

Field Engineering Bulletin
071 8275 01 | June 3, 2004
Reference ECO: 553K

Jupiter / Saturn / AccuSwitch Release 7.3

Contents

Applicability	1
Purpose	2
Equipment required	4
Software required	4
Materials supplied	5
Optional materials	5
System files CRCs	5
Release notes	5
Installation/upgrade	10
Removing Jupiter software	21
Getting the Jupiter LAN IP address of a PC	22
Software configuration	22
Running applications on a Remote PC	22

Applicability

This release applies to Jupiter/Saturn systems with VM/SI 3000 Control Processors. It also applies to systems running JupiterXPress or AccuSwitch deterministic router control software on the CM 4000 Control Module. This release supports English versions of Windows 2000 Professional and XP Professional operating systems only. Servers using Windows 3.1, Windows 95, Windows 98, or Windows NT are not supported.

ES-LAN machine control interface to Thomson Broadcast Automation and CP 3200 control panels are not supported on Windows 2000 systems and thus not supported in release 7.1.0 and later releases.

Purpose

7.3 Release

JupiterXPress

With this release, the CM 4000 Control Module running the JupiterXPress application now supports the following:

- TSL under monitor displays
- MI 3040/T tally operation (MI 3040/2 /8 /12 machine control functions are not supported)
- CP 2002B and CP 2002D control panels
- Saturn master control switchers and the AccuSwitch application (running on a separate CM 4000) are now supported, i.e., they can be on the same network as a CM 4000 running JupiterXPress
- The CP-3800 control panel now supports 20 pages of destinations when controlled by JupiterXpress
- Saturn Monitor Follow and Preview

For more information about these features, please refer to the Jupiter CM 4000 Installation and Operating manual. (This manual is supplied on the Documentation CD, part no. 071 8274 xx.)

Note Jupiter XPress software cannot be installed on systems containing VM 3000 or SI 3000 processors. Also note that only JupiterXPress or AccuSwitch can be downloaded and executed in a single CM 4000 at one time.

7.2 / 7.2.1 Release

(The following information is provided for reference. Release 7.3 includes all functions of previous releases.)

JupiterPlus and Jupiter LE

With this release, the VM 3000 Control Module running the JupiterPlus or Jupiter LE applications now supports the following new devices and functions:

- CP 3832L and CP 3864L Control Panels
- GVG Native protocol

For more information about these features, please refer to the Jupiter VM-3000 Installation and Operating manual. (This manual is supplied on the Documentation CD, part no. 071 8274 xx.)

JupiterXPress

The CM 4000/JupiterXPress product provides the following set of Jupiter switching and machine control functions using the CM 4000 as the interface between the devices listed below.

With this release, Jupiter Xpress now supports the following devices and functions:

- Configuration Upload Utility
- CP 3800, 3808, 3809, and 3830 Control Panels
- CP 3832 and 3832L; CP 3864 and CP 3864L Control Panels
- CP 300 and 300S; 310 and 310S; 320 and 320S; 328 and 328S; 330 and 330S; and 330/6 Control Panels
- CP 3000 / 3010 Control Panels
- CP 3020 / 3021 Control Panels
- MC 3000 / 3010 Control Panels
- VC 3020 Control Panel
- GVG Native protocol
- Data Tek protocol (option)
- Nexus protocol (option)
- Utah 96 protocol (option)
- Jupiter ESbus Physical protocol
- DD (Diamond) Series protocol
- ASCII, ES-control, and ES-switch protocol
- JNS Control System User Applications (except Party Line Download)
- Configuration Swap (option)

For more information about these features, please refer to the Jupiter CM-4000 Installation and Operating manual. (This manual is supplied on the Documentation CD, part no. 071827400.)

Corrections

Error corrections are provided by this release, as described in the Release Notes section beginning on [page 5](#). These notes should be reviewed before installing the software.

As with any software package, some limitations remain. Many of these are known and are detailed in this document and other documents referenced. Please note that the description of known limitations is not an agreement to correct them.

During this upgrade:

- All switcher status will be lost. To restore status, make note of the status of all outputs before starting the upgrade and re-Take all switches. Or, you can use Router Save/Restore to restore status.
- All memory on all Jupiter control system boards will be cleared due to a mandatory "pmemclear" subsequent to installation and download.
- All configuration sets will need to be recompiled.

Equipment required

Thomson-supplied PC 3000 (F7-029500-121) file server; or, PC with minimums as follows:

- Intel Pentium 700 processor with 256 K L2 cache
- 512 Mbytes RAM memory
- 1.2 Gigabyte hard drive
- 4X CD-ROM drive
- 1.44 Mb floppy drive
- Intel or 3Com Ethernet LAN card
- Media converter or hub if needed to connect Ethernet LAN card to CM 4000 or to Jupiter VM/SI 3000. (The CM 4000 has a 10/100baseT rear panel connector; the VM/SI 3000 has a 10base2 rear panel connector.)
- US Robotics 56 kbps modem
- Keyboard / mouse
- 15-inch monitor capable of 1024 x 768 x 256 operation
- 1 or 2 serial ports and 1 parallel port

CM 4000 (if present) must meet requirements specified in Engineering Change Order 642J. This ECO specifies replacement of PROM EPC1441 part no. 163827000 with PROM EPC1441 part no. 163827001. (Note: This new PROM is not compatible with previous versions of Jupiter software.) For more information, contact Thomson.

Software required

Installation of Release 7.3 is only supported on the English version of the Windows 2000 Professional operating system with Service Pack 2 or later or Windows XP Professional SP1.

Materials supplied

Kit, Jupiter Software Upgrade 7.3		650 4280 03
<u>Qty</u>	<u>Description</u>	<u>Part number</u>
1	Software, CD ROM Jupiter 7.3	063 8093 03
1	Documentation CD	071 8274 03
1	Field Engineering Bulletin	071 8275 01

Optional materials

Application specific software licenses (refer to Section 1 of the Jupiter Installation and Operating manuals for more information)

- Jupiter VM/SI 3000 Installation and Operating Manual (VM 3000), part no. 04-045707-002
- Jupiter CM 4000 Installation and Operating Manual, part no. 071 8261 xx

System files CRCs

ACCUSWCH.SYS	FD8C
JUPITER.LDR	C7F8
JUPITER.SYS	FB55
MCS.SYS	739E
SATURN.LDR	E17A
SATURN.SYS	4830
SNOWBIRD.SYS	B9E8

Release notes

7.3 Release

Problems corrected

1. Corrected a memory leak when ES-Control is defined and switches have been executed. Refresh messages for ES-Control would allocate memory, but it was not being released.
2. Corrected a memory leak with ES-Switch and ASCII where memory for status messages was not being released.
3. CR 43715: ES-Switch will now send a STARTUP message upon activation from a redundancy failover.

4. CR 43718: Corrected a problem with ES-Switch and ASCII where status update messages may not be sent to all ports requesting status and status may be intermittent.
5. CR 41791: Corrected a problem in Jupiter and JupiterXPress with the CP-3800 control panel where user defined sequences would not actually switch the correct levels.
6. CR 41792: Corrected problem in Jupiter and JupiterXPress with the CP-3800 where unlocking/unprotecting an output assigned to button nine or higher could cause a reboot.
7. CR 41785: Corrected a problem in Saturn with MI-3040/T where the internal and external tally may not tally correctly.

7.2.1 Release

JupiterXPress - Logged problems corrected

1. PRN 228: Corrected a problem where a global variable was being used by more than one object at a time.
2. PRN 229, PRN 230: Corrected a problem where serial protocols were using data before it was initialized.
3. PRN 231: Physical Remap now works with JupiterXPress.

Jupiter Configuration Editor - Logged problems corrected

1. PRN 2515: The Jupiter Network Suite board order now matches the order in the JNS Board Status and JNS Board Info tables.

Jupiter - Known issues

1. PRN 1983: Jupiter does not support follow levels and physical switching.

Follow levels were designed to work only with logical levels, inputs, and outputs. Currently all follow switches happen as logical switches, therefore you get input 9 on the follow levels since with this customer configuration, input 9 is logical input 10. If the SAFE input is moved to the bottom, then the follow switches would work because the rest of the follow levels are 1 to 1 between logical and physical inputs and outputs. If Jupiter did physical switches for the follow switches when physical switches were requested, the following problem occurs: If a source was defined as vtr1 green 5, blue 6, red 7, and a physical switch request of input 5 was requested, the end result would be green 5, blue 5, and red 5 to the selected destination.

7.2.0 Release

Jupiter - additional enhancements

Because redundant boards could not be differentiated from the main board, a "-R" was added to the board name in the VGA screen. This change requires that all VGA files will need to accommodate two more characters to the Board column in order to allow for "-R" to be appended to the redundant board. VGA Gen will account for this change, but will overwrite existing VGA files when ran. If a custom VGA page is being used, then the VGA file will have to be manually edited to accommodate this change.

Jupiter - logged problems corrected

1. PRN 1887: Corrected a problem where a machine assigned to Saturn Mix1 or Mix 2 under automation control would not operate correctly.
2. PRN 1929: Corrected a problem during the Jupiter installation process, if TCP/IP is not correctly configured (TCP/IP address is not configured or it is set for DHCP) for Jupiter, then a warning message is displayed and the user must correctly configure TCP/IP.
3. PRN 1938: Corrected a problem with path finding where locked tie lines could get out of sync.
4. PRN 1957: Corrected a problem with JNS Control Center changing sets and issuing a "run time 380" error message. Limited what buttons can be pressed during a set change.
5. PRN 1966: Corrected an issue with SAFE OFF TIME and data routers, where the SAFE switch was not happening correctly.

JupiterXPress - logged problems corrected

1. PRN 181: Corrected a problem with the CP-3800 where levels displayed do not coincide with the page number.
2. PRN 193: Corrected a problem in VGA where an array was being indexed improperly and was causing a page fault.
3. PRN 198: Corrected an issue where after a reboot, VGA and control panel status was slow.
4. PRN 203: Corrected a problem where the CP-3000 would display "MPK Display Error" when selecting a sequence.
5. PRN 204: Corrected a problem in ES-Switch when sending status requests for 500 outputs, one at a time, without a pause in between requests, the CM stops sending status messages, and the console port fills up with "(upmx) PPH4 queue is full" messages.
6. PRN 209: Corrected a problem with the CP-330 where a page fault was being caused by indexing an array improperly.

Jupiter Configuration Editor - logged problems corrected

1. PRN 2493: Corrected an issue where the configuration editor would allow Physical Level entries of 0-999 for Binary and TVS levels which are limited to 1-127.
2. PRN 2494: Corrected an issue where the compiler would not accept a CP Output set for the CP-3020.
3. PRN 2497: Corrected an issue where the GMT Offset for CM-4000 boards was not be compiled properly. GMT Offset was always "000".
4. PRN 2498: Corrected an issue where the redundant boards address was deleted if the type was changed.
5. PRN 2504: Corrected an issue with the compiler hanging when board names in the Network Description Table have spaces in them. Spaces are no longer allowed in board names.
6. PRN 2505: Corrected an issue where path finding groups from one level could be selected on another level. Path finding groups only apply to the level they are configured for.

CM 4000 (Jupiter XPress and AccuSwitch) - logged problems corrected

1. PRN 123: Corrected a problem where the subnet mask was incorrectly set for CM-4000 boards.
2. PRN 124: CM-4000 boards now have TTL (Time To Live) of 64 instead of 1.
3. PRN 2496: In the Time Standard Table, the help for the GMT Offset field said that if the time zone is west of Greenwich the entered value should have been positive. The help message has been corrected to say that time zones west of Greenwich should be negative.

AccuSwitch - logged problems corrected

1. PRN 127: Corrected a problem where the switch logger file could be corrupted.
2. PRN 130: Corrected a problem with the ASCII protocol where a "ZJ" response would not be returned for protected outputs.

PRN 132: Corrected a problem with the ASCII protocol where "ZV000" will protect the output, but "ZU000" would not unprotect the output.

7.1.0 Release notes

See FEB 075-0695-00 (27 pages).*

7.0.0 Release notes

See FEB 04-047604-109 (31 pages)*

6.2.1 Release notes

See FEB 04-047604-11 (20 pages).*

6.2, 6.1, and 6.0 Release notes

See FEB 04-047604-107 (64 pages).*

5.1.5 Release notes

See FEB 04-047604-089 (66 pages)*

5.1.1 Release notes

See FEB 04-047604-090 (2 pages)*

5.1.0 Release notes

See FEB 04-047604-086 (62 pages)*

5.0.6 Release notes

See FEB 04-047604-100 (53 pages)*

5.0.5 Release notes

See FEB 04-047604-082 (50 pages)*

*. This bulletin may be found on the Technical Publications CD-ROM included in this release package. Point your browser to the "index.htm" file on the CD or open the "MNC" directory. For more information, click on Help.

Installation/Upgrade

Like all software programs, Jupiter requires specific files to be in specific directories. Do not attempt to modify or add to the contents of the Jupiter directory (usually C:\Program Files\Thomson\Jupiter) by using tools such as Windows Explorer unless you are qualified to do so.

The file server computer must be equipped as described on [page 4](#).

Note (Saturn users only.) During the install process, the installer will ask for a version letter on the Meter LAN PROM U7 in your Saturn MCC 3500 control panel (see Figure 1). The version letter is found at the end of the part number, e.g., “45-046878-01B.” You may want to make a note of this number before you begin

Figure 1.

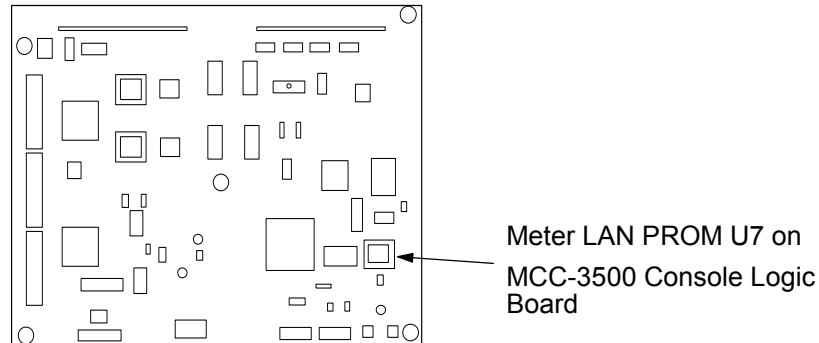

CAUTION You must have administrator privileges in order to load Jupiter software, launch Jupiter applications, and configure the system. And, the same login should be used for all tasks performed on the Jupiter file server, including uninstalling software.

Note (Windows XP systems.) When logging on as the Administrator, you may notice that the welcome screen does not always show an Administrator icon. Press Ctrl-Alt-Del twice, and then type “Administrator” as the username in the dialog box to log on as the Administrator.

1. (New system only.) Set the IP address for the NIC (Network Interface Card) connected to the Jupiter network:
 - a. Go to “Start > Settings > Network and Dial-up Connections > Local Area Connection > Internet Protocol (TCP/IP) > Properties.”
 - b. Enter the IP address. The recommended address for the Jupiter File Server NIC is 192.168.253.1. Make a note of the address for use later during this installation.

CAUTION Do *not* use “Obtain an IP Address Automatically.” This selection invokes DHCP (Dynamic Host Configuration Protocol) and may result in system corruption.

2. If configuration sets exist on this server you may wish to back up your current configuration directory (C:\Program Files\Thomson\Jupiter\config) and save it on another disk drive.
3. If previous versions of Jupiter software were installed on this server, they must be uninstalled at this time. See [Removing Jupiter Software on page 21](#).
4. With Windows running, and logged in as the administrator, insert the Jupiter installation CD-ROM. Allow a few seconds for the CD-ROM to auto start and the InstallShield Wizard welcome screen to appear:

Note If during the course of the following procedure you see the message “Error 1605:-This action is only valid for products that are currently installed” or the message “Error 1628 Failed to complete script based install” it may indicate that more than one login has been used for Jupiter. Contact Thomson Technical Support for assistance.

Figure 2.

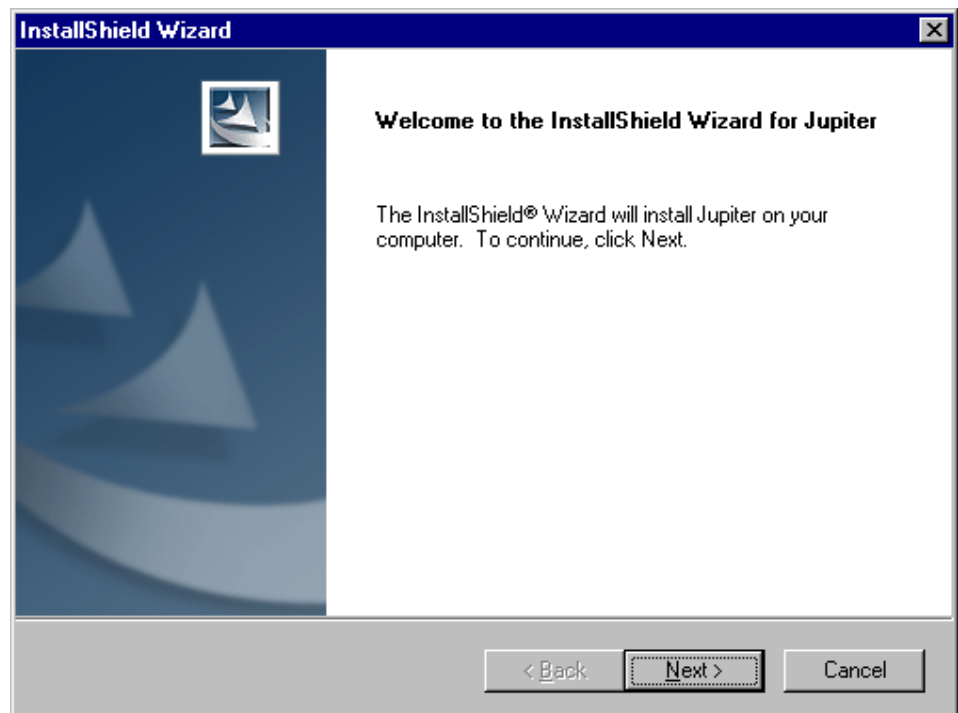

If your PC requires configuration of the Windows Installer, this will be done automatically. Some systems may require a restart following this configuration. If the following dialog box appears, click “Restart”.

Figure 3.



You can also start the installation by browsing to the CD-ROM and running "setup.exe."

5. Click on "Next."

Figure 4.

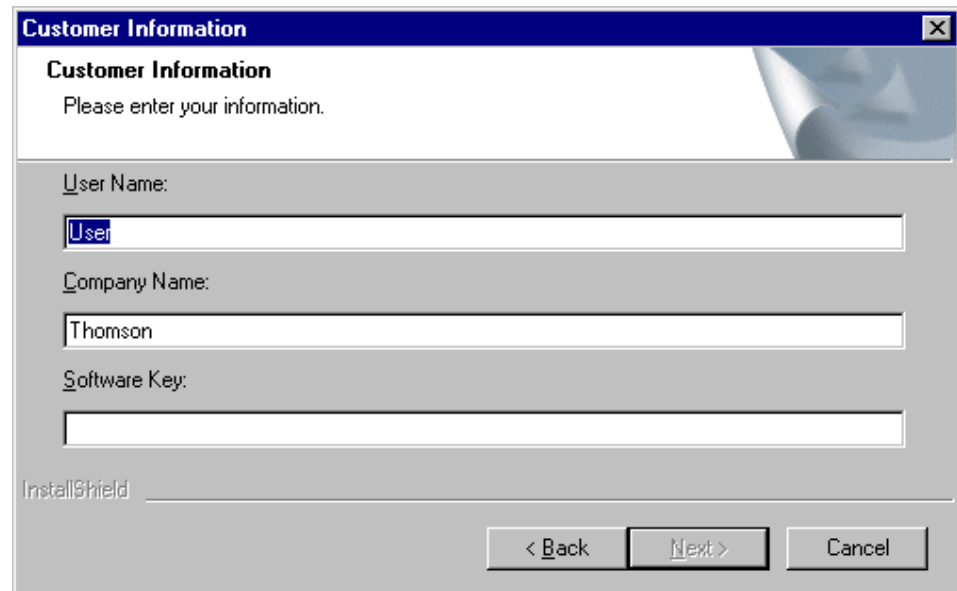

6. Enter a User Name and a Company Name.

7. Enter the Software Key Number printed on the CD-ROM case. This will be three groups of non-case-sensitive characters separated by dashes.

This password will indicate which if any options should be installed (such as GUI control panels or third-party router control software). For a list of available options, refer to Section 1 of the Jupiter Installation and Operating manual.

8. Verify that you accept the software license agreement.
9. Choose the Setup Type, either "File Server" or "Remote:"

Figure 5.

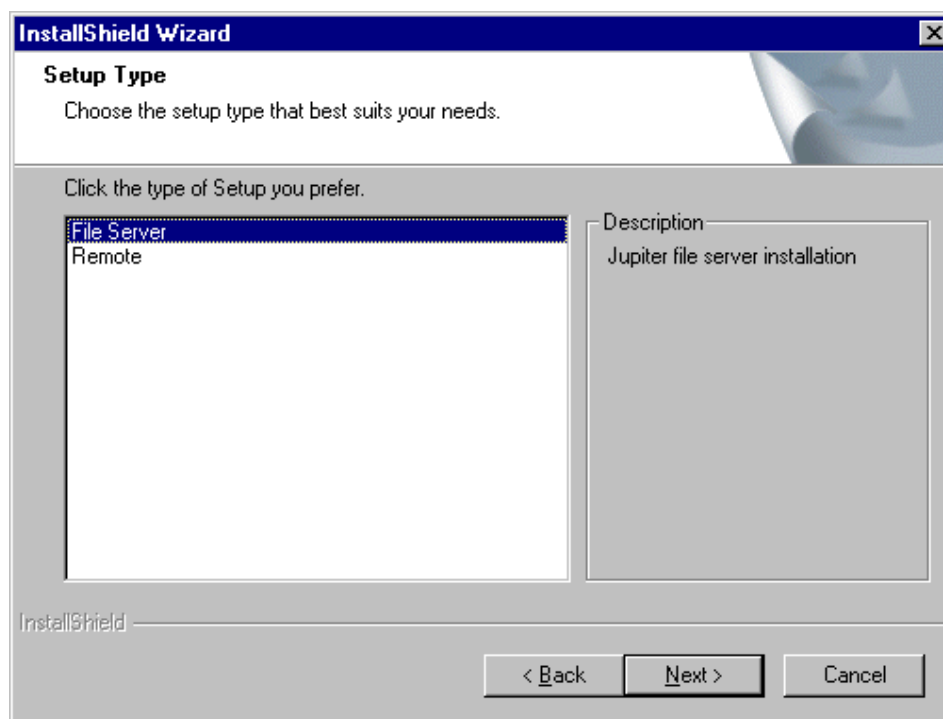

For more information about Remote Jupiter PCs, see [page 22](#).

10. If you selected File Server as the installation type, the installer will ask for a version letter on the Meter LAN PROM U7 in your Saturn console (for details see Note on [page 10](#)).

Figure 6.

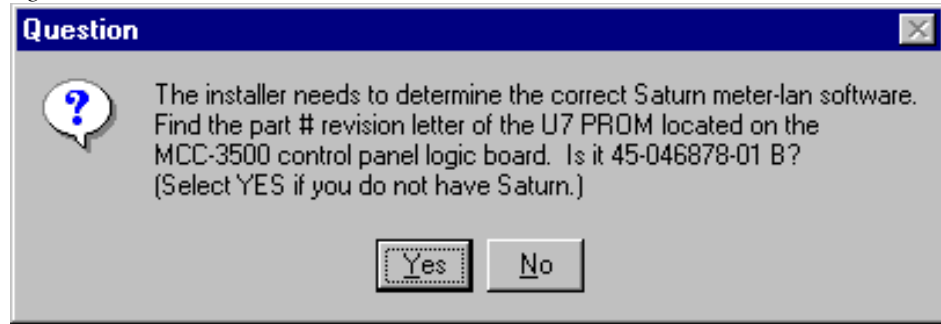

If you do not have a Saturn in the system select "Yes."

11. Select the directory where the Jupiter application will be installed.

Figure 7.

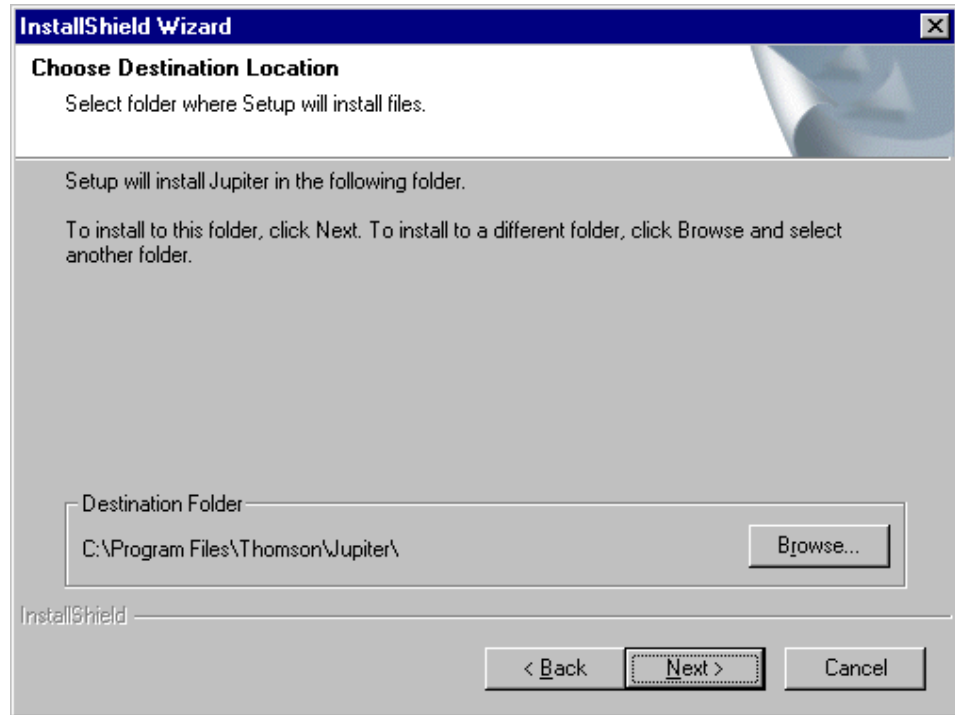

The default is C:\Program Files\Thomson\Jupiter.

12. Verify the file server's IP address.

Figure 8.

13. Verify the Network settings.

The recommended (factory default) settings are as follows:

Reboot Port	1E00
Communication Port	1F00
Base IP Address	192.168.253.10

In most cases, these recommended settings work well. The “base” IP address will be assigned automatically to the first controller board listed in the Jupiter Network Description table (described in the Jupiter manual). The base address, plus one, will be assigned automatically to the next board in the table; the base address, plus two, will be assigned automatically to the next board in the table, etc.

- If you want to keep the present IP address of the first controller board (CM 4000, VM 3000, etc.), the present communication port setting, and present reboot port setting, click “Next.”
- Or, enter new settings.

- Note Do not confuse the Base IP Address with the File Server IP Address. The Base IP Address goes to the first controller board (CM/VM, etc.). The File Server IP Address is for the PC only and is set using the Windows Network Setup application; the recommended (factory default) File Server IP Address is 192.168.253.1.
- Note The Base IP and File Server IP must be within the same subnet. E.g., if the subnet is 192.168.253 (and the subnet mask is 255.255.255.0) then both IP addresses would need to have 192.168.253.x addresses.
- Note If a second (“remote”) PC is attached to the LAN (e.g., to provide a Software Control Panel station), it must not conflict with any other address on the LAN, including those generated automatically as described above. If you don’t know a PC’s address, see [Getting the Jupiter LAN IP address of a PC on page 22](#).
- Note The Reboot and Communication Port settings should be left at “1E00” and “1F00” respectively except in very unusual circumstances.

14. You may see the following message:

Figure 9.

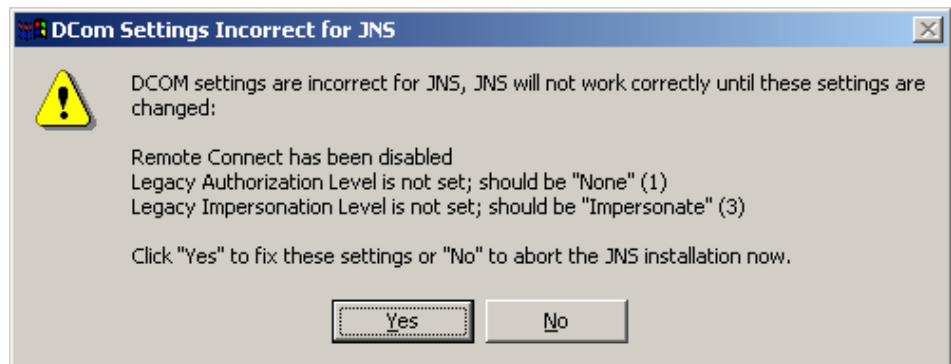

If so, click on “Yes.”

15. A list of Current Settings will be shown.

Figure 10.

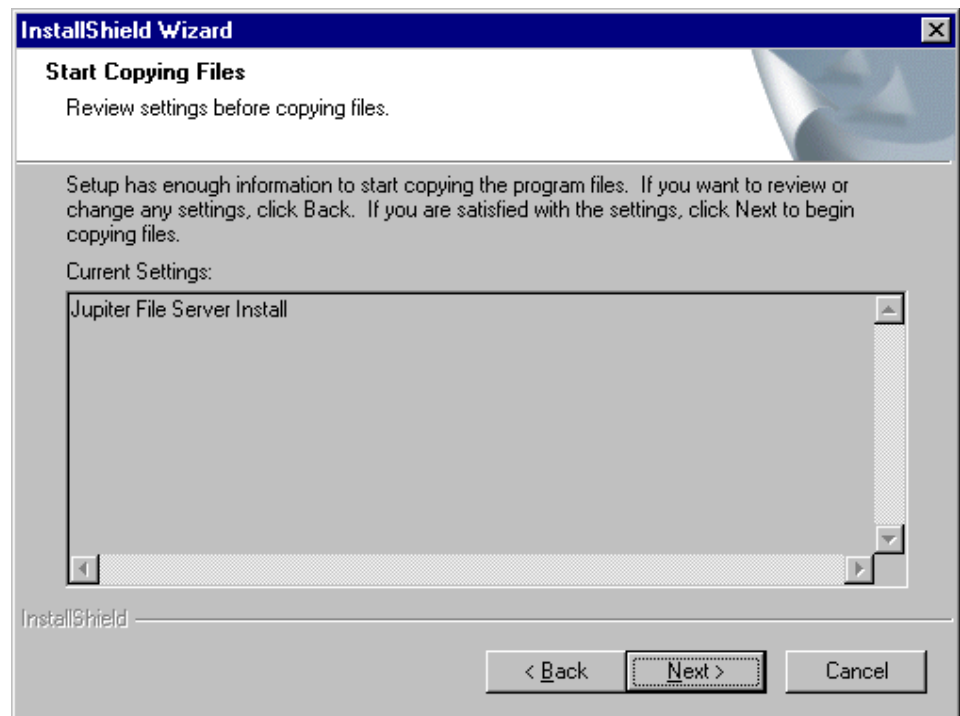

The list will normally show "Jupiter File Server Install" when "File Server" was selected during Step 8 above.

16. Verify by selecting "Next." This will initiate the file copy process.

Figure 11.

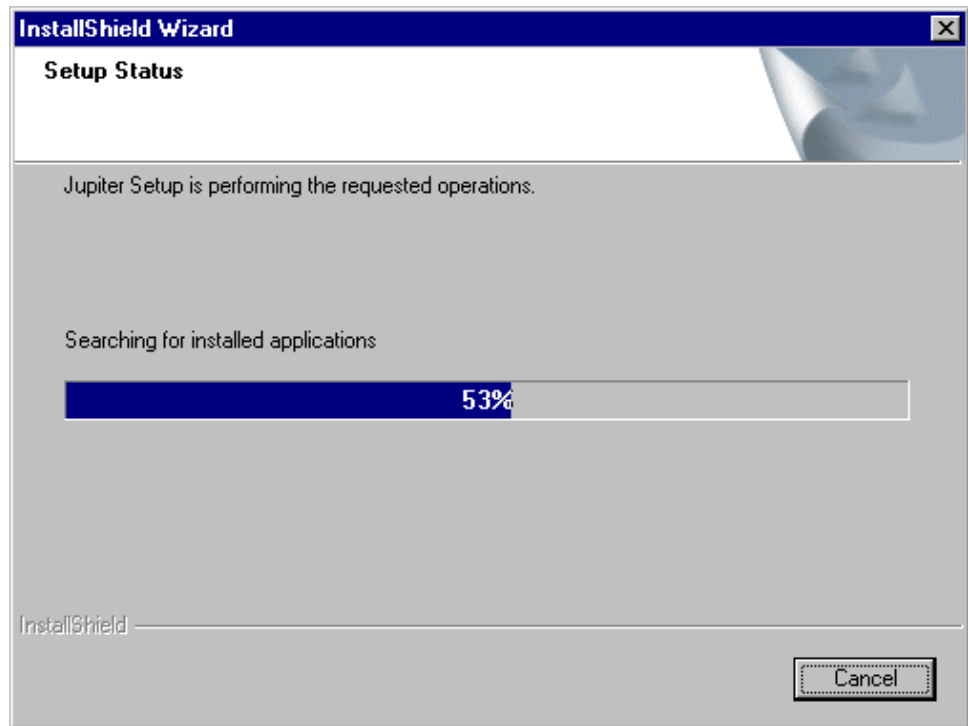

When finished, the installer will report "InstallShield Wizard Complete."

17. Click "Finish."
18. In some cases, when the installation is complete, a message will indicate that a reboot is required:

Figure 12.

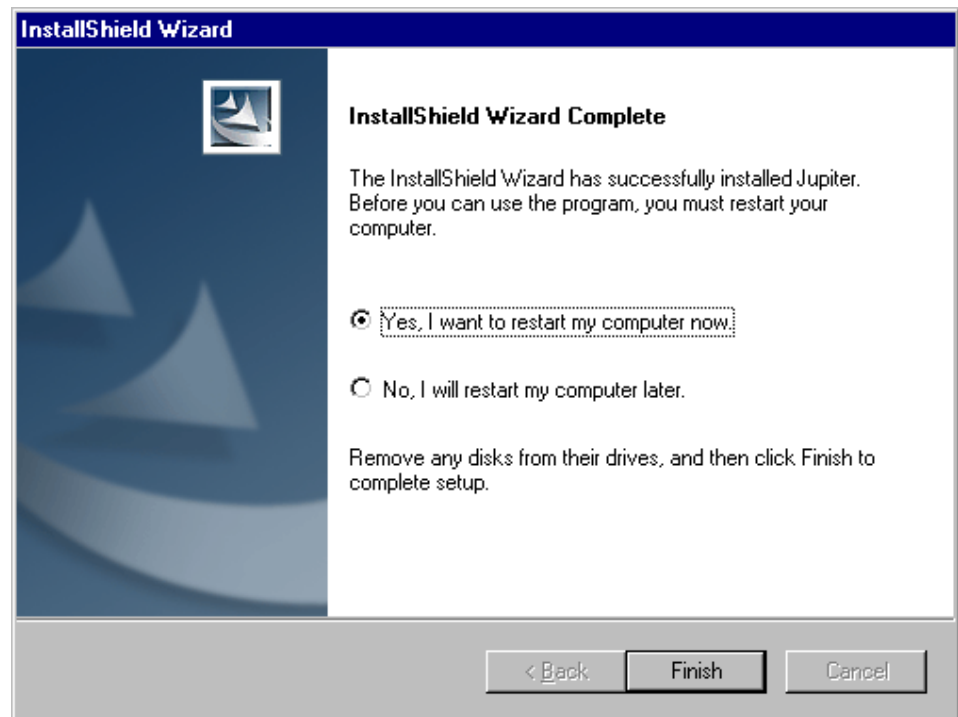

19. "Jupiter Network Suite" (JNS) should now appear in the "Start > Programs" menu.
20. (Optional - Saturn only) Install the patch that allows the "On Air Mono" and "Program Mono" digital outputs of the DAP 4000 Digital Audio Processor to be turned into stereo outputs:
 - a. Go to the Jupiter installation directory where the DSP files are located (C:\ProgramFiles\Thomson\Jupiter\download\list\common).
 - b. Back up the file "DSPA_XX.BIN" by renaming it (e.g., to "DSPA_XX.BAK").
 - c. Copy the file "DSPA_STR.BIN" and rename the copy "DSPA_XX.BIN."
 - d. Recompile the configuration set.
 - e. Activate and download the configuration set.
 - f. The On Air Mono and Program Mono outputs will now be stereo for all DAPs in the system.
21. Set the gateway and subnet mask values for the Jupiter network boards (VM/SI/CM/Saturn):
 - a. Launch Jupiter Network Suite.
 - b. Go to "Tools > Jupiter Settings."

- c.** Select (check) the field with the IP address used for the Jupiter network. This is the address described in [Step 12](#) above. The “base” address was described in [Step 13](#) above.
- d.** For the Gateway address, enter the Jupiter network number (e.g., 192.168.253) and a “1” for the gateway itself. For example: “192.168.253.1.”
- e.** For the Subnet Mask, indicate a Class C network by entering “255.255.255.0.”

Removing Jupiter Software

Note This process will not remove existing user-created configuration sets.

CAUTION You must be logged in as the administrator in order to load Jupiter software, launch Jupiter applications, and configure the system. This same login should be used for all tasks performed on the Jupiter file server, including uninstalling software. Failure to observe this rule may result in system corruption.

1. Go to “Start > Settings > Control Panel > Add/Remove Programs.” The InstallShield Wizard welcome screen will appear:

Figure 13.

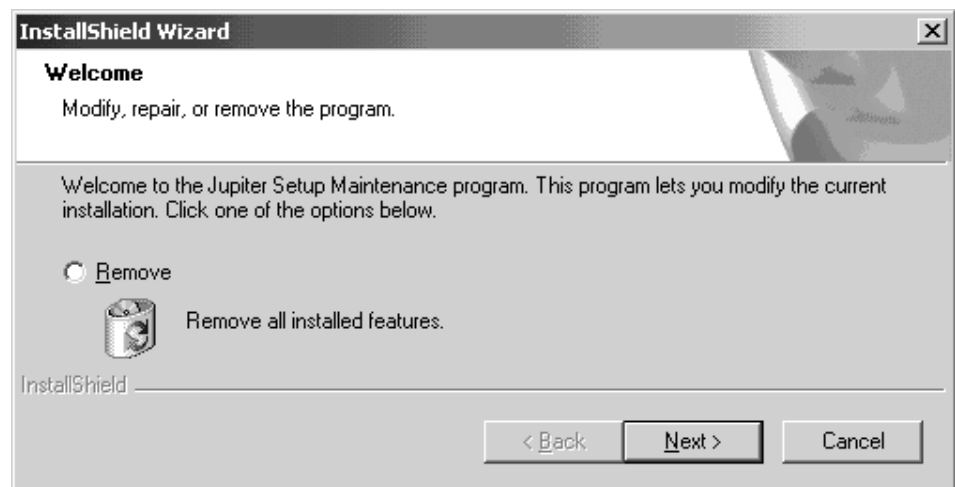

2. Click “Remove.”
3. To initiate the uninstall procedure, click “Next.”

When finished the system will report “Maintenance Complete.”

Note For those with Jupiter 7.2 Beta 1 installed: If you are unable to remove it, *re-install* Jupiter 7.2 Beta 1 and go to the Control Panel again to try to remove it. You can then proceed to install Jupiter 7.2.

Getting the Jupiter LAN IP address of a PC

1. Go to “Start > Settings > Control Panel > Network and Dial-up Connections > Local Area Connection > Properties.”
2. Select the Jupiter network adapter. The IP address will be indicated.

Software configuration

If this is an initial installation, the system software must be configured using the Jupiter configuration editor. For overall software configuration instructions, please refer to the Jupiter Installation and Operating manual starting with Section 4 - “Jupiter Network Suite Control Console.”

Running applications on a Remote PC

The following programs can be “connected to” (accessed) on a remote PC equipped with JNS:

- Board Status
- Control Center
- Force Unlock
- Logger
- Log Viewer
- Physical Control
- Party Line Download (JupiterPlus only)
- Router Control Utility
- Router Save/Restore
- Saturn Monitor Follow (JupiterPlus only)
- Software Control Panels Suite

To install these programs remotely, follow the instructions beginning on [page 10](#) and select “Remote” during [Step 9](#).

For more information about Remote PC installation and operation, refer to the Jupiter manual.

Connecting a Remote PC to a Windows XP Server

If the file server is running Windows XP and you would like to run remote clients that connect to the file server, a Local Security Policy setting may need to be changed on the file server. By default, Windows XP will prevent remote clients from connecting.

Open the Control Panel, select Performance and Maintenance, select

Administrative Tools, select Local Security Policy, double-click on Local Policies in the tree-view, and double-click on Security Options in the tree-view. Scroll down the list of settings to find "Network access: Sharing and security model for local accounts." Change the setting from "Guest only - local users authenticate as Guest" to "Classic - local users authenticate as themselves." You may need to reboot the file server.

If you still get DCOM errors while connecting, the Administrative Tools / Event Viewer may provide helpful information.

Keep in mind that the username AND password on both the file server and the remote clients must be identical. To prevent unauthorized access, Thomson recommends that you use a secure password.

