

# 8960ENC

4:2:2 TO NTSC/PAL ENCODER

Instruction Manual

SOFTWARE VERSION 8.0.2

071064204  
JULY 2005

*the most watched worldwide*

# Contacting Grass Valley

Region	Voice	Fax	Address	Web Site
North America	(800) 547-8949 Support: 530-478-4148	Sales: (530) 478-3347 Support: (530) 478-3181	Grass Valley P.O. Box 599000 Nevada City, CA 95959-7900 USA	www.thomsongrassvalley.com
Pacific Operations	+852-2585-6688 Support: 852-2585-6579	+852-2802-2996		
U.K., Asia, Middle East	+44 1753 218 777	+44 1753 218 757		
France	+33 1 45 29 73 00			
Germany, Europe	+49 6150 104 782	+49 6150 104 223		

Copyright © Thomson Broadcast and Media Solutions All rights reserved.

## Grass Valley Web Site

The [www.thomsongrassvalley.com](http://www.thomsongrassvalley.com) web site offers the following:

**Online User Documentation** — Current versions of product catalogs, brochures, data sheets, ordering guides, planning guides, manuals, and release notes in .pdf format can be downloaded.

**FAQ Database** — Solutions to problems and troubleshooting efforts can be found by searching our Frequently Asked Questions (FAQ) database.

**Software Downloads** — Software updates, drivers, and patches can be downloaded.

# Contents

- Preface**..... 5
  - About This Manual..... 5
  
- 8960ENC 4:2:2 to NTSC/PAL Encoder**
  - Introduction..... 7
  - Installation..... 8
    - Frame Capacity..... 8
    - Module Placement in the 8900 Frame..... 8
    - Frame Sync Submodule (8900FSS)..... 10
      - Installation..... 10
      - Termination..... 10
  - Cabling..... 11
    - Loop-through Input..... 11
    - Outputs..... 11
    - Reference Inputs..... 11
  - Power Up..... 12
    - Operation Indicator LEDs..... 12
  - Configuration..... 15
    - Configuration Summary..... 15
      - Configuration Summary Table..... 16
    - Local Onboard Module Configuration..... 18
      - Onboard Module Configuration..... 19
      - Adding/Deleting Setup for 525 Format..... 19
    - Remote Configuration and Monitoring..... 22
      - 8900NET Module Information..... 22
      - Newton Control Panel Configuration..... 22
      - Web Browser Interface..... 23
      - 8960ENC Links and Web Pages..... 25
  - Specifications..... 40
  - Functional Description..... 42
    - Serial 4:2:2 Input Stage & Output..... 42
    - Cross-Color Remover..... 43
    - Synchronizer..... 43
    - 10-bit Encoder and Output Driver..... 43
    - Color-frame Lock..... 43
    - Microcontroller..... 44
    - Regulator..... 44
  - Service..... 45
  - Status Monitoring..... 46
    - LEDs..... 46
    - Frame Alarm..... 47
    - Web Browser Interface..... 47
    - SNMP Reporting..... 48

**Index**..... 49

# *Preface*

## **About This Manual**

This manual describes the features of a specific module of the Gecko 8900 Signal Processing System. As part of this module family, it is subject to Safety and Regulatory Compliance described in the Gecko 8900 Series frame and power supply documentation (see the *Gecko 8900 Frames Instruction Manual*).



# *8960ENC 4:2:2 to NTSC/PAL Encoder*

## **Introduction**

The 8960ENC module is an encoder solution for converting 4:2:2 component serial digital video input into multi-standard composite analog video signals by using 10-bit processing throughout the conversion process.

The 8960ENC features:

- 10-bit signal processing,
- 4 NTSC/PAL outputs,
- 2 reclocked SDI (Serial Digital Interface standard) outputs,
- Full-frame output phasing with 8900FSS frame sync submodule option,
- 2 reference inputs for multiformat facilities,
- EDH detection, and
- Remote interface with the 8900NET module (version 3.2.2 or later) providing support for the following:
  - Web browser configuration and control
  - SNMP trap reports for use with NetCentral and other SNMP applications
  - NetConfig Networking application
  - Newton Control Panel control

# Installation

Installation of the 8960ENC module is a process of:

1. Placing the module in the proper frame slot, and
2. Cabling and terminating signal ports.

**Note** If you are installing the optional Frame Sync Submodule on the 8900ENC, see [Frame Sync Submodule \(8900FSS\) on page 10](#).

The 8960ENC module can be plugged in and removed from an 8900 Series frame with power on. When power is applied to the module, LED indicators reflect the initialization process (see [Power Up on page 12](#)).

## Frame Capacity

The 8960ENC module can be installed in all 8900 Series video frames but with varying maximum quantities determined by frame cooling capacity. [Table 1](#) provides the power capacity, cooling capacity, and maximum 8960ENC module count for each frame type.

Table 1. Power, Cooling, and Module Capacity of 8900 Frames

Capacity Calculated	8900TX Frame	8900TF-V Frame	8900TFN-V Frame
Power (W)	100	100	100
Recommended Module Cooling (W)	30	90	90
8960ENC Modules	5	10	10
8960ENC Modules with 8900FSS	X	10	10

**Note** Module capacity figures assume no other modules are in the frame. X = Not recommended without forced air cooling.

## Module Placement in the 8900 Frame

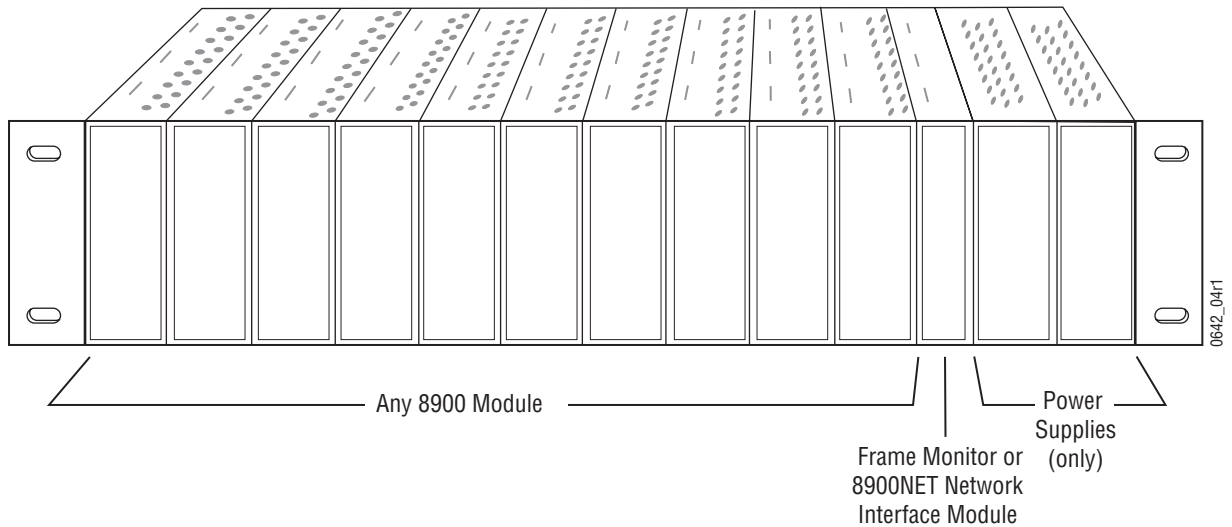
There are ten slot locations in the frame to accommodate either analog or digital modules. These are the left ten locations. Refer to [Figure 1 on page 9](#).

The two slots on the right are allocated for the power supplies. For additional information concerning the Power Supply module, refer to the 8900 Power Supply manual.

The third slot from the right is allocated for the controller module—either a Frame Monitor Module or a 2000NET Network Interface Module. For additional information concerning the controller module options, refer to the *Gecko 8900TX/8900TF/8900TFN Frames Instruction Manual*.

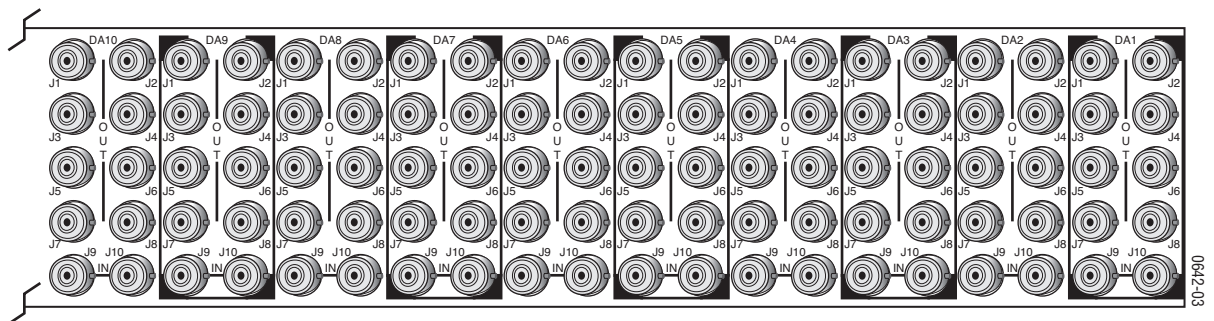


Figure 1. 8900 Series Frame



8900 module slots are interchangeable within the frame. There are 10 BNC connectors in each slot's I/O group. The functional assignment of each connector in a group is determined by the module that is placed in that slot. The maximum number of modules an 8900 frame can accept is ten. [Figure 2](#) illustrates the rear connector plate for an 8900 Series frame.

Figure 2. 8900 Series Frame Rear Connector



To install a module in the frame:

1. Insert the module, connector end first, with the component side of the module facing to the right and the ejector tab to the top.
2. Verify that the module connector seats properly against the backplane.
3. Press in the ejector tab to seat the module.

## Frame Sync Submodule (8900FSS)

An optional Frame Sync submodule is available for providing frame synchronization to an external reference. The submodule installs on the 8960ENC circuit board.

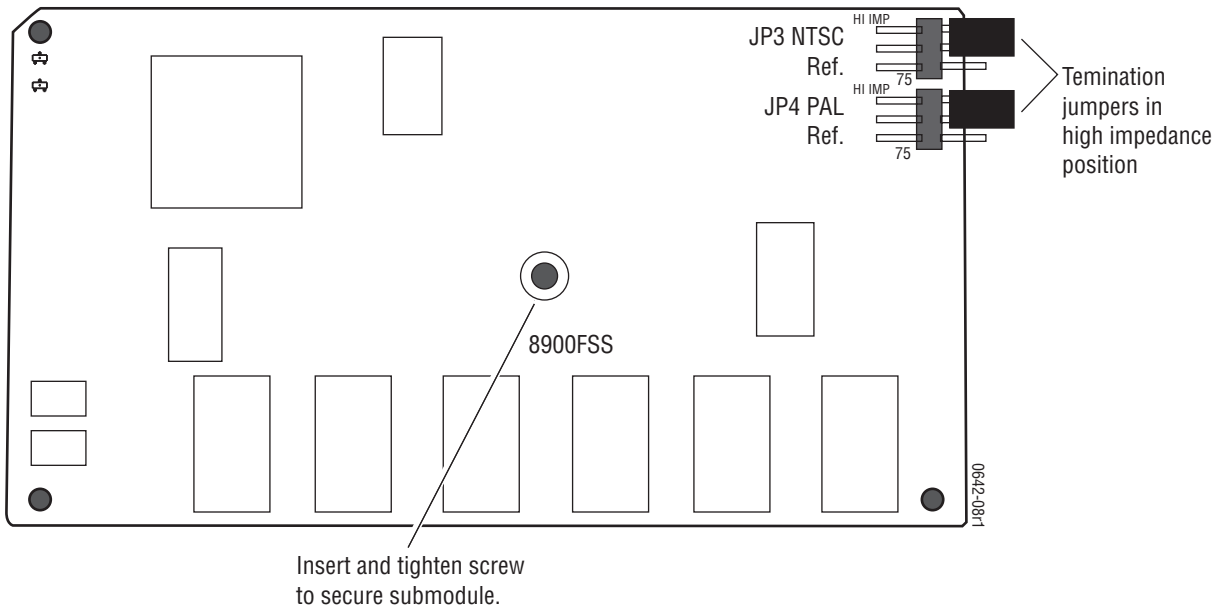
### Installation

Install the submodule onto the main circuit board by lining up the two connectors on the submodule with the connectors on the module. Make sure the connectors are aligned properly then press to seat the submodule. Insert and tighten the center screw to secure the submodule and assure that the connectors are in proper alignment.

### Termination

When used on the 8960ENC host module, the Frame Sync Submodule reference signal input termination should be set to high impedance (see [Figure 3](#)).

Figure 3. Frame Sync Submodule Reference Signal Termination Selection



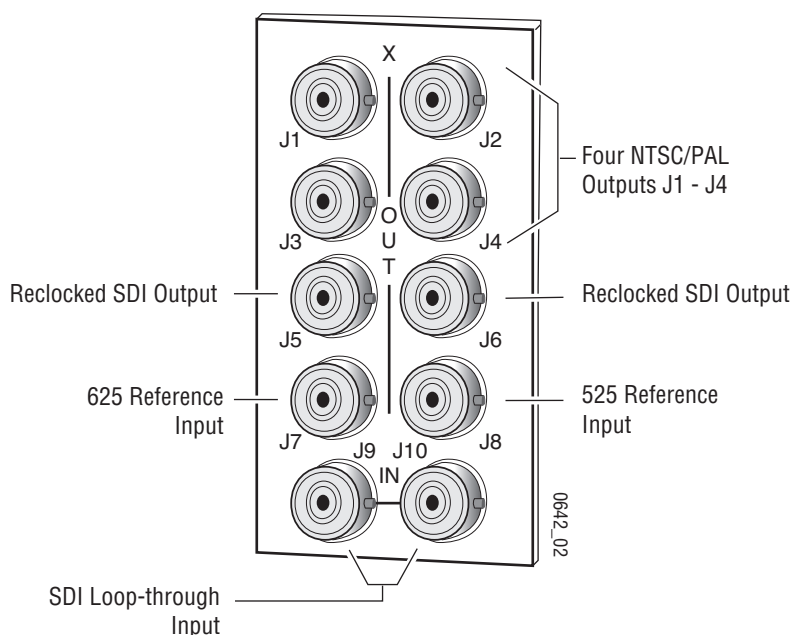
# Cabling

**Note** At the back of this manual are overlay cards that can be placed over the rear connector BNCs to identify the specific 8960ENC connector functions.

## Loop-through Input

Connect an input source to one of the loop-through input connectors, J9 or J10 (see [Figure 4](#)). The 8960ENC input will accept serial digital video conforming to SMPTE 259M 10-bit, 4:2:2 component digital standard. Terminate the unused connector into 75  $\Omega$  if the signal is not looped to other equipment.

Figure 4. 8960 Input/Output Connectors



## Outputs

The 8960ENC has four analog NTSC/PAL outputs—J1 through J4. Connectors J-5 and J-6 are reclocked SDI outputs.

## Reference Inputs

Separate input BNCs are provided for either 625-line (J7) or 525-line (J8) black burst reference signals. The reference inputs are 75  $\Omega$  or high impedance (jumper selectable, see [Local Onboard Module Configuration](#) on page 18).

# Power Up

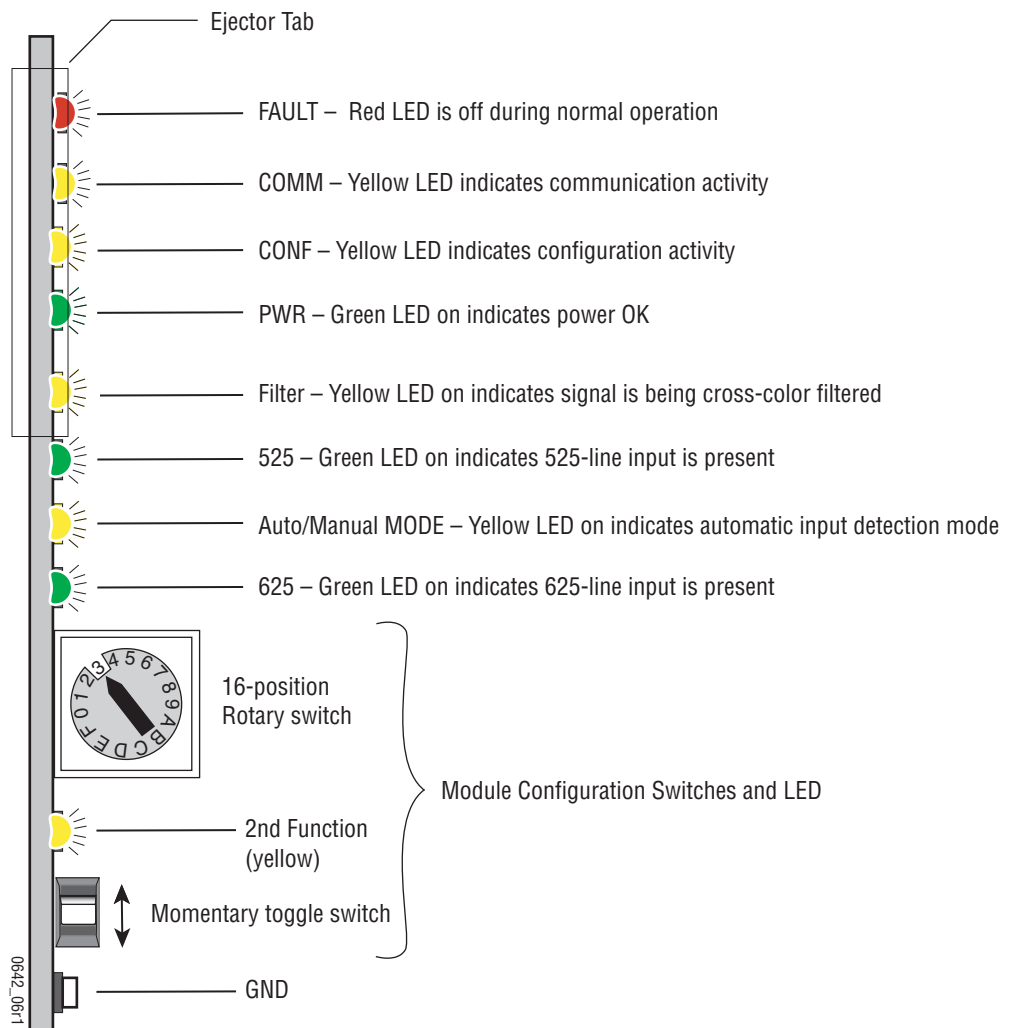
The front LED indicators and configuration switches are illustrated in [Figure 5](#). Upon power-up, the green PWR LED should light and the yellow CONF LED should illuminate for the duration of module initialization.

## Operation Indicator LEDs

With factory default configuration and a valid input signal connected, the green PWR LED, the yellow AUTO, and one of the green signal standard LEDs (525 or 625) should illuminate (refer to [Table 2 on page 13](#) to see the possible operating indicator combinations).

Video input presence is indicated by the 525 or 625 LED (indicating a 525-line or 625-line input signal has been detected). The AUTO LED indicates that automatic standard selection is enabled.

Figure 5. LEDs and Configuration Switches



A red FAULT LED indicates an error situation and, with the previously described LEDs, can indicate the operational conditions presented in Table 2. The table describes LED indications and the signal input/output conditions and user settings that are indicated.

Table 2. Input Conditions and Resulting Output signals and Indicators

Fault (red)	525 (green)	625 (green)	Input Condition	Output Signal
OFF	ON	OFF	Normal operation; SDI input signal and 525 reference standard selected.	Correct encoded signal with correct color-framing.
OFF	OFF	ON	Normal operation; SDI input signal and 625 reference standard selected.	Correct encoded signal with correct color-framing.
Flashing	OFF	OFF	Missing SDI input signal.	No signal.
Flashing	ON	OFF	EDH or format error in the input signal.	Output signal has errors.
Flashing	OFF	ON	EDH or format error in the input signal.	Output signal has errors.
OFF	OFF	Flashing	SDI 625 signal present; selected 625 reference missing.	Correct encoded output; color framing and delay adjustment from frame sync submodule is free running.
OFF	Flashing	OFF	SDI 525 signal present; selected 525 reference missing.	Correct encoded output; color framing and delay adjustment from frame sync submodule is free running.

Table 3 describes the outputs that will be seen for the operating modes and input conditions listed.

Table 3. Operating Mode, Input Conditions and Resulting Outputs

Mode	Standard Selection	Video Input	Reference Input	Output
Frame Sync Submodule Present — Module In Sync Mode	AUTO	Video present	Valid reference present	Correct output signal with correct timing
		No video signal present	Valid reference present	Corrupted output signal Or last field if autofreeze is on
		Video present	Reference not present	Correct output signal with free run timing
		Video present	Invalid reference input	Corrupted output signal
	Manual 525-line	Video present	Valid reference present	Correct output signal with correct timing
		No signal present	Valid reference present	Corrupted output signal Or last field if autofreeze is on
		Video present	Reference not present	Correct output signal with free run timing
		Video present	Invalid reference input	Corrupted output signal
		Invalid Video present	Valid reference present	Corrupted output signal
		Invalid Video present	Invalid reference input	Corrupted output signal
	Manual 625-line	Video present	Valid reference present	Correct output signal with correct timing
		No video signal present	Valid reference present	Corrupted output signal Or last field if autofreeze is on
		Video present	Reference not present	Correct output signal with free run timing
		Video present	Invalid reference input	Corrupted output signal
		Invalid Video present	Valid reference present	Corrupted output signal
		Invalid Video present	Invalid reference input	Corrupted output signal

Table 3. Operating Mode, Input Conditions and Resulting Outputs - (continued)

<b>Mode</b>	<b>Standard Selection</b>	<b>Video Input</b>	<b>Reference Input</b>	<b>Output</b>
<b>Frame Sync Submodule Present Module In Delay Mode</b>	AUTO	Video present	Not needed	Correct output signal w correct timing
		No video signal present	Not needed	Corrupted output signal Or last field if autofreeze is on
	Manual 525-line	Video present	Not needed	Correct output signal w correct timing.
		No video signal present	Not needed	Corrupted output signal Or last field if autofreeze is on
		Invalid Video input	Not needed	Corrupted output signal
	Manual 625-line	Video present	Not needed	Correct output signal w correct timing
		No video signal present	Not needed	Corrupted output signal Or last field if autofreeze is on
		Invalid Video input	Not needed	Corrupted output signal
	<b>No Frame Sync Submodule</b>	AUTO	Video present	Not needed
No video signal present			Not needed	No output signal
Manual 525-line		Video present	Not needed	Correct output signal
		No video signal present	Not needed	No output signal
		Invalid Video input	Not needed	Corrupted output signal
Manual 625-line		Video present	Not needed	Correct output signal
		No video signal present	Not needed	No output signal
		Invalid Video input	Not needed	Corrupted output signal

# Configuration

The 8960ENC can be configured locally using onboard switches or remotely using the 8900NET network interface GUI or a networked control panel.

Refer to the following sections for configuration instructions:

- Configuration Summary ([page 15](#))
- Local Onboard Module Configuration ([page 18](#))
- Remote Control and Monitoring ([page 22](#))

Operation of these control types is explained in detail in their respective sections of this manual.

## Configuration Summary

The configuration of the 8960ENC establishes:

- Reference signal input impedance (jumper selection),
- Local only or Remote/Local control (jumper selection),
- Input/Output standard setup,
- Signal processing adjustment,
- Signal filtering setup, and
- Optional Frame Sync module setup.

Output standard setup provides multi-standard support of analog output signals such as NTSC, Japanese NTSC, PAL-B, PAL-M.

The factory (default) settings for signal processing functions are set to pass a calibrated broadcast quality signal at optimum levels. Signal processing amplifier adjustments are available to correct deficiencies in the input signal.

[Table 4 on page 16](#) provides a summary in table format of all parameters and their ranges, default values, and remote, local, and control panel function names and locations for setting each value.

## Configuration Summary Table

Table 4 provides a complete summary of the 8960ENC functions and a comparison of the functionality available with each control type along with the ranges and default values for each parameter.

Table 4. Summary of Configuration Functions

Function Type	Default	Range/Choices Resolution	Web Page/ Function Name	Function Switch Bank/Setting	Newton Control Panel	Notes/ Conditions
Standard Recognition	Auto	Auto or Manual	Standard Selection/ Standard Recognition pull-down	1:0	Auto Std	
Manual Standard Selection	525	525 or 625	Standard Selection/ Manual Selection pull-down	1:1	Lines	Manual mode selected in Standard Recognition above.
Output Video Setup	Setup	Setup or No Setup	Standard Selection/ Output Video Setup pull-down	1:2	FF Setup	525 only
Vertical Interval Setup	Off	On or Off	Standard Selection/ VI Setup pull-down	2:F	VI Setup	
Line 21 Setup	Off	On or Off	Standard Selection/ Line 21 Setup pull-down	1:D	L21Setup	
Line 22 Setup	Off	On or Off	Standard Selection/ Line 22 Setup pull-down	1:E	L22Setup	
NTSC or PAL-M selection	NTSC	NTSC or PAL-M	Standard Selection/ NTSC/PAL-M Select pull-down	1:3	525 Std	
Standards Selection Controls Type	Numeric	Numeric <sup>1</sup> or Slider	Standard Selection/ Controls Type pull-down	N/A	N/A	Web page only
Output Video Level	97.09%	41.5 to 171.55% <sup>1</sup> (0.51% steps)	Standard Selection/ Output Video Level (% 1Vpp) Slider or arrow controls	1:4	Video	
User Adjustments	Calibrate	Calibrate or User	Levels/ User Adjustments pull-down	1:5	Levels	
Levels Control Type	Numeric	Numeric <sup>1</sup> or Slider	Levels/ Controls Type pull-down	N/A	N/A	Web page only
Luma Level adjustment to set luma gain	99.74%	89.5 to 109.9% <sup>1</sup> (0.08% steps)	Levels/ Luma Level (% White) Luma Level slider or arrow controls	1:6	Luma	User mode selected in User Adjustments above
Chroma Level adjustment to set chroma gain	99.52%	88 to 110.95% <sup>1</sup> (0.09% steps)	Levels/ Chroma Level (% saturation) Chroma Level slider or arrow controls	1:8	Chroma	
Hue Level adjustment (525 only)	0 degrees	0 to 358.05 degrees <sup>1</sup> (0.35 degree steps)	Levels/ Hue (degrees) Hue Level slider or arrow controls	1:9	Hue	
Black Level adjustment	7.54%	-14.22 to 21.48% <sup>1</sup> (0.34% steps)	Levels/ Black Level (% White) Black Level slider or arrow controls	1:7	Black	
Lock Source selection	Reference	Video or Reference	Timing/ Lock Source pull-down	2:0	Lock To	



Table 4. Summary of Configuration Functions

Function Type	Default	Range/Choices Resolution	Web Page/ Function Name	Function Switch Bank/Setting	Newton Control Panel	Notes/ Conditions
Timing Control Type	Numeric	Numeric or Slider	Timing/ Controls Type pulldown	N/A	N/A	Web page only
Fine Delay control	0 ns	0 to 40.80 ns (0.16 ns steps)	Timing/ Fine Delay Fine Delay slider or arrow controls	2:1	Fine Dly	No submodule required
Horizontal Delay	0	0 to 63418 ns (525) 0 to 63862 ns (625) (37 ns steps)	Timing/ Horizontal Delay slider or arrow controls	2:2	H Delay	8900FSS submodule installed.
Vertical Delay	0	0 to 524 lines (525) 0 to 624 lines (625) (1line steps)	Timing/ Vertical Delay slider or arrow controls	2:3	V Delay	
Freeze Recognition	Manual	Manual or Auto	Timing/ Freeze Recognition pulldown	2:4	Frz Rec	
Freeze Mode	Frame	Field or Frame	Timing/ Freeze Mode pulldown	2:6	Frz Mode	
Freeze Field	Field 1	Field 1 or Field 2	Timing/ Freeze Field pulldown	2:7	FrzField	
Freeze Signal	Last Field	Last Field or Black	Timing/ Freeze Signal pulldown	2:8	Frz Sig	
Force Manual Freeze	Off	On or Off	Timing/ Freeze button	2:5	Freeze	
Cross Color Removal	Disable	Enable or Disable	Video Processing/ Cross Color Removal pulldown	2:A	CrossClr	
Chrominance Signal	Disable	Enable or Disable	Video Processing/ Chrominance Signal pulldown	2:A	Chr Sig	
Burst Signal	Disable	Enable or Disable	Video Processing/ Burst Signal pulldown	1:B	Burst	
VI Processing	Pass	Pass or Delete	Video Processing/ VI Processing pulldown	1:C	VI Proc	
Test Mode	Disable	Enable or Disable	Video Processing/ Test Mode pulldown	2:D	Tst Mode	Replace output signal with test pattern
Test Signal	Colorbar	Colorbar or Linearity	Video Processing/ Test Signal Select pulldown	2:C	Tst Sel	
Recall factory defaults	N/A	See Defaults column	Recall Factory Defaults/ Factory Defaults button	1:F (down)	N/A	

<sup>1</sup> The numeric displays are approximate values only. Calculation of displayed values are subject to decimal place truncation. Variation from the absolute value increases at higher adjustment levels.

## Local Onboard Module Configuration

The 8960ENC module can be configured locally using the rotary and toggle switches shown in [Figure 6](#). Two LEDs (CONF and 2nd) indicate status of the configuration process. These four components perform the following:

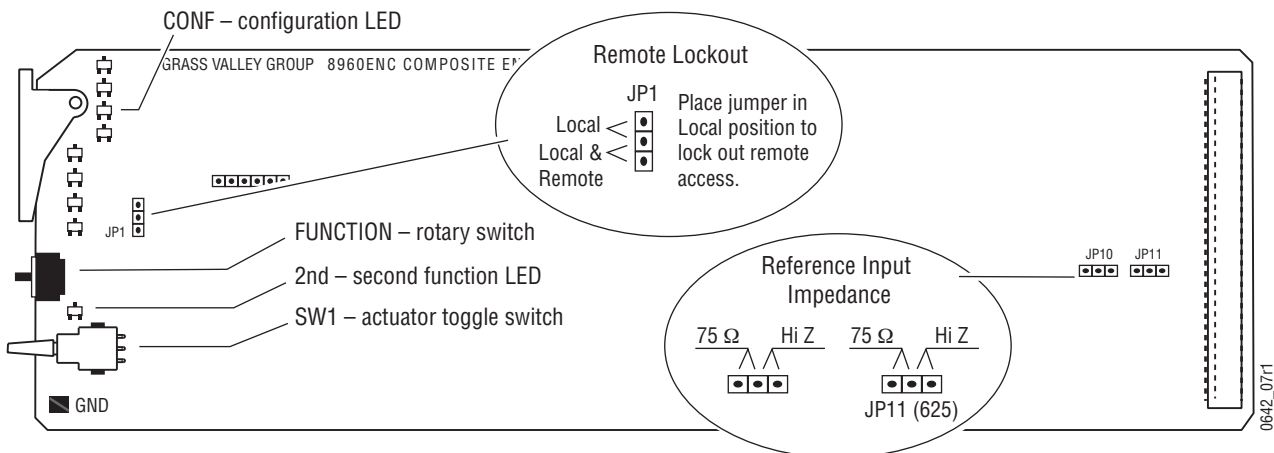
- Function (rotary) switch addresses a desired function for configuration and provides two sets (banks) of 16 functions (0 through 9, A through F), although not all positions are used.
- 2nd (second function) LED when on, indicates that the rotary switch is addressing the second (Bank 2) of functions (see [Table 5 on page 20](#)) that control the optional 8900FSS Frame Sync Submodule.
- SW1 (paddle) switch actuates or selects the desired setting for the selected function when the switch is held momentarily in either the up or down position.
- CONF (configuring) LED when on, indicates the module is initializing or processing configuration information.

**Note** Function switch position F (Recall) in Bank 1 can be used to return the module configuration to the factory default.

The following onboard jumpers are used to permit or lockout remote control and set reference input impedance.

- Remote Control Lockout – When a jumper is placed across pins 1 and 2 of jumper block JP1 (see [Figure 6](#)), module output mode settings are adjustable from the Local on-board switches only. To have both Local and Remote access, set the jumper across pins 2 and 3.
- Reference Input Impedance – When a jumper is placed across pins 1 and 2 of jumper block JP10 (525 line reference) or JP11 (625 line reference), Reference Input is terminated into 75  $\Omega$  (see [Figure 6](#)). To have high impedance termination, set the jumper across pins 2 and 3 of the appropriate jumper block.

Figure 6. Module Configuration Switches, LEDs, and Jumpers



## Onboard Module Configuration

To make configuration settings:

1. Rotate the Function Switch to Bank 1 (2nd LED off) or Bank 2 (2nd LED on) and to the desired function within that bank.

**Note** The Function switch should be kept in Bank 2 position E when not in use to avoid any inadvertent change in configuration. E is an inactive position.

2. Move the paddle switch to the up or down position and hold momentarily to set the desired function (refer to [Table 5 on page 20](#)).
3. Return the Function switch to Bank 2 position E when finished with entire configuration process.

## Adding/Deleting Setup for 525 Format

### Bank 1, Position 2

Bank 1, position 2 is an overall setup on/off selection which overwrites all other setup controls. When **Setup** (on) is selected for NTSC 525 format, all lines in the full-field (FF) picture—which is composed of AP (active picture) and VI (vertical interval)—have 54 mV setup added. The luma chroma gain is reduced to provide a 1 V peak-to-peak nominal level. When **No Setup** (off) is selected, AP and VI have no setup, and luma chroma gain is increased to provide a 1 V peak-to-peak nominal level.

When **Setup** is selected, setup can be selectively removed from lines 21, 22 or the vertical interval. When **No Setup** is selected, setup cannot be added to any line.

### Bank 1, Position D

Bank 1, position D controls setup **ON/OFF** for line 21 in both fields.

### Bank 1, Position E

Bank 1, position E controls setup **ON/OFF** for line 22 in both fields.

### Bank 2, Position F

Bank 2, position F controls setup **ON/OFF** VI lines only both fields.

When **Factory Default** is selected setup is on AP lines, no setup on VI lines, no setup on line 21, setup on line 22.

Table 5. Encoder Configuration Functions

	Function Switch	Paddle Switch Up	Paddle Switch Down	Function Description
<b>Bank 1 - 2nd LED Off</b>	<b>Input/Output Signal Adjustments</b>			
	0	Auto	Manual	Standard Recognition – Automatic standard recognition or manual select enable.
	1	525	625	Manual Standard – Selection of 525-line or 625-line signal. The internal automatic standard detection is disabled when Manual is selected.
	2	On	Off	Setup in the output video (this function is disabled if the standard is 625). Select On for NTSC, select Off for Japanese NTSC.
	3	NTSC	PAL-M	525 NTSC/PALM Selection – Defines the subcarrier frequency of the output video signal (Function is Disabled if standard is 625).
	4	Increase	Decrease	Output Video Level – controls $\pm 6$ dB gain adjustment of the output video signal in 256 steps.
	<b>Signal Processing Adjustments</b>			
	5	Enable	Calibrated †	User Adjustments – Enables processing amplifier functions (6-9) or selects Calibrated presets optimized for a calibrated video output.
	6	Increase	Decrease	Luma Level <sup>1</sup> – Can be adjusted $\pm 10\%$ in 256 incremental steps.
	7	Increase	Decrease	Black Level <sup>1</sup> – Can be adjusted $\pm 100$ mV in 256 incremental steps.
	8	Increase	Decrease	Chroma Level <sup>1</sup> – Can be adjusted $\pm 10\%$ in 256 incremental steps.
	9	+	-	Hue <sup>1</sup> – Chroma phase can be rotated from 0 to 360 degrees. Disabled if standard is PAL.
	<b>Signal Filtering Setup</b>			
	A	Enable	Disable	Enable/Disable modulated chroma signal
	B	Enable	Disable	Enable/Disable burst reference in the output signal
	C	Pass	Delete	VI Processing Options – Select Pass for picture content processed and passed through, or Delete to remove picture content.
	D	On	Off	Adds or removes setup for line 21 in both fields
	E	On	Off	Adds or removes setup for line 22 in both fields
	F		Recall	Factory Default – Resets all user adjustable parameters to optimized setting for a calibrated SDI input signal.

Table 5. Encoder Configuration Functions - (continued)

	Function Switch	Paddle Switch Up	Paddle Switch Down	Function Description
<b>Bank 2 - 2nd LED On</b>	0	Video	Reference	Lock Source – Selecting Video forces delay mode even if a reference signal is present
	1	+	–	Fine delay adjustment
	2	+	–	Horizontal Delay <sup>2</sup> – Provides synchronizer delay adjustment in clock increments and line increments accordingly.
	3	+	–	Vertical Delay <sup>2</sup> – Provides synchronizer delay adjustment in clock increments and line increments accordingly
	4	Manual	Auto	Freeze Recognition <sup>2</sup> – Selecting Auto stores the last field in the frame synchronizer to use if the input video is lost or corrupted.
	5	Off	On	Freeze Manual <sup>2</sup> – Enables/Disables manual selection of Freeze Mode according to positions 6&7.
	6	Frame	Field	Freeze Mode <sup>2</sup> – Select between Frame and Field.
	7	Field 1	Field 2	Freeze Field <sup>2</sup> – Select between Field 1 and Field 2.
	8	Last Field	Black	Freeze Signal <sup>2</sup> – Selects the freeze output signal if Auto or manual freeze is activated.
	9	currently not used		
	A	Enable	Disable	Cross color removal – Enables/Disables the cross-color removing 2D filter.
	B	currently not used		
	C	Colorbar	Linearity	Test Signal – Select between colorbar and linearity signal.
	D	Enable	Disable	Test Mode – If Test is selected, the input SDI is replaced with the test pattern selected in 2:C.
	E	Inactive Position		
	F	On	Off	Adds or removes setup for vertical interval in both fields

<sup>1</sup> Inactive if User Adjustments (switch position 5) is set to Calibrated

<sup>2</sup> Inactive if Frame Sync Submodule is not present

## Remote Configuration and Monitoring

8960ENC configuration and monitoring can be performed using a web browser GUI interface or a networked Newton Control Panel when the 8900NET Network Interface module is present in the video frame (Gecko 8900TFN-V frame). Each of these interfaces is described below.

**Note** For remote access, make sure the jumper block on the module is set for both Local and Remote access ([Figure 6 on page 18](#)).

### 8900NET Module Information

Refer to the 8900NET Network Interface Module Instruction Manual for information on the 8900NET Network Interface module and setting up and operating the Gecko 8900 frame network.

**Note** The 8900NET module in the frame must be running software version 3.2.2 or higher for proper remote and control panel operation. Upgrade software and instructions for the 8900NET can be downloaded from the Grass Valley web site.

### Newton Control Panel Configuration

A Newton Control Panel (hard or soft version) can be interfaced to the Gecko 8900 Series frame over the local network. Refer to the documentation that accompanies the Newton Modular Control System for installation, configuration, and operation information.

Control panel access offers the following considerations for module configuration and monitoring:

- Ability to separate system level tasks from operation ones, minimizing the potential for on-air mistakes.
- Ability to group modular products—regardless of their physical locations—into logical groups (channels) that you can easily manipulate with user-configured knobs.
- Update software for applicable modules and assign frame and panel IP addresses with the NetConfig Networking application.
- Recommended for real-time control of module configuration parameters, providing the fastest response time.

**Note** Not all module functions are available with the control panel, such as factory default recalls. The available control panel controls for the 8960ENC module are listed in [Table 4 on page 16](#).

An example of the Newton Configurator is shown in [Figure 7 on page 23](#).

Figure 7. Newton Configurator Example

Module (drag and drop from Device View)

Module Name: 8960ENC      Frame Name: Bay 1 QA 8900 Video     

Slot: 1      Frame IP Address: 10 . 16 . 18 . 108     

Label	Description	Type	PID	IID
State	Slot Status	switch	51	0
Input Sig	Input Signal	switch	52	0
Ref Sig	Reference Signal	switch	59	0
Auto Std	Standard Recognition	switch	710	0
Lines	Line Standard	switch	711	0
FF Setup	Output Video Setup	switch	712	0
525 Std	NTSC/PAL-M Select	switch	713	0
Video	Output Video Level	control	715	0
Levels	User Adjustments	switch	717	0
Luma	Luma Level	control	719	0
Black	Black Level	control	721	0

## Web Browser Interface

The web browser interface provides a graphical representation of module configuration and monitoring.

Use of the web interface offers the following considerations:

- Provides complete access to all module status and configuration functions, including naming of inputs and outputs, factory parameter and name default recalls, E-MEM functions, slot configuration, and SNMP monitoring controls.
- Web access will require some normal network time delays for processing of information.
- Configuration parameter changes may require pressing **Apply** button or **Enter**, upload processing time, and a manual screen refresh to become effective.
- Web interface recommended for setting up module signal and slot names, E-MEMS, and reporting status for SNMP and monitoring.

Refer to the Frame Status page shown in [Figure 8 on page 24](#). The 8900 modules can be addressed by clicking either on a specific module icon in the frame status web page or on a module name or slot number in the link list on the left.

**Note** The physical appearance of the graphics on the web pages shown in this manual represent the use of a particular platform, browser and version of 8900NET module software. They are provided for reference only. Web pages will differ depending on the type of platform and browser you are using and the version of the 8900NET software installed in your system. This manual reflects 8900NET software version 3.2.2.

For information on status and fault monitoring and reporting shown on the Status page, refer to *Status Monitoring on page 46*.

Figure 8. Gecko 8900 Frame Status Page

The Links section lists the frame and its current modules. The selected link's Status page is first displayed and the sub-list of links for the selection is opened. The sub-list allows you to select a particular information page for the selected device.

Content display section displays the information page for the selected frame or module (frame slot icons are also active links).

Refresh button for manual update of page

**Status**

Model: 8900TFN-V Description: Module Frame  
 Frame Location: 8900: QA Bay 1  
 Frame Health Alarm **WARNING** Temperature Status Pass  
**WARNING - Module Data or Config Errors**

Module	Empty	Empty	Module	Empty	Module	Empty	Empty	Empty	Empty	Net Card	Empty	Power Supply
--------	-------	-------	--------	-------	--------	-------	-------	-------	-------	----------	-------	--------------

Front Cover No Cover

**Properties**

Vendor	Thomson, Grass Valley	Software Version	3.2.2
Media Slots	10	Network Config	Network configuration stored on frame

[Bay 1 QA 8900 Video](#)  
[Status](#)  
[Configuration](#)  
[Connections](#)  
[1 8960ENC](#)  
[2 Media Slot 2](#)  
[3 Media Slot 3](#)  
[4 8964ENC](#)  
[5 Media Slot 5](#)  
[6 8990ARC](#)  
[7 Media Slot 7](#)  
[8 Media Slot 8](#)  
[9 Media Slot 9](#)  
[10 Media Slot 10](#)  
[11 8900NET](#)  
[12 Power Supply 1](#)  
[13 Power Supply 2](#)

0642\_10



## 8960ENC Links and Web Pages

The 8900 web interface GUI provides the following links and web pages for the 8960ENC module (Figure 9):

- Status – reports input and reference signal status and module information (page 26),
- Standard Selection – provides controls for setting module line standard and setting output video levels (page 27),
- Levels – provides access to controls for adjusting luma, chroma, hue, and black levels (page 30),
- Timing – provides lock source and fine phase adjustments and horizontal and vertical timing adjustments when the 8900FSS is installed (page 32),
- Video Processing – provides controls for enabling and disabling video functions on the encoded output (page 35),
- Recall Factory Defaults – use this web page to recall factory defaults for the module (page 36),
- Slot Config – provides a Locate Module function, Slot Identification fields, Slot Memory controls, and SNMP Trap enables (page 37), and
- Software Update – provides information on updating software (page 39).

Figure 9. 8960ENC Web Page Links

[1 8960ENC](#)  
[Status](#)  
[Standard Selections](#)  
[Levels](#)  
[Timing](#)  
[Video Processing](#)  
[Recall Factory Defaults](#)  
[Slot Config](#)  
[Software Update](#)



On all web pages, click on **Apply** to activate settings in each selection then refresh the web page at the top of the page with the **Refresh** button (both shown at left).

Refer to [Table 4 on page 16](#) for a complete summary of controls, defaults, and parameter ranges.

- Use this link
- [1 8960ENC](#)
  - [Status](#)
  - [Standard Selections](#)
  - [Levels](#)
  - [Timing](#)
  - [Video Processing](#)
  - [Recall Factory Defaults](#)
  - [Slot Config](#)
  - [Software Update](#)

### Status Web Page

The Status web page (Figure 10) shows the input signal status of the component analog video input. Color coding of the display indicated the signal status. Refer to *Status Monitoring* on page 46 for an explanation of the color coding.

Information about the module, such as part number, serial number, hardware revision and software and firmware versions are given in a read-only section at the bottom of the display.

Figure 10. 8960ENC Status Web Page

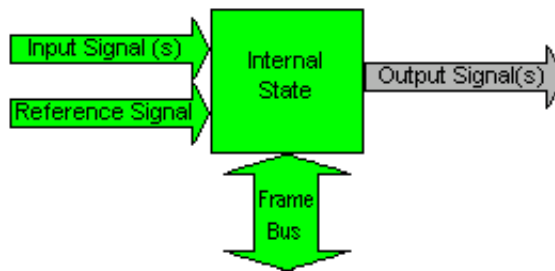


Model: [8960ENC](#) Description: [4:2:2 To NTSC/PAL Encoder](#)

Frame Location: [not assigned](#) , Slot: [1](#)

Input Signal Name: [not assigned](#)

8960ENC Status [PASS](#)



### Properties

Hardware Revision [01](#)    Serial Number [1229171](#)  
Software Version [8.0.2](#)    Part Number [671-4698](#)  
Firmware Version [08](#)

- Use [1 8960ENC](#)
- this [Status](#)
- link [Standard Selections](#)
- [Levels](#)
- [Timing](#)
- [Video Processing](#)
- [Recall Factory Defaults](#)
- [Slot Config](#)
- [Software Update](#)

## Standard Selection Web Page

The Standard Selections web page provides selections to set the line standard and output video level for the module.

Set the following parameters on this web page:

- Set the Standard Recognition control to either **Auto** or **Manual**. **Auto** mode allows the module to detect and accept either a 525-line or 625-line input signal. The line standard value will be reported as a read-only value in the menu when **Auto** is selected (see Figure 11).

Figure 11. Standard Selection Web Page

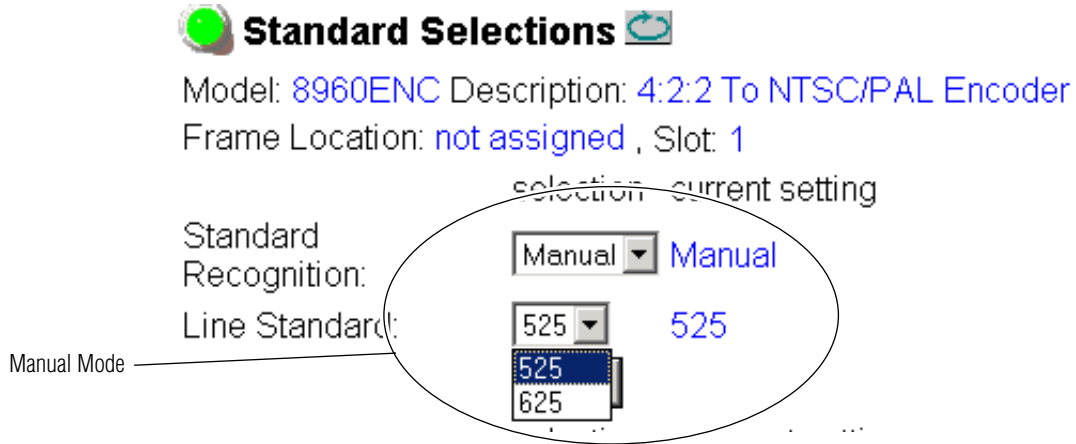
**Standard Selections**

Model: [8960ENC](#) Description: [4:2:2 To NTSC/PAL Encoder](#)  
 Frame Location: [not assigned](#) , Slot: [1](#)

	selection	current setting
Standard Recognition:	<input type="text" value="Auto"/>	<a href="#">Auto</a>
Line Standard:		<a href="#">525</a>
	<input type="button" value="Apply"/>	
	selection	current setting
Output Video Setup:	<input type="text" value="Setup"/>	<a href="#">Setup</a>
	<input type="button" value="Apply"/>	
	selection	current setting
VI Setup:	<input type="text" value="Off"/>	<a href="#">Off</a>
Line 21 Setup:	<input type="text" value="Off"/>	<a href="#">Off</a>
Line 22 Setup:	<input type="text" value="On"/>	<a href="#">On</a>
NTSC/PAL-M Select:	<input type="text" value="NTSC"/>	<a href="#">NTSC</a>
	<input type="button" value="Apply"/>	
	selection	current setting
Controls Type:	<input type="text" value="Numeric"/>	<a href="#">Numeric</a>
	<input type="button" value="Apply"/>	
Output Video Level (% 1Vpp)		
<input type="button" value="&lt;&lt;"/>	<input type="text" value="96.07"/>	<input type="button" value="&gt;&gt;"/>
<input type="button" value="&lt;"/>	<input type="button" value="Apply"/>	<input type="button" value="&gt;"/>

The **Manual** setting forces the module to operate in the mode chosen by the user. If **Manual** is selected, the **Line Standard** control will appear and allow selection of either **525** or **625** (Figure 12).

Figure 12. Standard Selection Web Page – Manual Mode



- The Output Video Setup control appears only when a 525-line standard is enabled, either manually or automatically. For output video with 54 mV of setup, select **Setup**. Select **No Setup** for Japanese NTSC or other requirements with no setup.

When **Setup** (on) is selected for NTSC 525 format, all lines in the full-field (FF) picture—which is composed of AP (active picture) and VI (vertical interval)—have 54 mV setup added. The luma chroma gain is reduced to provide a 1 V peak-to-peak nominal level. When **No Setup** (off) is selected, AP and VI have no setup, and luma chroma gain is increased to provide a 1 V peak-to-peak nominal level.

When **Setup** is selected, setup can be selectively removed from lines 21, 22 or the vertical interval. When **No Setup** is selected, setup cannot be added to any line.

Factory default provides setup on AP lines, no setup on VI lines, no setup on line 21, and setup on line 22.

- Select **NTSC** or **PAL-M** subcarrier format.

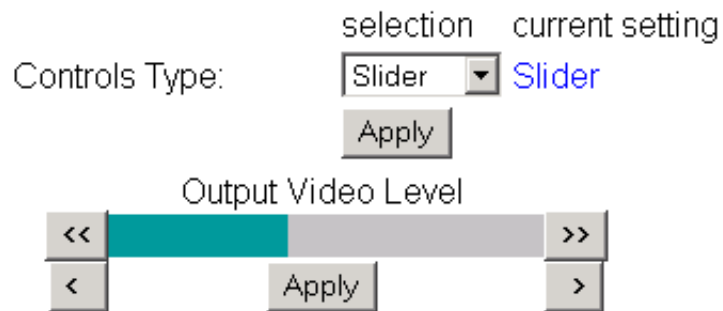
- Adjust the Output Video Level using either the **Slider** or **Numeric** adjustment mode (see [Figure 11 on page 27](#) for numeric control and [Figure 13](#) for slider control).

The gain of the output video is adjusted relative to a calibrated value of 1 V p-p (100%). For example, if you have an output of 1V p-p, the value would be set to 100%.

In either adjustment mode, the single arrow will increment the value by approximately 0.5% per click. The double arrows increment or decrement the value by approximately 10x (5% per click).

**Note** Numeric displays are for approximate values only. Calculation of displayed values are subject to decimal place truncation. Variation from the absolute value increases at higher adjustment levels.

Figure 13. Slider Output Level Adjustments



- Use this link
- [1 8960ENC](#)
  - [Status](#)
  - [Standard Selections](#)
  - [Levels](#)
  - [Timing](#)
  - [Video Processing](#)
  - [Recall Factory Defaults](#)
  - [Slot Config](#)
  - [Software Update](#)

## Level Adjustment Web Page

The Levels web page provides access to processing amplifier controls. You may select user adjustable or calibrated level modes.

Set the User Adjustments pulldown to either **Calibrate** or **User**.

In **Calibrate** mode, the module selects preset factory default values optimized for a calibrated video output. The values will be reported as read-only as shown in [Figure 14](#).

Figure 14. Levels Web Page – Calibrate Mode

**Levels**

Model: 8960ENC Description: 4:2:2 To NTSC/PAL Encoder  
 Frame Location: not assigned , Slot: 1

User Adjustments: selection current setting  
 **Calibrate**

Controls Type: selection current setting  
 **Numeric**

Luma Level: 99.74 % white      Black Level: 7.54 % white  
 Chroma Level: 99.52 % saturation  
 Hue: 0.00 degrees

In **User** mode, select **Slider** or **Numeric** adjustment mode to adjust the following output video parameters (see [Figure 15 on page 31](#) for numeric controls and [Figure 16 on page 31](#) for slider controls):

- Luma level (luminance gain relative % white),
- Chroma level (chrominance gain relative % saturation),
- Hue, 0 – 360 degrees (525 standard only), and
- Black level (black level relative to % white).

In either adjustment mode, the single arrow will increment/decrement the values by approximately 1x the parameter value. The double arrows will increment/decrement the values by approximately 10x. In **Numeric** adjustment mode, you may also enter a value directly into the window.

**Note** Numeric displays are for approximate values only. Calculation of displayed values are subject to decimal place truncation. Variation from the absolute value increases at higher adjustment levels.

Figure 15. Levels Web Page – User Mode

**Levels**

Model: 8960ENC Description: 4:2:2 To NTSC/PAL Encoder  
 Frame Location: not assigned , Slot: 1

User Adjustments: selection current setting  
 User

Controls Type: selection current setting  
 Numeric

Luma Level (% white)    
 Black Level (% white)

Chroma Level (% saturation)

Hue (degrees)

Figure 16. Levels Web Page – Slider Controls

Controls Type: selection current setting  
 Slider

Luma Level

Black Level

Chroma Level

Hue

- 1 [8960ENC](#)
  - [Status](#)
  - [Standard Selections](#)
  - [Levels](#)
  - [Timing](#)
  - [Video Processing](#)
  - [Recall Factory Defaults](#)
  - [Slot Config](#)
  - [Software Update](#)
- Use this link

## Timing Web Page

The Timing web page shown in [Figure 17 on page 33](#) (Numeric control mode) or [Figure 18 on page 34](#) (Slider control mode) provides lock source selection and fine phase adjustments for the output video. When the optional Frame Sync submodule is installed, additional horizontal and vertical phase adjustments and freeze options become available.

Select the **Apply** button to activate each selection.

Adjustment parameters may be selected in **Slider** or **Numeric** mode. Select the desired mode in the Controls Type window. In either mode, the single arrow will increment/decrement the values by approximately 1x the value of the parameter. The double arrows will increment/decrement the values by approximately 10x. In **Numeric** adjustment mode, you may also enter a value directly into the window.

Set the following parameters in this web page:



- Choose a Lock Source from **Reference** input or **Video** input.
- Adjust the Fine Delay in nanoseconds with either **Slider** or **Numeric** adjustment mode.

If the optional 8900FSS Frame Sync submodule is installed (Submodule Option: Present as shown in [Figure 17 on page 33](#)), you can also make the following delay adjustments and set freeze operation parameters:

- Adjust Horizontal Delay in nanosecond increments and Vertical Delay phase adjustment in line increments in either **Slider** or **Numeric** mode.
- Set Freeze Recognition to **Manual** or **Auto**. Selecting **Auto** stores the last field in the Frame Synchronizer to use if the input video is lost or corrupted.
- Set the Freeze Mode to **Frame** or **Field**.
- Set the Freeze Field to **Field 1** or **Field 2**.
- Set the Freeze Signal to **Last Field** or **Black**. This will determine the freeze output signal when a freeze is activated in either **Auto** or **Manual** mode.
- To perform a manual freeze, click the **Freeze** button at the lower left of the web page.



Figure 17. Timing Web Page

 **Timing** 

Model: 8960ENC Description: 4:2:2 To NTSC/PAL Encoder  
 Frame Location: not assigned , Slot: 1  
 Submodule Option: Present

Lock Source: selection    current setting  
 Reference

Fine Delay (ns)

Controls Type: selection    current setting  
 Numeric

Horizontal Delay (ns) Vertical Delay (lines)

Freeze Recognition: selection    current setting  
 Manual  
 Freeze Mode:  Frame  
 Freeze Field:  Field 1  
 Freeze Signal:  Last Field

Figure 18. Timing Web Page – Slider Controls

## Timing

Model: 8960ENC Description: 4:2:2 To NTSC/PAL Encoder

Frame Location: not assigned , Slot: 1

Submodule Option: Present

Lock Source: selection  current setting Reference

Fine Delay

Controls Type: selection  current setting Slider

Horizontal Delay

Vertical Delay

Freeze Recognition: selection  current setting Manual  
Freeze Mode:  Frame  
Freeze Field:  Field 1  
Freeze Signal:  Last Field

- Use this link
- [1 8960ENC](#)
  - [Status](#)
  - [Standard Selections](#)
  - [Levels](#)
  - [Timing](#)
  - [Video Processing](#)
  - [Recall Factory Defaults](#)
  - [Slot Config](#)
  - [Software Update](#)

## Video Processing Web Page

Use the Video Processing web page shown in Figure 19 to enable or disable the:

- Cross-color removing 2D filter,
- Modulated chrominance signal,
- Burst reference in the output signal, and
- Test Mode signal output.

In the VI Processing pulldown select **Pass** or **Delete** VI signal. When **Pass** is selected, the picture content in the vertical interval is processed and passed through. If **Delete** is selected, the picture content is removed from the vertical interval.

If **Test Mode** is enabled, choose **Colorbar** or **Linearity** as the test output signal.

Figure 19. Video Processing Web Page

**Video Processing**

Model: 8960ENC Description: 4:2:2 To NTSC/PAL Encoder  
 Frame Location: not assigned, Slot: 1

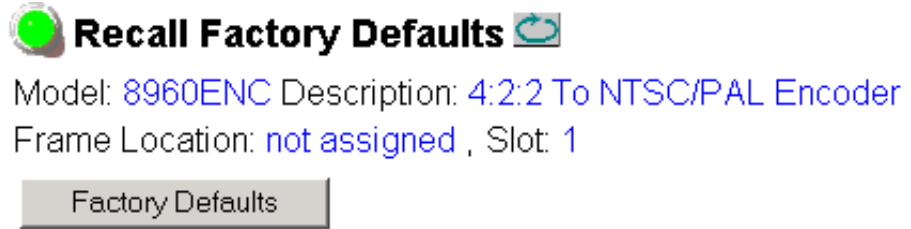
	selection	current setting
Cross-Color Removal:	<input type="button" value="Disable"/>	Disable
Chrominance Signal:	<input type="button" value="Enable"/>	Enable
Burst Signal:	<input type="button" value="Enable"/>	Enable
VI Processing:	<input type="button" value="Pass"/>	Pass
	<input type="button" value="Apply"/>	
	selection	current setting
Test Mode:	<input type="button" value="Enable"/>	Enable
Test Signal Select:	<input type="button" value="Colorbar"/>	Colorbar
	<input type="button" value="Apply"/>	

- 1 [8960ENC](#)
  - [Status](#)
  - [Standard Selections](#)
  - [Levels](#)
  - [Timing](#)
  - [Video Processing](#)
  - [Recall Factory Defaults](#)
  - [Slot Config](#)
  - [Software Update](#)
- Use this link

### Recall Factory Defaults Web Page

Factory default settings can be recalled by selecting the **Factory Defaults** button shown in [Figure 20](#) on the Recall Factory Defaults web page.

Figure 20. Factory Default Recall Web Page



## Slot Config Web Page

Use the Slot Config web page (Figure 21 on page 38) to perform the following functions on the 8960ENC module:

Use  
this  
link

- [1 8960ENC](#)
- [Status](#)
- [Standard Selections](#)
- [Levels](#)
- [Timing](#)
- [Video Processing](#)
- [Recall Factory Defaults](#)
- [Slot Config](#)
- [Software Update](#)

- **Locate Module** – selecting the **Flash** radio button flashes the yellow COMM and CONF LEDs on the front of the module so it can be located in the frame.
- **Slot Identification** – you may identify the module by typing a specific name in the **Name** field. The assigned name is stored on the 8900NET module and travels with the 8900NET module if it is moved to another frame. Select **Default** to enter the factory default module name.

An **Input Signal Name** field is also provided for entering a name for the input signal. Press the **Default** button to return to the factory default name.

- **Slot Memory** – the slot configuration for each media module is automatically saved periodically (once an hour) to the 8900NET module in that frame. You may also select the **Learn Module Config** button at any time to save the current configuration for this slot. The configuration is saved on the 8900NET module. If the 8900NET module is removed or powered down, the stored configurations are not saved.

When the **Restore upon Install** box has been checked, the current configuration saved to this slot is saved as slot memory. When the current module is removed and another module of the same type is installed, the configuration saved to the 8900NET module will be downloaded to the new module. The box must be checked before the current module with the saved configuration is removed.

- **Frame Health Reporting** – this function is not active with the latest version of the 8900NET module that controls this page.
- **Hardware Switch Controls** – a read-only status report of 8900NET module switch settings for Module Status Reporting and Asynchronous Status Reporting. These functions must be enabled for the following Slot SNMP Trap Reports to function.
- **Slot SNMP Trap Reports** – displayed only when the SNMP Agent software has been installed on the 8900NET module. Slot SNMP traps can be enabled only when the hardware switches for Module Fault reporting and Asynchronous Status reporting are enabled on the 8900NET module (dipswitch S1 segment 5 and dipswitch S2 segment 1).

The enabled SNMP traps will be reported to any SNMP manager that is identified as an SNMP Report Destination in 8900NET configuration. Trap severity is read-only hard-coded information that is interpreted and responded to by the SNMP Manager software configuration.

Figure 21. 8960ENC Slot Config Web Page

 **Slot Config** 

Model: [8960ENC](#) Description: [4:2:2 To NTSC/PAL Encoder](#)  
 Frame Location: [not assigned](#) , Slot: [1](#)

**Locate Module**

Flash  Off

**Slot Identification**

Name:

Input Signal Name:

**Slot Memory**

Restore upon Install

**Frame Health Reporting**

	Slot Fault	Signal Loss	Reference Loss
Enabled	<input checked="" type="checkbox"/>	<input type="checkbox"/>	<input type="checkbox"/>

**Hardware Switch Controls**

Module Status Reporting: [Enabled](#) Asynchronous Status Reporting: [Enabled](#)

**Slot SNMP Trap Reports**

	Slot Fault	Module Removed	Signal Loss	Reference Loss
Enabled	<input checked="" type="checkbox"/>	<input checked="" type="checkbox"/>	<input checked="" type="checkbox"/>	<input checked="" type="checkbox"/>
Trap Severity	<a href="#">Alarm</a>	<a href="#">Warning</a>	<a href="#">Warning</a>	<a href="#">Warning</a>

- [1 8960ENC](#)
  - [Status](#)
  - [Standard Selections](#)
  - [Levels](#)
  - [Timing](#)
  - [Video Processing](#)
  - [Recall Factory Defaults](#)
  - [Slot Config](#)
  - [Software Update](#)
- Use this link

### Software Update Web Page

The Software Update page (Figure 22) is not currently used to download module software updates via the web. For instructions on updating to the latest software, refer first to the 8960ENC Release Notes that accompany the software update for complete details.

Currently, the only recommended method of software updating is done with a software kit (8900-FLOAD-CBL) that includes a CD-ROM with the current software files and a serial cable assembly available from Grass Valley.

Refer to the 8900-FLOAD-CBL Software Upgrade Instruction Manual in pdf format on the CD-ROM for complete updating instructions and the required software files for the module.

Figure 22. 8960ENC Software Update Web Page

**Software Update**

Model: 8960ENC Description: 4:2:2 To NTSC/PAL Encoder  
 Frame Location: not assigned , Slot: 1  
 Software Version: 8.0.2 Firmware Version: 08  
[Enter Username, Password and File to Initiate Update](#)

	selection	current setting
FTP Server Address:	<input type="text" value="10.16.4.103"/>	10.16.4.103
File Path:	<input type="text" value="Enter Filename Here"/>	Enter Filename Here
FTP UserName:	<input type="text"/>	
FTP Password:	<input type="text"/>	
	<input type="button" value="Apply"/>	

# Specifications

Table 6. 8960ENC Specifications

Parameter	Value
<b>Input</b>	
Number of inputs	1
Input signal formats	Serial digital video conforming to SMPTE 259M 10-bit, 4:2:2 component digital signal
Common Mode Rejection	2 V peak to peak to 60 Hz
Impedance	75 $\Omega$ , loop-through
Return loss	> 15 dB up to 270 MHz
Equalization	300 meters (984 ft.) Belden 8281 cable
Connector	75 $\Omega$ BNC on 8900 frame
<b>Analog Outputs</b>	
Number of outputs	4
Signal type	Composite analog video conforming SMPTE170M for NTSC and CCIR624 for PAL-B
Signal level	1 V peak to peak nominal $\pm 6$ dB
Clamping level	0.0 VDC +20 mV/-0.0 mV
Output impedance	75 $\Omega$
Connector type	75 $\Omega$ BNC on 8900 frame
Output return loss	> 40 dB to 5.5 MHz
Output isolation	> 46 dB to 5.5 MHz
Frequency response	$\pm 0.1$ dB to 5.5 MHz
Differential phase	< 0.5 degrees
Differential gain	< 0.9%
Group delay	< 10 ns to 5.5 MHz
RMS signal-to-noise	> 59 dB to 5.5 MHz
Resolution	10 bits
Phasing	Full-frame with optional frame synchronizer
Fine Phase	0-45 ns
Electrical length	2.1 $\mu$ s $\pm 0.1$ $\mu$ s
Accuracy	9.2 bits



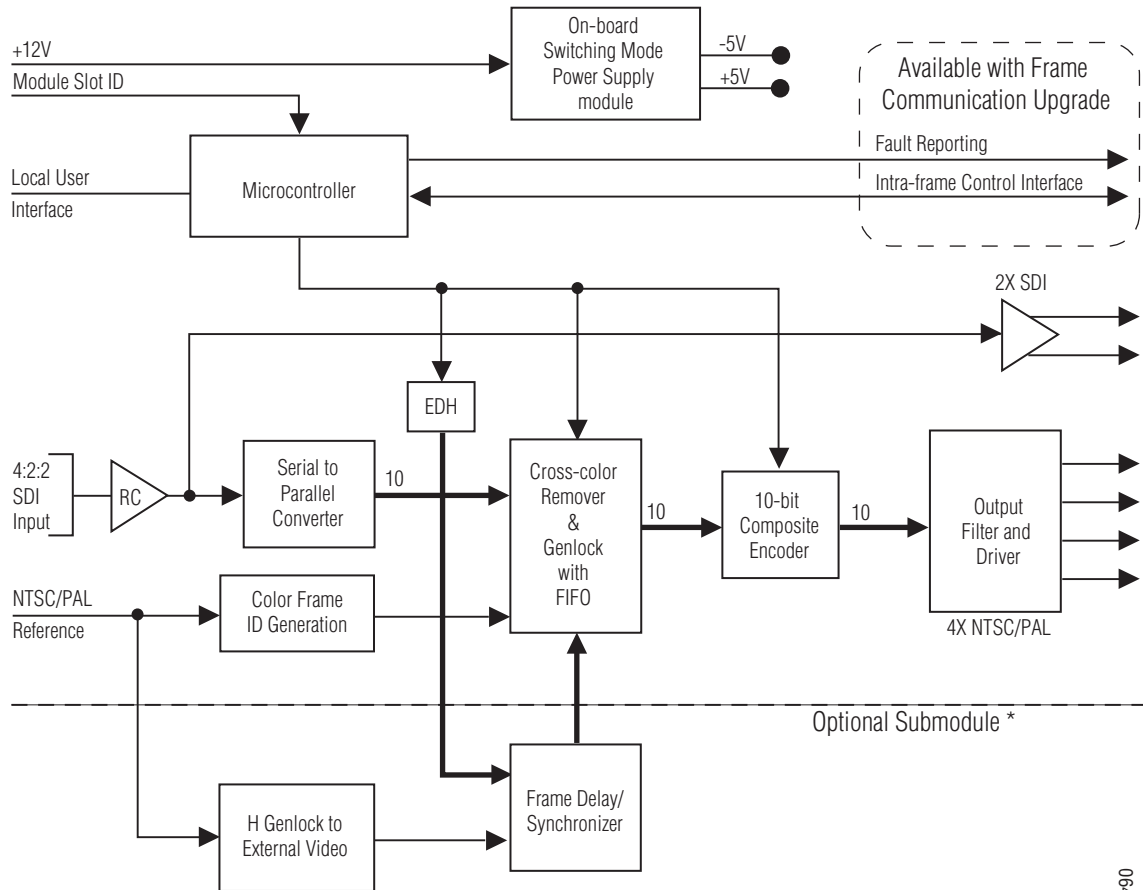
Table 6. 8960ENC Specifications - (continued)

Parameter	Value
<b>Serial Digital Outputs</b>	
Number of outputs	2
Signal type	Serial digital video conforming to SMPTE259M 10bit 4:2:2 component digital signal
Signal Level	800 mV +/-10%
Connector type	75 $\Omega$ BNC on 8900 frame
Output Return Loss	> 15 dB up to 270 MHz
Jitter	Conforms to SMPTE 17.2/002
Rise/Fall Times	400-700 ps (20-80% amplitude)
<b>Reference Input</b>	
Number of references	2
Signal type	Black Burst Separate input assigned for SMPTE170M signal (525) and CCIR624 signal (625)
Signal level	Sync: 300 mV p-p $\pm$ 3 dB
Input impedance	75 $\Omega$ or high impedance, jumper selectable
Connector type	75 $\Omega$ BNC on 8900 frame
Return loss	> 36 dB to 5 MHz
RMS signal-to-noise	> 40 dB to 5 MHz
SCH error	$\leq$ 60 degrees
Color-frame locking	Composite analog video output and reference signal must be within $\pm$ 10 video lines phase difference or color-frame lock will be in free-run mode
<b>Environmental</b>	
Frame temperature range	See Gecko Frame manual
Operating Humidity Range	0 to 90% non-condensing
Non-operating Temperature	-10 to +70 degrees C
<b>Mechanical</b>	
Frame type	Gecko 8900 Series Video
<b>Power Requirements</b>	
Supply voltage	+ 12V
Power Consumption	< 6.5 Watts, < 8.5 Watts with Frame Sync option

# Functional Description

Refer to the block diagram in [Figure 23](#) while reading the following functional description.

Figure 23. 8960ENC Block Diagram



\* The main encoder module automatically recognizes the attachment of the frame synchronizer submodule.

0642-01

## Serial 4:2:2 Input Stage & Output

The SDI signal is connected to the high impedance loop-through input. The input amplifier auto-equalizes the signal up to 24 dB loss (300 meters of Belden 8281 cable). The reclocked signal is available on two SDI output connectors and also on an internal 10-bit parallel bus for further processing. Error Detection Handling (EDH) is tested by the microcontroller which flashes the Fault LED when errors are detected.

## **Cross-Color Remover**

The encoder accepts 525/625 component video and before the composite encoding, removes luminance components that could cause discoloration in high detail diagonal content areas. By doing this at the decoder side, there are no artifacts when using digital comb filtering based decoders such as the 8960DEC Adaptive Decoder. The pre-filtering is done in a Field Programmable Gate Array (FPGA) using a spatio-temporal comb filter that gives full vertical resolution while removing all unwanted cross-color details. All the necessary timing and interfacing signals are generated internally and adjusted automatically to the incoming signal's standard.

## **Synchronizer**

Phasing range is infinite with the addition of the optional frame synchronizer module. The frame synchronizer is locked to the selected reference in the horizontal and vertical domain in 37 ns steps.

## **10-bit Encoder and Output Driver**

The 10-bit precision encoder can be switched through auto/manual standard selection to multi-standard outputs:

- NTSC
- PAL-B
- PAL-M

Fine phase adjustment is available within a 0-45 ns range.

The oversampling restoration filter gives an exceptionally flat response and a linear phase signal that is amplified and automatically DC-restored before it is output to the four BNC connectors.

## **Color-frame Lock**

When the Lock Source is set to Reference (factory default configuration), the composite output video is automatically color-frame locked when a blackburst reference signal is present. The composite analog video output signal and the reference have to be frequency-locked and the phase difference has to be within  $\pm 10$  video lines for color-frame locking.

If during module configuration Lock Source is set to Video, color-frame lock is free-running. If the output signal is PAL-M encoded, the board locks to NTSC reference signal.

## **Microcontroller**

At power up, the microcontroller configures the encoder chip and loads the firmware according to the last stored user settings. The user adjustable parameters are input through a multifunction rotary and toggle switch combination interface with a preset option of the factory recall settings. All the functions are remote read/writable through the intraframe control interface (available in 8900TX/TF/TFN frames). The Fault Reporting output is pulsed in case of loss of input signal.

## **Regulator**

The input +12 V is stepped down to +5 V and -5 V using an on-board switched mode drop (buck) regulator. The regulator does not start up until the main supply voltage reaches approximately 80% of its nominal value.

# Service

The 8960ENC modules make extensive use of surface-mount technology and programmed parts to achieve compact size and adherence to demanding technical specifications. Circuit modules should not be serviced in the field unless directed otherwise by Customer Service.

If your module is not operating correctly, proceed as follows:

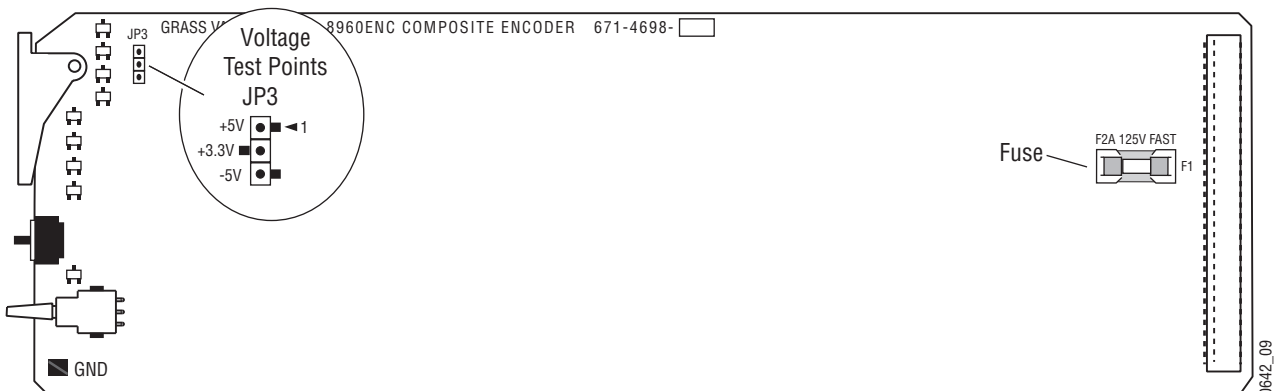
- Check frame and power and signal present LEDs.
- Check module voltage testpoints and fuse (Figure 24).
- Check for presence and quality of input signals.
- Verify that source equipment is operating correctly.
- Check cable connections.

Refer to Figure 5 for the location of PWR LED and Table 2 on page 13 for proper LED indications.

If the module is still not operating correctly, replace it with a known good spare and return the faulty module to a designated Grass Valley repair depot. Call your Grass Valley representative for depot location.

Refer to the [Contacting Grass Valley](#) at the front of this document for the Grass Valley Customer Service Information number.

Figure 24. Module Voltage Testpoints and Fuse



## Status Monitoring

This section provides a summary of status monitoring and reporting for a Gecko 8900 Series system. It also summarizes what status items are reported and how to enable/disable reporting of each item. There are a number of ways to monitor status of modules, power supplies, fans and other status items depending on the method of monitoring being used.

8900 Frame status will report the following items:

- Power supply health,
- Status of fans in the frame front cover,
- Temperature,
- Module health, and
- Frame bus status.

Module health status will report the following items:

- Internal module state (and state of submodule or options enabled) including configuration errors (warning), internal faults, and normal operation (Pass).
- Signal input states including valid/present (pass), not present or invalid (warning), not monitored, and not available (no signal inputs).
- Reference input states including locked/valid (pass), not locked/invalid (warning), and not monitored.
- Signal output states with reporting functionality (reference output).

## LEDs

LEDs on modules in the frame and on the front of the 8900TF/TFN frames indicate status of the frame and the installed power supplies, fans in the front covers, and modules. (The 8900TX-V/A frames have no LED indicators on the front cover.)

When a red FAULT LED is lit on a frame front cover, the fault will also be reported on the 8900NET or Frame Monitor module. The LEDs on the front of these modules can then be read to determine the following fault conditions:

- Power Supply 1 and 2 health,
- Fan rotation status,
- Frame over-temperature condition,
- Frame Bus fault (8900NET only), and
- Module health bus.

In general, LED colors used on the frame and modules indicate:

- Green – normal operation, (Pass) or signal present, module locked.
- Red – On continuously = fault condition, flashing = configuration error.
- Yellow – On continuously = active condition (configuration mode or communication), flashing in sequence = module locator function.

Status LEDs for this module are described in [Operation Indicator LEDs on page 12](#). LEDs for the 8900NET module are described in the *8900NET Network Interface Instruction Manual*.

## Frame Alarm

A Frame Alarm connection is available on pins 8 and 9 of the RS-232 connector on the rear of 8900 frame (Frame Monitor or 8900NET Network Interface module required). This will report any of the status items enabled with the 8900NET or Frame Monitor module configuration DIP switch. Connection and use of the Frame Alarm is covered in detail in the 8900NET Network Interface Instruction Manual.

## Web Browser Interface

When the 8900NET module is installed in the frame, a web browser GUI can indicate frame and module status on the following web pages:

- Frame Status web page – reports overall frame and module status in graphical and text formats.
- Module Status web page – shows specific input and reference signal status to the module along with enabled options and module versions.
- A Status LED icon on each web page to report communication status for the frame slot and acts as a link to the Status web page where warnings and faults are displayed (8900NET version 3.0 or later).

In general, graphics and text colors used indicate the following:

- Green = Pass – signal or reference present, no problems detected.
- Red = Fault – fault condition.
- Yellow = Warning – signal is absent, has errors, or is mis-configured.
- Gray = Not monitored (older 8900 module).
- White = Not present.

Status reporting for the frame is enabled or disabled with the configuration DIP switches on the 8900NET module. Some module status reporting items can also be enabled or disabled on individual configuration web pages.

## **SNMP Reporting**

The Gecko 8900 Series system uses the Simple Network Monitoring Protocol (SNMP) internet standard for reporting status information to remote monitoring stations. When SNMP Agent software is installed on the 8900NET module, enabled status reports are sent to an SNMP Manager such as the Grass Valley's NetCentral application.

There are both hardware and software report enable switches for each report. Both must be enabled for the report to be sent. Software report switches are set on the 8900NET Configuration web page for the Frame, the 8900NET module, and each module slot. Refer to the 8900NET Network Interface Instruction Manual for installation instructions.



# Index

## Numerics

- 8900 frame
  - frame alarm 47
  - status reporting 46
- 8900-FLOAD-CBL option 39
- 8900FSS (Frame Sync option) 32
  - installation 10
  - termination 10
- 8900FSS Frame Sync 18
- 8900NET module
  - required software version 22
- 8960ENC module
  - features 7
  - installation 8

## A

- activate freeze 32
- Apply button 25

## B

- backplane 9
- black burst
  - reference input 11
- black level
  - local control 20
  - remote control 30
  - summary table 16
- block diagram 42
- burst signal
  - local control 20
  - remote control 35
  - summary table 17

## C

- calibrated levels 30
- chroma level
  - local control 20
  - remote control 30

- summary table 16
- chrominance signal
  - local control 20
  - remote control 35
  - summary table 17
- configuration 18
  - local 18
  - Newton Control Panel 16
  - Remote, GUI 22
  - summary 15
  - summary table 16
- connectors 11
- control panel 22
- controller module 8
- cross color removal
  - local control 21
  - remote control 35
  - summary table 17

## D

- delay 32
- documentation online 2

## E

- enable SNMP 48
- environmental 41

## F

- factory default 12, 15
- factory defaults
  - recalling with local controls 20
  - remote control 36
  - summary table 16, 17
- FAQ database 2
- fault 13
- FAULT LED
  - troubleshooting 46
- fine delay

- local control 21
- remote control 32
- summary table 17

frame 8, 41

- module placement 8

Frame Status page 47

freeze controls

- local controls 21
- remote controls 32
- summary table 17

frequently asked questions 2

## G

graphical user interface (GUI) 25

Grass Valley web site 2

## H

horizontal delay 32

- local control 21
- remote control 32
- summary table 17

hue

- local control 20
- remote control 30
- summary table 16

## I

indicators 13

input

- loophrough 11
- specification 40
- standard 15
- termination 11

inputs

- reference 11

installation 8

- 8900FSS (Frame Sync option) 10

## L

Learn Module Config button 37

line 21 setup

- local control 20
- summary table 16

line 22 setup

- local control 20
- summary table 16

locate module 37

lock source 32

lock source selection

- local control 21
- remote control 32
- summary table 16

loop-through 11

luma level

- local control 20
- remote control 30
- summary table 16

## M

manual freeze 32

manual standard selection

- local control 20
- remote control 28
- summary table 16

Mode 17

module

- controller 8
- installation 8
- power supply 8
- slots 9

module health status 46

Module Status page 47

## N

Newton Control Panel

- overview 22
- summary table 16

numeric displays 30

## O

online documentation 2

operational modes 13

output video level

- local control 20
- remote control 29
- summary table 16

output video setup

- local control 20
- summary table 16

- outputs
  - analog 40
  - cabling 11
  - serial digital 41

- overlay 11

## P

- power 41
- power supply 8
- processing amplifier controls 30

## R

- rear connectors 9
- Recall Factory Defaults web page 36
- reference input impedance jumper 18
- reference inputs 11
- Refresh button 25
- remote/local jumper 18
- repair depot 45
- report enable switches 48
- Restore Upon Install function 37

## S

- SDI 11
- Slot Config web page 37
- slot memory 37
- SMPTE 259M 11, 41
- SNMP reporting
  - enabling 37
  - overview 48
- software download from web 2
- Software Update web page 39
- software updating 39
- standard recognition
  - local control 20
  - remote control 27
  - summary table 16
- Standard Selection web page 27
- status monitoring 46
- Status web page 26

- submodule 18
- switches 18
- sync timing adjustment 32

## T

- termination 11
- test mode enable
  - local control 21
  - remote controls 35
  - summary table 17
- test signal selection
  - local mode 21
  - remote control 35
  - summary table 17
- timing 32
- Timing web page 32
- troubleshooting 45

## U

- user adjustments
  - local control 20
  - remote control 30
  - summary table 16

## V

- vertical delay 32
  - local control 21
  - remote control 32
  - summary table 17
- vertical interval setup
  - local control 21
  - summary table 16
- VI (vertical interval) processing
  - local control 20
  - remote control 35
  - summary table 17
- video processing 35
- voltage specification 41

## W

- web browser
  - overview 23
- web site

*Index*

documentation [2](#)  
FAQ database [2](#)  
Grass Valley [2](#)  
software download [2](#)