

VISION

Device Controller

Machine Control Processor for iMC Master Control

User's Guide

UG0067-03

31 July 2013



A **BELDEN** BRAND

Copyright & Trademark Notice

Copyright © 2013, Miranda Technologies Partnership. All rights reserved.

Belden, Belden Sending All The Right Signals, and the Belden logo are trademarks or registered trademarks of Belden Inc. or its affiliated companies in the United States and other jurisdictions. Miranda, NVISION, and NV5100MC are trademarks or registered trademarks of Miranda Technologies Partnership. Belden Inc., Miranda Technologies Partnership, and other parties may also have trademark rights in other terms used herein.

Terms and Conditions

Please read the following terms and conditions carefully. By using NV5100MC documentation, you agree to the following terms and conditions.

Miranda Technologies Partnership (“Miranda”) hereby grants permission and license to owners of NV5100MC Routers to use their product manuals for their own internal business use. Manuals for Miranda products may not be reproduced or transmitted in any form or by any means, electronic or mechanical, including photocopying and recording, for any purpose unless specifically authorized in writing by Miranda.

A Miranda manual may have been revised to reflect changes made to the product during its manufacturing life. Thus, different versions of a manual may exist for any given product. Care should be taken to ensure that one obtains the proper manual version for a specific product serial number.

Information in this document is subject to change without notice and does not represent a commitment on the part of Miranda.

Warranty information is available in the Support section of the Miranda Web site (www.miranda.com).

Title	NV5100MC Routers User’s Guide
Part Number	UG0067-03
Revision	1.3 (28 Jun 13)

Safety Compliance



This equipment complies with the requirements of the following standards for safety of information technology equipment:

- CSA-C22.2 No. 60950-1-07 (2nd Edition)
- UL 60950-1 (2nd Edition)
- IEC 60950-1:2005 (2nd Edition)

WARNING

An appropriately listed/certified mains supply power cord must be used for the connection of the equipment to the mains voltage at either 120V~ or 240V~.

Applicable power cord certificates are listed in the [\[XREF to Power Cord Certificates appendix\]](#).

CAUTION

This equipment is meant to be installed in a restricted access location.

These servicing instructions are for use by qualified service personnel only.

To reduce the risk of electric shock, do not perform any servicing other than that contained in the operating instructions unless you are qualified to do so. Refer all servicing to qualified service personnel. Disconnect both power supply units before servicing. Servicing should be done in a static-free environment.

Battery handling

There is a danger of explosion if the battery is replaced incorrectly. Replace the battery only with the same or equivalent type recommended by the manufacturer. Dispose of used batteries according to the manufacturer's instructions. Before disposing of your Miranda equipment, please review [\[XREF to Disposal and Recycling Information\]](#).

Change History

Rev.	Date	ECO	Description	Approved
1.0	29 Nov 11	17941	Conforms to software release 7.2.0. This document started as a copy of UG0008.	D.Cox
1.1	07 Nov 12	18617	Conforms to software release 7.2.9.	D.Cox
1.2	21 Nov 12	18650	Conforms to software release 7.2.10. No significant changes.	D.Cox
1.3	28 Jun 13	TBD	Conforms to software release 7.2.11. New formatting.	D.Cox

Notice

Due to continued product development, the accuracy of the information in this document may change without notice. The information and intellectual property contained herein is confidential between Miranda and the client and remains the exclusive property of Miranda. If you find any problems in the documentation, please report them to us in writing. Miranda does not warrant that this document is error-free.

All title and copyrights as well as trade secret, patent and other proprietary rights in and to the Software Product (including but not limited to any images, photographs, animations, video, audio, music, test, and “applets” incorporated into the Software Product), the accompanying printed materials, and any copies of the Software Product, are owned by Miranda Technologies, Inc. The Software Product is protected by copyright laws and international treaty provisions. Customer shall not copy the printed materials accompanying the software product.

The software contains proprietary information of Miranda Technologies, Inc.. It is provided under a license agreement containing restrictions on use and disclosure and is also protected by copyright law. Reverse engineering of the software is prohibited.

FC FCC Statement

This equipment has been tested and found to comply with the limits for a Class A digital device, pursuant to part 15 of the FCC Rules. These limits are designed to provide reasonable protection against harmful interference when the equipment is operated in a commercial environment. This equipment generates, uses, and can radiate radio frequency energy and, if not installed and used in accordance with the instruction manual, may cause harmful interference to radio communications. Operation of this equipment in a residential area is likely to cause harmful interference in which case the user will be required to correct the interference at his own expense.

CE Declaration of Conformance (CE)

All of the equipment described in this manual has been designed to conform with the required safety and emissions standards of the European Community. Products tested and verified to meet these standards are marked as required by law with the CE mark.

When shipped into member countries of the European Community, this equipment is accompanied by authentic copies of original Declarations of Conformance on file in the Miranda GVD offices in Grass Valley, California USA.

Software License Agreement and Warranty Information

Contact Miranda for details on the software license agreement and product warranty.

Important Safeguards and Notices

This section provides important safety guidelines for operators and service personnel. Specific warnings and cautions appear throughout the manual where they apply. Please read and follow this important information, especially those instructions related to the risk of electric shock or injury to persons.

WARNING

Any instructions in this manual that require opening the equipment cover or enclosure are for use by qualified service personnel only. To reduce the risk of electric shock, do not perform any service other than that contained in the operating instructions unless you are qualified to do so.

Restriction on Hazardous Substances (RoHs)

Miranda is in compliance with EU Directive RoHS 2002/95/EC governing the restricted use of certain hazardous substances and materials in products and in our manufacturing processes.

Miranda has a substantial program in place for RoHS compliance that includes significant investment in our manufacturing process, and a migration of Miranda product electronic components and structural materials to RoHS compliance.

It is our objective at Miranda GVD to maintain compliance with all relevant environmental and product regulatory requirements. Detailed information on specific products or on the RoHS program at Miranda is available from Miranda Customer Support at

1-800-719-1900 (toll-free) or
1-530-265-1000 (outside the U.S.).

Symbols and Their Meanings



The lightning flash with arrowhead symbol within an equilateral triangle alerts the user to the presence of dangerous voltages within the product's enclosure that may be of sufficient magnitude to constitute a risk of electric shock to persons.



The exclamation point within an equilateral triangle alerts the user to the presence of important operating and maintenance/service instructions.



The Ground symbol represents a protective grounding terminal. Such a terminal must be connected to earth ground prior to making any other connections to the equipment.



The fuse symbol indicates that the fuse referenced in the text must be replaced with one having the ratings indicated.



The presence of this symbol in or on Miranda equipment means that it has been designed, tested and certified as complying with applicable Underwriter's Laboratory (USA) regulations and recommendations.



The presence of this symbol in or on Miranda equipment means that it has been designed, tested and certified as essentially complying with all applicable European Union (CE) regulations and recommendations.

General Warnings

A warning indicates a possible hazard to personnel which may cause injury or death. Observe the following general warnings when using or working on this equipment:

- Heed all warnings on the unit and in the operating instructions.
- Do not use this equipment in or near water.
- This equipment is grounded through the grounding conductor of the power cord. To avoid electrical shock, plug the power cord into a properly wired receptacle before connecting the equipment inputs or outputs.
- Route power cords and other cables so they are not likely to be damaged.
- Disconnect power before cleaning the equipment. Do not use liquid or aerosol cleaners; use only a damp cloth.
- Dangerous voltages may exist at several points in this equipment. To avoid injury, do not touch exposed connections and components while power is on.
- Do not wear rings or wristwatches when troubleshooting high current circuits such as the power supplies.

- To avoid fire hazard, use only the specified fuse(s) with the correct type number, voltage and current ratings as referenced in the appropriate locations in the service instructions or on the equipment. Always refer fuse replacements to qualified service personnel.
- To avoid explosion, do not operate this equipment in an explosive atmosphere.
- Have qualified service personnel perform safety checks after any service.

General Cautions

A caution indicates a possible hazard to equipment that could result in equipment damage. Observe the following cautions when operating or working on this equipment:

- When installing this equipment, do not attach the power cord to building surfaces.
- To prevent damage to equipment when replacing fuses, locate and correct the problem that caused the fuse to blow before re-applying power.
- Use only the specified replacement parts.
- Follow static precautions at all times when handling this equipment.
- This product should only be powered as described in the manual. To prevent equipment damage, select the proper line voltage on the power supply(ies) as described in the installation documentation.
- To prevent damage to the equipment, read the instructions in the equipment manual for proper input voltage range selection.
- Some products include a backup battery. There is a risk of explosion if the battery is replaced by a battery of an incorrect type. Dispose of batteries according to instructions.
- Products that have (1) no on/off switch and (2) use an external power supply must be installed in proximity to a main power output that is easily accessible.
- To reduce the risk of electrical shock, plug each power supply cord into a separate branch circuit having a separate service ground.

Declaration of Conformance (CE)

All of the equipment described in this manual has been designed to conform with the required safety and emissions standards of the European Community. Products tested and verified to meet these standards are marked as required by law with the CE mark.

When shipped into member countries of the European Community, this equipment is accompanied by authentic copies of original Declarations of Conformance on file in Miranda USA offices in Grass Valley, California USA.

Trademarks

Miranda is a registered trademark of Miranda Technologies, Inc.

Brand and product names mentioned in this manual may be trademarks, registered trademarks or copyrights of their respective holders. All brand and product names mentioned in this manual serve as comments or examples and are not to be understood as advertising for the products or their manufactures.

Software License Agreement and Warranty Information

Contact Miranda for details on the software license agreement and product warranty.

Important Safeguards and Notices

This section provides important safety guidelines for operators and service personnel. Specific warnings and cautions appear throughout the manual where they apply. Please read and follow this important information, especially those instructions related to the risk of electric shock or injury to persons.

WARNING

Any instructions in this manual that require opening the equipment cover or enclosure are for use by qualified service personnel only. To reduce the risk of electric shock, do not perform any service other than that contained in the operating instructions unless you are qualified to do so.

Restriction on Hazardous Substances (RoHs)

Miranda is in compliance with EU Directive RoHS 2002/95/EC governing the restricted use of certain hazardous substances and materials in products and in our manufacturing processes.

Miranda has a substantial program in place for RoHS compliance that includes significant investment in our manufacturing process, and a migration of Miranda product electronic components and structural materials to RoHS compliance.

It is our objective at Miranda GVD to maintain compliance with all relevant environmental and product regulatory requirements. Detailed information on specific products or on the RoHS program at Miranda is available from Miranda Customer Support at

1-800-719-1900 (toll-free) or
1-530-265-1000 (outside the U.S.).

Symbols and Their Meanings



The lightning flash with arrowhead symbol within an equilateral triangle alerts the user to the presence of dangerous voltages within the product's enclosure that may be of sufficient magnitude to constitute a risk of electric shock to persons.



The exclamation point within an equilateral triangle alerts the user to the presence of important operating and maintenance/service instructions.



The ground symbol represents a protective grounding terminal. Such a terminal must be connected to earth ground prior to making any other connections to the equipment.



The fuse symbol indicates that the fuse referenced in the text must be replaced with one having the ratings indicated.



The presence of this symbol in or on Miranda equipment means that it has been designed, tested and certified as complying with applicable Underwriter's Laboratory (USA) regulations and recommendations.



The presence of this symbol in or on Miranda equipment means that it has been designed, tested and certified as essentially complying with all applicable European Union (CE) regulations and recommendations.

General Warnings

A warning indicates a possible hazard to personnel which may cause injury or death. Observe the following general warnings when using or working on this equipment:

- Heed all warnings on the unit and in the operating instructions.
- Do not use this equipment in or near water.
- This equipment is grounded through the grounding conductor of the power cord. To avoid electrical shock, plug the power cord into a properly wired receptacle before connecting the equipment inputs or outputs.
- Route power cords and other cables so they are not likely to be damaged.
- Disconnect power before cleaning the equipment. Do not use liquid or aerosol cleaners; use only a damp cloth.
- Dangerous voltages may exist at several points in this equipment. To avoid injury, do not touch exposed connections and components while power is on.
- Do not wear rings or wristwatches when troubleshooting high current circuits such as the power supplies.
- To avoid fire hazard, use only the specified fuse(s) with the correct type number, voltage and current ratings as referenced in the appropriate locations in the service instructions or on the equipment. Always refer fuse replacements to qualified service personnel.
- To avoid explosion, do not operate this equipment in an explosive atmosphere.
- Have qualified service personnel perform safety checks after any service.

General Cautions

A caution indicates a possible hazard to equipment that could result in equipment damage. Observe the following cautions when operating or working on this equipment:

- When installing this equipment, do not attach the power cord to building surfaces.
- To prevent damage to equipment when replacing fuses, locate and correct the problem that caused the fuse to blow before re-applying power.
- Use only the specified replacement parts.
- Follow static precautions at all times when handling this equipment.
- This product should only be powered as described in the manual. To prevent equipment damage, select the proper line voltage on the power supply(ies) as described in the installation documentation.
- To prevent damage to the equipment, read the instructions in the equipment manual for proper input voltage range selection.
- Some products include a backup battery. There is a risk of explosion if the battery is replaced by a battery of an incorrect type. Dispose of batteries according to instructions.
- Products that have (1) no on/off switch and (2) use an external power supply must be installed in proximity to a main power output that is easily accessible.

toc

Table of Contents

1 Device Controller	1
Introduction	1
External Features	2
Front	2
Rear	2
Initial Setup	3
Entering IP and Mask	3
Set the IP address	3
Set the Ethernet Mode	3
Using the Configuration Tool	4
System	5
Logout	5
Time and Date	6
VTR Control	6
Protocol Assignment	6
Editing	7
Device Config	7
PHY Config	9
GPI	10
GPO	10
Event Monitoring	12
2 Misc	15
PC Configuration	15
Connectors	17
GPIO	17
Time Code Connector	18
Serial Ports	18
Notes	19
General	19
Saved Files	19
Under System Menu	19
Power Connection	19
Pre-Roll Delay	19
GPIO	19
Index	21
Contact Us	25

Table of Contents

1 Device Controller

Miranda offers a third-party “device controller” as an adjunct to its master control system. It is a DC21 from DNF Controls. Because it is third-party equipment, support for it is limited.

This brief guide augments the documentation from the manufacturer.

Topics

Introduction	1
External Features	2
Initial Setup	3
Using the Configuration Tool	4

Introduction

The “device controller” is a IRU device, 8.5” deep, that has 32 optically isolated inputs and 32 relay outputs (also optically isolated) and 4 serial ports.

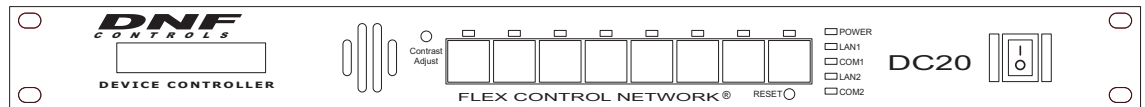

Fig. 1-1: Device Controller, Front View

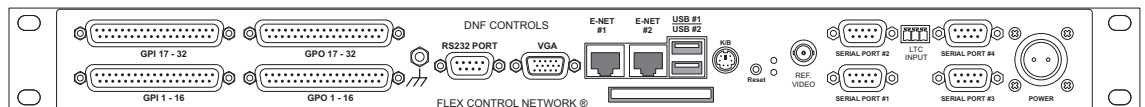

Fig. 1-2: Device Controller, Rear View

▲ The product is a DC21 even though its front panel says DC20.

The device controller receive signals from an MCE using Miranda’s NVISION Ethernet protocol (NVEP). Under master control, the DC21 sends device control messages to VTRs and other media either through its GPIO outputs or through its serial ports. A single DC21 can control up to 16 source devices using its GPIO ports and up to 4 source devices using its serial ports.

The serial ports communicate with controlled devices using a serial protocol. Protocols supported are Sony, Odetics, and VDCP.

The GPIO ports communicate with controlled devices using simple on/off switching.

Multiple device controllers can be connected together over the master control network. An MCE can address only the one device controller for which it is configured. MCEs can be configured for pre-roll and machine control independently. MCEs configured for pre-roll but not configured for machine control do not use the DC21.

The device controller itself is configurable with a small self-contained application that runs in a browser such as Internet Explorer. The objective of configuration is to define the serial ports and to set GPIO switching parameters.

External Features

Front

The unit includes, at the front, a 2×16 character display, an 8-key button pad, several LED indicators, and other items:

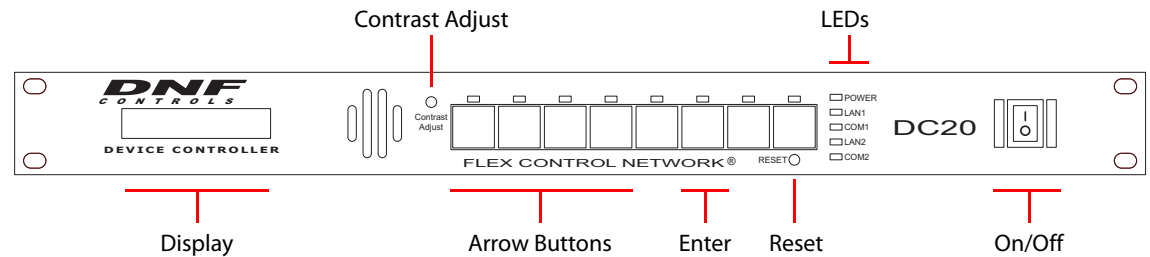

The display is for rudimentary configuration (such as setting the device's IP address) and status. The leftmost 4 buttons are up, down, left, and right arrow buttons, used for navigating the basic configuration options. Use the 'Enter' button (sixth, from the left) to commit configuration changes.

The LEDs indicate power, and the health of LANs 1 and 2 and COM ports 1 and 2.

You may ignore the recessed reset switch and contrast adjustment.

Rear

The unit includes, at the rear, GPIO, power, serial, Ethernet, and video reference connectors:

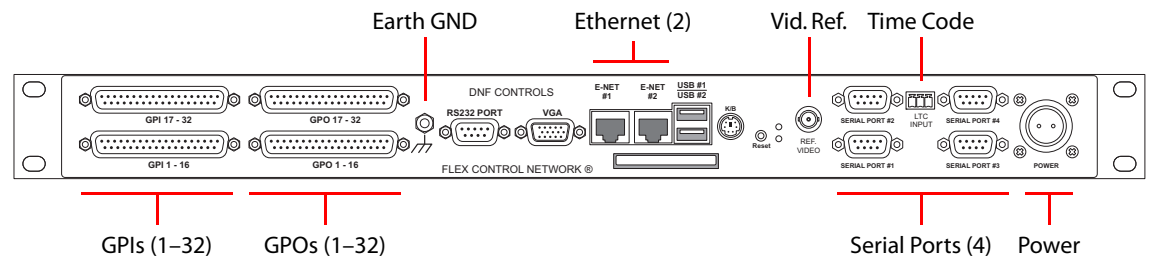

You may ignore any of the ports not identified in this illustration.

Use the GPO connectors (DC37s) to wire GPO device control connections. See [Connectors](#) on page 17 for the pinouts.

Use the Ethernet #1 connector (RJ-45) to connect the DC21 to your master control network.

Use the serial connectors (DE9s) to wire serial device control connections. The serial ports can be configured for RS-232 or RS-422 communication, but RS-422 is more widely used. See [Connectors](#) on page 17 for the pinouts.

▲ Up to 4 control panels may communicate with any one MCE.

It is recommended that you connect the ground terminal to earth ground, but not strictly necessary.

Connect your facility's video reference to the video reference connector. Connect your facility's time-code source to the LTC connector. The LTC uses a 3-pin Phoenix quick-release connector. See [Connectors](#) on page 17 for its pinout.

Initial Setup

- ▲ Caution: do **not** apply AC voltage to the power supply and then connect the power supply to the DC21. Component damage can occur.

This is the basic procedure.

- 1 Plug in the device controller at the power connection. Use the external power supply provided.
- 2 Use a CAT5 Ethernet cable to connect the device controller to the Ethernet switch servicing the master control network. Use the port labeled “E-net #1.”
- 3 Using the front panel of the device controller, enter its IP address on the master control network and verify that its mask is 255 . 255 . 255 . 0.
- 4 Cable the GPIOs (on the 4 DC37 connectors) to whatever devices you are using according to the design of your system. See [Connectors](#) on page 17 for the pinouts.
- 5 Using your configuration PC (presumed to be on the master control network already), launch your browser (e.g., Internet Explorer). Enter the IP address of the device controller as the URL:

`http://192.168.102.112` (This is just an example)

The device controller will run its self-contained configuration application in which you may configure the device controller's inputs and outputs.

Before you can configure anything, you must enter your ID and password. The default or initial ID and password are (admin, controls). You can change the ID and password.

(You can change the time and date using the 'System' option of the configuration software.)

Connect house video reference to the video reference input at the rear.

Entering IP and Mask

The front panel has a 2×16 character display and 8 function buttons.

Four of the function buttons (at the left) are arrows. The sixth button is 'Enter'. These buttons are used to navigate through the device controller's menu system.

To scroll through the list of options, press the up or down arrows until you come to an option you want to set or change.

Set the IP address

Scroll up or down so that the display shows 'Current IP1'. Press 'Enter'.

An underline cursor appears at the first digit of the IP address. Use the left and right arrows to move to a digit you want to change. Then use the up/down arrows to change the value of the digit. When you have finished, press 'Enter' once again.

- ▲ Pressing the 'Esc' button terminates the operation and leaves the value unchanged.

Do the same for the IP subnet mask. (The display should read 'Current Mask1'.) The value should be 255 . 255 . 255 . 0.

Set the Ethernet Mode

Scroll up or down so that the display shows 'Ethernet Status'. Press 'Enter'.

The display changes to 'Ethernet Config: Speed'. Choose 'auto' for most Ethernet connections. Choose '10M' for long cables, but only if you are experiencing communication failures. Press 'Enter' again to confirm your choice.

Press the 'Esc' button any time to cancel your operation.

Using the Configuration Tool

When you launch the internal DNF configuration tool in your browser, its initial screen is this:



It presents 7 options (sub-pages) listed across the top in the yellow region:

Protocol assignment	Define connections to devices controlled through the serial ports.
GPI	The GPIs are not used for master control.
GPO	Configure any or all of the 32 GPOs.
Event notification	Ignore this unless you have a USP. ^a
USP events	Ignore this unless you have a USP.
Event monitoring	You may ignore the 'Event Monitoring' table unless you want to trigger GP outputs based on certain inputs. This table is not used for master control.
System	Presents a login dialog and provides configuration options for the device controller (to which you are connected) and its software.

a. Miranda does not provide any support for the USP (Universal Switch Panel) — a separate DNF product.

Only 4 of these are of any use to master control.

Each sub-page manages a configuration table. Configuration tables can be saved and retrieved for fast setups and quick changes during broadcast or production.

Descriptions of the sub-pages follow.

System

If you are not logged in, clicking the 'System' option presents a login dialog:

logged out

Username:

Password:

The default ID is admin and the default password is control s.

- ▲ The login times out after a few minutes. After any period of non-use, you might find the configuration tool asking for your password again.

After you are logged in, the 'System' option presents a list of configuration options (where you can set your password, among other things).

Current User: admin

Current Time: July / 11 / 2009 11:20:12

Startup Time: July / 11 / 2009 10:11:58

- [Set Admin Password](#)
- [Set System Time](#)
- [Set System Label](#)
- [Set System Port Number](#)
- [Configure SNMP](#)
- [Restart the System](#)
- [Diagnostics](#)
- [System maintenance](#)
- [WTR Control](#)

- [Logout](#)

Other than password and system time, most of the items in this page are of little concern.

Logout

The logout entry on this page logs you out of the application immediately. Be careful if you do not know the password. (The default password is control s.)

Logging out prevents unauthorized persons from making changes.

Time and Date

This is the 'System Time' submenu:

Set System Time

Current Time: July / 11 / 2009 11:29:31

Year	Month	Day
<input type="text" value="2009"/>	<input type="text" value="July"/>	<input type="text" value="11"/>
Hour	Min.	Sec.
<input type="text" value="11"/>	<input type="text" value="29"/>	<input type="text" value="31"/>

Enter (or select) the values you want in the appropriate fields.

Click 'Save' to confirm your changes and return to the 'System page'. Click 'Cancel' to return to the 'System' page without saving your changes.

VTR Control

The VTR control is a Java program that interacts with a VTR (or similar device):



Use the left and right arrows to select the channel. (These include the 4 serial channels. The display does not apply to devices controlled by GPOs.)

Protocol Assignment

The device controller supports up to 4 serial channels (on the 4 serial ports). This table on this page lists the channels and defines the parameters for each channel.

The example in this illustration shows all 4 channels defined. Two use Sony protocol and the others use Odetics and VDCP:

[Edit Protocol Assignment Table](#)

Last Updated: August / 4 / 2009 14:50:03

PROTOCOL ASSIGNMENT TABLE

Channel	Physical Connector	Channel Label	Control Protocol	Control Function	List Config	Device Config	PHY Config	Event Definitions	Status
1	Serial_1	label0	sony	Basic Control	N/A	View Edit	View Edit	N/A	No Comm
2	Serial_2	label1	sony	Basic Control	N/A	View Edit	View Edit	N/A	No Comm
3	Serial_3	label2	vdcp	Basic Control	N/A	View Edit	View Edit	N/A	No Comm
4	Serial_4	label3	odet	Basic Control	N/A	View Edit	View Edit	N/A	No Comm

List of licensed protocols and functions:

Protocols: sony, menu, odet, vdcp,

Functions: Basic Control, USP, Clip Management,

[Edit Protocol Assignment Table](#)

You can edit the table, but you cannot add or delete items. Of the entries in the table, 'PHY Config' and 'Device Config' are the most important.

The Status column varies depending on the state of the connected device.

The 'List Config' column is not used. The 'Event Definitions' column is not used.

Editing

Click 'Edit Protocol Assignment Table' to make changes:

PROTOCOL ASSIGNMENT TABLE

Channel#	Physical Connector	Channel Label	Currently Licensed Control Protocol
1	<input type="text" value="Serial_1"/>	<input type="text" value="label0"/>	<input type="text" value="sony"/>
2	<input type="text" value="Serial_2"/>	<input type="text" value="label1"/>	<input type="text" value="sony"/>
3	<input type="text" value="Serial_3"/>	<input type="text" value="label2"/>	<input type="text" value="vdcp"/>
4	<input type="text" value="Serial_4"/>	<input type="text" value="label3"/>	<input type="text" value="vdcp"/>

Select a protocol in a 'Control Protocol' field to enable the channel. The choices are 'Sony', 'Odetics', and 'VDCP'.

Choose one of the serial connectors in the 'Physical Connector' field.

Assign a label to the channel. This is not essential, but useful.

Click 'Save' to confirm your entries and return to the 'Protocol Assignment' page. Click 'Cancel' to return to the 'Protocol Assignment' page without saving your changes.

Device Config

The 'Protocol Assignment page has are two 'Device Config' options: view or edit. These options are not available for undefined channels. The tables differ according to the protocol for the device.

Device Controller
Using the Configuration Tool

• Sony — View

VTR-Like Device Configuration Table

Channel#	Channel Label	Control Protocol	Control Function	Device Internal Latency (HH:MM:SS:FF)	Preroll Delay (HH:MM:SS:FF)	Time Base	TSO PLUS	TSO MINUS
1	label0	sony	Basic Control	00:00:00:05	00:00:03:00	DF	10	10

Done

• Sony — Edit

PROTOCOL ASSIGNMENT TABLE

Ch	Channel Label	Control Protocol	Control Function	Device Internal Latency	Preroll Delay	TSO PLUS	TSO MINUS
1	label0	sony	Basic Control	hour min sec frame 00 00 00 05	hour min sec frame 00 00 03 00	% of PLAY 10	% of PLAY 10

Save Done

• Odetics — View

VTR-Like Device Configuration Table

Channel#	Channel Label	Control Protocol	Control Function	Device Internal Latency (HH:MM:SS:FF)	Preroll Delay (HH:MM:SS:FF)	Time Base	TSO PLUS	TSO MINUS
4	label3	odet	Basic Control	00:00:00:08	00:00:00:00	DF	10	10

Done

• Odetics — Edit

Ch	Channel Label	Control Protocol	Control Function	Device Internal Latency	Preroll Delay	TSO PLUS	TSO MINUS
4	label3	odet	Basic Control	hour min sec frame 00 00 00 08	hour min sec frame 00 00 00 00	% of PLAY 10	% of PLAY 10

Save Done

• VDCP — View

VTR-Like Device Configuration Table

Channel#	Channel Label	Control Protocol	Control Function	Device Internal Latency (HH:MM:SS:FF)	Preroll Delay (HH:MM:SS:FF)	Time Base	TSO PLUS	TSO MINUS	VDCP Port	Extended IDs
3	label2	vdcp	Basic Control	00:00:00:05 OFF	00:00:00:00	DF	10	10	Port#0 OUTPUT	OFF

Done

- VPCP — Edit

PROTOCOL ASSIGNMENT TABLE

Ch	Channel Label	Control Protocol	Control Function	Device Internal Latency				Preroll Delay				VDCP Port	Extended IDs	Time Base	TSO PLUS	TSO MINUS	
3	label2	vdcp	Basic Control	hour	min	sec	frame	hour	min	sec	frame	0	OUTPUT	<input type="checkbox"/> Use Extended Clip IDs	DF	% of PLAY 10	% of PLAY 10
													<input type="checkbox"/> Close Port				

Save Done

Device Internal Latency

Master control is very much concerned with 'Device Internal Latency'. In any of these tables, you must ignore 'Preroll Delay' here because pre-roll delay is handled by master control internals.

Device latency is typically 4–10 frames. You will have to determine the device latency for each of your devices by experimentation.

- ▲ If you change the 'Device Internal Latency' value, it is then necessary to reboot the DC21 to inform the MCE of the new value. Also, whenever the DC21 is rebooted, all attached VTRs must be powered on or the DNF box will not report this latency value to the MCE!

Pre-Roll Delay

Always set all values in this column to 0. Pre-roll delay is handled in MasterConfig.

Time Base

The choices are DF (drop frame), NTSC, and PAL.

VDCP Port

This field identifies a port within the device under control.

TSO

TSO means "tape speed override." You can potentially enter a value up to $\pm 25\%$. However, TSO is not used in master control. You should use the default values.

Click 'Save' to confirm your entries. Click 'Done' to save your entries and return to the 'Protocol Assignment' page.

PHY Config

The 'Protocol Assignment page has are two 'PHY Config' options: view or edit. The options are not available for unassigned channels.

Click 'View' for the channel if you want only to examine its parameters

Done

Serial PHY Configuration

Channel	Baud Rate	Stop Bit	Parity	Char Size	Operation Mode	Interface Type
1	38400	1	ODD	8	CONTROLLER	RS422

Done

Click 'Edit' for a channel if you want to change its parameters

Serial PHY Configuration

Channel	Baud Rate	Stop Bit	Parity	Char Size	Operation Mode	Interface Type
1	38400	1	ODD	8	CONTROLLER	RS422

Choose the appropriate Baud rate and bit pattern for the device controlled by this channel. Typical values, and especially for Sony and Odetics protocols, are 38400 Baud, 1 stop bit, 8 data bits, and odd parity. RS-422 is the more common serial mode.

Choose 'Controller' in the 'Operation Mode' field.

Click 'Save' to confirm your entries. Click 'Done' to save your entries and return to the 'Protocol Assignment' page.

GPI

The DC21's GPIs are not used for master control.

GPO

The device controller's GPO option presents a table of 32 GPIOs (outputs):

[Edit](#) / [Backup](#) / [Restore](#) / [Create Default](#) / GPO Configuration Table

GPO CONFIGURATION TABLE

GPO#	Label	Current State	User Defined "ON" State	User Defined "ON" Mode	On time (*10 ms)	Transition Delay (*10 ms)	Debounce Time (*16 ms)
1	GPO_1	OFF	Relay Closed	Latched	0	0	1
2	GPO_2	OFF	Relay Closed	Latched	0	0	1
3	GPO_3	OFF	Relay Closed	Latched	0	0	1
4	GPO_4	OFF	Relay Closed	Latched	0	0	1
5	GPO_5	OFF	Relay Closed	Latched	0	0	1
6	GPO_6	OFF	Relay Closed	Latched	0	0	1
7	GPO_7	OFF	Relay Closed	Latched	0	0	1
8	GPO_8	OFF	Relay Closed	Latched	0	0	1
9	GPO_9	OFF	Relay Closed	Latched	0	0	1
10	GPO_10	OFF	Relay Closed	Latched	0	0	1
11	GPO_11	OFF	Relay Closed	Latched	0	0	1
12	GPO_12	OFF	Relay Closed	Latched	0	0	1
13	GPO_13	OFF	Relay Closed	Latched	0	0	1
14	GPO_14	OFF	Relay Closed	Latched	0	0	1
15	GPO_15	OFF	Relay Closed	Latched	0	0	1
16	GPO_16	OFF	Relay Closed	Latched	0	0	1
17	GPO_17	OFF	Relay Closed	Latched	0	0	1
18	GPO_18	OFF	Relay Closed	Latched	0	0	1
19	GPO_19	OFF	Relay Closed	Latched	0	0	1
20	GPO_20	OFF	Relay Closed	Latched	0	0	1
21	GPO_21	OFF	Relay Closed	Latched	0	0	1
22	GPO_22	OFF	Relay Closed	Latched	0	0	1
23	GPO_23	OFF	Relay Closed	Latched	0	0	1
24	GPO_24	OFF	Relay Closed	Latched	0	0	1
25	GPO_25	OFF	Relay Closed	Latched	0	0	1
26	GPO_26	OFF	Relay Closed	Latched	0	0	1
27	GPO_27	OFF	Relay Closed	Latched	0	0	1
28	GPO_28	OFF	Relay Closed	Latched	0	0	1
29	GPO_29	OFF	Relay Closed	Latched	0	0	1
30	GPO_30	OFF	Relay Closed	Latched	0	0	1
31	GPO_31	OFF	Relay Closed	Latched	0	0	1
32	GPO_32	OFF	Relay Closed	Latched	0	0	1

You cannot add or delete outputs, but you can edit them. The other options at the top of the page include:

- Backup Save your GPO configuration to a file (on your PC).
- Restore Retrieve the GPO configuration from a saved file.
- Create Default Reinitializes the device controller's GPOs to a default configuration. (You'll get a warning "Are you sure.")

Edit options

(See the diagram next page.)

- ON State 'Relay Closed' means that the output state is considered "on" when NO and COM are connected. 'Relay Open' means that it is "on" when NO and COM are **not** connected. (There is no NC position.)
See [Connectors](#) on page 17 for the connector pinouts.
- Mode Switching options are *latched* and *momentary*. Normal GPOs are latched. A momentary GPO produces a pulse. A 100 ms pulse is generally suitable for performing VTR control.
The MCE sends a pulse of 3 video frames (about 100 ms). To support the MCE's pulse, choose "latched." If you choose "momentary," you can set a different pulse width. We recommend that you choose "latched."
- On Time "On time" applies to momentary GPOs and is expressed in multiples of 10 ms.
- Transition Delay The amount of time from the triggering event to the change of the relay state. The transition delay is expressed in multiples of 10 ms.
- Debounce Debounce options are expressed in multiples of 16 ms (not 10 ms). A "1" means 10 ms; a "2" means 20 ms, and so on.

Save Cancel

GPO CONFIGURATION TABLE

GPO#	Label	GPO CURRENT STATE	Configuration				
			User Defined "ON" State	User Defined "ON" Mode	On Time (*10 ms)	Transition Delay (*10 ms)	Debounce Time (*16 ms)
1	GPO_1	OFF	Relay Closed	Latched	0	0	1
2	GPO_2	OFF	Relay Closed	Latched	0	0	1
3	GPO_3	OFF	Relay Closed	Latched	0	0	1
4	GPO_4	OFF	Relay Closed	Latched	0	0	1
5	GPO_5	OFF	Relay Closed	Latched	0	0	1
6	GPO_6	OFF	Relay Closed	Latched	0	0	1
7	GPO_7	OFF	Relay Closed	Latched	0	0	1
8	GPO_8	OFF	Relay Closed	Latched	0	0	1

The 'Current State' column tells you the logical state of the outputs (at the time of sampling).

Labels are useful, but not essential.

You must click the 'Refresh' button to resample the outputs.

The maximum for any of the time fields is 255.

Event Monitoring

The 'Event Monitoring' table defines the effects of events. Events include (1) GPI state changes and (2) serial channel events. This is a list of serial channel events:

Cue	Ffwd	Loaded	Pause	Play
Record	Rwd	Shut fwd	Shut rev	Stop

These event types apply to each of the DC21's 4 serial channels.

The *effects* can be either GPO changes (on, off, or toggle) or channel state changes. These are the channel changes supported by the DC21:

Play	Pause	Ffwd	Cue to 'in'	Slomo 25 Fwd	Slomo 50 Fwd
Stop	Recue	Rwd	Play rev	Slomo 25 Rev	Slomo 50 Rev

Again, they apply to each of the 4 serial channels. Note that master control does **not** use "slomo." Each row in the event table couples one event (GPI or channel event) to one effect (GPO or channel state change).

▲ There is no combinational logic (as there is in the tally processor).

For each event monitored, the table specifies what to do and which GPO to trigger (and whether to trigger it) when the event occurs.

When you add an event to this table, you define the label (a unique ID) for the event.

[Add / Edit / Delete / Backup / Restore](#) Channel Event
[Create Default Event Monitor Table](#)
Currently used file is not a restored file.

Last Refreshed: August / 7 / 2009 09:38:04

EVENT MONITORING TABLE

Status	Source IP	Connection Status	Event Label	Event Status	Frequency	GPO Label	ON Function	OFF Function
Enabled	0.0.0.0	Local	CH_1_RECORD	OFF	Repetitive	GPO_14	Turn On GPO	Turn Off GPO
Enabled	0.0.0.0	Local	GPI_27	OFF	Repetitive	GPO_13	Turn On GPO	Turn Off GPO

[Add / Edit / Delete / Backup / Restore](#) Channel Event
[Create Default Event Monitor Table](#)

An event is considered ON when its underlying definition evaluates ON. It is OFF, otherwise.

▲ *Pending* events do not result in any action.

In most cases, you do **not** want to configure any events at all—especially not those that cause changes to the state of controlled devices. That will interfere with master control operations.

However, if you have spare GPOs and want to use them, the event monitoring table can be useful.

Adding Events

An event dialog appears when you choose 'Add' (above or below the table).

Add Event to Channel Event Monitoring

Status	Enabled ▾
Source IP	0.0.0.0
Source Event Type	LOCAL EVENT ▾
Source Event Label	27: GPI_27 ▾
Frequency	Repetitive ▾
ON Function	Turn On GPO ▾
OFF Function	Turn Off GPO ▾
GPO Label	GPO_13 ▾

An event may be local or remote. If it is remote, enter the IP address of the remote device controller and the remote label for the event. If it is local, the label drop-down list will be filled with a number of options which include GPIs and serial port events.

An event may be classified as *repetitive* or *single*. *Repetitive* means that the input can be sampled whenever it occurs. *Single* means that the input is monitored until it goes on and thereafter it is not monitored.

- ▲ Some of the inputs that the device controller monitors to decide whether an event occurs come through the LAN, via NVEP, from the master control system.
- ▲ Duplicate entries overwrite older entries.

Choose whether the event monitoring is *repetitive* or *single*.

Choose the ON function and the OFF function. Some of the ON and OFF functions turn a GPO on or OFF. An event in the list always involves one of the GPOs, but it is meaningful only if the function is to turn the GPO on or off. The function 'Do Nothing' is available if you do not want to switch a GPO.

Editing

Click 'Edit' above or below the event monitoring table to edit one or more rows of the event table.

2 Misc.

Chapter 2 provides miscellaneous information about the device controller.

Topics

PC Configuration	15
Connectors	17
Notes	19

PC Configuration

You (or your system administrator) must connect the PC on which your software runs to the master control network. To do that, you must assign the PC an IP address (and mask) on the NIC that connects the PC to the master control network. (The PC must also be connected to the Ethernet switch of the network.)

Follow these steps to set the IP address of your PC:

- 1 Launch 'Settings > Network Configuration' from you PC's Start menu. The following window appears:

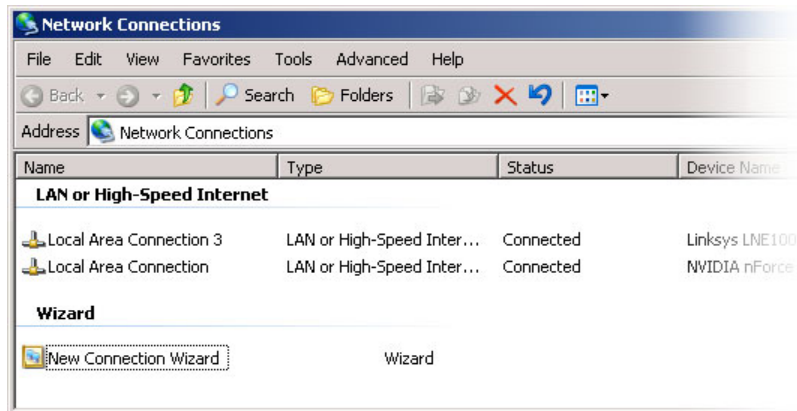

- 2 Double-click the appropriate 'Local Area Connection' for your master control network. Then, choose the General tab and click 'Properties'.

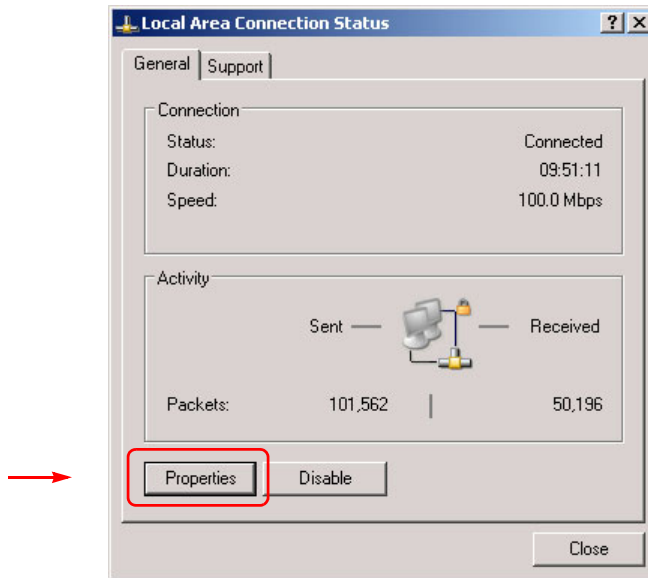

- 3 Select Internet Protocol (TCP/IP). Click 'Properties' again here:

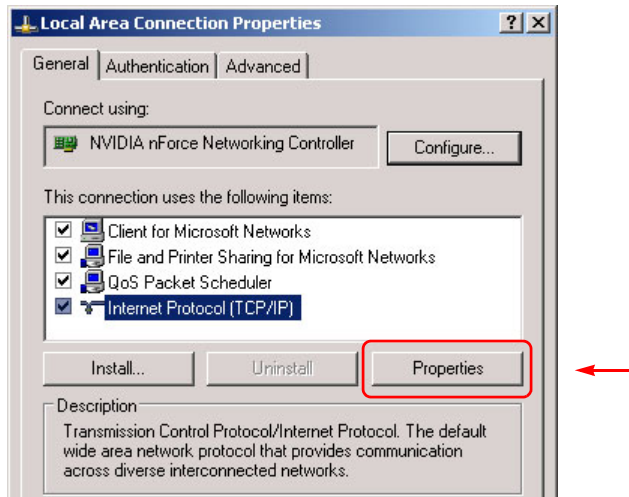

- 4 Select 'Use the following IP address' and enter an IP address for your PC. Use the default subnet mask.

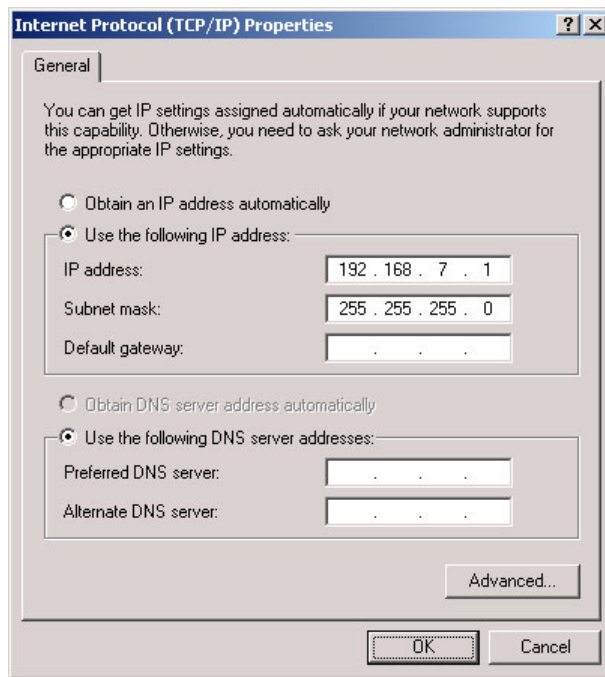

The IP address must be unique on the network. (The subnet mask must be 255.255.255.0.)

- 5 Click OK and it is done. Close all the Network Connections windows.

Connectors

GPIO

There are two GPI connectors (inputs 1–16 and inputs 17–32) and there are two GPO connectors (outputs 1–16 and outputs 17–32). These illustrations show the pin-out:

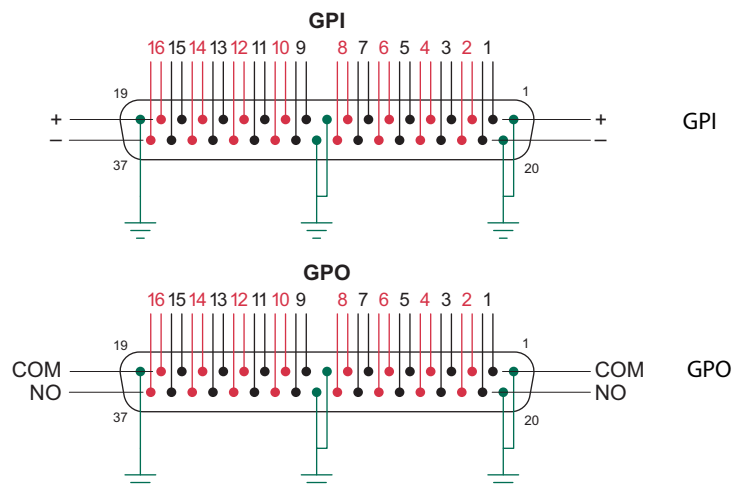

The input and output ranges 17–32 follow the same pattern.

GPI limits:

5VDC–12VDC (or 24VDC with a resistor of 680 to 820 ohms).
20mA maximum current.

GPO limits:

0.5 A at 125 VAC.
1.0 A at 24VDC.
1.0 A maximum current.

Time Code Connector

LTC is not required for master control. You do not need any connection to this port.
Nevertheless, this is the pinout of the LTC port:

Pin	Balanced	Unbalanced
1	LTC High	LTC High
2	LTC Low	Tie to pin 3
3	Common or shield	Shield

Serial Ports

Each of the 4 serial ports has this pinout. The DC21 supports RS-422 or RS-232:

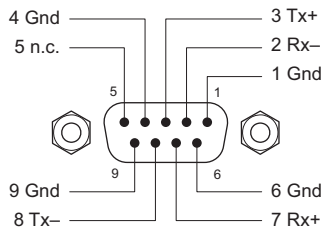

This is the section of the DC21 that has the serial ports (and LTC connector):

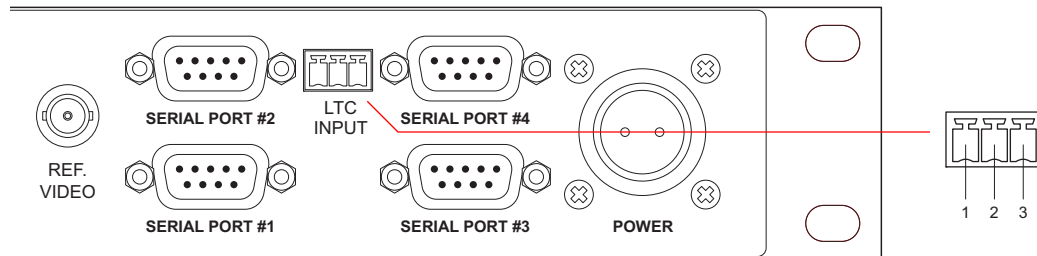

Notes

Although there are 2 Ethernet ports, only one — “E-net #1” — is usable.

General

To commit changes to the device controller, you'll usually want to click a 'Save' button or similar function.

‘Save & Edit’ — save added entry and go back to the table.

‘Save & Add’ — save added entry and remain in the add box to continue to add.

Sometimes changes you make are accepted without your explicitly saving anything.

You can often cancel a change by clicking a 'Cancel' or 'Back' button.

Heed all warnings.

Saved Files

Although you are well-advised to save your configuration files, restoring configuration files can take a while. You shouldn't assume a restore has failed — do not interrupt the restore!

Under System Menu

Do not place the device controller in router emulation mode.

'VTR Control' under the 'System' menu might be useful, but it is unsupported.

Power Connection

Make the connection between the power supply and the DC21 **before** you connect the power supply to AC power. Doing so can damage the DC21's circuitry.

Pre-Roll Delay

The pre-roll delay (on the Protocol Assignment page) is to be ignored. Master control handles pre-roll delay internally.

GPIO

The DC21's GPIO channels were not intended for machine control. An MCE can, however, make use of them for machine control. It uses adjacent pairs of GPOs (outputs). The odd-numbered member of a pair is used to “start” a device and the even-numbered member of the pair is used to “stop” a device.

An MCE can therefore support 16 devices using GPO machine control.

Index

A

Adding events	13
Address, IP	15, 17
Africa, contact	25
agreement, license	iv, viii
Americas, contact	25
Arrow buttons	2–3
Asia, contact	25

B

Back button	19
Button pad	2–3

C

Cancel button	19
cautions	vii, x
CE	iv, vii
change history	iii
Channels	6
Chapters	
1, Introduction	1
2, Misc.	15
China, contact	25
Configuration application	1, 3–4
Configuration PC	15
Configuration tables	5
Connectors	2, 17
contact Miranda	25
Controller, device (DC21)	1, 12
corporate office, contact	25
Cue	12
Cue to 'in'	12
Current IP1	3
Current Mask1	3
customer support	25

D

Date and time	6
DC21 device controller	1, 12
DC37 connectors	2–3

DE9 connectors	2
Debounce	11
Declaration of Conformance	iv, vii
Default password	5
Default user ID	5
Device Config	7
Device controller (DC21)	1, 12
Device internal latency	9
DNF Controls	1
document	
notice of use	iv
revision	iii

E

e-mail address	25
Enter button	2–3
Esc button	3
Ethernet connectors	2
Ethernet Status	3
Europe, contact	25
Event monitoring (page)	4, 12
Events, adding	13

F

fax number	25
FCC statement	iv
Ffwd	12
France, contact	25

G

GPI (page)	4, 10
GPI connectors	17
GPO (page)	4, 10
GPO connectors	17
GPO mode	11
GPO state	11

H

hardware symbolsvi, ix
------------------------	---------

hazardous substance v, viii
 hours of operation 25

I

ID 5
 Inputs, optically isolated 1
 Internet Protocol (TCP/IP) 16
 Introduction 1
 IP address 2-3, 13, 15, 17
 IP subnet mask 3

L

Latched (option) 11
 LCD, 2x16 2-3
 LEDs 2
 license iv, viii
 Loaded 12
 Local Area Connection 16
 Local events 13
 Login ID 5
 Login password 5
 Logout 5

M

MCEs 1-2
 Middle East, contact 25
 Miranda, contact 25
 Momentary (option) 11

N

Network Configuration 15
 Network Connections 17
 Notes 19
 notice, use iv
 NVEP 1, 13
 NVISION Ethernet protocol
 see NVEP

O

Odetics 1, 7
 office hours 25
 On time 11
 Outputs, relay 1

P

Password 5
 Pause 12
 PC Configuration 15
 phone numbers 25
 PHY Config 7, 9
 Play 12
 Play rev 12
 Ports, serial 1, 6
 Protocol assignment (page) 4, 6
 Protocols, serial 1, 7

R

Record 12
 Recue 12
 Refresh button 11
 Relay outputs 1
 Remote events 13
 Repetitive (option) 13
 restrictions v, viii
 revision, document iii
 RJ-45 connectors 2
 RoHS v, viii
 Rwd 12

S

safeguards v, viii
 safety notices v, viii
 Save & add button 19
 Save & edit button 19
 Serial ports 1, 6
 Serial protocols 1, 7
 Settings, Windows 15
 Shut fwd 12
 Shut rev 12
 Single (option) 13
 software license iv, viii
 Sony 1, 7
 Stop 12
 Sub-pages, configuration application 4
 support, contact 25
 symbols, meaning vi, ix
 System (page) 4-6, 19
 System option 3

T

Tables 5, 12
 technical support 25

Time and date 6
Time-out 5
trademarks vii
Transition delay 11

U

United Kingdom, contact 25

V

VDCP1, 7

W

warnings, hardwarevi, ix
warranty iv, viii
web site25
Windows, settings15



Miranda Technical Support

For technical assistance, please contact the Miranda Technical Support center nearest you:

Americas

Office hours: 9:00 a.m. – 9:00 p.m. (EST)
Telephone: +1-800-224-7882
Fax: +1-514-335-1614
E-mail: support@miranda.com

Asia

Office hours: 9:00 a.m. – 5:00 p.m. (GMT+8)
Telephone: +852 2539 6987
Fax: +852 2539 0804
E-mail: asiotech@miranda.com

Europe, Middle East, Africa, UK

Office hours: 9:00 a.m. – 6:00 p.m. (GMT)
Telephone: +44 118 952 3444
Fax: +44 118 952 3401
E-mail: eurotech@miranda.com

China

Telephone: +86 10 5873 1814
E-mail: asiotech@miranda.com

France

Office hours: 9:00 a.m. – 5:00 p.m. (GMT+1)
Telephone: +33 1 55 86 87 88
Fax: +33 1 55 86 00 29
E-mail: eurotech@miranda.com

EMERGENCY after hours (global)

Toll free: 1-800-224-7882 (US and Canada)
Telephone: +1 514 333 1772

Corporate Head Office

Miranda Technologies
3499 Douglas-B.-Floreani, St-Laurent, Quebec, Canada H4S 2C6
Telephone: +1 514-333-1772
Fax: +1 514-333-9828
Web: www.miranda.com



A **BELDEN** BRAND