

2010RDA-16

AES/EBU DIGITAL AUDIO RECLOCKING DA

Instruction Manual

SOFTWARE VERSION 1.0.1

071826800
NOVEMBER 2003

the most watched worldwide

Contacting Grass Valley

Region	Voice	Fax	Address	Web Site
North America	(800) 547-8949 Support: 530-478-4148	Sales: (530) 478-3347 Support: (530) 478-3181	Grass Valley P.O. Box 599000 Nevada City, CA 95959-7900 USA	www.thomsongrassvalley.com
Pacific Operations	+852-2585-6688 Support: 852-2585-6579	+852-2802-2996		
U.K., Asia, Middle East	+44 1753 218 777	+44 1753 218 757		
France	+33 1 45 29 73 00			
Germany, Europe	+49 6150 104 782	+49 6150 104 223		

Copyright © Thomson Broadcast and Media Solutions All rights reserved.

Grass Valley Web Site

The www.thomsongrassvalley.com web site offers the following:

Online User Documentation — Current versions of product catalogs, brochures, data sheets, ordering guides, planning guides, manuals, and release notes in .pdf format can be downloaded.

FAQ Database — Solutions to problems and troubleshooting efforts can be found by searching our Frequently Asked Questions (FAQ) database.

Software Downloads — Software updates, drivers, and patches can be downloaded.

Contents

- Preface**..... 5
 - About This Manual 5
 - Introduction 7
 - Installation 8
 - Local Onboard Module Configuration..... 8
 - Module Placement in the Kameleon 2000 Frame 9
 - Cabling 12
 - 2010RDA-16 COAX Passive Rear Module 12
 - Power Up 14
 - Operation Indicator LEDs 14
 - Remote Monitoring 16
 - 2010RDA-16 Links and Web Pages..... 17
 - Status Page 18
 - Input Status Output Mode Page 19
 - Slot Config Page..... 20
 - Software Update Page..... 22
 - Control Panel Monitoring 22
 - Specifications 23
 - Service..... 24
 - Functional Description..... 25
 - AES Receivers..... 25
 - Routing and Control FPGA 26
 - Controller 26
 - Power Supply..... 26

- Index** 27

Preface

About This Manual

This manual describes the features of a specific 2000 Series module in the Kameleon Media Processing System. As part of this module family, it is subject to Safety and Regulatory Compliance described in the 2000 Series frame and power supply documentation (see the *2000 Series Frames Instruction Manual*).

2010RDA-16 AES/EBU Digital Audio Reclocking DA

Introduction

The 2010RDA-16 is a single or dual operation 75 Ω unbalanced AES/EBU digital audio reclocking distribution amplifier. The 2010RDA-16 is configured with an on-board jumper to provide a single input with sixteen outputs or as a dual, two input, eight output DA providing two distinct distribution amplifiers on a single card. Reclocking provides jitter reduction at a variety of sample rates for the most demanding AES/EBU requirements.

The 2010RDA-16 modules feature:

- Unbalanced digital audio SMPTE 276M,
- 75 Ω unbalanced input/output I/O,
- Single mode with one input and 16 outputs,
- Dual mode with two inputs, each with eight outputs,
- Auto-detect data reclocking at sample rates of 32, 44.1, 48 or 96 kHz,
- Housed in the Kameleon frame with other 2000 series audio and video modules,
- Remote control via Ethernet frame interface with web browser GUI or Newton control panel, and
- Loss of signal detection and SNMP reporting.

Installation

Installation of the 2010RDA-16 module is a process of:

- Configuring the module for Single or Dual operation with an on-board jumper, JP5,
- Placing the passive rear module in a rear frame slot,
- Placing the media module in the corresponding front slot, and
- Cabling and terminating signal ports.

The 2010RDA-16 module can be plugged in and removed from a Kameleon 2000 Series frame with power on. When power is applied to the module, LED indicators reflect the initialization process (see [Power Up](#) on page 14).

Local Onboard Module Configuration

The 2010RDA-16 module is configured locally for Single or Dual operation using the jumper shown in [Figure 1](#).

Figure 1. Module Configuration Switches and LEDs

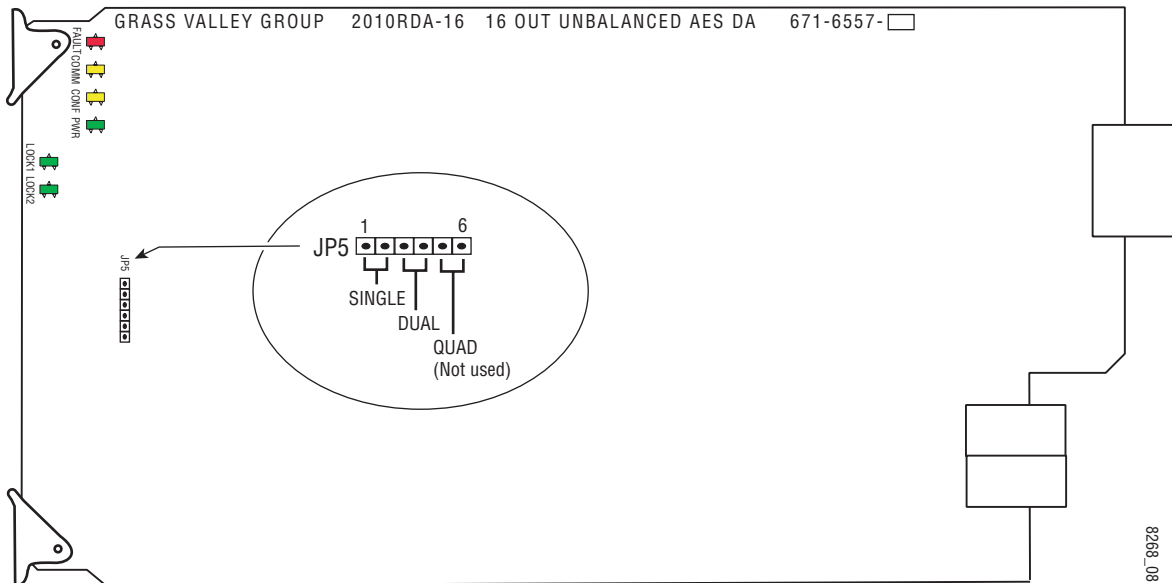

Set jumper JP5 for one of the following operating modes:

Single (pins 1/2)

- 1 input by 16 outputs

Dual (pins 3/4)

- 2 inputs by 8 outputs each

Module Placement in the Kameleon 2000 Frame

There are twelve slot locations in both the front and rear of a Kameleon 3 RU frame to accommodate 2000 Series modules. The 2010RDA-16 module set consists of a front media module and a passive rear module that require two module slots.

Each 2010RDA-16 front media module plugs into the front of the 2000 frame mid-plane. The passive rear module plugs into the corresponding rear slot to provide the input and output interface connectors. Stacked BNCs on the passive rear module require two rear slots. A frame fully stuffed with 2010RDA-16 front and rear modules will accommodate up to six module sets as shown in [Figure 2](#).

To install a 2010RDA-16 module set in the frame:

1. Locate a vacant slot in slot 2, 4, 6, 8, 10, or 12 of the rear of the 3 RU frame ([Figure 2](#)). The passive rear module uses two slots.

Figure 2. 3 RU Frame, Rear View

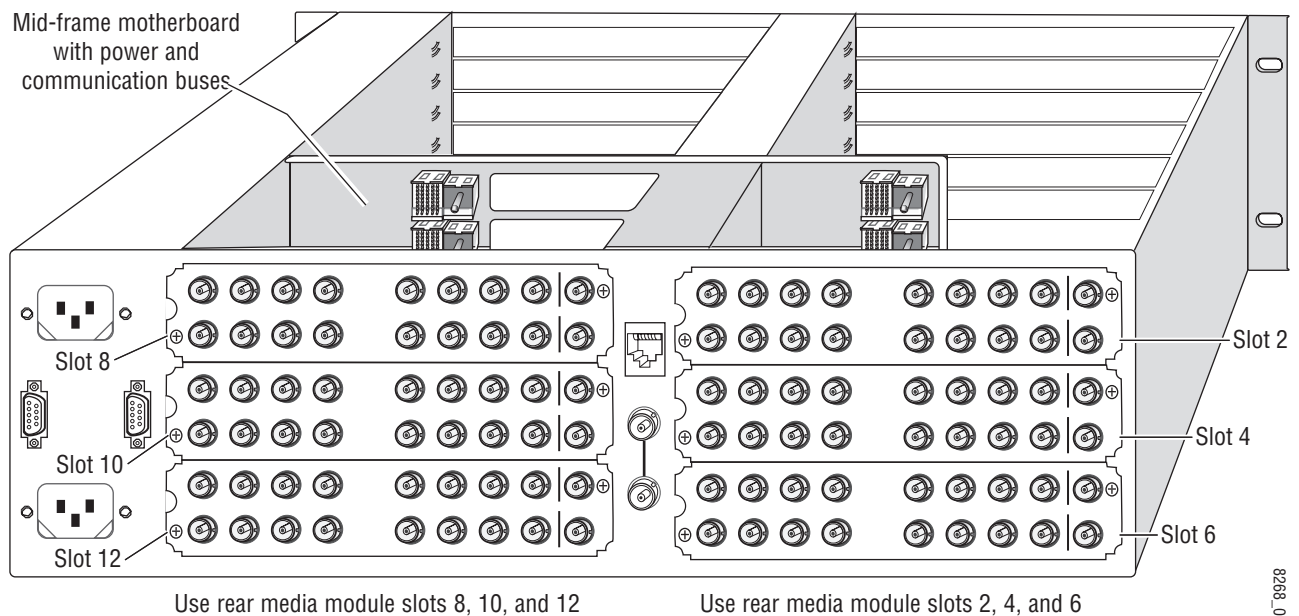

2. Insert the passive rear module into vacant rear slot 2, 4, 6, 8, 10, or 12 of the frame as illustrated in Figure 3.

Figure 3. Installing Passive Rear Module

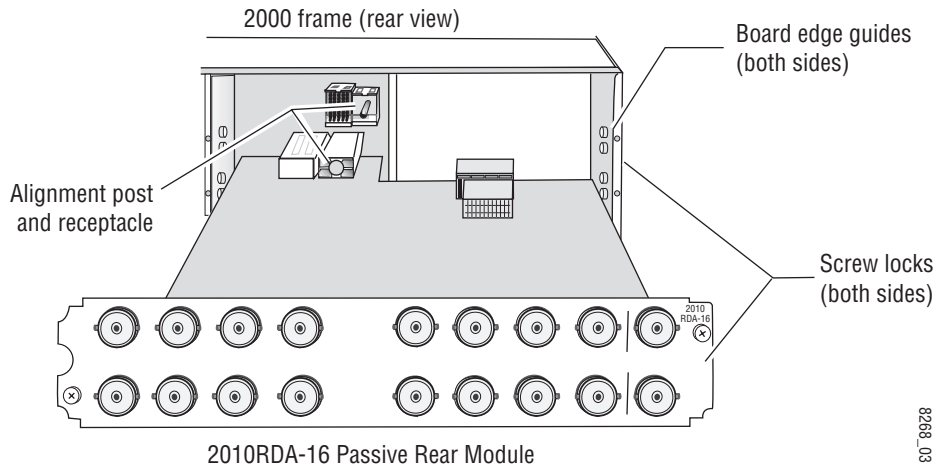

3. Verify that the module connector seats properly against the midplane.
4. Using a crossblade screwdriver, tighten the four screw locks to secure the module in the frame.
5. Locate the front slot 2, 4, 6, 8, 10, or 12 in the frame corresponding to the rear module circuit board. The 3 RU frame front view is illustrated in Figure 4. Module slots for the 2010RDA-16 are highlighted in gray.

Figure 4. 2000 Series 3 RU Frame, Front Slots

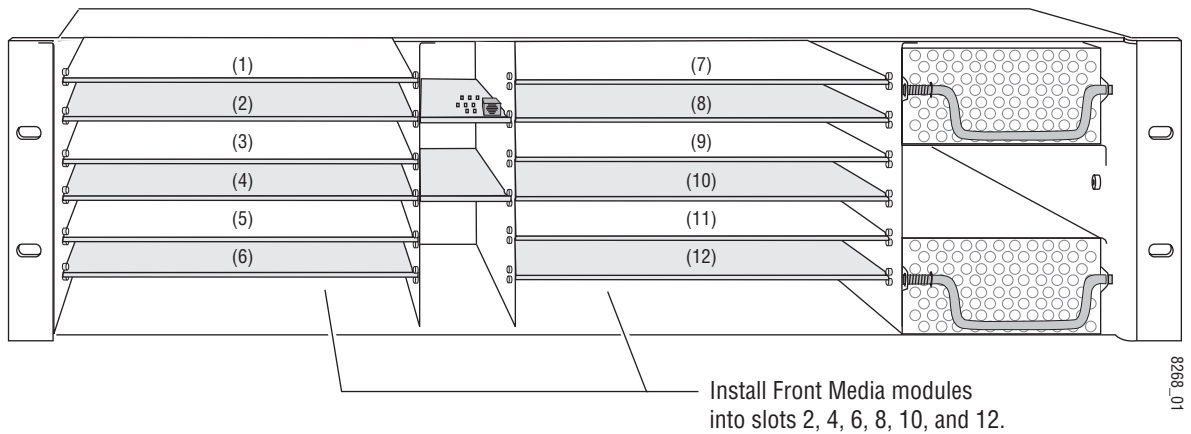

6. With the component side up, insert the front media module in the corresponding front slot (see [Figure 5](#)).
7. Verify that the module connector seats properly against the midplane and rear module connector.
8. Press firmly on both ejector tabs to seat the module.

Figure 5. Installing Front Media Module

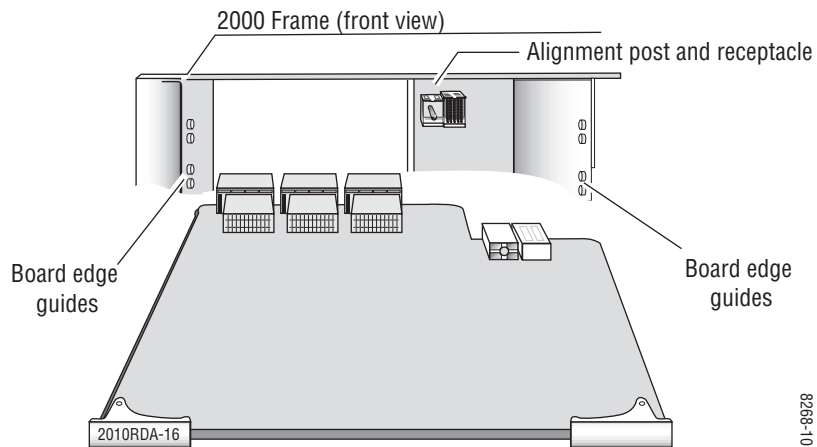

Cabling

All cabling to the modules is done on the corresponding passive rear module (PRM) at the back of the 2000 frame. The passive rear modules for the 2010RDA-16 is a COAX PRM with 75 Ω BNC I/O.

Refer to the instructions that follow for cabling the COAX passive rear module for single or dual mode.

2010RDA-16 COAX Passive Rear Module

The 2010RDA-16 passive rear module provides eighteen 75 Ω (unbalanced) BNC connectors for single or dual operation. Refer to [Figure 6](#) for an illustration of the 2010RDA-16 passive rear module.

The module must be jumpered during configuration for the desired mode of operation. Refer to [Local Onboard Module Configuration](#) on page 8.

Figure 6. COAX Passive Rear Module

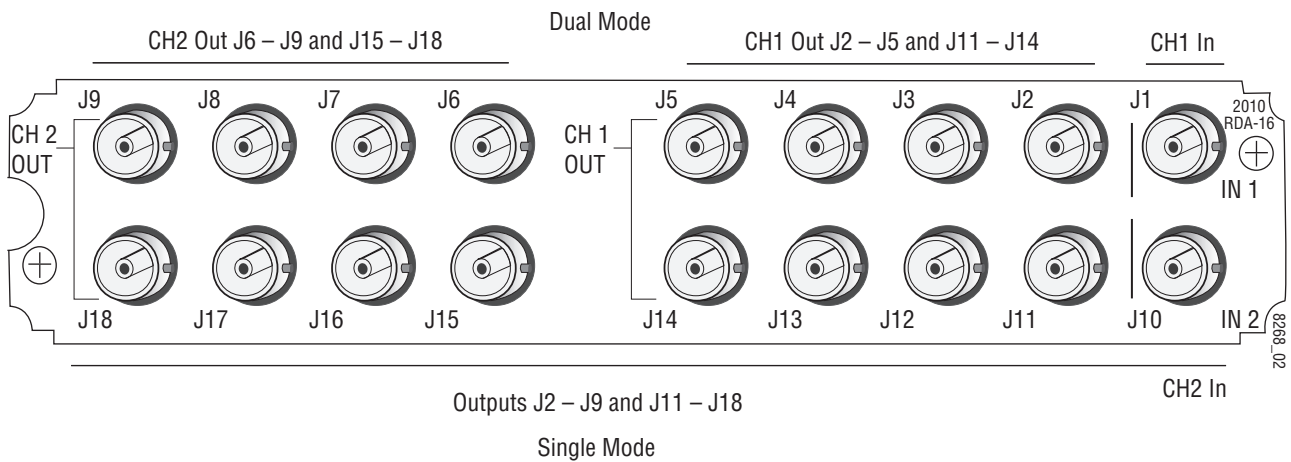

Refer to [Table 1](#) for single and dual channel cabling.

Table 1. COAX PRM Cabling BNCs

Connector	Single Mode	Dual Mode
J1	Ch 1 In	Ch 1 In
J2	Ch 1 Out 1	Ch 1 Out 1
J3	Ch 1 Out 2	Ch 1 Out 2
J4	Ch 1 Out 3	Ch 1 Out 3
J5	Ch 1 Out 4	Ch 1 Out 4
J6	Ch 1 Out 5	Ch 2 Out 1
J7	Ch 1 Out 6	Ch 2 Out 2
J8	Ch 1 Out 7	Ch 2 Out 3
J9	Ch 1 Out 8	Ch 2 Out 4
J10	Not used	Ch 2 In
J11	Ch 1 Out 9	Ch 1 Out 5
J12	Ch 1 Out 10	Ch 1 Out 6
J13	Ch 1 Out 11	Ch 1 Out 7
J14	Ch 1 Out 12	Ch 1 Out 8
J15	Ch 1 Out 13	Ch 2 Out 5
J16	Ch 1 Out 14	Ch 2 Out 6
J17	Ch 1 Out 15	Ch 2 Out 7
J18	Ch 1 Out 16	Ch 2 Out 8

Power Up

The front LED indicators and configuration jumper are illustrated in [Figure 7](#). Upon power-up, the green PWR LED should light and the yellow CONF LED should illuminate for the duration of module initialization.

Operation Indicator LEDs

With valid input signal(s) connected, the green PWR LED and the green LOCK LED 1 (and LOCK 2 for dual mode) should be on for each audio input.

Figure 7. Operation Indicator LEDs

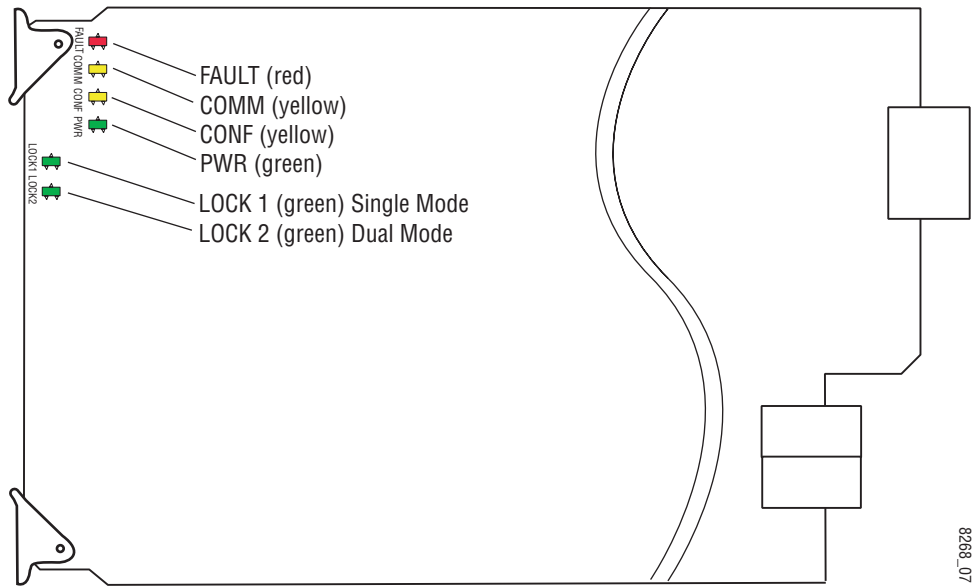

A red FAULT LED indicates an error situation and, with the other LEDs, can indicate the operational conditions presented in Table 2. The table describes signal output and LED indications for various input/reference combinations and user settings.

Table 2. Indicator LEDs and Conditions Indicated

LED	Indication	Condition
FAULT (red)	Off	Normal operation.
	On continuously	Module has detected an internal fault.
	Flashing	AES input missing or Mode Jumper not installed
COMM (yellow)	Off	No activity on frame communication bus.
	Long flash	Location Command received by the module from a remote control system.
	Short flash	Activity present on the frame communication bus.
CONF (yellow)	Off	Module is in normal operating mode.
	On continuously	Module is initializing, changing operating modes or updating firmware. Simultaneous CONF and FAULT LEDs on indicate FPGA load error.
	Flashing	Indicates rate of change of paddle-controlled analog setting.
PWR (green)	Off	No power to module or module's DC/DC converter failed.
	On continuously	Normal operation, module is powered.
LOCK 1 (green)	Off	Module does not detect a valid AES input signal on channel 1.
	On continuously	Valid AES input signal is present on channel 1 and module is locked to it.
LOCK 2 (green)	Off	Module does not detect a valid AES input signal on channel 2 (dual mode only).
	On continuously	Valid AES input signal is present on channel 2 and module is locked to it.

Remote Monitoring

Monitoring of the 2010RDA-16 can be performed remotely using the 2000NET interface (see Figure 8) or the Newton control panel. This section describes the GUI access to the module functions. Refer to the *2000NET Network Interface Module Instruction Manual* for information on setting up and operating the 2000 frame network.

Note The physical appearance of the menu displays shown in this manual represent the use of a particular platform, browser and version of 2000NET module software. They are provided for reference only. Displays will differ depending on the type of platform and browser you are using and the version of the 2000NET software installed in your system.

The 2000 modules can be addressed by clicking on a specific module icon in the frame status display or on a module name or slot number in the link list on the left.

Figure 8. 2000NET GUI

The Links section lists the frame and its current modules. The selected link's Status page is first displayed and the sub-list of links for the selection is opened. The sub-list allows you to select a particular information page for the selected device.

Content display section displays the information page for the selected frame or module (frame slot icons are also active links).

Refresh button for manual update of page

Online Manual Link

Status

Model: 2000T3N Description: Module Frame

Frame Location: Modular Lab

Frame Health Status **PASS** Temperature Status **Pass**

Fan Status **PASS**

Media Module	Net Card	Media Module	Power Sled
Empty		Empty	
Empty	Aux Card	Empty	Empty
Media Module		Empty	
Empty		Empty	Empty
Media Module		Media Module	

Properties

Vendor Thomson, Grass Valley Software Version 3.2.0

Media Slots 13

Bay 1 2000T3 Frame

- [Status](#)
- [Configuration](#)
- [1 Decoder Video-14](#)
- [2 Decoder Aud Mux-14](#)
- [3 Decoder Aud ADC-14A](#)
- [4 Decoder Aud ADC-14B](#)
- [5 Empty](#)
- [6 2010RDA-16](#)
- [7 FS Aud Dmx-14](#)
- [8 FS SDI Video-14](#)
- [9 FS Aud Delay-14A](#)
- [10 FS Aud Delay-14B](#)
- [11 FS Aud Mux-14](#)
- [12 FS Vid Encoder-14](#)
- [13 2000NET](#)
- [15 Empty](#)
- [19 Power Sled 19](#)
- [20 Fan Sled 20](#)
- [21 Power Sled 21](#)

8268_11

Use the **Refresh** button to update the display (available with 2000NET software version 3.0 and later).

The **Online Manual Link** button can be set up to link to the documentation in pdf format. Link configuration is done on the Frame Configuration page.

2010RDA-16 Links and Web Pages

The 2000 GUI provides the following links and displays for the 2010RDA-16 module (Figure 9):

- Status – reports input signal status and module information (page 18),
- Input Status Output Mode – reports mode of operation, rear module information, input signal lock status and sample rate being detected by the module (page 19),
- Slot Config – provides a Locate Module function and Slot Memory (page 20), and
- Software Update – gives software update information (page 22)

Figure 9. 2010RDA-16 Display Links

6 2010RDA-16

[Status](#)

[Input Status Output
Mode](#)

[Slot Config](#)

[Software Update](#)

Status Page

Use this link — [6 2010RDA-16](#)
[Status](#)
[Input Status Output Mode](#)
[Slot Config](#)
[Software Update](#)

The Status page (Figure 10) shows the status of the audio input signal(s) and the frame bus communication. Color coding of the display indicates the signal status. In general, colors used on the frame and modules indicate:

- Green – normal operation, (Pass) or signal present, module locked.
- Red – On continuously = fault condition, flashing = configuration error.
- Yellow – On continuously = active condition (configuration mode or communication), flashing in sequence = module locator function.

Rear slot status is also reported if the rear module is the wrong type or missing.

Information about the module, such as part number, serial number, hardware revision and software and firmware versions are given in a read-only **Properties** section at the bottom of the display.

Figure 10. 2010RDA-16 Status Page

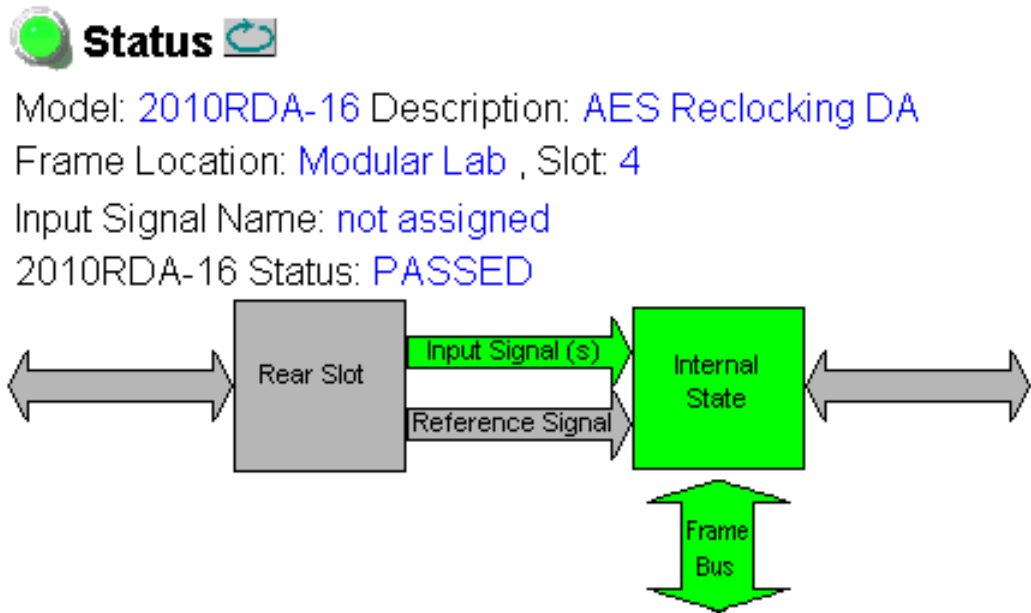

Properties

Hardware Revision	00B	Serial Number	VR03456477
Software Version	1.0.1	Part Number	671-6557-00B
Firmware Version	1		

Input Status Output Mode Page

Use
this
link

[6 2010RDA-16](#)
[Status](#)
[Input Status Output](#)
[Mode](#)
[Slot Config](#)
[Software Update](#)

The Input Status Output Mode page (Figure 11) provides the following status reporting items for the module:

- **Mode** indicates whether the on-board jumper is configured for **Single**, or **Dual** output mode. (Refer to *Local Onboard Module Configuration* on page 8.)
- **Rear Module Status** reports that the Coax passive rear module (**PRM-Coax**) is installed.
- **Channel Lock** indicates whether each channel is **Locked** (valid AES signal is present and module is locked to it) or **Unlocked** (module does not detect a valid AES signal).
- **Sample Rate** indicates the current input sample rate being detected by each channel as one of the following: **Out of Range**, **32K**, **44.1K**, **48K**, or **96K**.

Figure 11. 2010RDA-16 Input Status/Output Mode Display

Input Status Output Mode

Model: [2010RDA-16](#) Description: [AES Reclocking DA](#)

Frame Location: [Modular Lab](#) , Slot: [4](#)

Mode: [Dual](#)

Rear Module Status: [PRM-Coax](#)

Channel: Channel 1: Channel 2:

Lock: [Locked](#) [Locked](#)

Sample Rate: [48 kHz](#) [48 kHz](#)

Slot Config Page

Use
this
link

- [6 2010RDA-16](#)
- [Status](#)
- [Input Status Output Mode](#)
- [Slot Config](#)
- [Software Update](#)

Use the Slot Config page (Figure 12 on page 21) to perform the following functions on the 2010RDA-16 module:

- **Locate Module** – selecting the On pulldown flashes the yellow COMM and CONF LEDs on the front of the module so it can be located in the frame.
- **Slot Identification** – You may identify the module by typing a specific name in the **Name** field. The assigned name is stored on the 2000NET module and travels with the 2000NET module if it is moved to another frame. Select **Default** to enter the factory default module name.
- **Slot Memory** – the slot configuration for each media module is automatically saved periodically (once an hour) to the 2000NET module in that frame. You may also select the **Learn Module Config** button at any time to save the current configuration for this slot. The configuration is saved on the 2000NET module. If the 2000NET module is removed or powered down, the stored configurations are not saved.

When the **Restore upon Install** box has been checked, the current configuration saved to this slot is saved as slot memory. When the current module is removed and another module of the same type is installed, the configuration saved to the 2000NET module will be downloaded to the new module. The box must be checked before the current module with the saved configuration is removed.

- **Hardware Switch Controls** – a read-only status report of 2000NET module switch settings for Module Status Reporting and Asynchronous Status Reporting (dipswitch S1 segment 7 and dipswitch S2 segment 1). These functions must be enabled for the following Slot SNMP Trap Reports to function.
- **Slot SNMP Trap Reports** – displayed only when the SNMP Agent software has been installed on the 2000NET module. Slot SNMP traps can be enabled only when the hardware switches for Module Fault reporting and Asynchronous Status reporting are in enabled on the 2000NET module.

The enabled SNMP traps will be reported to any SNMP manager that is identified as an SNMP Report Destination in 2000NET configuration. Trap severity is read-only hard-coded information that is interpreted and responded to by the SNMP Manager software configuration.

Figure 12. 8964DEC Slot Config Page

Slot Config

Model: [2010RDA-16](#) Description: [AES Reclocking DA](#)

Frame Location: [Modular Lab](#) , Slot: [6](#)

Locate Module

Flash Off

Slot Identification

Name:

Input Signal Name:

Slot Memory

Restore upon Install

Hardware Switch Controls

Module Status Reporting: [Enabled](#) Asynchronous Status Reporting: [Enabled](#)

Slot SNMP Trap Reports

	Slot Fault	Module Removed	Signal Loss	Reference Loss
Enabled	<input checked="" type="checkbox"/>	<input checked="" type="checkbox"/>	<input checked="" type="checkbox"/>	<input checked="" type="checkbox"/>
Trap Severity	Alarm	Warning	Warning	Warning

Software Update Page

Use
this
link \

- [6 2010RDA-16](#)
- [Status](#)
- [Input Status Output](#)
- [Mode](#)
- [Slot Config](#)
- [Software Update](#)

The Software update page (Figure 13) indicates that the 2010RDA-16 does not support software downloads via the web or using the NetConfig networking application.

For instructions on updating to the latest software, refer to the 2010RDA-16 Release Notes that accompany any software update for complete details.

Figure 13. 2010RDA-16 Software Update Page

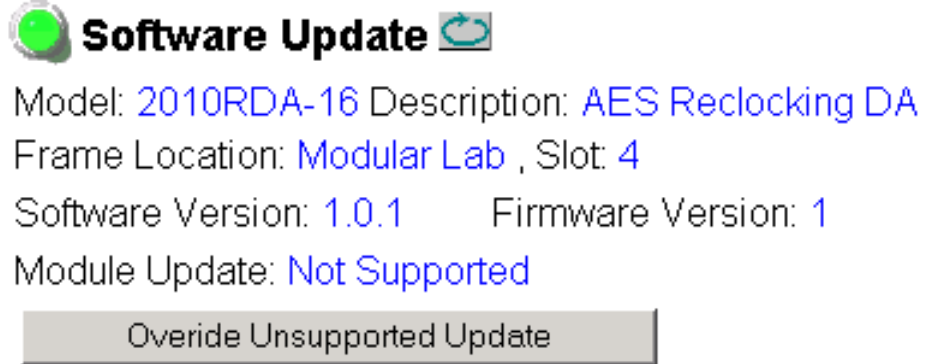

Control Panel Monitoring

The following status parameters for the 2010RDA-16 module can also be monitored with a Newton Modular Control System control panel:

- Slot State
- Input Signal
- Mode
- Rear Module Status
- Channel 1 Sample Rate
- Channel 2 Sample Rate
- Channel 1 Lock
- Channel 2 Lock

Refer to the Newton Instruction Manual for configuration instructions.

Specifications

Table 3. 2010RDA-16 Specifications

Parameter	Value
AES/EBU Inputs	
Signal type	AES3id – 1992 (transformer coupled)
Number of inputs	2 (jumper selectable for single or dual)
Connector type	75 Ω BNC on Passive Rear Module
Common mode range	± 10 V
Differential voltage range	200 mV to 12 V p-p
Sample rate	32 kHz, 44.1 kHz, 48 kHz, or 96 kHz
Input return loss	> 15 dB (100 kHz – 10 MHz)
Maximum jitter	< 6.5 ns RMS
AES Outputs	
Signal type	AES3id – 1992
Number of outputs	Single mode -16, Dual mode – 8 per channel
Connector type	75 Ω BNC
Output level	Unbalanced 1 V \pm 0.1 p-p terminated in 75 Ω
Rise/fall time	30 to 44 ns (across 75 Ω load)
Sample rate	32 kHz, 44.1 kHz, 48 kHz, or 96 kHz
Input return loss	> 15 dB (100 kHz – 6 MHz)
Maximum jitter	< 6.5 ns RMS
Performance	
DC offset	< ± 1 mV
Electrical length (delay)	560 ns
Environmental	
Frame temperature range	0 to 40° C
Operating humidity range	0 to 90% non-condensing
Non-operating temperature	-10 to 70° C
Mechanical	
Frame type	Kameleon 2000 Series
Power Requirements	
Supply voltage	+ 24 V
Power consumption	< 3.3 Watts

Service

The 2010RDA-16 modules make extensive use of surface-mount technology and programmed parts to achieve compact size and adherence to demanding technical specifications. Circuit modules should not be serviced in the field unless directed otherwise by Customer Service.

If your module is not operating correctly, proceed as follows:

- Check module power at JP1. If power is not present, check the fuse on the +24 V input to the module as illustrated in [Figure 14](#).
- Check for presence and quality of input signals.
- Verify that source equipment is operating correctly.
- Check cable connections.

Figure 14. Location of Module Fuse and Voltage Test Points

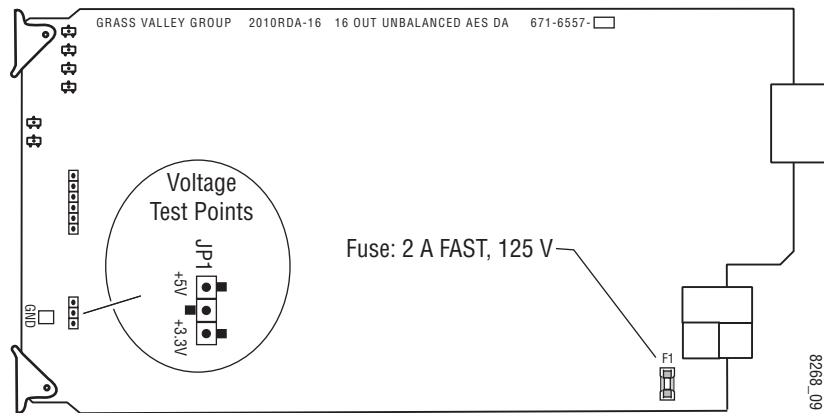

Refer to [Figure 7 on page 14](#) for the location of PWR LED and [Table 2 on page 15](#) for proper LED indications.

If the module is still not operating correctly, replace it with a known good spare and return the faulty module to a designated Grass Valley repair depot. Call your Grass Valley representative for depot location.

Refer to the [Contacting Grass Valley Group](#) at the front of this document for the Grass Valley Customer Support Information number.

Functional Description

The 2010RDA-16 module reclocks and distributes AES/EBU digital audio to sixteen outputs. The modules are configured with jumpers to operate in single or dual mode.

Figure 15. 2010RDA-16 Block Diagram

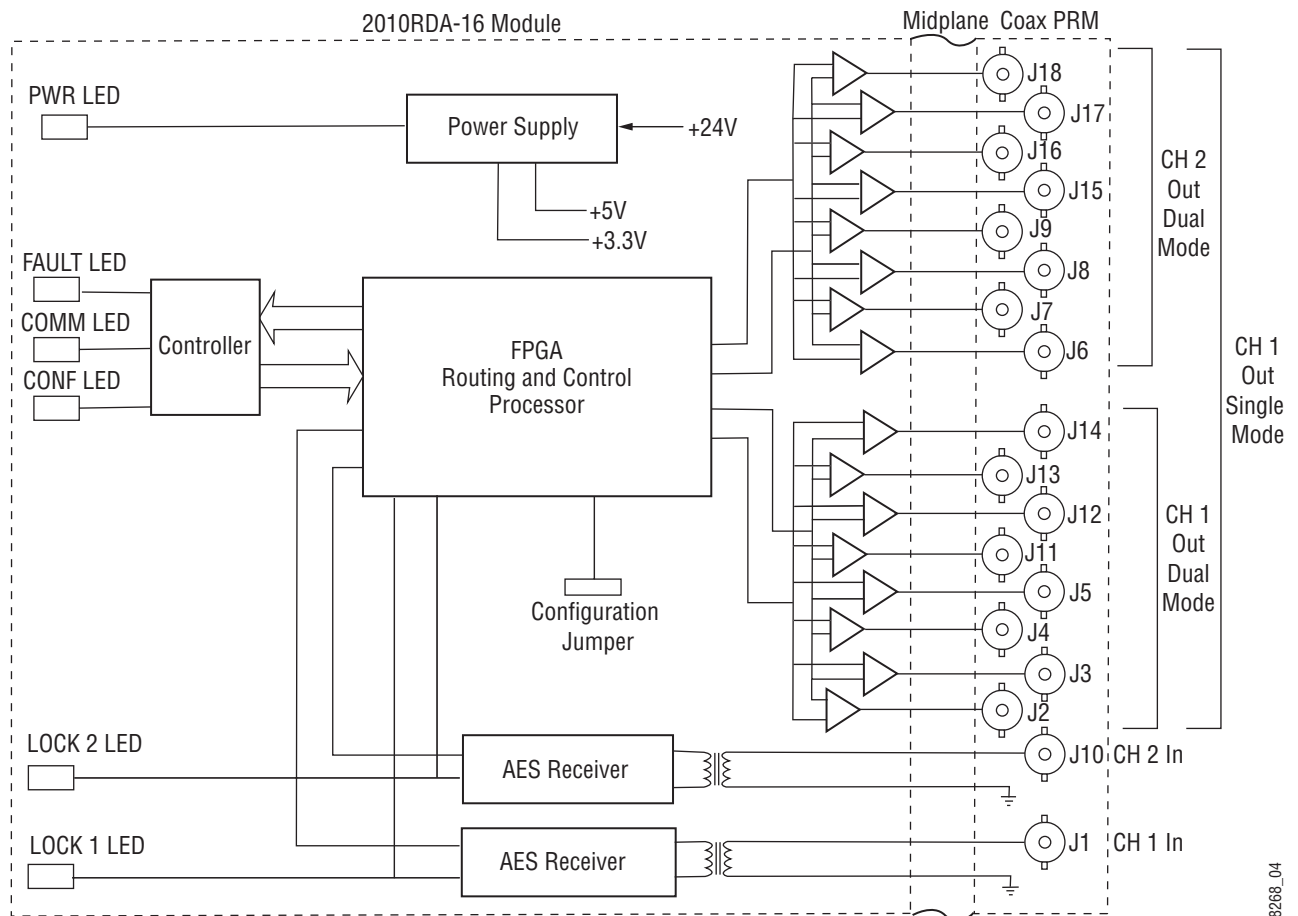

AES Receivers

Each channel of AES3 audio is fed to the modules through an isolation transformer into a crystal receiver IC where the data is reclocked by means of a phase-locked-loop (PLL). Each AES Receiver controls the LOCK LEDs which indicate when the receiver IC is locked to an incoming data stream. The reclocked signal is then fed to the FPGA for routing and control.

Routing and Control FPGA

The signals from the AES receiver ICs are applied to the Routing and Control FPGA. The signal routing is determined by the setting of the on-board configuration jumper at the front of the module. After processing, the signals are embedded into an AES stream and applied to the output drivers.

The Routing and Control section also drives the front panel LEDs and interfaces to the Controller section.

Controller

The Controller interfaces with the Routing and Control FPGA, the EEPROM and the 2000 Frame Bus. The Controller also provides the FPGA code that is downloaded to the FPGA during boot-up.

The Controller section handles local control and monitoring, as well as remote control and monitoring via the frame bus (when an 2000NET module is installed in the frame). Module settings are stored in the EEPROM for power up recall.

Power Supply

Power is fed from +24 V rails of the frame's switching power supply. Each stage of the module receives its own, separate, highly regulated and filtered power source.

Index

Numerics

2010RDA-16
 features [7](#)
 functional description [25](#)
 specifications [23](#)

C

cabling [12](#)
COAX PRM passive rear module
 BNC cabling table [13](#)
 cabling [12](#)
COMM LED [15](#)
CONF (configuring) LED [15](#)
configuration
 on-board [8](#)

D

documentation online [2, 17](#)
dual mode [8](#)

F

FAQ database [2](#)
FAULT LED [15](#)
frame status display [16](#)
frame, 3 RU [9](#)
frequently asked questions [2](#)
fuse [24](#)

G

Grass Valley web site [2](#)
GUI [16, 17](#)

I

Input Status Output Mode web page [19](#)
installation [8](#)

J

jumper settings [8](#)

L

Learn Module Config button [20](#)
locate module [20](#)
LOCK LEDs [14, 15](#)

M

media module [9](#)
 installation [11](#)
midplane [11](#)

N

network [16](#)
Newton control panel [22](#)

O

online documentation [2](#)
 Online Manual Link [17](#)
Online Manual Link [17](#)
operational conditions
 LED indications [15](#)

P

passive rear module [9](#)
 installation [9](#)
power requirements [23](#)
PWR LED [14, 15](#)

R

Refresh button [17](#)
repair depot [24](#)

S

- single mode 8
- Slot Config
 - hardware switch controls 20
 - slot identification 20
 - slot memory 20
- Slot Config web page 20
- SNMP reporting
 - enabling 20
- software download from web 2
- Software Update web page 22
- Status web page 18

T

- troubleshooting 24

W

- web site documentation 2
- web site FAQ database 2
- web site Grass Valley 2
- web site software download 2