

KAM-XM-SERIES

KAM-XM-UDC/UPC/UNC/DNC MODULES

Instruction Manual

SOFTWARE VERSION 1.4.4

071833003
DECEMBER 2005

the most watched worldwide

Contacting Grass Valley

Region	Voice	Fax	Address	Web Site
North America	(800) 547-8949 Support: 530-478-4148	Sales: (530) 478-3347 Support: (530) 478-3181	Grass Valley P.O. Box 599000 Nevada City, CA 95959-7900 USA	www.thomsongrassvalley.com
Pacific Operations	+852-2585-6688 Support: 852-2585-6579	+852-2802-2996		
U.K., Asia, Middle East	+44 1753 218 777	+44 1753 218 757		
France	+33 1 45 29 73 00			
Germany, Europe	+49 6150 104 782	+49 6150 104 223		

Copyright © Grass Valley. All rights reserved.

Grass Valley Web Site

The www.thomsongrassvalley.com web site offers the following:

Online User Documentation — Current versions of product catalogs, brochures, data sheets, ordering guides, planning guides, manuals, and release notes in .pdf format can be downloaded.

FAQ Database — Solutions to problems and troubleshooting efforts can be found by searching our Frequently Asked Questions (FAQ) database.

Software Downloads — Software updates, drivers, and patches can be downloaded.

Preface

About This Manual

This manual describes the features of a specific KAM-XM module in the Kameleon Media Processing System. As part of this module family, it is subject to Safety and Regulatory Compliance described in the 2000 Series frame and power supply documentation (see the *Kameleon 2000 Series Frames Instruction Manual*).

Contents

- Preface**..... 3
 - About This Manual..... 3

- KAM-XM Series**
- Up/Down Conversion Modules** 7
 - Introduction..... 7
 - Module Descriptions 8
 - Supported Up/Down Conversion Rates..... 9
 - System Requirements..... 10
 - Quick Start Guide 11
 - Installation 12
 - Module Placement in the 2000 Frame..... 12
 - Cabling 16
 - KAM-XM-R Rear Module Connections 16
 - GPI0 Connections for GPI Control 18
 - Power Up and Module Status..... 19
 - Configuration and Adjustments 21
 - Configuration Summary..... 21
 - Up and Down Conversion 21
 - Format Conversion 22
 - Aspect Ratio Modes..... 23
 - Proc Amp Controls 25
 - Detail Enhance Controls..... 25
 - Noise Reduction..... 26
 - Spike Filtering..... 26
 - Brickwall Filtering..... 26
 - Temporal Recursive Filtering..... 27
 - Color Legalizer..... 29
 - GPI and E-MEM Controls 29
 - Configuration Summary Table 30
 - Newton Control Panel Configuration 33
 - Web Browser Interface 34
 - Web Page Operations and Functional Elements..... 36
 - Links and Web Pages 38
 - Status Web Page..... 39
 - License Web Page..... 41
 - Setup Web Page 42
 - Format Web Page..... 44
 - Aspect Web Page 46
 - Proc Amp Web Page 48
 - Detail Enhance Web Page..... 49
 - Spike Web Page 50
 - Brickwall Web Page..... 51
 - Temporal Recursive Web Page 52

Contents

Mosquito Web Page	55
Advanced Aperture Web Page	55
Color Legalizer Web Page	56
Grain Insertion Web Page	57
GPI Web Page	58
E-MEM Web Page	59
Slot Config Web Page	65
Software Updating	68
Acquiring NetConfig Software	68
Acquiring the Latest KAM-XM Software	68
Software Updating With NetConfig.	69
Specifications.	73
Service	75
Power-up Diagnostics Failure.	75
Troubleshooting	75
Module Repair.	75
Index	77

KAM-XM Series Up/Down Conversion Modules

Introduction

This manual covers installation, configuration and operation of the following Kameleon KAM-XM Series modules:

- KAM-XM-UDC – HDTV Up/Down Converter
- KAM-XM-UPC – HDTV High Quality Up Converter
- KAM-XM-UNC – HDTV Up Converter with Advanced SDTV Noise Reduction
- KAM-XM-DNC – HDTV Down Converter

Module functionality is summarized in [Table 1](#).

Table 1. KAM-XM Up and Down Converter Module Summary

Function	KM-XM-UDC	KM-XM-UPC	KM-XM-UNC	KM-XM-DNC
Aspect Ratio Control	X	X	X	X
Proc Amp Adjustments (for video processing)	X	X	X	X
Color Space Conversion	X	X	X	X
Detail Enhancement	X	X	X	X
Spike Filter (Adaptive Median filtering)			X	
Brickwall Filter			X	
Temporal Recursive Filter (Auto or Manual mode)			X	
GPI Control (3 external GPI inputs controlling E-MEMs)	X	X	X	X
Color Legalizer Control	X	X	X	X
First 2 audio groups of HD video are re-embedded into SDI stream	X			X
First 2 audio groups of SDTV video re-embedded into HD output stream with compensating delay.	X	X	X	
Re-insertion of Closed Caption data into HD output stream	X	X	X	
2- or 4-frame processing delay	X	X	X	X

The KAM-XM Up/Down conversion series modules also feature:

- Proprietary Teranex™ PixelMotion™ De-interlacing,
- Support of SD and HD video with embedded audio, including Dolby-E,
- Hot-swap capability,
- Operates in the same frame with other 2000 and Kameleon modules,
- Three external GPI inputs to trigger selectable Preset 1-10 registers,
- Network control with the Newton Control Panel or Kameleon web control, and
- Support of NetConfig™ configuration tool and NetCentral™ SNMP-based monitoring system.

Module Descriptions

Each KAM-XM module uses the same circuit board with the application software enabled for the particular module type. The module type is identified by a sticker on the circuit board and the Model name is identified in the web page header. For up/down conversion rates supported, refer to [Table 2 on page 9](#).

The modules described in this manual include the following:

- KAM-XM-UDC – supports broadcast quality up and down conversion of SD and HD video with embedded audio with the standard conversion controls. This application utilizes de-interlacing on a pixel-by-pixel basis for preserving fine detail from the original image. Down conversion offers an anti-aliasing filter.
- KAM-XM-UNC – supports broadcast quality HD up conversion for SDI video with or without embedded audio with the standard conversion controls. In addition, this module also offers advanced noise reduction with adaptive median spike, brickwall, and temporal recursive filter controls. This application utilizes de-interlacing on a pixel-by-pixel basis for preserving fine detail from the original image.
- KAM-XM-UPC – supports broadcast quality HD up conversion for SDI video with or without embedded audio with the standard conversion controls. This application utilizes de-interlacing on a pixel-by-pixel basis for preserving fine detail from the original image.
- KAM-XM-DNC – this broadcast quality down converter application also utilizes de-interlacing on a pixel-by-pixel basis. Once the image has been de-interlaced and down converted, detail enhancement can be applied to the image to further shape the output. The first two groups of audio from the HD video are re-embedded into the standard definition SDI video signal.

Supported Up/Down Conversion Rates

The modules support the conversion rates summarized in [Table 2](#).

Table 2. Format Conversion Input/Output Combinations

Input Format	Output Format	KAM-XM-			
		UNC	UPC	DNC	UDC
480i59.94	480i59.94	X	X		X
480i59.94	720p59.94	X	X		X
480i59.94	1080i59.94	X	X		X
576i50	576i50	X	X		X
576i50	720p50	X	X		X
576i50	1080i50	X	X		X
720p50	576i50			X	X
720p59.94	480i59.94			X	X
1080i50	576i50			X	X
1080i59.94	480i59.94			X	X

System Requirements

Operation of the KAM-XM modules in 2000 Series frames has the following hardware and software requirements:

- Modules must be installed in a 2000T1DNG or 2000T3DNG Kameleon 2000 Series frame containing a 2000GEN module.
- The frame must have a 2000NET module with assembly number 671-5231-01 or later running software version 3.2.2 or later.

Note These requirements are necessary for proper cooling support and interface to the Newton Control Panel configuration, NetConfig and GUI control, and SNMP monitoring.

Existing Kameleon frames can be upgraded with the necessary modules and software for proper operation. Contact your sales representative for more information.

All KAM-XM module sets require two vertical module slots of frame space. Frame density for the 1 RU frame is two module sets and six module sets for a fully stuffed 3 RU frame. Both dual and single height Kameleon and 2000 modules can be mixed in the frames.

Quick Start Guide

This Quick Start Guide is provided for an overview of installing the KAM-XM modules. Each step gives you a link to a more detailed description of each process.

1. Install the KAM-XM modules in the 2000 Kameleon frame. Install the XM-IO-1 Rear module first, then install the front module in the corresponding front slot ([Module Placement in the 2000 Frame on page 12](#)).
2. Connect the 2000 frame to the network and navigate the web browser to the frame. This process is described in detail in the 2000NET Instruction Manual available on-line.
3. Navigate to the module you would like to configure and click on the appropriate slot to access the module links ([Links and Web Pages on page 38](#)).
4. Click on the Slot Config link on the left side of the page ([Slot Config Web Page on page 65](#)). This page allows you to assign a name to this module. Assigning easily recognizable names will help later in the configuration process.
5. Cable the rear module signal connections ([Cabling on page 16](#)).
6. Configure the input and output formats on the Format web page ([Format Web Page on page 44](#)).
7. Configure the Reference source on the Setup web page ([Setup Web Page on page 42](#)). Select the type of reference from either the input signal or an external reference (2000GEN module installed in the 2000 frame).
8. Continue with module configuration depending on the module type.

Installation

Installation of a KAM-XM module set is a process of:

- Placing the KAM-XM rear module in a frame slot,
- Placing the front media module in the corresponding front slot, and
- Cabling signal ports.

Module Placement in the 2000 Frame

There are twelve slot locations in both the front and rear of a Kameleon 3 RU frame to accommodate KAM-XM modules. A KAM-XM module set consists of a front media module and a dual height rear module that requires two module slots.

Each KAM-XM front media module plugs into the front of the 2000 frame mid-plane. The rear module plugs into the corresponding rear slot to provide the input and output interface connectors.

A 3 RU 2000T3 frame fully stuffed with KAM-XM front and rear modules will accommodate up to six module sets. A 1 RU 2000T1 frame will accommodate up to 2 module sets.

The KAM-XM front and rear module can be plugged in and removed from a Kameleon 2000 Series frame with power on. When power is applied to the module, LED indicators reflect the initialization process (see [Power Up and Module Status on page 19](#)).

To install a KAM-XM module set in a frame:

1. For fully stuffing a 3 RU frame with KAM-XM modules, locate a vacant slot in slot 2, 4, 6, 8, 10, or 12 of the rear of the frame ([Figure 1 on page 13](#)). The rear module uses two slots.

Note This configuration (using slots 2, 4, 6, 8, and 10) is only suggested when fully stuffing the frame with KAM-XM modules. There are no restrictions on which slot to use as long as there is room in the frame. You may use any two slots (odd or even numbered) for a KAM-XM module with any Kameleon or 2000 module combination.

Figure 1. 2000T3NG Frame, Rear View

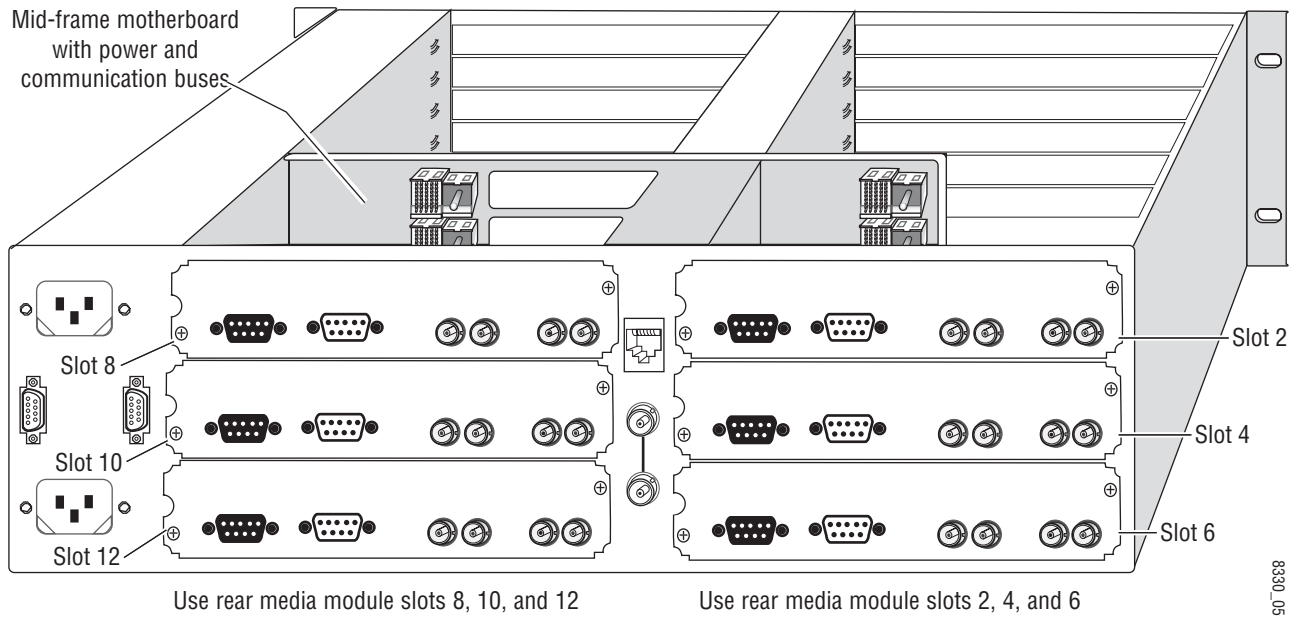

For a 1 RU frame, place the rear module in the lower slot as shown in [Figure 2](#).

Figure 2. 2000T1DNG Frame, Rear View

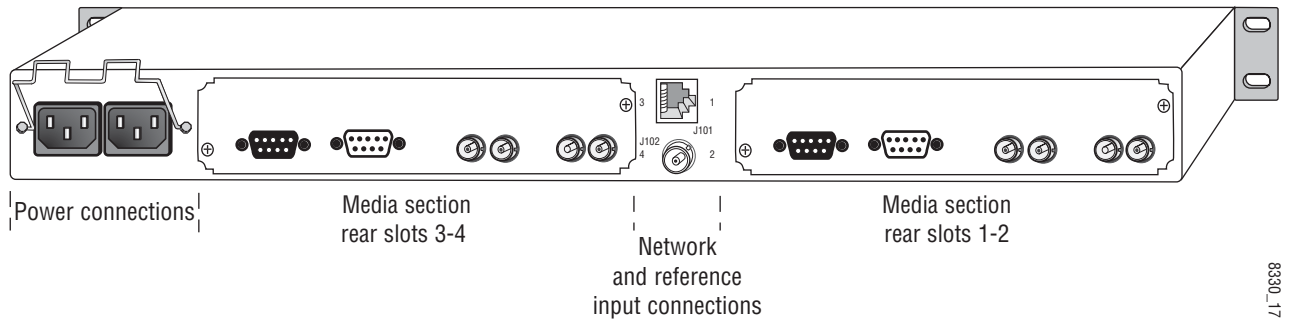

2. Insert the rear module into the vacant rear slot of the frame as illustrated in [Figure 3](#).
3. Verify that the module connector seats properly against the midplane.
4. Using a crossblade screwdriver, tighten the two screw locks to secure the module in the frame.

Figure 3. Installing KAM-XM Rear Module

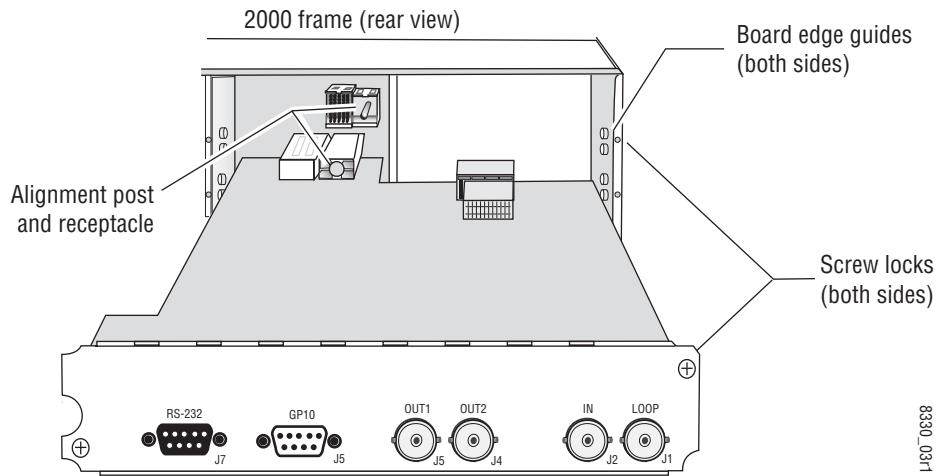

5. Locate the front slot 2, 4, 6, 8, 10, or 12 in the frame corresponding to the rear module circuit board. The 3 RU frame front view is illustrated in [Figure 4](#) and the 1 RU frame is shown in [Figure 5](#) on page 15.

Note Module slots where the KAM-XM should be installed are highlighted in gray for a fully stuffed 2000T3 frame and for any 2000T1 frame.

Figure 4. 2000T3 Frame, Front Slots

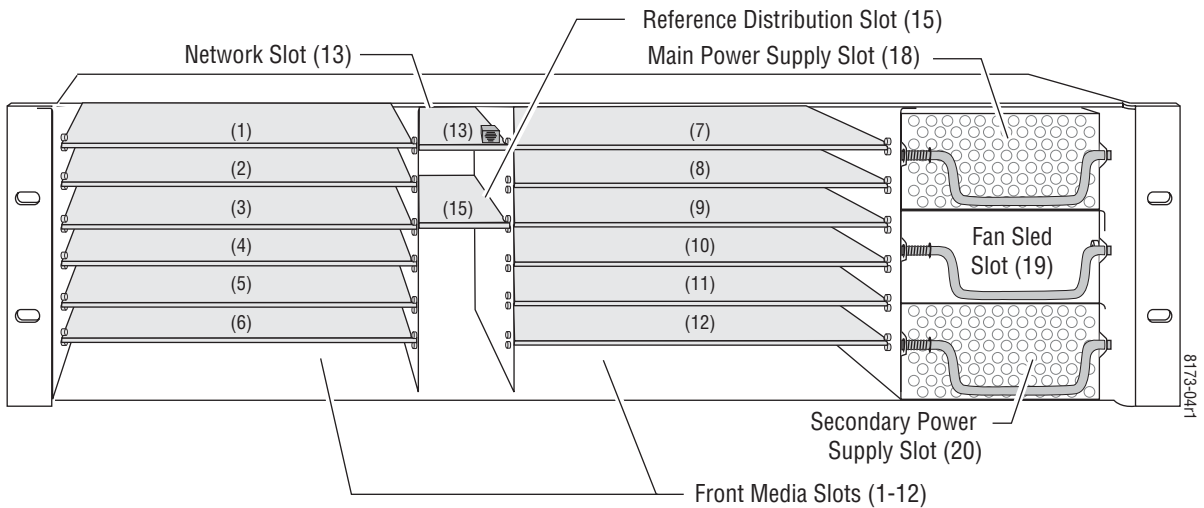
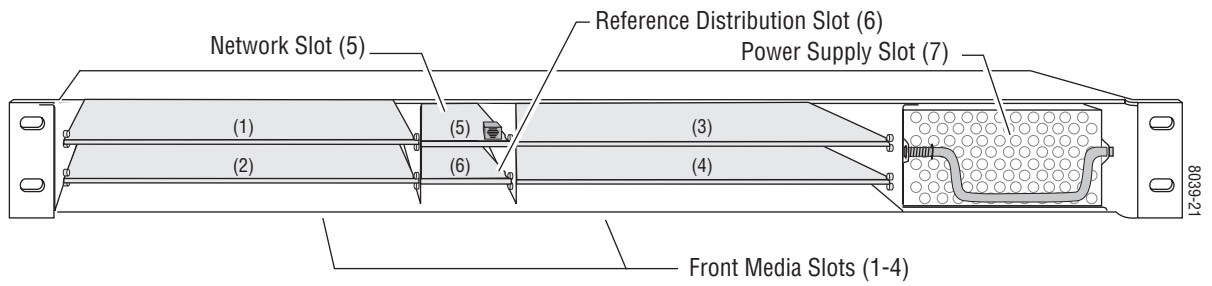
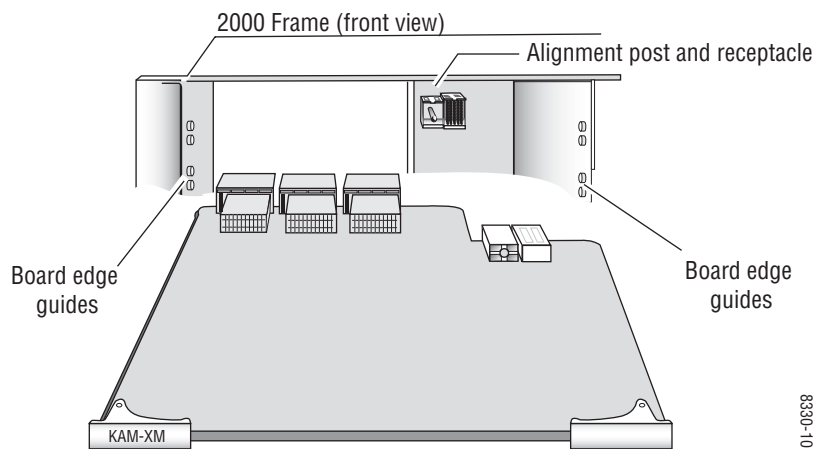

Figure 5. 2000T1 Frame, Front Slots



6. With the component side up, insert the front media module in the corresponding front slot (see [Figure 6](#)).
7. Verify that the module connector seats properly against the midplane and rear module connector.
8. Press firmly on both ejector tabs to seat the module.

Figure 6. Installing Front Media Module



Cabling

All cabling to the KAM-XM module set is done on the corresponding Dual Height KAM-XM-R rear module (XM-IO-1) at the back of the 2000 frame.

KAM-XM-R Rear Module Connections

Refer to [Figure 7](#) for an illustration of the KAM-XM rear module.

The KAM-XM rear module provides the following input and output and control connections.

- IN (BNC)– a serial digital input that may be either standard definition (SD) or high definition (HD) video depending on the front module type.
- LOOP (BNC)– provides an output for the input signal to be looped to another destination.
- OUT1 (BNC)– this serial digital output connection can be either SD or HD depending on the front module type and the output format selected.
- OUT2 (BNC)– this serial digital output connection can be either SD or HD depending on the front module type and the output format selected.
- RS-232 Port (DB-9, Male) – this serial port allows a direct interface to the module for testing and configuration purposes. This port is not normally used.
- GPIO Port (DB-9, Female) – this port allows connection of external GPI (General Purpose Interface) signals to the module as described in [GPIO Connections for GPI Control on page 18](#).

Figure 7. KAM-XM Rear Module Input/Output Connectors

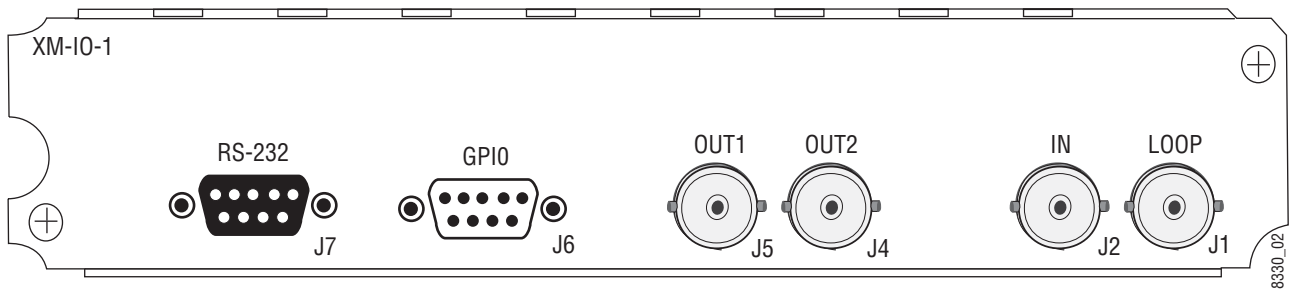

KAM-XM-UPC

For a KAM-XM-UPC HDTV Up Converter, connect the SD signal to be up converted to the IN (J2) BNC. Loop the signal from the LOOP (J1) BNC to another destination if required.

Connect the OUT1 (J5) and OUT2 (J4) BNCs to the HDTV device.

KAM-XM-UDC

For a KAM-XM-UDC HDTV Up/Down Converter, connect the SD signal to be up converted or the HD signal to be down converted to the IN (J2) BNC. Loop the signal from the LOOP (J1) BNC to another destination if required.

Connect the OUT1 (J5) and OUT2 (J4) BNCs to the HDTV device if up converting or the SDTV device if down converting.

KAM-XM-UNC

For a KAM-XM-UNC HDTV Up Converter with advanced SDTV noise reduction, connect the SD signal to be up converted to the IN (J2) BNC. Loop the signal from the LOOP (J1) BNC to another destination if required.

Connect the OUT1 (J5) and OUT2 (J4) BNCs to the HDTV device.

KAM-XM-DNC

For a KAM-XM-DNC Down Converter, connect the HDTV signal to be down converted to the IN (J2) BNC. Loop the signal from the LOOP (J1) BNC to another destination if required.

Connect the OUT1 (J5) and OUT2 (J4) BNCs to the SDTV device.

GPIO Connections for GPI Control

The KAM-XM modules can receive up to three General Purpose Interface (GPI) external triggers to automatically activate specific user preset E-MEM registers configured on the GPI (page 58) and E-MEM web pages (page 59). Customer-supplied external GPI triggers are wired through connector J6 (GPIO) on the rear module.

Inputs to the GPI are held high and expect a contact closure to ground to activate the programmed presets. There is a 100 mA maximum sink to ground.

Table 3 provides pinouts for the GPI I/O control port, connector J6.

Table 3. Connector GP10 Wiring for GPI Control

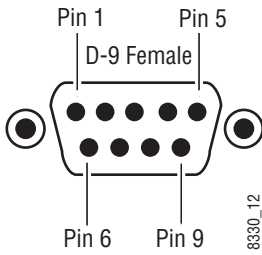
GPIO Control	Pin	Connector J6
	1	GPI Input 1
	2	GPI Input 2
	3	GPI Input 3
	4	Reserved
	5	System Ground
	6	System Ground
	7	Not Connected
	8	Reserved
	9	Reserved

Power Up and Module Status

The front LED indicators are illustrated in [Figure 8](#).

Upon power-up, the green PWR LED should light.

Note The KAM-XM module will take approximately 25 seconds to boot up.

Refer to [Table 4 on page 20](#) to see a complete list of possible operating conditions and the resulting indicator status.

Figure 8. Front Edge LEDs Indicators

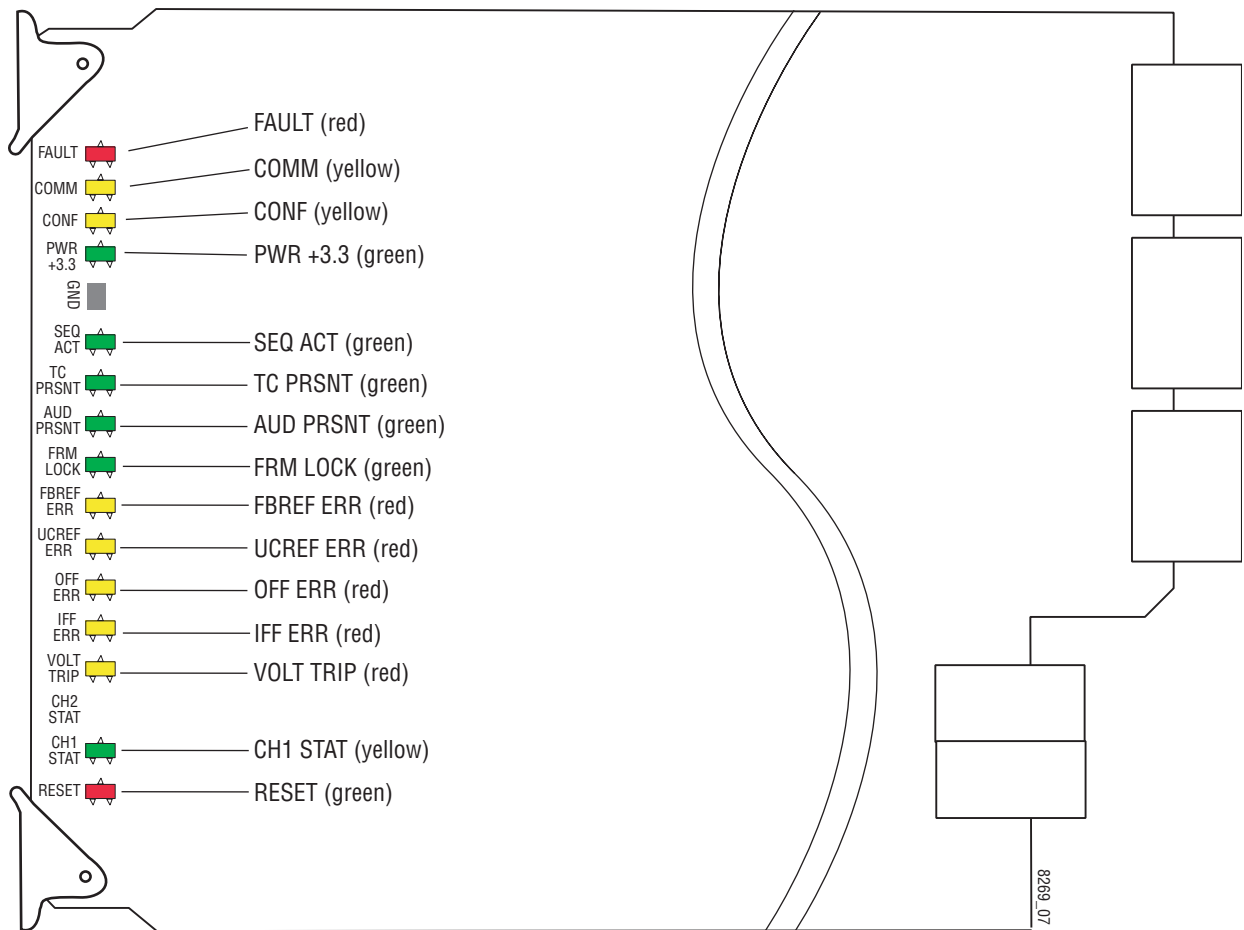

A red FAULT LED indicates an error situation and, when noted with the other indicator LEDs, can indicate a specific problem area. Table 4 describes signal output and LED indications for the various input combinations and user settings.

Table 4. Indicator LEDs and Conditions Indicated

LED	Indication	Condition
FAULT (red)	Off	Normal operation.
	On continuously	Module has detected an Optic 1 or Optic 2 internal fault from the submodule or a write failure has occurred on the front module.
	Long flash	No input is detected for the input or the input does not match the format selected manually, no rear module is present, or the wrong rear module is present.
COMM (yellow)	Off	No activity on frame communication bus.
	3 Short Flashes	Location Command received by the module from a remote control system.
	Short flash	Activity present on the frame communication bus.
CONF (yellow)	On	Module is initializing, changing operating modes, or updating firmware.
	Off	Module is in normal operating mode.
PWR +3.3 (green)	Off	No power to module, fuse blown, or module's DC/DC converter failed.
	On continuously	Normal operation, module is powered.
SEQ ACT (green)	Off	Input video not detected or PLL unlocked.
	Blinking	Normal operation, Sequencer Active LED should be blinking to Indicate good video input and PLLs locked.
TC PRSNT (green)	Off	No timecode or bad timecode.
	On	Good timecode is detected.
AUD PRSNT (green)	Off	No embedded audio detected.
	On	Embedded audio detected.
FRM LOCK (green)	Off	Input to output frame rates are not locked.
	On	Normal operation, input to output frame rates are locked.
FBREF ERR (yellow)	Off	No FrameBuilder refresh error detected.
	On	FrameBuffer refresh error detected, output could be corrupted such as bad output image.
UCREF ERR (yellow)	Off	No Microcode refresh error detected.
	On	Microcode refresh error detected, Microcode memory could be corrupted.
OFF ERR (yellow)	Off	Normal operation, no Output FIFO underflow/overflow error detected.
	On	Output FIFO underflow/overflow error condition detected.
IFF ERR (yellow)	Off	Normal operation, no input FIFO underflow/overflow error condition detected.
	On	Input FIFO is detecting underflow/overflow error condition.
VOLT TRIP (yellow)	Off	Normal state, no under voltage trip detected.
	On	Under voltage trip detected, one or more supply voltages is below specification.
CH1 STAT (green)	Off	No input detected or bad input.
	On	Normal operation, good input detected.
RESET (red)	Off	Normal operation, board is not in Reset mode.
	On	Module is in reset mode, including FPGA configuration sequence.

Configuration and Adjustments

The KAM-XM modules are configured remotely using the 2000NET network interface GUI and/or a networked Newton Control Panel.

Refer to the following sections for configuration instructions:

- Configuration Summary ([page 21](#))
- Newton Control Panel Configuration ([page 33](#))
- Web Browser Interface ([page 34](#))

Operation of these control types is explained in detail in their respective sections of this manual.

Note Before configuration, verify that system requirements have been met as described in [System Requirements on page 10](#).

Configuration Summary

This section provides a summary of all available filters and controls that can be adjusted on the KAM-XM module. Use this section for a summary of what adjustments can be made. [Table 5 on page 30](#) provides a summary in table format of all controls and their ranges, default values, and remote and control panel function names and locations for setting each value.

Up and Down Conversion

Up and down conversion in today's facilities is required for interconnection between video formats that have different numbers of pixels/line, lines/field, and in some cases, a different number of fields or frames/second. This interconnection requires the use of up and down format conversion devices.

Up conversion involves a three dimensional process for dealing with conversion of a moving image. Moving images exist in three dimensions. The horizontal dimension is made up of individual pixels. The vertical dimension is made up of lines contained in the field or frame. These exist in what is referred to as the spatial domain. The number of fields or frames per second is known as the temporal domain.

Generally, the process of up conversion deals with changing the number of pixels and lines in a format (spatial domain). This process is a form of sample rate conversion. One main issue with this process is that of resolution. Resolution cannot be created so the resolution of the original input signal must be carefully recovered and passed to the up converted output.

This is done by a process of de-interlacing the input signal so that the full vertical detail of the input is retained. On the KAM-XM modules this is basically accomplished by using an enhanced version of motion compensated de-interlacing which generates a motion vector for every pixel in the image.

In the process of up conversion, several factors must be addressed and the following controls are provided on the modules for these considerations.

Format Conversion

The video input to the module and the video output from the module can be selected as desired. On the Format web page ([Figure 22 on page 45](#)), the currently detected input is reported, the desired format pulldown is available and the status of the desired conversion format is reported as available. The available input/output format combinations are summarized in [Table 2 on page 9](#).

Additional controls are included for format conversion as described below:

- **App Configuration** – this control provides a choice between 2 or 4 frames of processing delay in down or up conversion applications. In up conversion applications, you may also choose 2 Frame Common or 4 Frame Common which sets the aspect ratio to Common Sides.

When using the shorter delay of 2 frames, the following functionality will be affected due to the shorter signal path through the module:

- The module cannot be externally referenced.
- The 2 Frame mode utilizes a different de-interlace technique, causing the resultant down conversion to somewhat different.
- In up conversion mode, no noise reduction filters are available.
- **Source Material** – this control is provided to further distinguish the type of input signal to the module. Two choices are available, Auto or Video.
- When set to Auto, the module will determine if the input material originated as video or film and adjust the filtering accordingly. In some situations, such as broadcast applications, where the input material cannot be as easily interpreted by the module, the user can force the mode to Video to prevent artifacts from occurring.
- **Deinterlace Type** – two types of de-interlacing are provided, PixelMotion and Vert Interpolation.
- PixelMotion is a combination of motion-adaptive de-interlacing and diagonal filtering. When using this technique, the image is analyzed to determine if there is any motion. This information is used to determine the filter characteristics used to de-interlace.
- Vert Interpolation de-interlacing combines the two fields of video to create a progressive frame regardless of the amount of motion content in the image.

Aspect Ratio Modes

Most SD material is in a 4:3 aspect ratio while HD material is 16:9. Aspect ratio in this case refers to the ratio of an image width to height, not related to image size. The effect of aspect ratio in up conversion (4:3 to 16:9) is a process of cropping, stretching, or squeezing the image. To address these issues, the module provides a control for selecting one of three standard aspect ratio conversion options:

- **Anamorphic** – this mode is designed to be used with material originally captured with an anamorphic lens. It ensures that the top and bottom edges of the input aspect ratio match the top and bottom edges of the output aspect ratio. When used with standard 4:3 material, it will have the effect of stretching the material horizontally as illustrated in [Figure 9](#). This results in a distortion of the geometry of the image, particularly causing circles to appear as ovals when present in the image.

Figure 9. 16:9 Anamorphic Mode

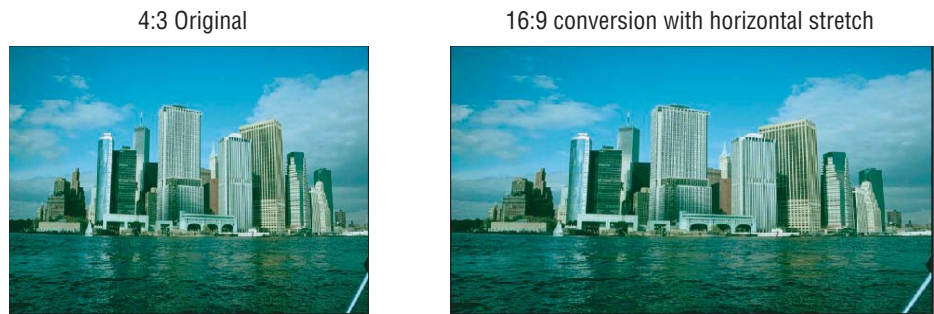

- **Common Top & Bottom** – this mode ensures that the top and bottom edges of the input image match the top and bottom edges of the output aspect ratio. A 4:3 image set to this mode will appear centered in a 16:9 display with black bars, or pillars (pillarbox), on the left and right sides as illustrated in [Figure 10](#).

Figure 10. Common Top and Bottom Mode



- Common Side (Common Left & Right) – this mode ensures that the left and right edges of the input image match the left and right edge of the output aspect ratio. As illustrated in the Anamorphic example (Figure 9 on page 23), for a 4:3 image, the left and right edges are stretched to match the left and right edges of the output.

In order to maintain correct geometry of the image, in Common Side mode the input image is stretched vertically as well, creating a zoom effect (Figure 11). This method results in correct geometry of the image but also results in overall loss of approximately 33% of the input information in the vertical domain. This loss of information means less vertical information is available to the interpolation process resulting in lowering the overall resolution of the output image.

Figure 11. Common Sides Mode



- FlexView – (currently only available in 480i/59.94 to 1080i/59.94 up conversion) is a non-linear anamorphic aspect ratio designed for use when converting 4:3 material to 16:9 without the traditional distortion of a normal anamorphic stretch. FlexView leaves the center portion of the image untouched and then applies increasing amounts of stretch closer to the edges of the image, giving a more realistic conversion.

Other aspect ratio controls include the following:

- Zoom Crop – when turned on, will zoom the image by 3 pixels and then crop the image by 3 pixels. This corrects issues that arise on the top or bottom edge or on the left or right side of an image.
- Edge Trim – this control adjust the amount of border cropping in the X and Y directions. It is adjustable from 0-50 or 0-20 pixels, depending on the conversion currently in use.
- Fill Shade – this control is used when input the aspect ratio is smaller than the output aspect ratio and there are areas in the output display that are filled with black. The Fill Shade control adjusts the luminance level (Y) and color (Cb and Cr) of these areas from 64 (digital black) to 940 (digital white).

Proc Amp Controls

Proc Amp controls are provided for making adjustments to the output video signal. Each Proc Amp function must be enabled before adjustments can be made.

The following Proc Amp controls are available:

- Video Gain – sets the overall amplitude with a range of ± 6 dB.
- Black Level – adjusts the black level with a range of ± 30 IRE.
- Hue – adjusts the phase with a range of ± 9 degrees.
- Saturation – adjusts the chroma saturation with a range of ± 6 dB.
- RP 177 checkbox – check this box when using video converted from film production as specified by SMPTE Recommended Practice RP 177.

Detail Enhance Controls

Once the image has been de-interlaced and up converted, detail enhancement can be applied to the image to further sharpen the output detail. This process utilizes an industry standard film compositing technique called unsharp masking. The filtering process adds an additional level of image detail by detecting the edges of objects and adjusting the contrast ratio around these objects to help separate them from the background. This edge sharpening filter allows for both positive and negative aperture correction.

The following user adjustable controls are available in Detail Enhance:

- Horizontal – enabling the horizontal control allows the user to soften or sharpen the horizontal detail in the image. The range of this control is ± 7.0 dB.
- Vertical – enabling the vertical control allows the user to soften or sharpen the vertical detail in the image. The range of this control is ± 7.0 dB.
- Anti-Alias Filter – in down conversion modes only, an anti-alias filter can be enabled in the down conversion process to smooth edges such as graphics.

Noise Reduction

Two of the modules covered in this manual (KAM-XM-UNC – Up Converter with Noise Reduction and KAM-XM-UDC– Up/Down Converter) provide the additional noise filtering and reduction controls described below.

Spike Filtering

This is an adaptive median filter that works well in removing random impulse noise. This type of filtering performs spatial processing to determine which pixels in an image have been affected by impulse noise. The adaptive median filter classifies pixels as noise by comparing each pixel in the image to its surrounding neighbor pixels. The size of the neighborhood is adjustable, as well as the threshold for the comparison.

A pixel that is different from a majority of its neighbors, as well as being not structurally aligned with those pixels to which it is similar, is labeled as impulse noise. These noise pixels are then replaced by the median pixel value of the pixels in the neighborhood that have passed the noise labeling test. This results in a prime benefit of not eroding edges or other small structures in the image with repeated application of the adaptive median filter.

This type of filtering provides controls for setting the adaptive threshold of the luminance and the chroma channels. The filter must be enabled to allow processing.

Brickwall Filtering

This is a low pass filter with a sharp cutoff. This type of high-order low pass filter attenuates high frequencies (image detail) while leaving low frequency information unaffected. Impulse and Gaussian noise contain high frequency components and will be diminished with this filter is on.

This filter is primarily intended for pre-compression processing, to attenuate high frequency information that will normally be quantized away in the compression process. When used for pre-compression, it can improve the efficiency and quality of the compression process. By controlling the manner in which the detail is removed, compression artifacts can be minimized. A boost can be applied after the brickwall filter to accentuate the remaining edges in the filtered image.

One of the benefits of removing high frequency noise before compression is that there are more bits to spend when generating the compressed stream since there is less information to compress. In addition, the potential for loss of desirable information due to the compression of small details is decreased, resulting in a more consistent output.

Controls for this filter type include the following:

- Enable – the filter must be enabled.
- Boost – sets the amount of amplitude prior to the cutoff frequency. This boosting of the amplitudes gives the appearance of sharpening in the image to help compensate for blurring that occurs when filtering out high frequency information.
- Cutoff – sets the cutoff frequency so that information greater than this value will be filtered. Information less than the cutoff value will be left alone.
- Direction Control – allows setting the filter to affect both the horizontal and vertical axes or just the horizontal or vertical axis.

Temporal Recursive Filtering

This noise reducer is a motion adaptive temporal recursive filter that works well in removing random and Gaussian noise. Each pixel in the filter process is labeled as motion, no motion, or noise.

Each of these classes of pixels is treated differently in the noise reduction process as follows:

- For pixels in which there is no motion, low Gaussian noise may be reduced via temporal processing by a weighted averaging over successive frames.
- For pixels labeled as random noise, spatial processing replaces these pixels.
- Pixels labeled as being in motion are left as is to avoid artifacts that may be introduced through temporal processing.

Controls for temporal filtering include the following:

- Enable – the filter must be enabled.
- Red Overlay – when turned on, the filter superimposes a red overlay onto areas in the input image where the temporal recursive filter identifies motion. This red overlay will display what area is not being filtered.
- Auto – when Auto mode is turned on, a feedback controller is engaged that dynamically sets the distance, no motion, and motion slider controls based on noise and motion measurements. The pixels determined to be in motion will be shown in red as shown in [Figure 12 on page 28](#). These pixels will not have any noise reduction applied to them.

The Bias control in Auto mode adjusts the noise set point in the temporal recursive controller. The higher the bias, the more aggressive the controller is towards the noise in the scene. The lower the bias setting, the more sensitive the controller is towards motion in the scene.

- Manual mode – when Auto mode is turned off, the temporal recursive filter is in Manual mode. This will activate a number of controls for manual temporal filtering.

The Distance control is set to determine the sensitivity to motion between the current frame and historical frames. This threshold represents a percentage of the current pixel value that the historical pixel value must be within in order to be considered unchanged. Therefore, a setting of zero would detect motion at every pixel, applying no filtering occurring. A setting of 40 would be less sensitive to motion, temporally filtering every pixel which could result in blurring or any objects or areas that are in motion. If the Distance control is set too low, too little filtering may occur, whereas, if set too high, too much filtering will be applied.

The No Motion control sets the historical weighting factor for areas in the frame where no motion has been detected. A setting of 100% forces the filter to use only historical data in areas where no motion has been detected. A setting of zero forces the filter to use only current data in areas where no motion has been detected.

The Motion control sets the historical weighting factor for areas in the frame where motion has been detected. A setting of 100% forces the filter to use only historical data in areas where motion has been detected. A setting of zero forces the filter to use only current data in areas where motion has been detected.

Figure 12. Temporal Recursive Filter Red Overlay

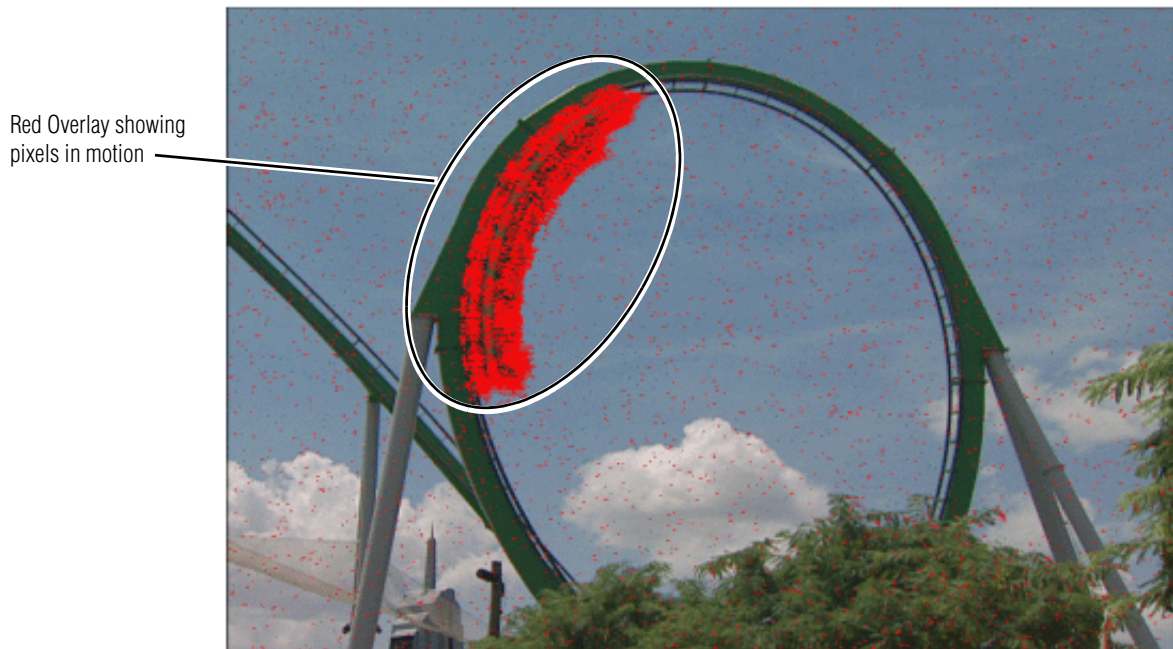

Color Legalizer

Color legalizer controls are provided to set the upper and lower limits for luma and chroma values to be within legal limits for broadcasting and downstream equipment.

Each luma and chroma value is a 10-bit value making the minimum limit 0 and the maximum limit 1019. High and low luma and chroma limit controls are provided for setting the upper and lower limits that the module will output. By default, these controls will cut off values outside of the legal range.

GPI and E-MEM Controls

Configuration is provided for setting up GPI triggers from external devices. Up to ten different module preset configurations can be defined then assigned to the three external GPIs or recalled on the E-MEM web page.

Configuration Summary Table

Table 5 provides a complete summary of the KAM-XM functions and a comparison of the functionality available with each control type along with the ranges and default values for each parameter.

Table 5. Summary of KAM-XM Configuration Functions

Function Type	Default	Range/Choices Resolution	Web Page/ Function Name	Newton Panel	Notes/ Conditions
Reference input selection	Input	Input or External	Setup/ Reference pulldown	Ref	All modules.
Adjust Genlock Offset when external reference selected	0 μ s	\pm 2000 μ s	Setup/ Genlock Offset (microseconds)	–	
Closed Caption Line select	Line 9	Line 9 to 19	Setup/ Closed Caption Line	CCLine	Up conversion modes.
Ignore bad video control	Don't Ignore	Ignore or Don't Ignore	Setup/ Bad Video Ignore checkbox	–	All modules
Blank VBI lines (525 line rate only)	Not Blanked	Blank or Not Blanked	Setup/ Blank Line checkboxes (525: Line 20, 21, 22, 23, 283, 284, 285, 286)	Blank20 Blank283 Blank21 Blank284 Blank22 Blank285 Blank23 Blank286	Up conversion modes.
Format Conversion Input selection	Up Converter: 480i59.94 Down Converter: 720p50	480i59.94 576i50 720p50 720p59.94 1080i50 1080i59.94	Format/ Input pulldown	InDesired	All modules.
Current Input Format	480i59.94	See list above	Format/ Current read-only column	InCurrent	
Input Available	–	Yes or No	Format Conversion/ Available read-only column	InAvailable	
Format Conversion Output	Up Converter: 480i59.94 Down Converter: 576i50	See list above	Format/ Output pulldown	OutDesired	
Current Output Format	480i59.94	See list above	Format/ Current read-only column	OutCurrent	All modules. Changing formats in some cases will cause application to reload. Wait for module to reload.
Output Available	–	Yes or No	Format/ Available read-only column	Available	
Apply format control	–	–	Format/ Apply button	ApplyFmt	
App Configuration	4 Frame Delay	4 Frame Delay 4 Frame Delay Common 2 Frame Delay Common 2 Frame Delay (Common mode in up conversion only)	Format/ App Configuration pulldown	–	See Format Conversion on page 22 for information on using this control.

Table 5. Summary of KAM-XM Configuration Functions

Function Type	Default	Range/Choices Resolution	Web Page/ Function Name	Newton Panel	Notes/ Conditions
Source Material selection	Video	Video or Auto	Format/ Source Material pulldown	–	Up conversion modes.
Deinterlace Type selection	PixelMotion	PixelMotion or Vert Interpolation	Format/ Deinterlace Type pulldown	–	
Current Aspect selection	Anamorphic	Anamorphic, Common Top, Common Side, or FlexView (480i/59.94 to 1080i/59.94 only)	Aspect/ Current Aspect pulldown	Aspect	All modules
Zoom Crop enable	Off	On or Off	Aspect/ Zoom Crop On checkbox	Crop	
Edge Trim – X or Y Trim	0 pixels	0 to 50 pixels 0 to 20 pixels	Aspect/ Edge Trim X or Y Trim control	XTrim YTrim	
Fill Shade – Y/Cb/Cr Channels	64	64-940	Aspect/ Fill Shade Y, Cb or Cr control	FILLY FillCb FillCr	
Video Gain Enable	Off	On or Off	ProcAmp/ Video Gain Enabled checkbox	GainEn	
Video Gain adjustment	0 dB	± 6.0 dB	ProcAmp/ Video Gain control	Gain	All modules. Each control must be enabled,
Black Level Enable	Off	On or Off	ProcAmp/ Black Level Enabled checkbox	BlackEn	
Black Level adjustment	0 IRE	± 30 IRE	ProcAmp/ Black Level control	Black	
Hue Enable	Off	On or Off	ProcAmp/ Hue Enabled checkbox	HueEn	
Hue adjustment	0 degrees	± 9.0 degrees	ProcAmp/ Hue control	Hue	
Saturation Enable	Off	On or Off	ProcAmp/ Saturation Enabled checkbox	SaturEn	
Saturation adjustment	0 dB	± 6 dB	ProcAmp/ Saturation control	Satur	
RP 177 enable	Off	On or Off	ProcAmp/ RP 177 On checkbox	–	
Horizontal Detail Enhance Enable	Off	On or Off	Detail Enhance/ Horizontal Enable checkbox	EnhHorEn	All modules. Each control must be enabled
Horizontal Detail Enhance	0 dB	± 7 dB	Detail Enhance/ Horizontal (dB) control	EnhHorDB	
Vertical Detail Enhance Enable	Off	On or Off	Detail Enhance/ Vertical Enable checkbox	EnhVerEn	
Vertical Detail Enhance	0 dB	± 7 dB	Detail Enhance/ Vertical control	EnhVerDB	
Anti-aliasing filter enable	Off	On or Off	Detail Enhance/ Anti-Alias Filter checkbox	AntiAlias	Down conversion modes only

Table 5. Summary of KAM-XM Configuration Functions

Function Type	Default	Range/Choices Resolution	Web Page/ Function Name	Newton Panel	Notes/ Conditions
Luma Limit High	4	4 to 1019	Color Legalizer/ Color Legalizer Levels/ Luma Limit High control	LumaLmtH	All modules.
Luma Limit Low	979	4 to 979	Color Legalizer/ Color Legalizer Levels/ Luma Limit Low control	LumaLmtL	
Chroma Limit High	4	4 to 1019	Color Legalizer/ Color Legalizer Levels/ Chroma Limit High control	ChromaLmtH	
Chroma Limit Low	979	4 to 979	Color Legalizer/ Color Legalizer Levels/ Chroma Limit Low control	ChromaLmtL	
Available on KAM-XM-UNC only:					
Spike filter enable	Off	On or Off	Spike/ Enable pulldown	SpikeEn	Control must be enabled.
Spike Luma/Chroma control	90%	1 to 100%	Spike/ Luma & Chroma control	SpkLuma SpkChroma	
Brickwall filter enable	Off	On or Off	Brickwall/ Enable pulldown	BrickEn	Control must be enabled
Brickwall Boost control	0 dB	0, 1, 2, 3 or 4 dB	Brickwall/ Boost control	Boost	
Brickwall Cutoff setting	3.5 MHz	0.9, 1.0, 1.25, 1.50, 1.75, 2.0, 2.25, 2.5, 2.75, 3.0, 3.25, 3.5, 3.75, 4.0, 4.25, 4.5, 4.75, 5.0, 5.25, 5.5 MHz	Brickwall/ Cutoff control	Cutoff	
Brickwall direction	Horizontal & Vertical	Horizontal & Vertical Horizontal Vertical	Brickwall/ Direction pulldown	Dir	
Temporal Recursive filter enable	Off	On or Off	Temporal Recursive/ Enable pulldown	RcrsvEn	
Temporal Recursive Red Overlay enable	Off	On or Off	Temporal Recursive/ Red Overlay pulldown	RedOvEn	
Temporal Recursive Auto	On	On or Off	Temporal Recursive/ Auto pulldown	Auto	
Temporal Recursive Bias	0	± 6	Temporal Recursive/ Auto pulldown	Bias	Auto mode only
Temporal Recursive Distance	15%	0 to 40%	Temporal Recursive/ Distance control	Distance	Manual mode only (Auto off)
Temporal Recursive No Motion	50%	0 to 100%	Temporal Recursive/ No Motion control	Motion (PID 1096)	
Temporal Recursive Motion	0%	0 to 100%	Temporal Recursive/ Motion control	NoMotion	

Newton Control Panel Configuration

A Newton Control Panel (hard or soft version) can be interfaced to the Kameleon 2000 Series frame over the local network. Control panel access offers the following considerations for module configuration and monitoring:

- Ability to separate system level tasks from operation ones, minimizing the potential for on-air mistakes.
- Ability to group modular products—regardless of their physical locations—into logical groups (channels) that you can easily manipulate with user-configured knobs.
- Update software for applicable modules and assign frame and panel IP addresses with the NetConfig Networking application.
- Recommended for real-time control of module configuration parameters, providing the fastest response time.

Note Not all module functions are available with the control panel, such as E-MEM and factory default recalls. The available control panel controls for the module are listed in [Table 5 on page 30](#).

An example of the Newton Configurator is shown in [Figure 13](#).

Figure 13. Newton Configurator Example

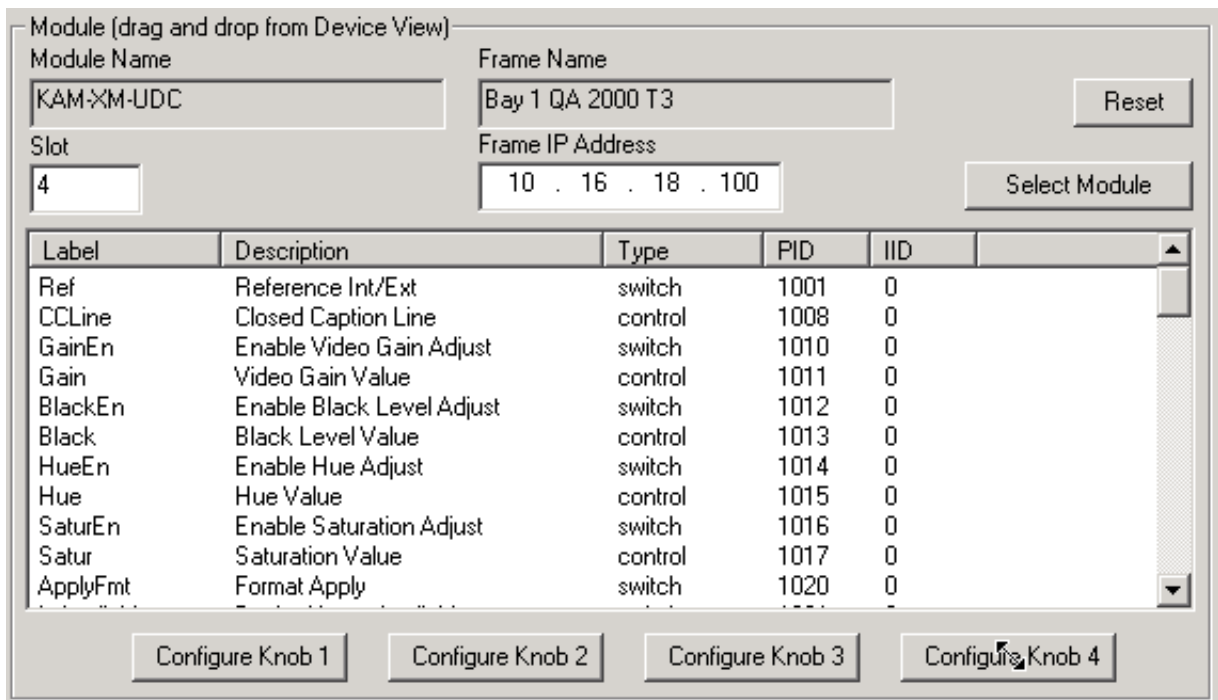

Refer to the documentation that accompanies the Newton Modular Control System for installation, configuration, and operation information.

Web Browser Interface

The web browser interface provides a graphical representation of module configuration and monitoring.

Use of the web interface offers the following considerations:

- Provides complete access to all module status and configuration functions, including naming of inputs and outputs, factory parameter and name default recalls, E-MEM functions, slot configuration, and SNMP monitoring controls.
- Web access will require some normal network time delays for processing of information.
- Configuration parameter changes may require pressing the **Apply** button or **Enter**, upload processing time, and a manual screen refresh to become effective.
- Web interface recommended for setting up module signal and slot names, E-MEMS, and reporting status for SNMP and monitoring.

Refer to the Frame Status page shown in [Figure 14 on page 35](#). The Kameleon and 2000 modules can be addressed by clicking either on a specific module icon in the frame status display or on a module name or slot number in the link list on the left.

Note The physical appearance of the menu displays on the web pages shown in this manual represent the use of a particular platform, browser and version of 2000NET module software. They are provided for reference only. Displays will differ depending on the type of platform and browser you are using and the version of the 2000NET software installed in your system. This manual reflects 2000NET software version 4.0.0.

Figure 14. 2000NET GUI

The Links section lists the frame and its current modules. The selected link's Status page is first displayed and the sub-list of links for the selection is opened. The sub-list allows you to select a particular information page for the selected device.

Content display section displays the information page for the selected frame or module (frame slot icons are also active links).

Refresh button for manual update of page

grass valley

Status

Model: 2000T3N Description: Module Frame
 Frame Location: Modular Lab
 Frame Health Alarm **PASS** Temperature Status **PASS**
 Power Status **PASS** Fan Status **PASS**

Empty	Net Card	Empty	Power Sled
Media Module		Media Module	
Empty	Aux Card	Empty	Fan Sled
Media Module		Media Module	
Empty		Empty	Power Sled
Media Module		Media Module	

Properties
 Vendor Thomson, Grass Valley Software Version 4.0.0
 Media Slots 13

[Bay 2 QA 2000 T3](#)
[Status](#)
[Configuration](#)
[Connections](#)
[Frame Alarm Reporting](#)
[SNMP Reporting](#)
[Power Supply/Demand](#)
[1 Media Slot 1](#)
[2 KAM-XM-UPC](#)
[3 Media Slot 3](#)
[4 KAM-XM-UDC](#)
[5 Media Slot 5](#)
[6 KAM-XM-DNC](#)
[7 Media Slot 7](#)
[8 KAM-XM-UNC](#)
[9 Media Slot 9](#)
[10 KAM-XM-STD](#)
[11 Media Slot 11](#)
[12 KAM-XM-SDNR](#)
[13 2000NET](#)
[15 2000GEN](#)
[18 Power Sled 18](#)
[19 Fan Sled 19](#)
[20 Power Sled 20](#)

8330_1112

Web Page Operations and Functional Elements

The following conventions and functional elements (shown at left) are used in KAM-XM web page operations. (The examples shown throughout this manual represent 2000NET software version 4.0.0 or later):

Pulldown Menus **Locate Module**



Button —

Radio button — 525 625

Check box — Report Error

Refresh button —

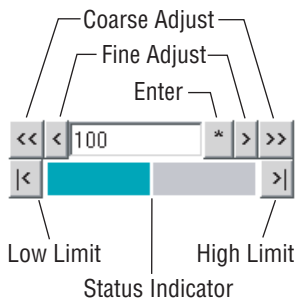

Entry Field

Name:

Status LED —

8341_13

- Pulldown menus allow you to choose selections from a list.
- Clicking on a button performs an immediate action such as recall of defaults, clearing of states, learning configurations, and selecting all or none of a selection.
- Radio buttons are used to make a choice of one parameter in a group.
- Check boxes are used when a selection can be enabled or included in a group. Multiple checkbox selections or enables can be made.
- A **Refresh** button (circular arrow) is provided at the top of each web page for manual refresh to view recently changed parameters.
- Each numerical adjustment control has a **Coarse** adjust button (left and right top double arrows) which increases or decreases the step value by a factor of 10. The **Fine** adjust button (left and right inside single arrows) increases or decreases the step value by 1.

To change a value, use the arrow button controls or enter a value into the number field and select the **Enter** button (*) or use the **Enter** key on your keyboard. The Status Indicator bar will follow the value selected.

Use the **Low** and **High Limit** buttons to go directly to the lowest and highest limits for the parameter.

- An entry field allows naming of various module functions such as input or output signals, asset tag, and slot identification.
- The Status LED is explained below.

Status LED icon

The Status LED icon reports communication status for the frame slot and is a link to the module Status page where Warnings and Faults are displayed. LED colors indicate:



- Green = Pass – no problems detected
- Yellow = Configuration error warning
- Red = Fault condition detected

Variables:

- Model and Description are read-only generated by the module
- Frame Location is entered in 2000 Series Frame configuration
- Slot number reports the module's location in the frame
- Last Recalled E-MEM reports the name of the last E-MEM recalled



An example of the Status page for each of the modules covered in this manual are shown in [Figure 15](#) (UDC), [Figure 16](#) (UPC), [Figure 17](#) (UNC), and [Figure 18](#) (DNC).

Figure 15. KAM-XM-UDC Status Header

 **Status** 



Model: [KAM-XM-UDC](#) Description: [Up/Down Converter](#)
 Frame Location: [Modular Lab](#) , Slot: [4](#)
 Last Recalled E-MEM: [Power On Default](#)

Figure 16. KAM-XM-UPC Status Header

 **Status** 



Model: [KAM-XM-UPC](#) Description: [HQ Up Converter](#)
 Frame Location: [Modular Lab](#) , Slot: [2](#)
 Last Recalled E-MEM: [Power On Default](#)

Figure 17. KAM-XM-UNC Status Header

 **Status** 

Model: [KAM-XM-UNC](#) Description: [HQ Up Converter with Noise Reducer](#)
 Frame Location: [Modular Lab](#) , Slot: [8](#)
 Last Recalled E-MEM: [Power On Default](#)

Figure 18. KAM-XM-DNC Status Header

 **Status** 

Model: [KAM-XM-DNC](#) Description: [Down Converter](#)
 Frame Location: [Modular Lab](#) , Slot: [6](#)
 Last Recalled E-MEM: [Power On Default](#)

Links and Web Pages

- [Status](#)
- [License](#)
- [Setup](#)
- [Format](#)
- [Aspect](#)
- [ProcAmp](#)
- [Detail Enhance](#)
- [Spike](#)
- [Brickwall](#)
- [Temporal Recursive](#)
- [Mosquito](#)
- [Advanced Aperture](#)
- [Color Legalizer](#)
- [Grain Insertion](#)
- [GPI](#)
- [E-MEM](#)
- [Slot Config](#)

The Kameleon 2000 GUI provides the following links (see graphic at left) to configuration web pages for all of the modules covered in this manual unless otherwise specified:

- Status – reports input signal status, warnings, and module information including part number, serial number and software versions ([page 39](#))
- License – reports the module type ([page 41](#))
- Setup – provides controls for selecting the video reference for the module, the genlock offset, closed captioning lines and blanking controls ([page 42](#))
- Format – provides controls for setting input and output format ([page 44](#))
- Aspect – provides aspect ratio conversion options ([page 46](#))
- ProcAmp – provides processing amplifier controls ([page 48](#))
- Detail Enhance – provides horizontal and vertical detail enhancement controls ([page 49](#))
- The following web pages are available only with the KAM-XM-UNC module:
 - Spike – provides adaptive median filter for random noise removal ([page 50](#))
 - Brickwall – provides a low pass filter with a sharp cutoff for impulse and gaussian noise conditions ([page 51](#))
 - Temporal Recursive – provides a motion adaptive filter for removing random and gaussian noise ([page 52](#))
- Mosquito – is not available in this application ([page 55](#))
- Advanced Aperture – is not available in this application ([page 55](#))
- Color Legalizer – provides luma and chroma high and low limit controls for setting legal color limits ([page 56](#))
- Grain Insertion – is not available in this application ([page 57](#))
- GPI – enable and assign E-MEM registers to GPI Inputs 1-3 for external recall ([page 58](#))
- E-MEM – provides ten Preset registers for store and recall of module configuration ([page 59](#))
- Slot Config – provides Slot ID and Memory functions, Frame Health reporting and SNMP reporting enable/disable controls ([page 65](#))

A summary of all configuration value ranges, defaults, and control types is given in [Table 5 on page 30](#).

Status Web Page

Use
this
link

- [Status](#)
- [License](#)
- [Setup](#)
- [Format](#)
- [Aspect](#)
- [ProcAmp](#)
- [Detail Enhance](#)

The Status web page ([Figure 19 on page 40](#)) provides an overall indication of the health of the system in the following sections:

- Status Header – the same on all KAM-XM configuration pages (see [Web Page Operations and Functional Elements on page 36](#)),
- Color-coded communication status for each component and path,
- Summary of all fault/warning conditions, and
- Identification, Version and Download Status reporting.

Color-coded Status Indicators and Links

Each box on the Status page represents a KAM-XM module. Arrows represent signal paths that may or may not be monitored. These elements act as links when their function is active (indicated by underlined function name).

Color code:

- Green = Pass – operating as expected.
- Yellow = Warning – signal is absent, has errors, or is misconfigured.
- Red = Fault – a component has failed.
- Grey = Not monitored.

Identification

The Identification section lists the following information about the module:

- Part Number
- Serial Number
- Hardware Version
- License Tag

Version

The Version section lists currently loaded Program, Software, and Video and Audio firmware.

Download Status

The current software version is listed in the Download Status area for all download components. The version for each of these components should be the same.

Figure 19. KAM-XM Status Web Page



Model: [KAM-XM-UPC](#) Description: [HQ Up Converter](#)
 Frame Location: [Modular Lab](#) , Slot: [2](#)
 Last Recalled E-MEM: [Power On Default](#)

Module Physical Structure

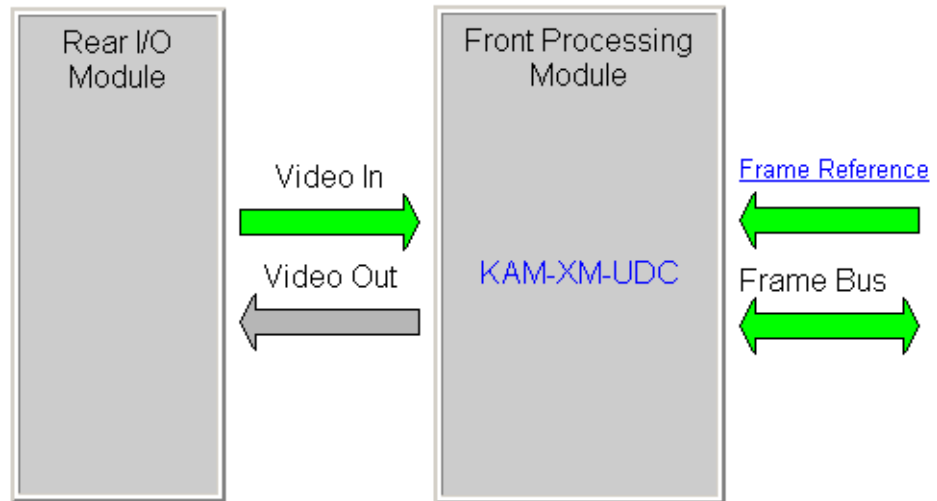

Warning/Fault reporting area

Identification

Part Number	115-0079-49A
Serial Number	G0010
Hardware Version	4
License Tag	98.07.01.EB.1D.53

Download Status

Apps	1.4.4
uCode1	1.4.4
uCode2	1.4.4
uCode3	1.4.4
UVC	1.4.4
Firmware	1.4.4

Version

Program	UVC
Software	1.4.4
Video Firmware	1.6.13
Audio Firmware	2.0.2
P4K-MC Firmware	1.2.2

License Web Page

- Use this link
- [Status](#)
 - [License](#)
 - [Setup](#)
 - [Format](#)
 - [Aspect](#)
 - [ProcAmp](#)
 - [Detail Enhance](#)

The License web page (Figure 20) displays read-only values for identifying the License Tag and Key and the type of module in the Licensed Packages area.

Note This information is set at the factory to determine module type and options.

Figure 20. KAM-XM License Web Page

License

Model: **KAM-XM-UPC** Description: HQ Up Converter
 Frame Location: iModular Lab , Slot: 2
 Last Recalled E-MEM: Power On Default

License Tag	D1.07.31.29.1D.67
License Key	SB5JTMNYEJNG5FRY

Licensed Packages

IC-UPC

Module version

Setup Web Page

Use
this
link

- [Status](#)
- [License](#)
- [Setup](#)
- [Format](#)
- [Aspect](#)
- [ProcAmp](#)
- [Detail Enhance](#)

The Setup web page ([Figure 21 on page 43](#)) provides the following controls for the module:

- **Reference** – set the module reference to either **Input** (from the currently selected video input) or **External** (from the 2000GEN module in the frame).

When **External** is selected, the **Genlock Offset** control will be available. Set the amount of offset in microseconds as needed to match the external reference.
- **Closed Caption Line** – select the line on which to place closed captioning.
- **Bad Video Input** – when the **Ignore** checkbox is selected, the module will not perform an application restart and will only lose the output for 2 frames. Under normal circumstances if a video switch/error occurs in the input SDI signal, the module will perform an application restart to recover, resulting in a 3 second loss of video output.

Note This mode requires that the source and frame be synchronized via an external reference.

- **Blank Line** – Select the **On** checkbox to blank the corresponding line in the vertical interval.

Figure 21. KAM-XM Setup Web Page.

Setup 

Model: [KAM-XM-UPC](#) Description: [HQ Up Converter](#)
Frame Location: [Modular Lab](#) , Slot: [2](#)
Last Recalled E-MEM: [Power On Default](#)

Reference:

Genlock Offset (microseconds)

Closed Caption Line

Bad Video Input: Ignore

Blank Line

Line 20: <input type="checkbox"/> On
Line 21: <input type="checkbox"/> On
Line 22: <input type="checkbox"/> On
Line 23: <input type="checkbox"/> On
Line 283: <input type="checkbox"/> On
Line 284: <input type="checkbox"/> On
Line 285: <input type="checkbox"/> On
Line 286: <input type="checkbox"/> On

Format Web Page

- Use
this
link
- [License](#)
 - [Setup](#)
 - [Format](#)
 - [Aspect](#)
 - [ProcAmp](#)
 - [Detail Enhance](#)
 - [Spike](#)

The Format web page ([Figure 22 on page 45](#)) provides the following controls for the module:

- **Format Conversion** – in the Format Conversion display, the **Current** input and output format are displayed. To change the input, use the Input **Desired** pulldown and select the format. If it is available a **Yes** will appear in the **Available** column. Possible input and output formats, as well as the defaults for an up and down converter are summarized in [Table 2 on page 9](#).

Note Changing the input or output format will cause the module to reload the application. This will take approximately 60 seconds and a reloading message will appear during this time. Select the **Refresh** button at the top of the page to see the new settings after this time has elapsed.

Select the **Apply** button to set the values.



Note All possible input and output values will be listed and can be selected in the pulldowns. If the value does not apply to the application it will be reported as not available.

- **App Configuration** – this control sets the amount of processing delay through the module. Selecting 2 Frame Delay offers a shorter delay time but bypasses some functions available with the default 4 frame delay as described in [Format Conversion on page 22](#).

For applications using down conversion, select either **2 Frame** or **4 Frame Delay**. For applications using up conversion, select from **4 Frame Delay**, **4 Frame Delay Common** (sets the Aspect Ratio to Common Sides), **2 Frame Delay Common** (sets the Aspect Ratio to Common Sides), **2 Frames Delay**.

- **Source Material** – select the type of source material being fed to the module (**Video** or **Auto**). When set to **Auto**, the module will determine if the input material is video or film originated and adjust the filtering accordingly. In some situations, such as broadcast applications, where the input material cannot be as easily interpreted by the module, the user can force the mode to **Video** to prevent artifacts from occurring.
- **Deinterlace Type** – select the type of deinterlacing for the module (**PixelMotion** or **Vert Interpolation**). Select **PixelMotion** for material that has motion or **Vert Interpolation** for images where motion is not a concern. Refer to [Format Conversion on page 22](#) for more explanation on using a particular de-interlace type.

Figure 22. KAM-XM Format Web Page.

 **Format** 
 Model: [KAM-XM-UPC](#) Description: [HQ Up Converter](#)
 Frame Location: [Modular Lab](#) , Slot: 2
 Last Recalled E-MEM: [Power On Default](#)

Format Conversion

	Current	Desired	Available
Input	480i59.94	1080i59.94 ▼	Yes
Output	480i59.94	480i59.94 ▼	Yes
<input type="button" value="Apply"/>			

App Configuration: ▼

Source Material: ▼

Deinterlace Type: ▼

Aspect Web Page

Use
this
link

- [Setup](#)
- [Format](#)
- [Aspect](#)
- [ProcAmp](#)
- [Detail Enhance](#)
- [Spike](#)
- [Brickwall](#)

The Aspect web page ([Figure 23 on page 47](#)) provides the following controls for selecting and adjusting the aspect ratio mode for the module:

- **Current Aspect** – Set the desired Aspect mode to one of the following:
 - Anamorphic
 - Common Side (Common Left & Right)
 - Common Top & Bottom

Refer to [Aspect Ratio Modes on page 23](#) for an overview for setting the aspect ratio mode.

Note Changing the aspect from **Common Sides** or to **Common Sides** will cause the module to reload the application. This will take approximately 60 seconds and the module will display a message stating that the application is reloading. Select the **Refresh** button to see the new settings after this time has elapsed.

- **Zoom Crop** – when enabled by checking the **On** checkbox, zooms the image by 3 pixels and then crops the image by 3 pixels. This allows correction of issues that occur on the top and bottom or left and right edges of an image.
- **Fill Shade** – when the input aspect ratio is smaller than the output aspect ratio there are areas in the output display filled with black. The Fill Shade controls adjust the luminance (Y) and color (Cb and Cr) of the black display areas.
- **Edge Trim** – use the X Trim and Y Trim controls to adjust the amount of border cropping in pixels in the X and Y directions performed on the image.

Figure 23. KAM-XM Aspect Web Page

Aspect 

Model: [KAM-XM-UPC](#) Description: [HQ Up Converter](#)

Frame Location: [Modular Lab](#) , Slot: [2](#)

Last Recalled E-MEM: [Power On Default](#)

Current Aspect:

Zoom Crop: On

Fill Shade

Y			
<< <	84	* >	>>
<			>
Cb			
<< <	100	* >	>>
<			>
Cr			
<< <	64	* >	>>
<			>

Edge Trim

X Trim (pixels)			
<< <	0	* >	>>
<			>
Y Trim (pixels)			
<< <	0	* >	>>
<			>

Proc Amp Web Page

- Use this link
- [Format](#)
 - [Aspect](#)
 - [ProcAmp](#)
 - [Detail Enhance](#)
 - [Spike](#)
 - [Brickwall](#)
 - [Temporal Recursive](#)

The Proc Amp web page (Figure 24) provides the controls for adjusting the video processing parameters for the output of the module. Ranges and default values are summarized in Table 5 on page 30.

Each control must be enabled by checking the **Enabled** checkbox.

Use the Proc Amp controls to set the following parameters:

- **Video Gain** – sets the overall amplitude of the output video signal from ± 6 dB.
- **Black Level** – adjusts the black level of the video output signal ± 30 IRE.
- **Hue** – adjusts the phase of the output video signal ± 9 degrees.
- **Saturation** – adjusts the chroma saturation of the output video signal ± 6 dB.

Check the **RP 177 On** checkbox when using video converted from film production as required by SMPTE Recommended Practice RP 177.

Figure 24. KAM-XM ProcAmp Web Page



Model: [KAM-XM-UPC](#) Description: [HQ Up Converter](#)
 Frame Location: [Modular Lab](#) , Slot: [2](#)
 Last Recalled E-MEM: [Power On Default](#)

ProcAmp		
Video Gain	<input type="checkbox"/> Enabled	Video Gain (dB) << < 0.0 * > >> < █ >
Black Level	<input type="checkbox"/> Enabled	Black Level (IRE) << < 0 * > >> < █ >
Hue	<input type="checkbox"/> Enabled	Hue (degrees) << < 0.0 * > >> < █ >
Saturation	<input type="checkbox"/> Enabled	Saturation (dB) << < 0.0 * > >> < █ >

RP 177: On

Detail Enhance Web Page

- Use this link
- [Aspect](#)
 - [ProcAmp](#)
 - [Detail Enhance](#)
 - [Spike](#)
 - [Brickwall](#)
 - [Temporal Recursive](#)
 - [Mosquito](#)

The Detail Enhance web page (Figure 25) provides the controls for determining the amount of detail enhancement applied to the signal.

Each control must be enabled by checking the corresponding **Enable** checkbox.

Use the following controls to perform detail enhancement:

- **Horizontal** – this control is used to soften or sharpen the horizontal detail in the image (± 6 dB).
- **Vertical** – this control is used to soften or sharpen the vertical detail in the image (± 6 dB).
- **Anti-Alias Filter** – (active in modules with down conversion capability only) turn anti-aliasing **On** or **Off** with the pulldown.

Figure 25. KAM-XM Detail Enhance Web Page

Detail Enhance

Model: [KAM-XM-UDC](#) Description: [Up/Down Converter](#)

Frame Location: [Modular Lab](#) , Slot: [4](#)

Last Recalled E-MEM: [Power On Default](#)

Detail Enhance

Horizontal	<input type="checkbox"/> Enable	Horizontal (dB) << < 0.0 * > >> < >
Vertical	<input type="checkbox"/> Enable	Vertical (dB) << < 0.0 * > >> < >

Anti-Alias Filter:

Spike Web Page

- Use this link
- [ProcAmp](#)
 - [Detail Enhance](#)
 - [Spike](#)
 - [Brickwall](#)
 - [Temporal Recursive](#)
 - [Mosquito](#)
 - [Advanced Aperture](#)

The Spike web page (Figure 26) is active only on the KAM-XM-UNC module.

This web page provides noise reduction with an adaptive median filter that works well in reducing random impulse noise. Refer to [Spike Filtering on page 26](#) for a discussion of the Spike filter.

- **Enable** – enable or disable the **Spike** control with the **Enable** pulldown.
- **Luma & Chroma** – sets the adaptive threshold of the filter in the luminance and chrominance channels. This threshold represents a percentage of the central pixel value that surrounding neighbors must be within in order to be considered similar.

Setting the filter to 100 (maximum) forces the filter on for every pixel, resulting in a standard median filter being applied to the entire luminance and chrominance channels.

Figure 26. KAM-XM Spike Web Page



Model: [KAM-XM-UNC](#) Description: [HQ Up Converter with Noise Reducer](#)
Frame Location: [Modular Lab](#) , Slot: [8](#)
Last Recalled E-MEM: [Power On Default](#)

Enable: ▾

Luma & Chroma

<<	<	90	*	>	>>
<					>

Brickwall Web Page

- Use this link
- [Detail Enhance](#)
 - [Spike](#)
 - [Brickwall](#)
 - [Temporal Recursive](#)
 - [Mosquito](#)
 - [Advanced Aperture](#)
 - [Color Legalizer](#)

The Brickwall web page (Figure 27) is active only on the KAM-XM-UNC module.

This web page provides noise reduction by using a low pass filter with a sharp cutoff to attenuate high frequencies. This type of filter is best for diminishing Gaussian and impulse noise. Refer to [Brickwall Filtering on page 26](#) for a discussion on using the Brickwall filter.

Enable the control by selecting **On** in the **Enable** pulldown then use the following controls for the Brickwall filter:

- **Boost** – sets the amount of boosting in dB of amplitudes prior to the cutoff frequency. This gives the appearance of sharpening the image to help compensate for blurring that occurs when filtering out high frequency information.
- **Cutoff** – sets the cutoff frequency in MHz above which information will be filtered while information below the cutoff will be left untouched.
- **Direction** – this control allows the user to set the direction in which the filters above will affect the picture.
 - **Vertical** applies the filters to the vertical axis only.
 - **Horizontal** applies the filters to the horizontal axis only.
 - **Horizontal & Vertical** applies the filters to the both axes.

Figure 27. KAM-XM Brickwall Web Page



Model: [KAM-XM-UNC](#) Description: [HQ Up Converter with Noise Reducer](#)
 Frame Location: [Modular Lab](#) , Slot: [8](#)
 Last Recalled E-MEM: [Power On Default](#)

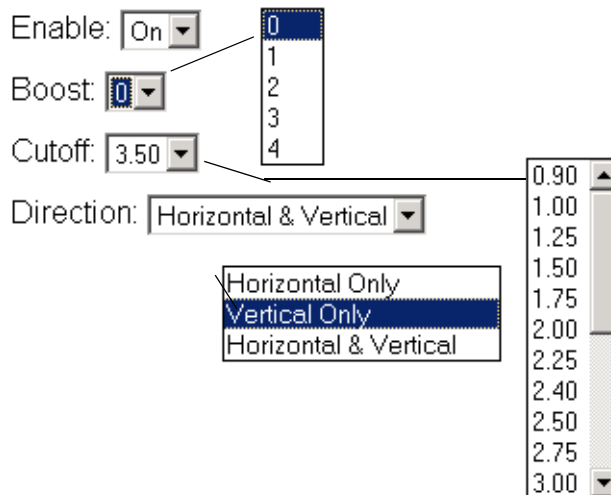

Temporal Recursive Web Page

- Use this link
- [Spike](#)
 - [Brickwall](#)
 - [Temporal Recursive](#)
 - [Mosquito](#)
 - [Advanced Aperture](#)
 - [Color Legalizer](#)
 - [Grain Insertion](#)
 - ...

The Temporal Recursive web page is active only on the KAM-XM-UNC module.

This is a motion adaptive temporal recursive filter that works well in removing random and Gaussian noise. Refer to [Temporal Recursive Filtering on page 27](#) for a discussion on using this filter.

Enable the Temporal Recursive control by selecting **On** in the **Enable** pull-down. This filter can operate in either **Auto** or **Manual** mode.

Auto Mode

Use the following controls for removing noise:

- **Red Overlay** – when enabled (**On**), a red overlay is superimposed onto areas in the input image where the temporal recursive filter identifies motion.
- **Auto** – enabling this mode ([Figure 28](#)) engages a feedback controller that dynamically sets the **Distance**, **No Motion** and **Motion** control setting available in **Manual** mode based on noise and motion measurement extracted from the scene.
- **Bias** – is active only in **Auto** mode. This control adjusts the noise set point in the temporal recursive controller. The higher the bias the more aggressive the controller is towards noise in the scene. The lower the bias setting the more sensitive the controller is towards motion.

Figure 28. KAM-XM Temporal Recursive – Auto Mode



Model: [KAM-XM-UNC](#) Description: [HQ Up Converter with Noise Reducer](#)
 Frame Location: [Modular Lab](#) , Slot: [8](#)
 Last Recalled E-MEM: [Power On Default](#)

Enable:

Red Overlay:

Auto:

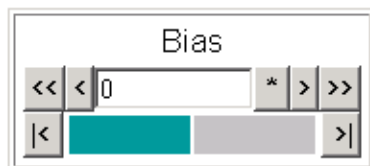

Manual Mode

Enable **Manual** control by turning **Auto** off. The web page will appear as shown in [Figure 29](#).

Use the controls below in Manual Mode:

- **Red Overlay** – when enabled (**On**), a red overlay is superimposed onto areas in the input image where the temporal recursive filter identifies motion.
- **Auto** – disabling Auto (**Off**) puts the Temporal Recursive filter in Manual mode.

Figure 29. KAM-XM Temporal Recursive – Manual Mode

Temporal Recursive

Model: [KAM-XM-UNC](#) Description: [HQ Up Converter with Noise Reducer](#)

Frame Location: [Modular Lab](#) , Slot: [8](#)

Last Recalled E-MEM: [Power On Default](#)

Enable:

Red Overlay:

Auto:

Distance	
<< <	8
<	>
No Motion	
<< <	50
<	>
Motion	
<< <	0
<	>

- **Distance** – sets the distance threshold to determine the sensitivity to motion between the current frame and historical frames. The range of this control is from 0 – 40, with the nominal value for the distance threshold at 15. A setting of 0 will detect motion at every pixel, causing no filtering to occur. A setting of 40 will be less sensitive to motion, temporally filtering every pixel, which may result in blurring of any objects/areas in motion.

In summary, if the distance is set too low, the module detects everything as moving and applies no filtering. If set too high, no motion is detected, and everything is filtered.

- **No Motion** – sets the historical weighting factor for areas in the frame where no motion has been detected. A high setting forces the filter to use only historical data in areas where no motion has been detected. A low setting forces the filter to use only current data in areas where no motion has been detected.
- **Motion** – sets the historical weighting factor for areas in the frame where motion has been detected. A low setting forces the filter to use only current data in areas where motion has been detected.

Mosquito Web Page

- Use this link
- [Brickwall](#)
 - [Temporal Recursive](#)
 - [Mosquito](#)
 - [Advanced Aperture](#)
 - [Color Legalizer](#)
 - [Grain Insertion](#)
 - [GPI](#)

The Mosquito web page (Figure 30) indicates it is not available on these module types.

Figure 30. KAM-XM Mosquito Web Page



Mosquito 

Model: [KAM-XM-UPC](#) Description: [HQ Up Converter](#)
 Frame Location: [Modular Lab](#) , Slot: [2](#)
 Last Recalled E-MEM: [Power On Default](#)

Not Available

Advanced Aperture Web Page

- Use this link
- [Temporal Recursive](#)
 - [Mosquito](#)
 - [Advanced Aperture](#)
 - [Color Legalizer](#)
 - [Grain Insertion](#)
 - [GPI](#)
 - [E-MEM](#)

The Advance Aperture web page (Figure 31) indicates it is not available on these module types.

Figure 31. KAM-XM Advanced Aperture Web Page



Advanced Aperture 

Model: [KAM-XM-UPC](#) Description: [HQ Up Converter](#)
 Frame Location: [Modular Lab](#) , Slot: [2](#)
 Last Recalled E-MEM: [Power On Default](#)

Not Available

Color Legalizer Web Page

- Use this link
- [Mosquito](#)
 - [Advanced Aperture](#)
 - [Color Legalizer](#)
 - [Grain Insertion](#)
 - [GPI](#)
 - [E-MEM](#)

The Color Legalizer web page (Figure 32) provides the controls for setting the high and low legal limits for the luma and chroma values as described in [Color Legalizer on page 29](#).

Use the following controls to set **High** and **Low** limits for Luma and Chroma:

- **Luma** – set the legal limits for the Luma signal with the High and Low controls.
- **Chroma** – set the legal limits for the Chroma signal with the High and Low controls.

Figure 32. KAM-XM Color Legalizer Web Page



Color Legalizer 

Model: [KAM-XM-UPC](#) Description: [HQ Up Converter](#)
 Frame Location: [Modular Lab](#) , Slot: [2](#)
 Last Recalled E-MEM: [Power On Default](#)

Color Legalization Levels

	Luma	Chroma
High	Luma Limit High << < 1019 * > >> < [] >	Chroma Limit High << < 1019 * > >> < [] >
Low	Luma Limit Low << < 4 * > >> < [] >	Chroma Limit Low << < 4 * > >> < [] >

Grain Insertion Web Page

- Use
this
link →
- [Advanced Aperture](#)
 - [Color Legalizer](#)
 - [Grain Insertion](#)
 - [GPI](#)
 - [E-MEM](#)
 - [Slot Config](#)

The Grain Insertion web page ([Figure 33](#)) indicates it is not available on these module types.

Figure 33. KAM-XM Grain Insertion Web Page



Model: [KAM-XM-UPC](#) Description: [HQ Up Converter](#)
Frame Location: [Modular Lab](#) , Slot: [2](#)
Last Recalled E-MEM: [Power On Default](#)

Not Available

GPI Web Page

- Use this link
- [Advanced Aperture](#)
 - [Color Legalizer](#)
 - [Grain Insertion](#)
 - [GPI](#)
 - [E-MEM](#)
 - [Slot Config](#)

The GPI web page ([Figure 34](#)) allows enabling and selection of E-MEM registers to be recalled by three external GPI inputs (Input 1-3). The E-MEM presets are defined on the E-MEM web page ([E-MEM Web Page on page 59](#)).

- Select the desired E-MEM register to be recalled from the pulldown list for each GPI input.
- Check the **Enabled** check box to enable the GPI input.

External GPI connection is explained in [GPIO Connections for GPI Control on page 18](#).

Figure 34. KAM-XM GPI Web Page



Model: [KAM-XM-UPC](#) Description: [HQ Up Converter](#)
 Frame Location: [Modular Lab](#) , Slot: [2](#)
 Last Recalled E-MEM: [Power On Default](#)

GPI Inputs

Input 1	<input type="checkbox"/> Enabled	Black Level
Input 2	<input type="checkbox"/> Enabled	Preset 9
Input 3	<input type="checkbox"/> Enabled	Preset 10

Trim 625
 Black Level
 Linear Min Value
 Video Proc
 Spike
 Brickwall
 Preset 7
 Preset 8
 Preset 9
Preset 10

E-MEM Web Page

Use
this—
link

- [Advanced Aperture](#)
- [Color Legalizer](#)
- [Grain Insertion](#)
- [GPI](#)
- [E-MEM](#)
- [Slot Config](#)

The E-MEM web page provides local operations for learning and recalling configurations into E-MEM registers. File operations are also available for saving or loading the learned E-MEM files to and from a hard disk or other accessible media. These registers can be selected in the GPI 1-3 Inputs to be recalled when the GPI is fired (see [GPI Web Page on page 58](#)).

Factory default settings for all channels can be recalled by selecting the **Recall factory settings** button. To return the module to the factory signal names (such as the signal inputs), select the **Recall factory names** button.

There are two E-MEM view selections: **Standard** and **Advanced**.

In Standard view ([Figure 35 on page 60](#)), any one of ten learned E-MEMs can be recalled by selecting the corresponding **Recall** button in the Local Operations window. This will place the configuration learned into that E-MEM into the module. This change will occur immediately upon recall.

To learn an E-MEM, select the **Advanced** button in the View Selection section. This will open the Advanced view ([Figure 36 on page 61](#)).

Note The existing configuration of the module is also saved automatically to an internal module register called Preset 0 once a minute. This feature of KAM-XM models only, allows the module to recover from a power cycle to the same configuration it had when powered down. This is not the same as Slot Memory on the 2000NET module as explained on [page 65](#).

The Advanced View ([Figure 36 on page 61](#)) includes a File Operations section to Learn a configuration into E-MEM (**Learn**), save a file to a disk location (**Save to...**) or load a file from a disk location (**Load from...**).

To learn an E-MEM:

1. Open the **Advanced** view.
2. When the configuration is complete for the module, type a descriptive name for the configuration into an unused E-MEM register (or overwrite an existing one).
3. Learn the E-MEM to memory by selecting the corresponding **Learn** button. All module parameters are learned at once and stored in the same register. This register is now learned and ready for recall.

Figure 35. KAM-XM E-MEM Web Page – Standard View

 Model: [KAM-XM-UPC](#) Description: [HQ Up Converter](#)
Frame Location: [Modular Lab](#) , Slot: [2](#)
Last Recalled E-MEM: [Power On Default](#)

E-MEM®

View Selection: Standard Advanced

	Local Operations	
E-MEM 1:	Trim 625	<input type="button" value="Recall"/>
E-MEM 2:	Black Level	<input type="button" value="Recall"/>
E-MEM 3:	Linear Min Value	<input type="button" value="Recall"/>
E-MEM 4:	Video Proc	<input type="button" value="Recall"/>
E-MEM 5:	Spike	<input type="button" value="Recall"/>
E-MEM 6:	Brickwall	<input type="button" value="Recall"/>
E-MEM 7:	Preset 7	<input type="button" value="Recall"/>
E-MEM 8:	Preset 8	<input type="button" value="Recall"/>
E-MEM 9:	Preset 9	<input type="button" value="Recall"/>
E-MEM 10:	Preset 10	<input type="button" value="Recall"/>

Recall factory settings Recall factory names

Figure 36. KAM-XM E-MEM Web Page – Advanced View



Model: [KAM-XM-UPC](#) Description: [HQ Up Converter](#)

Frame Location: [Modular Lab](#) , Slot: [2](#)

Last Recalled E-MEM: [Power On Default](#)

E-MEM®

View Selection: Standard Advanced

	Local Operations		File Operations		
E-MEM 1:	<input type="text" value="Trim 625"/>	<input type="button" value="Recall"/>	<input type="button" value="Learn"/>	<input type="button" value="Save to..."/>	<input type="button" value="Load from..."/>
E-MEM 2:	<input type="text" value="Black Level"/>	<input type="button" value="Recall"/>	<input type="button" value="Learn"/>	<input type="button" value="Save to..."/>	<input type="button" value="Load from..."/>
E-MEM 3:	<input type="text" value="Linear Min Value"/>	<input type="button" value="Recall"/>	<input type="button" value="Learn"/>	<input type="button" value="Save to..."/>	<input type="button" value="Load from..."/>
E-MEM 4:	<input type="text" value="Video Proc"/>	<input type="button" value="Recall"/>	<input type="button" value="Learn"/>	<input type="button" value="Save to..."/>	<input type="button" value="Load from..."/>
E-MEM 5:	<input type="text" value="Spike"/>	<input type="button" value="Recall"/>	<input type="button" value="Learn"/>	<input type="button" value="Save to..."/>	<input type="button" value="Load from..."/>
E-MEM 6:	<input type="text" value="Brickwall"/>	<input type="button" value="Recall"/>	<input type="button" value="Learn"/>	<input type="button" value="Save to..."/>	<input type="button" value="Load from..."/>
E-MEM 7:	<input type="text" value="Preset 7"/>	<input type="button" value="Recall"/>	<input type="button" value="Learn"/>	<input type="button" value="Save to..."/>	<input type="button" value="Load from..."/>
E-MEM 8:	<input type="text" value="Preset 8"/>	<input type="button" value="Recall"/>	<input type="button" value="Learn"/>	<input type="button" value="Save to..."/>	<input type="button" value="Load from..."/>
E-MEM 9:	<input type="text" value="Preset 9"/>	<input type="button" value="Recall"/>	<input type="button" value="Learn"/>	<input type="button" value="Save to..."/>	<input type="button" value="Load from..."/>
E-MEM 10:	<input type="text" value="Preset 10"/>	<input type="button" value="Recall"/>	<input type="button" value="Learn"/>	<input type="button" value="Save to..."/>	<input type="button" value="Load from..."/>

Recall factory settings Recall factory names

To save an E-MEM configuration to a file on a hard drive or other accessible media:

1. Select the corresponding **Save to...** button in the File Operations section.
2. This will bring up a File Download screen (not shown), select **Save** to bring up the Save As screen shown in [Figure 37](#).

Figure 37. E-MEM Save to Operation

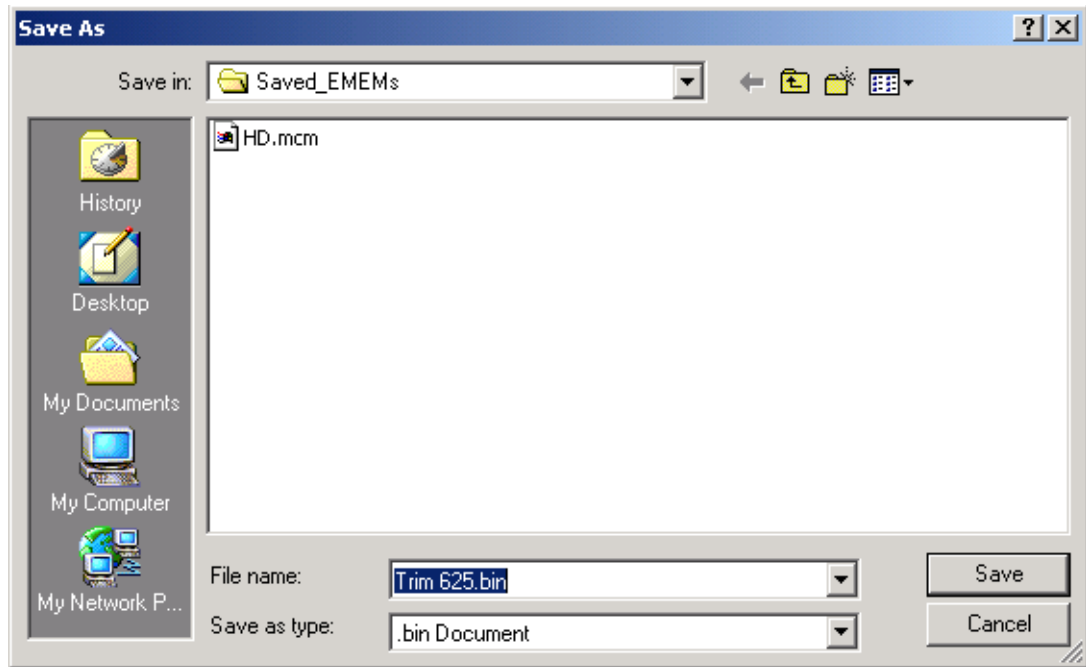

3. In the Save As dialog box, the file name will default to the E-MEM name. Browse to the folder where you want to save the configuration and select **Save**. The KAM-XM module files save as a .bin file type. Other Kameleon module types save as a .mcm file type.

Note You may rename the file during the Save process but the E-MEM name entered into the Local Operations window will not change on the web page to match the Save As name. Best practice is to leave the Save As file name the same as the E-MEM name.

To load a saved E-MEM from a location:

1. Select the **Load from ...** button in the File Operations section.
2. This will bring up the Load E-MEM page ([Figure 38](#)).

Figure 38. Load E-MEM Page

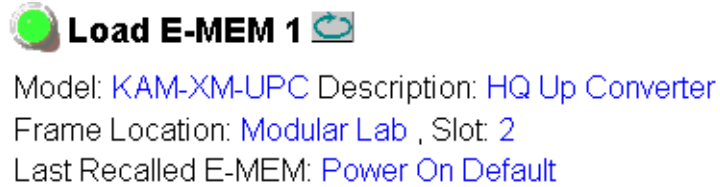

Load file Into E-MEM1...

Enter filename:

3. Select **Browse** to open the Choose File window ([Figure 39](#)). Browse to the location of the file you wish to load and select the .bin file then the **Open** button to load the file or enter the filename and path in the Enter filename box.

Figure 39. Choose File Window

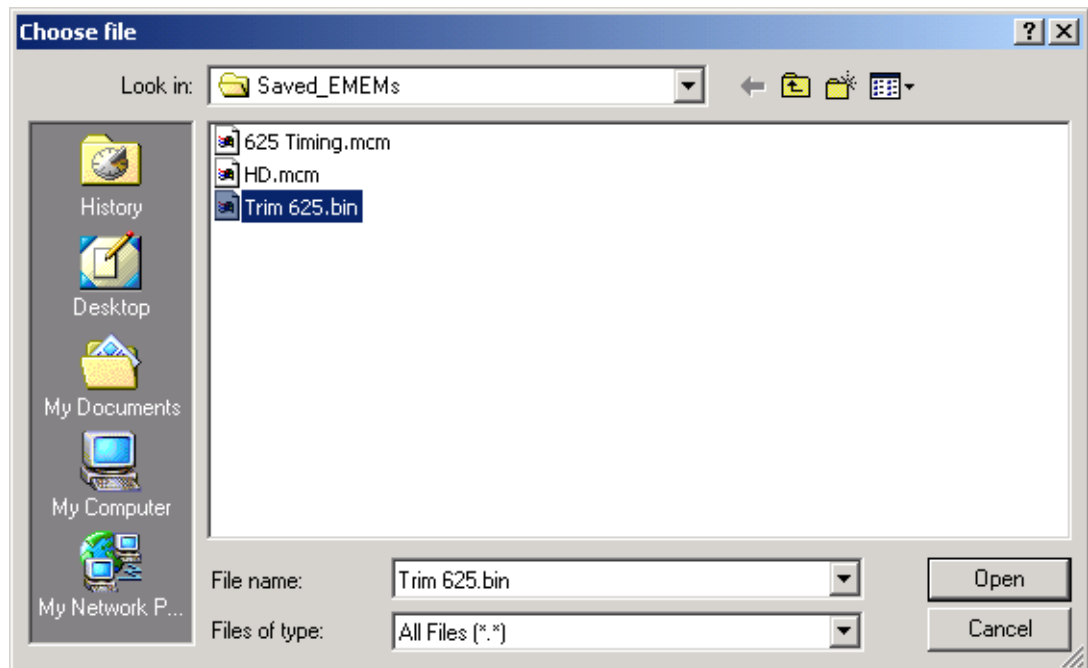

4. Once the correct path and filename is loaded, select the **Load** button on the Load E-MEM page.
5. This should place the recalled E-MEM file into the corresponding E-MEM window.
6. Select the corresponding **Recall** button to invoke this configuration.

Note After a power cycle (module is removed and replaced), E-MEM will default to Power On Default regardless of the last E-MEM recalled.

Slot Config Web Page

- [Advanced Aperture](#)
 - [Color Legalizer](#)
 - [Grain Insertion](#)
 - [GPI](#)
 - [E-MEM](#)
 - [Slot Config](#)
- Use this link

Use the Slot Config web page (Figure 40) to perform the following functions on the module:

- **Slot Identification** – You may identify the module by typing a specific name in the **Name** field. The assigned name is stored on the 2000NET module and travels with the 2000NET module if it is moved to another frame. Select **Default** to enter the factory default module name.
- **Locate Module** – selecting **Flash** from the **Locate Module** pulldown flashes the yellow COMM and CONF LEDs on the front of the module so it can be located in the frame.

Figure 40. Slot Config Web Page

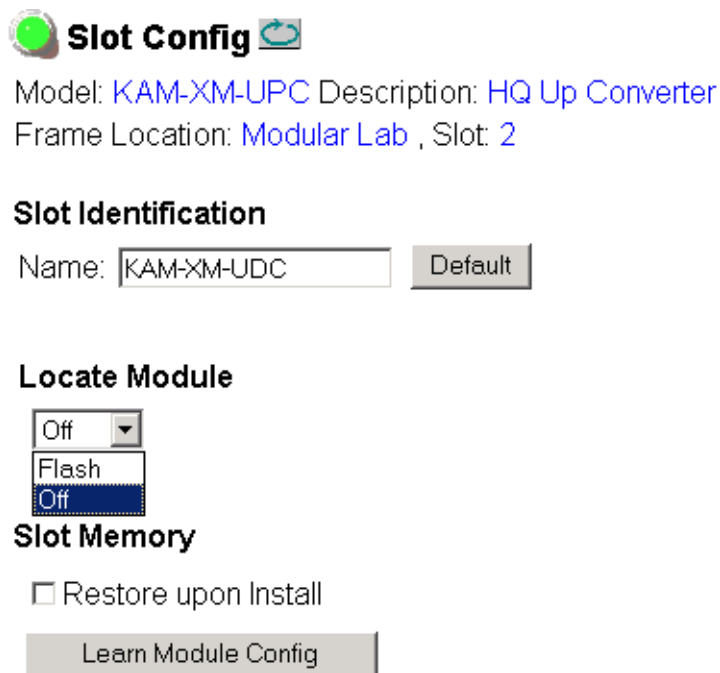

[Frame Health Reports](#)

[SNMP Trap Reports](#)

- **Slot Memory** – the slot configuration for each media module is automatically saved periodically (once an hour) to the 2000NET module in that frame. You may also select the **Learn Module Config** button at any time to save the current configuration for this slot. The configuration is saved on the 2000NET module. If the 2000NET module is removed or powered down, the stored configurations are not saved.

- When the **Restore upon Install** box has been checked, the current configuration saved to this slot is saved as slot memory. When the current module is removed and another module of the same type and software version is installed, the configuration saved to the 2000NET module will be downloaded to the new module. The box must be checked before the current module with the saved configuration is removed.

If a different type of module is installed in this slot, a warning message will state that the original module type has been replaced with another module type. In this case, a **Clear** button will appear allowing you to clear the stored configuration from the previous module.

Note Uncheck the **Restore Upon Install** button before downloading new software.

- **Frame Health Reports Link** – will appear only on a module installed in a 2000T3 (3 RU) frame. Select the Frame Health Reports link to open the 2000NET module Frame Alarm Reporting web page. This web page allows configuration of what alarms and warnings are reported to the external Frame Health Alarm connector on the rear of the frame.

Note This page is only present on the 2000T3 frame. The 2000T1 frame does not have an external Frame Health alarm.

This web page contains the following sections:

- **Hardware Switch Status** – the Hardware Switch Status section of this web page displays the current settings of the alarm and warning configuration DIP switches, S1 and S2, on the 2000NET circuit board in this frame. These switches allow enabling and disabling of what overall status reporting information is provided to the external Frame Alarm.
- **Output Format for Warnings** – set the Output Format for Warnings on the external RS-232 Frame Alarm output on the rear of the frame. When the **Open** radio button is selected, warnings are not reported to the external frame alarm. Selecting the **Closed** radio button, causes warnings to be reported in the same manner as alarms.
- **Frame Health Reporting** – this section provides a table showing the presence and status of all frame devices such as modules, power supplies, and fans and other frame functions such as Module Health and Frame Bus status. Use the corresponding **Report** check-boxes to indicate which alarms and warnings should be reported to the Frame Health alarm for the following conditions:
 - Faults
 - Signal Loss
 - Reference Loss
 - Config Error

- **SNMP Trap Reports Link** – select the SNMP Trap Reports link to open the 2000NET SNMP Reporting web page. This link will only be present when SNMP Agent software has been installed on the 2000NET module. This web page allows configuration of what alarms and warnings are reported to the SNMP management software.
- **Hardware Switch Status** – the Hardware Switch Status section of this web page displays the current settings of the alarm and warning configuration DIP switches, S1 and S2, on the 2000NET circuit board in this frame. These switches allow enabling and disabling of what overall status reporting information is provided to the SNMP traps.

Note Slot SNMP traps can be enabled only when the hardware switches for Module Fault reporting and Asynchronous Status reporting are in enabled on the 2000NET module (dipswitch S1 segment 7 and dipswitch S2 segment 1).

- **SNMP Trap Reporting** – this section provides a table showing the presence and/or status of all frame devices such as modules, power supplies, power and fan sleds and other frame functions such as fan and Frame Bus status.

Use the corresponding **Report** checkboxes to indicate what trap warnings and alarms should be reported to the SNMP manager for the following conditions:

- Faults
- Devices removed
- Signal Loss
- Reference Loss
- Config Error

The enabled SNMP traps will be reported to any SNMP manager that is identified as an SNMP Report Destination in 2000NET configuration. Trap severity is read-only hard-coded information that is interpreted and responded to by the SNMP Manager software configuration.

Refer to the *2000NET Instruction Manual* for complete details on using the 2000NET web pages.

Software Updating

Software updating for the KAM-XM modules is done using the NetConfig Networking application available from the Thomson Grass Valley ftp site or Customer Service data base as described in this section. It is recommended to use the latest available version of NetConfig for software updating.

Note Kameleon 2000 frames with a 2000NET module running version 4.0.0 and later will no longer provide a Software Update web page.

Acquiring NetConfig Software

If you do not have NetConfig or the latest version, you can download it from the Thomson Grass Valley ftp site at this URL:

<ftp://ftp.thomsongrassvalley.com/pub/router/NetConfig/Version 2.0.6/>

1. Right-click on the latest NetConfig link to download the zipped file to the C:\temp folder or other convenient location on your PC.
2. Extract the zipped files onto your local drive:
3. Double-click on the NetConfig.EXE file to install NetConfig.

Note Installing NetConfig into the default location given in the install script (C:\Programs\Grass Valley Group) is recommended for future NetConfig and module software updates.

Acquiring the Latest KAM-XM Software

To acquire the latest Kameleon software, connect to the Grass Valley Customer Service FAQ database from the following URL:

<http://gvg.custhelp.com>

This will take you to the Grass Valley Customer Service FAQ data base. The information provided here is the most up-to-date. You may also subscribe to software updates through the FAQ site. This is recommended so that when new versions of software are released, you are notified by email.

If you cannot find the software you need here, go directly to the Grass Valley Customer FTP site at the following URL:

<ftp://ftp.thomsongrassvalley.com/pub/modular>

To download the latest Kameleon HD software from either the Customer Service database or the ftp site, do the following:

1. Navigate to the Customer Service FAQ site and click on the first FAQ, DOWNLOAD THE LATEST SOFTWARE?

2. Select the 2000 Series link.
3. Select the link to the latest Kameleon module software.
4. Select the link to the KAM-XM software.

If using the ftp site, enter the URL below to access the software directly:

`ftp.thomsongrassvalley.com/pub/modular/Kameleon/KAM-XM`

5. Follow the instructions below to update the software.

Software Updating With NetConfig

To use this method, your 2000NET module must be running version 3.2.2 or later and you must have the NetConfig Networking Application option running on a networked PC on the same subnet as the frame with the 2000NET module. Seven files are required for updating software, six .fld files and an .sw2 for the module being updated.

To use NetConfig for software updating, follow the steps below:

1. Begin the upgrade procedure by moving the KAM-XM files you have downloaded into your Temp directory into the correct NetConfig directories (these steps apply to all versions of NetConfig).
2. Copy all KAM-XM software download files from the C:\temp directory into the main NetConfig directory on your PC. This is normally in the default location in C:\Program Files\Grass Valley Group\NetConfig.

If you have installed NetConfig in another location, find the location of the NetConfig directory by right-clicking on the NetConfig shortcut. Select **Properties** and note the location in the **Start In** field. Download the package to the NetConfig directory.

3. In the main NetConfig directory, locate a folder named **modular**. If this folder does not exist, create a folder called **modular** in the main NetConfig directory.
4. Move the six .fld files you copied into the main NetConfig directory into this **modular** directory.
5. Verify that the KAM-XM_X.X.X.sw2 file is somewhere in the main NetConfig directory (not in the **modular** directory).

Note NetConfig reads each .sw2 file in its main directory and navigates to the directory given in these files to find the .fld files available. The .sw2 file should not have a .txt extension or NetConfig will not recognize it. There may be a number of .sw2 and .fld files in your NetConfig directory for other modular products. These will not interfere with the update.

CAUTION During the download, the module will have no video output, so be sure the module is off-air before upgrading.

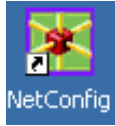

6. Open NetConfig.

Note If you have not used NetConfig before, refer to the *NetConfig Instruction Manual* included during installation in the main NetConfig directory in pdf format (NetConfig.pdf).



7. Click on the **Load SW** button on the top of the NetConfig toolbar.

8. This will bring up the Load Software screen (Figure 41). This screen shows the latest version as of NetConfig currently available, version 2.0.6. If you are using an earlier version of NetConfig, the file structure is slightly different, but the files versions are the same.

Figure 41. NetConfig Load Software Screen – First .fld Download

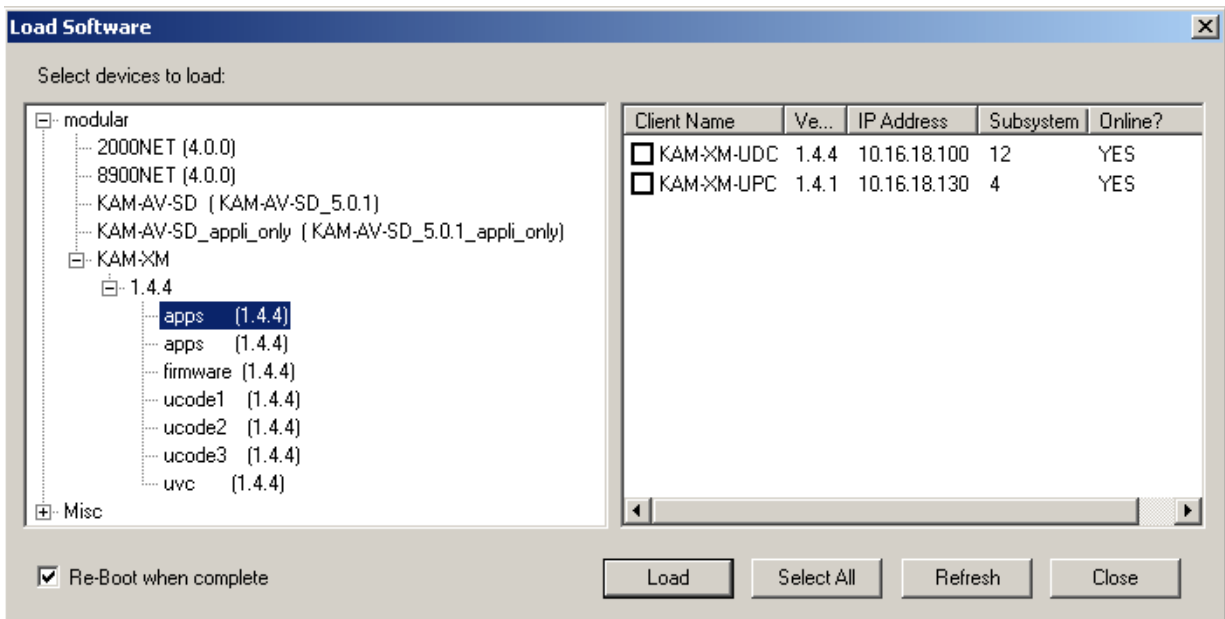

9. Open the **KAM-XM** directory.

The following files should appear in the KAM-XM directory, all reporting the same software version represented here by X.X.X:

- apps (X.X.X)
- firmware (X.X.X)
- ucode1 (X.X.X)
- ucode2 (X.X.X)
- ucode3 (X.X.X)
- uvc (X.X.X)

Note Previous software updates may also be present in the modular folder and may appear in the KAM-XM directory

10. Highlight the **apps** Device Type. All KAM-XM modules accessible on this subnet will be displayed in the window on the right with their current software version and frame IP Address.
11. Find the KAM-XM module you are updating in the Client Name list. Check the corresponding checkbox in the window on the right to indicate you wish to update this device.

Note You may upgrade all modules at once with this application by checking all of the Client Name checkboxes. We recommend upgrading one module first to understand the process before attempting to upgrade all of the modules at once.

12. Check the **Re-Boot when complete** checkbox in the lower left corner of the screen.
13. Click on the **Load** button to begin the update.
14. If the load has been successful, a popup will appear as shown in [Figure 42](#). Click the **OK** button.

Figure 42. Load Successful Popup

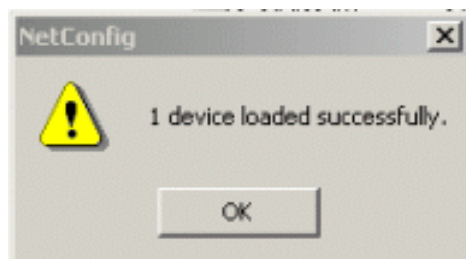

15. Allow the reboot to complete.
16. Bring up NetConfig again and click on the **Discover** button in the top menu bar. Then click on the **Load SW** button.
17. Select the **firmware** Device Type on the left ([Figure 41 on page 70](#)).
18. Select the same Client Name as the first download.
19. Check the **Re-Boot when complete** checkbox in the lower left corner of the screen.
20. Press the **Load** button to download the firmware to the KAM-XM module selected.
21. If the load has been successful, a popup will appear as shown in [Figure 42 on page 71](#). Click the **OK** button.

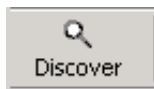

22. Allow the reboot to complete.
23. Bring up NetConfig again and click on the **Discover** button in the top menu bar. Then click on the **Load SW** button.
24. Select the **ucode1** Device Type on the left.
25. Select the same Client Name as the first download.
26. Complete the same steps for the rest of the .fld files listed, allowing the reboot to complete each time.
27. Verify that all downloads were successful by checking the Download Status table on the Status web page ([Figure 19 on page 40](#)).

For more information on using NetConfig, refer to the *NetConfig Networking Application Instruction Manual* which is included with the option, available on the Thomson Grass Valley web site, and may also be present in the NetConfig directory during some NetConfig installations (Newton Control Panel installation is one example).

Specifications

Table 6. KAM-XM Series Specifications

Parameter	Value
SD/HD Video Input	
Standard	
KAM-XM-UNC KAM-XM-UPC	SMPTE 259-C (270 Mb/s)
KAM-XM-UDC	SMPTE 259-C (270 Mb/s), SMPTE 292M (1.5 Gb/s), SMPTE 274M, SMPTE 296M, SMPTE 349M
KAM-XM-DNC	SMPTE 292M (1.5 Gb/s), SMPTE 274M, SMPTE 296M, SMPTE 349M
Number of inputs	1 with active loop-through
Connector	BNC per IEC 60169-8 Amendment 2
Equalization	
KAM-XM-UNC KAM-XM-UPC	Automatic to 300 m @ 270 Mb/s with Belden 1694 or equivalent cable
KAM-XM-UDC	Automatic to 100 m @ 1.5 Gb/s/300 m @ 270 Mb/s with Belden 1694 or equivalent
KAM-XM-DNC	Automatic to 100 m @ 1.5 Gb/s with Belden 1694 or equivalent cable
Return Loss	> 15 dB @ 270 Mb/s (and 1.5 Gb/s)
Active Input Loop-through Output	
Standard	
KAM-XM-UNC KAM-XM-UPC	SMPTE 259-C (270 Mb/s)
KAM-XM-UDC	SMPTE 259-C (270 Mb/s), SMPTE 292M (1.5 Gb/s), SMPTE 274M, SMPTE 296M, SMPTE 349M
KAM-XM-DNC	SMPTE 292M (1.5 Gb/s), SMPTE 274M, SMPTE 296M, SMPTE 349M
Number of outputs	1
Connector	BNC per IEC 60169-8 Amendment 2
DC offset	0 V \pm 0.5 V
Rise and fall time	750 ps nominal for SD
Overshoot	< 10% of amplitude
Return loss	> 9 dB @ 1.5 Gb/s
Wideband jitter	< 0.2 UI
Up/Down Converted Serial Video Output	
Standard	
KAM-XM-UNC KAM-XM-UPC KAM-XM-DNC	SMPTE 292M (1.5 Gb/s)
KAM-XM-UDC	SMPTE 259-C (270 Mb/s) or SMPTE 292M (1.5 Gb/s)
Number of outputs	2
Connector	BNC per IEC 60169-8 Amendment 2
DC offset	0 V \pm 0.5 V
Rise and fall time	750 ps nominal for SD
Overshoot	< 10% of amplitude
Return loss	> 15 dB @ 270 Mb/s, > 9 dB @ 1.5 Gb/s
Wideband jitter	< 0.2 UI

Table 6. KAM-XM Series Specifications - (continued)

Parameter	Value
Input to Output Processing Delay	
Video delay	
KAM-XM-UNC KAM-XM-UPC KAM-XM-UDC	4 frames (up conversion)
KAM-XM-UDC KAM-XM-DNC	2 frames (down conversion)
Audio delay	Delayed and re-embedded in time with the output video
Electrical	
Power	27 W
EMI/RFI	Complies with FCC Part 15 Class A, EU EMC Directive
Physical	
Number of slots	2, installation in even numbered frame slots recommended for maximum frame density
Environmental	
Operating temperature range	See specifications for Kameleon 2000 frame
Non-operating Temperature	-10 to 70 ° C
Operating Humidity Range	10 to 90% non condensing

Service

The KAM-XM modules make extensive use of surface-mount technology and programmed parts to achieve compact size and adherence to demanding technical specifications. Circuit modules should not be serviced in the field unless as directed by Grass Valley Customer Service.

Power-up Diagnostics Failure

If the module has not passed self-diagnostics, do not attempt to troubleshoot. Return the unit to Grass Valley (see [Module Repair](#)).

Troubleshooting

If your module is not operating correctly, proceed as follows:

- If module power is not present, check fuse F1 (see [Figure 43](#)).
- Check for presence and quality of input signals.
- Verify that source equipment is operating correctly.
- Check cable connections.

Figure 43. KAM-XM Voltage Testpoints and Fuse Location

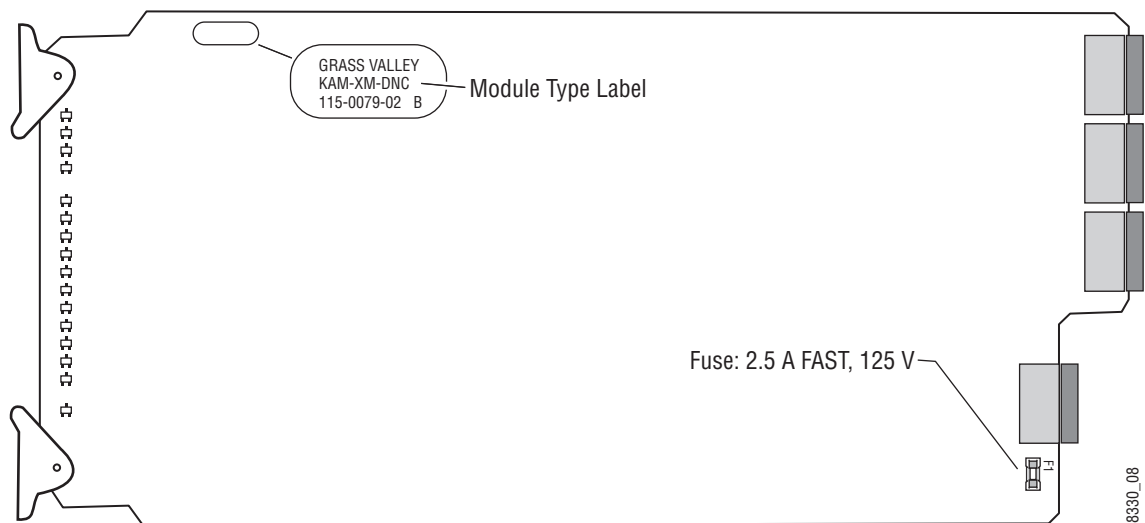

Module Repair

If the module is still not operating correctly, replace it with a known good spare and return the faulty module to a designated Grass Valley repair depot. Call your Grass Valley representative for depot location. Refer to [Contacting Grass Valley](#) at the front of this document for the Grass Valley Customer Service Information number.

Index

Numerics

- 2000GEN module [10](#)
- 2000NET module requirements [10](#)

A

- Advanced Aperture web page [55](#)
- anti-alias filter
 - overview [25](#)
 - remote control [49](#)
 - summary table [31](#)
- App Configuration
 - overview [22](#)
 - remote control [44](#)
 - summary table [30](#)
- application loading message [44, 46](#)
- aspect ratio
 - anamorphic
 - definition [23](#)
 - common sides
 - definition [24](#)
 - common top & bottom
 - definition [23](#)
- FlexView
 - definition [24](#)
 - overview [23](#)
 - remote control [46](#)
 - summary table [31](#)
- Aspect web page [46](#)
- AUD PRSNT LED [20](#)

B

- Blanking
 - VBI lines [42](#)
- Boost
 - overview [26](#)
 - summary table [32](#)
- boot up time [19](#)
- brickwall filter

- overview [26](#)
 - remote controls [51](#)
 - summary table [32](#)
- Brickwall web page [51](#)

C

- cabling [16](#)
- CH1 STAT LED [20](#)
- Clear button [66](#)
- closed caption
 - setting line [42](#)
 - summary table [30](#)
- Coarse adjust button
 - overview [36](#)
- color legalizer
 - overview [29](#)
 - remote control [56](#)
 - summary table [32](#)
- Color Legalizer web page [56](#)
- COMM LED [20](#)
- configuration
 - overview [21](#)
 - summary table [30](#)
- control panel
 - mneumonics [30](#)
- conversion rates [9](#)
- conversion, format
 - overview [22](#)
 - summary table [30](#)
- conversion, up and down
 - overview [21](#)

D

- deinterlace type [44](#)
 - overview [22](#)
 - summary table [31](#)
- Detail Enhance web page [49](#)
- detail enhancement
 - overview [25](#)

- remote controls 49
- summary table 31

documentation online 2

E

E-MEM

- advanced view 59
- description 59
- load from file 63
- save to file 62
- standard view 59
- web page 59

environmental 74

F

factory defaults

- recall factory defaults 59
- recall factory names 59
- summary table 30

FAQ database 2

FAULT LED 20

fault table 20

FBREF ERR LED 20

Fine adjust button

- overview 36

FlexView

- aspect ratio, overview 24

format conversion 44

Format web page 44

Frame Health Reporting 66

frame, 1 RU 13

frame, 3RU 12

frequently asked questions 2

FRM LOCK LED 20

front module

- installation 15

front panel LEDs 19

fuse

- location and type 75

G

Genlock Offset

- remote control 42

- summary table 30

GPI (General Purpose Interface)

- configuring inputs 58
- Connector J5 wiring 18
- overview 29

GPI web page 58

Grain Insertion web page 57

Grass Valley web site 2

GUI 38

I

IFF ERR LED 20

input

- cabling 16

installation 12

K

KAM-XM module

- descriptions 8
- functionality summary 7

KAM-XM-DNC

- cabling 17
- description 8

KAM-XM-UDC

- cabling 17
- description 8

KAM-XM-UNC

- cabling 17
- description 8

KAM-XM-UPC

- cabling 17
- description 8

L

LEDs

- meanings 20

License web page 41

locate module 65

M

media module 12

midplane 15

Mosquito web page [55](#)

N

Newton Control Panel
overview [33](#)

O

OFF ERR LED [20](#)
online documentation [2](#)
operational modes [20](#)
outputs
 cabling [16](#)

P

passive rear module [12](#)
 installation [12](#)
PixelMotion
 deinterlace type [31, 44](#)
Preset 0 [59](#)
presets
 overview [29](#)
proc amp
 overview [25](#)
 remote control [48](#)
 summary table [31](#)
ProcAmp web page [48](#)
PWR LED [20](#)

Q

Quick Start guide [11](#)

R

rear module
 cabling [16](#)
red overlay
 overview [27](#)
 remote control [52](#)
reference
 selecting [42](#)
Refresh button [36](#)
repair depot [75](#)

RESET LED [20](#)
RP 177
 overview [25](#)
 proc amp control [48](#)
 summary table [31](#)

S

SEQ ACT LED [20](#)
Setup web page [42](#)
Slot Config web page [65](#)
slot identification [65](#)
slot memory [66](#)
SNMP reporting
 enabling [67](#)
software download from web [2](#)
software version [39](#)
source material
 input selection [44](#)
 summary table [31](#)
spike filter
 overview [26](#)
 remote control [50](#)
 summary table [32](#)
Spike web page [50](#)
status indicators
 color codes [39](#)
 meanings [39](#)
Status LEDs
 meaning [36](#)
Status web page [39](#)
system requirements [10](#)

T

TC PRSNT LED [20](#)
Temporal Recursive filter
 auto mode [52](#)
 Manual mode [53](#)
 overview [27](#)
 summary table [32](#)
Temporal Recursive web page [52](#)
testpoints [75](#)
troubleshooting [75](#)

U

UCREF ERR LED [20](#)

V

VBI blanking

 selecting lines [42](#)

 summary table [30](#)

Vert Interpolation

 deinterlace type [31, 44](#)

VOLT TRIP LED [20](#)

W

web browser overview [34](#)

web site documentation [2](#)

web site FAQ database [2](#)

web site Grass Valley [2](#)

web site software download [2](#)