

# 8990ARC

SD ASPECT RATIO CONVERTER MODULE

Instruction Manual

SOFTWARE VERSION 3.0.0

071803601  
DECEMBER 2004

*the most watched worldwide*

# Contacting Grass Valley

Region	Voice	Fax	Address	Web Site
North America	(800) 547-8949 Support: 530-478-4148	Sales: (530) 478-3347 Support: (530) 478-3181	Grass Valley P.O. Box 599000 Nevada City, CA 95959-7900 USA	www.thomsongrassvalley.com
Pacific Operations	+852-2585-6688 Support: 852-2585-6579	+852-2802-2996		
U.K., Asia, Middle East	+44 1753 218 777	+44 1753 218 757		
France	+33 1 45 29 73 00			
Germany, Europe	+49 6150 104 782	+49 6150 104 223		

Copyright © Thomson Broadcast and Media Solutions All rights reserved.

## Grass Valley Web Site

The [www.thomsongrassvalley.com](http://www.thomsongrassvalley.com) web site offers the following:

**Online User Documentation** — Current versions of product catalogs, brochures, data sheets, ordering guides, planning guides, manuals, and release notes in .pdf format can be downloaded.

**FAQ Database** — Solutions to problems and troubleshooting efforts can be found by searching our Frequently Asked Questions (FAQ) database.

**Software Downloads** — Software updates, drivers, and patches can be downloaded.

# Contents

- Preface**..... 5
  - About This Manual ..... 5
  - Introduction ..... 7
  - Installation ..... 8
    - Frame Capacity ..... 8
    - Module Placement in the 8900 Frame..... 8
    - Cabling ..... 10
      - Loop-through Input..... 10
      - Outputs ..... 10
      - General Purpose Interface (GPI) Connections..... 10
  - Power Up ..... 12
    - Operation Indicator LEDs ..... 12
  - Configuration..... 14
    - Output Format Control Summary ..... 14
      - Output Aspect Ratio ..... 14
      - Vertical Resizing..... 17
      - Output Conversion Modes..... 17
      - Video and VBI Line Handling ..... 18
    - Video Index Coding ..... 20
      - Modified Video Index Coding..... 21
      - Custom WSS/Video Index Coding..... 23
    - Wide Screen Signaling (WSS) ..... 24
      - WSS Line Selection..... 24
      - Standard Wide Screen Signaling ..... 24
      - Modified Wide Screen Signaling..... 25
      - Custom Wide Screen Signaling ..... 25
    - GPI Control..... 25
    - Configuration Summary..... 26
      - Newton Pan/Tilt Control..... 27
    - Onboard Configuration Switches and LEDs..... 29
      - Local On-board Module Configuration ..... 30
    - Remote Configuration and Monitoring ..... 31
      - 8900NET Module Information..... 31
      - Newton Control Panel Configuration..... 31
      - Web Browser Interface ..... 32
      - 8990ARC Links and Web Pages..... 34
  - Status Monitoring ..... 43
    - LEDs ..... 43
    - Frame Alarm ..... 44
    - Web Browser Interface ..... 44
      - SNMP Reporting ..... 45
  - Specifications ..... 46
  - Service..... 49
  - Functional Description..... 50
    - Input and Ancillary Data Processing ..... 50

*Contents*

Active Picture Processing .....	50
H & V Re-sizing Algorithm.....	51
Vertical Resize Filtering.....	51
Video Index Information Coding Support .....	51
<b>Index</b> .....	<b>53</b>

# *Preface*

## **About This Manual**

This manual describes the features of a specific module of the Gecko 8900 Signal Processing System. As part of this module family, it is subject to Safety and Regulatory Compliance described in the Gecko 8900 Series frame and power supply documentation (see the *Gecko 8900 Frames Instruction Manual*).



# *8990ARC SD Aspect Ratio Converter*

## **Introduction**

The 8990ARC converts between standard (4:3) and widescreen (16:9) SD video formats. Flexible aspect ratio control is provided on the module's front panel and through remote control using the 8900 web browser graphical user interface (GUI) and the Newton Control Panel.

The 8990ARC is compact and fits in the 8900 frame which holds up to 10 modules in 2 RU. It supports 270 Mb serial digital video with outputs referenced from the input signal.

Key features include:

- 270 Mb component serial digital input and output,
- Module is hot-swappable,
- Module settings are stored in non-volatile memory,
- Automatic 525/625 line selection based on video input,
- Passes horizontal ancillary data (HANC),
- Passes or blanks vertical interval ancillary data (VANC),
- Standard, modified, and custom Video Index Coding and Wide Screen Signaling (WSS) with selectable WSS line,
- GPI (general purpose interface) input can recall one of four user-defined preset settings,
- Selection of top and bottom one, two, or three active video lines as data lines, and
- Remote control and monitoring through the 8900 frame ethernet I/F and Newton Control Panel (with 8900NET module running software version 3.2.0 and later).

# Installation

Installation of the 8990ARC module is a process of:

- Placing the module in the selected frame slot, and
- Cabling and terminating signal ports.

The 8990ARC module can be plugged in and removed from an 8900 Series frame with power on. When power is applied to the module, LED indicators reflect the initialization process (see [Power Up](#) on page 12).

## Frame Capacity

The maximum number of 8900 modules allowed in a frame is determined by frame cooling capacity. [Table 1](#) provides the power capacity, cooling capacity, and maximum module count for the 8990ARC in each frame type.

Table 1. Power, Cooling, and Module Capacity of 8900 Frames

Capacity Calculated	8900T2 Frame	8900T2-F Frame	8900TX Frame	8900TF Frame	8900TFN Frame
Power (W)	60	60	100	100	100
Recommended Module Cooling (W)	30	60	30	90	90
8990ARC Modules	6	10	6	10	10

**Note** Module capacity figures assume no other modules are in the frame. If the maximum number of modules a frame can handle is less than ten, provide as much space between the modules as possible.

## Module Placement in the 8900 Frame

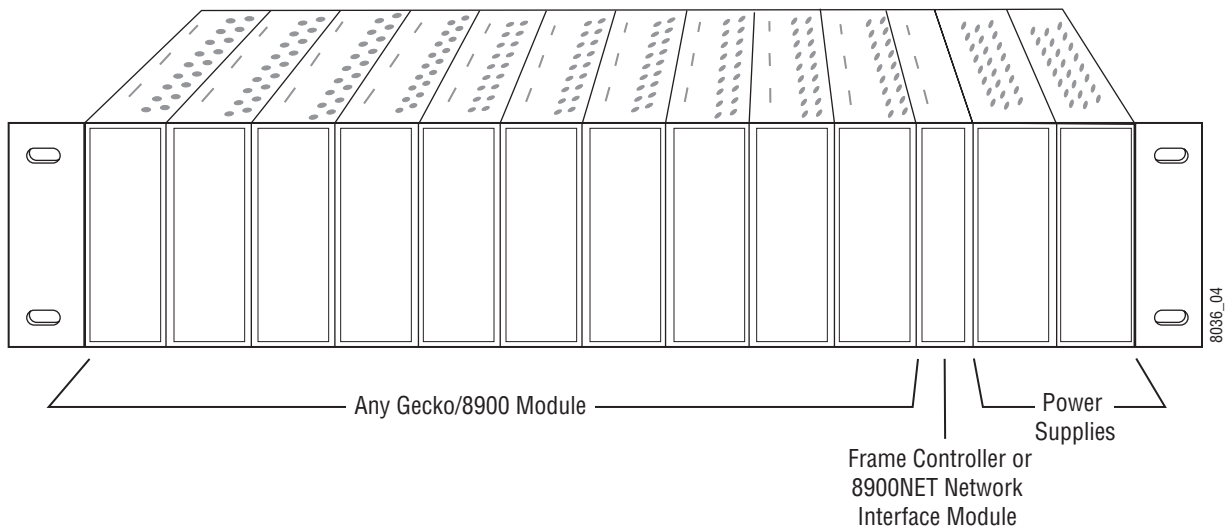
There are ten cell locations in the frame to accommodate either analog or digital modules. These are the left ten locations. Refer to [Figure 1](#) on page 9.

The two cells on the right are allocated for the power supplies. For additional information concerning the Power Supply module, refer to the 8900 Power Supply manual.

The third cell from the right is allocated for the Frame Monitor or Network Interface module. These modules provide health bus monitoring and control options.

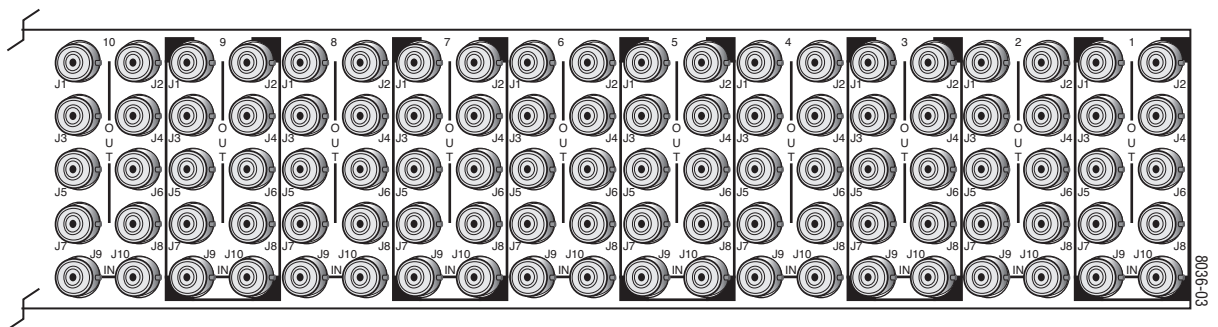


Figure 1. 8900 Series Frame



8900 modules are interchangeable within the module cells. There are 10 BNC connectors in each cell's I/O group. The functional assignment of each connector in a group is determined by the module that is placed in that cell. The maximum number of modules an 8900 frame can accept is ten. [Figure 2](#) illustrates the rear connector plate for an 8900 Series frame.

Figure 2. 8900 Series Frame Rear Connectors



To install a module in the frame:

1. Insert the module, connector end first, with the component side of the module facing to the right and the ejector tab to the top.
2. Verify that the module connector seats properly against the backplane.
3. Press the ejector tab in to seat the module in place.

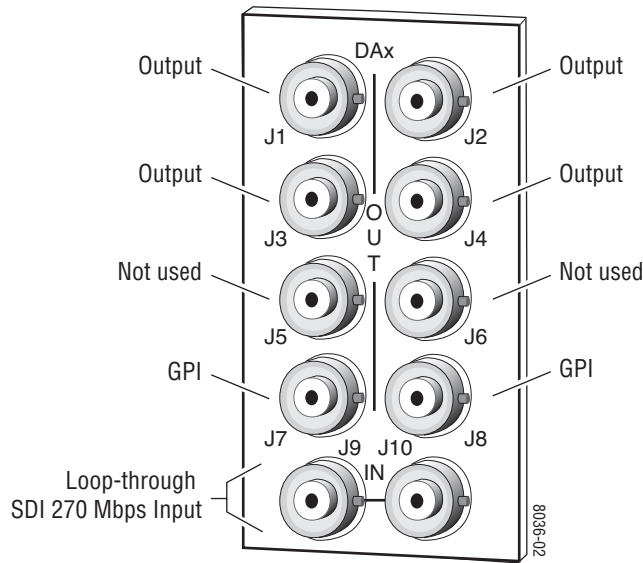
## Cabling

**Note** At the back of this manual (hard-copy only) are die-cut overlay cards that can be placed over the rear connector BNCs to identify the specific 8990ARC connector functions.

### Loop-through Input

Connect an input source to one of the loop-through input connectors, J9 or J10 (see Figure 3). The 8990ARC input accepts SMPTE 259M-C or EBU tech 3267 8- or 10-bit component serial digital video. Terminate the unused connector into 75Ω if the signal is not looped to other equipment.

Figure 3. 8990ARC Input, Output and GPI Connectors



### Outputs

The 8990ARC provides four 75 Ω component video output BNCs (J1 through J4).

The destination equipment should have a 75 Ω input impedance or loop through inputs that are terminated into 75 Ω.

### General Purpose Interface (GPI) Connections

BNCs J7 and J8 accept GPI control signals that select one of four user-defined preset settings that are stored using the onboard configuration controls or the remote GUI controls. The GPI can be used with a user-provided panel with four latching momentary switches and appropriate resistors. No tally is provided from the module.

## GPI Control

The GPI control input at BNCs J7 or J8 (not both) on the rear panel is a loop-through input to an A/D converter and a 1.21 K $\Omega$  resistor to +5 V. When the module's GPI function is enabled, the 8990ARC software will recognize a GPI input voltage level to select one of four stored user-defined modes. Looping the input to additional modules allows a single GPI signal to set them all (up to 10 modules).

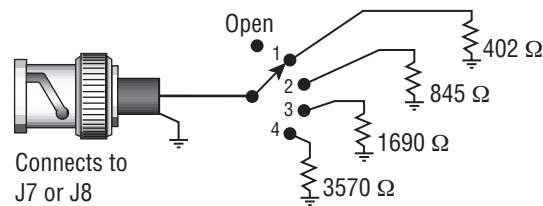
The GPI input is created by the application of a parallel resistor between the coax center and common ground that results in a voltage lower than +5 V to the A/D converter.

The following voltages (all  $\pm 0.4$  V) will select the GPI register indicated:

- 1.25 V = GPI 1
- 2.08 V = GPI 2
- 2.92 V = GPI 3
- 3.75 V = GPI 4

The resistors required for these voltages are shown in [Figure 4](#).

Figure 4. Typical GPI Input Circuit Diagram



Note:  
Resistor tolerance = 1%  
Only one GPI input can be used

8036\_07

# Power Up

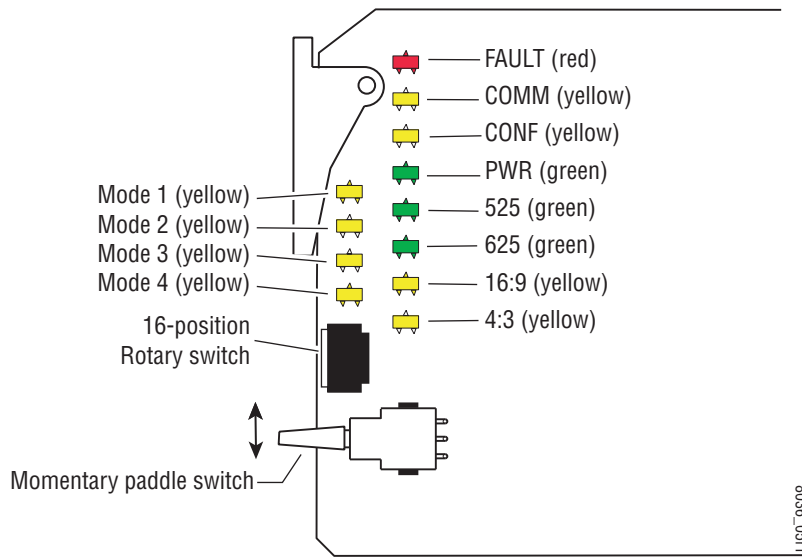
The various front LED indicators and configuration switches are illustrated in Figure 5. Upon power-up, the green PWR LED should light and the yellow CONF LED should illuminate for the duration of module initialization.

## Operation Indicator LEDs

With factory default configuration and a valid input signal connected, the green PWR LED, and one of the green signal standard LEDs (525 or 625) should illuminate (refer to Table 2 on page 13 to see the possible operating indicator combinations).

Video input presence is indicated by the appropriate 525 or 625 LED (indicating a 525-line or 625-line input signal has been detected). The appropriate Mode LED is on.

Figure 5. LEDs and Configuration Switches



A red FAULT LED indicates an error situation and, with the previously described LEDs, can indicate the operational conditions presented in Table 2.

Table 2. Indicator LEDs and Conditions Indicated

LED	Indication	Condition
<b>FAULT (red)</b>	Off	Normal operation
	On continuously	Module has detected internal fault
	Short flash	EDH errors will cause short flashes. In most applications a few, infrequent EDH errors will not be of consequence. Continuous EDH errors result in obvious output signal degradation.
<b>COMM (yellow)</b>	Off	No activity on frame communication bus
	Long flash	Location Command received by the module from a remote control system
	Short flash	Activity present on the frame communication bus
<b>CONF (yellow)</b>	Off	Module is in normal operating mode
	On continuously	Module is initializing, changing operating modes or updating firmware
	Flashing	Indicates rate of change of paddle switch controlled analog setting. The longer the switch is held, the more the flashing rate and the change-of-setting rate increases
<b>PWR (green)</b>	Off	No power to module or module's DC/DC converter failed
	On continuously	Normal operation, module is powered
<b>525 (green)</b>	Off	Input signal is 625 standard or no signal is present
	On continuously	Input signal is 525 standard and present
<b>625 (green)</b>	Off	Input signal is 525 standard or no signal is present
	On continuously	Input signal is 625 standard and present
<b>16:9 (yellow)</b>	Off	4:3 mode is selected
	On	16:9 mode is selected
<b>4:3 (yellow)</b>	Off	16:9 mode is selected
	On	4:3 mode is selected
<b>Mode 1 (yellow)</b>	Off	Another mode is selected
	On	Mode 1 is selected
<b>Mode 2 (yellow)</b>	Off	Another mode is selected
	On	Mode 2 is selected
<b>Mode 3 (yellow)</b>	On	Another mode is selected
	Off	Mode 3 is selected
<b>Mode 4 (yellow)</b>	On	Another mode is selected
	Off	Mode 4 is selected

# Configuration

The 8990ARC can be configured locally using onboard switches or remotely using the 8900NET GUI interface or the Newton Control Panel. A summary of all functions available with each control type along with the ranges and default values for each parameter is given in [Table 8 on page 26](#). The configuration of the 8990ARC determines:

- Output aspect ratio (16:9/4:3),
- Display conversion modes: (see [Output Conversion Modes on page 17](#)),
  - Bypass (no conversion),
  - Pillarbox for 16:9 output or Letterbox for 4:3 output,
  - Full Width for 16:9 output or Full Height for 4:3 output,
  - 14:9 output,
- High or Low vertical resizing filtering – for vertical black/white or severe chroma transitions,
- Position of converted outputs on the monitor (Tilt for vertical and Pan for horizontal positioning),
- Blanking or passing of vertical ancillary data (VANC),
- Number of active video lines selected as data lines (None, 1, 2, or 3),
- Enable one of three Video Index Control modes allowing control from data within the video input signal,
- Enable one of three Wide Screen Signaling (WSS) Control modes allowing control from video source data and selection of WSS line (lines 13-27),
- Enable/disable of GPI control,
- Save/Recall of user-defined configurations for each of four GPI and one non-GPI controlled memory register, and
- Recall of factory default settings.

## Output Format Control Summary

The output format from the module can be resized by selecting an aspect ratio, a conversion mode, and setting vertical resizing.

### Output Aspect Ratio

The output aspect ratio can be selected with the web page, Newton control panel, local controls, or through the GPI registers as either 16:9 or 4:3. [Figure 6 on page 15](#) and [Figure 7 on page 16](#) illustrate the output conversions for both 4:3 and 16:9 formats.

Figure 6. 4:3 Picture Input to 16:9 Conversion Options

INPUT - 4:3



CONVERSION

Mode 1, Bypass  
Complete picture with horizontal stretch




← Shift horizontally →

Mode 2, Pillarbox  
Complete picture with no distortion;  
Position left, center, or right (Pan)



Mode 3, Full Width  
Top and bottom cropping;  
Position top, center, or bottom (Tilt)

 = lost picture



↑  
Shift vertically  
↓

← Shift horizontally →

Mode 4, 14:9  
Top and bottom cropping;  
Position left, center, or right (Pan)


 = lost picture



Figure 7. 16:9 Picture Input to 4:3 Conversion Options

INPUT - 16:9

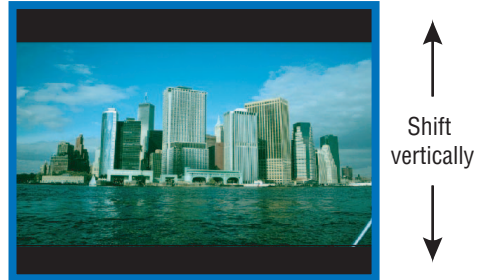


CONVERSION


Mode 1, Bypass  
Complete picture with vertical distortion (objects appear taller)



Mode 2, Letterbox  
Complete picture in Letterbox format with blanking at top and bottom  
Position top, center, or bottom (Tilt)




Mode 3, Full Height  
Horizontal cropping  
Position left, center, or right (Pan)

 = lost picture



Mode 4, 14:9  
Vertical blanking  
Horizontal cropping  
Position top, center, or bottom (Tilt)

 = lost picture





## Vertical Resizing

The V Process BW control adjusts vertical sizing to correct filter ringing above and below the edge on video sources with high contrast or chroma saturated horizontal edges. Select **Low** to remove ringing in lines with vertical black/white or severe chroma transitions.

## Output Conversion Modes

One of four output conversion modes for either 4:3 or 16:9 output aspect ratio format can be selected with user controls as follows:

- For 4:3 format, 1 = Bypass, 2 = Letterbox, 3 = Full Height, 4 = 14:9, or
- For 16:9 format, 1 = Bypass, 2 = Pillarbox, 3 = Full Width, 4 = 14:9.

Examples of the conversion modes are shown in [Figure 6 on page 15](#) and [Figure 7 on page 16](#) for both 4:3 and 16:9 formats.

Control of the desired video output conversion mode can be from four sources:

- Web page, Newton Control Panel, or local control,
- GPI triggering of pre-programmed registers,
- Video Index Coding data on video input signal, or
- Wide Screen Signaling (WSS) on input signal.

When set for Remote/Local operation ([Figure 9 on page 29](#)), the web page, Newton Control Panel and local control settings are always enabled and always valid. GPI controls are based on these settings, stored in GPI registers, and triggered by the web page, local controls, or an customer-supplied external device. Video Index Coding and WSS may or may not be valid depending on the presence of information on the input signal. The status of both WSS and Video Index Coding is reported at all times for the input signal on the Settings web page in read-only form ([Settings Web Page on page 36](#)).

[Table 3](#) shows the output formatting control options and the resultant output processing for various input signals and controls enabled.

*Table 3. Input Combinations and Resulting Outputs*

<b>WSS Input &amp; Enable</b>	<b>Video Index Input &amp; Enable</b>	<b>GPI Input &amp; Enable</b>	<b>User Selected Control</b>	<b>Resulting Output Signal Processing Control</b>
Valid and enabled	Any condition	Any condition	Mode, format	WSS control
None or disabled	Valid and enabled	Any condition	Mode, format	Video Index control
None or disabled	None or disabled	Valid and enabled	Mode, format	GPI control
None or disabled	None or disabled	None or disabled	Mode, format	User selected processing

The output will change according to the last valid command from the highest priority enabled control. For example, consider a case where the Video Index is enabled and its input is invalid. The user sets the conversion mode with the control panel to Bypass which passes the Video Index signal through to the output. The Video Index input changes to valid and sets the conversion mode to Letterbox. The Video Index then becomes invalid again.

The output will remain at Letterbox until another valid enabled control changes the conversion mode. It will not revert back to the setting set with the control panel.

### **Tilt/Pan Control**

Tilt and pan controls for left and right, centering, and top and bottom positioning are provided depending on the Conversion mode selected.

## **Video and VBI Line Handling**

The module handles lines in the video input differently depending on whether the line is an active video or a vertical interval line.

Vertical interval lines (lines 1-20/264-283 in 525 or lines 624-23/311-336 in 625) are either passed to the output unchanged or blanked by the VBI Bypass circuit. This selection is made with the VANC Data control.

Active video lines (lines 21-263/284-525 in 525 or lines 24-310/337-623 in 625) are processed through a scaling circuit. Depending on the mode of the module and the line number, they are either passed to the output, replaced with a scaled version of part of the input active video, or replaced with black fill.

If, for example, the scaling circuit is magnifying the video vertically, all active lines are replaced with scaled lines and the portion of the scaled video that doesn't fit in to the active space is discarded.

If the scaling circuit is reducing the video vertically, all of the scaled video is displayed on the output and active lines that are not covered by the scaled video are blanked.

When information such as closed captioning data is present on one of the first three active video lines, (lines 21/284, 22/285, and 23/286 in 525 or lines 24/337, 25/338, and 26/339 in 625), these lines can be designated as data lines and will be treated as part of the vertical interval passing the data to the output when the VANC Data control is set to **Pass**.

This is done using the Data Lines control as follows:

- When the Data Lines control is set to 1, the first active line of video is treated as part of the vertical interval and passed to the output through the VBI Bypass circuit maintaining any data it contains.

In the active video scaling circuit, this first active video line is blanked before the active video is processed in the scaling circuit so that no non-video information will appear on the video output. The last active video line is also blanked to maintain symmetry on the video output.

- When the Data lines control is set to 2, the first 2 active lines of video are treated as part of the vertical interval in the VBI Bypass circuit. These first 2 lines of active video are blanked before the active video is processed in the scaling circuit. The last two lines of active video are also blanked before the scaling circuit to maintain symmetry on the video output.
- When set to 3, the first three lines of active video are treated as vertical interval lines in the VBI Bypass circuit. These first 3 lines of active video are blanked before the active video is processed in the scaling circuit. The last three lines of active video are also blanked before the scaling circuit to maintain symmetry on the video output.

For the exact line number of the lines that are blanked with the different Data Lines control settings for 525 and 625 line rates, refer to the parameter for *Active lines blanked before processing by scaling circuit* on page 47 in the Specifications section.

## Video Index Coding

In Video Index Coding, video source data can be inserted in the video input signal on lines 11 and 324 for 625, on lines 14 and 277 for 525, to identify the signal line standard and aspect ratio. If this information is present and the 8990ARC Video Index Control function is enabled in one of three Video Index Coding modes and the module output mode matches the input, the module will pass the signal as is. If the output mode does not match, the module will use the selected conversion mode (see [Output Conversion Modes on page 17](#)). The Video Index coding is passed through to the 8990ARC output unaltered.

This module supports three modes of Video Index Coding: Standard, Modified, and Custom.

### Standard Video Index Coding

Support for Standard Video Index Coding is based on the SMPTE RP-186 standard. In Standard mode, the three least significant bits (b0, b1, and b2) of the first byte (octet) contain the aspect ratio information of the video. Refer to [Table 4](#) for the definition and how this information is interpreted by the module. Note that the module ignores the line rate.

Table 4. Standard Video Index Coding

AID Value (b2, b1, b0)	Definition (AID)	Selected Output Format	Resulting Conversion Mode
000	No information	None	Mode 1:Bypass
001	525/59.94 4:3	4x3	Mode 1:Bypass
		16x9	Mode 2: Pillarbox
010	625/50 4:3	4x3	Mode 1:Bypass
		16x9	Mode 2: Pillarbox
011	Reserved	None	Mode 1:Bypass
100	Reserved	None	Mode 1:Bypass
101	525/59.94 16:9	4x3	Mode 2: Letterbox
		16x9	Mode 1: Bypass
110	625/50 16:9	4x3	Mode 2: Letterbox
		16x9	Mode 1: Bypass
111	Reserved	None	Mode 1:Bypass

## Modified Video Index Coding

In the Modified Video Index Coding (a revision of SMPTE RP-186 based on the ARDSPCI rev 1), the definition of the first byte (octet) of the Video Index data has been modified to hold additional information. The three least significant bits of this byte have not changed; they still contain the aspect ratio information of the video. Refer to [Table 5](#) for the definition of the first byte and how it is interpreted by the module. Note that the line rate is ignored by the module.

Table 5. Modified Video Index Coding – AID

AID Value	Definition	Resulting AID Status
000	No information	Invalid
001	525/59.94 4:3	4:3
010	625/50 4:3	4:3
011	Reserved	Invalid
100	Reserved	Invalid
101	525/59.94 16:9	16:9
110	625/50 16:9	16:9
111	Reserved	Invalid

The next three bits of the first octet of the Video Index (b3, b4, and b5) contain the intended aspect ratio of the active region of the video (ARD). [Table 6](#) shows how this data is defined as well as the resulting module operating mode for all combinations of selected output status and AID status from [Table 5](#).

**Note** The operating mode portion is only valid if Video Index control is enabled and there are not any valid, higher priority controls enabled.

Table 6. Modified Video Index Coding – ARD

ARD Value (b5, b4, b3)	Definition	Selected Output Format	AID Status	Resulting Module Mode
000	Active region same as coded frame	4x3	Invalid	Default to next highest priority control
			4:3	Mode 1: Bypass
			16:9	Mode 2: Letterbox
		16x9	Invalid	Default to next highest priority control
			4:3	Mode 2: Pillarbox
			16:9	Mode 1: Bypass
001	4:3	4x3	Invalid	Default to next highest priority control
			4:3	Mode 1: Bypass
			16:9	Mode 3: Full Height
		16x9	Invalid	Default to next highest priority control
			4:3	Mode 2: Pillarbox
			16:9	Mode 1: Bypass

Table 6. Modified Video Index Coding – ARD

ARD Value (b5, b4, b3)	Definition	Selected Output Format	AID Status	Resulting Module Mode
010	16:9	4x3	Invalid	Default to next highest priority control
			4:3	Mode 1: Bypass
			16:9	Mode 2: Letterbox
		16x9	Invalid	Default to next highest priority control
			4:3	Mode 3: Full Width
			16:9	Mode 1: Bypass
011	14:9	4x3	Invalid	Default to next highest priority control
			4:3	Mode 1: Bypass
			16:9	Mode 4: 14:9 Horizontal Crop
		16x9	Invalid	Default to next highest priority control
			4:3	Mode 4: 14:9 Top and Bottom Crop
			16:9	Mode 1: Bypass
100	Reserved	N/A	Invalid	Default to next highest priority control
101	4:3 with shoot and protect 14:9 center	4x3	Invalid	Default to next highest priority control
			4:3	Mode 1: Bypass
			16:9	Mode 4: 14:9 Horizontal Crop
		16x9	Invalid	Default to next highest priority control
			4:3	Mode 4: 14:9 Top and Bottom Crop
			16:9	Mode 1: Bypass
110	16:9 with shoot and protect 14:9 center	4x3	Invalid	Default to next highest priority control
			4:3	Mode 1: Bypass
			16:9	Mode 4: 14:9 Horizontal Crop
		16x9	Invalid	Default to next highest priority control
			4:3	Mode 4: 14:9 Top and Bottom Crop
			16:9	Mode 1: Bypass
111	16:9 with shoot and protect 4:3 center	4x3	Invalid	Default to next highest priority control
			4:3	Mode 1: Bypass
			16:9	Mode 3: Full Height
		16x9	Invalid	Default to next highest priority control
			4:3	Mode 2: Pillarbox
			16:9	Mode 1: Bypass

## Custom WSS/Video Index Coding

Custom coding allows selection of the conversion mode and tilt desired for each of the eight states of the least three significant bits (LSBs) of the first octet with the web page controls. When the Custom mode is selected, the LSB (Least Significant Bit) can be selected along with the desired output mode.

For Video Index Coding the output selections are as follows:

- 16x9 Output Selections
  - Bypass
  - Pillarbox
  - Full Width Top
  - Full Width Center
  - Full width Bottom
  - 14:9 Top
  - 14:9 Center
  - 14:9 Bottom
- 4x3 Output Selections
  - Bypass
  - Letterbox Top
  - Letterbox Center
  - Letterbox Bottom
  - Full Height
  - 14:9 Top
  - 14:9 Center
  - 14:9 Bottom

## Wide Screen Signaling (WSS)

Wide Screen Signaling (WSS) for 625 systems is also supported on this module. One of three WSS control modes can be selected: Standard, Modified, and Custom.

If WSS is enabled, the 8990ARC output conversion mode will be controlled according to this input data. If Video Index Control is also enabled, the WSS control, when present, will take precedence as explained in [Table 3 on page 17](#). WSS coding is passed through to the 8990ARC output unaltered.

### WSS Line Selection

According to the industry standard WSS protocol, in 625-line systems the video input signal can contain video source data on line 23. This module has been modified to allow the line containing source data to be selected as any line from 13-27. The module will only search for WSS data on the line selected by the WSS control on the web page, control panel, or local control.

### Standard Wide Screen Signaling

Support for standard WSS mode is based on the EN 300 294 V1.3.2 (1998-04) standard. [Table 7](#) shows the setting for the module based on the output mode selected and the contents of the Group 1 data in the WSS signal.

Table 7. Standard Wide Screen Signaling

Group 1 Value (b2, b1, b0)	Aspect Ratio Label	Position	Selected Output Format	Resulting Conversion Mode	Resulting Tilt/Pan
000	4:3	N/A	4x3	Mode 1: Bypass	Center
			16x9	Mode 2: Pillarbox	Center
001	14:9	Center	4x3	Mode 1: Bypass	Center
			16x9	Mode 4: 14x9	Center
010	14:9	Top	4x3	Mode 1: Bypass	Center
			16x9	Mode 4: 14x9	Top
011	16:9	Center	4x3	Mode 1: Bypass	Center
			16x9	Mode 3: Full Width	Center
100	16:9	Top	4x3	Mode 1: Bypass	Center
			16x9	Mode 3: Full Width	Top
101	> 16:9	Center	4x3	Mode 1: Bypass	Center
			16x9	Mode 3: Full Width	Center
110	14:9	Center	4x3	Mode 1: Bypass	Center
			16x9	Mode 4: 14x9	Center
111	16:9	N/A	4x3	Mode 2: Letterbox	Center
			16x9	Mode 1: Bypass	Center



## Modified Wide Screen Signaling

Support for the Modified WSS is based on a modified version of the Standard WSS described in [Standard Wide Screen Signaling on page 24](#). The changes (described in the L23 specification) redefine the Group 1 bits to match the AID bits of the Modified Video Index Coding specification. The Group 2 bits have been redefined to match the ARD of the Modified Video Index Coding. Both of these (AID/ARD) are described in [Modified Video Index Coding on page 21](#).

The operation of the module when the WSS control is enabled is the same as when the Video Index Coding is enabled except the control information is taken from a different part of the video and it is formatted differently.

## Custom Wide Screen Signaling

Custom Wide Screen Signaling allows selection of the conversion mode and tilt desired for each of the eight states of the least three significant bits of the first octet with the web page controls. When the Custom mode is selected, the LSB (Least Significant Bit) can be selected along with the desired output mode.

For WSS the output selections are the same as those listed for the Video Index Coding on [page 23](#).

## GPI Control

GPI control of four GPI registers can be enabled or disabled. Each register can be saved and recalled with local or remote controls. Once a register is saved, it can also be recalled with a GPI trigger from an external device. See [General Purpose Interface \(GPI\) Connections on page 10](#).

## Configuration Summary

Table 8 provides a complete summary of the 8990ARC functions and a comparison of the functionality available with each control type along with the ranges and default values for each parameter. Refer to the specific control type for more details on using each control.

Table 8. Summary of 8990ARC Configuration Functions

Function Type	Default	Range/Choices Resolution	Web Page/ Function Name	Rotary Switch Bank/Setting	Newton Panel
Output Format (aspect ratio)	16:9	16:9 or 4:3	Settings/ Output Format pulldown	1:1	OutptFmt
V Process BW (vertical resizing)	High	High or Low	Settings/ V Process BW pulldown	1:6	VProcBW
Conversion Mode	Pillarbox (16:9)	Bypass Pillarbox (16:9) or Letterbox (4:3) Full Width (16:9) or Full Height (4:3) 14:9	Settings/ Conversion Mode pulldown	1:2	ConvMode
Pan (horizontal)	Centered	Left, Centered, or Right	Settings/ Pan pulldown	1:3	Pan <sup>1</sup>
Tilt (vertical)	Centered	Top, Centered, or Bottom	Settings/ Tilt pulldown	1:3	Tilt <sup>1</sup>
VANC Data	Blanked	Blanked or Pass	Settings/ VANC Data pulldown	1:7	VANCDData
Data Line processing	None	None 1 Line 2 Lines 3 Lines	Settings/ Data Lines pulldown	1:5	DatLines
Video Index Control	Disable	Disable, Standard, Modified, or Custom	Settings/ Video Index Control pulldown	1:4 1:8	VidIdCtl
WSS Control	Disable	Disable, Standard, Modified, or Custom	Settings/ WSS Control pulldown	1:4 1:8	WSS Ctrl
WSS/Vid Input LSBs (Custom Conversion Mode selected in Conversion Mode pulldown)	000	000, 001, 010, 011, 100, 101, 110, 111	Settings/ WSS/Vid Input LSBs pulldown	N/A	N/A
Resulting 16x9 Mode (16x9 Output format selected)	No Change	No Change, Bypass, Pillarbox, Full Width Top, Full Width Center, Full Width Bottom, 14:9 Top, 14:9 Center, 14:9 Bottom	Settings/ Resulting 16:9 Mode pulldown	N/A	N/A

Table 8. Summary of 8990ARC Configuration Functions

Function Type	Default	Range/Choices Resolution	Web Page/ Function Name	Rotary Switch Bank/Setting	Newton Panel
Resulting 4x3 Mode (4x3 Output format selected)	No Change	No Change, Bypass, Letterbox Top, Letterbox Center, Letterbox Bottom, Full Height, 14:9 Top, 14:9 Center, 14:9 Bottom	Settings/ Resulting 4x3 Mode pulldown	N/A	N/A
WSS Line	Line 23	Line 13-27 Default can be set with local control	Settings/ WSS Line pulldown	1:F 1:9 <sup>2</sup>	WSSLine
GPI Control	Disable	Enable or Disable	Settings/ GPI Control pulldown	1:9 <sup>1</sup>	GPICtrl
Recall or Save User settings	–	Recalls or saves module setup	Save/Recall Settings/ <b>Recall or Save User Settings</b> button	1:E	N/A
Recall or Save GPI 1	–	Save or recall settings for GPI 1	Save/Recall Settings/ <b>Recall or Save GPI 1 Settings</b> button	1:A	N/A
Recall or Save GPI 2	–	Save or recall settings for GPI 2	Save/Recall Settings/ <b>Recall or Save GPI 2 Settings</b> button	1:B	N/A
Recall or Save GPI 3	–	Save or recall settings for GPI 3	Save/Recall Settings/ <b>Recall or Save GPI 3 Settings</b> button	1:C	N/A
Recall or Save GPI 4	–	Save or recall settings for GPI 4	Save/Recall Settings/ <b>Recall or Save GPI 4 Settings</b> button	1:D	N/A
Recall Factory Defaults	–	See Default column	Save/Recall Settings/ <b>Recall Defaults</b> button	1:F	N/A

<sup>1</sup> Refer to [Newton Pan/Tilt Control](#) below for special instructions on enabling these controls.

<sup>2</sup> This is a dual control: Paddle switch in the up position disables GPI control and sets WSS to default of Line 23.

## Newton Pan/Tilt Control

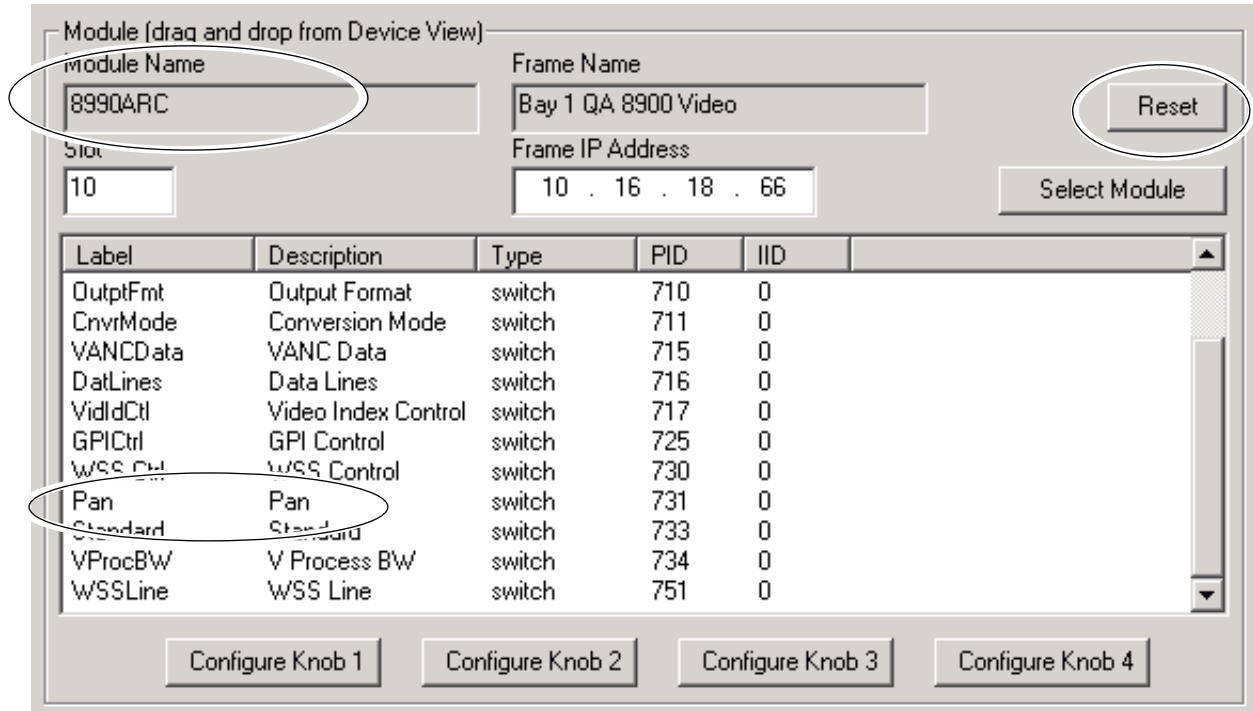
In the Newton Control System, only the **Pan** or the **Tilt** setting can appear at one time in the Newton Configurator module view. If both controls are needed on a Newton Control Panel configuration, do the following:

1. Set the Settings web page so that the **Pan** control is visible (16:9 – Pillarbox and 14:9 or 4:3 – Full Height).
2. Using NetConfig, click on the Newton Configurator icon (shown at left) at the top of the screen to open the application.



3. Drag the 8990ARC in the IP View on the left of the screen to the Module Name box (Figure 8). The current selection on the web page, **Pan**, should show up on the list.

Figure 8. Newton Control Panel Configurator – Pan and Tilt Controls



4. Configure a knob with this parameter as explained in the Newton Control System Instruction Manual.
5. Deselect the Newton icon to return to the Settings web page and change the control to **Tilt** (16:9 – Full Width, 4:3 – Letterbox and 14:9).
6. Select the Newton Configurator icon then the **Reset** button in the upper right corner of the Module view as shown in Figure 8. This will clear the parameter view.
7. Drag the 8990ARC into the Module Name box again and find the **Tilt** control in the list.
8. Configure another knob with the **Tilt** control.
9. Proceed with Newton configuration as explained in the Newton instruction manual.

**Note** During Newton Control Panel operation, the two knobs will interact due to linking in a software register.

## Onboard Configuration Switches and LEDs

The 8990ARC module can be configured using the on-board rotary and paddle switches shown in Figure 9. The CONF LED is a configuration status indicator.

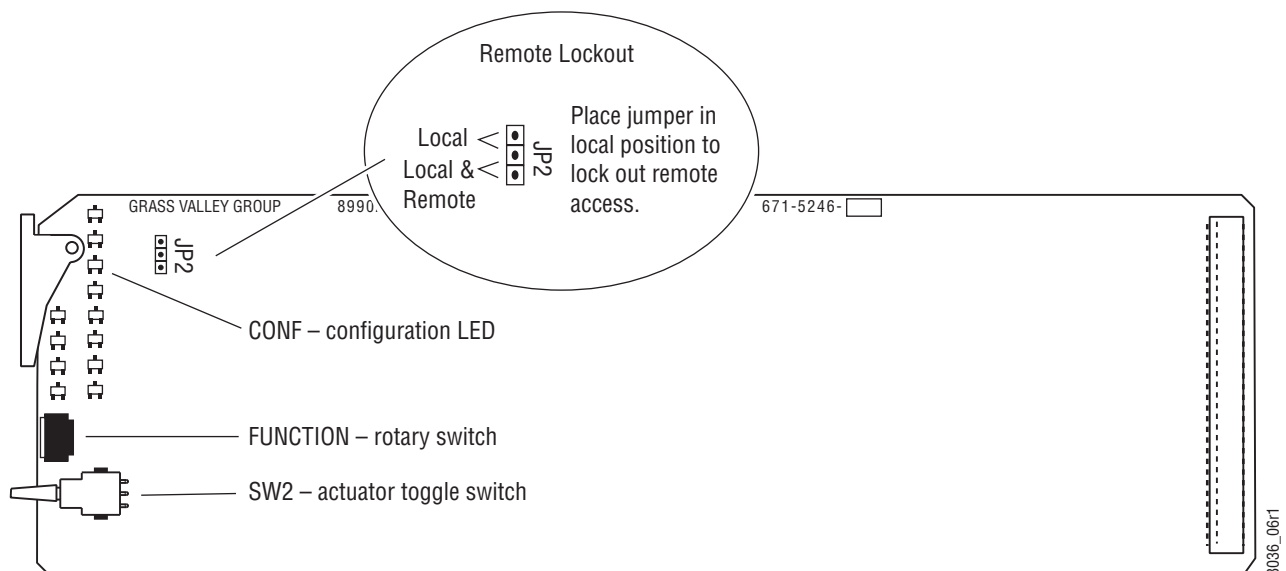
These three components perform the following:

- Function (rotary) switch — Addresses one of 16 possible positions (0 through 9 and A through F) to access a desired function for configuration. Not all positions are used (see Table 9 on page 30).

**Note** The Function switch should be kept in position 0 when not in use to avoid any inadvertent change in configuration. 0 is an inactive position.

- SW2 (paddle) switch — Actuates or selects the desired setting for the selected function when the switch is held momentarily in either the Up or Down position.
- CONF (configuring) LED — When on, indicates the module is initializing or processing configuration information.

Figure 9. Module Configuration Switches and LEDs



## Local On-board Module Configuration

The local on-board 8990ARC parameter settings are listed in [Table 9](#). Refer also to [Table 8 on page 26](#) for an overview of each of the parameters and their default values. The status of some controls can be determined by the state of the front edge LEDs shown in [Figure 5 on page 12](#).

**Note** When module power recycles the last setup state is restored. The module does not revert to a factory or the user default.

To make a configuration setting:

1. Rotate the Function Switch to the desired function switch position.
2. Move the paddle switch to the up or down position and hold momentarily to set the desired function. Note that some functions may require more than one toggle to be activated.

Table 9. 8990ARC On-board Configuration Functions

Function Switch	Paddle Switch Up	Paddle Switch Down	Function Description
0	--	--	Inactive position
1	16:9 output	4:3 output	Selects output format (aspect ratio). <sup>1</sup>
2	Decrease 4 > 3 > 2 > 1	Increase 1 > 2 > 3 > 4	Step through four output conversion modes depending on output format selected (see <a href="#">Table 8 on page 26</a> ). <sup>2</sup>
3	Picture position toggle with wrap: Right > Center > Left > Right or Bottom > Center > Top > Bottom	Center	Move picture position on the monitor to one of three positions depending on applicable mode—Tilt (top, center, bottom) or Pan (left, center, right). Positioning mode is determined by the picture conversion mode selected. Return to Center (paddle down) for reference.
4	WSS/Video Index: Off	WSS/Video Index: On	Enable Wide Screen Signaling/Video Index control. Use position 8 to set WSS or Video Index Coding mode.
5	0 > 1 > 2 > 3 > 0	0 (none)	Steps through choices for data line selection—none, one, two, or three lines. Return to 0 (none) for reference.
6	High	Low	Select High or Low V Process (vertical resizing) filtering
7	Blanked	Pass	Blank or pass Vertical Ancillary Data (VANC).
8	Standard WSS (toggle 1X) VID Off (toggle 2X)	Modified WSS (toggle 1X) Standard Vid (toggle 2X) Modified Vid (toggle 3X)	Set WSS/Video Index mode. WSS/Video Index must be turned on with position 4. Custom modes are only available with web browser.
9	Disable GPI and Set WSS line to 23	Enable GPI	Dual control: General Purpose Interface (GPI) enable/disable. In the up position, GPI control is disabled and WSS is set to line 23 default.
A	Recall GPI 1	Save GPI 1	Save/recall GPI 1 mode and current option settings.
B	Recall GPI 2	Save GPI 2	Save/recall GPI 2 mode and current option settings.
C	Recall GPI 3	Save GPI 3	Save/recall GPI 3 mode and current option settings.
D	Recall GPI 4	Save GPI 4	Save/recall GPI 4 mode and current option settings.
E	Recall Last User	Save Last User	Save current or recall last saved user settings.
F	Recall default settings	Decrement WSS line from 13-27 with wrap	Recall factory default settings (listed in <a href="#">Table 8 on page 26</a> ) and WSS line selection (choose from line 13 to line 27 with wrap back to line 13).

<sup>1</sup> Selected output format is indicated by yellow 16:9 or 4:3 LED on front edge of module

<sup>2</sup> Selected conversion mode is indicated by yellow Mode LED on front edge of module.

## Remote Configuration and Monitoring

Configuration and monitoring can be performed using a web browser GUI interface or a networked Newton Control Panel when the 8900NET Network Interface module is present in the video frame (Gecko 8900TFN-V frame). Each of these interfaces is described below.

**Note** For remote access, make sure the jumper block on the module is set for both Local and Remote access ([Figure 9 on page 29](#)).

### 8900NET Module Information

Refer to the 8900NET Network Interface Module Instruction Manual for information on the 8900NET Network Interface module and setting up and operating the Gecko 8900 frame network.

**Note** The 8900NET module in the frame must be running software version 3.2.0 or higher for proper remote and control panel operation. Upgrade software and instructions for the 8900NET can be downloaded from the Grass Valley web site.

### Newton Control Panel Configuration

A Newton Control Panel (hard or soft version) can be interfaced to the Gecko 8900 Series frame over the local network. Refer to the documentation that accompanies the Newton Modular Control System for installation, configuration, and operation information.

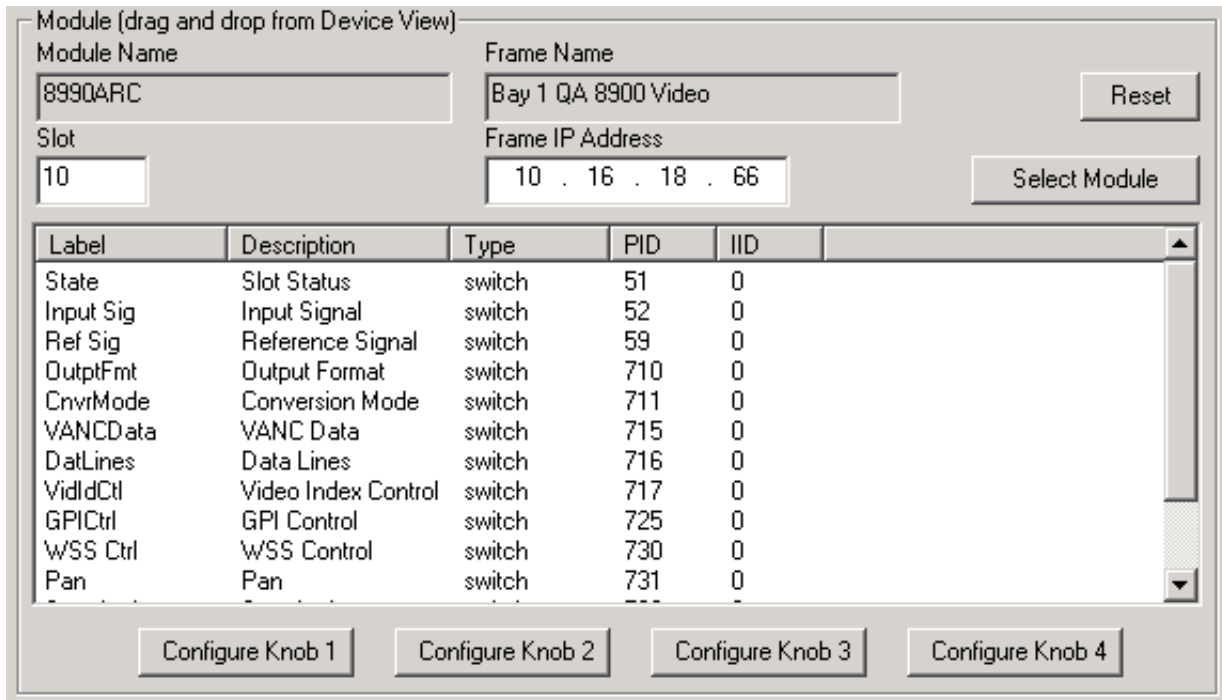
Control panel access offers the following considerations for module configuration and monitoring:

- Ability to separate system level tasks from operation ones, minimizing the potential for on-air mistakes.
- Ability to group modular products—regardless of their physical locations—into logical groups (channels) that you can easily manipulate with user-configured knobs.
- Update software for applicable modules and assign frame and panel IP addresses with the NetConfig Networking application.
- Recommended for real-time control of module configuration parameters, providing the fastest response time.

**Note** Not all module functions are available with the control panel, such as E-MEM and factory default recalls. The available control panel controls for the module are listed in [Table 8 on page 26](#).

An example of the Newton Configurator is shown in [Figure 10 on page 32](#).

Figure 10. Newton Configurator Example



## Web Browser Interface

The web browser interface provides a graphical representation of module configuration and monitoring.

Use of the web interface offers the following considerations:

- Provides complete access to all module status and configuration functions, including naming of input, factory parameter and default recalls, slot configuration, and SNMP monitoring controls.
- Web access will require some normal network time delays for processing of information.
- Configuration parameter changes may require pressing **Apply** button or **Enter**, upload processing time, and a manual screen refresh to become effective.
- Web interface recommended for setting up module signal and slot names and reporting status for SNMP and monitoring.

Refer to the Frame Status page shown in [Figure 11 on page 33](#). The 8900 modules can be addressed by clicking either on a specific module icon in the frame status display or on a module name or slot number in the link list on the left.



**Note** The physical appearance of the menu displays on the web pages shown in this manual represent the use of a particular platform, browser and version of 8900NET module software. They are provided for reference only. Displays will differ depending on the type of platform and browser you are using and the version of the 8900NET software installed in your system. This manual reflects 8900NET software version 3.2.2.

For information on status and fault monitoring and reporting shown on the Status page, refer to *Status Monitoring on page 43*.

Figure 11. Gecko 8900 Frame Status Page

The Links section lists the frame and its current modules. The selected link's Status page is first displayed and the sub-list of links for the selection is opened. The sub-list allows you to select a particular information page for the selected device.

Content display section displays the information page for the selected frame or module (frame slot icons are also active links).

Refresh button for manual update of page

**Bay 2 8900 Frame 1**

- [Status](#)
- [Configuration](#)
- [1 8920DAC](#)
- [2 8920DAC](#)
- [3 8920DAC](#)
- [4 Media Slot 4](#)
- [5 8920DAC](#)
- [6 8920DMX](#)
- [7 8920MUX](#)
- [8 Media Slot 8](#)
- [9 8990ARC](#)
- [10 8990ARC](#)
- [11 8900NET](#)
- [12 Power Supply 1](#)
- [13 Power Supply 2](#)

**Status**

Model: 8900TFN Description: Module Frame  
 Frame Location: Back Room Top  
 Frame Health Status WARNING Temperature Status Pass  
 WARNING - Module Data or Config Errors

Module	Module	Module	Module	Module	Module	Module	Module	Empty	Empty	Empty	Net Card	Empty	Power Supply
--------	--------	--------	--------	--------	--------	--------	--------	-------	-------	-------	----------	-------	--------------

Front Cover No Cover

**Properties**

Vendor	Thomson, Grass Valley	Software Version	3.2.2
Media Slots	10	Network Config	Network configuration stored on 8900NET module

8036\_12r2

## 8990ARC Links and Web Pages

The 8900 GUI provides the following links and web pages for the 8990ARC module (Figure 12):

- Status – reports input and frame bus status and module information (page 35),
- Settings – provides controls for aspect ratio, conversion mode, tilt and pan, blanking options, WSS enable and line selection, Video Index Coding enable, GPI enable, and other module functions (page 36),
- Recall/Save User Settings– provides recall and save functions for user and GPI functions as well as recalling factory defaults (page 39),
- Slot Config – provides a Locate Module function, input signal naming, SNMP trap report control, and Slot Memory (page 40), and
- Software Update – gives information on software updating (page 42).

Figure 12. 8990ARC Web Page Links

[10 8990ARC](#)  
[Status](#)  
[Settings](#)  
[Save/Recall Settings](#)  
[Slot Config](#)  
[Software Update](#)

Refer also to [Table 8 on page 26](#) for an overview of each of the parameters and their default values.

Use this link


- [10 8990ARC](#)
- [Status](#)
- [Settings](#)
- [Save/Recall Settings](#)
- [Slot Config](#)
- [Software Update](#)

### Status Web Page

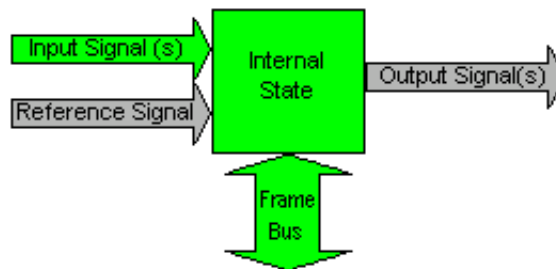
The Status web page (Figure 13) shows the status of the input signal, the internal state of the module, and frame bus communication. Color coding of the display indicates status. Refer to *Status Monitoring* on page 43 for an explanation of the color coding.

Information about the module, such as part number, serial number, hardware revision and software and firmware versions are given in a read-only section at the bottom of the page.

Figure 13. 8990ARC Status Web Page

 **Status**

Model: [8990ARC](#) Description: [SD Aspect Ratio Converter](#)  
 Frame Location: [8900: QA Bay 1](#) , Slot: [10](#)  
 Input Signal Name:  
 8990ARC Status: [PASSED](#)



### Properties

Hardware Revision [00F](#) Serial Number [0242FCGVG4587](#)  
 Software Version [3.0.0](#) Part Number [671-5246-00F](#)  
 Firmware Version [20](#)

Use  
this  
link

- [10\\_8990ARC](#)
- [Status](#)
- [Settings](#)
- [Save/Recall Settings](#)
- [Slot Config](#)
- [Software Update](#)



## Settings Web Page

The Settings web page (Figure 14 on page 37) allows you to set the following for the module:

- Select Output Format – 4:3 or 16:9,
- Select high or low V Process BW (vertical resizing) filter – switch to low to remove ringing in lines with vertical black/white or severe chroma transitions (see *Vertical Resize Filtering* on page 51).
- Select Conversion Mode – output picture ratio options (see *Output Conversion Modes* on page 17),
- Select Tilt or Pan – Tilt appears in modes that allow vertical position adjustment, Pan appears in modes that allow horizontal position adjustment,
- Pass/blank vertical ancillary data (VANC),
- Select Video Index Control type (see *Video Index Coding* on page 20). For Custom mode, see *WSS or Video Index Custom Mode* on page 38,
- Select Wide Screen Signaling type (see *Wide Screen Signaling (WSS)* on page 24),
- In 625 mode, Select line on which Wide Screen Signaling will occur on (line 13-27),
- Enable GPI control (see *GPI Control* on page 11), and
- Select number of data lines for processing (see *Video and VBI Line Handling* on page 18).

The module will report the status of both WSS and Video Index Coding as it is detected on the input signal in a read-only section at the bottom of the page. The information will always be displayed even when WSS and Video Index Coding are disabled. This read-only information is based on current industry standard formats and is provided as a status guide for the user.

Figure 14. Settings Web Page for 4:3 Output Format

 **Settings** 

Model: [8990ARC](#) Description: [SD Aspect Ratio Converter](#)  
 Frame Location: [8900: QA Bay 1](#) , Slot: [10](#)  
 Standard: [525](#)

	selection	current setting
Output Format:	<input type="text" value="16:9"/>	<a href="#">16:9</a>
V Process BW:	<input type="text" value="High"/>	<a href="#">High</a>
Conversion Mode:	<input type="text" value="Pillarbox"/>	<a href="#">Pillarbox</a>
Pan:	<input type="text" value="Centered"/>	<a href="#">Centered</a>
	<input type="button" value="Apply"/>	
	selection	current setting
VANC Data:	<input type="text" value="Blanked"/>	<a href="#">Blanked</a>
Data Lines:	<input type="text" value="None"/>	<a href="#">None</a>
	<input type="button" value="Apply"/>	
	selection	current setting
Video Index Control:	<input type="text" value="Disable"/>	<a href="#">Disable</a>
WSS Control:	<input type="text" value="Disable"/>	<a href="#">Disable</a>
WSS Line:	<input type="text" value="23"/>	<a href="#">23</a>
GPI Control:	<input type="text" value="Disable"/>	<a href="#">Disable</a>
	<input type="button" value="Apply"/>	

Standard WSS AR/Pos: [Invalid](#)  
 Modified WSS Status: [Invalid](#)  
 Modified WSS AID: [000 Invalid](#)  
 Modified WSS ARD: [000 same as AID](#)  
 Standard VID AID: [000 no info](#)  
 Modified VID Status: [Valid](#)  
 Modified VID AID: [000 Invalid](#)  
 Modified VID ARD: [000](#)

### WSS or Video Index Custom Mode

When **Custom** mode has been selected for either the Video Index Control or the WSS Control, the web page will change to include the following two controls:

- **WSS/Vid Input LSBs** – use this control to select an LSB for a particular conversion mode (Figure 15).
- **Resulting 16x9/4x3 Mode** – set the desired conversion mode for the selected LSB. The web page will display the currently selected output format as shown in Figure 15 (16x9) and Figure 16 (4x3). Refer to Table 8 on page 26 for a configuration summary of all parameters available for these controls.

Figure 15. WSS/Vid Input LSB and Mode Web Page Controls – 16x9 Output

	selection	current setting
WSS/Vid Input LSBs:	<input type="text" value="000"/>	000
	<input type="button" value="Apply"/>	
	selection	current setting
Resulting 16x9 Mode:	<input type="text" value="No Change"/>	No Change
	<input type="button" value="Apply"/>	

Figure 16. WSS/Vid Input LSB and Mode Web Page Controls – 4x3 Output

	selection	current setting
WSS/Vid Input LSBs:	<input type="text" value="000"/>	000
	<input type="button" value="Apply"/>	
	selection	current setting
Resulting 4x3 Mode:	<input type="text" value="No Change"/>	No Change
	<input type="button" value="Apply"/>	

### Save/Recall Settings Web Page

Use this link

- [10 8990ARC](#)
- [Status Settings](#)
- [Save/Recall Settings](#)
- [Slot Config](#)
- [Software Update](#)

The 8990ARC provides five storage registers to save module configuration settings for access through standard local and remote control or four of the registers can be controlled through the GPI interface on the Save/Recall Settings web page (Figure 17).

Use the **Save User Settings** button to save the current module configuration to a local storage register. Select **Recall User Settings** to recall the locally saved register.

Use the **Save** and **Recall GPI 1-4** registers to recall saved configurations by triggering

Current module configuration settings are displayed below the header information. Factory default settings can be recalled using the **Recall Defaults** button.

Figure 17. Save/Recall Settings Web Page

**Save/Recall Settings**

Model: [8990ARC](#) Description: [SD Aspect Ratio Converter](#)  
 Frame Location: [8900: QA Bay 1](#) , Slot: [10](#)

Output Format: [16:9](#)      Conversion Mode: [Pillarbox](#)      Pan: [Centered](#)  
 VANC Data: [Blanked](#)      Data Lines: [None](#)      Standard: [525](#)  
 Video Index Control: [Disable](#)      GPI Control: [Disable](#)      WSS Control: [Disable](#)  
 V Process BW: [High](#)

<a href="#">Recall User Settings</a>	<a href="#">Save User Settings</a>
<a href="#">Recall GPI 1 Settings</a>	<a href="#">Save GPI 1 Settings</a>
<a href="#">Recall GPI 2 Settings</a>	<a href="#">Save GPI 2 Settings</a>
<a href="#">Recall GPI 3 Settings</a>	<a href="#">Save GPI 3 Settings</a>
<a href="#">Recall GPI 4 Settings</a>	<a href="#">Save GPI 4 Settings</a>
<a href="#">Recall Defaults</a>	

Use  
this  
link

- [10 8990ARC](#)
- [Status](#)
- [Settings](#)
- [Save/Recall Settings](#)
- [Slot Config](#)
- [Software Update](#)

## Slot Config Web Page

Use the Slot Config web page (Figure 18 on page 41) to perform the following functions on the 8990ARC module:

- **Locate Module** – selecting the **Flash** radio button flashes the yellow COMM LED on the front of the module so it can be located in the frame.
- **Slot Identification** – You may identify the module by typing a specific name in the **Name** field. The assigned name is stored on the 8900NET module and travels with the 8900NET module if it is moved to another frame. Select **Default** to enter the factory default module name.

You may also enter a unique signal name in the **Input Signal Name** field. Press the **Default** button to return to the default input signal name (**not assigned**).

- **Slot Memory** – the slot configuration for each media module is automatically saved periodically (once an hour) to the 8900NET module in that frame. You may also select the **Learn Module Config** button at any time to save the current configuration for this slot. The configuration is saved on the 8900NET module. If the 8900NET module is removed or powered down, the stored configurations are not saved.



When the **Restore upon Install** box has been checked, the current configuration saved to this slot is saved as slot memory. When the current module is removed and another module of the same type is installed, the configuration saved to the 8900NET module will be downloaded to the new module. The box must be checked before the current module with the saved configuration is removed.

- **Frame Health Reporting** – this function is not used on the current version of 8900NET software which controls this page.
- **Hardware Switch Controls** – a read-only status report of 8900NET module switch settings for Module Status Reporting and Asynchronous Status Reporting. These functions must be enabled for the following Slot SNMP Trap Reports to function.
- **Slot SNMP Trap Reports** – displayed only when the SNMP Agent software has been installed on the 8900NET module. Slot SNMP traps can be enabled only when the hardware switches for Module Fault reporting and Asynchronous Status reporting are enabled on the 8900NET module (dipswitch S1 segment 5 and dipswitch S2 segment 1).

The enabled SNMP traps will be reported to any SNMP manager that is identified as an SNMP Report Destination in 8900NET configuration. Trap severity is read-only hard-coded information that is interpreted and responded to by the SNMP Manager software configuration.



Figure 18. 8990ARC Slot Config Web Page

 **Slot Config** 

Model: [8990ARC](#) Description: [SD Aspect Ratio Converter](#)  
 Frame Location: [8900: QA Bay 1](#) , Slot: [10](#)

**Locate Module**

Flash  Off

**Slot Identification**

Name:

Input Signal Name:

**Slot Memory**

Restore upon Install

**Frame Health Reporting**

	Slot Fault	Signal Loss	Reference Loss
Enabled	<input checked="" type="checkbox"/>	<input type="checkbox"/>	<input type="checkbox"/>

**Hardware Switch Controls**

Module Status Reporting: [Enabled](#) Asynchronous Status Reporting: [Enabled](#)

**Slot SNMP Trap Reports**

	Slot Fault	Module Removed	Signal Loss	Reference Loss
Enabled	<input checked="" type="checkbox"/>	<input checked="" type="checkbox"/>	<input checked="" type="checkbox"/>	<input checked="" type="checkbox"/>
Trap Severity	<a href="#">Alarm</a>	<a href="#">Warning</a>	<a href="#">Warning</a>	<a href="#">Warning</a>

Use  
this  
link

- [10 8990ARC](#)
- [Status](#)
- [Settings](#)
- [Save/Recall Settings](#)
- [Slot Config](#)
- [Software Update](#)

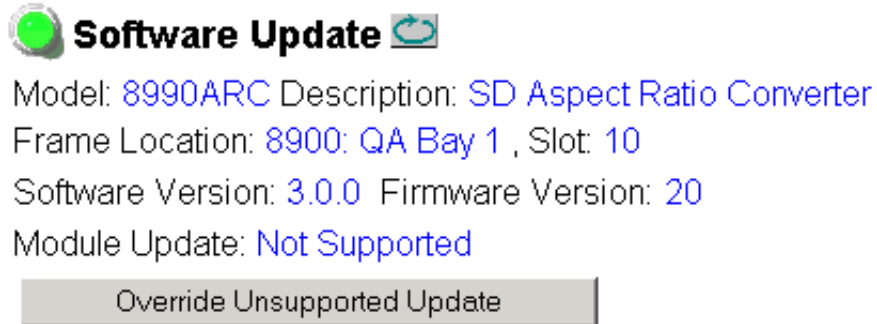
### Software Update Web Page

As shown in the Software Update web page (Figure 19), software updates via the web or using the NetConfig networking application are currently not supported. For instructions on updating to the latest software, refer first to the 8990ARC Release Notes that accompany the software update for complete details.

Currently, the only recommended method of software updating is done with a software kit (8900-FLOAD-CBL) that includes a CD-ROM with the current software files and a serial cable assembly available from Grass Valley.

Refer to the *8900-FLOAD-CBL Software Upgrade Instruction Manual* in pdf format on the CD-ROM for complete updating instructions and the required software files for the 8990ARC.

Figure 19. 8990ARC Software Update Web Page



## Status Monitoring

This section provides a summary of status monitoring and reporting for a Gecko 8900 Series system. It also summarizes what status items are reported and how to enable/disable reporting of each item. There are a number of ways to monitor status of modules, power supplies, fans and other status items depending on the method of monitoring being used.

8900 Frame status will report the following items:

- Power supply health,
- Status of fans in the frame front cover,
- Temperature,
- Module health, and
- Frame bus status.

Module health status will report the following items:

- Internal module state (and state of submodule or options enabled) including configuration errors (warning), internal faults, and normal operation (Pass).
- Signal input states including valid/present (pass), not present or invalid (warning), not monitored, and not available (no signal inputs).
- Reference input states including locked/valid (pass), not locked/invalid (warning), and not monitored.
- Signal output states with reporting functionality (reference output).

## LEDs

LEDs on modules in the frame and on the front of the 8900TF/TFN frames indicate status of the frame and the installed power supplies, fans in the front covers, and modules. (The 8900TX-V/A frames have no LED indicators on the front cover.)

When a red FAULT LED is lit on a frame front cover, the fault will also be reported on the 8900NET or Frame Monitor module. The LEDs on the front of these modules can then be read to determine the following fault conditions:

- Power Supply 1 and 2 health,
- Fan rotation status,
- Frame over-temperature condition,
- Frame Bus fault (8900NET only), and
- Module health bus.

In general, LED colors used on the frame and modules indicate:

- Green – normal operation, (Pass) or signal present, module locked.
- Red – On continuously = fault condition, flashing = configuration error.
- Yellow – On continuously = active condition (configuration mode or communication), flashing in sequence = module locator function.

Status LEDs for this module are described in [Table 2 on page 13](#). LEDs for the 8900NET module are described in the *8900NET Network Interface Instruction Manual*.

## Frame Alarm

A Frame Alarm connection is available on pins 8 and 9 of the RS-232 connector on the rear of the 8900 frame (Frame Monitor or 8900NET Network Interface module required). This will report any of the status items enabled with the 8900NET or Frame Monitor module configuration DIP switch. Connection and use of the Frame Alarm is covered in detail in the *8900NET Network Interface Instruction Manual*.

## Web Browser Interface

When the 8900NET module is installed in the frame, a web browser GUI can indicate frame and module status on the following web pages:

- Frame Status page – reports overall frame and module status in graphical and text formats.
- Module Status page – shows specific input and reference signal status to the module along with enabled options and module versions.
- A Status LED icon on each web page to report communication status for the frame slot and acts as a link to the Status page where warnings and faults are displayed (8900NET version 3.0 or later).

In general, graphics and text colors used indicate the following:

- Green = Pass – signal or reference present, no problems detected.
- Red = Fault – fault condition.
- Yellow = Warning – signal is absent, has errors, or is mis-configured.
- Grey = Not monitored (older 8900 module).
- White = Not present.

Status reporting for the frame is enabled or disabled with the configuration DIP switches on the 8900NET module. Most module status reporting items can be enabled or disabled on individual configuration web pages.

## SNMP Reporting

The Gecko 8900 Series system uses the Simple Network Monitoring Protocol (SNMP) internet standard for reporting status information to remote monitoring stations. When SNMP Agent software is installed on the 8900NET module, enabled status reports are sent to an SNMP Manager such as the Grass Valley's NetCentral application.

There are both hardware and software report enable switches for each report. Both must be enabled for the report to be sent. Software report switches are set on the 8900NET Configuration page for the Frame, the 8900NET module, and each module slot. Refer to the *8900NET Network Interface Instruction Manual* for installation instructions.

# Specifications

Table 10. 8990ARC Specifications

Parameter	Value
<b>SDI Input</b>	
Signal type	SMPTE 259M-C or EBU tech 3267, 8- or 10-bit serial digital component video
Number of inputs	1 loop-through
Connector type	75 $\Omega$ BNC
Return loss	> 15 dB, 5 to 270 MHz
Max input cable length	300 m (1000 ft.) of Belden 8281 or equivalent
<b>SDI Outputs</b>	
Number of outputs	4
Connector type	75 $\Omega$ BNC
Signal type	SMPTE 259M-C or EBU tech 3267
Output impedance	75 $\Omega$
Return loss	> 15 dB, 5 to 270 MHz
<b>Signal Processing</b>	
Signal path	12-bit processing internally then rounded and truncated to 10 bits
525/625 selection	Automatic
Aspect ratio selection	16:9 to 4:3, 4:3 to 16:9, manual or automatic if video index is enabled
Modes 16:9 to 4:3 conversion	<ul style="list-style-type: none"> <li>• Bypass (No processing)</li> <li>• Letterbox (no loss)</li> <li>• Full height (h-crop)</li> <li>• 14:9 sub-image (some h-crop, less than full height)</li> </ul>
Modes 4:3 to 16:9 conversion	<ul style="list-style-type: none"> <li>• Bypass (No processing)</li> <li>• Pillarbox side panels (no loss)</li> <li>• Full width (v-crop)</li> <li>• 14:9 sub-image (some v-crop, less than full width)</li> </ul>
Horizontal position	Left/center/right justified output (shrink) or input (magnify)
Vertical position	Top/center/bottom justified output (shrink) or input (magnify)
Horizontal ancillary data	All horizontal embedded ancillary data (HANC) passed to output
Hot switch handling	Module will handle input signal hot switched between synchronous signals that are timed within 1/2 line without causing glitches in the output stream
Switching line processing	None
Vertical interval blanking	Vertical interval lines: Lines 1-20, 264-283 (525) Lines 624-23, 311-336 (625) These lines are blanked if the VANC Data control is set to Blanked. These lines are passed if the control is set to Pass.

Table 10. 8990ARC Specifications

Parameter	Value
Active lines blanked before processing by scaling circuit	
	525
	Data Lines control setting (Number of blanked lines)
	None      No active or half-lines blanked
	1      Line 21 blanked (top) Line 284 blanked (top) Line 263 blanked (bottom) Line 525 blanked (bottom)
	2      Line 21 blanked (top) Line 284 blanked (top) Line 22 blanked (top) Line 285 blanked (top) Line 262 blanked (bottom) Line 524 blanked (bottom) Line 263 blanked (bottom) Line 525 blanked (bottom)
	3      Line 21 blanked (top) Line 284 blanked (top) Line 22 blanked (top) Line 285 blanked (top) Line 23 blanked (top) Line 286 blanked (top) Line 261 blanked (bottom) Line 523 blanked (bottom) Line 262 blanked (bottom) Line 524 blanked (bottom) Line 263 blanked (bottom) Line 525 blanked (bottom)

Table 10. 8990ARC Specifications

Parameter	Value
	625
	Data lines setting (Number of blanked lines)
	None No active or half-lines blanked
	1 Line 24 blanked (top) Line 337 blanked (top) Line 310 blanked (bottom) Line 623 blanked (bottom)
	2 Line 24 blanked (top) Line 337 blanked (top) Line 25 blanked (top) Line 338 blanked (top) Line 309 blanked (bottom) Line 622 blanked (bottom) Line 310 blanked (bottom) Line 623 blanked (bottom)
	3 Line 24 blanked (top) Line 337 blanked (top) Line 25 blanked (top) Line 338 blanked (top) Line 26 blanked (top) Line 339 blanked (top) Line 308 blanked (bottom) Line 621 blanked (bottom) Line 309 blanked (bottom) Line 622 blanked (bottom) Line 310 blanked (bottom) Line 623 blanked (bottom)
Output signal EDH	EDH Check-words per SMPTE RP 165 inserted in output signal
<b>Video Processing Delay</b>	
Electrical Length	About 75 1/4 lines
<b>Response to input signal loss</b>	
Video input signal absent	Output signal invalid
<b>GPI/VDI</b>	
Video Index information input	If enabled, allows automatic selection of processing mode
GPI selections	Ability to store and recall 4 settings for either 525 or 625, not both. Store is via the front panel controls or the Ethernet remote control. Recall can be via local controls, Ethernet, or by means of a User-provided control panel.
GPI panel	User provides 4 latching or momentary switches and appropriate resistors. No tall is provided from this module.
<b>Environmental</b>	
Frame temperature range	See 8900 Gecko Frame specifications
Operating humidity range	0 to 90% non-condensing
Non-operating temperature	- 10 to 70 degrees C
<b>Mechanical</b>	
Frame type	Gecko 8900 Video Frame
<b>Power Requirements</b>	
Supply voltage	+ 12 V
Power consumption	4.75 Watts



# Service

The 8990ARC Digital to Analog Converter modules make extensive use of surface-mount technology and programmed parts to achieve compact size and adherence to demanding technical specifications. Circuit modules should not be serviced in the field unless otherwise directed by Customer Service.

If your module is not operating correctly, proceed as follows:

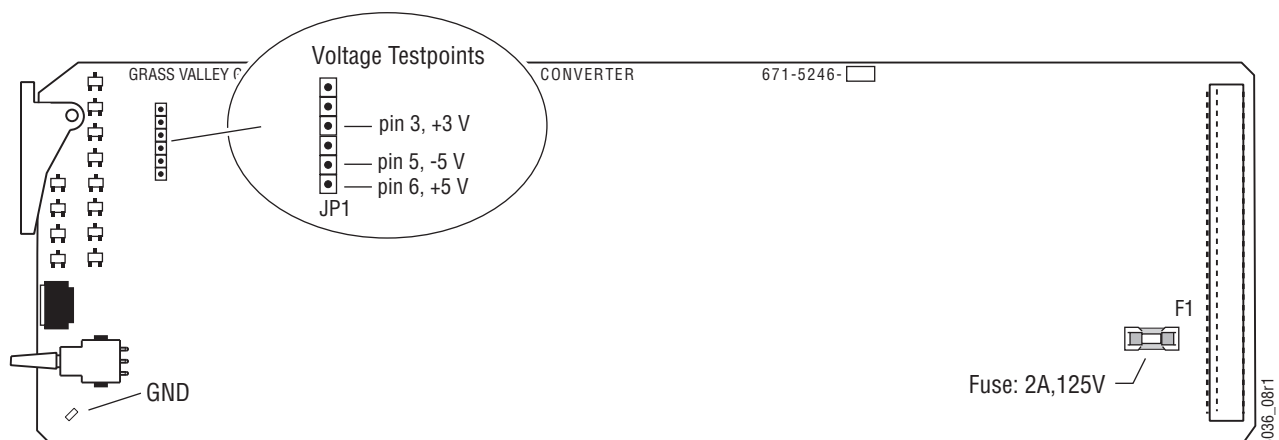
- Check frame and module power and signal present LEDs.
- Verify power at the voltage testpoints (see [Figure 20](#)) and check Fuse F1 if no voltage is detected.
- Check for presence and quality of input signals.
- Verify that source equipment is operating correctly.
- Check cable connections.
- Check output connections for correct I/O mapping (correct input connector is used for the corresponding channel output).

Refer to [Figure 5](#) on [page 12](#) for the location of PWR LED and [Table 2](#) on [page 13](#) for proper LED indications.

If the module is still not operating correctly, replace it with a known good spare and return the faulty module to a designated Grass Valley repair depot. Call your Grass Valley representative for depot location.

Refer to [Contacting Grass Valley](#) at the front of this document for the Grass Valley Customer Service Information number.

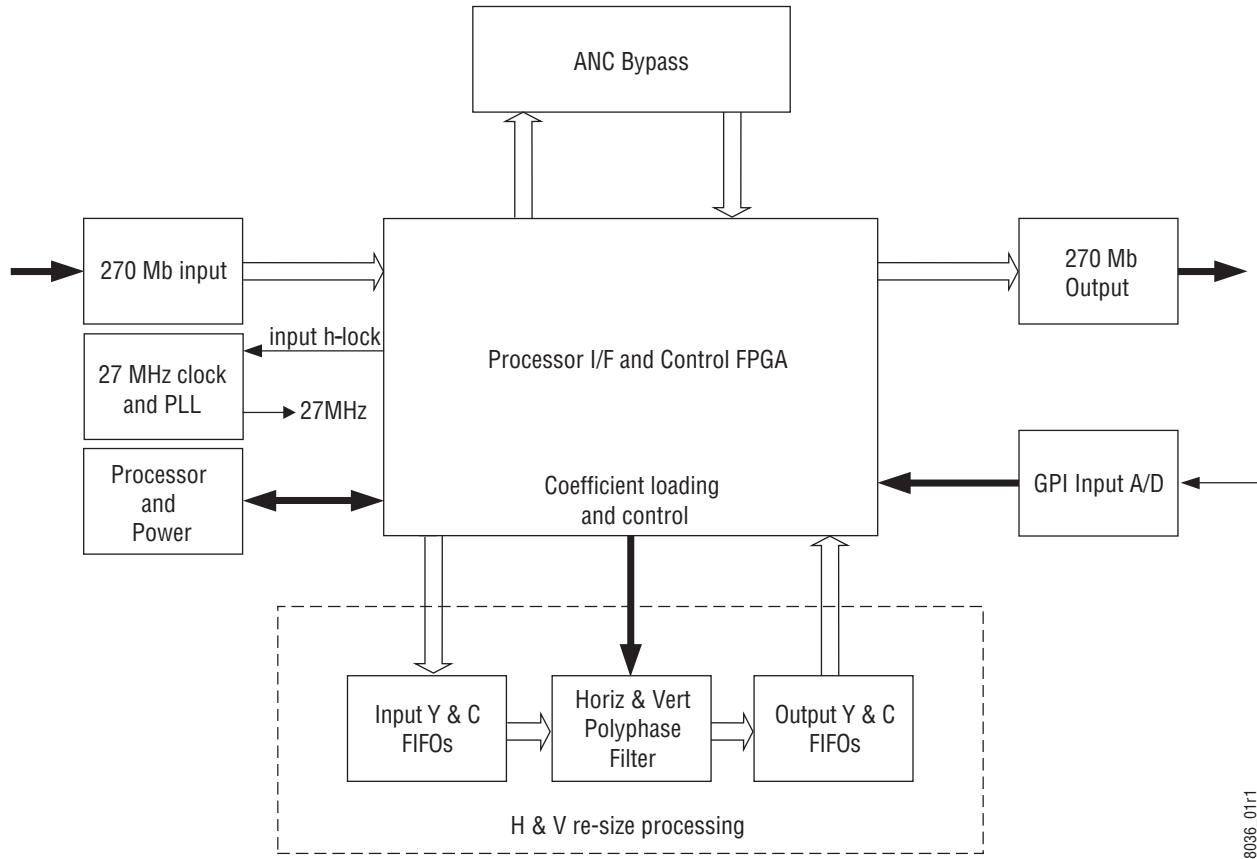
Figure 20. Fuse and Voltage Testpoint Locations



## Functional Description

Refer to the block diagram in [Figure 21](#) while reading the following functional description.

Figure 21. 8990ARC Block Diagram



8036\_01r1

### Input and Ancillary Data Processing

The input signal is deserialized and enters the control Field Programmable Gate Array (FPGA). Sync is detected and is used to H-lock the system 27 MHz clock. All horizontal and vertical interval data is routed through the ancillary data (ANC) bypass FIFO to delay match the re-sized active picture data and is multiplexed back, with the re-sized data, to the parallel data output. This output is serialized and output through 4 buffers and connectors.

### Active Picture Processing

The active picture portion is routed through the H and/or V re-sizing portion shown. Depending on the mode and input format selected, H and V will be scaled up or down. The maximum delay for this processing is

required for vertical magnification, where the starting position of the output will be at last 3/4 position in the input picture. The worst case is 4:3 input and mode 3 (full-width) with the vertical position set at the bottom of the field. In all modes, the overall delay will be fixed at this worst case for each line rate.

## H & V Re-sizing Algorithm

Scaling up (magnify) creates more pixels or lines in a selected region than is available in the input and therefore requires a horizontal or vertical position adjustment. It is accomplished by periodically holding off the reading of data from the input FIFO, while re-computing a new pixel/line in its corresponding poly-phase filter.

Scaling down (shrink) decimates pixels or lines from the entire source image and results in a blanked region in the output, which is adjusted using the horizontal or vertical position adjustment. It is accomplished by periodically holding off the writing of data to the output FIFO, while re-computing a new pixel/line in its corresponding poly-phase filter.

In modes 2 and 3 only one operation is performed, H or V scale up or down. In mode 4, the 14:9 sub-image both scaling up and scaling down are done independently and simultaneously.

## Vertical Resize Filtering

All the poly-phase filters used for vertical magnification or shrink have maximum bandwidth. Video sources with high contrast or chroma saturated horizontal edges will produce some filter ringing within a few lines above and below the edge. One example of such an edge is contained in the SMPTE color bar test pattern. If this effect needs to be eliminated, then linear-interpolators can be used in these vertical processing modes in the V Process BW configuration selection. The consequence of this selection is having a reduced vertical bandwidth.

## Video Index Information Coding Support

Video source data can be inserted on lines 11 and 324 in 625 line rate or lines 14 and 277 in 525 line rate systems per SMPTE RP-186 specification. The very first section of this coding region, Class 1.1, data octet 1, encodes options on the source of being 525/625 line and 4x3 or 16x9 format. If the input to the 8990ARC contains this section of coding and the Video Index Control function is enabled, the mode will automatically change to 1 (no processing) if the input format and selected output format are the same. It will revert to the previous, 2 through 4 selection when either the input format changes or the user changes the desired output format.



# Index

## Numerics

- 16:9 LED 13
- 4:3 LED 13
- 525 LED 12, 13
- 625 LED 12, 13
- 8900 frame
  - frame alarm 44
  - status reporting 43
- 8900NET module
  - required software version 31
- 8990ARC
  - block diagram 50
  - features 7

## A

- aspect ratio
  - local control 30
  - overview 14
  - remote control 36
  - summary table 26

## B

- backplane 9
- block diagram 50

## C

- COMM LED 13
- CONF (configuring) LED 12, 13, 29
- configuration
  - local on-board 29
  - overview 14
  - Remote, GUI 31
  - summary table 26
- connectors
  - input/output 10
- control panel 14, 31
  - summary table 26
- controller module 8

- conversion modes
  - local control 30
  - overview 17
  - remote control 36
  - summary table 26

## D

- data lines
  - local control 30
  - remote control 36
  - summary table 26
- documentation online 2

## E

- enable SNMP 45
- environmental 48

## F

- factory defaults
  - recall
    - local control 30
    - remote control 39
    - summary table 27
  - summary table 26
- FAQ database 2
- fault 13
- FAULT LED 13
  - troubleshooting 43
- frame 8, 48
- frame capacity 8
- Frame Status web page 44
- frequently asked questions 2
- Function rotary switch 29, 30
- functional description 50
- fuse 49

## G

- GPI (General Purpose Interface)
  - connections 10
  - control configuration 25
  - local control 30
  - remote control 36
  - summary table 27
- graphical user interface (GUI) 34
- Grass Valley web site 2

## I

- impedance 10
- indicators 13
- input
  - loop-through BNC 10
  - specification 46

## L

- locate module 40
- loop-through 10
- LSBs
  - custom configuration 38
  - overview 23
  - summary table 26

## M

- MAN LED 12
- Mode 1 LED 13
- Mode 2 LED 13
- Mode 3 LED 13
- Mode 4 LED 13
- module
  - controller 8
  - installation 8
  - power supply 8
  - slots 9
- module health status 43
- Module Status web page 44

## N

- Newton Control Panel
  - configuration summary 26

- overview 31

## O

- online documentation 2
- operational modes 13
- output format (resizing)
  - control summary 14
  - local control 30
  - remote control 36
  - summary table 26
- outputs
  - cabling 10
  - connectors 10
  - specification 46
  - termination 10

## P

- paddle switch 29
- Pan control
  - local 30
  - Newton Control Panel 27
  - remote 36
  - summary table 26
- performance 46
- power 48
- power supply 8
- PWR LED 12, 13

## R

- rear connectors 9
- rear overlay cards 10
- repair depot 49
- report enable switches 45

## S

- Save/Recall web page 39
- Settings web page 36
- Slot Config web page 40
- slot memory 40
- SNMP reporting
  - enabling 40
  - overview 45

software download from web [2](#)  
 Software Update web page [42](#)  
 status monitoring [43](#)  
 Status web page [35](#)  
 switches (onboard) [29](#)

## T

termination [10](#)  
 Tilt control  
   local [30](#)  
   Newton Control Panel [27](#)  
   remote [36](#)  
   summary [26](#)  
 troubleshooting [49](#)

## U

user settings  
   summary table [27](#)

## V

V Process (vertical resizing)  
   local control [30](#)  
   overview [17](#)  
   remote control [36](#)  
   summary table [26](#)  
 VANC (vertical ancillary) data  
   local control [30](#)  
   overview [18](#)  
   remote control [36](#)  
   summary table [26](#)  
 Video Index Coding  
   Custom [23,38](#)  
   local control [30](#)  
   Modified [21](#)  
   overview [20](#)  
   remote control [36](#)  
   Standard [20](#)  
   summary table [26](#)  
 voltage (supply) [48](#)  
 voltage tespoints [49](#)

## W

web browser

  overview [32](#)  
 web site  
   documentation [2](#)  
   FAQ database [2](#)  
   Grass Valley [2](#)  
   software download [2](#)  
 Wide Screen Signaling (WSS)  
   Custom [25,38](#)  
   default line [27](#)  
   line selection [24](#)  
   local control [30](#)  
   Modified [25](#)  
   overview [24](#)  
   remote control [36](#)  
   Standard overview [24](#)  
   summary table [26](#)

