

# 8937/8937D

SDI RECLOCKING EQ SNMP DA MODULES

Instruction Manual

SOFTWARE VERSION 1.0.0

071827000  
FEBRUARY 2004

*the most watched worldwide*

# Contacting Grass Valley

Region	Voice	Fax	Address	Web Site
North America	(800) 547-8949 Support: 530-478-4148	Sales: (530) 478-3347 Support: (530) 478-3181	Grass Valley P.O. Box 599000 Nevada City, CA 95959-7900 USA	www.thomsongrassvalley.com
Pacific Operations	+852-2585-6688 Support: 852-2585-6579	+852-2802-2996		
U.K., Asia, Middle East	+44 1753 218 777	+44 1753 218 757		
France	+33 1 45 29 73 00			
Germany, Europe	+49 6150 104 782	+49 6150 104 223		

Copyright © Thomson Broadcast and Media Solutions All rights reserved.

## Grass Valley Web Site

The [www.thomsongrassvalley.com](http://www.thomsongrassvalley.com) web site offers the following:

**Online User Documentation** — Current versions of product catalogs, brochures, data sheets, ordering guides, planning guides, manuals, and release notes in .pdf format can be downloaded.

**FAQ Database** — Solutions to problems and troubleshooting efforts can be found by searching our Frequently Asked Questions (FAQ) database.

**Software Downloads** — Software updates, drivers, and patches can be downloaded.

# Contents

- Preface**..... 5
  - About This Manual..... 5
  
- 8937 and 8937D Reclocking EQ SNMP DAs**
  - Introduction..... 7
  - Installation..... 8
    - Frame Capacity..... 8
    - Module Placement in the Gecko 8900 Frame..... 8
    - Module On-board Jumper Settings..... 10
      - 8937 Module..... 10
      - 8937D Module..... 11
    - Looping Capabilities..... 11
  - Cabling..... 12
    - 8937 Module..... 12
    - 8737D Module..... 13
  - Power Up..... 14
    - Operation Indicator LEDs..... 14
  - Configuration..... 16
    - Remote Control and Monitoring..... 16
      - 8937 and 8937D Links and Web Pages..... 18
        - Status Web Page..... 19
        - Standard Selections Web Page..... 20
        - Recall Factory Defaults Web Page..... 24
        - Slot Config Web Page..... 25
        - Software Update Web Page..... 27
      - Newton Control Panel Configuration..... 28
  - Specifications..... 29
  - Functional Description..... 30
    - Input and Output Processing..... 30
    - Microprocessor and Input Selector..... 30
  - Service..... 31
  - Status Monitoring..... 32
    - LEDs..... 32
    - Frame Alarm..... 33
    - Web Browser Interface..... 33
      - SNMP Reporting..... 34
  
- Index**..... 35



# *Preface*

## **About This Manual**

This manual describes the features of a specific module of the Gecko 8900 Signal Processing System. As part of this module family, it is subject to Safety and Regulatory Compliance described in the Gecko 8900 Series frame and power supply documentation (see the *8900TX/8900TF/8900TFN Frames Instruction Manual*).



# *8937 and 8937D Reclocking EQ SNMP DAs*

## **Introduction**

The 8937 module is a 1 x 8 looping input, auto-reclocking, auto-cable equalizing DA with SNMP monitoring capability. The module is suited for medium to long distance signal distribution.

The 8937D (dual) module provides two separate SDI distribution amplifiers on a single card. It also has auto-reclocking, auto-cable equalizing with SNMP monitoring capability. The module is ideal for environments where compact and high density capability is required such as mobile trucks.

The 8937 and 8937D feature:

- Jumper selectable bypass/relock mode with auto bypass,
- Auto detection and front panel indication of all SMPTE 259M signal data rates,
- Auto format detection (525/625),
- Auto cable equalization for up to 300 meters of cable with front panel EQ warning,
- Suitable for SMPTE 310M, SMPTE 259M, DVB-ASI, SDI 270 Mb/s and other 800 mV data ranging from 4 Mb/s to 360 Mb/s,
- Signal presence indication with selectable SNMP trap generation, and
- Remote health monitoring interface.

This manual covers installation, configuration, and operation for both the 8937 and 8937D modules.

# Installation

Installation of a module is a process of:

1. Placing the module in a video frame slot, and
2. Cabling and terminating signal ports.

The module can be plugged in and removed from a Gecko 8900 video frame with power on. When power is applied to the module, LED indicators reflect the initialization process (see [Power Up on page 14](#)).

## Frame Capacity

The 8937 and 8937D module can be installed in all Gecko 8900 video frames but with varying maximum quantities determined by frame cooling capacity. [Table 1](#) provides the power capacity, cooling capacity, and maximum module count for each frame type.

Table 1. Video Frame Power Capacity

Capacity Calculated	8900TX Frame	8900TF Frame	8900TFN Frame
Power (W)	100	100	100
Recommended Module Cooling (W)	30	100	100
8937 Modules	10	10	10
8937D Modules	10	10	10

**Note** Module capacity figures assume no other modules are in the frame.

## Module Placement in the Gecko 8900 Frame

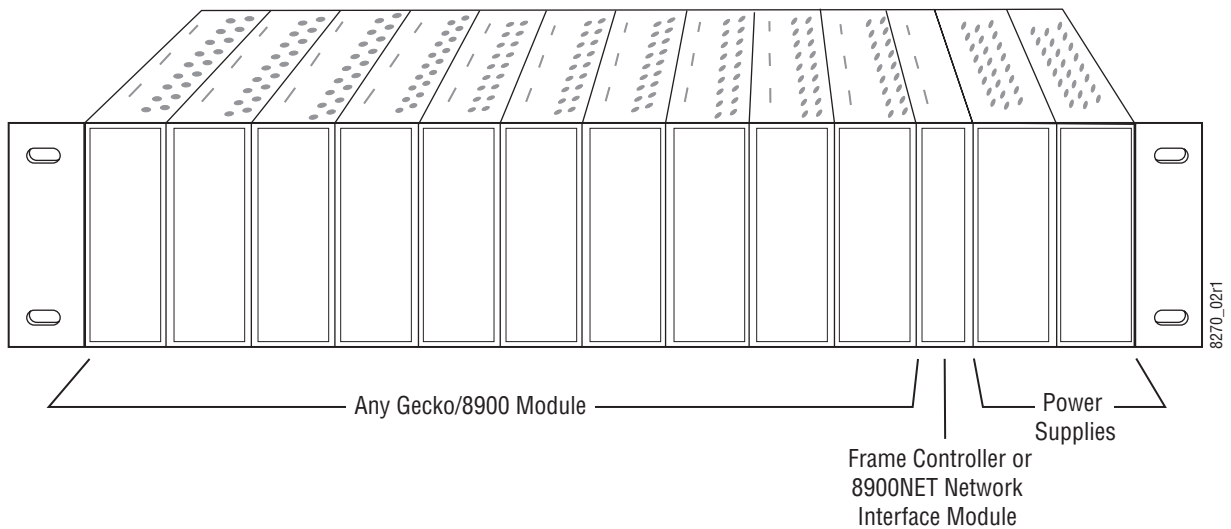
There are ten cell locations in the video frame to accommodate modules. These are the left ten locations. Refer to [Figure 1](#).

The two cells on the right are allocated for the power supplies. For additional information concerning the Power Supply module, refer to the 8900 Power Supply manual.

The third cell from the right is allocated for the Frame Monitor or 8900NET Network Interface module. These modules provide health monitoring and control options.

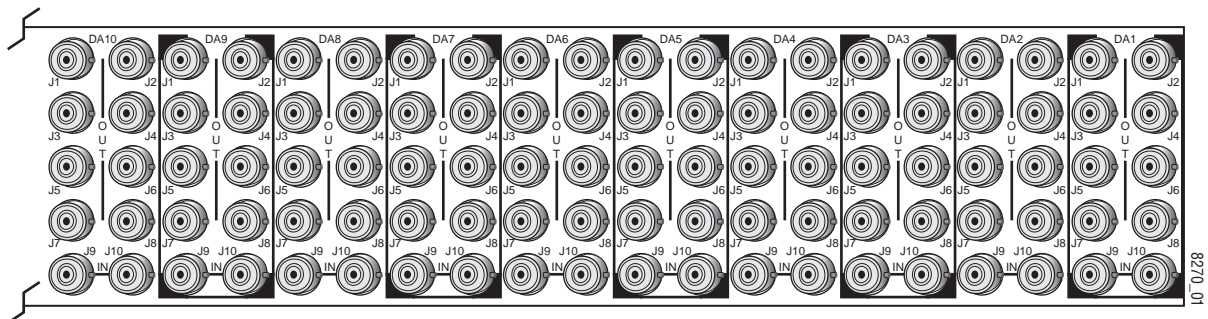


Figure 1. Gecko 8900 Series Frame



8900 module slots are interchangeable within the frame. There are 10 BNCs in each slot's I/O group. The functional assignment of each connector in a group is determined by the module that is placed in that slot. The maximum number of modules a Gecko 8900 video frame can accept is ten. [Figure 2](#) illustrates the rear connector plate for a Gecko 8900 video frame.

Figure 2. Gecko 8900 Series Video Frame Rear Connector



To install a module in the frame:

1. Insert the module, connector end first, with the component side of the module facing to the right and the ejector tab to the top.
2. Verify that the module connector seats properly against the backplane.
3. Press in the ejector tab to seat the module.

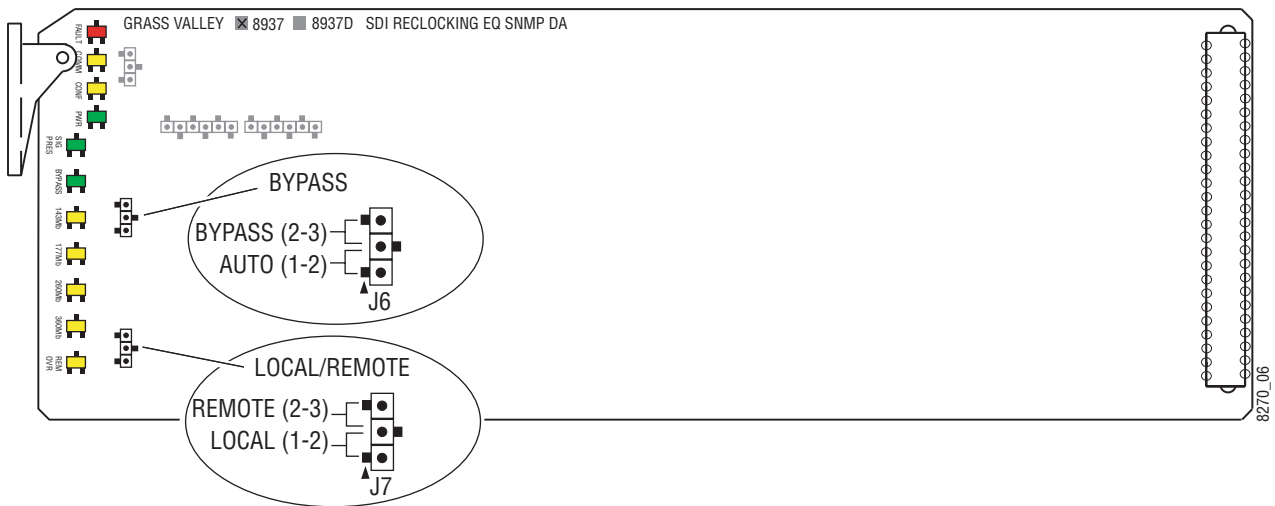
## Module On-board Jumper Settings

### 8937 Module

Two on-board jumpers must be set on the 8937 module to determine module formatting before installing it in the frame. Refer to [Figure 3](#) for jumper locations on the module circuit board.

- DA 1 Bypass – set jumper J6 for AUTO (pins 1-2) to enable auto reclocking (for signal data rates of 143, 177, 270, and 360 Mb/s) or BYPASS (pins 2-3) to bypass reclocking (for signals with data rates of 4 Mb/s to 360 Mb/s). This setting can be overridden by remote controls.
- Local/Remote – set jumper J7 to LOCAL (pins 1-2) to lock out remote control or LOCAL & REMOTE (pins 2-3) for access to remote control. This setting cannot be overridden by remote controls.

Figure 3. On-Board Jumper Locations

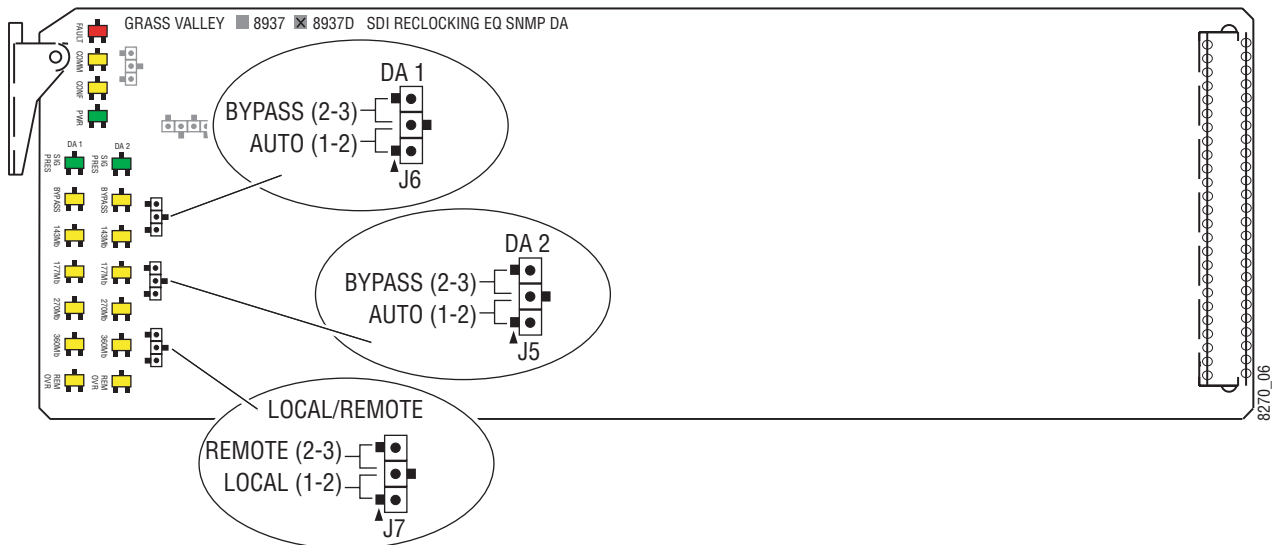


## 8937D Module

Three on-board jumpers must be set on the 8937D module to determine module formatting before installing it in the frame. Refer to [Figure 4](#) for jumper locations on the module circuit board.

- DA 1 BYPASS/AUTO – for DA 1, set jumper J6 for AUTO (pins 1-2) to enable auto reclocking (for signal data rates of 143, 177, 270, and 360 Mb/s) or BYPASS (pins 2-3) to bypass reclocking (for signals with data rates of 4 Mb/s to 360 Mb/s). This setting can be overridden by remote controls.
- DA 2 BYPASS/AUTO – for DA 2, set jumper J5 for AUTO (pins 1-2) to enable auto reclocking (for signal data rates of 143, 177, 270, and 360 Mb/s) or BYPASS (pins 2-3) to bypass reclocking (for signals with data rates of 4 Mb/s to 360 Mb/s). This setting can be overridden by remote controls.
- Local/Remote – set jumper J7 to LOCAL (pins 1-2) to lock out remote control or LOCAL & REMOTE (pins 2-3) for access to remote control. This setting cannot be overridden by remote controls.

Figure 4. 8937D On-Board Jumper Locations



## Looping Capabilities

The reclocked output signal from one 8937 or 8937D module may be looped to up to ten reclocked 8937 or 8937D modules in series for further distribution without degrading the signal.

The output signal from modules operating in Bypass mode (not reclocked to one of the standard rates) will begin to degrade by the third module in the series. This looping is not recommended.

# Cabling

## 8937 Module

Refer to [Figure 5](#) for cabling the 8937 module. Cabling to and from the module is done at the back of the Gecko 8900 video frame as described below.

**Note** At the back of every manual are two sets of printed overlay cards that can be placed over the rear connector BNCs to identify the specific connector functions.

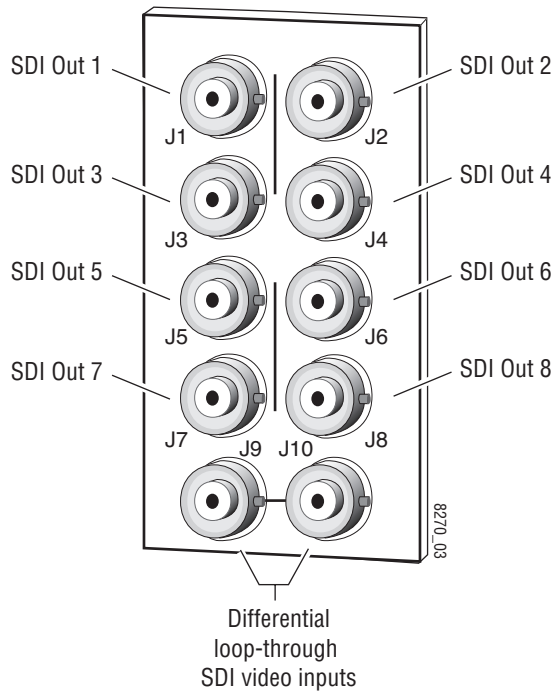
### Loop-Through Input

One serial digital component input is provided at differential loop-through BNCs J9 and J10. If the unused input is not looped to another device, it should be terminated in 75  $\Omega$ .

### Outputs

There are eight outputs for the 8937 module at BNCs J1 through J8. Output destination equipment should have an input impedance of 75  $\Omega$  unless it has loop-through inputs, in which case the loop-through inputs must be terminated into 75  $\Omega$ . All outputs are in phase with the input signal.

Figure 5. 8937 Rear Input/Output Connectors



## 8737D Module

Refer to [Figure 6](#) for cabling the 8937D module. Cabling to and from the module is done at the back of the Gecko 8900 video frame as described below.

**Note** At the back of every manual are two sets of six overlay cards that can be placed over the rear connector BNCs to identify the specific connector functions.

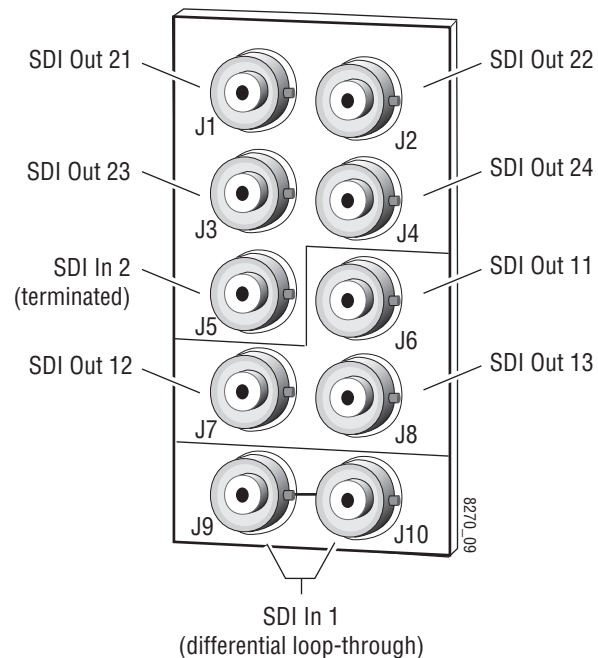
### DA 1 Inputs and Outputs

DA 1 provides one serial digital component input at loop-through BNCs J9 and J10. If the unused input is not looped to another device, it should be terminated in 75  $\Omega$ . The three outputs for DA 1 are from BNCs J6, J7, and J8. All outputs are in phase with the input signal.

### DA 2 Inputs and Outputs

DA 2 provides one terminated serial digital component input at BNC J5. The four outputs for DA 2 are from BNCs J1, J2, J3, and J4. All outputs are in phase with the input signal.

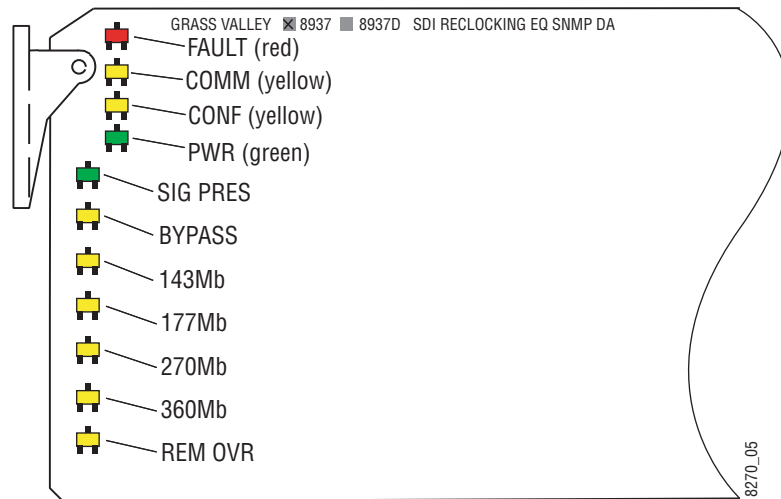
Figure 6. 8937D Rear Input/Output Connectors



# Power Up

The front LED indicators and configuration switches are illustrated for the 8937 in Figure 7. The 8937D module has an additional row of identical LEDs labeled for DA 1 and DA 2. Upon power-up, the green PWR LED should light and the yellow CONF LED should illuminate for a few seconds for the duration of module initialization.

Figure 7. LEDs and Configuration Switches



## Operation Indicator LEDs

Refer to Figure 7 and Table 2 for the name and meaning of each of the board edge operating indicators on the module circuit board.

Table 2. Board Edge LED Names and Meaning

LED	8937	8937D		Condition
		DA 1	DA 2	
<b>FAULT (red)</b>	Off	Off	Off	Normal operation.
	On continuously	On	On	Module has detected an internal fault. (Refer to <a href="#">Functional Description on page 30.</a> )
	Long Flash	Long Flash	Long Flash	Input missing or input does not match bit rate set with manual mode.
<b>COMM (yellow)</b>	Off	Off	Off	No activity on frame communication bus.
	3 Quick Pulses	3 Quick Pulses	3 Quick Pulses	Locate Module command received by the module from a remote control system.
	Short flash	Short flash	Short flash	Activity present on the frame communication bus.
<b>CONF (yellow)</b>	Off	Off	Off	Module is in normal operating mode.
	On continuously	On	On	Module is initializing, changing operating modes or programming hardware.
<b>PWR (green)</b>	Off	Off	Off	No power to module or module's DC/DC converter failed.
	On	On	On	Normal operation, module is powered.

Table 2. Board Edge LED Names and Meaning

LED	8937	8937D		Condition
		DA 1	DA 2	
<b>SIG PRES</b> (green)	Off	Off	Off	No signal input detected or input signal does not match bit rate set with manual mode.
	On	On	On	In Auto or Bypass mode input signal is present or input signal matches bit rate set with manual mode.
<b>BYPASS</b> (yellow)	Off	Off	Off	Reclocking is enabled and auto-rate detection mode is active.
	On	On	On	Bypass mode is on, input signal will not be reclocked
<b>143 Mb</b> (yellow)	Off	Off	Off	No 143 Mb speed signal present.
	On	On	On	Input signal is locked at 143 Mb
<b>177 Mb</b> (yellow)	Off	Off	Off	No 177 Mb speed signal present.
	On	On	On	Input signal is locked at 177 Mb
<b>270 Mb</b> (yellow)	Off	Off	Off	No 270 Mb speed signal present.
	On	On	On	Input signal is locked at 270 Mb
<b>360 Mb</b> (yellow)	Off	Off	Off	No 360 Mb speed signal present.
	On	On	On	Input signal is locked at 360 Mb
<b>REM OVR</b> (yellow)	Off	Off	Off	Module setting match those set on module switches and jumpers.
	On	On	On	Remote control is overriding on-board jumper setting

Table 3 provides the various output conditions possible for a given input and module setting.

Table 3. Possible Output Conditions

Input	Setting	Output Condition
Standard definition SDI video	Auto or Bypass	Standard definition SDI video
Other carrier	Bypass	Other carrier
Other carrier	Auto	Signal with errors
No signal or over EQ range	All modes	Muted

# Configuration

The 8937 and 8937D can be controlled and monitored remotely using the 8900NET network interface GUI or a networked control panel. Operation of these control types is explained in detail in their respective sections of this manual.

Refer to the following sections for configuration instructions:

- Remote Monitoring ([page 16](#))
- Control Panel Monitoring ([page 28](#))

## Remote Control and Monitoring

Module monitoring can be performed using a web browser GUI interface when the 8900NET Network Interface module is present in the frame (Gecko 8900TFN-V frame). This section describes the GUI access to the module functions.

For remote access, make sure the jumper block on the module is set for both Local and Remote access ([Figure 7 on page 14](#)).

Refer to the *8900NET Network Interface Module Instruction Manual* for information on the 8900NET Network Interface module and setting up and operating the Gecko 8900 frame network.

**Note** For optimal performance and access to the latest features, it is recommended that the 8900NET module be updated to the latest software release. Check the Grass Valley web site for the current 8900NET software.

Refer to the Gecko 8900 Frame Status page shown in [Figure 8 on page 17](#). The 8900 modules can be addressed by clicking either on a specific module icon in the frame status display or on a module name or slot number in the link list on the left.

**Note** The physical appearance of the menu displays on the web pages shown in this manual represent the use of a particular platform, browser and version of 8900NET module software. They are provided for reference only. Displays will differ depending on the type of platform and browser you are using and the version of the 8900NET software installed in your system.

Use the **Refresh** button to update the display (available with 8900NET software version 3.2.0 and later).

The **Online Manual Link** button can be set up to link to the documentation in pdf format. Link configuration is done on the Frame Configuration page as described in the *8900NET Instructions Manual*.

For information on status and fault monitoring and reporting shown on the Status page, refer to [Status Monitoring on page 32](#).



Figure 8. Gecko 8900 Frame Status Page

The Links section lists the frame and its current modules. The selected link's Status page is first displayed and the sub-list of links for the selection is opened. The sub-list allows you to select a particular information page for the selected device.

Content display section displays the information page for the selected frame or module (frame slot icons are also active links).

Refresh button for manual update of page

Online Manual Link

**Bay 2 8900 Frame 1**

- [Status](#)
- [Configuration](#)
- [1 8937](#)
- [2 8906](#)
- [3 8920DAC](#)
- [4 Media Slot 4](#)
- [5 8920DAC](#)
- [6 8920DMX](#)
- [7 8920MUX](#)
- [8 Media Slot 8](#)
- [9 Media Slot 9](#)
- [10 Media Slot 10](#)
- [11 8900NET](#)
- [12 Power Supply 1](#)
- [13 Power Supply 2](#)

**Status**

Model: 8900TFN Description: Module Frame

Frame Location: Back Room Top

Frame Health Status WARNING Temperature Status Pass

WARNING - Module Data or Config Errors

Module	Module	Module	Module	Module	Module	Module	Module	Empty	Empty	Empty	Net Card	Empty	Power Supply
--------	--------	--------	--------	--------	--------	--------	--------	-------	-------	-------	----------	-------	--------------

Front Cover No Cover

**Properties**

Vendor	Thomson, Grass Valley	Software Version	3.2.0
Media Slots	10	Network Config	Network configuration stored on 8900NET module

8270\_04

## 8937 and 8937D Links and Web Pages

The 8900 GUI provides the following links and web pages for the 8937 and 8937D modules (Figure 9):

- Status – reports input signal and frame bus communication status and module information (page 19),
- Standard Selections –allows enabling and disabling of signal loss reporting and selection of the standard selection mode (page 20),
- Recall Factory Defaults – provides factory default recall (page 24),
- Slot Config – provides a Locate Module function and Slot Memory (page 25), and
- Software Update – describes software updating procedure (page 27).

Figure 9. 8937 and 8937D Web Page Links

### 1 8937(D)

Status

Standard Selections

Recall Factory Defaults

Slot Config

Software Update

## Status Web Page

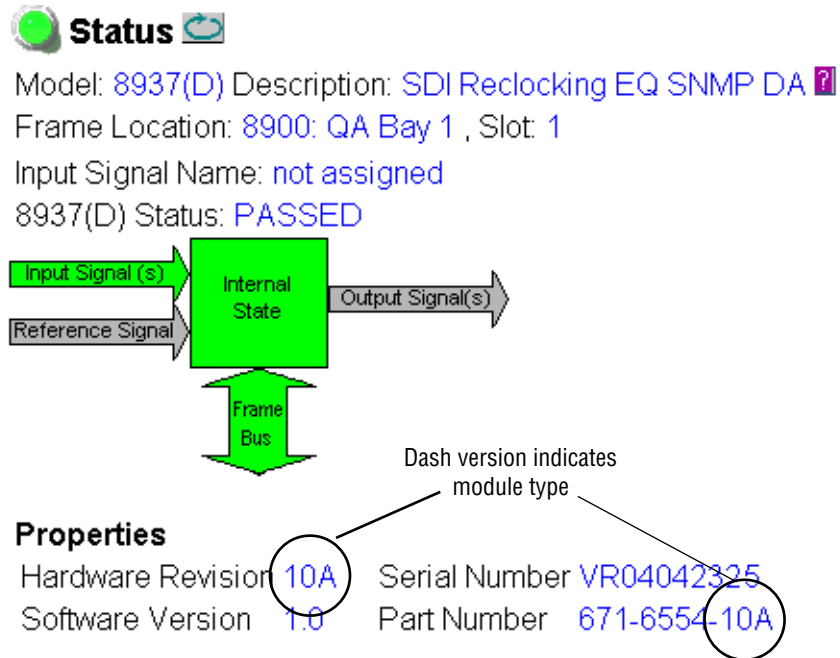
Use this link [Status](#)  
[Standard Selections](#)  
[Recall Factory Defaults](#)  
[Slot Config](#)  
[Software Update](#)

The Status web page (Figure 10) shows the signal status of the input signal and communication with the frame bus. Color coding of the display indicates the signal status. Refer to *Status Monitoring* on page 32 for an explanation of the color coding.

Information about the module, such as part number, serial number, hardware revision and software versions are given in a Properties section at the bottom of the display.

All web page displays for either the 8937 or 8937D module will show the model as 8937(D). To identify which module is installed, refer to the Hardware Revision or the Part Number field in the Properties section of the Status web page. 8937 modules are noted as a -00 while 8937D modules are noted as -10 (8937D shown in Figure 10).

Figure 10. 8937 and 8937D Status Web Page



## Standard Selections Web Page

Use this link  
[Status](#)  
[Standard Selections](#)  
[Recall Factory Defaults](#)  
[Slot Config](#)  
[Software Update](#)

The Standard Selections web page allows you to set loss of signal reporting and operating mode for the 8937 and 8937D modules. Refer to the specific 8937 or 8937D heading below.

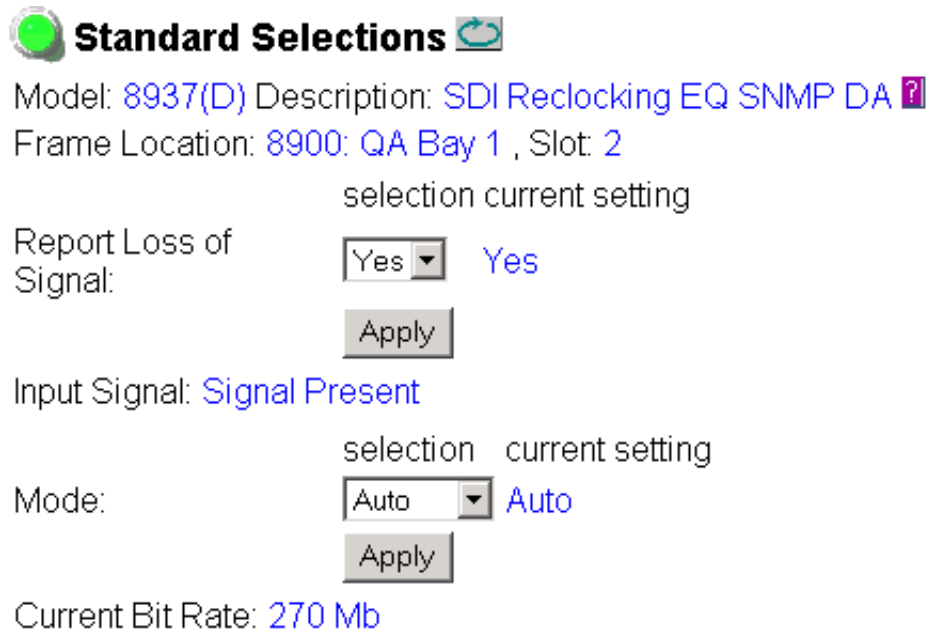
### 8937 Module

Refer to [Figure 11](#) for the Standard Selections web page for the 8937.

- Set the Report Loss of Signal input presence reporting to **Yes** or **No**. Disabling this control will gray out the Input signal on the Status web page graphic shown in [Figure 10 on page 19](#).
- The Input Signal field will report the status of the input signal.
- Set the Mode control to **Auto** (input bit rate standard detected by module), **Manual** (input bit rate standard selected manually), or **Bypass** (input bypasses reclocking circuitry).
- When Auto or Bypass mode is selected, the currently detected bit rate detected by the module will be displayed in the Current Bit Rate field.

Click the **Apply** button to enter any values.

Figure 11. 8937 Standards Selections Web Page



When Manual mode is selected, a Standard Selection pulldown will appear as shown in Figure 12.

Select a bit rate from the Standard Selection pulldown from one of the following:

- 143 Mb,
- 177 Mb,
- 270 Mb, or
- 360 Mb

The currently selected manual rate will be shown next to the pulldown.

Figure 12. 8937 Operating Mode Set to Manual

**Standard Selections**

Model: 8937(D) Description: SDI Reclocking EQ SNMP DA ?  
 Frame Location: 8900: QA Bay 1 , Slot: 2

Report Loss of Signal: selection current setting  
 Yes ▾ Yes  
 Apply

Input Signal: [Signal Present](#)

Mode: selection current setting  
 Manual ▾ Manual  
 Apply

Standard Selection: selection current setting  
 270 Mb ▾ 270 Mb  
 143 Mb  
 177 Mb  
 270 Mb  
 360 Mb

## 8937D Module

The Standards Selections page for the 8937D ([Figure 13 on page 23](#)) provides a common reporting of signal loss control for both DAs and two sets of separate controls for standard selection.

Click the **Apply** button to enter all values.

- The Report Loss of Signal control is common to both DAs. A loss of signal will be reported if either one or both DAs lose the input signal.

Set the input presence reporting to **Yes** or **No** for both DA 1 and DA 2. Disabling this control will gray out the corresponding Input signal on the Status web page graphic shown in [Figure 10 on page 19](#).



For DA 1:


- Set the Mode control for DA 1 to **Auto** (input bit rate standard detected by module), **Manual** (input bit rate standard selected manually), or **Bypass** (input bypasses reclocking circuitry).
- The Input Signal field will report the status of the DA 1 input signal.
- When Auto or Bypass mode is selected, the currently detected bit rate detected by the module will be displayed in the Current Bit Rate field.
- When **Manual** mode is selected, a Standard Selection pulldown will appear similar to the one shown in the DA 2 illustration in [Figure 13 on page 23](#). Select the bit rate from the Standard Selection pulldown (**143 Mb**, **177 Mb**, **270 Mb**, or **360 Mb**) as desired. The currently selected manual rate will be shown next to the pulldown.

For DA 2:

- Set the Mode 2 control for DA 2 to **Auto** (input bit rate standard detected by module), **Manual** (input bit rate standard selected manually), or **Bypass** (input bypasses reclocking circuitry).
- The Input Signal 2 field will report the status of the DA 2 input signal.
- When Auto or Bypass mode is selected, the currently detected bit rate detected by the module will be displayed in the Current Bit Rate 2 field.
- When **Manual** mode is selected, a Standard Selection 2 pulldown will appear similar to the one shown in [Figure 13 on page 23](#). Select the bit rate from the Standard Selection 2 pulldown (**143 Mb**, **177 Mb**, **270 Mb**, or **360 Mb**) as desired. The currently selected manual rate will be shown next to the pulldown.

Figure 13. 8937D Standard Selection Web Page

 **Standard Selections** 

Model: [8937\(D\)](#) Description: [SDI Reclocking EQ SNMP DA](#) 

Frame Location: [8900: QA Bay 1](#) , Slot: [2](#)

Report Loss of Signal:  selection current setting [Yes](#)

Input Signal: [Signal Present](#)

Mode:  selection current setting [Auto](#)

Current Bit Rate: [270 Mb](#)

Input Signal 2: [Signal Present](#)

Mode2:  selection current setting [Manual](#)

Standard Selection 2:  selection current setting [270 Mb](#)

## Recall Factory Defaults Web Page

Use [Status](#)  
this [Standard Selections](#)  
link [Recall Factory Defaults](#)  
[Slot Config](#)  
[Software Update](#)

Use the Recall Factory Defaults web page (Figure 14) to recall preset factory defaults of:

- Report Loss of Signal = **Yes**, and
- Mode Control = **Auto**.

**Note** For the 8937D module, this will recall factory defaults for both DAs.

Figure 14. 8937 and 8937D Recall Factory Defaults Web Page





## Slot Config Web Page

Use  
this  
link

- [Status](#)
- [Standard Selections](#)
- [Recall Factory Defaults](#)
- [Slot Config](#)
- [Software Update](#)

Use the Slot Config web page (Figure 15 on page 26) to perform the following functions on the module:

- **Locate Module** – selecting the **Flash** radio button flashes the yellow COMM LED on the front of the module so it can be located in the frame.
- **Slot Identification** – You may identify the module by typing a specific name in the **Name** field. The assigned name is stored on the 8900NET module and travels with the 8900NET module if it is moved to another frame. Select **Default** to enter the factory default module name.
- **Slot Memory** – the slot configuration for each media module is automatically saved periodically (once an hour) to the 8900NET module in that frame. You may also select the **Learn Module Config** button at any time to save the current configuration for this slot. The configuration is saved on the 8900NET module. If the 8900NET module is removed or powered down, the stored configurations are not saved.

When the **Restore upon Install** box has been checked, the current configuration saved to this slot is saved as slot memory. When the current module is removed and another module of the same type is installed, the configuration saved to the 8900NET module will be downloaded to the new module. The box must be checked before the current module with the saved configuration is removed.

- **Hardware Switch Controls** – a read-only status report of 8900NET module switch settings for Module Status Reporting and Asynchronous Status Reporting. These functions must be enabled for the following Slot SNMP Trap Reports to function.
- **Slot SNMP Trap Reports** – displayed only when the SNMP Agent software has been installed on the 8900NET module. Slot SNMP traps can be enabled only when the hardware switches for Module Fault reporting and Asynchronous Status reporting are enabled on the 8900NET module (dipswitch S1 segment 7 and dipswitch S2 segment 1).

The enabled SNMP traps will be reported to any SNMP manager that is identified as an SNMP Report Destination in 8900NET configuration. Trap severity is read-only hard-coded information that is interpreted and responded to by the SNMP Manager software configuration.

SNMP reporting can also be disabled for the signal input(s) on the Standard Selections web page.

Figure 15. 8937 and 8937D Slot Config Page

 **Slot Config** 

Model: [8937\(D\)](#) Description: [SDI Reclocking EQ SNMP DA](#)   
 Frame Location: [8900: QA Bay 1](#) , Slot: [2](#)

**Locate Module**

Flash  Off

**Slot Identification**

Name:

Input Signal Name:

**Slot Memory**

Restore upon Install

**Hardware Switch Controls**

Module Status Reporting: [Enabled](#) Asynchronous Status Reporting: [Enabled](#)

**Slot SNMP Trap Reports**

	Slot Fault	Module Removed	Signal Loss	Reference Loss
Enabled	<input checked="" type="checkbox"/>	<input type="checkbox"/>	<input checked="" type="checkbox"/>	<input checked="" type="checkbox"/>
Trap Severity	<a href="#">Alarm</a>	<a href="#">Warning</a>	<a href="#">Warning</a>	<a href="#">Warning</a>

## Software Update Web Page

Use  
this  
link \

- [1 8937\(D\)](#)
- [Status](#)
- [Standard Selections](#)
- [Recall Factory Defaults](#)
- [Slot Config](#)
- [Software Update](#)

The Software Update web page ([Figure 16](#)) indicates that module software updates via the web or using the NetConfig networking application are not supported.

Refer to the release notes for the latest software upgrade for instructions on updating 8937 software.

Figure 16. 8937 and 8937D Software Update Web Page

### **Software Update**

Model: [8937\(D\)](#) Description: [SDI Reclocking EQ SNMP DA](#) 

Frame Location: [8900: QA Bay 1](#) , Slot: [2](#)

Software Version: [1.0](#)

Module Update: [Not Supported](#)

[Override Unsupported Update](#)

## Newton Control Panel Configuration

The Newton control panel is available to interface over the network to the 8937 and 8937D modules. The configuration functions available with the Grass Valley Newton Control System are shown in the Newton Control Panel Configurator illustration in [Figure 17](#).

**Note** Available parameters will depend on the module type installed. This example reflects the 8937D module.

Figure 17. Newton Configurator Control Panel Parameters

PID	IID	Label	Type	Description
51	0	State	switch	Slot Status
52	0	Input Sig	switch	Input Signal
59	0	Ref Sig	switch	Reference Signal
710	0	Mode	switch	Mode
711	0	StdSel	switch	Standard Selection
712	0	CurRt	switch	Current Bit Rate
715	0	RepLOS	switch	Report Loss of Signal
810	0	Mode2	switch	Mode2
811	0	StdSel2	switch	Standard Selection 2
812	0	CurRt2	switch	Current Bit Rate 2

8937D only

Installation, configuration, and operation of the Newton Modular Control System is provided in a separate manual provided with the control panel option.

# Specifications

Table 4. 8937 and 8937D Specifications

Parameter	Value
<b>Serial Digital Component Inputs</b>	
Number of inputs	8937: 2 BNC differential loop-through 8937D: DA 1 – 2 BNC loop-through 8937D: DA 2 – 1 terminated BNC
Input impedance	High Z
Signal type	Serial digital SMPTE 259M (143 Mb/s, 177 Mb/s, 270 Mb/s, 360 Mb/s), SMPTE 310M, DVB-ASI
Reclocked data rates	143 Mb/s, 177 Mb/s, 270 Mb/s, and 360 Mb/s
Supported data rates	4 Mb/s to 360 Mb/s
Signal level	SDI 800 mV p-p ( $\pm 10\%$ maximum)
Return loss	> 15 dB 4 MHz to 360 MHz
Automatic cable equalization (Belden 8281 cable)	< 300 meters up to 270 Mb/s < 200 meters up to 360 Mb/s
<b>Serial Digital Component Outputs</b>	
Number of outputs	8937: 8 BNCs 8937D: DA 1 – 3 BNCs 8937D: DA 2 – 4 BNCs
Output impedance	75 $\Omega$
Signal types	Serial digital SMPTE 259M (143 Mb/s, 177 Mb/s, 270 Mb/s, 360 Mb/s), SMPTE 310M, DVB-ASI
Signal level	SDI 800 mV p-p ( $\pm 10\%$ maximum)
Return loss	> 15 dB 4 MHz to 360 MHz
Error checking	Transparent to embedded EDH
Electrical length	< 20 ns
Output polarity	Non-inverted
Rise and fall time	400 – 700 ps
Jitter	< 0.2 UI
<b>Environmental</b>	
Frame temperature range	Refer to frame specification
Operating humidity range	10 to 90% non-condensing
Non-operating temperature	-10 to + 70 degrees C
<b>Mechanical</b>	
Frame type	Gecko 8900 Video/8800/8500 (with trace cut),
<b>Power</b>	
Power consumption	< 3 W

## Functional Description

### Input and Output Processing

The input section(s) receive SD (standard definition) video from the rear input BNCs and send it to signal equalizing and reclocking circuits. The input section can also bypass reclocking circuits to the output amplifiers. The output amplifiers drive eight equal-phase outputs on the rear backplane for the 8937 and one set of four outputs and one set of three outputs for the 8937D.

**Note** All outputs are in phase with the input signal.

### Microprocessor and Input Selector

The primary purpose of the microprocessor is to provide remote control and monitoring capability for the module. It receives signal present, signal lock, and speed detection signals from the equalizer and reclocker circuits. Using this information, local jumper settings, and remote control commands, the microprocessor selects the internal signal path and gives feedback through the LEDs and remote control bus.

User-enabled video presence detection generates individual SNMP traps for each channel that can be sent to an SNMP manager via the microprocessor.

# Service

The 8937 and 8937D modules make extensive use of surface-mount technology and programmed parts to achieve compact size and adherence to demanding technical specifications. Circuit modules should not be serviced in the field unless directed otherwise by Customer Service.

If your module is not operating correctly, proceed as follows:

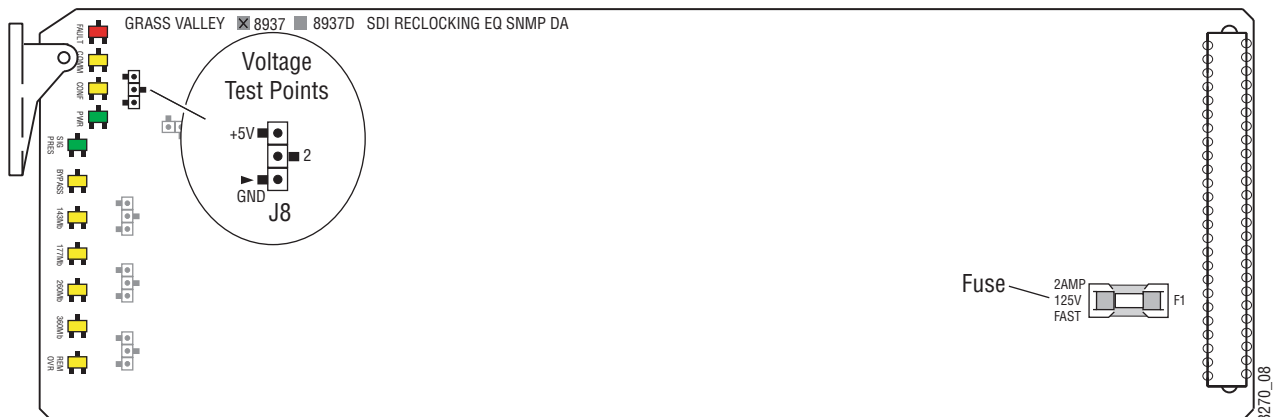
- Check frame and module power and signal present LEDs.
- Verify power at the voltage testpoints (see [Figure 18](#)) and check fuse if no voltage is detected.
- Check for presence and quality of input signals.
- Verify that source equipment is operating correctly.
- Check cable connections.

Refer to [Figure 7](#) for the location of PWR LED and [Table 2 on page 14](#) for proper LED indications.

If the module is still not operating correctly, replace it with a known good spare and return the faulty module to a designated Grass Valley repair depot. Call your Grass Valley representative for depot location.

Refer to the [Contacting Grass Valley](#) at the front of this document for the Grass Valley Customer Service Information number.

Figure 18. 8937 and 8937D Fuse and Voltage Testpoint Locations



## Status Monitoring

This section provides a summary of status monitoring and reporting for a Gecko 8900 Series system. It also summarizes what status items are reported and how to enable/disable reporting of each item. There are a number of ways to monitor status of modules, power supplies, fans and other status items depending on the method of monitoring being used.

8900 Frame status will report the following items:

- Power supply health,
- Status of fans in the frame front cover,
- Temperature,
- Module health, and
- Frame bus status.

Module health status will report the following items:

- Internal module state (and state of submodule or options enabled) including configuration errors (warning), internal faults, and normal operation (Pass).
- Signal input states including valid/present (pass), not present or invalid (warning), not monitored (unknown), and not available (no signal inputs).
- Reference input states including locked/valid (pass), not locked/invalid (warning), and not monitored (unknown).
- Signal output states with reporting functionality (reference output).

## LEDs

LEDs on modules in the frame and on the front of the 8900TF/TFN frames indicate status of the frame and the installed power supplies, fans in the front covers, and modules.

When a red FAULT LED is lit on a frame front cover, the fault will also be reported on the 8900NET or Frame Monitor module. The LEDs on the front of these modules can then be read to determine the following fault conditions:

- Power Supply 1 and 2 health,
- Fan rotation status,
- Frame over-temperature condition,
- Frame Bus fault (8900NET only), and
- Module health bus.



In general, LED colors used on the frame and modules indicate:

- Green = normal operation, (Pass) or signal present, module locked.
- Red – On continuously = fault condition, flashing = configuration error.
- Yellow – On continuously = active condition (configuration mode or communication), flashing in sequence = module locator function.

Status LEDs for this module are described in [Operation Indicator LEDs on page 14](#). LEDs for the 8900NET module are described in the *8900NET Network Interface Instruction Manual*.

## Frame Alarm

A Frame Alarm connection is available on pins 8 and 9 of the RS-232 connector on the rear of the 8900 frame (Frame Monitor or 8900NET Network Interface module required). This will report any of the status items enabled with the 8900NET or Frame Monitor module configuration DIP switch. Connection and use of the Frame Alarm is covered in detail in the *8900NET Network Interface Instruction Manual*.

## Web Browser Interface

When the 8900NET module is installed in the frame, a web browser GUI can indicate frame and module status on the following web pages:

- Frame Status page – reports overall frame and module status in graphical and text formats.
- Module Status page – shows specific input and reference signal status to the module along with enabled options and module versions.
- A Status LED icon on each web page to report communication status for the frame slot and acts as a link to the Status page where warnings and faults are displayed (8900NET version 3.0 or later).

In general, graphics and text colors used indicate the following:

- Green = Pass – signal or reference present, no problems detected.
- Red = Fault – fault condition.
- Yellow = Warning – signal is absent, has errors, or is mis-configured.
- Gray = Not monitored (older 8900 module).
- White = Not present.

Status reporting for the frame is enabled or disabled with the configuration DIP switches on the 8900NET module. Most module status reporting items can be enabled or disabled on individual configuration web pages.

## SNMP Reporting

The Gecko 8900 Series system uses the Simple Network Monitoring Protocol (SNMP) internet standard for reporting status information to remote monitoring stations. When SNMP Agent software is installed on the 8900NET module, enabled status reports are sent to an SNMP Manager such as the Grass Valley's NetCentral application.

There are both hardware and software report enable switches for each report. Both must be enabled for the report to be sent. Software report switches are set on the 8900NET Configuration page for the Frame, the 8900NET module, and each module slot. Refer to the *8900NET Network Interface Instruction Manual* for installation instructions.

# Index

## Numerics

- 8900 frame
  - frame alarm 33
  - module capacity 8
  - status reporting 32
- 8900NET module
  - installation 8
- 8937 module
  - features 7
- 8937D module
  - features 7

## B

- backplane 9

## C

- cabling
  - 8937 12
  - 8937D 13
- COMM LED 14
- CONF LED 14
- configuration
  - Remote, GUI 16
- connectors 9
- controller module 8

## D

- documentation online 2, 16

## E

- enable SNMP 34
- environmental 29

## F

- FAQ database 2
- FAULT LED

- states 14
- troubleshooting 32
- Frame Controller module 8
- Frame Status page 33
- frequently asked questions 2
- functional description 30
- fuse 31

## G

- Gecko frame 8, 29
- graphical user interface (GUI) 18
- Grass Valley web site 2

## I

- identifying module type 19
- inputs
  - specification 29
- installation 8

## J

- jumpers, on-board
  - 8937 10
  - 8937D 11

## L

- LEDs
  - front edge 14
  - Names and Meanings table 14
- locate module 25
- looping modules 11

## M

- manual mode
  - 8937 21
  - 8937D 22
- module

## Index

- controller 8
- installation 8
- power supply 8
- slots 9
- module health status 32
- Module Status web page 33

## N

- Newton Control Panel
  - configuration 28
  - overview 28

## O

- online documentation 2
  - Online Manual Link 16
- Online Manual Link 16
- outputs
  - specification 29
- overlay 12, 13

## P

- power 29
- power supply 8
- power up 14
- PWR LED 14

## R

- rear connectors 9
- Recall Factory Defaults web page 24
- Refresh button 16
- REM OVR LED 15
- repair depot 31
- report enable switches 34

## S

- Slot Config web page 25
- slot memory 25
- SNMP reporting
  - enabling 25
  - overview 34
- software download from web 2

- Software Update web page 27
- specifications 29
- Standard Selections web page
  - 8937 20
  - 8937D 22
- status monitoring 32
- Status web page 19

## T

- testpoints 31
- TRK ON LED 15
- troubleshooting 31

## V

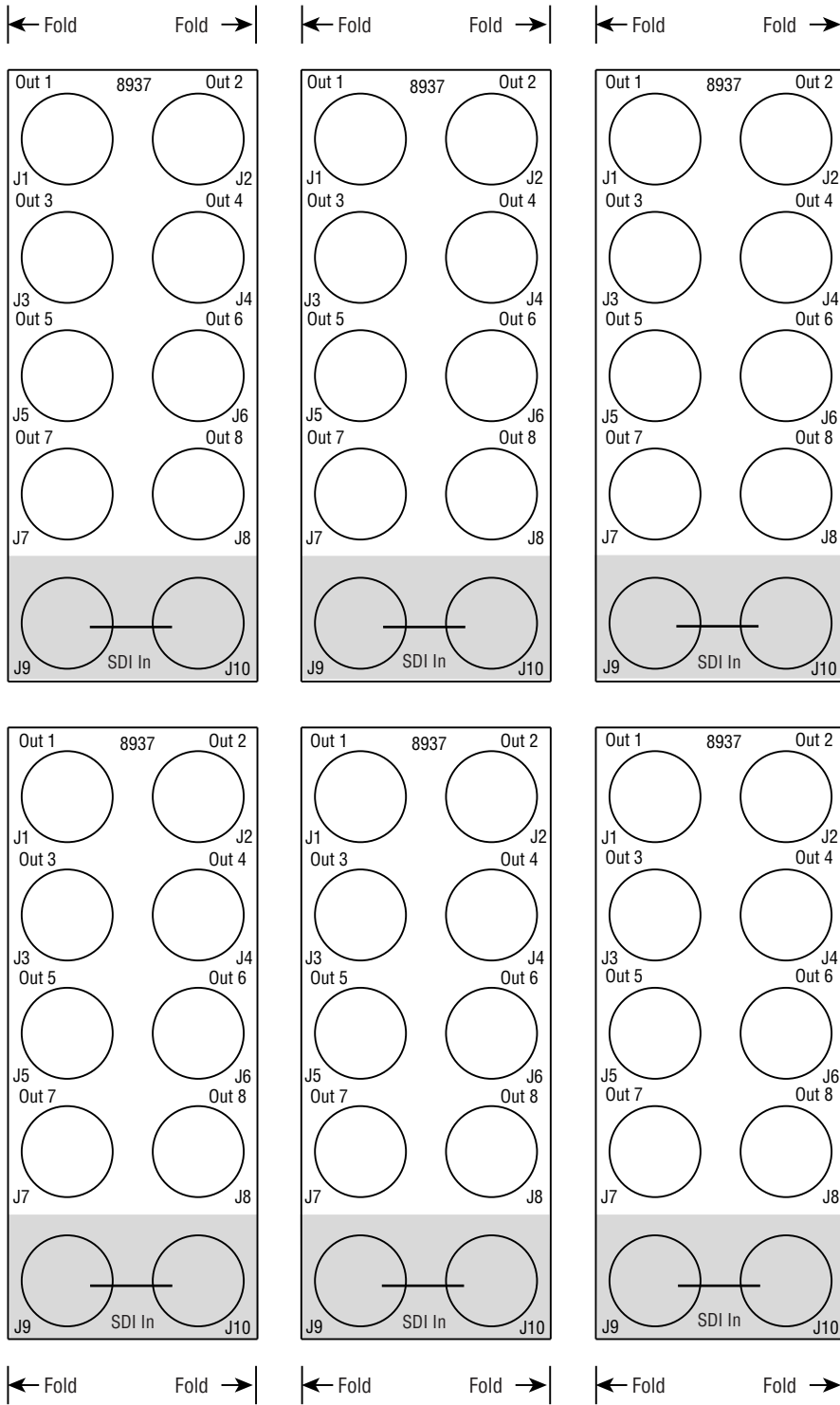
- voltage tespoints 31

## W

- web site documentation 2
- web site FAQ database 2
- web site Grass Valley 2
- web site software download 2

# 8937 SDI Reclocking EQ SNMP DA Module Rear Connector Overlay

Fold along vertical lines to break perforations, then tear to separate vertical pairs.





# 8937D Dual SDI Reclocking SNMP EQ DA Module Rear Connector Overlay

Fold along vertical lines to break perforations, then tear to separate vertical pairs.

