

Telecast Fiber Solutions

Cobra 2DT User Guide

M4021-9900-102

24 July 2014



Copyright & Trademark Notice

Copyright © 2012–2014, Grass Valley. All rights reserved.

Belden, Belden Sending All The Right Signals, and the Belden logo are trademarks or registered trademarks of Belden Inc. or its affiliated companies in the United States and other jurisdictions. Grass Valley, Cobra 2DT are trademarks or registered trademarks of Grass Valley. Belden Inc., Grass Valley, and other parties may also have trademark rights in other terms used herein.

Terms and Conditions

Please read the following terms and conditions carefully. By using Cobra 2DT documentation, you agree to the following terms and conditions.

Grass Valley, a Belden Brand (“Grass Valley”) hereby grants permission and license to owners of Cobra 2DT to use their product manuals for their own internal business use. Manuals for Grass Valley products may not be reproduced or transmitted in any form or by any means, electronic or mechanical, including photocopying and recording, for any purpose unless specifically authorized in writing by Grass Valley.

A Grass Valley manual may have been revised to reflect changes made to the product during its manufacturing life. Thus, different versions of a manual may exist for any given product. Care should be taken to ensure that one obtains the proper manual version for a specific product serial number.

Information in this document is subject to change without notice and does not represent a commitment on the part of Grass Valley.

Warranty information is available in the Support section of the Grass Valley Web site (www.miranda.com).

Title	Cobra 2DT User Guide
Part Number	M4021-9900-102
Revision	24 July 2014

toc

Table of Contents

1	About Cobra 2DT	1
	About the Cobra 2DT System	2
	Unpacking the Cobra 2DT	3
	Product Returns	3
	Safety and Fiber Optic Systems	4
	Optical Fiber Safety	4
	FCC Part A Manual Notice	4
2	Cobra 2DT Components	5
	Fiber Cable Overview	6
	Fiber Optic Connector Types	6
	Triaxial Connector Types	7
	Cobra 2DT Fiber Optic Camera Interface Components	8
	Cobra 2DT Fiber Optic Camera Interface Operational Areas	9
	Area A - Power Connection	9
	Area B - Fiber Optic Connection	9
	Area C - Cable and System Status Monitoring	10
	Area D - Camera or Camera Control Unit Connector	10
	Area E - Optical Power Monitoring	11
	Using the Cobra 2DT Camera Interface Optical Power Indicators	12
	Best Practices	13
	Block Diagrams	14
	Troubleshooting	15
3	Specifications	17
A	Ordering Information	20
	Part Numbers and Parameters	21
	Typical Model Part Numbers	22



About Cobra 2DT

This chapter provides an overview of the Cobra 2DT and includes the safety and warranty information about it.

<i>About the Cobra 2DT System</i>	2
<i>Safety and Fiber Optic Systems</i>	4

About the Cobra 2DT System

The Cobra 2DT Fiber Optic Camera Interface allows you to use fiber cable to extend the link between a high definition "digital triax" camera and the associated camera control units (CCU's). The initial product release of the Cobra 2DT is compatible with the Sony HXC100 and HSC300.

The Cobra 2DT can be delivered in a number of configurations depending on the Fiber Optic Cable Connector or Camera/CCU connector options selected.

The Cobra 2DT system uses a pair of fiber optic transceivers that convert the camera and CCU's digital RF signals to optical signals, transmitting them on a fiber cable, using one or two strands to deliver all of the bidirectional video, audio, intercom, and camera control signals between the camera and base station. Signal strength meters provide real-time status at each end of the link.

The Cobra 2DT handles the following signals:

- High-Definition Digital Video
- Return video & Genlock
- Audio, intercom & IFB
- Control data & tally

The camera chain can be extended to over 40 kilometers (24.85 miles) using existing infrastructure or "dark fiber" fiber optic cable.

The Cobra 2DT Camera Interface Unit operates at 100-240VAC, 50/60Hz power and provides power to the camera by reinserting power up to 300 meters (1000 feet) of triax cable, depending on camera/CCU model. The Base Unit is powered from the camera chain's CCU. One or two of the base units can be configured into a single 1RU rack-mountable enclosure.

Optionally, up to eight camera chains can be multiplexed on to a single fiber strand using the TelePort System. Contact Grass Valley (see [Contact Us](#) on page 19) or your local distributor for more information.

The following illustration shows one of a multitude of possible scenarios for the Cobra 2DT. This example shows a simple Camera to CCU extension using a set of Cobra 2DT units.

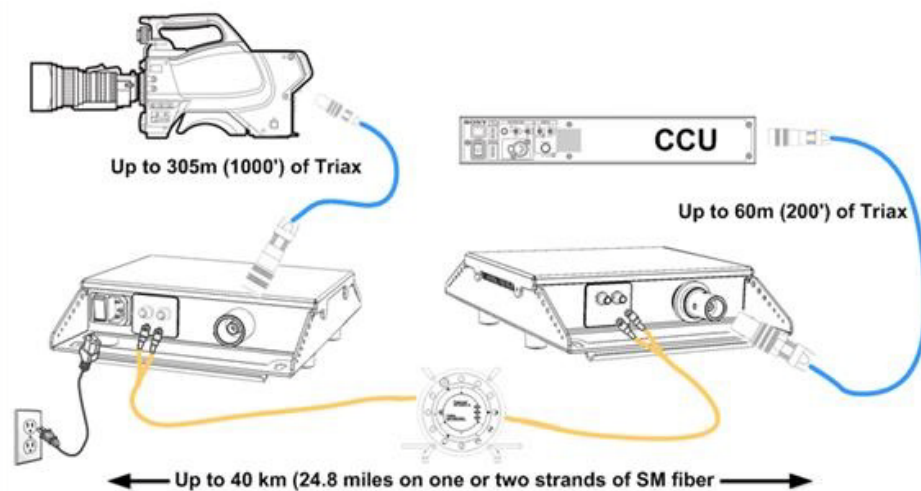

Fig. 1-1: Cobra 2DT Fiber Optic Camera Interface for Digital Triax Camera System Usage Example

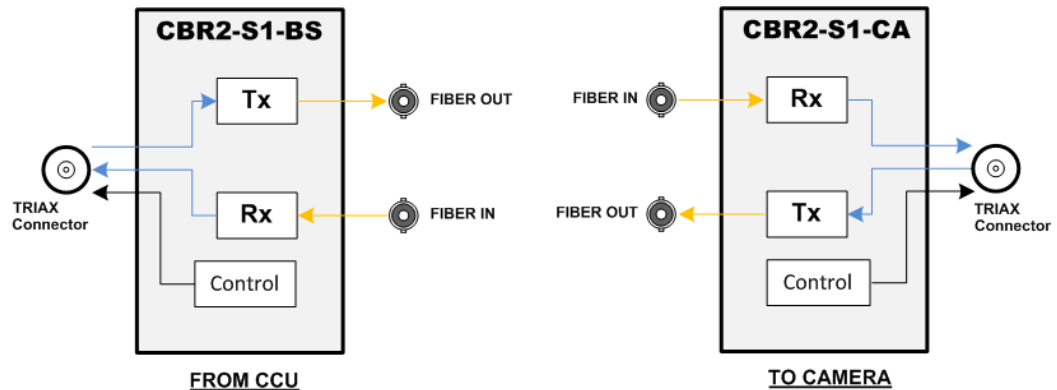

Fig. 1-2: Cobra 2DT Fiber Optic Camera Interface for Digital Triax Camera System Block Diagram

Unpacking the Cobra 2DT

Consult your packing slip and purchase order to ensure that you have received all of the expected components.

Inspect all components for scratches and other mechanical damage, and inspect the electrical connectors for bent or damaged pins and latches. Report any missing or damaged components to Grass Valley technical support (see [Contact Us](#) on page 19).

Leave the protective caps on the optical connectors whenever the fiber is disconnected.

Product Returns

In the unlikely event of damage to your Cobra 2DT during shipping or delivery, take note of any damage with the delivery or shipping service. If any component does not work correctly out of the box, contact Grass Valley technical support (see [Contact Us](#) on page 19).

If the problem cannot be remedied through a service telephone call, you will receive an RMA number (Return of Merchandise Authorization). Take note of this RMA number inside and outside of all shipping boxes and on all documentation provided with the items to be returned.

Safety and Fiber Optic Systems

Optical Fiber Safety

- This Cobra 2DT contains CDRH Class 1 laser devices. To prevent damaging your eyes, always avoid looking directly at, or staring into, the laser light located on an optical connector or on the end of a fiber.
- Infrared radiation is produced at the fiber connection port on the rear of the TX units and at the end of any un-terminated optical fibers that are attached to this port. Avoid any direct exposure to the light that comes from these sources.
- Do not power up the unit when there is no fiber connector attached to the fiber port.
- You cannot make manual adjustments inside the Cobra 2DT. Do not attempt any type of service to this instrument other than any as instructed this manual. Refer all servicing to the Fiber Solutions division of Grass Valley (see [Contact Us](#) on page 19).
- Always use cable connector caps when the cables are not connected. This protects the connector from damage and the unlikely event of exposure to an operating optical link. Keeping the caps in place when the connectors are not in use will prevent dirt and dust from entering the connector and degrading the performance of the optical link.
- You should read the **Using Fiber Optics** document for information on how to manage and deploy your fiber optics cabling. You can find a copy of this document on the Support portal (see [Contact Us](#) on page 19).

FCC Part A Manual Notice



This equipment has been tested and found to comply with the limits for a Class A digital device, pursuant to part 15 of the FCC rules. These limits are designed to provide reasonable protection against harmful interference when the equipment is operated in a commercial environment. This equipment generates, uses, and radiates radio frequency (RF) energy and, if not installed and used in accordance with this instruction manual, may cause harmful interference to radio communications.

Cobra 2DT Components



This chapter describes the main components of the Cobra 2DT.

<i>Fiber Cable Overview</i>	6
<i>Cobra 2DT Fiber Optic Camera Interface Components</i>	8
<i>Best Practices</i>	13
<i>Block Diagrams</i>	14
<i>Troubleshooting</i>	15

Fiber Cable Overview

Fiber Optics and Fiber Optic Cable are the core technologies at the heart of the Cobra 2DT Fiber Optic Camera Interface for Digital Triax Camera System system. The ability to multiplex and de-multiplex a variety of video, audio and data signals so that they can be carried over a thin strand of Fiber Optic cable for long distances enables the Cobra 2DT. The specific theory and operation of Fiber Optics is beyond the scope of this document.

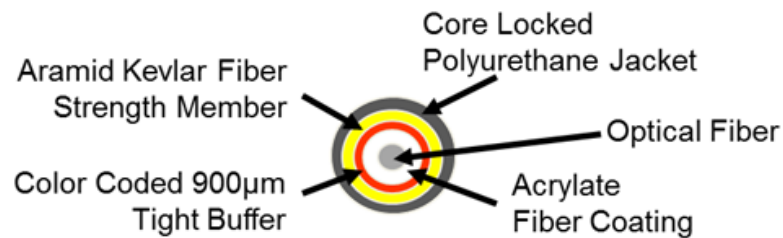

Fig. 2-1: Single Mode Fiber Optic Cable Cross-Section

Fiber Optic Connector Types

The Cobra 2DT can be equipped with a variety of Fiber Optic Connectors and with a choice of three industry standard Triaxial connectors. The standard Cobra 2DT comes with two ST connectors. .

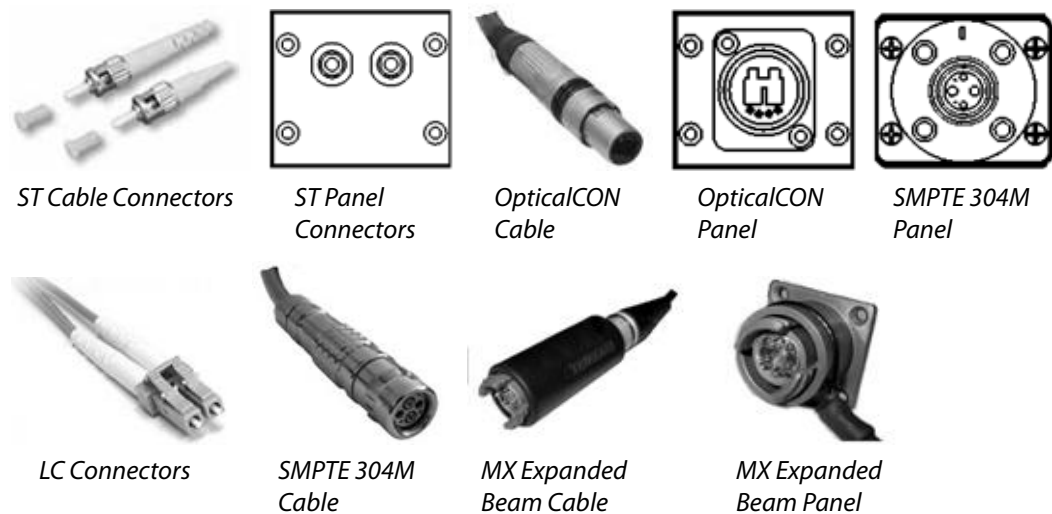

Fig. 2-2: Fiber Optic Connectors

For other options, see below and [Ordering Information](#) on page 20

Triaxial Connector Types

The Cobra 2DT should be ordered with Triax connectors that match your existing Camera/CCU.



Kings Tri-Loc



Fischer



Damar-Hargen

Fig. 2-3: Triaxial Connector Types

Cobra 2DT Fiber Optic Camera Interface Components

The Cobra 2DT system consists of two units:

- **Camera Unit:** the unit that is attached to the camera via triax cable
- **Base Unit:** the unit that is attached to the Camera Control Unit (CCU) via triax cable

All connections and system monitoring are on the front panel of both units. There are five areas of operational interest.

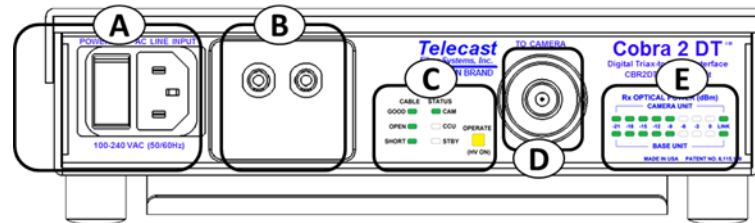

Fig. 2-4: Cobra 2DT Camera Unit

The Cobra 2DT Camera Unit operational areas:

- **A - Power Connection**
- **B - Fiber Optic Connection(s)**
- **C - Cable and System Status Monitoring**
- **D - Camera Connector**
- **E - Optical Power/Link Monitoring**

Each of these areas is described in detail below.

The Base Unit shares the same fiber and triax connectivity as well as status and optical monitoring indicators, but does not have a Power Connection and does not have Cable Status monitoring.

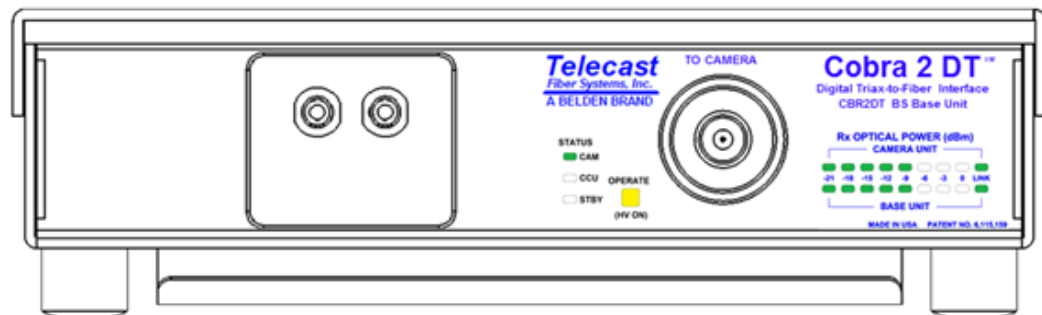

Fig. 2-5: Cobra 2DT Base Unit

Cobra 2DT Fiber Optic Camera Interface Operational Areas

The Cobra 2DT Camera Interface has no user operated components. Once the units are connected and the Camera unit powered, you only need to monitor the various cable, system and Optical Power monitors provided by the system. All operational activity takes place at the Camera or the CCU.

Area A - Power Connection

The Camera Unit requires 100-240VAC - 50/60Hz power.

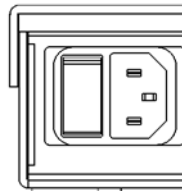

Fig. 2-6: Camera Unit Power Connection

A standard IEC power inlet receptacle is provided to connect the Camera Unit to AC line voltage.

The Cobra 2DT Camera Interface provides camera power with cable-check interlock which provides user safety. This means that the camera cable must be properly connected at both ends before power is applied.

Area B - Fiber Optic Connection

The Cobra 2DT Camera Interface can be supplied with a variety of five Fiber Optic Connector styles which must be specified at the time of order.

The example shown is a pair of ST connectors.

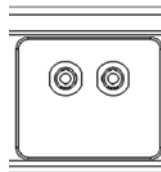

Fig. 2-7: Fiber Optic Connection

To prevent damaging your eyes, NEVER look into a powered Fiber Optic connection. Always keep the fiber optic connectors covered (regardless of type) when not in use. This also prevents dirt damage to the connector which could degrade the signal quality.

Area C - Cable and System Status Monitoring

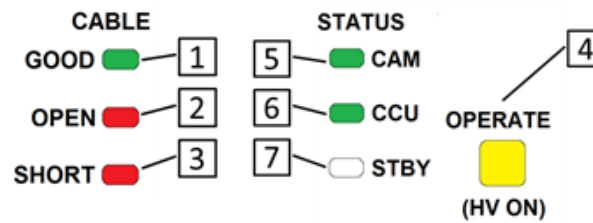

Fig. 2-8: Cable and System Status Monitoring

Items 1 through 3 are only present on the Cobra 2DT Camera Interface Unit.

- **Good (1):** shows Green if Camera to Cobra 2DT Camera Interface cable connection is good.
- **Open(2):** shows Red if there is any open condition in the Camera to Cobra 2DT Camera Interface cable. Under normal conditions this indicator is off.
- **Short(3):** shows Red if there is any short condition in the Camera to Cobra 2DT Camera Interface cable. Under normal conditions this indicator is off.
- **Operater (4):** shows Yellow when the camera operating voltage is turned on and after all cable interconnect and camera communication conditions for both ends of the system have been properly established.
- **CAM (5):** shows Green if the Cobra 2DT Camera Interface Unit is connected to the camera and all cable interconnect and camera communication conditions have been properly established.
- **CCU (6):** shows Green if the Cobra 2DT Base Unit is connected to the CCU and all cable interconnect and CCU communication conditions have been properly established.
- **STBY (7):** shows Green only when the camera is switched to standby and all cable interconnect and camera communication conditions for both ends of the system have been properly established. turns off when camera power is switched on.

Area D - Camera or Camera Control Unit Connector

The Cobra 2DT Camera Interface can be equipped with one of three Triax connector types. The proper type for your system must be specified at time of order.

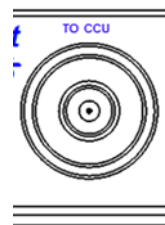

Fig. 2-9: Camera or Camera Control Unit Connector

The Cobra 2DT Camera Interface Base unit comes with a Male Triax connector and the Cobra 2DT Camera Interface Camera Unit comes with a Female Triax connector.

The Cobra 2DT Camera Interface system requires two Triax cables - one between the Camera and the Cobra 2DT Camera Interface Camera Unit and one between the CCU and the Cobra 2DT Camera Interface Base Unit. Both of these cables are end-user supplied.

Area E - Optical Power Monitoring

Both the Cobra 2DT Camera Interface Camera Unit and the Base unit provide Optical Power monitoring for both the Camera unit and the Base unit. The metering uses Multi-Colored LEDs with indicators covering a range of -21dBm to 0 dBm. The Cobra 2DT Camera Interface is specified to operate at Optical Power levels above -22dBm.

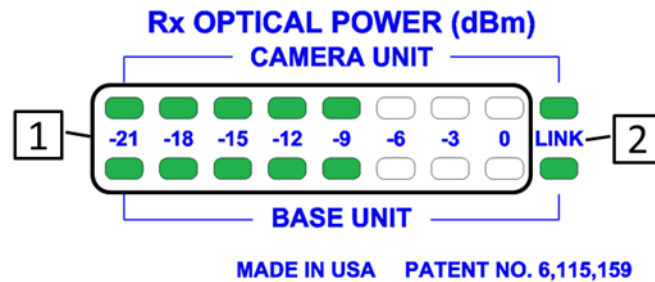

Fig. 2-10: Optical Power Monitoring

- 1 The Optical Power level at the Camera Unit is measured on the top row of LEDs across a range of -21 dBm to 0 dBm.

The bottom row measures the Optical Power level at the Base Unit.

- 2 The quality of the Fiber Optic Link between the Cobra 2DT Camera Interface Camera Unit and Base Unit is indicated by the LINK LED.

The multi-colored LEDs indicate the following:





- **Green** - Good power
- **Yellow Orange** - Marginal power
- **Red** - Insufficient power

The practical application of these indicators is described in [Using the Cobra 2DT Camera Interface Optical Power Indicators](#) on page 12.

Note: Because the Cobra 2DT is a digital system, the link will operate properly at the lowest acceptable signal strength. If the signal strength dips below the minimum acceptable level, the link will not function.

Using the Cobra 2DT Camera Interface Optical Power Indicators

This section illustrates five operational scenarios in which the Optical Power Indicator LEDs and the Link LED provide a visual indication of the Cobra 2DT Camera Interface system status.

LEDs	Description
 <p>Rx OPTICAL POWER (dBm) CAMERA UNIT -21 -18 -15 -12 -9 -6 -3 0 LINK BASE UNIT</p>	<p>In this scenario, the system is operating well. The -6 dBm reflects typical signal strength across a Fiber Optic cable run. The Cobra 2DT Camera Interface will run perfectly at this signal strength.</p>
 <p>Rx OPTICAL POWER (dBm) CAMERA UNIT -21 -18 -15 -12 -9 -6 -3 0 LINK BASE UNIT</p>	<p>In this scenario, there is a bad Fiber Optic link and no Optical Power in either direction. Check to see if there is a problem with the Fiber Optic connection or cable.</p>
 <p>Rx OPTICAL POWER (dBm) CAMERA UNIT -21 -18 -15 -12 -9 -6 -3 0 LINK BASE UNIT</p>	<p>In this scenario, there is just enough Optical Power present to provide an operational link. Check the Fiber Optic cable run for possible damage or physical interference such as sharp bends in the cable. Also check the Fiber Optic connectors for dust, dirt, or any kind of damage.</p>
 <p>Rx OPTICAL POWER (dBm) CAMERA UNIT -21 -18 -15 -12 -9 -6 -3 0 LINK BASE UNIT</p>	<p>In this scenario, there is low Optical Power but more than adequate for a usable link. Keep an eye on the reading to ensure it is consistent. Check the cable run as above and check the Fiber Optic connectors for dust, dirt or damage.</p>
 <p>Rx OPTICAL POWER (dBm) CAMERA UNIT -21 -18 -15 -12 -9 -6 -3 0 LINK BASE UNIT</p>	<p>In this scenario, there is a signal overload and is applicable only to the high-power laser option available when ordering the Cobra 2DT. In this case, the LEDs will flash Red to indicate an overload condition. The unit may still function properly depending on how severe the overload is, but operation is not guaranteed.</p>

Best Practices

- Take all the necessary precautions to prevent damaging your eyes when handling the optical equipment.
- Protect the Fiber Optic Cable and the Fiber Optic Connectors. **Always** keep these capped unless there are being connected.
- Read the Guide on planning the Fiber Run.

The Using Fiber Optics Guide explains how to manage and deploy your fiber optics cabling, safety precautions, tips & tricks, and recommendations for creating complex fiber optic networks. You can find a copy of this document on the Support portal (see [Contact Us](#) on page 19).

- Make sure that the Cobra 2DT unit is secure and cannot be inadvertently moved. Mounting the unit to a wall, the floor, a nearby pole, or a piece of plywood using the mounting holes on the unit can ensure safe and continuous operation.

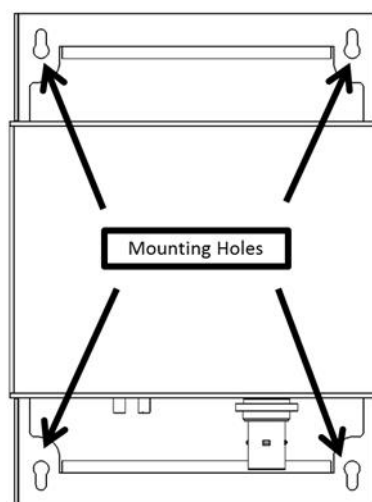

Fig. 2-11: Mounting Plate with Holes

- Once the system is set up and running, monitor the system display on the Cobra 2DT carefully. Because the system is digital, the Signal Strength will meet or exceed operational requirements. When the Signal Strength is no longer strong enough, the signal stops.
- Be as careful during System tear down as during System setup.

Block Diagrams

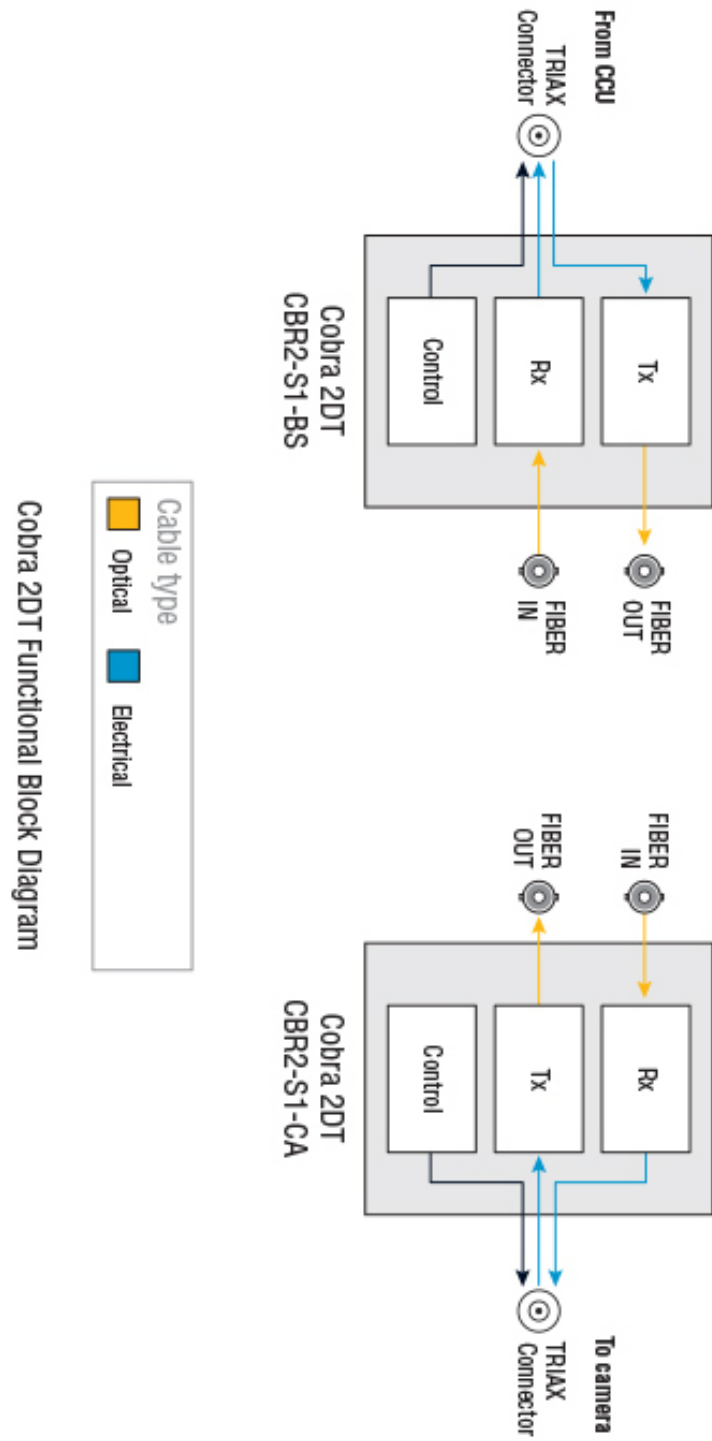

Fig. 2-12: Cobra 2DT Functional Block Diagram

Troubleshooting

Troubleshooting any technical issues with the Cobra 2DT System is similar to any piece of television production gear, with the exception of the core Fiber Optic technology.

Here is a list of things to keep in mind:

- Check all your cables for any broken connections or bad connectors.
- Ensure that the Power Supply is working.
- If there is a power problem, check the power supplies.

If you cannot resolve the problem in the field, contact support (see [Contact Us](#) on page 19).

3 Specifications

Transmission

Data Rate	2.97 Gb/s
Optical Source	Laser Diode
Fiber Type.....	Single Mode
Optical Output Power (typical).....	-7 dBm
Optional High Power Version.....	0dBm
Optical Sensitivity (typical).	>-21 dBm
Link Margin/Distance (typical).....	20 dB/40 km (typ.)
Wavelength (from camera/to camera)	
2-fiber version.....	1310/1310nm
1-fiber version.....	1310/1550 nm
Input/Output Impedance.....	75 Ω
Available in 1-fiber or 2-fiber versions	

Mechanical/Environmental

Throw Down Mussel Shell: (LxWxH)	12" x 9" x 2.5"
1 RU Base Unit: (single or double (LxWxH)).	12" x 18" x 1.5"
Weight, Camera End.	4.6 lbs.
Weight, Base Station End (throwdown).....	3.6 lbs.
Weight Base Station End (1RU unit):	
single/double.....	4 lbs./7 lbs.
Connectors:	
Triaxial connector.	Kings Tri-Loc, Fischer, Damar Hagen
Optical	ST Single Mode (standard), ST(Single), ST(Dual), 304M(Dry),
.....	MX, Neutrik. OpticalCON, LC
Input Voltage.	100 VAC to 240 VAC, 45-65Hz
Output Voltage to Camera:	
Standby.....	36VDC+/-10%
Operate	180VDC+/-10%
Triaxial range:	
Cobra DT2 Camera Unit to Camera	Min: 10 meters, Max: 300 meters
Cobra DT2 Base Unit to CCU typical	Min: 10 meters, Max: 60 meters
Power Consumption :	
Base Unit.....	<10 Watts
Camera Unit (excluding camera power):.	<30 Watts
Temperature Range, operating	-40 C to +55 C
Humidity Range	0 to 95% non-condensing



Grass Valley Technical Support

For technical assistance, please contact the Grass Valley Technical Support center nearest you:

Americas

Office hours: 9:00 a.m. – 9:00 p.m. (EST)
Telephone: 1-800-224-7882
Fax: +1 514 335 1614
E-mail: support@miranda.com

Asia

Office hours: 9:00 a.m. – 6:00 p.m. (GMT+8)
Telephone: +852 2539 6987
Fax: +852 2539 0804
E-mail: asiotech@miranda.com

Europe, Middle East, Africa, UK

Office hours: 9:00 a.m. – 6:00 p.m. (GMT)
Telephone: +44 118 952 3444
Fax: +44 118 952 3401
E-mail: eurotech@miranda.com

China

Office hours: 9:00 a.m. – 6:00 p.m. (GMT+8)
Telephone: +86 10 5873 1814
E-mail: asiotech@miranda.com

France

Office hours: 9:00 a.m. – 5:00 p.m. (GMT+1)
Telephone: +33 1 55 86 87 88
Fax: +33 1 55 86 00 29
E-mail: eurotech@miranda.com

Malaysia

Telephone: +60 3 2247 1808

EMERGENCY After Hours (Global)

Toll Free: 1-800-224-7882 (US and Canada)
Telephone: +1 514 333 1772

Corporate Head Office

Grass Valley
3499 Douglas-B.-Floreni
St-Laurent, Quebec H4S 2C6
Canada
Telephone: +1 514 333 1772
Fax: +1 514 333 9828
Web: www.miranda.com



Ordering Information

This appendix provides a list of part numbers that you can use when ordering equipment.

Part Numbers and Parameters 21
Typical Model Part Numbers 22

Part Numbers and Parameters

The Cobra 2DT unit must be ordered with a part number specifying the following parameters:

- 1 Overall Product Series
- 2 Camera Make
- 3 Camera or CCU Version
- 4 Enclosure Type – Mini-Mussell Shell or Rack Unit
- 5 Number of Units – Mini-Mussell Shell is always 1 unit, Rack Unit can be 1 or 2
- 6 Fiber Connector Type
- 7 Triax Connector Type

The following table lists the choices for each part number parameter:

Item	Parameter	Designation	Description
1	Series	CBR2	Cobra 2D Triax-to-Fiber
2	Camera Make	S1	Sony HSC/HXC
3	Camera or CCU	CA	Camera End
		BS	CCU End
4	Enclosure	MS	Mussell Shell
		RM	1 RU Rack Mount
5	Number of Units	1	Single
		2	Dual CCU End (Rack Mount Only) 2 in BS-RM only)
6	Fiber Connector	S2	2 ST Connectors
		S1	1 ST Connector (WDM)
		L2	2 LC Connectors
		OC2	OpticalCON Connector (Dry)
		MX	MX Connector
		304	SMPTE 204M Connector (Dry)
7	Triax Connector	F	Fischer
		KG	Kings
		DH	Damar-Hagen

Typical Model Part Numbers

Model Number	Model Description
CBR2-S1-CA-MS-1-S2-F	Cobra2D, Model S1 (Sony HSC/HXC chains), Camera End, single Mussel Shell enc., fiber: 2 ST connectors, Fischer triax con.
CBR2-S1-BS-MS-1-S2-F	Cobra2D, Model S1 (Sony HSC/HXC chains), CCU end, single Mussel Shell enc., fiber: 2 ST connectors, Fischer triax con.
CBR2-S1-BS-RM-1-S2-F	Cobra2D, Model S1 (Sony HSC/HXC chains), CCU end, single 1 RU rack mount enc., fiber: 2 ST connectors, Fischer triax con.
CBR2-S1-BS-RM-2-S2-F	Cobra2D, Model S1 (Sony HSC/HXC chains), CCU end, dual CCU 1 RU rack mount enc., fiber: 2 ST connectors, Fischer triax con.

