



A **BELDEN** BRAND

Intuition XG

Advanced HD/SD graphics co-processor



Configuration Guide

M848-9002-480

w w w . m i r a n d a . c o m

Copyright & Trademark Notice

Copyright © 2013, Miranda Technologies Partnership. All rights reserved.

Belden, Belden Sending All The Right Signals, and the Belden logo are trademarks or registered trademarks of Belden Inc. or its affiliated companies in the United States and other jurisdictions. Miranda and Intuition XG are trademarks or registered trademarks of Miranda Technologies Partnership. Belden Inc., Miranda Technologies Partnership, and other parties may also have trademark rights in other terms used herein.

Terms and Conditions

Please read the following terms and conditions carefully. By using the Intuition XG documentation, you agree to the following terms and conditions.

Miranda Technologies Partnership (“Miranda”) hereby grants permission and license to owners of the Intuition XG to use their product manuals for their own internal business use. Manuals for Miranda products may not be reproduced or transmitted in any form or by any means, electronic or mechanical, including photocopying and recording, for any purpose unless specifically authorized in writing by Miranda.

A Miranda manual may have been revised to reflect changes made to the product during its manufacturing life. Thus, different versions of a manual may exist for any given product. Care should be taken to ensure that one obtains the proper manual version for a specific product serial number.

Information in this document is subject to change without notice and does not represent a commitment on the part of Miranda.

Warranty information is available in the Support section of the Miranda Web site (www.miranda.com).

Document identification

Title	Intuition XG - Installation & Quick Start Guide
Part number	M848-9002-480
SW version	Vertigo Suite v.4.8

Revision History

After the original release date, this document may be updated with edits and then re-released. The following table tracks the versions of this document.

Revision date	Description
June 27, 2012	Original release of this configuration guide for Vertigo Suite v.4.8
Nov. 5, 2013	Removed the “File formats supported by the Intuition XG” section on page 1-8 and any references to the “Supported file formats for playback” document.

TABLE OF CONTENTS

Introduction	1-1
Intuition XG's standard and optional features.....	1-2
Intuition XG system integration.....	1-6
Upstream branding using the Intuition XG.....	1-7
Overview of the Intuition XG's Hardware	2-1
Hardware overview (Intuition-XG-e)	2-2
Front panel components (Intuition-XG-e).....	2-3
Rear panel components (Intuition-XG-e).....	2-5
Hardware overview (Intuition-XG-3U-e / Dual-e).....	2-8
Front panel components (Intuition-XG-3U-e / Dual-e)	2-9
Rear panel components (Intuition-XG-3U-e / Dual-e).....	2-11
Intuition XG's signal path and rendering processes	2-16
Video input/output channels	2-17
Audio input/output channels	2-18
Ancillary data processing	2-19
Clip Player and media storage.....	2-19
Graphics processing	2-21
Intuition XG's Desktop Applications & Tools	3-1
Intuition XG's desktop - device identification	3-2
Intuition XG Control Panel and XG Dashboard	3-3
Xplay - Playout control application.....	3-5
Device Manager.....	3-6
Automation Configuration	3-8
Xplay's Automation settings.....	3-9
Vertigo Command Shell.....	3-10
Windows Explorer.....	3-12
Embedded Xmedia Server Control Panel.....	3-13
XPublish Agent Control Panel	3-15
Data Server Control Panel.....	3-16
Intuition XG Portal - Intuition XG's Remote Configuration Tool	4-1
Accessing and logging into the Intuition XG Portal.....	4-2
Overview of the Intuition XG Portal's menu commands	4-4
Remotely shutting down the Intuition XG device	4-6
Restarting the Intuition XG device remotely	4-7
Viewing the processes running on the Intuition XG device.....	4-8
Configuring Intuition XG's network settings.....	4-9
Specifying the Intuition XG device's hostname.....	4-11
Specifying the Intuition XG device's Date & Time settings	4-12
Logging off of the Intuition XG Portal.....	4-13
Dashboard - Intuition XG's Local Configuration Software	5-1

About the Dashboard.....	5-3
Starting Dashboard.....	5-4
An overview of the Dashboard's interface components	5-5
Dashboard's menus and buttons	5-6
Device List	5-8
Loading and refreshing the device list	5-9
Saving the device list	5-9
Restarting a device in the device list	5-10
Monitoring the status of a device	5-10
Removing a device from the device list	5-10
Device Discovery Tool.....	5-11
Performing a Manual Device Discovery.....	5-13
Performing an Automatic Device Discovery	5-14
Device Profile page	5-15
Device Settings tabs and configuration pages	5-17
Device settings buttons.....	5-18
General page	5-19
Resolution page.....	5-21
Live Window page	5-23
Clips page.....	5-25
3D Engine page	5-27
Logging page	5-29
Hardware Settings > Genlock page.....	5-31
Hardware Settings > Video page	5-34
Hardware Settings > Audio page	5-36
Hardware Settings > Ancillary page.....	5-38
Hardware Settings > Watch Dog page	5-41
Licensing page.....	5-42
Audio Mixing Profiles dialog box.....	5-43

1 INTRODUCTION

The Intuition XG graphics co-processor significantly extends the graphics and clip playout capabilities of master control switcher systems, like the Imagestore 750 or NV51000MC, by feeding the HD/SD fill/key inputs. It's ideal for playout of the most advanced data-driven, channel branding and promotional graphics, including: "Coming up next" and episodic promos. The Intuition XG provides multi-level character generation plus animation/still and clip playout with multi-channel audio.

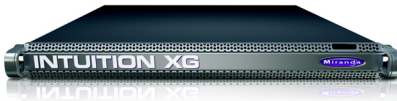

The following sections of this configuration guide describe the Intuition XG's features, capabilities, and system integration:

- ["Intuition XG's standard and optional features" on page 1-2](#)
- ["Intuition XG system integration" on page 1-6](#)
- ["Upstream branding using the Intuition XG" on page 1-7](#)
- ["The Intuition XG provides advanced branding capabilities to master control switchers" on page 1-7](#)

Further chapters provide descriptions of the Intuition XG's hardware and software components:

- ["Overview of the Intuition XG's Hardware" on page 2-1](#)
- ["Intuition XG's Desktop Applications & Tools" on page 3-1](#)

Most Intuition XG devices are installed and configured by qualified network administrators or Miranda's Integration Specialists using the Intuition XG Portal and Dashboard software interfaces. While we do not recommend that users change the Intuition XG's settings, the following chapters provide detailed descriptions of each of the Intuition XG settings:

- ["Intuition XG Portal - Intuition XG's Remote Configuration Tool" on page 4-1](#)
- ["Dashboard - Intuition XG's Local Configuration Software" on page 5-1](#)

Intuition XG's standard and optional features

The Intuition XG is available in three (3) standard models:

<p>Intuition-XG-e</p>	<p>A single channel graphics co-processor, generally used upstream of a master control switcher like the Imagestore 750 or NV5100MC.</p> <div data-bbox="458 378 1046 465" data-label="Diagram"> </div> <ul style="list-style-type: none"> • 1RU chassis with a single power supply unit. • 1 HD/SD video input, 1 HD/SD (Fill & Key) output • A powerful, HD/SD character generator which allows the playout of virtually unlimited layers of animated text and dynamically updated text. • 1 TB RAID1 storage for up to 200 hours of video/audio clips and simultaneous playout of multiple clips • Playout of up to eight (8) layers of animated and still graphics templates for the most advanced branding and promotional effects. • SD output as NTSC or PAL • HD output as 1080i, 720p or 480p • VANC + VBI extraction processing and insertion or VAnc/VBI pass through. • Full automation control by serial, Ethernet and/or GPI commands. <p>Options</p> <ul style="list-style-type: none"> • VX-ClipPlayer • VX-Audio-e
<p>Intuition-XG-3U-e</p>	<p>A single channel graphics co-processor, generally used upstream of a master control switcher like the Imagestore 750 or NV5100MC.</p> <div data-bbox="458 1256 1046 1367" data-label="Diagram"> </div> <ul style="list-style-type: none"> • 3RU chassis with redundant power supply unit. • 1 HD/SD video input, 1 HD/SD (Fill & Key) output • A powerful, HD/SD character generator which allows the playout of virtually unlimited layers of animated text and dynamically updated text.

	<ul style="list-style-type: none"> • 1 TB RAID1 storage for up to 400 hours of video/audio clips and simultaneous playout of multiple clips • Playout of up to eight (8) layers of animated and still graphics templates for the most advanced branding and promotional effects. • SD output as NTSC or PAL • HD output as 1080i, 720p or 480p • VANC + VBI extraction processing and insertion or VANC/VBI pass through. • 16 embedded audio channels • Discrete AES audio channels - up to 8 in and 16 out • Full automation control by serial, Ethernet and/or GPI commands. <p>Options</p> <ul style="list-style-type: none"> • VX-ClipPlayer • VX-Audio-e • VX-EAS • VX-GPI-8-eVX-RS422-2-e • VX-TC-e • VX-2TB-UPG
<p>Intuition-XG-Dual-e</p>	<p>A dual channel graphics co-processor, generally used upstream of a master control switcher like the Imagestore 750 or NV5100MC.</p> <div data-bbox="532 965 1120 1097" data-label="Diagram"> </div> <ul style="list-style-type: none"> • 3RU chassis with redundant power supply unit. • 2 HD/SD video input, 2 HD/SD (Fill & Key) output • A powerful, HD/SD character generator which allows the playout of virtually unlimited layers of animated text and dynamically updated text. • 1 TB RAID1 storage for up to 400 hours of video/audio clips and simultaneous playout of multiple clips • Playout of up to eight (8) layers of animated and still graphics templates for the most advanced branding and promotional effects. • SD output as NTSC or PAL • HD output as 1080i, 720p or 480p

	<ul style="list-style-type: none"> • VANC + VBI extraction processing and insertion or VAnc/VBI pass through. • 16 embedded audio channels per SDI stream • Discrete AES audio channels - up to 8 in and 2 x 16 out • Full automation control by serial, Ethernet and/or GPI commands. <p>Options</p> <ul style="list-style-type: none"> • VX-ClipPlayer • VX-Audio-e • VX-EAS • VX-GPI-8-e/VX-RS422-2-e • VX-TC-e • VX-2TB-UPG
--	--

The following options are available on Intuition XG devices:

VX-ClipPlayer	<p>Clip Player</p> <p>The Clip Player is an internal codec package for playing out multi-format video clips. See “Clip Player and media storage” on page 2-19 for more information about the Clip Player option.</p>
VX-Audio-e	<p>Audio Processing</p> <p>The discrete audio I/O card allows the Intuition XG to capture, process and output discrete audio. The number of discrete audio I/O channels depends on the model of Intuition XG:</p> <ul style="list-style-type: none"> • Intuition-XG-e => None • Intuition-XG-3Ue and Intuition-XG-Dual-e => 8 in / 16 out <p>See “Audio input/output channels” on page 2-18 for more information.</p>
VX-GPI-8-e	<p>GPI card</p> <p>The GPI card allows for control of the Intuition XG via GPI triggers. The card allows for up to 8 GPI in and 8 GPI out. See “GPI Card Connector” on page 2-15 for more information about the GPI card option.</p>
VX-EAS	<p>EAS Text Integration (EAS Plugin and EAS Software Panel)</p> <p>High quality EAS text and audio can be played out with the Intuition XG processor, using templates which integrate channel branding graphics for a consistent on-air presentation.</p> <p>Only available for the Intuition-XG-3U-e and Intuition-Dual-e models.</p>

VX-RS422-2-e	2 port RS-422 card The RS-422 card provides an interface upon which the Intuition XG can communicate with automation systems. See “RS-422 Connectors” on page 2-13 for more information. Only available for the Intuition-XG-3U-e and Intuition-Dual-e models.
VX-TC-e	Time Code card The Time Code card allows you to lock the Intuition XG’s system clock to an external timecode. See “Time Code Card” on page 2-13 for more information about the Time Code option. Only available for the Intuition-XG-3U-e and Intuition-Dual-e models.
VX-2TB-UPG	1 TB RAID-10 Expansion option (2 x 1TB) Increases the usable storage from 1TB to 2TB. See “Clip Player and media storage” on page 2-19 for more information. Only available for the Intuition-XG-3U-e and Intuition-Dual-e models.

Intuition XG system integration

Figure 1-1 demonstrates that the Intuition XG can be fully integrated with the Miranda's Imagestores or 3rd party master control switchers, the Vertigo Suite, playout automation, and media management systems.

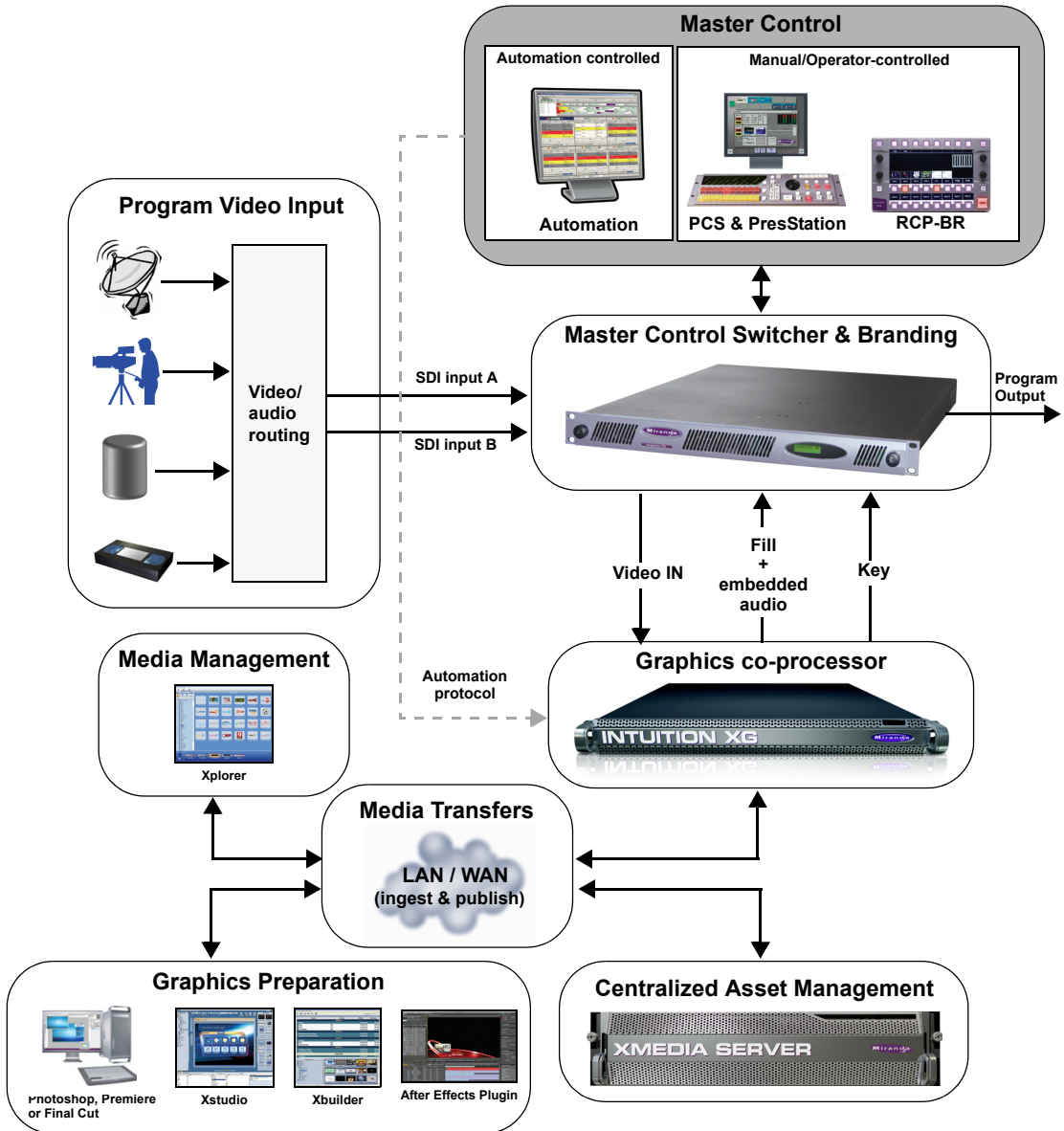

Figure 1-1. The Intuition XG integrates with master control switchers and the Vertigo Suite products

Upstream branding using the Intuition XG

With its powerful rendering engine, the Intuition XG is able to generate and deliver sophisticated multi-layered branding graphics as HD/SD fill and key inputs to master control switchers, like the Imagestore 750 or NV5100MC.

Figure 1-2 demonstrates that the master control switcher's ability to switch between two video sources is conserved and the clean video feed is simultaneously pushed through the master control switcher and the Intuition XG. Feeding the video signal into the Intuition XG allows you to produce even more sophisticated branding events using dynamic DVEs, like picture-in-picture and squeeze-and-reveal transitions. If for some reasons the Intuition XG were to go down, graphics insertion would be lost, but the video signal is conserved without interruption since the video feed continues to run through the master control switcher. Note that for the video signal to be synchronized, you must specify a video frame delay on the master control switcher (see **VIDEO FRAME DELAYS** in the Imagestore 750 documentation).

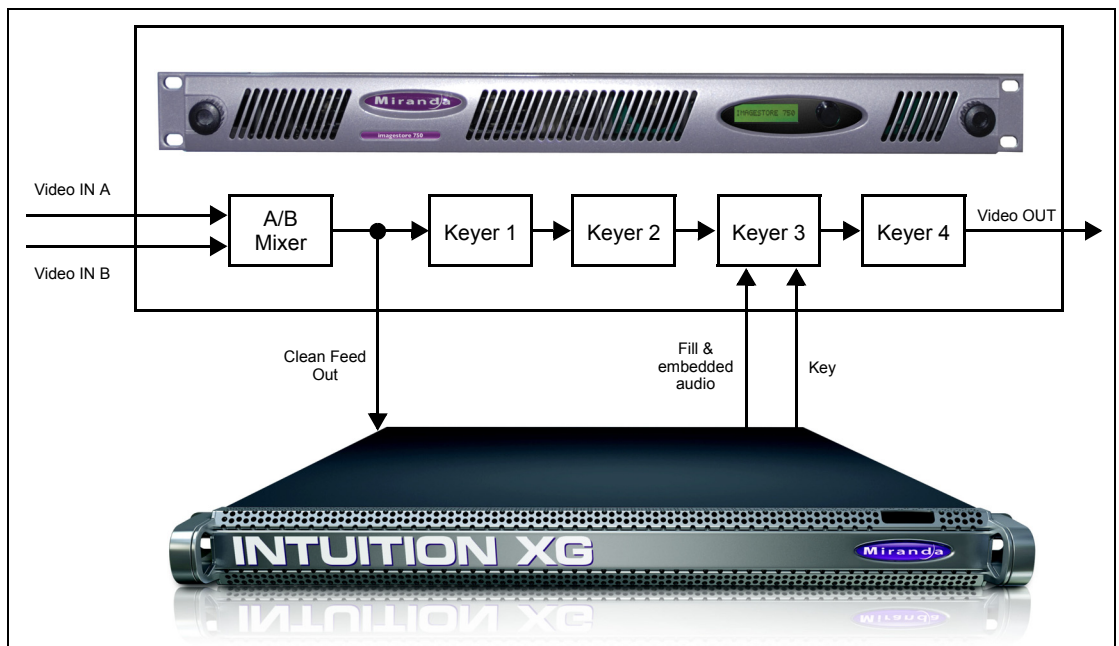



Figure 1-2. The Intuition XG provides advanced branding capabilities to master control switchers

2 OVERVIEW OF THE INTUITION XG'S HARDWARE

Depending upon the model, the Intuition XG device is either a 1 RU or 3 RU rackmount chassis. The following sections describe the hardware components associated with each model of the Intuition XG:

- [“Hardware overview \(Intuition-XG-e\)” on page 2-2](#)
- [“Hardware overview \(Intuition-XG-3U-e / Dual-e\)” on page 2-8](#)

Despite the physical difference in chassis size and hardware options, each model of the Intuition XG follows the same theory of operation as a graphics co-processor (see [“Intuition XG’s signal path and rendering processes” on page 2-16](#) for more details).

Intuition-XG-e	A single channel (fill + key) output graphics co-processor in a 1 RU chassis. 
Intuition-XG-3U-e Intuition-XG-Dual-e	A single or dual channel (fill + key) output graphics co-processor in a 3 RU chassis. 

Hardware overview (Intuition-XG-e)

The Intuition XG-e is a single HD/SD channel playout server (1 HD/SD video input, 1 HD-SDI Fill + Key output) that incorporates the Vertigo XG graphics engine to rendering advanced graphics. Physically, the Intuition XG is a 1RU rackmount playout server with a single power supply unit and 1 TB of storage.

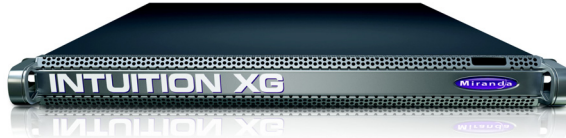

The following sections provide more information about Intuition XG's hardware components:

- ["Front panel components \(Intuition-XG-e\)" on page 2-3](#)
- ["Rear panel components \(Intuition-XG-e\)" on page 2-5](#)

Chassis	FORM: 1U rackmount chassis HEIGHT: 1.7" (43 mm) WIDTH: 17.2" (437 mm) DEPTH: 28.2" (716 mm)
Power consumption	1 x 1400W power supply <ul style="list-style-type: none">• AC input: 180 - 240V, 50 - 60 Hz, 7.2 - 9.5 Amp

Front panel components (Intuition-XG-e)

The Intuition XG's front panel features convenient access to the SATA hard drives, two USB ports, a CD/DVD ROM drive, two fans, and a control panel containing five LEDs and two buttons for system monitoring and operation. The table following the figure [2-1](#) describes the function of each LED and button.

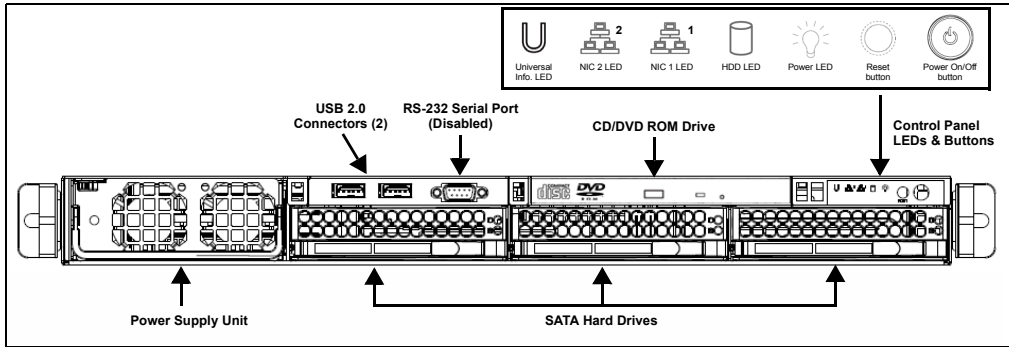

Figure 2-1. Intuition XG's front panel components

UNIVERSAL INFORMATION LED









The Universal Information LED is used to indicate fan failure, power failure, overhear condition, or to identify the unit within a large rack installation. The feature requires a motherboard that supports the Universal Information LED.

When this LED blinks red quickly, it indicates a fan failure and when blinking red slowly a power failure. This LED will be blue when used for UID (Unit Identifier). When on continuously red, it indicates an overhear condition, which may be caused by cables obstructing the airflow in the system or the ambient room temperature being too warm. See the table below for descriptions of the LED states.

Note: Deactivating the UID LED must be performed in the same way it was activated. (If the UID LED was activated via IPMI, you can only turn the LED off via IPMI and not with the UID button.)

Universal Information LED States	
State	Indication
Fast Blinking Red (1x/sec)	Fan Fail
Solid Red	CPU Overheat
Slow Blinking Red (1x/4 sec)	Power Fail
Solid Blue	Local UID Button Depressed
Blinking Blue	IPMI-Activated UID

<p>NIC2</p> 	<p>A flashing NIC2 LED indicates network activity on LAN2.</p>
<p>NIC1</p> 	<p>A flashing NIC1 LED indicates network activity on LAN1.</p>
<p>HDD</p> 	<p>Indicates IDE channel activity.</p>
<p>POWER (LED)</p> 	<p>Indicates that power is being supplied to the system's power supply units. This LED should normally be illuminated when the system is in operation.</p>
<p>RESET</p> 	<p>The Reset button reboots the system.</p>
<p>POWER (BUTTON)</p> 	<p>This is the main power button, which is used to apply or turn off the main system power. Turning off this button removes the main power, but keeps standby power supplied to the system.</p>

Rear panel components (Intuition-XG-e)

The Intuition XG's rear panel features convenient access to the video card's I/O connector, which provides 1 SD/HD SDI video input, 1 SD/HD SDI video output (Fill & Key), and a reference signal input. The rear panel also provides access to the graphics card connector, as well as various I/O ports (RS-422, USB, Ethernet...etc.).

The table following the figure 2-2 describes the function of each connector on the rear panel of the Intuition XG chassis.

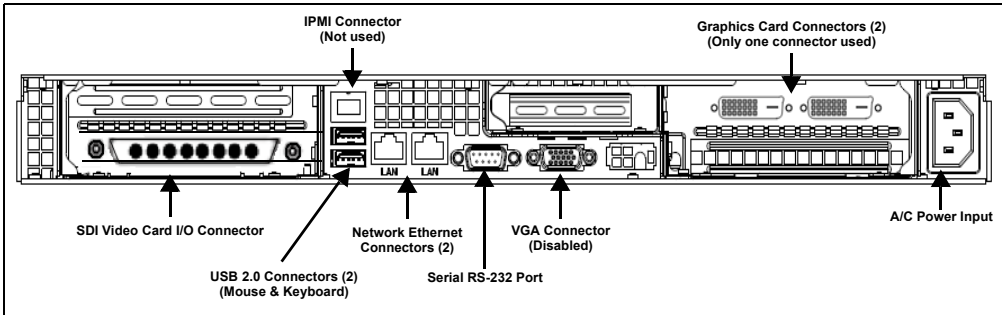
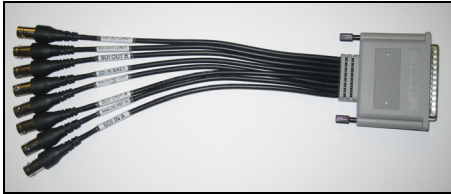
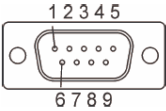



Figure 2-2. The Intuition XG's rear panel components

<p>SDI Video Card I/O Connector</p>	<p>A breakout cable is used to connect the Video Card I/O connector to the SDI video input/output cables and the reference I/O. See “Video input/output channels” on page 2-17 for more information about the Intuition XG's video input/output channel connections.</p> 
<p>IPMI Connector</p>	<p>Intelligent Platform Management Interface is a set of common interfaces to a computer system which system administrators can use to monitor system health and manage the system. IPMI operates independently of the operating system and allows administrators to manage a system remotely even in the absence of an operating system or the system management software, or even if the monitored system is powered off.</p>
<p>USB 2.0 Connectors</p>	<p>The two (2) USB 2.0 connectors on the rear panel allow you to connect a mouse and keyboard to the Intuition XG device. These peripherals are required during the device's initial configuration, which involves using the Intuition XG's desktop applications, including Dashboard.</p>

<p>Network Ethernet Connectors</p>	<p>The two (2) Network Ethernet connectors are teamed and allow you to connect the Intuition XG device to the Local Area Network (LAN).</p> <p>NIC Teaming is a networking concept where multiple network adapters within a computer are combined in parallel to provide redundancy for the network interface. On an Intuition XG device, the two Local Area Connection network adapters are teamed together (connect 2 cables to the 2 NIC cards at the same time) to form a third virtual adapter. In the event of an adapter, cable or switch failure, the network interface fails over to the healthy adapter.</p> <p>When the individual Local Area Network adapters are teamed together the individual Local Area Network adapters are not accessible or configurable. Only the teamed virtual adapter can be configured.</p> <p>If you only have 1 cable connected, then the teaming will still be in effect but all traffic will be over that one cable. If that NIC fails, you will have to manually move the cable to the other NIC.</p>																				
<p>Serial RS-232 Port</p>	<p>The two (2) RS-232 connectors provide two control ports upon which the automation system's serial cables are connected. It is through this connection that the automation system communicates and controls the Vertigo XG using automation protocol commands.</p> <table border="1" data-bbox="417 847 655 1107"> <thead> <tr> <th>Pin No.</th> <th>Signal Name RS232</th> </tr> </thead> <tbody> <tr> <td>1</td> <td>CD</td> </tr> <tr> <td>2</td> <td>RD</td> </tr> <tr> <td>3</td> <td>TD</td> </tr> <tr> <td>4</td> <td>DTR</td> </tr> <tr> <td>5</td> <td>Ground</td> </tr> <tr> <td>6</td> <td>DSR</td> </tr> <tr> <td>7</td> <td>RTS</td> </tr> <tr> <td>8</td> <td>CTS</td> </tr> <tr> <td>9</td> <td>RI</td> </tr> </tbody> </table>  <p>Connector type: 9 pin male D type.</p>	Pin No.	Signal Name RS232	1	CD	2	RD	3	TD	4	DTR	5	Ground	6	DSR	7	RTS	8	CTS	9	RI
Pin No.	Signal Name RS232																				
1	CD																				
2	RD																				
3	TD																				
4	DTR																				
5	Ground																				
6	DSR																				
7	RTS																				
8	CTS																				
9	RI																				
<p>VGA Connector</p>	<p>This VGA connector is disabled since the Intuition XG's graphics card connector allows you to connect to a monitor to view the Intuition XG desktop.</p>																				

Graphics Card's DVI Connectors	<p>The graphics card's DVI connectors allow you to connect the Vertigo XG device to DVI monitor. The monitor is only required during the device's initial configuration, so as to display Vertigo XG's desktop applications, including XG Dashboard.</p> <p>Note that although there are two (2) DVI connectors, the Vertigo XG can display to only one monitor. Therefore, it does matter which of the two connectors the monitor's cable is connected to.</p> <p>Use the adapter (below) if you would rather connect a VGA monitor.</p> 
Power Supply	<p>The power cord connects to Intuition XG's 1400 W power supply. See the specifications listed on page 2-1.</p>

Hardware overview (Intuition-XG-3U-e / Dual-e)

Physically, the Intuition XG-3U-e and Intuition XG-Dual-e are 3RU rackmount rendering platforms that incorporate redundant fans, three power supplies, and 1 TB RAID-1 enabled storage (optional 2 TB RAID-10 expansion).



The Intuition XG (3U & Dual) features easy frontal access to the SCSI drives, two UBS ports and a control panel featuring LEDs and buttons for system monitoring and operation (see [page 2-9](#) for more details). The rear panel also provides convenient access to three power supply modules, six PCI expansion slots which contain the video, audio, and graphics cards, and various I/O ports (USB, COM1, VGA, Ethernet...etc). See [page 2-11](#) for more details about the Intuition XG's rear panel components and connectors.

The following hardware options are also available to enhance the performance and capabilities of the Intuition XG:

- **VX-RS422-e** (2 port RS-422/485 PCI card)
- **VX-GPI-8-e** (GPI card)
- **VX-TC-e** (Time Code card)
- **VX-2TB-UPG** (1TB RAID10 expansion drive)

Chassis	FORM: 3U rackmount chassis HEIGHT: 5.2" (132 mm) WIDTH: 17.7" (450 mm) DEPTH: 25.5" (648 mm)
Power consumption	3 x 380W power supply AC input: 100 - 240V, 50 - 60 Hz, 14/7 Amp

Front panel components (Intuition-XG-3U-e / Dual-e)

The Intuition XG's front panel features convenient access to the RAID-1 hard drives, two USB ports, a CD/DVD ROM drive, and a control panel containing six LEDs and three buttons for system monitoring and operation. The table following the figure [2-3](#) describes the function of each LED and button.

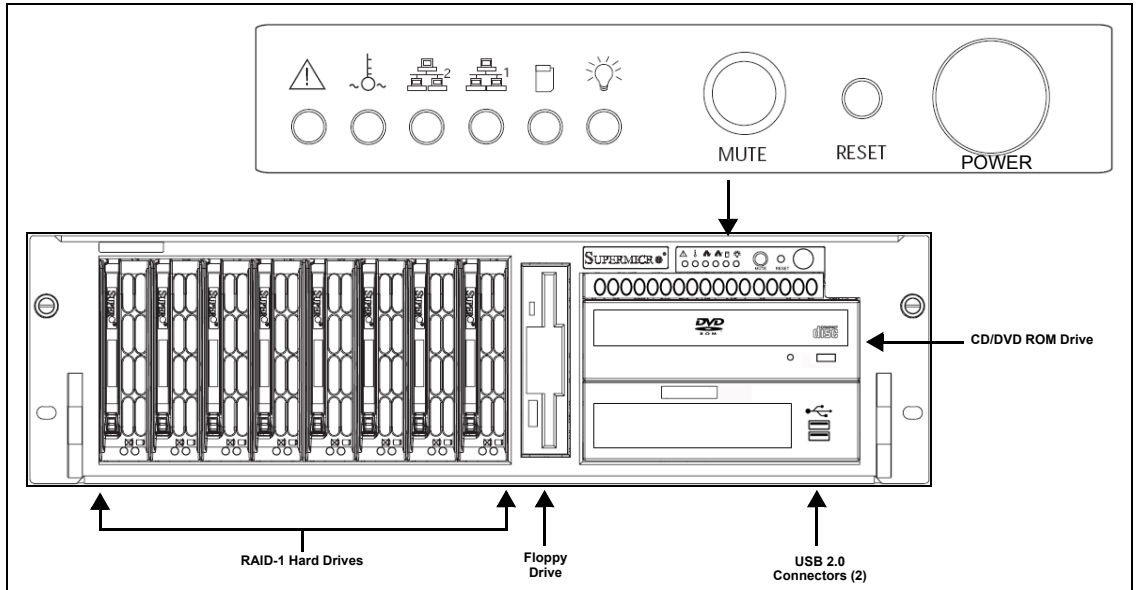







Figure 2-3. The Intuition XG's front panel components

<p>SYSTEM ALERT / POWER FAILURE</p> 	<p>Indicates a power supply module has failed. This should be accompanied by an audible alarm. A backup power supply module will take the load and keep the system running, but the failed module will need to be replaced. This red LED should be off when the system is operating normally.</p>
<p>OVERHEAT / FAN FAIL</p> 	<p>When this red LED flashes, it indicates a fan failure. When it is constantly illuminated (solid on), it indicates an overheat condition, which may be caused by cables obstructing the airflow in the system or the ambient room temperature being too warm. Check the routing of cables and make sure that all fans are present and operating normally. You should also check to make sure that the chassis covers are installed properly. Finally, verify that the heatsinks are installed properly. This LED will remain flashing or on as long as the above mentioned conditions exist.</p>
<p>LAN2</p> 	<p>A flashing green LAN2 LED indicates network activity on LAN2.</p>

<p>LAN1</p> 	<p>A flashing green LAN1 LED indicates network activity on LAN2.</p>
<p>HDD ACTIVITY</p> 	<p>This flashing amber LED indicates IDE channel activity.</p>
<p>POWER INDICATOR (LED)</p> 	<p>Indicates that power is being supplied to the system's power supply units. This green LED should normally be illuminated when the system is in operation.</p>
<p>MUTE (ALARM RESET)</p>	<p>Press the Mute button to silence the buzzer alarm, which is activated by a signal received from the SCSI drive backplane. After silencing the alarm, you should then press the button again to reactivate the alarm function.</p>
<p>RESET</p>	<p>The Reset button reboots the system.</p>
<p>POWER BUTTON</p>	<p>This is the main power button, which is used to apply or turn off the main system power. Turning off this button removes the main power, but keeps standby power supplied to the system.</p>

Rear panel components (Intuition-XG-3U-e / Dual-e)

The Intuition XG's rear panel features convenient access to the video card's I/O connector, which provides up to 4 SD/HD SDI video outputs, a reference signal input, and AES audio input/output. The rear panel also provides access to the graphics card connector, as well as various I/O ports (RS-422, USB, Ethernet...etc.).

The table following the figure [2-2](#) describes the function of each connector on the rear panel of the Intuition XG chassis.

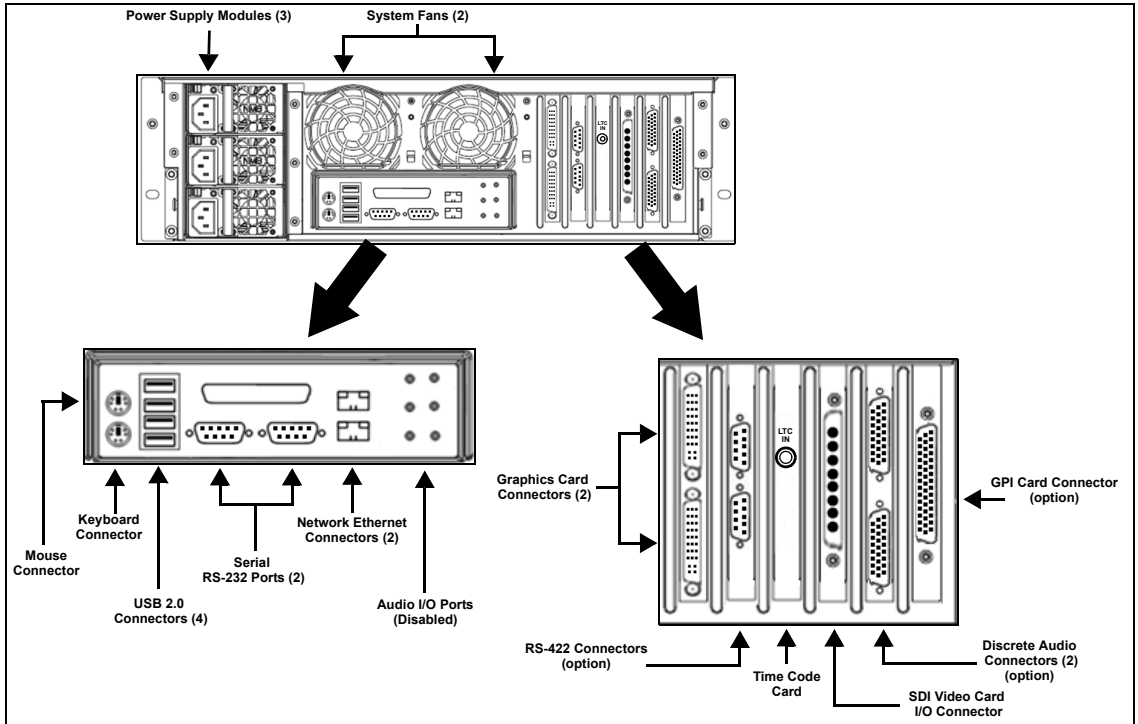
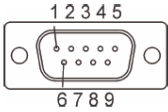

Figure 2-4. The Intuition XG's rear panel components

Mouse & Keyboard connectors

The two (2) PS/2 connectors on the rear panel allow you to connect a mouse and keyboard to the Intuition XG device. These peripherals are required during the device's initial configuration, which involves using the Intuition XG's desktop applications, including Dashboard.

Note that if the mouse or keyboard has a UBS connector, you can connect them to the USB 2.0 connectors on the front or rear panels of the Intuition XG device.

<p>USB 2.0 Connectors</p>	<p>The four (4) USB 2.0 connectors on the rear panel allow you to connect peripheral devices (e.g. keyboard, mouse, flash drive...etc) to the Intuition XG.</p>																				
<p>Serial RS-232 Port</p>	<p>The two (2) RS-232 connectors provide two control ports upon which the automation system's serial cables are connected. It is through this connection that the automation system communicates and controls the Intuition XG using automation protocol commands.</p> <table border="1" data-bbox="413 427 649 685"> <thead> <tr> <th>Pin No.</th> <th>Signal Name RS232</th> </tr> </thead> <tbody> <tr> <td>1</td> <td>CD</td> </tr> <tr> <td>2</td> <td>RD</td> </tr> <tr> <td>3</td> <td>TD</td> </tr> <tr> <td>4</td> <td>DTR</td> </tr> <tr> <td>5</td> <td>Ground</td> </tr> <tr> <td>6</td> <td>DSR</td> </tr> <tr> <td>7</td> <td>RTS</td> </tr> <tr> <td>8</td> <td>CTS</td> </tr> <tr> <td>9</td> <td>RI</td> </tr> </tbody> </table>  <p>Connector type: 9 pin male D type.</p>	Pin No.	Signal Name RS232	1	CD	2	RD	3	TD	4	DTR	5	Ground	6	DSR	7	RTS	8	CTS	9	RI
Pin No.	Signal Name RS232																				
1	CD																				
2	RD																				
3	TD																				
4	DTR																				
5	Ground																				
6	DSR																				
7	RTS																				
8	CTS																				
9	RI																				
<p>Network Ethernet Connectors</p>	<p>The two (2) Network Ethernet connectors are teamed and allow you to connect the Intuition XG device to the Local Area Network (LAN).</p> <p>NIC Teaming is a networking concept where multiple network adapters within a computer are combined in parallel to provide redundancy for the network interface. On an Intuition XG device, the two Local Area Connection network adapters are teamed together (connect 2 cables to the 2 NIC cards at the same time) to form a third virtual adapter. In the event of an adapter, cable or switch failure, the network interface fails over to the healthy adapter.</p> <p>When the individual Local Area Network adapters are teamed together the individual Local Area Network adapters are not accessible or configurable. Only the teamed virtual adapter can be configured.</p> <p>If you only have 1 cable connected, then the teaming will still be in effect but all traffic will be over that one cable. If that NIC fail, you will have to manually move the cable to the other NIC.</p>																				
<p>Audio I/O ports</p>	<p>These six (6) audio I/O ports are not supported by the Intuition XG since external audio input and output is provided by the Discrete EAS option (see “Audio input/output channels” on page 2-18).</p>																				

<p>Graphics Card's DVI Connectors</p>	<p>The graphics card's DVI connectors allow you to connect the Vertigo XG device to DVI monitor. The monitor is only required during the device's initial configuration, so as to display Intuition XG's desktop applications, including XG Dashboard.</p> <p>Note that although there are two (2) DVI connectors, the Intuition XG can display to only one monitor. Therefore, it does matter which of the two connectors the monitor's cable is connected to.</p> <p>Use the adapter (below) if you would rather connect a VGA monitor.</p> <div data-bbox="751 453 939 630" data-label="Image"> </div>																				
<p>RS-422 Connectors</p>	<p>Intuition XG hardware option: Vx-RS422-e</p> <p>The RS-422 connectors provide two control ports upon which the automation system's serial cables are connected. It is through this connection that the automation system communicates and controls the Intuition XG using automation protocol commands.</p> <p>The following represents the pinout assignments of the RS-422 connector:</p> <table border="1" data-bbox="475 899 760 1204"> <thead> <tr> <th>PIN #</th> <th>Signal Name</th> </tr> </thead> <tbody> <tr> <td>1</td> <td>Chassis GND</td> </tr> <tr> <td>2</td> <td>TX-</td> </tr> <tr> <td>3</td> <td>RX+</td> </tr> <tr> <td>4</td> <td>NC</td> </tr> <tr> <td>5</td> <td>NC</td> </tr> <tr> <td>6</td> <td>GND</td> </tr> <tr> <td>7</td> <td>TX+</td> </tr> <tr> <td>8</td> <td>RX-</td> </tr> <tr> <td>9</td> <td>NC</td> </tr> </tbody> </table> <div data-bbox="787 1003 991 1095" data-label="Diagram"> </div>	PIN #	Signal Name	1	Chassis GND	2	TX-	3	RX+	4	NC	5	NC	6	GND	7	TX+	8	RX-	9	NC
PIN #	Signal Name																				
1	Chassis GND																				
2	TX-																				
3	RX+																				
4	NC																				
5	NC																				
6	GND																				
7	TX+																				
8	RX-																				
9	NC																				
<p>Time Code Card</p>	<p>Time Code Card option: VX-TC-e</p> <p>The Time Code card allows you to lock the Intuition XG's system clock to an external timecode. The Time Code card reads Longitudinal Time Code (LTC) from the signal present at the BNC connector.</p> <p>The Time Code option ensures an accurate time stamp for system logs. Accurate time is also required for time-based on-air graphics (i.e. countdown clocks).</p>																				

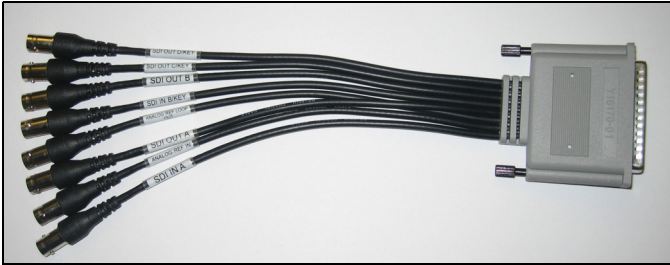
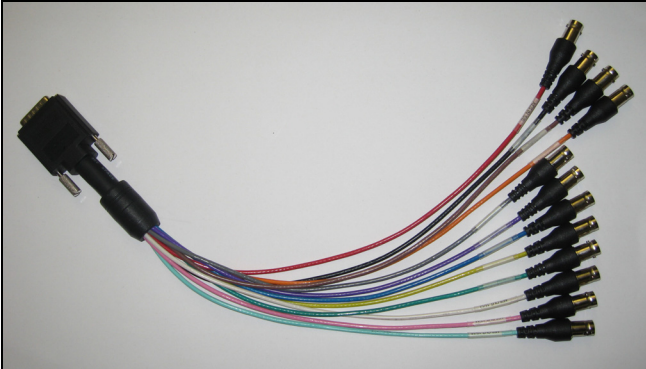
<p>SDI Video Card I/O Connector</p>	<p>A breakout cable is used to connect the Video Card I/O connectors to the SDI video input/output cables and the reference I/O. See “Video input/output channels” on page 2-17 for more information about the Intuition XG’s video input/output channel connections.</p> 
<p>Discrete Audio connectors</p>	<p>Intuition XG hardware option: Vx-Audio-e</p> <p>A breakout cable is used to connect the optional discrete audio card I/O connectors to the BNC audio input/output cables. See “Audio input/output channels” on page 2-18 for more information about the Vertigo XG’s discrete audio input/output channel connections.</p> 

GPI Card Connector

Intuition XG hardware option: Vx-GPI-8-e

The GPI card allows for control of the Intuition XG via GPI triggers. The card provides for up to 8 optically isolated GPI inputs and 8 reed relay GPI outputs.

Port A is an 8 bit input port connected to optically isolated inputs sensors. Each sensor can be used to interface a voltage and then sense whether the voltage is on or off.

The reed relays are well suited for low current applications. The relays are normally open, and will close when energized.

The following tables identify the pinout assignment for the GPI card's input and output ports:

Input Ports Pin Assignment

Port A Bit	Port A Pins
0	2, 40
1	3, 41
2	4, 36
3	5, 37
4	6, 38
5	7, 42
6	8, 43
7	9, 44

Output Ports Pin Assignment

Port C Bit	Port A Pins
0	10, 28
1	11, 29
2	12, 30
3	13, 31
4	14, 32
5	15, 33
6	16, 34
7	17, 35

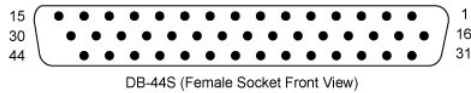

Power and Ground Pin Assignments

Ground	22, 23, 24
+ 5 Volts	39
+12 Volts	1

Intuition XG's signal path and rendering processes

Figure 2-5 features a block diagram of the inputs, outputs and internal rendering processes that are performed by the Intuition XG. Note that the block diagram illustrates the features and functionality of all three models of the Intuition XG. Features and components that are restricted to specific models are identified as such in the diagram or by the shading.

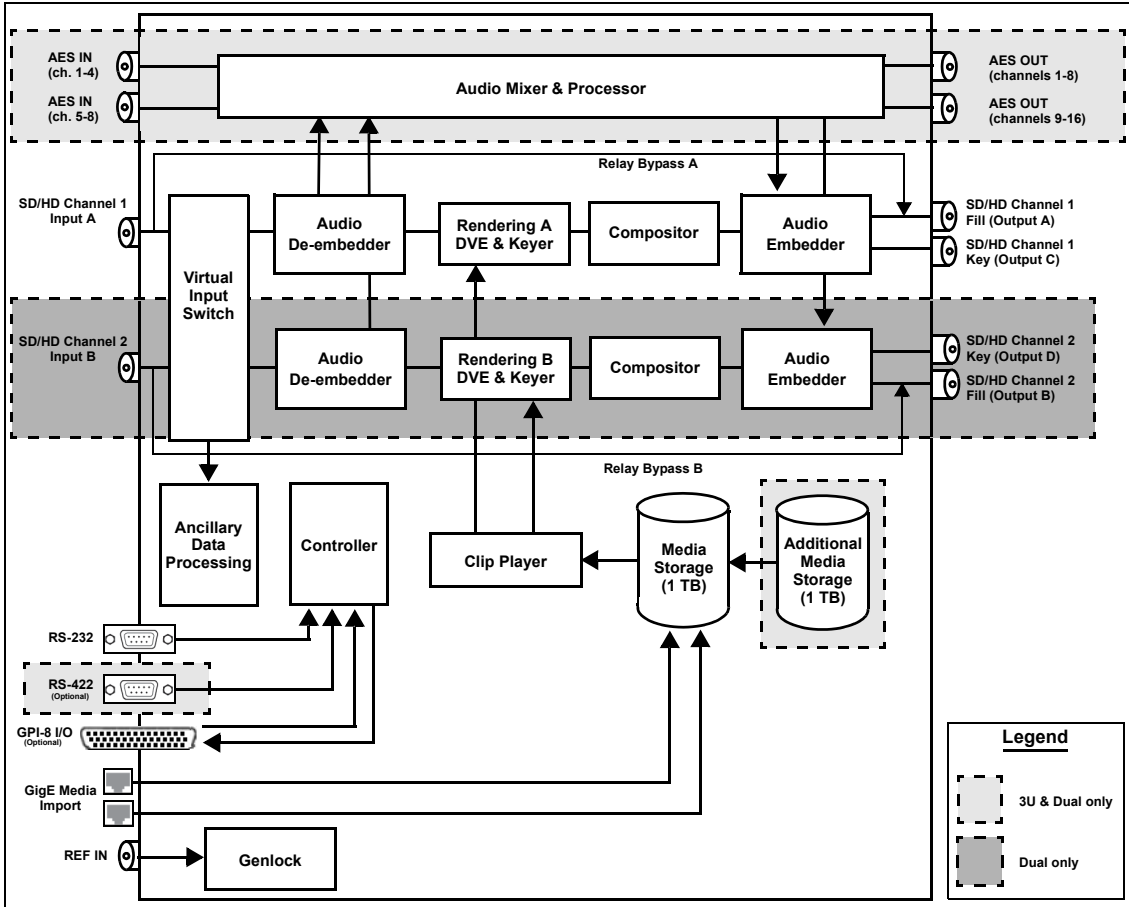

Figure 2-5. Block diagram of the Intuition-XG-3U-e and Intuition-XG-Dual-e

Additional information regarding the internal processing performed by the Intuition XG is provided in the following topics:

- [“Video input/output channels” on page 2-17](#)
- [“Audio input/output channels” on page 2-18](#)
- [“Ancillary data processing” on page 2-19](#)
- [“Clip Player and media storage” on page 2-19](#)
- [“Graphics processing” on page 2-21](#)

Video input/output channels

Depending on the model, Intuition XG devices offer one or two video SD/HD input channels with one or two video SD/HD fill and key output channels. Figure 2-6 and the following table identifies and describes the Intuition XG video card's input and output connections, including the hardware bypass.

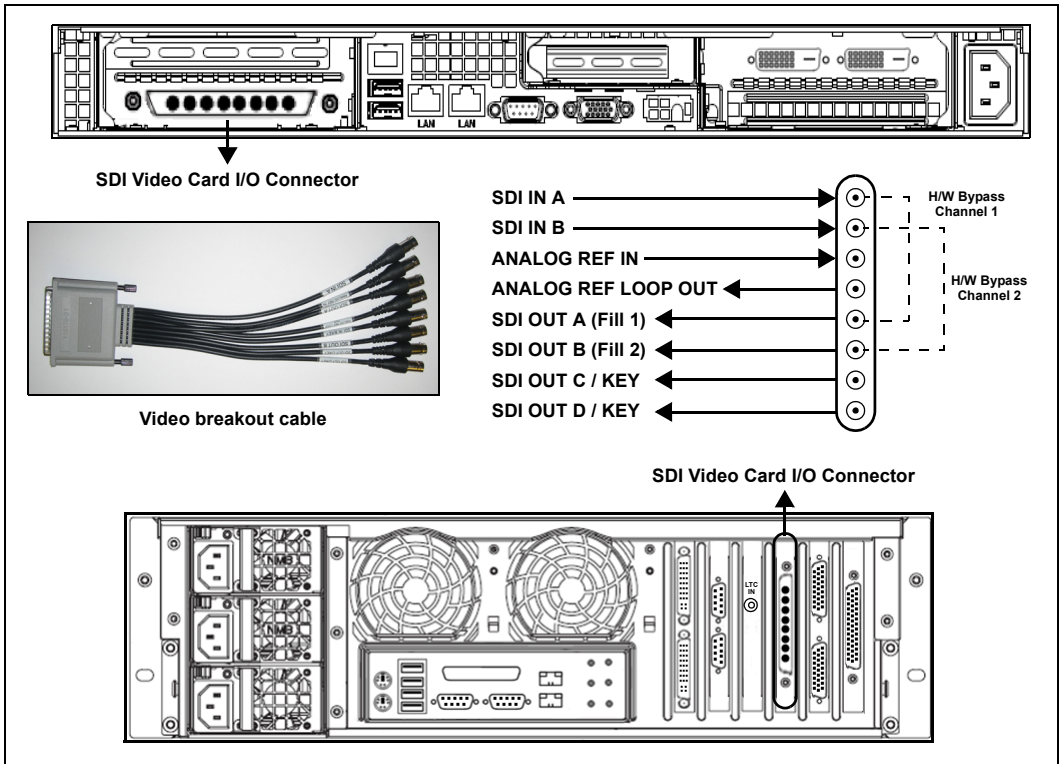

Figure 2-6. The Intuition XG video card's input and output connections

Pin/Channel Name	Description
SDI IN A	SDI IN A is the primary input channel connection.
SDI In B	SDI IN B acts as a separate input channel on the Intuition-XG-Dual-e model.
ANALOG REF IN	Analog Ref In is the input reference signal used by the Genlock hardware to synchronize the phase timing video and graphics processing.
ANALOG REF LOOP OUT	Analog Ref Out loops the signal that comes in through the Analog Ref In channel.
SDI OUT A	SDI OUT A (Fill 1) is the primary output channel connection.

Pin/Channel Name	Description
SDI Out B	SDI OUT B (Fill 2) is the second output channel on the Intuition-XG-Dual-e model. No signal is present at this connection for single-channel models.
SDI Out C / Key	SDI OUT C is the matching Key channel for SDI OUT A.
SDI Out D / Key	SDI OUT D is the matching Key channel for SDI OUT B, which is only available on the Intuition-XG-Dual-e model. No signal is present at this connection for single-channel models.

Audio input/output channels

The Intuition XG-3U-e and Intuition XG-Dual-e supports both embedded and discrete audio channels. Each video input/output can contain up to 8 stereo pairs (16 channels) of embedded audio.

The number of discrete audio input/output channels depends on the number of physical inputs available. For each physical input available there will be a discrete audio breakout cable (see figure 2-7). Each discrete audio breakout cable contains 4 BNC inputs and 8 BNC outputs. Each BNC connector represents 1 stereo pair (2 channels) of digital AES/EBU audio. Therefore, each discrete audio breakout cable contains 4 stereo pairs (8 channels) of input and 8 stereo pairs (16 channels) of output.

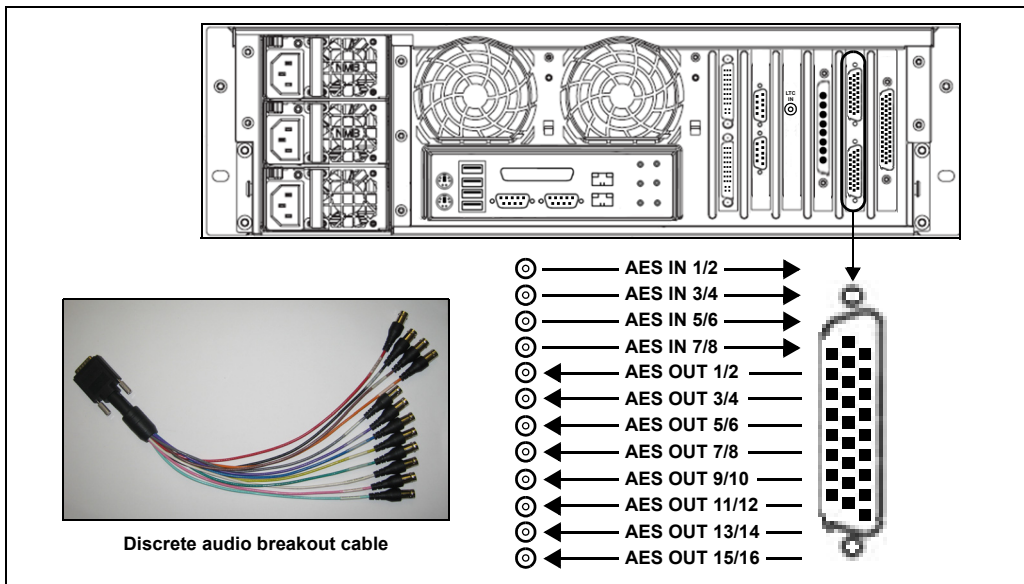

Figure 2-7. Intuition XG's discrete audio channels

When capturing audio, the Intuition XG can capture embedded and discrete simultaneously, however there are restrictions. The stereo pair cannot be captured from both sources at the same time. For example, if only capturing pairs 1 & 2 from embedded, then pairs 1 & 2 are not available from AES, but 3-8 are available.

The Intuition XG performs one-to-one passthrough of audio. All captured audio will be broadcast on the corresponding outputs. For example, if the first 2 stereo pairs of embedded audio on SDI IN A are captured, then the signal will be output as the first 2 stereo pairs of embedded audio on SDI OUT A and simultaneously on AES discrete outputs 1 & 2.

Ancillary data processing

The Intuition XG reserves some hardware functionality for the extraction, processing, and insertion of ancillary data into the output video signal, for example, Vertical Ancillary (VANC) data and Vertical Blanking Interval (VBI) data.

The ancillary data space can be used as a transport mechanism for data to be extracted by the Intuition XG for triggering keyers, squeezes (DVEs) or other graphics events. Metadata embedded upstream of the Intuition XG is extracted and processed by the control application to control these actions.

Clip Player and media storage

The Intuition XG offers a video/audio clip player option that can output clips simultaneously. It is ideal for the playout of full screen or partial screen clips, and the player supports MPEG2 (I frame & Long GOP), MPEG-4 / H.264, DV25, DV50, DV100, IMX30, IMX40, IMX50, MXF, GFX and AVI formats.

All models of the Intuition XG are equipped with a base 1 TB RAID1 storage. The Intuition XG-3U-e and Intuition XG-Dual-e models offer an expandable RAID 10 storage option, which increases the devices storage capacity from 1 TB to 2 TB (**VX-2TB-UPG**). The following table demonstrates the storage capacities of clips in multiple formats using the base and expanded storage configurations.

Mbps	Clip storage with different storage options (hours)	
	1 TB	2 TB
10	200	400
50	40	80
100	20	40

Graphics processing

The Intuition XG's multi-layered graphics engine supports the loading of multiple graphics scenes on independently-controlled, dynamic layers. The number of layers to be controlled is defined in the Xplay control application. A large number of graphics objects, including input video, images, clips, cel animations, text, crawls, rolls, are supported all within a single graphics layer (figure 2-8). Graphics output is created by positioning objects within a graphics scene using the authoring tool set and then loading the scene onto the Intuition XG device.



Figure 2-8. The Intuition XG supports the production of multi-layered graphics

3 INTUITION XG'S DESKTOP APPLICATIONS & TOOLS

Connecting a VGA monitor, keyboard and mouse to the Intuition XG device's rear panel connectors (see [page 2-5](#) or [page 2-11](#)) allows you to view and interact with the Intuition XG's desktop and software applications. Upon startup, the Intuition XG automatically opens its desktop applications, which are used for configuring and controlling the Intuition XG device locally. Once the device is properly configured, these applications are only needed for maintenance. As such, the monitor, keyboard, and mouse can be disconnected.

The following sections describe the Intuition XG's desktop appearance, as well as the various software applications or tools that the Intuition XG makes available through its desktop:

- [“Intuition XG's desktop - device identification” on page 3-2](#)
- [“Intuition XG Control Panel and XG Dashboard” on page 3-3](#)
- [“Xplay - Playout control application” on page 3-5](#)
- [“Vertigo Command Shell” on page 3-10](#)
- [“Windows Explorer” on page 3-12](#)
 - [“Embedded Xmedia Server Control Panel” on page 3-13](#)
 - [“XPublish Agent Control Panel” on page 3-15](#)
 - [“Data Server Control Panel” on page 3-16](#)

NOTE

Although it is not directly an Intuition XG desktop application, the Intuition XG Portal is another software tool that is used to configure and monitor the state of the Intuition XG device from a remote workstation. See [“Intuition XG Portal - Intuition XG's Remote Configuration Tool” on page 4-1](#) for more information.

Intuition XG's desktop - device identification

To easily identify the active device, the Intuition XG's desktop features the Intuition XG logo, as well as identification information related specifically to the Intuition XG device (figure 3-1). Specifically, the information presented are:

- The Vertigo Suite software version that the Intuition XG device is currently running
- The host name given to the Intuition XG device
- The IP Address currently assigned to the Intuition XG device
- The date and time at which the Intuition XG device was last started
- Miranda Technologies Technical Support contact information

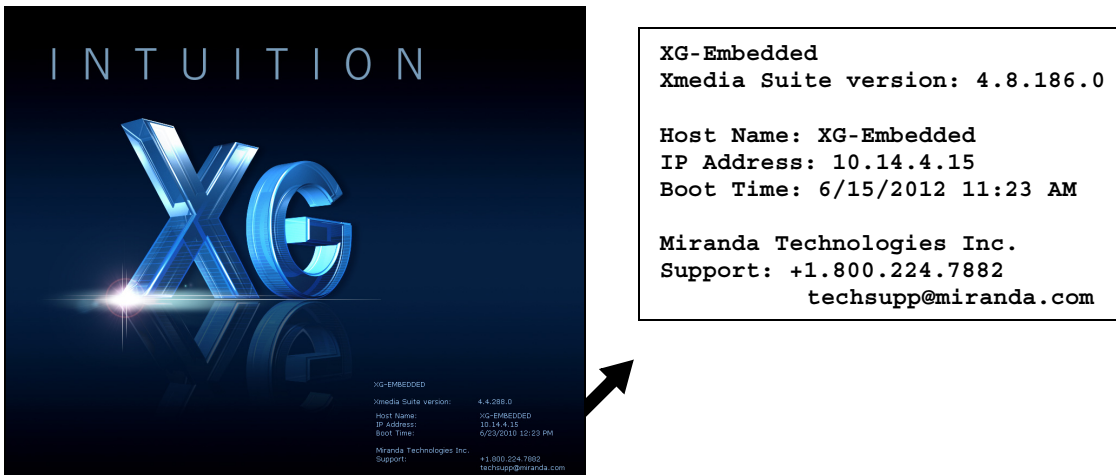

Figure 3-1. The Intuition XG's desktop displays the device's identification information

Intuition XG Control Panel and XG Dashboard

When the Intuition XG is started, the **Intuition XG Control Panel** is automatically opened on the desktop (figure 3-2). The Control Panel is a simple user interface that allows you to quickly reference general information about the Intuition XG device, as well as perform basic tasks for operating the Intuition XG like, loading a scene and launching the XG Dashboard application.

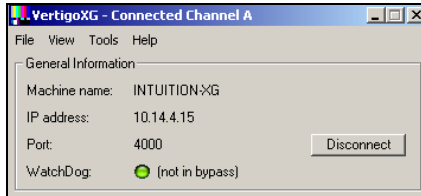

Figure 3-2. The Intuition XG's Control Panel

The following tables provides descriptions of the commands and fields on the Intuition XG's Control Panel:

<p>GENERAL INFORMATION</p>	<p>These read-only fields display information regarding the local host computer that is being used to run/control the Intuition XG device.</p> <ul style="list-style-type: none"> • MACHINE NAME: Name of the host computer. • IP ADDRESS: The IP address of the host computer. • PORT: The port number that is dedicated to the Intuition XG. • WATCHDOG: The Watchdog field on the Intuition XG's Control Panel displays a colored LED along with a brief description indicating its status. <p>The possible states for the Intuition XG's Watchdog are:</p> <ul style="list-style-type: none"> • GREEN - not in bypass • YELLOW – bypass is active – nothing to render • YELLOW – bypass is active – user triggered • RED – bypass is active – other channel failed • RED – bypass is active – D3D error • RED – bypass is active – error • GREY – Disabled • GREY – Ignored
<p>DISCONNECT button</p>	<p>Promptly closes the connection between the Intuition XG device and the application that it was actively connected to.</p>

<p>FILE menu</p>	<ul style="list-style-type: none"> • Open - Launches the OPEN dialog box, allowing you to select and load a scene to the Intuition XG device. The directory that the Open dialog box opens is set in the PUBLISH PATH parameter on Dashboard's GENERAL page. The default directory location for Intuition XG scenes is <code>F:\Scene</code>. Please see "XPublish Agent Control Panel" on page 3-15 for instructions about how to properly set the publish path directories. • Exit - Closes the Intuition XG's Control Panel window. See "Windows Explorer" on page 3-12 for instructions on how to reopen a Control Panel if it was accidentally closed.
<p>FILE menu</p>	<ul style="list-style-type: none"> • Open Log File - Launches the device's current log file in a text editor (Notepad). Note that Logging must be enabled in Dashboard for this menu command to work.
<p>TOOLS menu</p>	<ul style="list-style-type: none"> • Launch Dashboard - Opens the XG Dashboard, which is an application that allows you to configure the settings and behavior of Vertigo devices, including the Intuition XG (see "Dashboard - Intuition XG's Local Configuration Software" on page 5-1). • Identify - Displays the device's identity data on its output. When enabled, the machine name, IP address and command port are displayed on the Intuition XG's output. Note that the identity information appears on the output, even if on-air. Therefore, it should be used for diagnostics and troubleshooting tasks only, and then disabled.
<p>HELP menu</p>	<ul style="list-style-type: none"> • About - Opens the ABOUT VERTIGOXG dialog box, which displays the software version number of the Vertigo Suite installed on the Intuition XG device. <div data-bbox="642 1034 952 1147" data-label="Image"> <p>The image shows a small dialog box titled "About VertigoXG". Inside the dialog box, the text reads "Xmedia Suite 4.8 GA" followed by "(4.8.186.0)" on the next line. To the right of this text is a button labeled "OK". The dialog box has a standard Windows-style title bar with a close button (X) in the top right corner.</p> </div>

Xplay - Playout control application

When the Intuition XG is started, the **Xplay** application automatically opens on the desktop (figure 3-3). Xplay is the playout control application that the automation system uses to control the playout of video and graphics on the Intuition XG device. The automation system and Xplay communicate with each other using industry standard automation protocols.

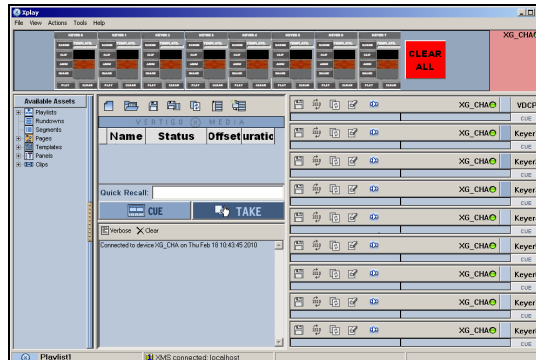

Figure 3-3. Xplay

The **Xplay User Manual** provides instructions and complete information regarding configuring Xplay. Once Xplay is initially configured, you should not have to interact any further with the Xplay application.

For general information, the following sections provide brief descriptions of the Xplay components and/or settings that are relevant to the interaction of the Xplay with an automation system:

- [“Device Manager” on page 3-6](#)
- [“Automation Configuration” on page 3-8](#)
- [“Xplay’s Automation settings” on page 3-9](#)

Device Manager

As the intermediary between the automation system and the Intuition XG device, Xplay must establish a connection directly with the Intuition XG device. This connection is defined by adding the Intuition XG device to Xplay's **Device Manager** (figure 3-4). The Device Manager is accessed by selecting Xplay's **TOOLS>DEVICE MANAGER** menu command.

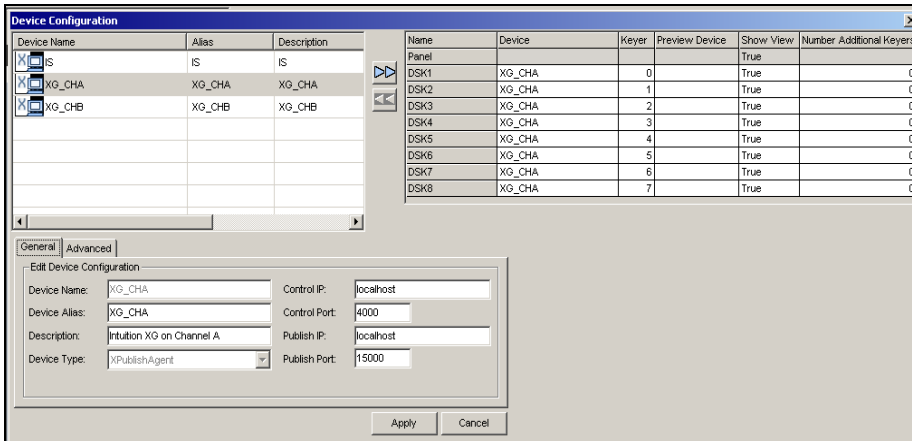

Figure 3-4. The Intuition XG device is added to Xplay's Device Manager

Adding the device involves creating a device configuration profile, which contains the following properties:

General tab

- **DEVICE NAME, DEVICE ALIAS and DESCRIPTION**
- **DEVICE TYPE:** The device type for Intuition XG devices must always be **XPUBLISHAGENT**.
- **CONTROL IP:** The network location (IP address, hostname, or `localhost`) of the selected output device. The host must be available on the network.
- **CONTROL PORT:** The networking port that serves as a channel for sending commands to and from the output device.
- **PUBLISH IP:** The network location (IP address, hostname, or `localhost`) of the selected output device. The host must be available on the network.
- **PUBLISH PORT:** The networking port that serves as a channel for publishing assets. Typically, this value is set to **15000**.

Advanced tab

- **CLIP TEMPLATE, CEL TEMPLATE, IMAGE TEMPLATE:** The name of the template that is used to play out clips, cel animations, and/or images.
- **EXTERNAL KEYS:** This is an optional setting which allows you to configure the Intuition XG to control a master control switcher (i.e. Imagestore 750) by specifying the master control switcher in the **EXTERNAL KEYS** property. Once

the External Keyer settings is applied, an LED for both the Intuition XG and the external keyer device will appear in Xplay's device view keyers that are associated with the Intuition XG (figure 3-5).

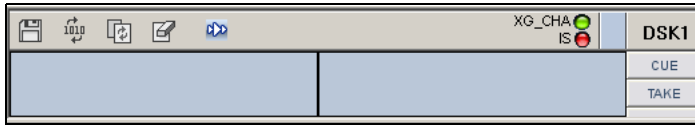

Figure 3-5. LEDs indicate the status of the Intuition XG and its external keyer device

- **PUBLISH MASTER:** Must be left empty.

The Device Manager also features a table (figure 3-6), which displays the number of device keyers that can be controlled by Xplay. The number of keyers available is determined by the **NUMBER OF DEVICES SETTING** in Xplay's **GENERAL** settings.

Name	Device	Keyer	Preview Device	Show View	Number Additional Keyers
Panel				True	
DSK1	XGCHA	0		True	0
DSK2	XGCHA	1		True	0
DSK3	XGCHA	2		True	0
DSK4	XGCHA	3		True	0
DSK5	XGCHA	4		True	0
DSK6	XGCHA	5		True	0
DSK7	XGCHA	6		True	0
DSK8	XGCHA	7		True	0

Figure 3-6. Xplay's device keyer assignments in the Device Manager

Each device keyer in the table is associated to a device upon which the graphics will be played out. A keyer number is also associated to each device keyer which determines the layer level upon which the graphics will be displayed.

NOTE

Instructions and further information about adding devices to Xplay's Device Manager are provided in the **Xplay User Manual**.

Automation Configuration

For the Intuition XG to be controlled by an automation system, the Intuition XG device must be mapped to an automation protocol in Xplay's **Automation Configuration** window (figure 3-7).

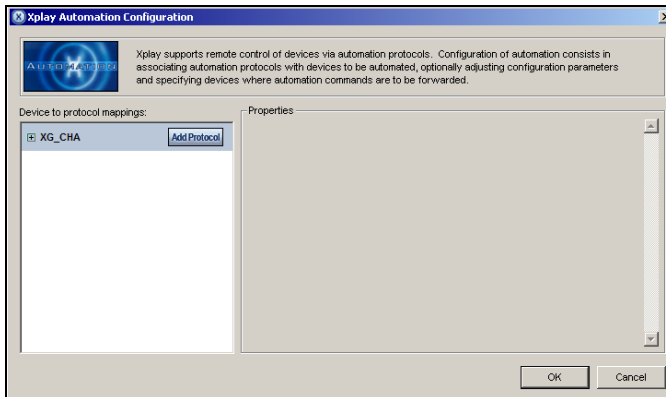

Figure 3-7. Xplay Automation Configuration dialog box

NOTE

The Intuition XG device must be added to Xplay's Device Manager prior to opening the Automation Configuration window. See [page 3-6](#) for more information about the Device Manager.

To set or verify Xplay's Automation Configuration settings:

1. In Xplay, select **TOOLS>AUTOMATION CONFIGURATION**.
The **XPLAY AUTOMATION CONFIGURATION** window appears (figure 3-7).
2. Verify that the Intuition XG device is displayed in the **DEVICE TO PROTOCOL MAPPINGS** list.
3. Verify that the Intuition XG device is mapped to an appropriate protocol by expanding the device's heading in the **DEVICE TO PROTOCOL MAPPINGS** list.

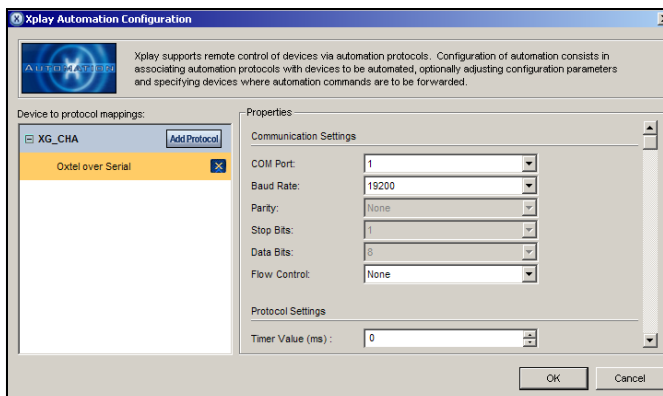

Figure 3-8. The Intuition XG's Automation Configuration (mapping and properties)

If the device is properly mapped to a protocol, simply click **OK** or **CANCEL** to close the **XPLAY AUTOMATION CONFIGURATION** window.

However, if the device is not mapped to an automation protocol:

- a. Select the **ADD PROTOCOL** button next to the device.
- b. Select a protocol from the drop-down list and press **ENTER**.
- c. Verify and set the protocol's properties.
- d. Click **OK**.

Once the Automation Configuration is completed, an automation icon will appear in Xplay's Device Views (figure 3-9) as a visual reminder that automation is configured to control the device associated with that device keyer.

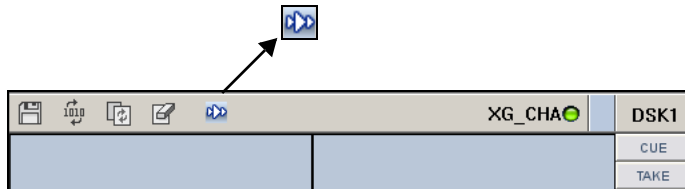

Figure 3-9. Automation icon in Xplay's device view

Xplay's Automation settings

Xplay has a series of settings that define its behavior and functionality. Among these settings are a series of **AUTOMATION** settings, which are used when Xplay is used by an automation system to control the Intuition XG device.

Xplay's Settings window is accessed by selecting the **TOOLS>SETTINGS** menu command. While each of the Xplay and Automation settings are described in the **XPLAY USER MANUAL**, it is worth noting that the **TV FORMAT** should match the TV format of the templates that you build in Xstudio and the **OUTPUT RESOLUTION** setting in the Intuition XG's Dashboard.

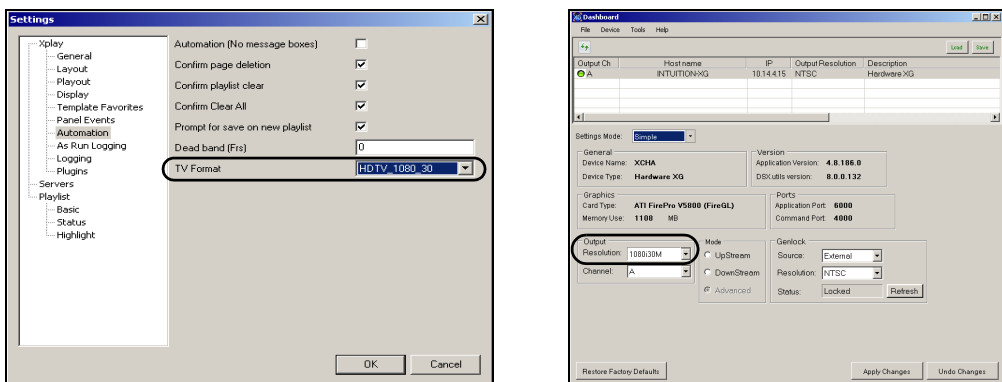

Figure 3-10. Ensure that Xplay's TV Format setting and Dashboard's Resolution setting are identical

Vertigo Command Shell

When the Intuition XG device is started, the **VERTIGO COMMAND SHELL** window (figure 3-11) automatically opens on the desktop. The Vertigo Command Shell window allows you to perform some basic command tasks like opening Windows Explorer and shutdown/reboot the Intuition XG device.

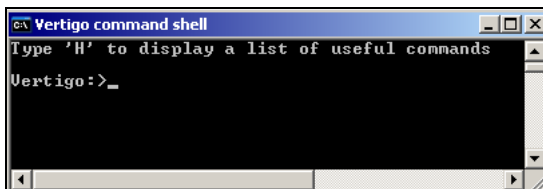

Figure 3-11. The Vertigo Command Shell Window

The following table identifies the commands that can be typed into the Vertigo Command Shell and the actions that are performed:

H	Provides a quick listing of the commands that can typed in the Vertigo Command Shell (the same as listed below).
Explorer	Opens Windows Explorer , which allows you to navigate through the Intuition XG device's drive directories. See "Windows Explorer" on page 3-12 for more information of when to use Windows Explorer on the Intuition XG device.
taskmgr	Opens the Windows Task Manager , which allows you to monitor the status and performance of the Intuition XG device, as well as its applications and processes.
shutdown -f -s t 0... -t	Closes the Intuition XG applications and powers off the Intuition XG device.
reboot	Restarts the Intuition XG device and its applications.
XMS	Opens the Xmedia Server Control Panel.
XPA	Opens the Xpublish Agent Control Panel.
XDS	Opens the Data Server Control Panel.
SQL	Opens SQL Management Studio Express.
RAID	Opens the Intel RAID management software.

Reopening the Vertigo Command Shell window

If ever the Vertigo Command Shell window is closed by accident, you can reopen the window by performing the following procedure:

1. Press **CTRL + SHIFT + ESC**
The Windows Task Manager opens.
2. Select the **FILE>NEW TASK (RUN...)** command.
The **CREATE NEW TASK** dialog box appears.
3. Type `cmd` in the **OPEN** text box and click **OK**.
4. The **VERTIGO COMMAND SHELL** window opens on the desktop.

Windows Explorer

Since Intuition XG's desktop does not contain any icons or shortcuts, therefore you may need to access **Windows Explorer** (figure 3-12) to navigate through your system.

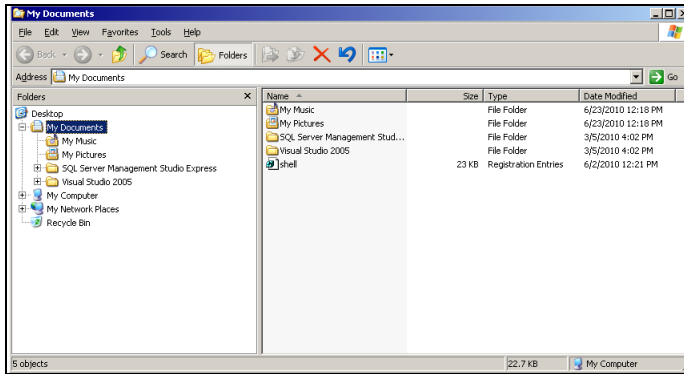

Figure 3-12. Windows Explorer

When Windows Explorer is open, you can type the following system shortcuts in the address bar to access directories relevant to Intuition XG and its applications:

<p>%vxm%</p>	<p>A shortcut to the directory that contains the LOGS folder, which contains the Vertigo log files. See page 5-29 for more information about logging.</p> <p>C:\Documents and Settings\All Users\Application Data\VertigoXmedia\Logos</p>
<p>%vxapps%</p>	<p>A shortcut to the Vertigo Apps directory, which contains files related to the Vertigo Suite applications.</p> <p>C:\Program Files\VertigoXmedia\Apps</p>
<p>c:\Vertigo</p>	<p>Opens the directory that contains shortcuts to the executable file for the Intuition XG Control Panel and Xplay application.</p> <p>If you accidentally close the Xplay window or the Intuition XG Control Panel on the desktop, you can use this directory to access the shortcuts and restart the applications.</p>

You can also use Windows Explorer to navigate to the Windows **CONTROL PANEL** directory, which contains three (3) important Vertigo applications:

- **VERTIGOXMEDIA XMEDIA SERVER** - [“Embedded Xmedia Server Control Panel” on page 3-13](#)
- **VERTIGOXMEDIA XPUBLISHAGENT** - [“XPublish Agent Control Panel” on page 3-15](#)
- **VERTIGOXMEDIA DATA SERVER** - [“Data Server Control Panel” on page 3-16](#)

Embedded Xmedia Server Control Panel

The Intuition XG contains an Embedded Xmedia Server (EXMS), which acts as a local asset database, as well as offering various services to the Intuition XG.

The user interface for configuring and controlling the Embedded Xmedia Server is the **EMBEDDED XMEDIA SERVER (EXMS) CONTROL PANEL**. The EXMS Control Panel features eleven (11) tabbed pages that contain parameters and settings related to the configuration and functioning of the Embedded Xmedia Server.

To open the EXMS Control Panel window, open Windows Explorer (see [page 3-12](#)) and navigate to **CONTROL PANEL>VERTIGOXMEDIA XMEDIA SERVER**.

✓ NOTE

Since all of the Vertigo applications are running locally on the Intuition XG (e.g. Xplay), they connect to the EXMS by specifying `localhost` as their **XMEDIA SERVER IP ADDRESS**.

The following table describes a sampling of the EXMS Control Panels tabbed pages, which are of particular interest when configuring Intuition XG devices:

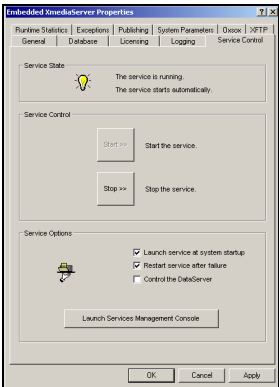
	<h3>General</h3>
	<h3>Service Control</h3>

The **GENERAL** page provides a quick view of the EXMS's product information like version and paths for the executable and working folder.

The **DIRECTORIES CONFIGURATION** properties allow you to specify and view the Embedded Xmedia Server's communication port and the full directory paths where the EXMS stores or retrieves information from.

The Authorization Manager Configuration section allows you to configure, enable, or disable the Vertigo Suite's User Rights Management.

In most cases, the EXMS service is set to automatically launch and run in the background when the Intuition XG is powered up.

At times, the service may need to be stopped and restarted, either manually or as the result of a failure in the system. Therefore, the EXMS Control Panel's Service Control page provides you with buttons and settings for stopping and restarting the EXMS service.

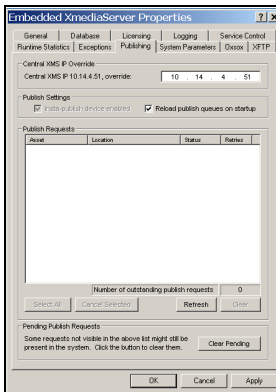

Publishing

The EXMS facilitates the publishing of assets from a central or stand-alone Xmedia Server to the device using server propagation operations (XMS > EXMS > XPublishAgent > device).

The Publishing page contains the following parameters:

- **CENTRAL XMS IP OVERRIDE:** The IP address of the central or stand-alone Xmedia Server device that the EXMS will be receiving the assets from.
- **INSTA-PUBLISH DEVICE ENABLE:** This setting is enabled by default on Intuition XG devices to ensure the publishing of assets from the central XMS to the Intuition XG device.
- **RELOAD PUBLISH QUEUE ON STARTUP:** This setting allows the Publish Request list to be populated with the current publish queue items when the EXMS service is started.

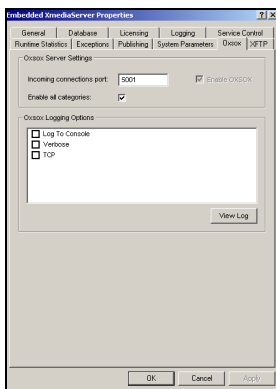

OxSox

The **OXSOX SERVER SETTINGS** are enabled by default on all Intuition XG devices, which makes the Oxsox protocol available for legacy Oxtel media browsers to browse/push assets (e.g. PresStation).

- **ENABLE OXSOX:** Enabled by default on Intuition XG devices.
- **INCOMING CONNECTIONS PORT:** The port (5001) that the EXMS dedicates for communicating with the OxSox softwares.
- **ENABLE ALL CATEGORIES:** Enabling all categories allows the EXMS to reflect all of the assets in its database regardless of category as a flat list, thereby emulating the Intuition and ImageStore. When disabled, the EXMS only reflects the assets stored in the asset type root categories.

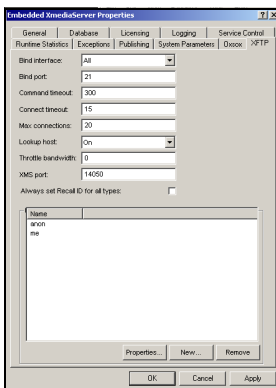

XFTP

The XFTP service allows assets to be moved from the central of stand-alone Xmedia Server to the EXMS without a direct TCP connection. The technique involves first publishing the assets to an FTP device. Then the content can be ingested from the FTP device onto the EXMS. Throughout this procedure, the assetIDs, categorization and other metadata are completely preserved

XPublish Agent Control Panel

Assets are moved from the central Xmedia Server to the Intuition XG device in a process referred to as **publishing**. The XPublish Agent (XPA) is a special service on the Intuition XG device, which is responsible for receiving and processing the publish requests and making the media available to the Intuition XG.

To open the XPublish Agent Control Panel window, open Windows Explorer (see [page 3-12](#)) and navigate to **CONTROL PANEL>VERTIGOXMEDIA XPUBLISHAGENT**.

The XPA service's **BASE PATH** setting controls where media is stored on the recipient Intuition XG device. Figure 3-13 demonstrates that the **BASE PATH** setting must match the **PUBLISH PATH** setting on the XG Dashboard, which determines where the Intuition XG rendering engine expects to find the assets on the central Xmedia Server. The default directory for Intuition XG devices is `F:\Scene`, on both the XPublish Agent and Dashboard. It is recommended that you verify that these settings match.

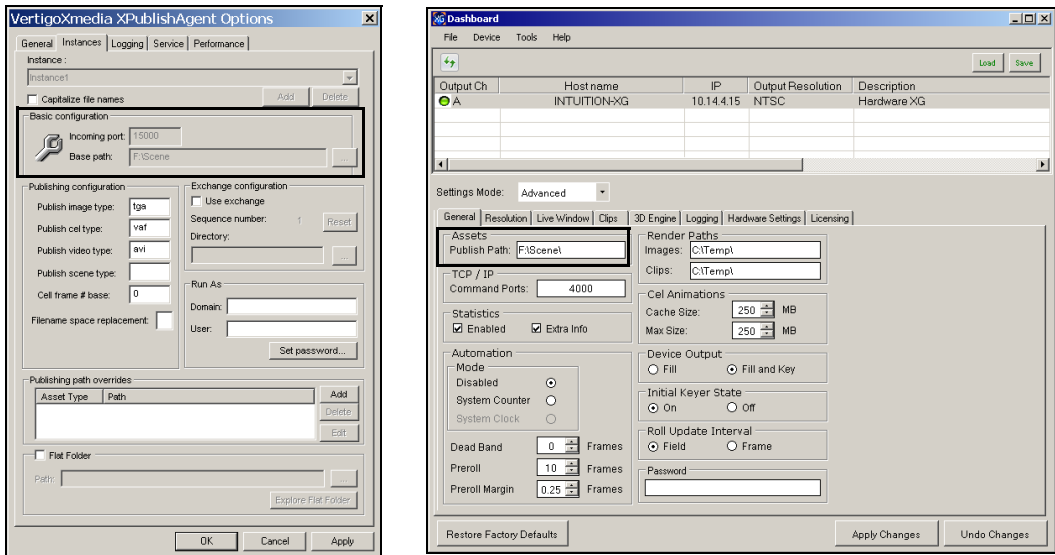

Figure 3-13. The XPA's Base Path and Dashboard's Publish Path settings must be identical

Data Server Control Panel

The Data Server is a service that runs in the background on the Embedded Xmedia Server and is responsible for managing data coming from various feeds by providing live updates of data values when requested, and distributing the data to the appropriate recipients.

The **DATA SERVER CONTROL PANEL** (VertigoXmedia Data Server Option window) is the user interface that is used to configure and control the Data Server service (figure 3-14). You can open the Data Server Control Panel by opening Windows Explorer (see [page 3-12](#)) and navigating to **CONTROL PANEL>VERTIGOXMEDIA DATA SERVER**.



Figure 3-14. The Data Server Control Panel

The Data Server Control Panel features three (3) tabbed pages that contain parameters for configuring the connection, metadata, and logging options, as well as stopping and starting the Data Server service.

4 INTUITION XG PORTAL - INTUITION XG'S REMOTE CONFIGURATION TOOL

The **INTUITION XG PORTAL** (figure 4-1) is a web server interface that provides you with remote access to information about a specific Intuition XG device's settings and operation. You can also use the Intuition XG Portal to perform some basic configuration and control tasks, like change the network settings or shutdown/restart the device.

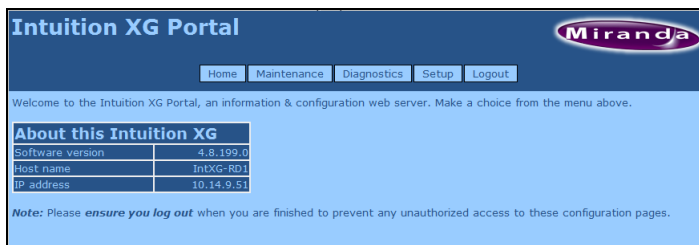

Figure 4-1. The Intuition XG Portal - Intuition XG's remote configuration tool

The following sections describe the Intuition XG Portal's features, as well as how to use the Portal's menu commands to interact with the Intuition XG device:

- [“Accessing and logging into the Intuition XG Portal” on page 4-2](#)
- [“Overview of the Intuition XG Portal's menu commands” on page 4-4](#)
- [“Remotely shutting down the Intuition XG device” on page 4-6](#)
- [“Restarting the Intuition XG device remotely” on page 4-7](#)
- [“Viewing the processes running on the Intuition XG device” on page 4-8](#)
- [“Configuring Intuition XG's network settings” on page 4-9](#)
- [“Specifying the Intuition XG device's hostname” on page 4-11](#)
- [“Specifying the Intuition XG device's Date & Time settings” on page 4-12](#)
- [“Logging off of the Intuition XG Portal” on page 4-13](#)

Accessing and logging into the Intuition XG Portal

Once the Intuition XG device is running and is properly connected to the LAN, you can access the Intuition XG Portal from any client workstation that is connected to the network using a standard graphical web browser, like Internet Explorer.

✓ NOTE

As a prerequisite to using the Intuition XG Portal, you must know that Intuition XG devices IP address. Contact your network administrator for the device's IP address, or take note of it from the Intuition XG Control Panel (see [page 3-3](#)).

To access and log into the Intuition XG Portal:

1. Open a web browser (e.g. Internet Explorer) on a client workstation that is connected to the same local network as the Intuition XG device.
2. Type the IP address or hostname of the Intuition XG device into the address bar of the web browser (e.g. `http://10.0.4.245` or `http://xg-embedded3`) and press **ENTER**. The Intuition XG Portal's **LOGIN** page appears (figure [4-2](#)).

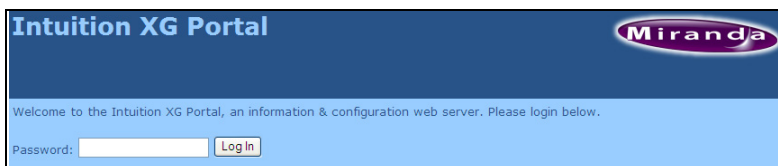

Figure 4-2. The Intuition XG Portal's Login page

✓ NOTE

If the Intuition XG Portal's **LOGIN** page does not appear, verify the IP address in the web browser's address bar for typographical errors. Other reasons that it might not appear are that the Intuition XG device is not running, that it is not properly connected to the network, or the network is down.

3. Log into the application by typing `vertigo` in the **PASSWORD** text box and clicking the **LOGIN** button.

The **INTUITION XG PORTAL** Home page appears (figure [4-3](#)).



Figure 4-3. The Intuition XG Portal's Home page

4. Choose from among the menu bar to perform the various functions. See [page 4-4](#) for descriptions of each of the menu commands.

NOTE

Please ensure that you log out when you are finished to prevent any unauthorized access to these configuration pages. See [page 4-13](#) for instructions on how to log off.

Overview of the Intuition XG Portal's menu commands

With the exception of the **LOGIN** page, the **INTUITION XG PORTAL** always features a menu bar in the top banner that allows you to navigate through the application (figure 4-4).

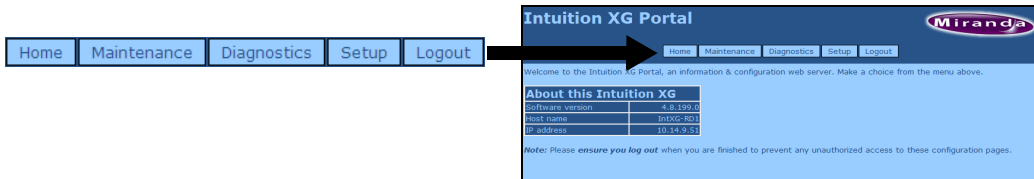

Figure 4-4. Intuition XG Portal's menu bar

The five(5) menus at the top of the Intuition XG Portal provide access to commands and/or actions that allow you to view information about the device, configure settings, and/or perform some basic control actions. The following list identifies the function of each of the menus and their associated commands:

<p>Home</p>	<p>Returns the Intuition XG Portal immediately to its home page, which displays the following information:</p> <ul style="list-style-type: none"> • SOFTWARE VERSION: The version of the Vertigo Suite that the device is currently running. • HOST NAME: The host name that is currently assigned to the Intuition XG device. To change to host name, select SETUP>HOSTNAME SETUP from the menu bar. • IP ADDRESS: The IP Address that is currently assigned to the Intuition XG device. To change to IP Address, select SETUP>NETWORK SETUP from the menu bar (see page 4-9 for more information).
<p>Maintenance</p>	<p>The MAINTENANCE menu features the following commands that allow you to perform a soft shutdown or restart the Intuition XG device remotely.</p> <ul style="list-style-type: none"> • SYSTEM RESTART: Allows you to restart the Intuition XG remotely from a workstation. See page 4-7 for more information. • SYSTEM SHUTDOWN: Allows you to shutdown the Intuition XG remotely from a workstation. See page 4-6 for more information.
<p>Diagnostics</p>	<p>The DIAGNOSTICS menu features the following commands:</p> <ul style="list-style-type: none"> • RUNNING PROCESSES: Allows you to view a listing of the processes currently running on the Intuition XG device. See page 4-8 for more information. • DIAGNOSTIC ZIP FILE: Currently not supported. Gathers log files, configuration files and registry settings that are related to the device. This data is a zipped into a file, which can be saved or viewed immediately.

Setup	<p>The SETUP menu features the following commands that allow you to edit the Intuition XG device's current network, host name, and Date/Time settings using a remote workstation.</p> <ul style="list-style-type: none">• NETWORK SETUP: Allows you to configure the network settings of the Intuition XG device, including the IP ADDRESS, SUBNET MASK, and DEFAULT GATEWAY. See page 4-9 for more information.• HOSTNAME SETUP: Allows you to assign a new host name for the Intuition XG device. See page 4-11 for more information.• TIME SETUP: Allows you to configure the date and time (clock) belonging to the Intuition XG device. See page 4-12 for more information.
Logout	Immediately logs you off from the current session and returns the Intuition XG Portal to the Login page. See page 4-13 for more information.

Remotely shutting down the Intuition XG device

The Intuition XG Portal allows you to shutdown of the Intuition XG device from a remote workstation using the **MAINTENANCE** menu's **SHUTDOWN SYSTEM** command.

To shutdown the Intuition XG device using the Intuition XG Portal:

1. Log into the Intuition XG's Portal (see [page 4-2](#)).
2. Select the **MAINTENANCE>SYSTEM SHUTDOWN** command.
The Portal's **SYSTEM SHUTDOWN** page appears (figure [4-5](#)).

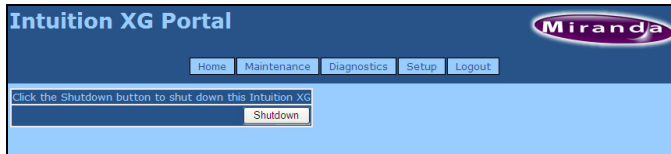

Figure 4-5. The Intuition XG Portal's System Shutdown page

3. Click the **SHUTDOWN** button to shut down the Intuition XG device.
A window appears asking you to confirm that you want to shut down the device (figure [4-6](#)).

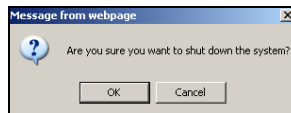

Figure 4-6. Confirm whether or not you want to shut down the device

4. Click **OK** to shut down the device, or click **CANCEL** to keep the device running.

NOTE

The Intuition XG device must be running for the Intuition XG Portal to be available. Therefore, once the Intuition XG device is shutdown, you can no longer use the Intuition XG Portal to configure or restart the device.

Restarting the Intuition XG device remotely

The Intuition XG Portal allows you to restart an actively running Intuition XG device from a remote workstation using the **RESTART SYSTEM** command in the **MAINTENANCE** menu.

✓ NOTE

The Intuition XG device must be operating for the Intuition XG Portal to be available. Therefore, once the Intuition XG device is shutdown, you can no longer use the Intuition XG Portal to configure or restart the device.

To restart the Intuition XG device using the Intuition XG Portal:

1. Log into the Intuition XG's Portal (see [page 4-2](#)).
2. Select the **MAINTENANCE>SYSTEM RESTART** command.
The Portal's **SYSTEM RESTART** page appears ([figure 4-7](#)).

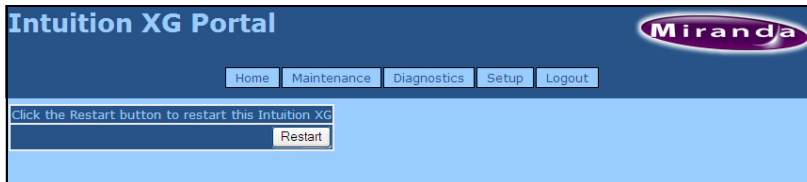

Figure 4-7. The Intuition XG Portal's System Restart page

3. Click the **RESTART** button to restart down the Intuition XG device.
A window appears asking you to confirm that you want to restart the device ([figure 4-8](#)).

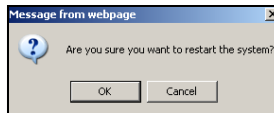

Figure 4-8. Confirm whether or not you want to restart the device

4. Click **OK** to restart the device.
The Portal immediately returns to the Intuition XG Portal's **LOGIN** page.
Give the machine sufficient time to complete the reboot process and then log back into the system (see [page 4-2](#)).

Viewing the processes running on the Intuition XG device

The Intuition XG Portal allows you to view and monitor (in real time), a comprehensive list of the processes that are currently running on the Intuition XG device (figure 4-9). Like the **PROCESSES** tab in the Windows Task Manager, the Portal's Processes page reports and measures each process' status and performance.

NOTE

The Portal's **PROCESSES** list is read-only and is intended for consultation purposes only. You cannot interact in any way with the list of processes from this interface. If you need to interact with a process (i.e. end a process), you must...

Image Name	PID	Mem Usage	User Name	CPU Time
System Idle Process	0	16 K	NT AUTHORITY\SYSTEM	1301:42:07
System	4	224 K	NT AUTHORITY\SYSTEM	0:10:54
smss.exe	1128	396 K	NT AUTHORITY\SYSTEM	0:00:00
csrss.exe	1228	2,728 K	NT AUTHORITY\SYSTEM	0:00:17
winlogon.exe	1260	4,500 K	NT AUTHORITY\SYSTEM	0:00:00
services.exe	1304	5,668 K	NT AUTHORITY\SYSTEM	0:02:07
lsass.exe	1316	7,632 K	NT AUTHORITY\SYSTEM	0:07:34
svchost.exe	1464	5,300 K	NT AUTHORITY\SYSTEM	0:00:00
svchost.exe	1540	4,488 K	NT AUTHORITY\NETWORK SERVICE	0:00:00
at2evxx.exe	1892	3,188 K	NT AUTHORITY\SYSTEM	0:00:00
svchost.exe	1784	21,108 K	NT AUTHORITY\SYSTEM	0:11:42
at2evxx.exe	1904	3,608 K	NT AUTHORITY\SYSTEM	0:00:00
svchost.exe	1936	4,680 K	NT AUTHORITY\NETWORK SERVICE	0:00:02
svchost.exe	296	6,700 K	NT AUTHORITY\LOCAL SERVICE	0:02:00
spoolsv.exe	620	4,712 K	NT AUTHORITY\SYSTEM	0:00:00
msdtc.exe	800	5,060 K	NT AUTHORITY\NETWORK SERVICE	0:00:00
StorServ.exe	884	20,144 K	NT AUTHORITY\SYSTEM	0:18:02
LIGHTSRC.exe	1112	1,436 K	NT AUTHORITY\SYSTEM	0:00:00
LightTPD.exe	1160	4,296 K	NT AUTHORITY\SYSTEM	0:00:01

Figure 4-9. The Intuition XG Portal's Processes page

To view a list of the processes currently running on the Intuition XG device:

1. Log into the Intuition XG's Portal (see [page 4-2](#)).
2. Select the **DIAGNOSTICS>RUNNING PROCESSES** command.

The Portal's **PROCESSES** page appears (figure 4-9) and lists all of the processes that are currently running on the Intuition XG device. Each process is list in a table that contains the following column categories, which report back information in real-time:

IMAGE NAME	The name of the process.
PID	Process Identifier: A unique number assigned to the process to help identify it while it runs.
MEM USAGE	The amount of main memory, in kilobytes, used by the process.
USER NAME	The user account under which the process is running.
CPU TIME	The total processor time, in seconds, used by the process since it was started.

Configuring Intuition XG's network settings

The Intuition XG Portal allows you to conveniently configure the Intuition XG device's network settings from a remote workstation. The Portal's **NETWORK SETUP** page allows you to change the following settings: **IP ADDRESS**, **SUBNET MASK**, and **DEFAULT GATEWAY**.

We recommend that a static IP address be assigned to the Intuition XG device when it is originally installed and configured. In some cases, however, the Intuition XG device may have been originally configured using DHCP. If so, the Network Setup page will display the following warning:

This Intuition XG is currently configured to obtain IP addresses automatically using DHCP. Using DHCP is not recommended.

Since using DHCP is not recommended, we ask that you enter a new IP address on the Network Setup page, which will immediately assign a static IP Address to the Intuition XG device.

NOTE

Changing the IP address will require that you reconfigure the Device settings for this Intuition XG device on the central Xmedia Server.

To change the Intuition XG device's network settings:

1. Log into the Intuition XG's Portal (see [page 4-2](#)).
2. Select the **SETUP>NETWORK SETUP** command.
The Portal's **NETWORK SETUP** page appears (figure [4-10](#)).

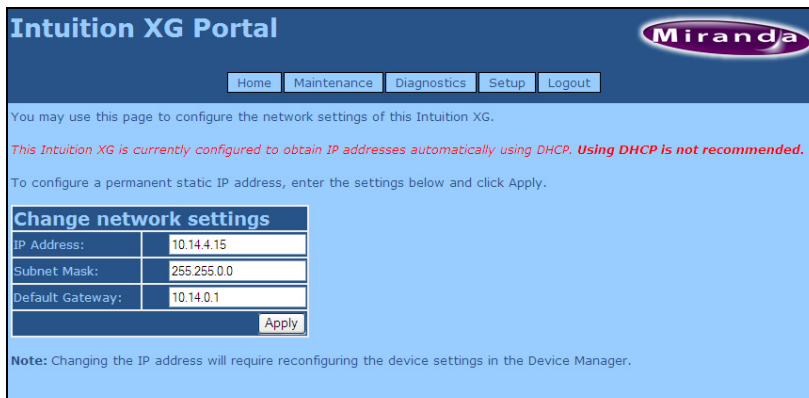

Intuition XG Portal Miranda

Home Maintenance Diagnostics Setup Logout

You may use this page to configure the network settings of this Intuition XG.

This Intuition XG is currently configured to obtain IP addresses automatically using DHCP. Using DHCP is not recommended.

To configure a permanent static IP address, enter the settings below and click Apply.

Change network settings	
IP Address:	10.14.4.15
Subnet Mask:	255.255.0.0
Default Gateway:	10.14.0.1
<input type="button" value="Apply"/>	

Note: Changing the IP address will require reconfiguring the device settings in the Device Manager.

Figure 4-10. The Intuition XG Portal's Network Setup page

3. To change the **IP ADDRESS**, **SUBNET MASK**, and/or **DEFAULT GATEWAY** values, type the new value in the corresponding text box.

4. Click the **APPLY** button.

A window appears asking you to confirm that you want to change the IP Address (figure [4-11](#)).

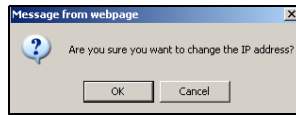

Figure 4-11. Confirm whether or not you want to apply the new settings

5. Click **OK** to apply the new IP Address, or click **CANCEL** to keep the previous hostname.

✓ NOTE

The Intuition XG device does not have to be restarted for these settings to be applied. However, the next time you access the Intuition XG Portal, you will use the new IP Address in the web browser's address bar.

Specifying the Intuition XG device's hostname

The Intuition XG Portal allows you to conveniently change the Intuition XG device's hostname from a remote workstation.

NOTE

Changing the hostname requires that the Intuition XG device be immediately restarted for the change to be applied.

To change the Intuition XG device's hostname:

1. Log into the Intuition XG's Portal (see [page 4-2](#)).
2. Select the **SETUP>HOSTNAME SETUP** command.

The Portal's **HOSTNAME SETUP** page appears with the current hostname value displayed in the Hostname text box (figure [4-10](#)).

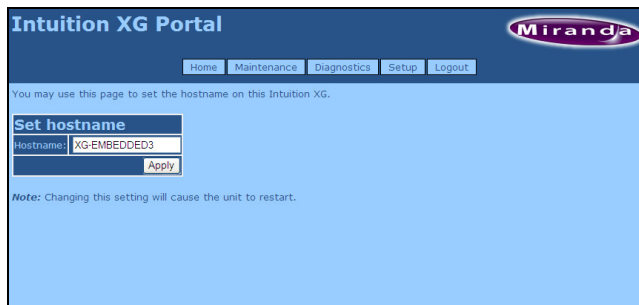

Figure 4-12. The Intuition XG Portal's Hostname Setup page

3. Type the new hostname in the text box and click the **APPLY** button. A window appears asking you to confirm that you want to change the hostname (figure [4-13](#)).

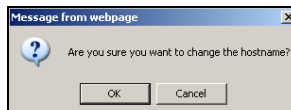

Figure 4-13. Confirm whether or not you want to apply the new settings

4. Click **OK** to apply the new hostname. The Intuition XG device will now automatically perform a restart.
Or,
Click **CANCEL** to keep the previous hostname.

Specifying the Intuition XG device's Date & Time settings

The Intuition XG Portal allows you to conveniently change the Intuition XG device's date and time settings.

☑ NOTE

Any change to the **TIME** setting will not take effect if a timecode card is installed.

To change the Intuition XG device's Date and/or Time settings:

1. Log into the Intuition XG's Portal (see [page 4-2](#)).
2. Select the **SETUP>TIME SETUP** command.

The Portal's **TIME SETUP** page appears and displays the following fields and information: **DATE**, **TIME**, and **CURRENT TIME** (figure [4-14](#)).

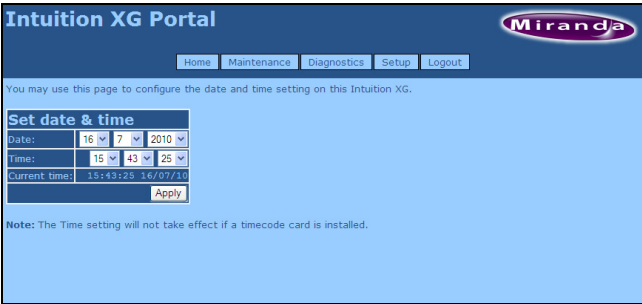

Set date & time		
Date:	16	7 2010
Time:	15	43 25
Current time:	15:43:25 16/07/10	
Apply		

Note: The Time setting will not take effect if a timecode card is installed.

Figure 4-14. The Intuition XG Portal's Time Setup page

3. Use the drop-down lists in the **DATE** and **TIME** fields to select the new date and time values.
4. Click the **APPLY** button.

Logging off of the Intuition XG Portal

To prevent any unauthorized access to the Intuition XG Portal's configuration pages, we highly recommend that you log out when you are finished your session.

To log out of the Intuition XG Portal:

- Click the **LOGOUT** menu command.

The Intuition XG Portal immediately returns to its **LOGIN** page and your session has securely been terminated.

5 DASHBOARD - INTUITION XG'S LOCAL CONFIGURATION SOFTWARE

Dashboard is an application that allows you to configure the settings and behavior of the Vertigo hardware devices (Vertigo XG or Intuition XG) and software CG that are currently running on your network. The Dashboard application simplifies the configuration process by offering a series of pages containing the parameters that control how video and audio processed, rendered and output by the device.

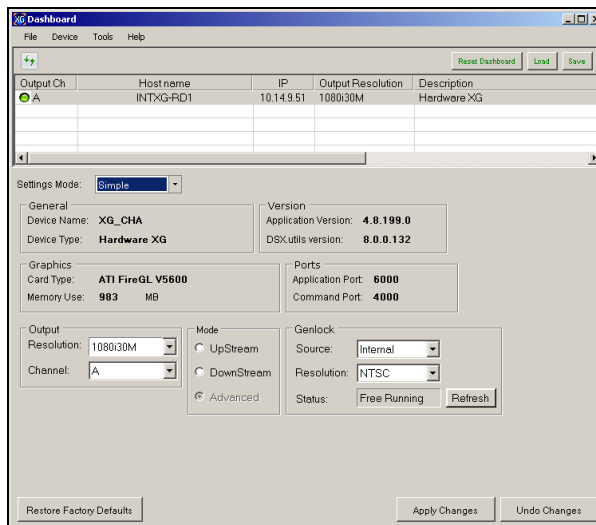

Figure 5-1. The Dashboard Window

✓ NOTE

Most Intuition XG devices are installed and configured by qualified network administrators or Miranda's Integration Specialists using the Dashboard software interface. Changing these settings may result in undesirable behaviors or hinder the performance of the Intuition XG device. Therefore, we recommend that you use caution should you change any of the Intuition XG settings.

The following topics aim to further explain the function of Dashboard, as well as familiarize you with the various parts of Dashboard's interface:

- [“About the Dashboard” on page 5-3](#)
- [“Starting Dashboard” on page 5-4](#)
- [“An overview of the Dashboard's interface components” on page 5-5](#)
- [“Dashboard's menus and buttons” on page 5-6](#)
- [“Device List” on page 5-8](#)
- [“Device Profile page” on page 5-15](#)
- [“Device Settings tabs and configuration pages” on page 5-17](#)
- [“Device Discovery Tool” on page 5-11](#)
- [“Audio Mixing Profiles dialog box” on page 5-43](#)

NOTE

Dashboard is a common interface that is used to configure Intuition XG, Vertigo XG, and software CG devices.

About the Dashboard

Dashboard is an application that allows you to modify the settings and behavior of Vertigo devices.

One of the first things that Dashboard does is perform a device discovery, which searches your local machine and/or your network for all active Vertigo devices (i.e. Intuition XG or Vertigo XG) and then lists them on Dashboard's [Device List](#). Using the [Device Discovery Tool](#), Dashboard allows you to configure the device discovery's search parameters resulting in a more focused search for a particular device, or a broader search to reveal more devices. See ["Device Discovery Tool" on page 5-11](#) for more details.

Once the devices are listed and active in the device table, you can select a device from the list to display to view and configure the device's settings. Dashboard can display a device's settings in two (2) modes: **SIMPLE** or **ADVANCED**.

When the **SETTING MODE** is set to **SIMPLE**, a selection of the device's properties and important settings are displayed on the [Device Profile page](#) below the Device List. This information can be useful to identify the device's configuration, as well as for troubleshooting problems.

Changing the **SETTING MODE** from **SIMPLE** to **ADVANCED** replaces the device's profile information with a series of settings tabs that provide access to the device's configuration pages. Each of the eight (8) configuration tabs exposes the parameters and settings for the selected device.

A description of each page and their parameters/settings is provided in ["Device Settings tabs and configuration pages" on page 5-17](#). These descriptions generally state what the parameter is and informs you of what should be taken into consideration when changing the default settings.

Selecting the various pages allows you to edit the device's settings to build your desired configuration. You can apply the changes immediately to the device (see ["Device settings buttons" on page 5-18](#)). Note that some settings required the device to be restarted in Dashboard's Device List for the changes to be applied (see ["Restarting a device in the device list" on page 5-10](#)).

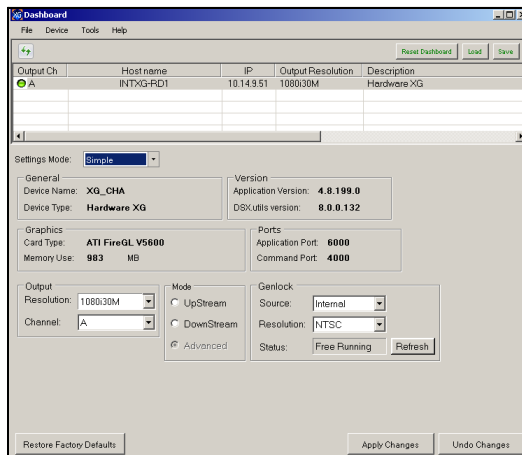

Starting Dashboard

The Dashboard application can be started by selecting the **TOOLS>LAUNCH DASHBOARD** command on the Intuition XG device's Control Panel.

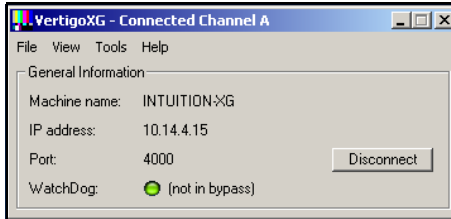

Figure 5-2. Select the **TOOLS>LAUNCH DASHBOARD** command to start the Dashboard

Alternatively, the Dashboard application can also be started independently by navigating through Windows Explorer to the **Dashboard.exe** file that is stored in the following directory on the host computer: `C:\Program Files\VertigoXmedia\Apps\`. See [page 3-12](#) for a shortcut to the Apps folder.

An overview of the Dashboard's interface components

Dashboard is a graphical interface that consists of a series of tabbed pages containing the parameters and settings for the Vertigo devices on the network.

Figure 5-2 and the following sections describe the various components that make up Dashboard's interface:

- [“Dashboard's menus and buttons” on page 5-6](#)
- [“Device List” on page 5-8](#)
- [“Device Discovery Tool” on page 5-11](#)
- [“Device Profile page” on page 5-15](#)
- [“Device Settings tabs and configuration pages” on page 5-17](#)
- [“Audio Mixing Profiles dialog box” on page 5-43](#)

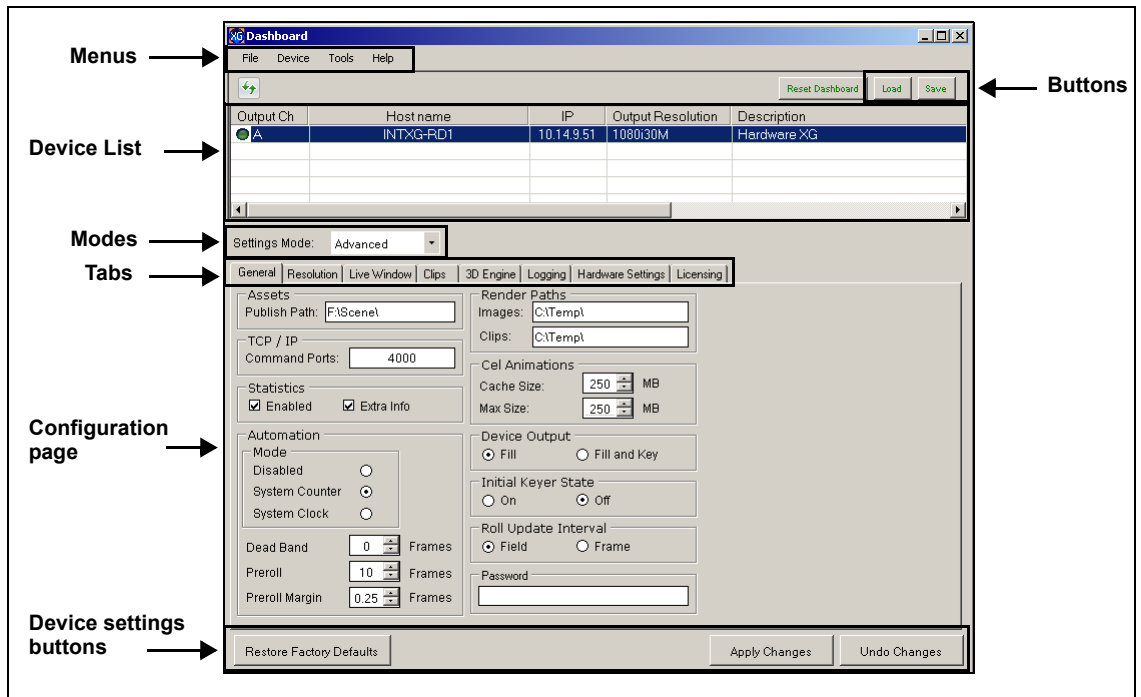





Figure 5-3. Dashboard window components

Dashboard's menus and buttons

The following tables describe the actions that are performed by Dashboard's menu commands and buttons:

<p>FILE MENU</p>	<ul style="list-style-type: none"> • LOAD DEVICE LIST : Clears the Device List and repopulates it using the saved list of devices stored on disk from a previous session. When Dashboard starts up, it automatically performs a load to populate the device list. If the saved device list is empty, Dashboard performs a scan to detect any new devices. Note that this is the same type of scan action as clicking the refresh button. • SAVE DEVICE LIST : Saves all the devices already in the Device List to a file on the disk, so that Dashboard avoids having to detect devices every time it is run. See also the EXIT command and "SAVE DEVICE LIST ON EXIT" on page 5-12. • EXIT: Closes the Dashboard application. The first time you exit Dashboard, the AUTO-SAVE ON EXIT dialog box appears before the application closes and asks you if you want to automatically save the device list. Click YES to save the device list and close Dashboard, or NO to simply close Dashboard. During subsequent exits the Auto-Save on Exit dialog box will not appear. If you would like to save the device list, however, you can use the File menu's "SAVE DEVICE LIST" command, or select "SAVE LIST ON EXIT" on the Device Discovery Tool.
<p>DEVICE MENU</p>	<ul style="list-style-type: none"> • REFRESH DEVICE LIST : Updates the Device List by launching a search for available Vertigo devices using the Device Discovery settings specified in the Device Discovery Tool dialog box. • RESTART DEVICE: Restarts the Vertigo device that is selected in the Device List. The device may need to be restarted to have certain settings take effect when you are configuring the device. When these settings are changed, Dashboard automatically prompts you with a dialog box asking if you want to restart the device immediately when the settings are changed. If you would rather restart the device at a later time, refuse Dashboard's request and use the Restart Device command later when you are ready to restart the device. • MONITOR DEVICE STATUS: When selected, it will query all the devices in the Device List to see if the status has changed. For example, active devices have become inactive, or inactive devices have become active. Note that the interval between polling can be changed using the REFRESH RATE parameter on Device Discovery Tool. • IDENTIFY DEVICE OUTPUT: When enabled, the machine name, IP address and command port are displayed on the Intuition XG's output. Since the identity information appears on the output, even if on-air, it should only be used for diagnostics and troubleshooting tasks.

TOOLS MENU

SETTINGS > DEVICE DISCOVERY: Opens the [Device Discovery Tool](#), which is used to set the method that will be used to detect available devices, whether they are local or remote (on the network).

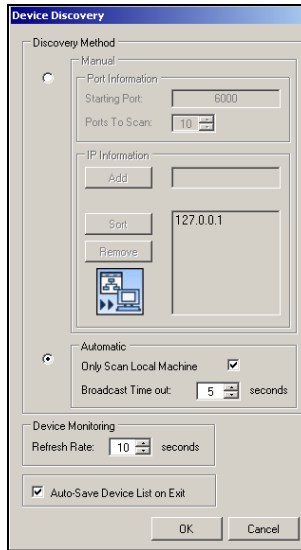
**HELP MENU**

Opens the **ABOUT XG DASHBOARD** dialog box, which displays the Dashboard product information, including the version number.

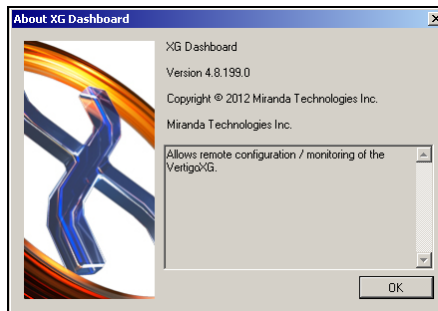

Device List

The Device List identifies the Vertigo devices that were found on the host machine (local) and/or on the network when a device discovery search is performed.

Output Ch	Host name	IP	Output Resolution	Description
A	CA-VXM-XGRD3	10.14.3.47	1080i30M	Hardware XG
B	CA-VXM-XGRD3	10.14.3.47	NTSC	Hardware XG
SWCG	CA-VXM-XGRD3	10.14.3.47	NTSC	Software CG

Depending upon which **SETTINGS MODE** is selected, Dashboard displays either the Device Profile page or the configuration pages for the selected device.

The following table provides a description for each of the columns in the Device List and the topics listed below describe the tasks that you can perform using the Device List.

- [“Loading and refreshing the device list” on page 5-9](#)
- [“Saving the device list” on page 5-9](#)
- [“Restarting a device in the device list” on page 5-10](#)
- [“Monitoring the status of a device” on page 5-10](#)
- [“Removing a device from the device list” on page 5-10](#)

OUTPUT CHANNEL	<p>Displays the name of the output channel for the Vertigo device. Typically, this is A or B.</p> <p>Note: If the device is a Vertigo software CG, this field always displays “SWCG” as the output channel.</p> <p>A green or red light is displayed next to the output channel name, which indicates the state of the device.</p> <p>The green light indicates that the device is active, connected to Dashboard, and ready to accept commands.</p> <p>The red light indicates that the device is not active and no connection has been established by Dashboard. Therefore, you need to start the device and connect it to Dashboard through the host computer or the network.</p>
HOST NAME	Displays the name of the host computer.
IP	Displays the IP address of the device.
OUTPUT RESOLUTION	Displays the setting of the output rendering resolution as specified on the device’s Device Profile page or the Resolution page .
DESCRIPTION	Displays whether the device is a Software CG (Software-based rendering and preview application) or a hardware XG (hardware-based renderer and production device). Also, displays connection error messages (e.g. Failed to Open Socket).

Loading and refreshing the device list

The mechanism used to find and list devices on Dashboard 's Device List is a tool called the [Device Discovery Tool](#). As described on [page 5-11](#), the Device Discovery tool allows you to select between two methods of searching for Vertigo devices: automatic or manual.

Upon starting, Dashboard automatically begins a device discovery to locate the available Vertigo devices and then lists them on the Dashboard's Device List.

You can set the method used during the device discovery anytime, by accessing the Device Discovery tool from Dashboard's **TOOLS>SETTINGS** menu (see [page 5-11](#) for instructions).

Use the Device menu's **REFRESH DEVICE LIST** command, or the **REFRESH** button , to update the device list at anytime. This action starts a device discovery that scans the local machine and/or network and updates the status of the devices already listed and adds any newly found devices.

Devices that are actively connected and ready to be used with Dashboard are indicated in the Device List with a green light next to their name, while inactive devices have a red light. When a device discovery is performed and the list is refreshed, the status of the listed devices is also updated. An inactive device means that it is not in communication with Dashboard, perhaps because the device is turned off, it has crashed, or the network is down. If the device has crashed, you can restart it using Dashboard's **RESTART DEVICE** command (see "[Restarting a device in the device list](#)" on [page 5-10](#)). When the device is active again, performing a refresh of the device list will return its status to a green light.

Saving the device list

Upon starting, Dashboard automatically begins a device discovery to locate the available Vertigo devices and then lists them on the Dashboard's Device List. This initial device list can be saved, so that the next time Dashboard performs a device discovery (refresh), it only has to update the status of the listed devices rather than searching for them again.

Use the File menu's **SAVE DEVICE LIST** command, or the **SAVE** button, to save the device list. If you do not save the device list before exiting Dashboard, the application asks you if you would like to save the device list before exiting. This prompt only happens the first time you exit Dashboard after installation.

As an alternative to manually saving the device list, you can use the Device Discovery tool's **AUTO-SAVE DEVICE LIST ON EXIT** parameter to automatically save the device list when you exit the Dashboard application.

Restarting a device in the device list

During configuration, there are some device parameters that require that the Vertigo device to be restarted before the new settings can take effect. When these settings are changed, Dashboard automatically prompts you with a dialog box asking if you want to restart the device immediately. If you would rather restart the device at a later time, decline Dashboard's request and use the Device menu's **RESTART DEVICE** command when you are ready to restart the device.

Another use for the Restart Device command is to re-activate a device from the Device List that has become inactive (red light) because the device crashed. The **RESTART DEVICE** command performs a remote restart of the device, which may resolve the issue and return the device to an active state (green light) after performing a refresh of the device list.

Monitoring the status of a device

The status of a Vertigo device is reported in the Device List by a green (active) or red (inactive) light next to its name. You can monitor the status of a device by activating the Device menu's **MONITOR DEVICE STATUS** command, which uses the **REFRESH RATE** setting on the Device Discovery tool to determine at what frequency to update the device's status on the device list.

To monitor the status of a Vertigo device listed in the Dashboard Device List:

1. Select the device in the Device List.
2. Launch the Device Discover tool by selecting **TOOLS > SETTINGS > DEVICE DISCOVERY**.
3. Set the Device Monitoring's Refresh Rate parameter to the desired frequency interval. For example, a setting of 10, checks the status every 10 seconds.
4. Click **OK**.
5. Select the **MONITOR DEVICE STATUS** command in the **DEVICE** menu.

Removing a device from the device list

If the device list has previously been saved, it will list all of the Vertigo devices found and updated from the previous device discovery, including Vertigo devices that are active, inactive, local, and/or networked.

There may be times when you want to limit the devices displayed in the device list to a particular few. If this is the case, you can tailor the device list by removing any unwanted devices from the device list.

To remove a device from the device list:

1. Right-click on the device in the device list that you want to remove.
2. Select the **REMOVE DEVICE** command.

Device Discovery Tool

The Dashboard Device Discovery tool allows you to set the method to be used to detect the Vertigo devices that are local to your machine or on your network. Once the devices are located, Dashboard lists them on the [Device List](#), which allows you to view and edit the device's settings.

The Device Discovery tool is accessed by selecting Dashboard's **TOOLS > SETTINGS > DEVICE DISCOVERY** menu command (figure 5-4).

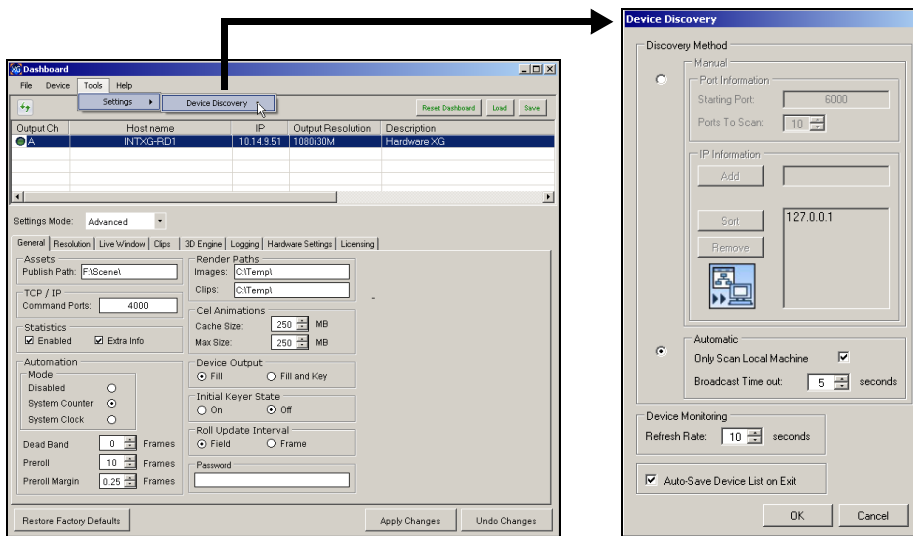

Figure 5-4. Launching the Device Discovery Tool

One of the first things that Dashboard does on start up is use the Device Discovery tool to perform a device discovery. A device discovery performs a search of your local machine and/or your network for all of the active Vertigo devices that are able to connect to Dashboard and then lists them on Dashboard's [Device List](#). Selecting a device from the Device List displays the Device Profile page or the Device configuration pages depending upon the Settings Mode.

The following table provides a description for each of the fields on the Device Discovery dialog box and the topics listed below describe the tasks that two methods that you can use to perform the device discovery.

- [“Performing a Manual Device Discovery” on page 5-13](#)
- [“Performing an Automatic Device Discovery” on page 5-14](#)

<p>MANUAL</p>	<p>PORT INFORMATION</p> <ul style="list-style-type: none"> • STARTING PORT: Specifies the port number to use as the starting point for searching for devices. • PORTS TO SCAN: Specifies the number of ports to scan starting at the port number specified in the Starting Port. <p>IP INFORMATION</p> <p>Displays a list of IP addresses to scan to detect Vertigo devices. The IP address is that of the machine that the device is running on. You can get this IP address either by typing <code>IPConfig</code> on the command prompt, or by using the IP address listed on the Vertigo device's software's dialog box.</p> <ul style="list-style-type: none"> • ADD: Enter a specific IP address that you suspect the device to be using. • SORT: Arranges the IP addresses added to the IP information list in descending numerical order. • REMOVE: Removes the selected IP address from the IP Information list.
<p>AUTOMATIC</p>	<p>The device discovery's automatic mode performs a thorough search for all of the Vertigo devices on your local machine or on your network.</p> <ul style="list-style-type: none"> • ONLY SCAN LOCAL MACHINE: Rather than searching for all of the Vertigo devices on your network, this setting limits the search to finding all the Vertigo devices connected/on your local machine. • TIME OUT: Sets a time limit at which to stop the search for devices. The default value is 5 seconds.
<p>DEVICE MONITORING</p>	<p>REFRESH RATE: Sets the frequency (in seconds) at which to poll the devices to see if they are active or inactive. The default value is 10 seconds. See "Monitoring the status of a device" on page 5-10 for more information.</p>
<p>SAVE DEVICE LIST ON EXIT</p>	<p>The Save Device List on Exit automatically saves the device list when you exit Dashboard. By default this parameter is not enabled. See "Saving the device list" on page 5-9 for more information.</p>

Performing a Manual Device Discovery

The Device Discovery's manual mode allows you to focus your device search by limiting the search to particular port and IP limits. The search begins scanning for devices from the port number specified and then each sequential port up as specified by the Ports to Scan value.

It is recommended that you use the manual method if you are wanting to configure a particular Vertigo device and you know roughly, or even exactly, where the device is located on the network using its port and IP address information.

To perform a manual device discovery:

1. Open the Device Discovery tool by selecting **TOOLS > SETTINGS > DEVICE DISCOVERY**.
2. Set the **DEVICE DISCOVERY METHOD** in the device discovery tool.
 - a. Select the **MANUAL** Discovery Method.
 - b. Set the **STARTING PORT** parameter by typing in the port number that you suspect the device to be using for the Vertigo device.
 - c. Set the **PORTS TO SCAN** parameter.
 - d. Verify that the appropriate IP address appears in the IP Information list (see [IP INFORMATION](#) in the table above).

If the desired IP address does not exist, type the IP address digits in the **ADD** text box and click the **ADD** button. Be sure to pay close attention to the dot separators when typing the IP Address.

- e. Click **OK**.
3. Start the device discovery process by clicking the **REFRESH** button . Dashboard will start scanning the specified IP addresses and ports for any available Vertigo devices. Dashboard then automatically updates the Device List.

Output Ch	Host name	IP	Output Resolution	Description
A	CA-VXM-XGRD3	10.14.3.47	1080i30M	Hardware XG
B	CA-VXM-XGRD3	10.14.3.47	NTSC	Hardware XG
SWCG	CA-VXM-XGRD3	10.14.3.47	NTSC	Software CG

Performing an Automatic Device Discovery

The automatic method of performing a device discovery provides you with the options of scanning only your local machine for an active Vertigo device, or to scan the network within a specified time out period.

To perform an automatic device discovery:

1. Open the Device Discovery tool.

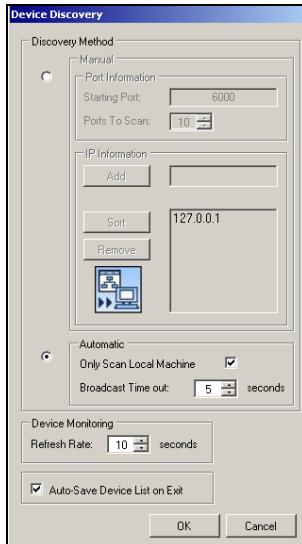

TOOLS > SETTINGS > DEVICE DISCOVERY



2. Set the Device Discovery method in the device discovery tool.
 - a. Select the **AUTOMATIC** Discovery Method.
 - b. Disable the **ONLY SCAN LOCAL MACHINE** parameter.
 - c. Click **OK**.

3. Refresh the Device List by clicking the **REFRESH** button .

Dashboard will start scanning the network and the local machine for any available Vertigo devices. Dashboard then automatically updates the Device List. Select the desired device from the Device List. If the desired device has a green light in the Output Channel column, continue to the next phase in the configuration procedure.

Output Ch	Host name	IP	Output Resolution	Description
 A	CA-VXM-XGRD3	10.14.3.47	1080i30M	Hardware XG
 B	CA-VXM-XGRD3	10.14.3.47	NTSC	Hardware XG
 SWCG	CA-VXM-XGRD3	10.14.3.47	NTSC	Software CG

If, however, the desired device is still not listed on the Device List, or if the device is listed, but has a red light in the Output Channel column, you will have to verify the status of the device (on/off), as well as the status of the network.

Device Profile page

The Device Profile page appears below Dashboard's Device List when the **SETTINGS MODE** is set to **SIMPLE** and a device is selected from the Device List (figure 5-5). The Device Profile page provides a brief summary of some of the device and system's settings that may be relevant when operating or troubleshooting the system.

Figure 5-5. Dashboard's Device Profile page

The following table describes each of the fields that are displayed on the Device Profile page for Vertigo devices:

GENERAL	<ul style="list-style-type: none"> • DEVICE NAME: The name given by the last connecting application. Such as Xplay or Xstudio. • DEVICE TYPE: Displays the Vertigo device type, either HARDWARE XG or SOFTWARE CG.
VERSION	<ul style="list-style-type: none"> • APPLICATION VERSION: Displays the software version of Vertigo device. • DSX.UTILS VERSION: Displays the version of the driver used inside the Vertigo device.
GRAPHICS	<ul style="list-style-type: none"> • CARD TYPE: Identifies the type of graphics card used by the Vertigo device. This information is useful when troubleshooting the Vertigo device as some functionality might depend upon the type of graphics card used. • MEMORY USE: Displays the total amount of memory being used by the graphics card, including host and onboard.
PORTS	<ul style="list-style-type: none"> • APPLICATION PORT: Displays the communication port used between the Dashboard application and the selected Vertigo device. • COMMAND PORT: The communications port used by the Vertigo device for command and control by applications, such as Xstudio or Xplay. To edit this setting, select the Display Settings Tab and edit the COMMAND PORT field.

<p>OUTPUT</p>	<ul style="list-style-type: none"> • RESOLUTION: Allows you to set the resolution format that is used for processing within the Vertigo device. You can set the output Resolution either in this field or in the OUTPUTS RESOLUTION field on the ADVANCED>RESOLUTION PAGE (page 5-21). • CHANNEL: Specifies the output channel used by the Vertigo device. The available output channels are determined by the installed hardware. You can set the Output Channel either in this field or in the OUTPUTS CHANNELS field on the HARDWARE SETTINGS>VIDEO PAGE (page 5-34).
<p>MODE</p>	<p>The Mode setting specifies the processing mode of the Vertigo device.</p> <ul style="list-style-type: none"> • UPSTREAM: When UpStream mode is enabled, the device is configured as follows: <ol style="list-style-type: none"> 1. There is no video input. 2. The device outputs both a fill and key signal. 3. The Watch Dog is enabled. 4. The Watch Dog key signal is transparent. • DOWNSTREAM: When in Downstream mode is enabled, the device is configured as follows: <ol style="list-style-type: none"> 1. The device processes video input and the input channel matches the output channel. 2. The device outputs only a fill signal. 3. The Watch Dog is enabled. 4. The Watch Dog key signal is transparent. • ADVANCED: When this read-only field is enabled, it indicates that the device has been configured through the Advanced setting mode so that its settings do not match the Upstream or Downstream settings.
<p>GENLOCK</p>	<p>This setting controls the sync of the Vertigo device. It is a simplified view of the ADVANCE>HARDWARE SETTINGS>GENLOCK PAGE.</p> <ul style="list-style-type: none"> • SOURCE: Specifies the source of the Genlock signal. Choose from the following settings: INTERNAL, BLACKBURST, VIDEOIN A, or VIDEOIN B (assuming the hardware contains inputs). • RESOLUTION: Specifies the resolution of the Genlock signal. The Resolution can also be set on the HARDWARE SETTINGS>GENLOCK page (page 5-11). • STATUS: Reports the status of the Genlock signal (i.e. the Intuition XG has locked onto the signal). The Status can also be set on the HARDWARE SETTINGS>GENLOCK page (page 5-11).

Device Settings tabs and configuration pages

Selecting **ADVANCED** from the **SETTINGS MODE** drop-down list produces a series of eight (8) tabs that display thematic pages of parameters and settings that allow you to configure the selected device (figure [5-6](#)).

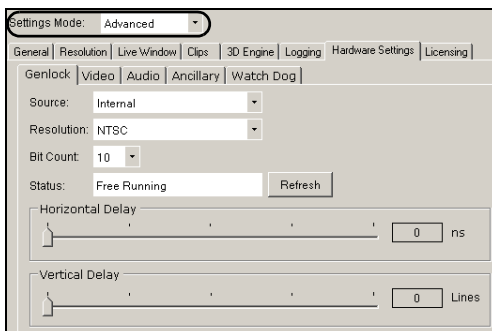

Figure 5-6. Selecting the Advanced Settings Mode exposes the device's configuration pages

✓ NOTE

The seventh page is dynamic, meaning that when the selected device is a hardware XG, the seventh tab is labelled **HARDWARE SETTINGS**; however when the selected device is a software CG the seventh tab is labelled **AUDIO & VIDEO**.

The following topics describes each of the parameters and settings on the device's configuration pages:

- [“Device settings buttons” on page 5-18](#)
- [“General page” on page 5-19](#)
- [“Resolution page” on page 5-21](#)
- [“Live Window page” on page 5-23](#)
- [“Clips page” on page 5-25](#)
- [“3D Engine page” on page 5-27](#)
- [“Logging page” on page 5-29](#)
- [“Hardware Settings > Genlock page” on page 5-31](#)
- [“Hardware Settings > Video page” on page 5-34](#)
- [“Hardware Settings > Audio page” on page 5-36](#)
- [“Hardware Settings > Ancillary page” on page 5-38](#)
- [“Hardware Settings > Watch Dog page” on page 5-41](#)
- [“Licensing page” on page 5-42](#)

Device settings buttons

When Dashboard is in **ADVANCED** Settings Mode, selecting the tabs exposes the device's configuration pages, which allows you to edit the device's current settings. Once you have made the desired changes to the settings, you must apply the changes to the device by selecting the **APPLY CHANGES** button. Note that for some changes to take effect, Dashboard will request that the device be restarted (see **RESTART DEVICE** on [page 5-6](#)).

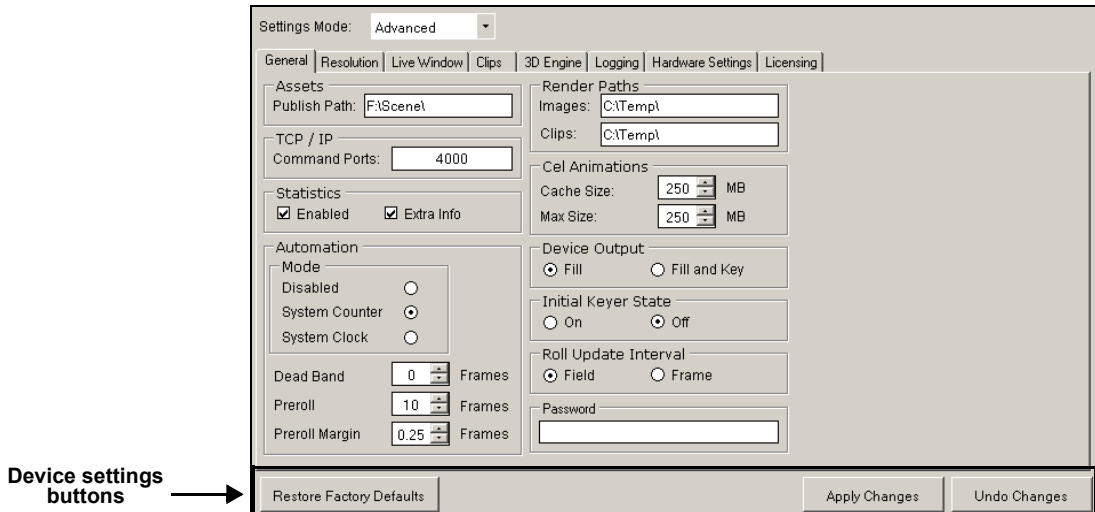

Figure 5-7. Device Settings buttons

You can retract the changes that you make to the device settings by performing an **UNDO**, as long as you haven't already applied the changes. If you have made unwanted changes, you can revert to the device's default settings by pressing the **RESTORE FACTORY DEFAULTS** button.

The following table summarizes the function of the three (3) buttons in the lower portion of Dashboard's device configuration pages.

RESTORE FACTORY DEFAULTS	Resets all of the parameter settings to Dashboard default settings.
APPLY CHANGES	Applies all of the new settings from the page to the selected device.
UNDO CHANGES	Reinstates the page's device settings back to what they were at the last APPLY CHANGES action.

General page

Selecting the **GENERAL** tab in Advanced Settings mode, opens the General settings page (figure 5-8). This configuration page provides you access to a series of miscellaneous device parameters, including storage settings and communication settings between the Vertigo devices, Xplay, and/or the broadcast monitor.

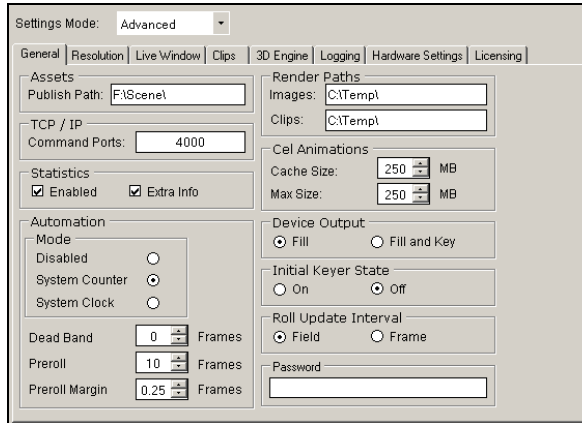

Figure 5-8. The General settings tab and page on the Dashboard Window

<p>ASSETS</p>	<p>PUBLISH PATH: Identifies the directory location where assets are stored on the Vertigo device, or on the host computer (software CG). The default directory paths for the Vertigo hardware devices is <code>F:\Scene\</code>, while the default directory path for the Vertigo Software CG is <code>C:\Scene\</code>.</p> <p>Assets are automatically placed within appropriate subfolders by the publish agent. For example, images are stored in the Image subfolder.</p>
<p>TCP/IP</p>	<p>COMMAND PORTS: Sets the communications port used by the Vertigo devices and Vertigo software CG for command and control between applications (i.e. Intuition XG and Xplay). This port must be open and 2-way unblocked on the Vertigo device's subnet.</p>
<p>STATISTICS</p>	<p>ENABLED: Displays the frame rate, video card, and memory use on the output display for debugging purposes.</p> <p>EXTRA INFO: Displays timing information (Dx9, DSX, Readback) on the Intuition XG's output display for debugging purposes. Timing values are displayed in milliseconds for each thread</p>

<p>AUTOMATION</p>	<p>MODE: Determines the timestamping mechanism used for commands between the Vertigo devices and Xplay.</p> <ul style="list-style-type: none"> • DISABLED: When selected the timestamp of the command will be ignored and the command is executed immediately. • SYSTEM COUNTER: High performance counter issued to reference the time of the command. • SYSTEM CLOCK: Sets the format of the timestamps, which is timecode-based (Hour: Minute: Seconds: Frames). <p>DEAD BAND: Sets the dead band zone for the time stamping of commands. If the difference in timestamps between multiple commands is less than the dead band, the earlier timestamp will be use for all commands.</p> <p>PREROLL: Sets the preroll time by which all timestamps are adjusted. The default value for this setting is 10 frames.</p> <p>PREROLL MARGIN: When the Vertigo devices receive automation commands, they are usually timestamped. The devices add the preroll time as an offset to these timestamps. The preroll margins is an additional offset added. The preroll setting is an integer allowing only whole frames. The preroll margin allows fractional values. The default value for this setting is 0.25 frames.</p>
<p>RENDER PATHS</p>	<p>IMAGES: Specifies the directory path of where the image file will be saved to when the SNAPSHOT command is used in Xbuilder.</p> <p>CLIPS: Specifies the directory path of where the image file will be saved to when the RENDER TO DISK command is used in Xbuilder.</p>
<p>CEL ANIMATIONS</p>	<p>CACHE SIZE: Sets the number of cel animations that are cached in system memory after they are no longer referenced by a loaded scene. The default is 250. Increasing the cache size setting will unnecessarily slow down performance and occupy memory space.</p> <p>MAX SIZE: Specifies the maximum size of a cel animation that Intuition XG will accept. Cel animations that are larger are rejected. The default is 250 MB.</p>
<p>DEVICE OUTPUT</p>	<p>FILL: Only the fill signal will be transmitted to the output monitor.</p> <p>FILL AND KEY: The fill and key signals will be transmitted to the output monitor/device. This setting is the default for Intuition XG devices.</p>
<p>INITIAL KEYER STATE</p>	<p>Sets the initial state of the Vertigo device's internal virtual keyer list.</p> <p>ON: Sets the Vertigo device's keyer to an active state. This is the default setting.</p> <p>OFF: Sets the Vertigo device's keyer to an inactive state.</p>
<p>ROLL UPDATE INTERVAL</p>	<p>Determines if the vertical movement interval of a crawl is based on a FIELD or FRAME.</p>
<p>PASSWORD</p>	<p>A simple security feature that allows you to set a password so that other users cannot change the device settings.</p>

Resolution page

The Resolution page (figure 5-9) provides access to the device parameters that set the input, rendering, and output resolution of the video data.

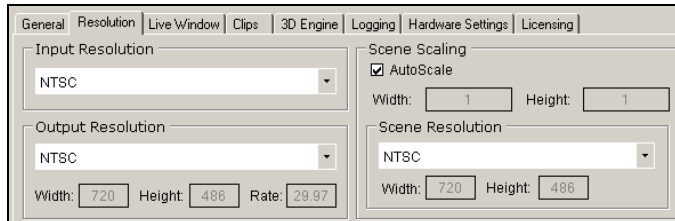

Figure 5-9. The Resolution tab and page on the Dashboard window

INPUT RESOLUTION

This parameter is only available to Vertigo hardware devices (not the software CG).

The Input Resolution parameter allows you to select the input resolution of the video data prior to processing by Vertigo device. Select a resolution format from the drop-down list of preset formats that are compatible with the rendering resolution.

- **NTSC**: Sets the rendering resolution to NTSC format (720 x 486) Rate: 29.97
- **NTSC_WIDE**: Sets the rendering resolution to NTSC-Wide format (800 x 486) Rate: 29.97
- **PAL**: Sets the rendering resolution to PAL format (720 x 576) Rate: 25
- **PAL_WIDE**: Sets the rendering resolution to PAL-Wide format (800 x 576) Rate: 25
- **720P60**: Sets the rendering resolution to 720p60 format (1280 x 720) Rate: 60
- **720P60M**: Sets the rendering resolution to 720p60M format (1280 x 720) Rate: 59.97
- **1080i25**: Sets the rendering resolution to 1080i25 format (1920 x 1080) Rate: 25
- **1080i30M**: Sets the rendering resolution to 1080i30M format (1920 x 1080) Rate: 29.97
- **1080i30**: Sets the rendering resolution to 1080i30 format (1920 x 1080) Rate: 30
- **1080i24M**: Sets the rendering resolution to 1080i24M format (1920 x 1080) Rate: 23.98

<p>INPUT RESOLUTION - CONTINUED</p>	<ul style="list-style-type: none"> • 1080P24: Sets the rendering resolution to 1080p24 format (1920 x 1080) Rate: 24 • 1080P25: Sets the rendering resolution to 1080p25 format (1920 x 1080) Rate: 25 • 1080P30M: Sets the rendering resolution to 1080p30m format (1920 x 1080) Rate: 29.97 • 1080P30: Sets the rendering resolution to 1080p30 format (1920 x 1080) Rate: 30 • CUSTOM: Sets the rendering resolution to the resolution values set in the rendering resolution width, height, and rate fields. This setting is only available to Software CG devices.
<p>OUTPUT RESOLUTION</p>	<p>The Output Resolution parameter allows you to specify the output resolution of the Vertigo devices.</p> <p>WIDTH, HEIGHT, & RATE: Displays the width (horizontal lines), height (vertical lines), and frame rate of the output resolution selected. These fields are read-only, except when CUSTOM is selected as the Output Resolution. Note, however, that the Custom setting is only available to Software CG devices. The width, height, and rate rendering values for Intuition XG devices are determined by the resolution format selected.</p>
<p>SCENE SCALING</p>	<p>This allows the Vertigo devices to account for the fact that sometime the resolution of the scene being rendered does not match the resolution that the device is rendering at.</p> <p>AUTOSCALE: Specifies if the scale is automatically calculated by comparing the scene resolution with the output resolution or if the user can manually enter scaling values.</p> <p>WIDTH & HEIGHT: Displays the scaling factor that will be applied to width and height of the scene during rendering.</p> <p>SCENE RESOLUTION: Specifies the resolution of the scenes to be loaded.</p> <p>WIDTH & HEIGHT: Show the width and height of the scene resolution selected. If the resolution is set to CUSTOM, then the width and height can be entered manually.</p>

Live Window page

In addition to the output display, the Live Window page provides you with parameters for enabling an additional display of a window on the computer monitor (Live Window) that shows the output of the Vertigo device.

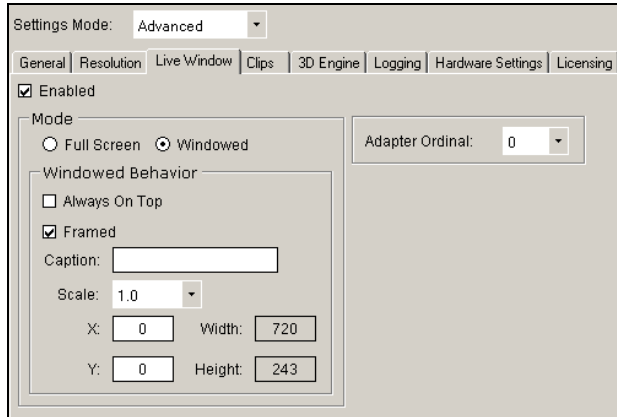

Figure 5-10. The Live Window tab and page on the Dashboard window

ENABLED	Enables the display of the Live Window. In the case of the Vertigo CG, the Live Window is the only method of seeing the output.
MODE	<p>Selecting ENABLED, activates the following parameters allowing you to set the size and positioning of the Live Window.</p> <p>FULL SCREEN: Sets the Live Window to occupy the entire display area, and therefore, replaces the output display.</p> <p>WINDOWED: Sets the Live Window to display in a separate window. Selecting this setting activates the Window Behavior parameters that allow you to set the positioning and size of the Live Window.</p>

<p>Mode - continued</p>	<p>WINDOW BEHAVIOR: The following parameters are activated when Windowed is selected, and they allow you to set the positioning and size of the Live Window.</p> <ul style="list-style-type: none"> • ALWAYS ON TOP: Specifies whether the Live Windows is always the top window. • FRAMED: Enables a frame around the Live Window. • CAPTION: Allows the override of the default Live Window caption (title). • SCALE: Specifies a scaling factor for the width and height of the live window. Choose from 1.0, 0.5, or 0.25 values. • X: Specifies the vertical screen coordinate of the top left corner of the Live Window. A value of zero (0) locates the window in the upper-most corner of the screen. • Y: Specifies the horizontal screen coordinate of the top left corner of the Live Window. A value of zero (0) locates the window in the left-most corner of the screen. • WIDTH & HEIGHT: Displays the size of the Live Window by setting the vertical and horizontal dimensions in pixels. These are read-only fields and match the values specified by the Output Resolution field on the Resolution page.
<p>ADAPTER ORDINAL</p>	<p>Specifies which VGA display adapter to use for rendering. Note that displaying the Live Window on the incorrect VGA display will unnecessarily increase CPU usage.</p>

Clips page

The parameters on the Clips page allow you to set clip rendering characteristics.

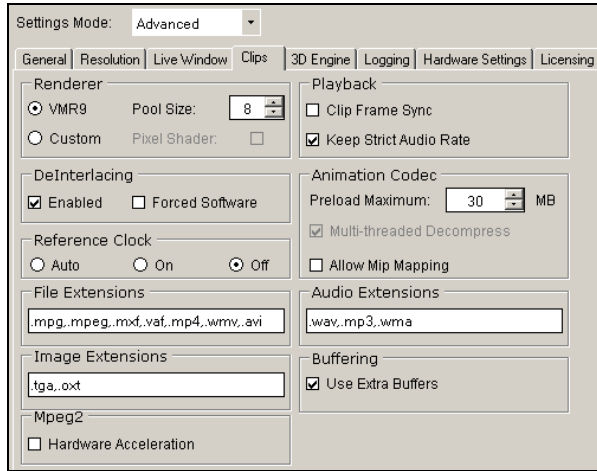

Figure 5-11. The Clips tab and page on the Dashboard window

RENDERER	<p>The following fields specifies which renderer will be used to produce and insert the graphics and video clips for output.</p> <p>VMR9: Specifies that the VMR9 (Video Mixing Renderer 9) will be used for clip playback. This is the default renderer.</p> <p>POOL SIZE: Only available when VMR9 is selected as the renderer. Pool Size specifies the number of VMR9s that are preallocated at the start up of the application. The default value of -1 disables the preallocation.</p> <p>CUSTOM: Specifies that the Vertigo hardware device's own video renderer will be used for clip playback.</p> <p>PIXEL SHADER: Only available when CUSTOM is selected as the renderer. Selecting Pixel Shader allows pixel color conversion to be done on the Vertigo device's GPU. When Pixel Shader is not selected, pixel color conversion is performed on the host computer.</p>
DEINTERLACING	<p>The renderers processing format is interlaced, but all of the other functions are performed in progressive.</p> <p>ENABLED: The Vertigo device will deinterlace clips using the best method available. This is the default setting.</p> <p>FORCED SOFTWARE: The Vertigo device will use the Vertigo's own deinterlacing algorithm.</p>

REFERENCE CLOCK	<p>AUTO: Specifies that the clip rendering will be clocked.</p> <p>ON: Specifies that the clock will always be used in clip rendering.</p> <p>OFF: Specifies that the clock will not be used in clip rendering.</p>
FILE EXTENSIONS	<p>Specifies the extensions of video file formats that are supported. Although the more commonly used formats are already listed in this field, you can also add additional format extensions to the list.</p>
IMAGE EXTENSIONS	<p>Specifies the extensions of image file formats that are supported. Although the more commonly used formats are already listed in this field, you can also add additional format extensions to the list.</p>
MPEG2	<p>HARDWARE ACCELERATION: When selected, Mpeg-2 decoding is performed using the Vertigo device's GPU. When this parameter is not selected, Mpeg-2 decoding is performed by the CPU. This parameter is selected in its default state.</p>
PLAYBACK	<p>The following parameters are only displayed on the Clips page when a Vertigo device is selected in the device list.</p> <p>CLIP FRAME SYNCH: Forces clips to remain synchronized with the start of frames.</p> <p>KEEP STRICT AUDIO RATE: Only allows 48 kHz audio to be used in clip playback.</p>
ANIMATION CODEC	<p>PRELOAD MAXIMUM: Specifies the maximum size (MB) of a file that will be preloaded into system memory. All files smaller will be loaded into system memory for playback and all files larger will be streamed off disk. The valid range is 50 to 500.</p> <p>MULTI-THREADED DECOMPRESSION: Determines if the decompression of the Vertigo animation clips is multi-threaded or single-threaded.</p> <p>ALLOW MIP MAPPING: When enabled, the Vertigo XG device performs mip mapping when rendering animation (VAF) files.</p>
AUDIO EXTENSIONS	<p>Specifies the extensions of audio formats that are supported. Although the more commonly used formats are already listed in this field, you can also add additional audio format extensions to the list. Please read “The Intuition XG provides advanced branding capabilities to master control switchers” on page 1-7 before editing the list.</p>
BUFFERING	<p>USE EXTRA BUFFERS: When selected, extra buffers are used between the clip engine and the rendering engine (output engine). This parameter is selected in its default state.</p>

3D Engine page

The 3D Engine page provides access to parameters that allow you to set some parameters that affect the way in which 3D graphics are rendered and output by the Vertigo hardware devices. The following table describes each of the parameters on the 3D Engine page.

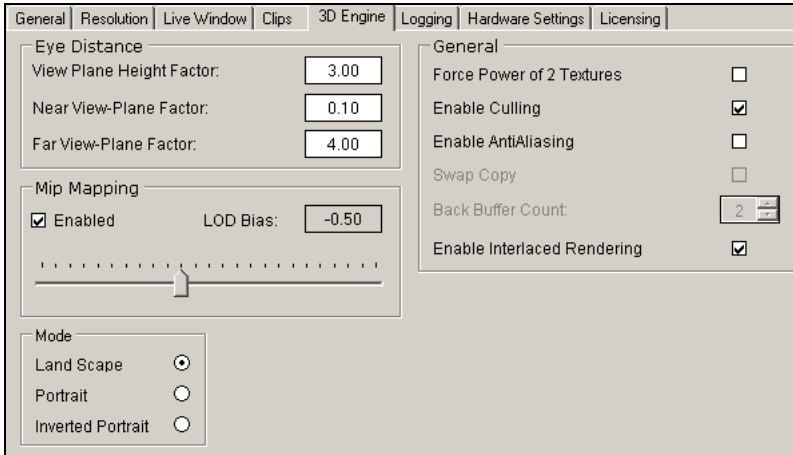

Figure 5-12. The 3D Engine tab and page on the Dashboard window

<p>EYE DISTANCE</p>	<p>The Eye Distance parameters set the three dimensional positioning by defining the spatial perspective/location of how far the object is from the camera (close, far).</p> <p>VIEW PLANE HEIGHT FACTOR: Sets the field of view of the camera.</p> <p>NEAR VIEW-PLANE FACTOR: Sets the distance from the camera in world space units. Anything closer to the camera will be clipped.</p> <p>FAR VIEW-PLANE FACTOR: Sets the distance from the camera in world space units. Anything farther from the camera will be clipped.</p>
<p>MIP MAPPING</p>	<p>Mip mapping allows for a higher level of layering detail by internally creating collections of bitmap images to accompany a main texture. This is intended to increase rendering speed of 3D graphics, and improves the digital video effects (DVE) quality.</p> <p>ENABLED: When selected, the Vertigo hardware device performs mip mapping when rendering 3D graphics.</p> <p>LOAD BIAS: When Enabled is selected for Mip Mapping, the Load Bias parameter allows you to set the level of detail bias for mipmapping by adjusting the slider between -3 and +3. Values below 0 result in less blurred mip-level choice. The default value is -0.50.</p>

<p>MODE</p>	<ul style="list-style-type: none"> • LAND SCAPE: The default orientation of the Vertigo device's output. • PORTRAIT: Rotates the Vertigo device's entire output by 90 degrees clockwise. • INVERTED PORTRAIT: Rotates the Vertigo device's entire output by 90 degrees counter-clockwise.
<p>GENERAL</p>	<p>FORCE POWER OF 2 TEXTURES: Textures are typically square and must have side lengths equal to a power of 2. Some graphics cards do not adequately support non-power of two textures, so you can select this parameter to force the textures to conform to the power of 2 requirement.</p> <p>ENABLE CULLING: Prevents elements of 3D graphics that are non-visible from the rendering process, thereby making the rendering process more efficient.</p> <p>ENABLE ANTIALIASING: Enables antialiasing rendering in 3D. Reduces 3D edge artifacts.</p> <p>SWAP COPY: This parameter is only available to the Vertigo software CG and only when the Live Window is full screen. Swap Copy makes overlay graphics slower by allowing buffer swaps to be performed as a copy from back to front, rather than having the back and front exchanged. These conditions allow some video cards to perform better. This parameter is not selected by default.</p> <p>BACK BUFFER COUNT: This parameter is only available to the Vertigo software CG and it is used with the Swap Copy parameter. This parameter specifies the number of back buffers to use in the Swap Copy. The default is set to 2.</p> <p>ENABLE INTERLACED RENDERING: Determines if the window is the height of a field or the height of a frame (unchecked). This setting has no effect if the output resolution is progressive, since there are only frame, no fields, in progressive.</p>

Logging page

The logging page allows you to set parameters to create log files that record the status of events while the Vertigo devices are running. The log files can then be use to investigate device behavior and debug.

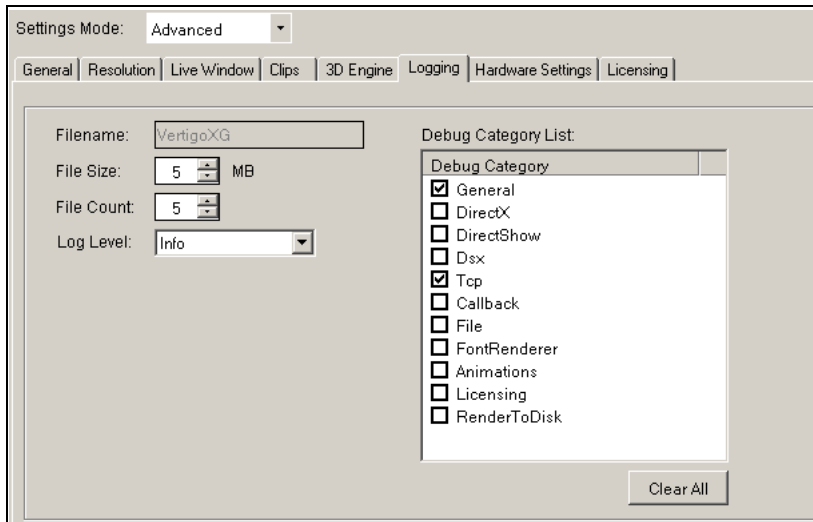

Figure 5-13. The Logging tab and page on the Dashboard window

FILENAME	The name of the log file. The name cannot be changed, however, if multiple log files are created, then an underscore, date, and time are appended to the file name. The default name is "VertigoXG".
FILE SIZE	Sets the maximum memory size for each log file created per run. The default value is 6 MB.
FILE COUNT	Sets the maximum number of log files to be created per run. The default value is 20.
LOG LEVEL	<p>Sets the severity categories that will be reported to the log file.</p> <ul style="list-style-type: none"> • ERROR: An error of some type has occurred and this log category will likely indicate the source of a problem. • WARN: Be aware that something unexpected has happened, like unsuccessful operations that may indicate a problem. • INFO: Logs important events that occur during normal conditions, which allows you to trace what and when the applications are doing.

DEBUG CATEGORY LIST	<p>Sets the categories that will be reported to the log file.</p> <ul style="list-style-type: none">• GENERAL: General information.• DIRECT X: Information pertaining Direct and 3D rendering.• DIRECT SHOW: Information about Direct Show, which is used to play clips and audio files.• DSX: Information about the video I/O device.• TCP: Information about network communication.• CALLBACK: Information about callback replies sent to applications, like Xplay or Xstudio.• FILE: Information about attempts to access files on the disk.• FONTRENDERER: Information about text rendering.• ANIMATIONS: Information about animations.• LICENSING: Information about licensing.• RENDERTODISK: Information about the Render to Disk functionality. <p>CLEAR ALL button: Allows you to quickly de-select all of the selected debug categories.</p>
----------------------------	--

Hardware Settings > Genlock page

The Genlock page is a sub-page of the Hardware Settings tab, which is only visible when a Vertigo hardware device is selected in the Dashboard's device list. The Genlock page (figure 5-14) exposes parameters that allow you to set the Vertigo device's genlock reference signal that synchronizes the phase timing eliminating video jitter.

The source of the Vertigo device's genlock reference signal can be set to come from one of four sources: internal, blackburst, SDI Video In A, or SDI Video In B.

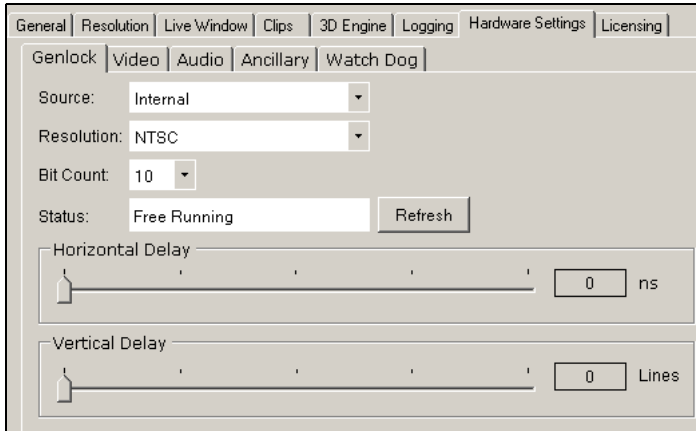

Figure 5-14. The Genlock Page within Dashboard's Hardware Settings

<p>SOURCE</p>	<p>The source of the Vertigo device's genlock reference signal can come from one of four sources:</p> <ul style="list-style-type: none"> • INTERNAL: Genlock to the video card, which generates its own synchronization clock • BLACKBURST: The blackburst signal contains the vertical, horizontal, frame, color synchronization, and field 1 reference, without any video data. • SDI VIDEO A: The SDI video A input signal inherently carries a reference signal and therefore it can be used as a genlock signal. • SDI VIDEO B: The SDI video B input signal inherently carries a reference signal and therefore it can be used as a genlock signal.
<p>RESOLUTION</p>	<p>Specifies the resolution of the genlock signal. In cases where two instances of the Vertigo devices are running simultaneously with different resolutions, both instances should specify the lower resolution for genlock.</p> <p>Select one of the following resolution formats from the drop-down list:</p> <ul style="list-style-type: none"> • NTSC: Sets the rendering resolution to NTSC format (720 x 486)

<p>RESOLUTION - CONTINUED</p>	<ul style="list-style-type: none"> • NTSC_WIDE: Sets the rendering resolution to NTSC-Wide format (800 x 486) • PAL: Sets the rendering resolution to PAL format (720 x 576) • PAL_WIDE: Sets the rendering resolution to PAL-Wide format (800 x 576) • 720P60: Sets the rendering resolution to 720p60 format (1280 x 720) • 720P60M: Sets the rendering resolution to 720p60M format (1280 x 720) • 1080i25: Sets the rendering resolution to 1080i25 format (1920 x 1080) • 1080i30M: Sets the rendering resolution to 1080i30M format (1920 x 1080) • 1080i30: Sets the rendering resolution to 1080i30 format (1920 x 1080) • 1080i24M: Sets the rendering resolution to 1080i24m format (1920 x 1080) • 1080P24: Sets the rendering resolution to 1080p24 format (1920 x 1080) • 1080P25: Sets the rendering resolution to 1080p25 format (1920 x 1080) • 1080P30M: Sets the rendering resolution to 1080p30m format (1920 x 1080) • 1080P30: Sets the rendering resolution to 1080p30 format (1920 x 1080)
<p>BIT COUNT</p>	<p>Specifies the bit depth of the genlock signal. Choose either 8 (default) or 10 from the drop-down list.</p>
<p>STATUS & REFRESH button</p>	<p>Identifies the current state of the Genlock signal source that is selected in the SOURCE parameter.</p> <ul style="list-style-type: none"> • LOCKED: The connection is established and the on-board Genlock is sending a clocking signal to the Genlock source specified in the Source parameter. • FREE RUNNING: No signal is coming in on the selected Genlock source, or the specified signal formats are not the same. For example, if the resolution setting on the Genlock page does not match the resolution formats specified on the Resolution page. • RELOCKING: In the process of locking. Note that if continuously in this state, the Genlock signal might not be stable and it needs to be checked.

STATUS & REFRESH button - Continued	<ul style="list-style-type: none">• UNKNOWN (UPDATE THE XG SOFTWARE): This message appears when the version of the Vertigo software that is being used is an earlier version and does not support this feature. If this is the case, you need to update the Vertigo software. <p>Click the REFRESH button to request an update of the Genlock status of the source. Each time you select a new Genlock Source setting and apply the change, the status message will be gray until you click the Refresh button to update the status.</p>
HORIZONTAL DELAY	Adjusts the horizontal timing of the signal in nanoseconds.
VERTICAL DELAY	Adjusts the vertical timing of the signal in lines.

Hardware Settings > Video page

The Video page is a sub-page of the Hardware Settings tab, which is only visible when a Vertigo hardware device is selected in the Dashboard's device list. The Video page (figure 5-15) exposes parameters that allow you to set the Vertigo device's video input/output channels and video processing options.

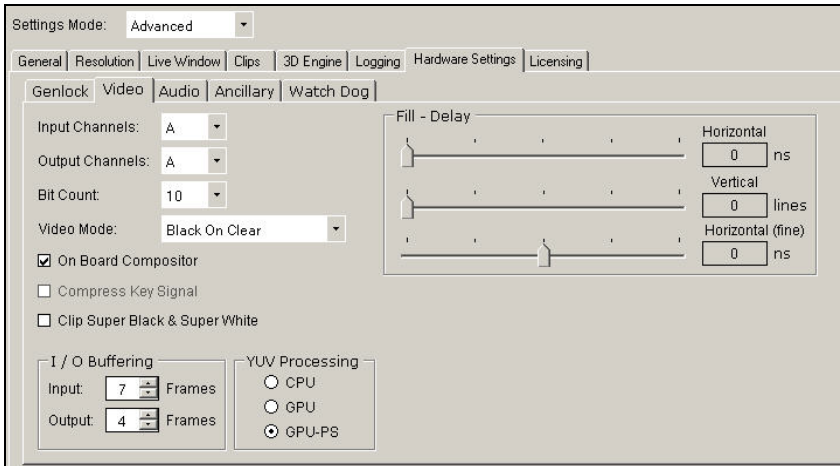

Figure 5-15. The Video page within Dashboard's Hardware Settings

<p>INPUT CHANNELS</p>	<p>Specifies the input channel of the hardware to use. Depending on the hardware configuration of the machine, the possible values are blank, A, or B.</p> <p>When running a single instance of the Vertigo device, both sources can be used. But when running two instances of the device simultaneously, they must each use a different input channel. In the case where there are more instances running than input channels, some will have to leave the setting blank.</p>
<p>OUTPUT CHANNELS</p>	<p>Specifies the output channel of the hardware to use. Depending on the hardware configuration of the machine, the possible values are A, B, C, or D. When running multiple instances of the Vertigo device simultaneously, each instance must specify a different output channel. This parameter can also be set using the Output Channel field on the Device Profile page (page 5-15).</p>
<p>BIT COUNT</p>	<p>Specifies the bit depth of the signal. Choose either 8 or 10 (default) from the drop-down list.</p>

VIDEO MODE	<p>Specifies how the Vertigo hardware device passes through video.</p> <ul style="list-style-type: none"> • BACKGROUND VIDEO ON: The Vertigo device will always display the video input as the back most layer, even without any scene loaded. • VIDEO ON CLEAR: When the Vertigo device has nothing to render (no scenes have been loaded), it will display the video input. • BLACK ON CLEAR: When the Vertigo device has nothing to render (no scenes have been loaded), it will render nothing, displaying black.
ON BOARD COMPOSITOR	<p>Allows the off loading of certain color conversion routines from the CPU to the video card. This feature is dependant on the correct firmware options being installed on the hardware.</p>
COMPRESS KEY SIGNAL	<p>When this setting is enabled, the key signal color space is compressed so it does not fall into super black or super white. The full 10-bit color space is from 0 – 1023. The key signal is compressed into the range 64 – 940. Above 940 is super white and below 64 is super black.</p>
CLIP SUPER BLACK & SUPER WHITE	<p>Determines whether or not the VertigoXG allows the output to be in the super black & super white range. The luminance range of a 10-bit SDI signal is from 0 to 1023. A value below 64 is considered super black and a value above 940 is considered super white. When this setting is enabled, the VertigoXG will clip any pixels below 64 up to 64 and any pixels above 940 down to 940.</p>
I/O BUFFERING	<p>Together these I/O buffering values determine the video delay of the passthrough.</p> <ul style="list-style-type: none"> • INPUT: The number of buffered (frames) used for video input. • OUTPUT: The number of buffers (fields) used for video output.
YUV PROCESSING	<p>Specifies if color conversion of video input is off-loaded from the CPU to the GPU.</p> <ul style="list-style-type: none"> • CPU: Use the CPU to do the conversion. • GPU: Use the GPU to do the conversion. The GPU is not recommended, however, for HD video. • GPU-PS: Uses the pixel shader to do YUV to RGB conversion.
FILL DELAY	<ul style="list-style-type: none"> • HORIZONTAL: The slider adjusts the horizontal (nanoseconds) timing of the fill signal. • VERTICAL: The slider adjusts the vertical (lines) timing of the fill signal. • HORIZONTAL (FINE): The slider offers you a finer (smaller increments) control of the horizontal timing delay of the Fill signal.

Hardware Settings > Audio page

The Audio page is a sub-page of the Hardware Settings tab, which is only visible when a Vertigo hardware device is selected in the Dashboard's device list. The Audio page (figure 5-16) exposes parameters that allow you to set the Vertigo device's audio processing.

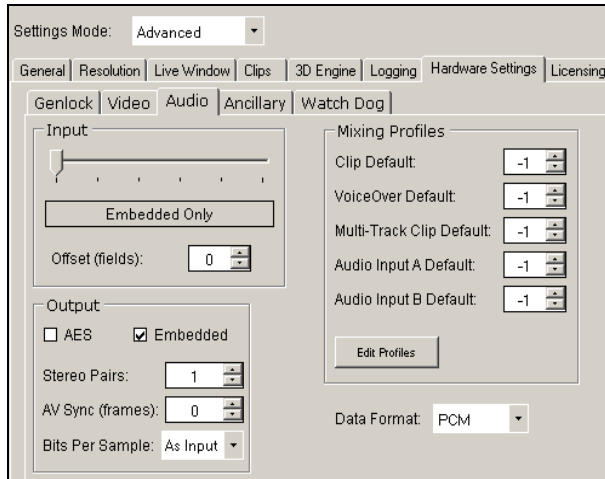

Figure 5-16. The Audio page within Dashboard's Hardware Settings

INPUT

The Intuition XG can be configured to capture only embedded audio, only discrete audio, or a combination of both. Use the slider to select the following settings:

- **EMBEDDED ONLY:** Specifies that the audio input signal is embedded in the video signal (SDI), rather than a discrete (AES) audio signal (separate from the video signal).
- **1 PAIR AES + 7 PAIRS EMBEDDED**
- **2 PAIRS AES + 6 PAIRS EMBEDDED**
- **3 PAIRS AES + 5 PAIRS EMBEDDED**
- **4 PAIRS AES + 4 PAIRS EMBEDDED**
- **AES ONLY:** Specifies that the audio input signal is discrete (AES), rather than being embedded (SDI) in the video signal.
- **OFFSET (FIELDS):** Adds additional delay to the time it takes audio to be captured at the input and then output again.

OUTPUT	<ul style="list-style-type: none"> • AES: Specifies that the audio output signal is discrete (AES), rather than being embedded (SDI) in the video signal. • EMBEDDED: Specifies that the audio output signal is embedded in the video signal (SDI), rather than a discrete (AES) audio signal (separate from the video signal). • STEREO PAIRS: Specifies the number of stereo pairs to be captured from the current audio source. • AV SYNC: Specifies the number of frames to shift the audio and video output out of sync. A positive number delays the audio and a negative number delays the video. • BITS PER SAMPLE: Specifies the bit depth of the audio signal. The available values are 0, 16, 20, and 24. The default value is 0. Using a value of 0 means that the device will automatically choose the bit-depth based on the output format. For SD, it is 20 and for HD it is 24.
MIXING PROFILES	<p>The following are the default mix profiles used for each type of object, like clips, .wav file...etc. Type the Profile ID number to assign a mixing profile from the Audio Mixing Profiles dialog box as the default mixing profile (see “Audio Mixing Profiles dialog box” on page 5-43).</p> <ul style="list-style-type: none"> • CLIP DEFAULT • VOICEOVER DEFAULT • MULTI-TRACK CLIP DEFAULT • AUDIO INPUT A DEFAULT • AUDIO INPUT B DEFAULT • EDIT PROFILES button: Opens the Audio Mixing Profiles dialog box (see “Audio Mixing Profiles dialog box” on page 5-43).
DATA FORMAT	<p>Declare the input audio format (PCM or RAW) at the startup of the Intuition XG device. If set to PCM (default), the incoming audio stream is guaranteed to be purely PCM, allowing the Intuition XG to apply audio effects. If it is set to RAW, the Intuition XG is prevented from altering the audio stream in any way, thus protecting the Dolby signal.</p>

Hardware Settings > Ancillary page

The **Ancillary** page contains parameters that allows for control over the Vertical Ancillary Data Space (VANC). This includes options such as simply passthrough through the **VANC INPUT** section and more complex management (extraction/generation/insertion) of Ancillary Data Packets (such as CDP, AFD and SDP types) through the **VANC OUTPUT** section (figure [5-17](#)).

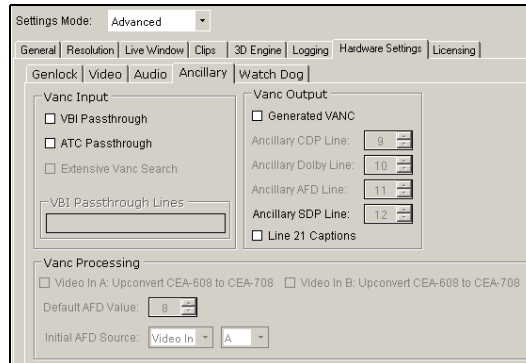

Figure 5-17. The Ancillary tab and page on the Dashboard window

Vanc Input

- **VBI PASSTROUGH:** When enabled, it indicates that the Vertical Blanking Interval (VBI) information is passed through from Video Input or selected Clips (in NTSC and PAL mode only for clips) into the VANC output. This setting is ignored if the generated VANC setting is enabled.
- **ATC PASSTROUGH:** When enabled, it indicates that the ATC (LTC or VITC time codes) should be passed through from Video Input to the Intuition XG output.
- **EXTENSIVE VANC SEARCH:** When checked, it indicates that Intuition XG should scan for ancillary data packets that may not be contiguous from the start of a VANC line. This setting forces Intuition XG to scan all of the Video Input VANC lines instead of assuming that the first unused VANC space signals the end of ancillary data packets on that line.
- **VBI PASSTROUGH LINES:** In generated VANC mode, this specifies which Video In or Clip (in NTSC and PAL mode only for clips) VBI field lines should be passed through without any processing. Lines which are passed through are not scanned for any ancillary data packets and are passed through with no modifications. If an ancillary service is specified for a line which is part of the passthrough lines, then the ancillary service is disabled. The VBI line numbers specified in this setting are in field relative ordinals. Note that a particular aspect of field relative numbering is that a Field2 line with the same ordinal as a Field1 line is always the line following it on the display (independent of which field is actually the top field). Lines that are only applicable to Video passthrough will be ignored for Clip VBI passthrough (such as Line 6 for PAL). Also note that one line is field specific in NTSC mode (line 6) and can only be passed through as part of Field2 (and only for Video Input passthrough).

<p>VANC OUTPUT</p>	<ul style="list-style-type: none"> • GENERATED VANC: When selected, it indicates that Intuition XG is operating in generated VANC output (This setting supersedes the VBI Passthrough mode). Intuition XG generates the VANC using selective passthrough of some VBI lines from Video In or from Clips (in NTSC and PAL mode only for clips), selected ancillary data packets are also generated for CDPs and AFD codes and inserted into some VANC lines, and some ancillary data packets are passed through from Video IN to the corresponding VANC output line. • ANCILLARY CDP LINE: In generated VANC mode, this property specifies which VANC line should carry caption distribution packets (CDP). If the line specified is outside the valid range (same range as for Passthrough lines except in NTSC mode where line 6 is not permissible since it is only available on Field2), then CDPs will not be managed by Intuition XG. Use -1 to disable CDP processing (any line out of range will disable the processing, but using a negative value avoids logging it as an error). Note that CDP is frame based and will only be inserted in the first field of each frame. Also note that even if the source for the captions is a "line21" CEA-606 stream, Intuition XG will create CDP packets with only the CEA-608 compatibility bytes and if no caption stream is available, Intuition XG will create empty CDP packets. • ANCILLARY DOLBY LINE: This feature is not yet supported by Intuition XG and apart from range checks, any number specified will be ignored. • ANCILLARY AFD LINE: This feature is not yet supported by Intuition XG. • ANCILLARY SDP LINE: Specifies the line of the VANC on which SDP are inserted. • LINE 21 CAPTIONS: When selected and Intuition XG's output resolution is NTSC, tis specifies that Intuition XG should extract the CEA-608 caption stream and encode it on line 21(field1 and field2). If no caption stream exists, then the lines will not be generated. Note that if there is a field 2 CEA-608 caption but no field 1 captions, the Intuition XG generates an "empty" field 1 CEA-608 caption with only "line21" clock run-in (SMPTE requirement).
<p>VANC PROCESSING</p>	<p>AFD processing is enabled when the VANC OUTPUT section's GENERATED VANC option is enabled and the ANCILLARY AFD LINE setting is valid line number. Intuition XG must insert an AFD ancillary data packet into the VANC.</p> <ul style="list-style-type: none"> • VIDEO IN A: UP CONVERT CEA-608 TO CEA-708: When enabled, this parameter converts the CEA-608 (Line 21) closed caption data on Video A input into native CEA-708, which is required for digital television broadcast. • VIDEO IN B: UP CONVERT CEA-608 TO CEA-708: When enabled, this parameter converts the CEA-608 (Line 21) closed caption data on Video B input into native CEA-708, which is required for digital television broadcast. • DEFAULT AFD VALUE: Intuition XG inserts the DEFAULT AFD VALUE into an AFD ancillary data packet under 2 conditions. The first is if Intuition XG cannot find any AFD values within the specified source (videoin or clip). It will substitute the DEFAULT AFD VALUE instead. The second case is if you selected the INITIAL AFD SOURCE to be VALUE and selected DEFAULT from the drop-down box.

VANC PROCESSING - CONTINUED	<ul style="list-style-type: none">• INITIAL AFD SOURCE: The INITIAL AFD SOURCE parameter tells the Intuition XG device where it should look to find a value to insert in the AFD ancillary data packet. Choose from the following three options:<ul style="list-style-type: none">• VIDEOIN: VideoIn is selected, then you must also select which input to use (A or B). Intuition XG scans that VANC SDI input for any AFD codes and then inserts that value into an AFD ancillary data packet.• CLIP: If Clip is selected, then you must enter the name of a clip scene element. Intuition XG tries to extract an AFD code from any clip playing within the specified scene element.• VALUE. If Value is selected, you must select a numerical value and Intuition XG inserts that value into an AFD ancillary data packet.
--	--

Hardware Settings > Watch Dog page

The Watch Dog is a feature that allows the system to continue video passthrough on a Vertigo hardware device during an application crash or a system failure. The Watch Dog page is a sub-page of the Hardware Settings tab, which is only visible when a Vertigo hardware device is selected in the Dashboard's device list. Use the settings below to configure the Vertigo device's Watch Dog.

NOTE

The Watch Dog field on the Vertigo device console uses a colored LED along with a brief statement to indicate the Watch Dog's current state during operation (see [page 3-3](#)).

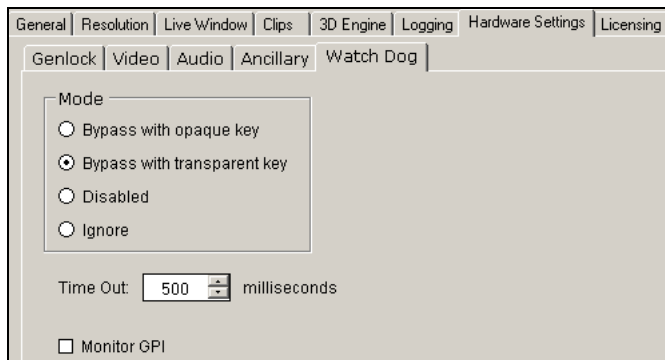

Figure 5-18. The Watch Dog page within Dashboard's Hardware Settings

<p>MODE</p>	<ul style="list-style-type: none"> • BYPASS WITH OPAQUE KEY: The Watch Dog is enabled and when it activates the key signal will become opaque. • BYPASS WITH TRANSPARENT KEY: The Watch Dog is enabled and when it activates the key signal will become transparent. • DISABLED: The Watchdog is not active. If the device fails, the output will most likely be frozen on the last frame produced. • IGNORE: When the setting is IGNORE, the device sends no signal to the hardware and the device does not use the Watch Dog. The hardware will therefore be in the last state it was set to. If however, the last state of the hardware had the Watch Dog enable, the device will NOT send a regular signal and you might never see the frames being rendered by the device. Therefore, we recommend that you intentional set the FILL to ENABLED when you want activate the Watch Dog.
<p>TIME OUT</p>	<p>Specifies the number of milliseconds that must elapse during which no rendering occurs before the hardware Watch Dog kicks in. The default value is 500.</p>
<p>MONITOR GPI</p>	<p>When enabled, the watch dog listens to the GPI server for a trigger to activate the video bypass functionality.</p>

Licensing page

The Device Settings' Licensing page allows you to set the XMS IP and port information that is used to retrieve and identify valid application licenses for the Vertigo devices, as well as clip and audio licenses (hardware devices only).

General	Resolution	Live Window	Clips	3D Engine	Logging	Hardware Settings	Licensing
XMS IP Address:	<input type="text" value="127.0.0.1"/>						
XMS Port:	<input type="text" value="14050"/>						
Backup XMS IP Address:	<input type="text" value="(null)"/>						
Backup XMS Port:	<input type="text" value="14050"/>						
Embedded XMS Port:	<input type="text" value="14050"/>						
Valid Licenses:	<input type="text" value="Application, Clips, Audio, Encode"/>						<input type="button" value="Refresh"/>

Figure 5-19. The Licensing tab and page on the Dashboard window

XMS IP ADDRESS	Sets the IP address of the primary XMS that the application will attempt to checkout licenses from.
XMS PORT	Sets the port of the primary XMS that the application will attempt to connect on.
BACKUP XMS IP ADDRESS	Sets the IP address of the backup XMS used for licensing.
BACKUP XMS PORT	Sets the port of the backup XMS used for licensing.
EMBEDDED XMS PORT	Sets the port the application will attempt to connect on. This is a read-only parameter.
VALID LICENSES	Displays which licenses that application was able to obtain from either the primary, backup, or embedded XMS. The REFRESH button allows the device to retry the checkout of any feature licenses that it does not yet have.

Audio Mixing Profiles dialog box

The Audio Mixing Profiles dialog box allows you to create up to ten (10) audio mixing profiles that can be assigned as defaults for the various audio formats on the Dashboard's Hardware Settings' Audio page. See ["Hardware Settings > Audio page" on page 5-36](#) for more details regarding assigning defaults.

The Audio Mixing Profile dialog box facilitates the creation of mixing profiles by letting you work from within one of three predefined matrixes formats: 2x2, 6x6, or 8x8 channels. You can also add or remove channels from the matrix to suit your needs. Each matrix structure allows you to assign the percentage of the input audio signal that will be mixed into the output channel.

Figure 5-20 and the following tables the components of the Audio Mixing Profiles dialog box:

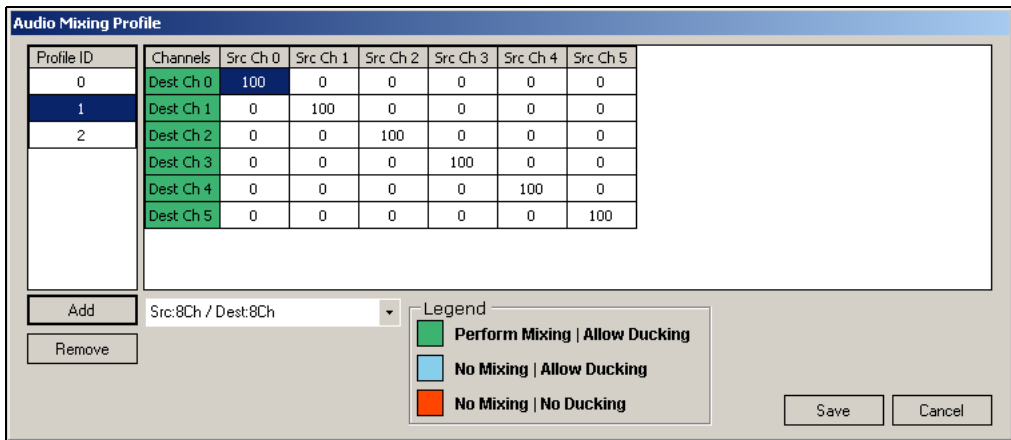

Figure 5-20. Audio Mixing Profile dialog box with a 6 x 6 matrix mixing profile

<p>PROFILE ID</p>	<p>Identifies the profile ID number associated to a specific mixing profile matrix. You can store up to ten (10) audio mix profiles in the list (numbered 0 to 9). It is this number that will be used to set the default mixing profiles for the various audio files listed on the Hardware Settings' Audio page (see "Hardware Settings > Audio page" on page 5-36).</p>
<p>ADD / REMOVE buttons</p>	<p>The ADD button adds the mixing profile matrix that is currently being created to the Profile ID list and assigns it a Profile ID number in the list.</p> <p>The REMOVE button deletes the selected mixing profile from the Profile ID list. The Remove command is also accessible by right-clicking on the Profile ID list.</p>

<p>MATRIX FORMAT Drop-down List</p>	<p>This drop-down list contains three (3) predefined matrix formats that you can use as the basis for building your mixing profile. Although the matrixes are a predefined size, you can add channels to the matrix format by using the ADD SOURCE and ADD DESTINATION commands.</p> <p>The three predefined mixing matrix formats are:</p> <ul style="list-style-type: none"> • SRC: STEREO / DEST:STEREO: A 2x2 matrix featuring 2 source channels and 2 destination channels used for creating stereo sound profiles (left and right). • SRC: 6CH / DEST:6CH: A 6x6 matrix featuring 6 source channels and 6 destination channels used for mixing to 5.1 conventional surround sound (for example: front left, front right, front center, low frequencies/subwoofer, back left, and back right). • SRC: 8CH / DEST:8CH: An 8x8 matrix featuring 8 source channels and 8 destination channels used for mixing to 8-channel commercial surround sound (for example: front left, front right, front center, low frequencies/subwoofer, back left, back right, Side left, and side right).
<p>SOURCE /DESTINATION CHANNELS</p>	<p>Source channels represent the channels upon which the audio data is entering the system and the destination channel is the channel upon which the audio data will leave the system.</p> <p>The intersecting points in the matrix (the box where the source and destination channels intersect) specifies the percentage of the source signal that will be passed through to the destination channel. For example, a value of zero (0) means that none of the signal will pass through to the destination channel, while a value of 100 means the full signal will be passed through.</p> <p>The destination channel headings feature different color backgrounds depending on the status/setting of the channel. The colors are defined in the interface's legend:</p> <ul style="list-style-type: none"> • GREEN: Perform Mixing / Allow Ducking • BLUE: No mixing / Allow Ducking • RED: No mixing / No Ducking
<p>SOURCE /DESTINATION CHANNELS - CONTINUED</p>	<p>The destination channel will display as green if mixing is enabled by setting the intersecting mixing value as greater than zero (>0). If the value is set to zero, this indicates that no mixing will occur and therefore the destination channel will be displayed in red.</p> <p>When a channel is set to have no mixing (i.e. 0 value), you can use a technique called ducking by using the DUCK command. The Duck command determines the behavior of the output channel with respect to the original level (see Duck command below). When the DUCK command is applied to a destination channel turns from red to blue. Note that ducking is automatic when mixing.</p>

SAVE / CANCEL buttons	<p>The SAVE button saves the mixing profile matrix, and any changes that were made to the matrix values or structure, by associating it with a number in the Profile ID list.</p> <p>The CANCEL button allows you to exit the Audio Mixing Profile dialog box without saving any of the changes made to the mixing matrixes/profiles.</p>
ADD SOURCE command	<p>Use the ADD SOURCE command to add an additional source channel to a predefined mix matrix. The ADD SOURCE command is accessed by right-clicking anywhere within the matrix and selecting ADD SOURCE from the command list.</p>
ADD DESTINATION command	<p>Use the ADD DESTINATION command to add an additional destination channel to a predefined mix matrix. The ADD DESTINATION command is accessed by right-clicking anywhere within the matrix and selecting ADD DESTINATION from the command list.</p>
DUCK command	<p>The DUCK command enables a technique for attenuating the audio coming in on the “ducked” channel, to make room for another signal to dominate. For example, the music coming in on a channel will lower when a voice over is introduced.</p> <p>Ducking is automatically enable when mixing is enabled (value > 0).</p> <p>You can also manually set the ducking command when the mixing value is set to zero (0 indicating no audio mixing to that channel). The DUCK command is accessed by right-clicking the destination channel heading and selecting from the command list. When ducking is enabled, the destination channel's heading turns blue.</p>

Creating an audio profile using the Audio Mixing Profile dialog box

1. Open the Audio Mixing Profile dialog box by pressing the **EDIT PROFILES** button on the Hardware Settings' Audio page (figure 5-21).

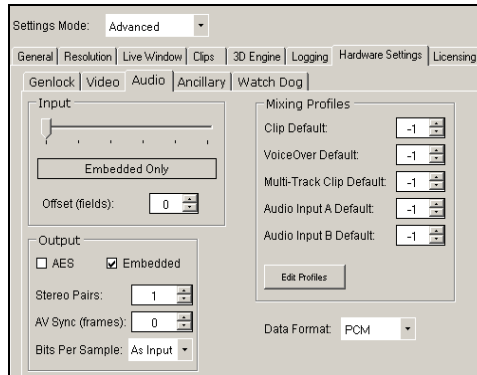

Figure 5-21. Hardware Settings' Audio page

2. Select a predefined matrix format from the drop-down list.

The choices are:

- **SRC:STEREO / DEST:STEREO**
- **SRC:6CH / DEST:6CH**
- **SRC:8CH / DEST:8CH**

Note that these are basic matrix formats and you may need to add source or destination channels to the matrix to meet your needs. For example, if you want to create an audio mixing profile that takes a 2-channel stereo source to a 6-channel 5.1 surround destination, you would select **SRC:STEREO / DEST:STEREO** and then add four (4) destination channels to the matrix (see [ADD DESTINATION command](#) above).

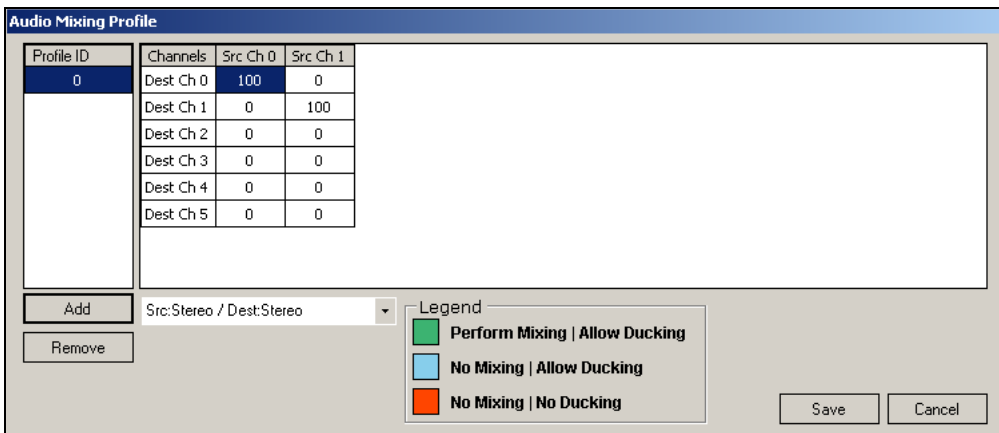

3. Press the **ADD** button to add the profile to the Profile ID column. The matrix is assigned a Profile ID number (0 to 9).

The audio mixing matrix appears in the main frame with a default channel matching profile (i.e. 100% of source channel 0 to destination channel 0).

4. Assign the mixing values by typing the mixing values for each of the channels in the matrix. The number represents the percentage of the source signal to be mixed into the destination channel (for example, 100 is 100%).

The matrix below demonstrates the audio mixing profile for a 2-channel stereo source to be mixed into a 6-channel 5.1 surround configuration, where:

- 100% of the source channel 0 and 0% of the source channel 1 will be mixed into destination channel 0.
- 0% of the source channel 0 and 100% of the source channel 1 will be mixed into destination channel 1.
- 20% of source channel 0 and 80% of source channel 1 will be mixed into destination channel 2.
- 80% of source channel 0 and 20% of source channel 1 will be mixed into destination channel 3.
- 50% of source channel 0 and 50% of source channel 1 will be mixed into destination channel 4.
- 50% of source channel 0 and 50% of source channel 1 will be mixed into destination channel 5.

Profile ID	Channels	Src Ch 0	Src Ch 1
0	Dest Ch 0	100	0
	Dest Ch 1	0	100
	Dest Ch 2	20	80
	Dest Ch 3	80	20
	Dest Ch 4	50	50
	Dest Ch 5	50	50

5. Save the mixing profile to the Profile ID list by pressing the **SAVE** button.
6. Return to Dashboard's Audio page and type the Profile ID number for the desired profile in the appropriate Mixing Profile parameter.