

KMV-3901 / KMV-3911

High quality, ultra-flexible and scalable multiviewer

Guide to Installation and Operation

M866-9900-113

26 March 2014



A **BELDEN** BRAND

Copyright & Trademark Notice

Copyright © 2011–2014, Miranda Technologies Partnership. All rights reserved.

Belden, Belden Sending All The Right Signals, and the Belden logo are trademarks or registered trademarks of Belden Inc. or its affiliated companies in the United States and other jurisdictions. Miranda, KMV-3901/3911, iControl, and Densité are trademarks or registered trademarks of Miranda Technologies Partnership. Belden Inc., Miranda Technologies Partnership, and other parties may also have trademark rights in other terms used herein.

Terms and Conditions

Please read the following terms and conditions carefully. By using Kaleido multiviewer documentation, you agree to the following terms and conditions.

Miranda Technologies Partnership (“Miranda”) hereby grants permission and license to owners of Kaleido multiviewers to use their product manuals for their own internal business use. Manuals for Miranda products may not be reproduced or transmitted in any form or by any means, electronic or mechanical, including photocopying and recording, for any purpose unless specifically authorized in writing by Miranda.

A Miranda manual may have been revised to reflect changes made to the product during its manufacturing life. Thus, different versions of a manual may exist for any given product. Care should be taken to ensure that one obtains the proper manual version for a specific product serial number.

Information in this document is subject to change without notice and does not represent a commitment on the part of Miranda.

Warranty information is available in the Support section of the Miranda Web site (www.miranda.com).

The SDHC Logo is a trademark of SD-3C, LLC.

Title	KMV-3901/3911 Guide to Installation and Operation
Part Number	M866-9900-113
Revision	26 March 2014, 7:48 pm

Electromagnetic Compatibility

FC This equipment has been tested for verification of compliance with FCC Part 15, Subpart B requirements for class A digital devices.

Note: This equipment has been tested and found to comply with the limits for a Class A digital device, pursuant to part 15 of the FCC Rules. These limits are designed to provide reasonable protection against harmful interference when the equipment is operated in a commercial environment. This equipment generates, uses, and can radiate radio frequency energy and, if not installed and used in accordance with the instruction manual, may cause harmful interference to radio communications. Operation of this equipment in a residential area is likely to cause harmful interference in which case the user will be required to correct the interference at his own expense.

CE This equipment has been tested and found to comply with the requirements of the EMC directive 2004/108/CE:

- EN 55022 Class A radiated and conducted emissions
- EN 61000-3-2 Limits for harmonic current emissions
- EN 61000-3-3 Limitation of voltage changes, voltage fluctuations and flicker
- EN 61000-4-2 Electrostatic discharge immunity
- EN 61000-4-3 Radiated, radio-frequency, electromagnetic field immunity
- EN 61000-4-4 Electrical fast transient/burst immunity
- EN 61000-4-5 Surge transient immunity
- EN 61000-4-6 Conducted disturbances immunity
- EN 61000-4-8 Power frequency magnetic field immunity
- EN 61000-4-11 Voltage dips, short interruptions and voltage variations immunity

toc

Table of Contents

1	Installation	1
	Features	1
	Block Diagram	2
	Front Card-Edge Interface	2
	Unpacking	3
	Installation in the Densité Frame	3
	Rear Connector Panel	4
	Front Card Edge	6
2	Operation	9
	Card-Edge LEDs	9
	Using the Densité Frame Control Panel	11
	Remote Control Using iControl	13
3	Specifications	25
	Video Inputs	25
	Mosaic Outputs	26
	Reference	27
	GPI I/O	27
	Communication	28
	Video Processing Performance	28
	Audio Processing Performance	28
	Electrical	28
	Appendix A KMV-3901/3911 Local Control Panel	29
	Contact Us	31

1 Installation

Kaleido-Modular is the most space and energy efficient multiviewer system, with up to 20 multiviewer outputs per 3RU frame, consuming only 300 Watts in total. It also offers super silent operation, outstanding picture quality, and expansion up to 288 multiviewer outputs when connected to an upstream router.

The KMV-3911 multiviewer card is the central building block of the Kaleido-Modular system. It replaced the earlier KMV-3901 models. Kaleido-Modular systems are available in the following sizes: 4 × 1, 4 × 2, 8 × 1, 8 × 2, 12 × 1, 12 × 2, 16 × 1, 16 × 2, 20 × 1, 20 × 2, 24 × 1 and 24 × 2. In addition to the earlier model's features, the KMV-3911 supports up to two HD-SDI monitoring outputs.

Features

UNMATCHED SPACE EFFICIENCY

- 20 quad-splits, or ten 8-input KMV-3901/3911 multiviewer cards, per 3RU frame
- Fully loaded frame with 10 cards weighs only 9.9 kg (21.8 lbs)

LOW POWER CONSUMPTION

- 300 Watts for fully loaded 3RU frame with 10 cards and up to 20 outputs
- 24 Watts per dual-output card

SUPER SILENT

- Ideal for installation within studios, control rooms and trucks

HIGH QUALITY, FLEXIBLE MONITORING

- Outstanding multiviewer picture quality, based on award-winning Kaleido technology, with all essential display elements for production
- Choice of single multiviewer output per card with up to 8 pictures, or dual quad-split displays
- The KMV-3911 supports up to two HD-SDI monitoring outputs (one associated with Head 1, and one with Head 2 if enabled), with embedded audio

ROUTER INTEGRATION

- Tight integration with NVISION and third party routers allows expansion up to 1152 inputs and 288 multiviewer outputs
- Multiple multiviewer outputs can be controlled from a single panel

ULTRA-RESILIENT

- Hot-swappable cards with Auto-Recovery for configuring cold replacement cards during maintenance
- 3RU frame features dual hot-swappable power supplies and fans plus redundant Ethernet

3Gbps/HD/SD OPERATION

- Triple-rate, future-proof performance

MIX AND MATCH CARD FUNCTIONS

- Kaleido-Modular multiviewer cards can be installed in a 3RU frame with other Densité Series cards, such as signal processors and DAs, for maximum space and cost-effectiveness

Block Diagram

The following block diagram shows the functionality of the KMV-3911. Except for the HD-SDI monitoring outputs, the same diagram applies to the earlier KMV-3901 models.

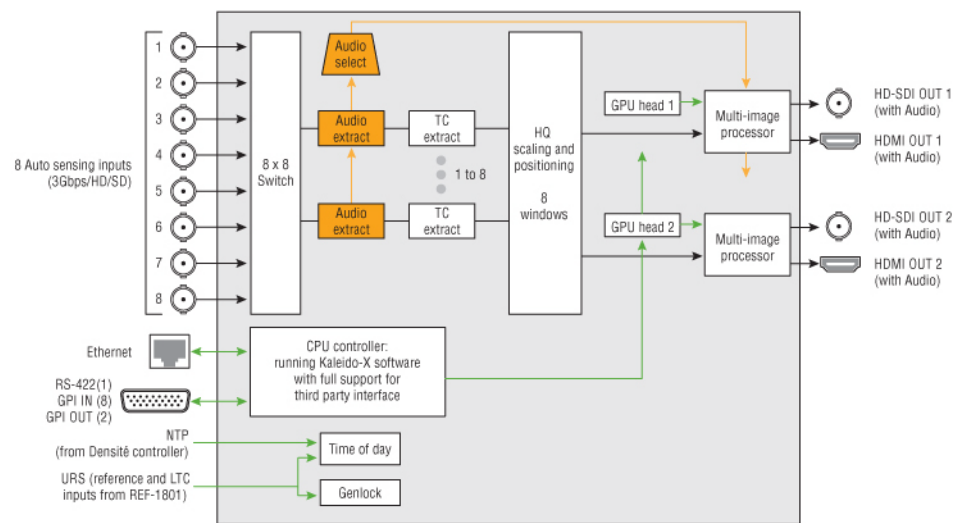

Functional block diagram of the KMV-3911

Front Card-Edge Interface

The front card-edge of the KMV-3901/3911 incorporates several operational elements:

- Select Button (see [Using the Densité Frame Control Panel](#), on page 11)
- Status LED (see [Status LED](#), on page 10)
- CPU Status LED (see [CPU Status LED](#), on page 10)
- Boot LED (see [Boot LED](#), on page 10)
- Power LED (see [Power LED](#), on page 11)
- SDI LEDs (8) (see [SDI LEDs](#), on page 11)
- USB connector (see [USB Connector](#), on page 6)
- Bridge connectors (2) (see [Bridge Connectors](#), on page 7)

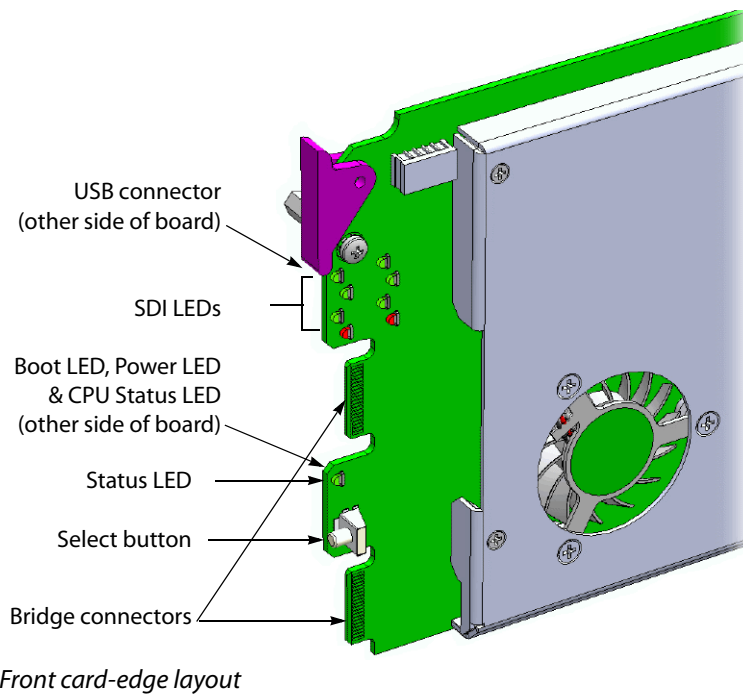

Unpacking

Make sure the following items have been shipped with your KMV-3901/3911. If any of the following items are missing, contact your distributor or Miranda.

- KMV-3911 or KMV-3901 3Gbps/HD/SD multiviewer card
- the appropriate rear connector panel for the card (see [KMV-3911-8X2-3DRP rear panel](#), or [KMV-3901-8X2-3DRP rear panel](#), on page 5)

Installation in the Densité Frame

The KMV-3901/3911 and its associated rear connector panel must be mounted in a Densité 3 frame or a Densité 3 mini frame. It is not necessary to switch off the frame's power when installing or removing the card. Refer to the Densité 3 frame manual or the Densité 3 mini frame manual for detailed instructions on installing cards and their associated rear panels.

IMPORTANT

Keep the KMV-3901/3911 offline at initial setup to avoid conflicts.

Before powering up the Densité housing frame, make sure none of the KMV-3901/3911 multiviewer cards it contains are connected to the network, to avoid IP-address conflicts during initial physical setup—i.e. make sure there is no cable connected to your cards' ETH port.

IMPORTANT *(continued)*

Densité CPU-ETH2 Enhanced Ethernet Controller Card

A Densité frame housing a KMV-3901/3911 multiviewer card must have a controller card (Densité CPU-ETH2 Enhanced Ethernet Controller Card) with firmware version 2.0.4 or later. A controller with an earlier version of the firmware cannot provide a time reference to the multiviewer card. Make sure the controller's internal clock is set to the correct date and time. The clock settings will persist for 10 days after a power loss. Should you need to change the time on a Densité CPU-ETH2 controller, then make sure to restart all multiviewers located in the same housing frame as the controller card. Refer to the Densité CPU-ETH2 Enhanced Ethernet Controller Card Guide to Installation and Operation for more information.

Rear Connector Panel

The KMV-3901/3911 requires a dual-slot-width rear panel:

- Eight 3G/HD/SD inputs (BNC connectors). Optional inputs 5-8 are available only in the case of 8 × 2, and 8 × 1 models.
- Two 3G/HD/SD multiviewer outputs (HDMI connectors). Optional MV OUT 2 is available only in the case of 4 × 2, 8 × 2 cards.
- Two HD-SDI monitoring outputs (DIN 1.0/2.3 connectors). Only supported with the KMV-3911 models.
- One DB-26 connector for GPI I/O lines (8 in / 2 out) and RS-422 control. Miranda's NSH26M wiring terminal adapter can be used to connect the GPI lines to this connector.
- One RJ-45 for data transfer over Ethernet.

With the double-width rear panel installed in a Densité-3 frame, the KMV-3901/3911 must be installed in the rightmost of the two slots covered by the panel in order to mate with the panel's connectors.

In a Densité 3 mini frame, the card must be placed in the bottom slot.

If it is placed in the wrong slot, the front panel LED will flash red. Move the card to the other slot for correct operation. No damage will result to the card if this occurs.

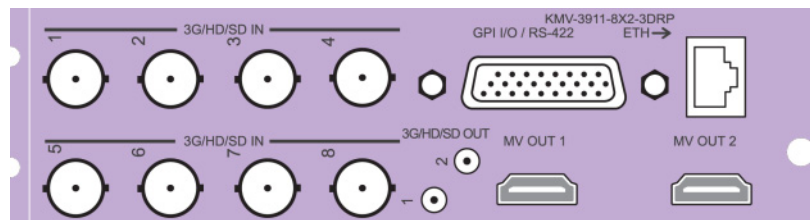

KMV-3911-8X2-3DRP rear panel

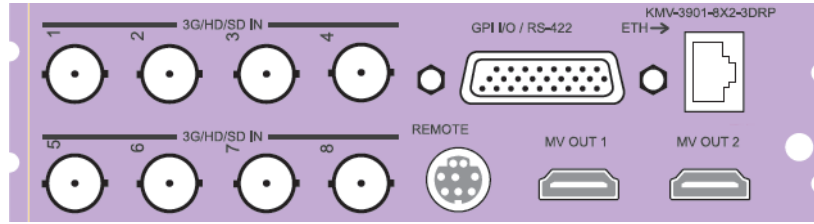

KMV-3901-8X2-3DRP rear panel

Ethernet Port

The Ethernet port must be configured before it can be used to communicate with the KMV-3901/3911. See [Network Settings Panel](#), on page 16.

GPI/RS-422 Connector

The DB-26 GPI connector carries 8 GPI IN and 2 GPI OUT lines, plus the RS-422 interface. The pinout of this connector is listed below.

Pin	Function	Pin	Function	Pin	Function
1	422 TX+	10	422 TX -	19	GND
2	422 RX+	11	422 RX -	20	GND
3	GPI IN2	12	GPI IN1	21	GPI IN3
4	GND	13	GPI IN4	22	GPI IN5
5	GPI IN7	14	GPI IN6	23	GPI IN8
6	NC	15	GND	24	NC
7	OUT 1-(emitter)	16	GND	25	OUT 1+ (collector)
8	GND	17	GND	26	OUT 2- (emitter)
9	NC	18	OUT 2+ (collector)		

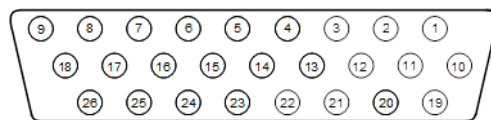

DB-26 GPI/RS-422 connector

Note: Miranda's NSH26M wiring terminal adapter can be used to connect the GPI and RS-422 lines to this connector. The NSH26M comes with a label that identifies the pinout to make wiring easy.

HDMI Mosaic Output Connectors

Connect these outputs (MV OUT 1 and MV OUT 2) to video displays using HDMI cables.

Space constraints on the KMV-3901/3911 rear module do not allow HDMI connectors with a screw securing mechanism. For this reason, a special locking mechanism is incorporated on the rear panel. The mechanism is adjustable for many sizes of cables and shells.

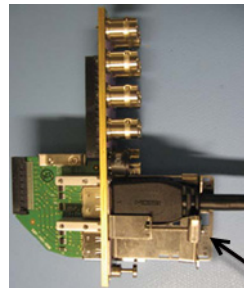

Incorporated locking mechanism

In the case of a KMV-3901/3911 with both heads activated, the two HDMI cables should have same-size plug connectors; otherwise the locking mechanism will not hold the smaller connector securely. If your cables have long plug connectors that will not fit the special locking mechanism, you can secure them with a cable wrap threaded through the hole in the bracket.

HD-SDI Monitoring Output Connectors

There are two HD-SDI monitoring outputs: one associated with Head 1, and one with Head 2 if enabled. The HD-SDI output resolution depends on the current resolution at the corresponding HDMI output, and, in the case of a 1080-line resolution, on the scan format (interlaced, progressive) configured in XEdit for this output head.

HDMI output resolution	HD-SDI output (interlaced)	HD-SDI output (progressive)
1280 × 720 50 Hz	No output	720p 50 Hz
1280 × 720 59.94 Hz	No output	720p 59.94 Hz
1920 × 1080 50 Hz	1080i 50 Hz	1080p 50 Hz
1920 × 1080 59.94 Hz	1080i 59.94 Hz	1080p 59.94 Hz
Any other HDMI resolutions	No output	No output

Front Card Edge

USB Connector

This USB connector is accessible when the front panel of the Densité frame is open. The USB connector is used for the following tasks:

- Upgrading the Kaleido-X Software and KMV-3901/3911 firmware, by using a USB key prepared with the appropriate upgrade package. Refer to the Kaleido-X Release Notes for details.
- Controlling some features on the monitor wall, by using a mouse (e.g. showing or hiding the monitor wall dashboard, dismissing the confirmation message that appears

at the end of the upgrade process). Refer to the Kaleido-X User's Manual for details.

Note: The KMV-3901/3911 does not support USB hubs. Only one USB device (USB key or mouse) can be connected at a time. If an externally powered USB hub is connected to the KMV-3901/3911, then a mouse connected to the hub will not work.

Bridge Connectors

The bridge connectors are accessible when the front panel of the Densité frame is open.

They are used to interconnect two adjacent KMV-3901/3911 cards by using a cascade bridge (Miranda part no. KMV-3901-8XN-BRIDGE). Refer to the KMV-3901/3911 Cascade Step-by-Step Configuration guide, available on the Kaleido-X DVD, for detailed instructions on setting up a cascade system.

2 Operation

The KMV-3901/3911 can be controlled in different ways:

- On the Densité frame, the local control panel and its buttons can be used to navigate menus and adjust parameter values (see [Using the Densité Frame Control Panel](#), on page 11).
- Miranda's iControl system can be used to access the card's operating parameters from a remote computer, using a convenient graphical user interface (see [Remote Control Using iControl](#), on page 13).
- The loading and management of layouts is handled via a Java-based application, XEdit, accessed through a dedicated Ethernet port (see the Kaleido-X User's Manual, (available on the Kaleido-X DVD that shipped with your system, and from the Miranda support portal).
- A GPI interface allows remote layout selection.
- The output resolution of the card can be controlled automatically through the EDID interface with the display.
- The RCP-200 advanced remote control panel, and the Kaleido-RCP2 control panel allow you to perform operations on the monitor wall, either by themselves or in association with an external keyboard and a mouse. Refer to the RCP-200, Kaleido-RCP2, and Kaleido-X documentation (available on the Kaleido-X DVD that shipped with your system).

Card-Edge LEDs

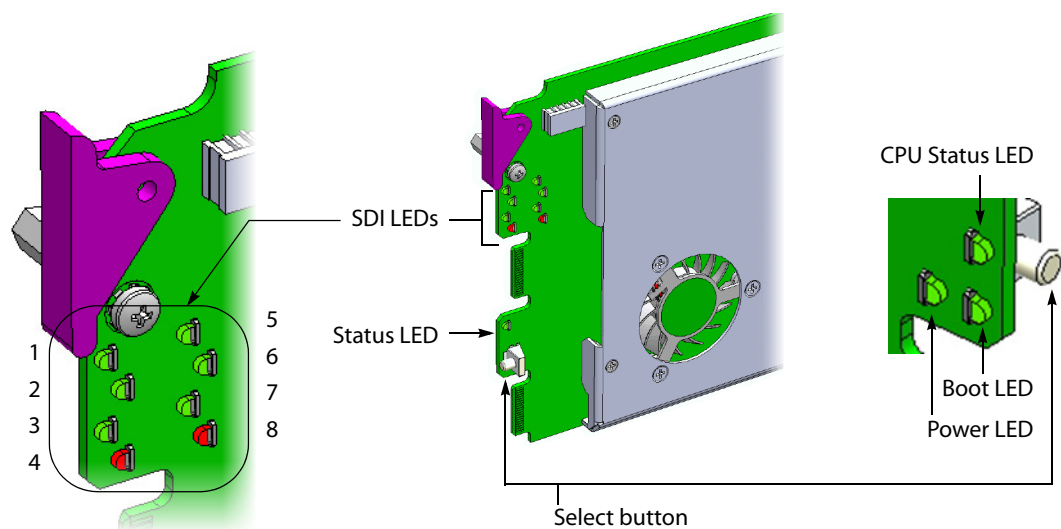

Status LED

The Status LED is located on the front card-edge of the KMV-3901/3911, immediately above the Select button, and is visible through the front access door of the Densité frame. This multi-color LED indicates the status of the KMV-3901/3911 by color, and by blinking/steady illumination:

LED	Meaning
Green	Normal
Blinking orange	Booting (or the card is selected for local control)
Red	No Ethernet / SD card error
Blinking red	Fan failure / no rear / duplicate IP address

The Status LED always shows the most severe detected error status that it is configured to display (see [Alarm Configuration Panel](#), on page 17), and in the table above error severity increases from top to bottom, with green representing no error/disabled, and blinking red the most severe error.

If the Status LED is blinking orange, it means that the card is selected for local control using the Densité frame's control panel, or that the card is booting up. See [Using the Densité Frame Control Panel](#), on page 11 for details.

CPU Status LED

Monitors the status of the CPU operation.

LED	Meaning
Green	OK
Red	CPU kernel error
Blinking red	Upgrading

Boot LED

Monitors the status of the system firmware.

LED	Meaning
Blinking green	System OK (<i>heartbeat</i> signal)
Steady red	Beginning of start-up process (normal) Continuous - error
Steady green or OFF	Software not running

Power LED

Monitors the status of the power on board the KMV-3901/3911 card.

LED	Meaning
Green	OK
Red	Error detected This is a latched error and will remain displayed until the next reboot, even if the error was a brief glitch and the supply is OK. If the LED remains red after a restart, there is or has been a fault in the power source.

SDI LEDs

This group of eight LEDs monitors the status of the eight inputs to the KMV-3901/3911 card. The frame door must be open for the LEDs to be visible.

LED	Meaning
Green	Input SDI signal detected
Red	Error - no input signal detected

Using the Densité Frame Control Panel

All of the cards installed in a Densité frame are connected to the frame’s controller card, which handles all interaction between the cards and the outside world. There are no operating controls located on the cards themselves. The controller supports remote operation via its Ethernet ports, and local operation using its integrated control panel.

The local control panel is fastened to the controller card, and consists of a display unit capable of displaying two lines of text, each 16 characters in length, and five buttons.

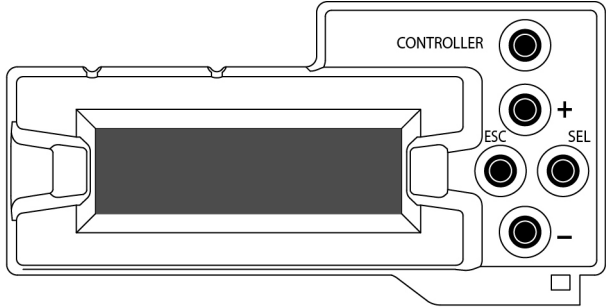

Densité CPU-ETH2 local control panel

The panel is assigned to operate any card in the frame by pressing the Select button *on the front edge of that card*. The Status LED on the selected card will then be blinking orange.

Press the CONTROLLER button on the control panel to select the controller card itself.

Navigating the Local Control Panel Menu

The KMV-3901/3911 has operating parameters which may be adjusted locally at the controller card interface. Press the Select button *on the KMV-3901/3911 front card edge* (see [Front Card-Edge Interface](#), on page 2) to assign the local control panel to operate the card. Use the control panel buttons to navigate through the menu, as described below.

The complete menu structure is shown in Appendix A [KMV-3901/3911 Local Control Panel](#), on page 29.

The local control panel displays a menu that can be navigated using the four buttons located next to the display. The functionality of the buttons is as follows:

[+] and [-] Used for menu navigation and value modification.

SEL Gives access to the next menu level. When a parameter value is shown, pressing this button once enables modification of the value using the [+] and [-] buttons; pressing a second time confirms the new value.

ESC Cancels the effect of parameter value changes that have not been confirmed; pressing ESC causes the parameter to revert to its former value. Pressing ESC moves the user back up to the previous menu level. At the main menu, ESC does not exit the menu system. To exit, press the Select button on the front edge of the card being controlled.

If no controls are operated for 30 seconds, the controller reverts to its normal standby status, and the selected card's Status LED reverts to its normal operating mode. If a parameter was changed on the card but not submitted (SEL was not pressed) and the 30 second timeout occurs, the parameters will be confirmed as if the SEL button had been pressed.

Saving a Restore Point to the Controller's Non-Volatile Memory

The Densité CPU-ETH2 controller can be configured to automatically apply parameters from a previously saved restore point, when you replace a card with another card of the same type. In the case of a KMV-3901/3911 card the restore point includes the multiviewer's system name and networking parameters.

To save a restore point to the controller's non-volatile memory, proceed as follows:

- 1 On the Densité frame's local control panel, press the CONTROLLER button.
- 2 Press the [-] button repeatedly until RESTORE POINTS appears on the display, and then press the SEL button.
- 3 Press the [-] button repeatedly until SAVE A CARD appears on the display, and then press the SEL button.
- 4 Press the [-] button repeatedly until CARD # N-where N matches the slot number for the Kaleido-Modular card whose configuration you wish to save-appears on the display, and then press the SEL button.

Remote Control Using iControl

The KMV-3901/3911 may be controlled by using Miranda's iControl version 3.60 or later. This section describes the control panel associated with the KMV-3901/3911 and its use. Refer to the iControl User's Guide for information about setting up and operating iControl.







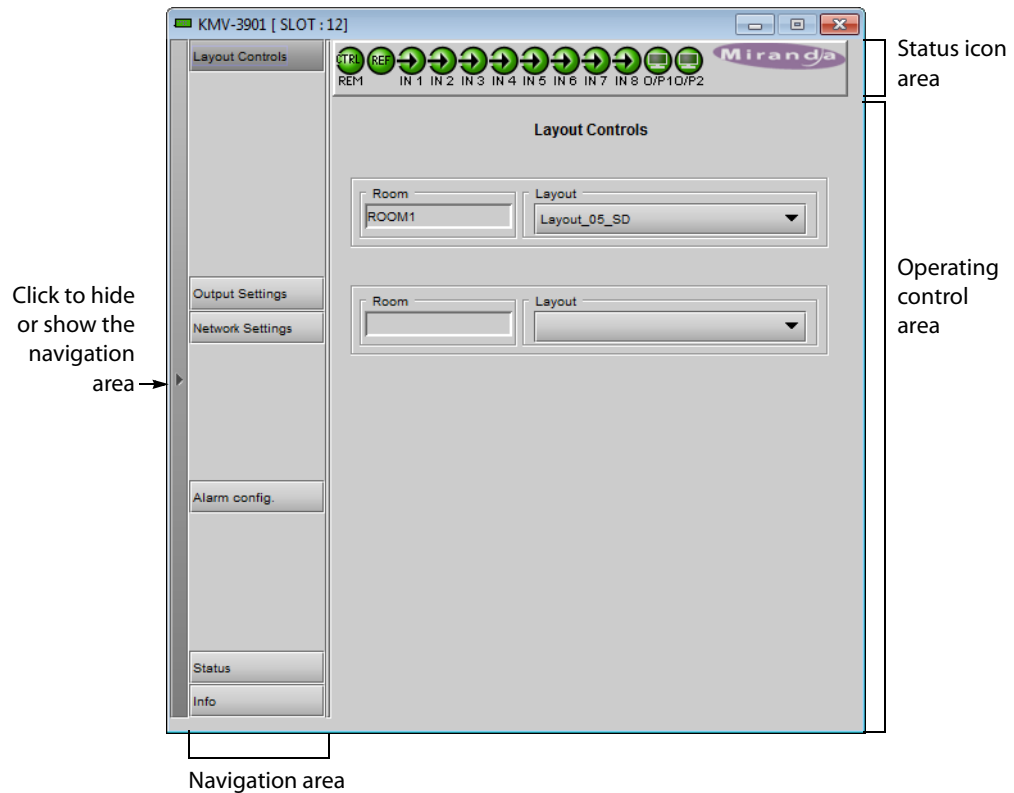

In iControl Navigator or iControl Web, double-click a KMV-3901/3911 icon to open the associated control panel.

KMV-3901/3911 Service Control Panel in iControl

The card type (*KMV-3901* in this example) and the slot number where the card is installed in the Densité frame are indicated in the window's title bar. There are three main areas in the KMV-3901/3911 control panel window itself: the status icon area, the navigation area, and the operating control area.



The status icon area shows a series of twelve icons that report the status of some card parameters.

Icon 1 - Control status	Icon 2 - Reference status	Icons 3 to 10 - Status of inputs 1 to 8	Icons 11 and 12 - Status of outputs 1 and 2
 Green: Remote control via iControl	 Green: Locked to frame reference (mouse over to see format)	 Green: Input signal detected (mouse over to see details of the format)	 Green: EDID information detected on the HDMI channel
 Yellow: Local control at the Densité frame using the menu	 Red: Unavailable	 Red: No input signal detected	 Red: No EDID information detected on the HDMI channel

Move the mouse over an icon and a status message appears below the icon area providing additional information.

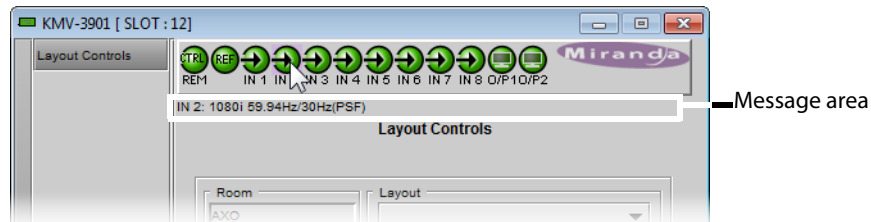

Error status messages appear in the message area without mouse-over.

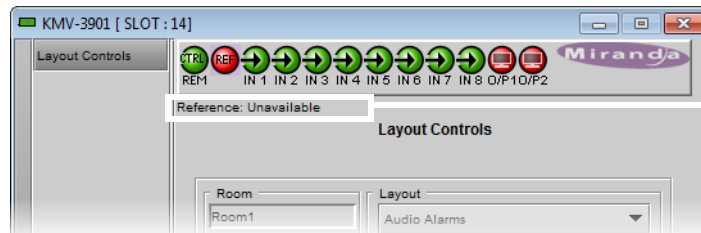

- If there are multiple errors, the error messages cycle so all can be seen.
- The icon whose status or error message is shown is highlighted with a mauve background.

The navigation area contains buttons that control the contents of the main area. Click a button to access the associated features. Click the left side border (identified by a small arrow icon) to hide or reveal this area.

The operating control area contains the main operating controls for managing the KMV-3901/3911 multiviewer's feature set. The contents change depending on the button you clicked in the navigation area. The five panels are described individually in the following sections:

- [Layout Controls Panel](#) below
- [Output Settings Panel](#), on page 15
- [Network Settings Panel](#), on page 16
- [Alarm Configuration Panel](#), on page 17

- [Status Panel](#), on page 20
- [Info Panel](#), on page 21

Layout Controls Panel

The two **Layout** lists are used to load layouts to the monitor wall displays. Depending on your configuration, you may have either one room with one or two displays, or two rooms with one display each. Sample layouts are available on the KMV-3901/3911 multiviewer as shipped, for immediate use. Additional layouts may be created in XEdit, and exported to the multiviewer. Refer to the Kaleido-X User's Manual for more information on creating rooms and layouts.

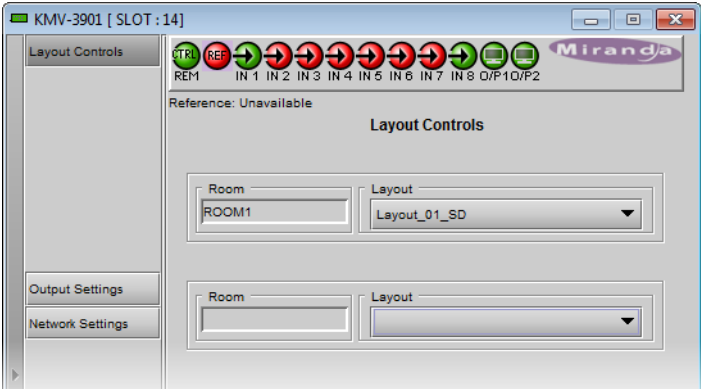

Output Settings Panel

Set the resolution of the multiviewer output heads to an appropriate value based on the displays in use. If a display uses EDID (Extended Display Identification Data) to communicate its characteristics to the KMV-3901/3911 multiviewer via the HDMI connector, the matching can be done automatically, in which case the detected resolution appears in the **Detected resolution** box. Select the check box to use the detected resolution. If the detected resolution is not used (either because the check box is not selected or because the display does not make the information available) the value selected in the **Output resolution** list will be used.

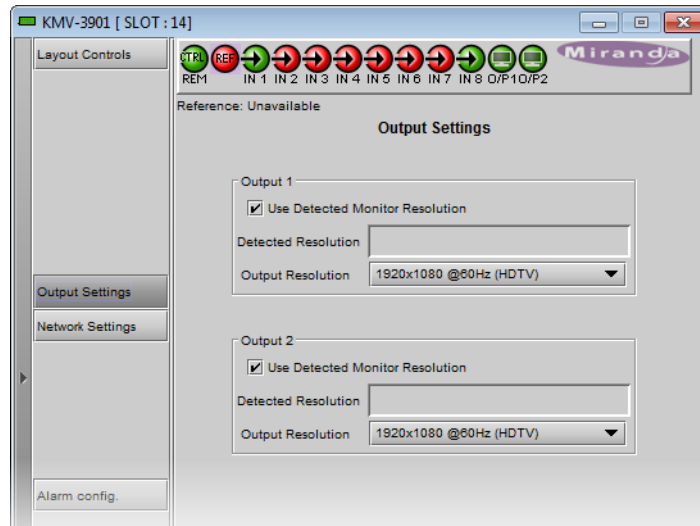

The following table lists some (but not all) output formats supported at the HDMI connections. You can customize your own timing rates for resolutions ranging from 1280 × 1024 pixels up to 1920 × 1200 pixels, through the XEdit software.

Resolution	Format name	Refresh rates (Hz)
1280 × 1024	SXGA	50.00, 59.94
1280 × 1024	BARCO	59.94
1360 × 768	NEC	50.00, 59.94
1480 × 1200	Christie	50.00, 59.94
1600 × 1200	UXGA	50.00, 59.94
1920 × 1080	Baycat	50.00, 59.94
1920 × 1200	WUXGA	50.00, 59.94

Note: All KMV-3901/3911 cards within a housing frame must have their output heads configured with the same refresh rate. If your frame is referenced, then the heads' refresh rate must also match the reference signal's refresh rate.

Network Settings Panel

The KMV-3901/3911 is shipped with default network settings, which will not work for your network and must be changed. You may need to consult your network administrator to get the correct values. Enter the appropriate IP address, mask and gateway information to configure this KMV-3901/3911 within your Ethernet network.

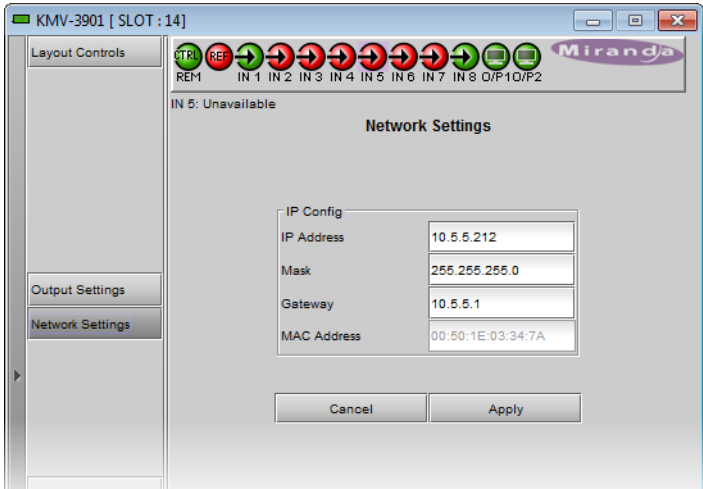

Notes

- These settings apply to the rear-panel Ethernet port of the KMV-3901/3911 itself; *not* to the Ethernet ports at the back of the Densité controller card.
- The MAC Address is a hard-wired attribute of the KMV-3901/3911 card, and is not configurable; the information is presented here for information only.

Click **Apply** to set these values into the card, or **Cancel** to leave the original values unchanged.

Alarm Configuration Panel

This panel allows the alarm reporting of the KMV-3901/3911 to be configured. When you click the **Alarm config.** button, the panel opens as a separate window, which can be resized if needed.

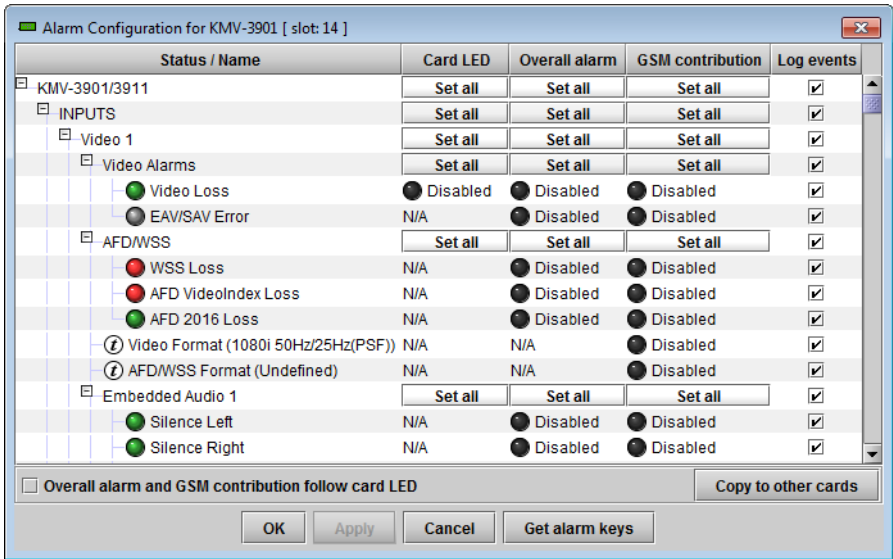

Status/Name

The **Status/Name** column lists all the alarms reported by this KMV-3901/3911 multiviewer. Next to each alarm name, an icon shows the alarm's current status.

Card LED, Overall alarm and GSM contribution

The **Card LED**, **Overall alarm** and **GSM contribution** columns contain lists that allow you to set the level of contribution of each individual alarm to the alarm named in the column heading.

Card LED This column allows you to configure the behavior of the KMV-3901/3911's card-edge status LED.

Overall alarm This column allows you to configure the contribution of each individual alarm to the *overall alarm* associated with this card. Indicators for the overall alarm appear in the upper left corner of the control panel windows, and at the bottom of the **Status/Name** column.

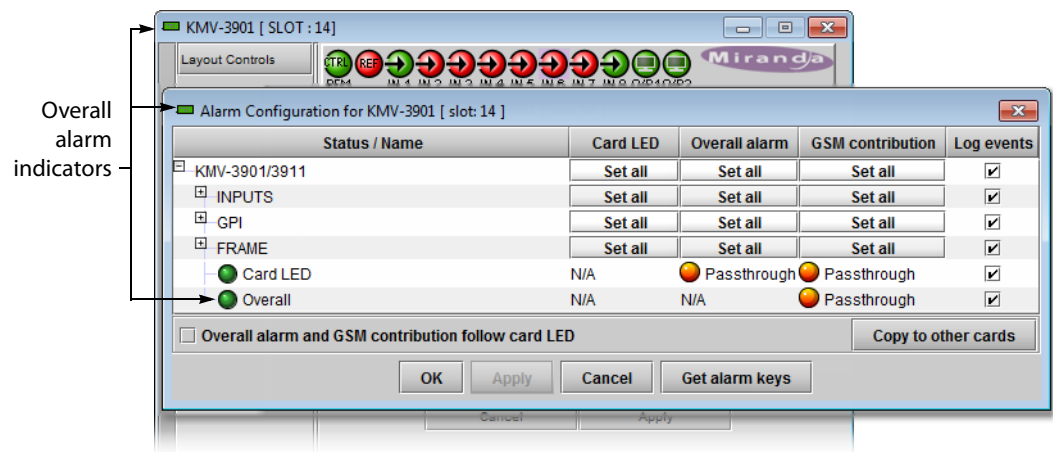

GSM contribution This column allows you to configure the contribution of each individual alarm to the GSM alarm status associated with this card. The GSM is a dynamic register of all iControl system alarms, and is also an alarm provider for external applications. The possible values for the GSM contribution are related to the overall alarm contribution:

- If the overall alarm contribution is set to **Disabled**, then the GSM alarm contribution can be set to any available value.
- If the overall alarm contribution is set to any level other than disabled, then the GSM contribution follows the overall alarm.

Alternatively, select the **Overall alarm and GSM contribution follow card LED** check box, to have the same contribution in all three contexts for the corresponding individual alarm.

Note: N/A means the alarm is not user-configurable.

The lists may contain some or all of the following options:

- Disabled The alarm makes no contribution (black icon)
- Minor The alarm is of minor importance (yellow icon)
- Major The alarm is of major importance (orange icon)
- Critical The alarm is of critical importance (red icon)
- Passthrough The alarm exists but has no effect (used for text and composite alarms)

TIP

Click one of the **Set all** buttons beside a section heading to assign the same level to all alarms in that section of the column at once.

iControl maintains a log of alarm events associated with the card. The log is useful for troubleshooting and identifying event sequences. Select in the **Log events** check box to enable logging of alarm events for an individual alarm.

At the bottom of the window are several other controls.

Overall alarm and GSM contribution follow card LED

Select the check box to force the overall alarm and GSM contribution to be identical to the Card LED status:

- All Overall alarms for which there is a Card LED alarm will be forced to match the Card LED alarm.
- All Overall Alarms for which there is no Card LED alarm will be Disabled.

A message prompts you to confirm the action, since it will result in changes to the configuration window that cannot readily be undone.

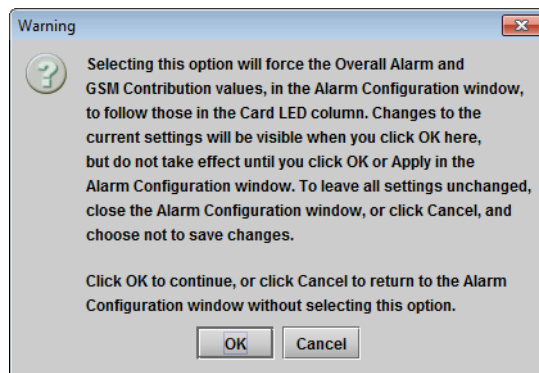

Copy to other cards

Click **Copy to other cards** to open a window that allows the alarm configuration set for this card to be copied into another KMV-3901/3911 card. Select one or more destination cards from the list in the window by selecting the corresponding check boxes, or all of them by selecting the **All** check box.

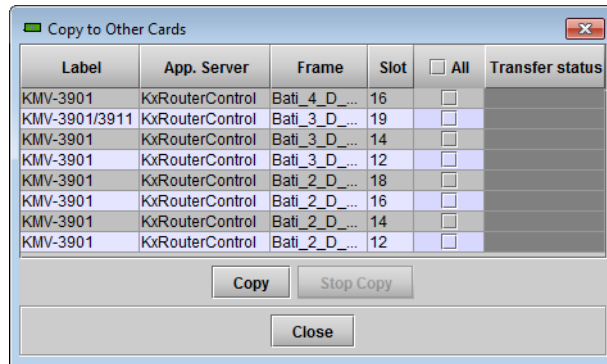

Get alarm keys

Click **Get alarm keys** to save a file containing a list of all alarms on this card and their current values, along with an Alarm Key for each. The alarm keys are useful for system integration and troubleshooting. The file is saved in CSV format.

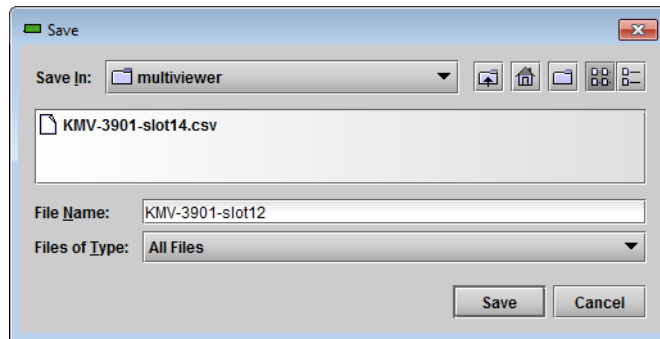

OK, Apply, Cancel

- Click **OK** to accept the settings and close the window once the card confirms that there are no errors.
- Click **Apply** to accept the settings, but leave the window open.
- Click **Cancel** to close the window without applying any changes, and leave the previous settings intact.

Status Panel

This panel reports on the status of the eight video input ports, with a status icon and text description of the format for each. Status of each of the eight GPI inputs and two GPI outputs is also reported, as *Open* or *Closed*. System status is reported at the bottom of the panel:

- **Reference:** status icon and text description
- **FAN:** status of the on-card cooling fan
- **Software version:** text description

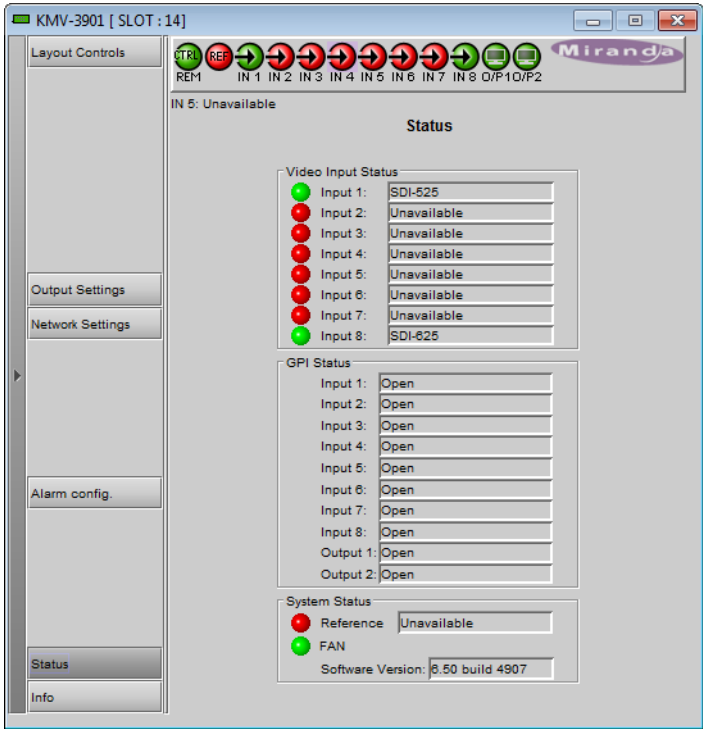

Info Panel

When the KMV-3901/3911 is included in an iControl environment, certain information about the card may be made available to the iControl system. In the boxes with a white background, you can type labels and comments that will make this card easier to identify in a complex setup.



Label Type a label to identify this KMV-3901/3911 when it appears in iControl applications.

Short label Type the shorter label that iControl uses in some cases (8 characters).

Source ID Type a descriptive name for this KMV-3901/3911.

Comments Type any desired text.

The remaining boxes show manufacturing information about this card.

Three buttons give access to additional information and controls:

Details Reports the firmware version, service version, and panel version for this card.

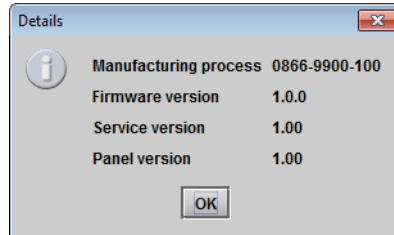

Advanced Shows the Miranda Long ID for this card. The Long ID is the address of this KMV-3901/3911 in the iControl network.

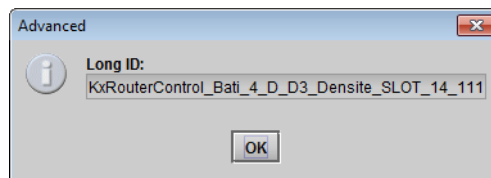

Remote system administration Opens the **Joining Locators** window, which lists remote lookup services to which this KMV-3901/3911 is registered.

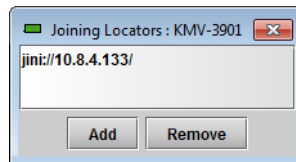

- Click **Add** to force the iControl service for this KMV-3901/3911 to register itself on a lookup service, by using the following syntax in the **Input** window:
`jini://<ip_address>`
where <ip_address> is the IP address of the server running the lookup service.
- Select one of the services listed in the window by clicking on it, and then click **Remove** to remove it from the list.

3 Specifications

Video Inputs

Connector	BNC
-----------	-----

SD-SDI

Signal	SMPTE 259M-C (270 Mbps), SMPTE 272M-1994
Formats	525 and 625
Return loss	> 15 dB up to 270 MHz
Jitter	< 0.2 UI
Cable length	250 m (820 ft) (Belden 1694A)

HD-SDI

Signal	SMPTE 292M-C (1.485, 1.485/1.001 Gbps), SMPTE 272M-1994
Formats	720p24, 720p25, 720p29.97, 720p50, 720p59.94 1080i50, 1080i59.94 1080PsF23.98, 1080PsF24, 1080PsF25, 1080PsF29.97 1080p23.98, 1080p24, 1080p25, 1080p29.97 Note: The Kaleido-X software does not distinguish between 1080PsF25 and 1080i50, and neither between 1080PsF29.97 and 1080i59.94. Both 1080PsF25 and 1080i50 are reported as 1080i50, and both 1080PsF29.97 and 1080i59.94 are reported as 1080i59.94, on the monitor wall and in XAdmin's Status and Options page.
Return loss	> 15 dB up to 1.5 GHz
Jitter	< 0.2 UI
Cable length	100 m (328 ft) (Belden 1694A)

3G-SDI

Signal	SMPTE 424M-2006 (2.97, 2.97/1.001 Gbps)
Formats	1080p50 (level A only) 1080p59.94 (level A only)
Return loss	> 10 dB up to 2.97 GHz

3G-SDI (continued)

Jitter	< 0.3 UI
Cable length	100 m (328 ft) (Belden 1694A) Note: If you wish to use the HD-SDI <i>monitoring outputs</i> (see page 26) and configure them for a 1080p format, then the multiviewer supports a maximum cable length of 85 m (279 feet) <i>at the video inputs</i> . Refer to “Configuring the HD-SDI Monitoring Output Format” in the “Setting Up Rooms” chapter of the Kaleido-X User’s Manual, for more information.

Graphic converted to HD-SDI from KXI-DVI-Bridge

Signal	SMPTE 292M-C (1.485, 1.485/1.001 Gbps)
Formats	1024 × 768 @ 60 (XGA) 1280 × 1024 @ 60 (SXGA) 1366 × 768 or 1368 × 768 @ 60 (WXGA) 1680 × 1050 @ 60 (WSXGA+) 1600 × 1200 @ 60 (UXGA)
Cable length	100 m (328 ft) (Belden 1694A)

Mosaic Outputs

HDMI outputs (2)

Signal	HDMI V1.3
Format	1280 × 1024 up to 1920 × 1200p configurable Supported refresh rates: 50 Hz and 59.94 Hz Refer to the table on page 16 for a list of supported formats.
Cable length	15 feet
Connector	HDMI type connector
Signal path	8 bits output

HD-SDI monitoring outputs (2)

Signal	4:2:2 SMPTE 292M-C (1.5 Gbps), SMPTE 424M
Formats	720p50, 720p59.94 1080i50, 1080i59.94 1080p50 (level A only), 1080p59.94 (level A only) Note: If you configure an HD-SDI monitoring output for a 1080p format (see page 6), then the multiviewer supports a maximum cable length of 85 m (279 feet) <i>at the video inputs</i> . Refer to “Configuring the HD-SDI Monitoring Output Format” in the “Setting Up Rooms” chapter of the Kaleido-X User’s Manual, for more information.

HD-SDI monitoring outputs (2) (continued)

Audio	SMPTE 299M (limited to one pair, embedded on group 1, pair 1)
Cable length	100 m (328 feet) for 3G or HD, 256 m (840 feet) for SD (Belden 1694A)
Alignment jitter (100 KHz)	< 0.2 UI
Connector	DIN 1.0/2.3

Reference

Internal	Universal Reference from the Densité frame Note: If your housing frame is referenced, then all KMV-3901/3911 cards within the frame must have their output heads configured with a refresh rate that matches the reference signal's refresh rate.
----------	--

GPI I/O

GPI inputs (8)

Description	Contact closure to GND
Pull-up voltage	3.3 Volts
Source current	30 μ A when input shorted
Low-level activation	0.8 Volts max
Over voltage	24 Volts max
Connector	Terminal block interface PCB via DB-26

GPI outputs (2)

Description	Contact closure to GND
Signal	Open collector 5 to 12 VDC
Contact closure current	50 mA max
Reverse voltage	-15 Volts max
Reverse current	-50 mA max
V out low	0.6 Volts at 1.5mA
Connector	Terminal block interface PCB via DB-26

Communication

Ethernet (1)

Connector	RJ-45
-----------	-------

Serial port (1)

Signal	RS-422 (SMPTE 207M, EBU-3245)
Connector	Terminal block interface PCB via DB-26

Video Processing Performance

Signal path	8-bit YCbCr to 24-bit RGB
Processing delay	~ 1 field in genlock mode; 1 - 2 fields in non-genlock mode

Audio Processing Performance

Quantization	20-24 bits
Sampling	48 kHz
THD+N	80 dB
SNR	98 dB

Electrical

Power consumption	24W max
-------------------	---------

KMV-3901/3911 Local Control Panel



KMV-3901/3911 user interface (local menu structure)

```

INPUT STATUS      1 {FORMAT}**
                  2 {FORMAT}**
                  3 {FORMAT}**
                  4 {FORMAT}**
                  5 {FORMAT}**
                  6 {FORMAT}**
                  7 {FORMAT}**
                  8 {FORMAT}**

{CARD VERSION}**
RESOLUTION      HEAD1      {List of resolutions;* = current}**
                  HEAD2      {List of resolutions;* = current}**

{LINK STATE}**
GPIO STATUS     GPI INPUTS  LINE 1 {STATE}**
                                      LINE 2 {STATE}**
                                      LINE 3 {STATE}**
                                      LINE 4 {STATE}**
                                      LINE 5 {STATE}**
                                      LINE 6 {STATE}**
                                      LINE 7 {STATE}**
                                      LINE 8 {STATE}**
                                      GPI OUTPUTS LINE 1 {STATE}**
                                      LINE 2 {STATE}**

{FAN STATUS}**
NETWORK SETTINGS IP ADDRESS EDIT  ###.###.###.###
                  NETMASK EDIT    ###.###.###.###
                  DEFAULT GW EDIT  ###.###.###.###
                  {MAC ADDRESS}**
    
```

* All KMV-3901/3911 cards within a housing frame must have their output heads configured with the same refresh rate. If your frame is referenced, then the heads' refresh rate must also match the reference signal's refresh rate.

** Parameters shown here in braces {} will display the actual value of the item and not the text shown above.



Miranda Technical Support

For technical assistance, please contact the Miranda Technical Support center nearest you:

Americas

Office hours: 9:00 a.m. – 9:00 p.m. (EST)
Telephone: 1-800-224-7882
Fax: +1 514 335 1614
E-mail: support@miranda.com

Asia

Office hours: 9:00 a.m. – 5:00 p.m. (GMT+8)
Telephone: +852 2539 6987
Fax: +852 2539 0804
E-mail: asiatech@miranda.com

Europe, Middle East, Africa, UK

Office hours: 9:00 a.m. – 6:00 p.m. (GMT)
Telephone: +44 118 952 3444
Fax: +44 118 952 3401
E-mail: eurotech@miranda.com

China

Telephone: +86 10 5873 1814
E-mail: asiatech@miranda.com

France

Office hours: 9:00 a.m. – 5:00 p.m. (GMT+1)
Telephone: +33 1 55 86 87 88
Fax: +33 1 55 86 00 29
E-mail: eurotech@miranda.com

EMERGENCY After Hours (Global)

Toll Free: 1-800-224-7882 (US and Canada)
Telephone: +1 514 333 1772

Corporate Head Office

Miranda Technologies
3499 Douglas-B.-Floreani, St-Laurent, Quebec, Canada H4S 2C6
Telephone: +1 514 333 1772
Fax: +1 514 333 9828
Web: www.miranda.com