

# Trinix

## Back-Up Power Supplies



### Installation and Service Manual

Software Version 3.3.1

**KEMA Quality**

# CERTIFICATE

Certificate Number: 510040.001

The Quality System of:

## **Grass Valley USA, LLC and its Grass Valley Affiliates**

Headquarters:

**400 Providence Mine Road  
Nevada City, CA 95945  
United States**

**15655 SW Greystone Ct.  
Beaverton, OR 97006  
United States**

**Brunnenweg 9  
D-64331 Weiterstadt  
Germany**

**Kapittelweg 10  
4827 HG Breda  
The Netherlands**

**2300 So. Decker Lake Blvd.  
Salt Lake City, UT 84119  
United States**

Including its implementation, meets the requirements of the standard:

## **ISO 9001:2008**

Scope:

The design, manufacture and support of video and audio hardware and software products and related systems.

This Certificate is valid until: June 14, 2012  
This Certificate is valid as of: December 23, 2010  
Certified for the first time: June 14, 2000



H. Pierre Sallé  
President  
KEMA-Registered Quality

The method of operation for quality certification is defined in the KEMA General Terms And Conditions For Quality And Environmental Management Systems Certifications. Integral publication of this certificate is allowed.

**KEMA-Registered Quality, Inc.**  
4377 County Line Road  
Chalfont, PA 18914  
Ph: (215)997-4519  
Fax: (215)997-3809  
CRT 001 042108

Accredited By:  
ANAB



a  **DEKRA** company



# Trinix

Back-Up Power Supplies

Installation and Service Manual

Software Version 3.3.1

# Contacting Grass Valley

<b>International Support Centers</b>	<b>France 24 x 7</b>	+800 8080 2020 or +33 1 48 25 20 20	<b>United States/Canada 24 x 7</b>	+1 800 547 8949 or +1 530 478 4148
<b>Local Support Centers (available during normal business hours)</b>	<b>Asia</b>	<b>Hong Kong, Taiwan, Korea, Macau:</b> +852 2531 3058 <b>Indian Subcontinent:</b> +91 22 24933476 <b>Southeast Asia/Malaysia:</b> +603 7805 3884 <b>Southeast Asia/Singapore:</b> +65 6379 1313 <b>China:</b> +861 0660 159 450 <b>Japan:</b> +81 3 5484 6868		
		<b>Australia and New Zealand:</b> +61 1300 721 495	<b>Central/South America:</b> +55 11 5509 3443	
		<b>Middle East:</b> +971 4 299 64 40 <b>Near East and Africa:</b> +800 8080 2020 or +33 1 48 25 20 20		
	<b>Europe</b>	<b>Belarus, Russia, Tadzikistan, Ukraine, Uzbekistan:</b> +7 095 2580924 225 <b>Switzerland:</b> +41 1 487 80 02 <b>S. Europe/Italy-Roma:</b> +39 06 87 20 35 28 <b>-Milan:</b> +39 02 48 41 46 58 <b>S. Europe/Spain:</b> +34 91 512 03 50 <b>Benelux/Belgium:</b> +32 (0) 2 334 90 30 <b>Benelux/Netherlands:</b> +31 (0) 35 62 38 42 1 <b>N. Europe:</b> +45 45 96 88 70 <b>Germany, Austria, Eastern Europe:</b> +49 6150 104 444 <b>UK, Ireland, Israel:</b> +44 118 923 0499		

Copyright © Grass Valley USA, LLC. All rights reserved.

This product may be covered by one or more U.S. and foreign patents.

## Grass Valley Web Site

The [www.grassvalley.com](http://www.grassvalley.com) web site offers the following:

**Online User Documentation** — Current versions of product catalogs, brochures, data sheets, ordering guides, planning guides, manuals, and release notes in .pdf format can be downloaded.

**FAQ Database** — Solutions to problems and troubleshooting efforts can be found by searching our Frequently Asked Questions (FAQ) database.

**Software Downloads** — Download software updates, drivers, and patches.



## END-OF-LIFE PRODUCT RECYCLING NOTICE

Grass Valley's innovation and excellence in product design also extends to the programs we've established to manage the recycling of our products. Grass Valley has developed a comprehensive end-of-life product take back program for recycle or disposal of end-of-life products. Our program meets the requirements of the European Union's WEEE Directive, the United States Environmental Protection Agency, and U.S. state and local agencies.

Grass Valley's end-of-life product take back program assures proper disposal by use of Best Available Technology. This program accepts any Grass Valley branded equipment. Upon request, a Certificate of Recycling or a Certificate of Destruction, depending on the ultimate disposition of the product, can be sent to the requester.

Grass Valley will be responsible for all costs associated with recycling and disposal, including freight. However, you are responsible for the removal of the equipment from your facility and packing the equipment to make it ready for pickup.



For further information on the Grass Valley product take back system please contact Grass Valley at + 800 80 80 20 20 or +33 1 48 25 20 20 from most other countries. In the U.S. and Canada please call 800-547-8949, and ask to be connected to the EH&S Department. Additional information concerning the program can be found at: [www.grassvalley.com/about/environmental-policy](http://www.grassvalley.com/about/environmental-policy)

001187401

# Contents

<b>Preface</b> .....	7
About This Manual .....	7
Additional Documentation .....	7
<b>Safety Summary</b>	
Safety Terms and Symbols .....	9
Terms in This Manual .....	9
Terms on the Product .....	9
Symbols on the Product .....	10
Warnings .....	10
Cautions .....	11
<b>Regulatory Notices</b>	
Certifications and Compliances .....	21
FCC Emission Control .....	21
Canadian EMC Notice of Compliance .....	21
EN55022 Class A Warning .....	21
Canadian Certified Power Cords .....	22
Canadian Certified AC Adapter .....	22
Laser Compliance .....	22
Laser Safety Requirements .....	22
Laser Safety .....	22
FCC Emission Limits .....	23
Certification .....	23
<b>ESD Protection</b>	
Recommended ESD Guidelines .....	25
Sources of ESD and Risks .....	26
Grounding Requirements for Personnel .....	27
<b>Section 1 — Introduction</b> .....	29
Overview .....	29
DV-33128 .....	31
DV-33256 .....	31
DV-33512 .....	31
Materials Supplied .....	32
Equipment Required .....	32
Software Required .....	34
Specifications .....	34
Ordering Information .....	35
<b>Section 2 — Installation for NXT and Newer Frames</b> .....	37
Lineage Power Supply Alarms .....	38
Reference .....	39

<b>Section 3 — Installation for Legacy Frames</b> .....	41
Tools Required .....	41
Installation Procedure - DV-33128 and DV-33256 Units .....	43
Installation Procedure - DV-33512 Units .....	47
<b>Appendix 4 — Specifications</b> .....	51
Mechanical .....	51
Environmental .....	51
Air Intake/Exhaust Locations .....	51
Electrical .....	52

# *Preface*

## **About This Manual**

This manual provides installation instructions for the Trinix backup power supplies.

## **Additional Documentation**

Trinix Installation and Service manual, includes planning and installation instructions.

Documents can also be downloaded from our web site or ordered in print form by contacting Technical Support (see [page 4](#)).





# Safety Summary

Read and follow the important safety information below, noting especially those instructions related to risk of fire, electric shock or injury to persons. Additional specific warnings not listed here may be found throughout the manual.

**WARNING** Any instructions in this manual that require opening the equipment cover or enclosure are for use by qualified service personnel only. To reduce the risk of electric shock, do not perform any servicing other than that contained in the operating instructions unless you are qualified to do so.

## Safety Terms and Symbols

### Terms in This Manual

Safety-related statements may appear in this manual in the following form:

**WARNING** Warning statements identify conditions or practices that may result in personal injury or loss of life.

**CAUTION** Caution statements identify conditions or practices that may result in damage to equipment or other property, or which may cause equipment crucial to your business environment to become temporarily non-operational.

### Terms on the Product

The following terms may appear on the product:

**DANGER** — A personal injury hazard is immediately accessible as you read the marking.

**WARNING** — A personal injury hazard exists but is not immediately accessible as you read the marking.

**CAUTION** — A hazard to property, product, and other equipment is present.

## Symbols on the Product

The following symbols may appear on the product:



Indicates that dangerous high voltage is present within the equipment enclosure that may be of sufficient magnitude to constitute a risk of electric shock.



Indicates that user, operator or service technician should refer to product manual(s) for important operating, maintenance, or service instructions.



This is a prompt to note fuse rating when replacing fuse(s). The fuse referenced in the text must be replaced with one having the ratings indicated.



Identifies a protective grounding terminal which must be connected to earth ground prior to making any other equipment connections.



Identifies an external protective grounding terminal which may be connected to earth ground as a supplement to an internal grounding terminal.



Indicates that static sensitive components are present which may be damaged by electrostatic discharge. Use anti-static procedures, equipment and surfaces during servicing.

## Warnings

The following warning statements identify conditions or practices that can result in personal injury or loss of life:

**Dangerous voltage or current may be present** — Disconnect power and remove battery (if applicable) before removing protective panels, soldering, or replacing components.

**Do not service alone** — Do not internally service this product unless another person capable of rendering first aid and resuscitation is present.

**Remove jewelry** — Prior to servicing, remove jewelry such as rings, watches, and other metallic objects.

**Avoid exposed circuitry** — Do not touch exposed connections, components or circuitry when power is present.

**Use proper power cord** — Use only the power cord supplied or specified for this product.

**Ground product** — Connect the grounding conductor of the power cord to earth ground.

**Operate only with covers and enclosure panels in place** — Do not operate this product when covers or enclosure panels are removed.

**Use correct fuse** — Use only the fuse type and rating specified for this product.

**Use only in dry environment** — Do not operate in wet or damp conditions.

**Use only in non-explosive environment** — Do not operate this product in an explosive atmosphere.

**High leakage current may be present** — Earth connection of product is essential before connecting power.

**Dual power supplies may be present** — Be certain to plug each power supply cord into a separate branch circuit employing a separate service ground. Disconnect both power supply cords prior to servicing.

**Double pole neutral fusing** — Disconnect mains power prior to servicing.

**Use proper lift points** — Do not use door latches to lift or move equipment.

**Avoid mechanical hazards** — Allow all rotating devices to come to a stop before servicing.

## Cautions

The following caution statements identify conditions or practices that can result in damage to equipment or other property:

**Use correct power source** — Do not operate this product from a power source that applies more than the voltage specified for the product.

**Use correct voltage setting** — If this product lacks auto-ranging power supplies, before applying power ensure that the each power supply is set to match the power source.

**Provide proper ventilation** — To prevent product overheating, provide equipment ventilation in accordance with installation instructions.

**Use anti-static procedures** — Static sensitive components are present which may be damaged by electrostatic discharge. Use anti-static procedures, equipment and surfaces during servicing.

**Do not operate with suspected equipment failure** — If you suspect product damage or equipment failure, have the equipment inspected by qualified service personnel.

**Ensure mains disconnect** — If mains switch is not provided, the power cord(s) of this equipment provide the means of disconnection. The socket outlet must be installed near the equipment and must be easily accessible. Verify that all mains power is disconnected before installing or removing power supplies and/or options.

**Route cable properly** — Route power cords and other cables so that they are not likely to be damaged. Properly support heavy cable bundles to avoid connector damage.

**Use correct power supply cords** — Power cords for this equipment, if provided, meet all North American electrical codes. Operation of this equipment at voltages exceeding 130 VAC requires power supply cords which comply with NEMA configurations. International power cords, if provided, have the approval of the country of use.

**Use correct replacement battery** — This product may contain batteries. To reduce the risk of explosion, check polarity and replace only with the same or equivalent type recommended by manufacturer. Dispose of used batteries according to the manufacturer's instructions.

**Troubleshoot only to board level** — Circuit boards in this product are densely populated with surface mount technology (SMT) components and application specific integrated circuits (ASICs). As a result, circuit board repair at the component level is very difficult in the field, if not impossible. For warranty compliance, do not troubleshoot systems beyond the board level.

# Sicherheit – Überblick

Lesen und befolgen Sie die wichtigen Sicherheitsinformationen dieses Abschnitts. Beachten Sie insbesondere die Anweisungen bezüglich Brand-, Stromschlag- und Verletzungsgefahren. Weitere spezifische, hier nicht aufgeführte Warnungen finden Sie im gesamten Handbuch.

**WARNUNG** Alle Anweisungen in diesem Handbuch, die das Abnehmen der Geräteabdeckung oder des Gerätegehäuses erfordern, dürfen nur von qualifiziertem Servicepersonal ausgeführt werden. Um die Stromschlaggefahr zu verringern, führen Sie keine Wartungsarbeiten außer den in den Bedienungsanleitungen genannten Arbeiten aus, es sei denn, Sie besitzen die entsprechende Qualifikationen für diese Arbeiten.

## Sicherheit – Begriffe und Symbole

### In diesem Handbuch verwendete Begriffe

Sicherheitsrelevante Hinweise können in diesem Handbuch in der folgenden Form auftauchen:

**WARNUNG** Warnungen weisen auf Situationen oder Vorgehensweisen hin, die Verletzungs- oder Lebensgefahr bergen.

**VORSICHT** Vorsichtshinweise weisen auf Situationen oder Vorgehensweisen hin, die zu Schäden an Ausrüstungskomponenten oder anderen Gegenständen oder zum zeitweisen Ausfall wichtiger Komponenten in der Arbeitsumgebung führen können.

### Hinweise am Produkt

Die folgenden Hinweise können sich am Produkt befinden:

**GEFAHR** — Wenn Sie diesen Begriff lesen, besteht ein unmittelbares Verletzungsrisiko.

**WARNUNG** — Wenn Sie diesen Begriff lesen, besteht ein mittelbares Verletzungsrisiko.

**VORSICHT** — Es besteht ein Risiko für Objekte in der Umgebung, den Mixer selbst oder andere Ausrüstungskomponenten.

## Symbole am Produkt

Die folgenden Symbole können sich am Produkt befinden:



Weist auf eine gefährliche Hochspannung im Gerätegehäuse hin, die stark genug sein kann, um eine Stromschlaggefahr darzustellen.



Weist darauf hin, dass der Benutzer, Bediener oder Servicetechniker wichtige Bedienungs-, Wartungs- oder Serviceanweisungen in den Produkthandbüchern lesen sollte.

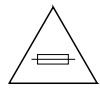

Dies ist eine Aufforderung, beim Wechsel von Sicherungen auf deren Nennwert zu achten. Die im Text angegebene Sicherung muss durch eine Sicherung ersetzt werden, die die angegebenen Nennwerte besitzt.



Weist auf eine Schutzerdungsklemme hin, die mit dem Erdungskontakt verbunden werden muss, bevor weitere Ausrüstungskomponenten angeschlossen werden.



Weist auf eine externe Schutzerdungsklemme hin, die als Ergänzung zu einem internen Erdungskontakt an die Erde angeschlossen werden kann.



Weist darauf hin, dass es statisch empfindliche Komponenten gibt, die durch eine elektrostatische Entladung beschädigt werden können. Verwenden Sie antistatische Prozeduren, Ausrüstung und Oberflächen während der Wartung.

## Warnungen

Die folgenden Warnungen weisen auf Bedingungen oder Vorgehensweisen hin, die Verletzungs- oder Lebensgefahr bergen:

**Gefährliche Spannungen oder Ströme** — Schalten Sie den Strom ab, und entfernen Sie ggf. die Batterie, bevor sie Schutzabdeckungen abnehmen, löten oder Komponenten austauschen.

**Servicearbeiten nicht alleine ausführen** — Führen Sie interne Servicearbeiten nur aus, wenn eine weitere Person anwesend ist, die erste Hilfe leisten und Wiederbelebungsmaßnahmen einleiten kann.

**Schmuck abnehmen** — Legen Sie vor Servicearbeiten Schmuck wie Ringe, Uhren und andere metallische Objekte ab.

**Keine offen liegenden Leiter berühren** — Berühren Sie bei eingeschalteter Stromzufuhr keine offen liegenden Leitungen, Komponenten oder Schaltungen.

**Richtiges Netzkabel verwenden** — Verwenden Sie nur das mitgelieferte Netzkabel oder ein Netzkabel, das den Spezifikationen für dieses Produkt entspricht.

**Gerät erden** — Schließen Sie den Erdleiter des Netzkabels an den Erdungskontakt an.

**Gerät nur mit angebrachten Abdeckungen und Gehäuseseiten betreiben** — Schalten Sie dieses Gerät nicht ein, wenn die Abdeckungen oder Gehäuseseiten entfernt wurden.

**Richtige Sicherung verwenden** — Verwenden Sie nur Sicherungen, deren Typ und Nennwert den Spezifikationen für dieses Produkt entsprechen.

**Gerät nur in trockener Umgebung verwenden** — Betreiben Sie das Gerät nicht in nassen oder feuchten Umgebungen.

**Gerät nur verwenden, wenn keine Explosionsgefahr besteht** — Verwenden Sie dieses Produkt nur in Umgebungen, in denen keinerlei Explosionsgefahr besteht.

**Hohe Kriechströme** — Das Gerät muss vor dem Einschalten unbedingt geerdet werden.

**Doppelte Spannungsversorgung kann vorhanden sein** — Schließen Sie die beiden Anschlußkabel an getrennte Stromkreise an. Vor Servicearbeiten sind beide Anschlußkabel vom Netz zu trennen.

**Zweipolige, neutrale Sicherung** — Schalten Sie den Netzstrom ab, bevor Sie mit den Servicearbeiten beginnen.

**Fassen Sie das Gerät beim Transport richtig an** — Halten Sie das Gerät beim Transport nicht an Türen oder anderen beweglichen Teilen fest.

**Gefahr durch mechanische Teile** — Warten Sie, bis der Lüfter vollständig zum Halt gekommen ist, bevor Sie mit den Servicearbeiten beginnen.

## Vorsicht

Die folgenden Vorsichtshinweise weisen auf Bedingungen oder Vorgehensweisen hin, die zu Schäden an Ausrüstungskomponenten oder anderen Gegenständen führen können:

**Gerät nicht öffnen** — Durch das unbefugte Öffnen wird die Garantie ungültig.

**Richtige Spannungsquelle verwenden** — Betreiben Sie das Gerät nicht an einer Spannungsquelle, die eine höhere Spannung liefert als in den Spezifikationen für dieses Produkt angegeben.

**Gerät ausreichend belüften** — Um eine Überhitzung des Geräts zu vermeiden, müssen die Ausrüstungskomponenten entsprechend den Installationsanweisungen belüftet werden. Legen Sie kein Papier unter das Gerät. Es könnte die Belüftung behindern. Platzieren Sie das Gerät auf einer ebenen Oberfläche.

**Antistatische Vorkehrungen treffen** — Es gibt statisch empfindliche Komponenten, die durch eine elektrostatische Entladung beschädigt werden können. Verwenden Sie antistatische Prozeduren, Ausrüstung und Oberflächen während der Wartung.

**CF-Karte nicht mit einem PC verwenden** — Die CF-Karte ist speziell formatiert. Die auf der CF-Karte gespeicherte Software könnte gelöscht werden.

**Gerät nicht bei eventuellem Ausrüstungsfehler betreiben** — Wenn Sie einen Produktschaden oder Ausrüstungsfehler vermuten, lassen Sie die Komponente von einem qualifizierten Servicetechniker untersuchen.

**Kabel richtig verlegen** — Verlegen Sie Netzkabel und andere Kabel so, dass Sie nicht beschädigt werden. Stützen Sie schwere Kabelbündel ordnungsgemäß ab, damit die Anschlüsse nicht beschädigt werden.

**Richtige Netzkabel verwenden** — Wenn Netzkabel mitgeliefert wurden, erfüllen diese alle nationalen elektrischen Normen. Der Betrieb dieses Geräts mit Spannungen über 130 V AC erfordert Netzkabel, die NEMA-Konfigurationen entsprechen. Wenn internationale Netzkabel mitgeliefert wurden, sind diese für das Verwendungsland zugelassen.

**Richtige Ersatzbatterie verwenden** — Dieses Gerät enthält eine Batterie. Um die Explosionsgefahr zu verringern, prüfen Sie die Polarität und tauschen die Batterie nur gegen eine Batterie desselben Typs oder eines gleichwertigen, vom Hersteller empfohlenen Typs aus. Entsorgen Sie gebrauchte Batterien entsprechend den Anweisungen des Batterieherstellers.

Das Gerät enthält keine Teile, die vom Benutzer gewartet werden können. Wenden Sie sich bei Problemen bitte an den nächsten Händler.



# Consignes de sécurité

Il est recommandé de lire, de bien comprendre et surtout de respecter les informations relatives à la sécurité qui sont exposées ci-après, notamment les consignes destinées à prévenir les risques d'incendie, les décharges électriques et les blessures aux personnes. Les avertissements complémentaires, qui ne sont pas nécessairement repris ci-dessous, mais présents dans toutes les sections du manuel, sont également à prendre en considération.

**AVERTISSEMENT** Toutes les instructions présentes dans ce manuel qui concernent l'ouverture des capots ou des logements de cet équipement sont destinées exclusivement à des membres qualifiés du personnel de maintenance. Afin de diminuer les risques de décharges électriques, ne procédez à aucune intervention d'entretien autre que celles contenues dans le manuel de l'utilisateur, à moins que vous ne soyez habilité pour le faire.

## Consignes et symboles de sécurité

### Termes utilisés dans ce manuel

Les consignes de sécurité présentées dans ce manuel peuvent apparaître sous les formes suivantes:

**AVERTISSEMENT** Les avertissements signalent des conditions ou des pratiques susceptibles d'occasionner des blessures graves, voire même fatales.

**ATTENTION** Les mises en garde signalent des conditions ou des pratiques susceptibles d'occasionner un endommagement à l'équipement ou aux installations, ou de rendre l'équipement temporairement non opérationnel, ce qui peut porter préjudice à vos activités.

### Signalétique apposée sur le produit

La signalétique suivante peut être apposée sur le produit:

**DANGER** — risque de danger imminent pour l'utilisateur.

**AVERTISSEMENT** — Risque de danger non imminent pour l'utilisateur.

**MISE EN GARDE** — Risque d'endommagement du produit, des installations ou des autres équipements.

## Symboles apposés sur le produit

Les symboles suivants peut être apposés sur le produit:



Signale la présence d'une tension élevée et dangereuse dans le boîtier de l'équipement ; cette tension peut être suffisante pour constituer un risque de décharge électrique.



Signale que l'utilisateur, l'opérateur ou le technicien de maintenance doit faire référence au(x) manuel(s) pour prendre connaissance des instructions d'utilisation, de maintenance ou d'entretien.



Il s'agit d'une invite à prendre note du calibre du fusible lors du remplacement de ce dernier. Le fusible auquel il est fait référence dans le texte doit être remplacé par un fusible du même calibre.



Identifie une borne de protection de mise à la masse qui doit être raccordée correctement avant de procéder au raccordement des autres équipements.



Identifie une borne de protection de mise à la masse qui peut être connectée en tant que borne de mise à la masse supplémentaire.



Signale la présence de composants sensibles à l'électricité statique et qui sont susceptibles d'être endommagés par une décharge électrostatique. Utilisez des procédures, des équipements et des surfaces antistatiques durant les interventions d'entretien.

## Avertissements

Les avertissements suivants signalent des conditions ou des pratiques susceptibles d'occasionner des blessures graves, voire même fatales:

**Présence possible de tensions ou de courants dangereux** — Mettez hors tension, débranchez et retirez la pile (le cas échéant) avant de déposer les couvercles de protection, de défaire une soudure ou de remplacer des composants.

**Ne procédez pas seul à une intervention d'entretien** — Ne réalisez pas une intervention d'entretien interne sur ce produit si une personne n'est pas présente pour fournir les premiers soins en cas d'accident.

**Retirez tous vos bijoux** — Avant de procéder à une intervention d'entretien, retirez tous vos bijoux, notamment les bagues, la montre ou tout autre objet métallique.

**Évitez tout contact avec les circuits exposés** — Évitez tout contact avec les connexions, les composants ou les circuits exposés s'ils sont sous tension.

**Utilisez le cordon d'alimentation approprié** — Utilisez exclusivement le cordon d'alimentation fourni avec ce produit ou spécifié pour ce produit.

**Raccordez le produit à la masse** — Raccordez le conducteur de masse du cordon d'alimentation à la borne de masse de la prise secteur.

**Utilisez le produit lorsque les couvercles et les capots sont en place** — N'utilisez pas ce produit si les couvercles et les capots sont déposés.

**Utilisez le bon fusible** — Utilisez exclusivement un fusible du type et du calibre spécifiés pour ce produit.

**Utilisez ce produit exclusivement dans un environnement sec** — N'utilisez pas ce produit dans un environnement humide.

**Utilisez ce produit exclusivement dans un environnement non explosible** — N'utilisez pas ce produit dans un environnement dont l'atmosphère est explosible.

**Présence possible de courants de fuite** — Un raccordement à la masse est indispensable avant la mise sous tension.

**Deux alimentations peuvent être présentes dans l'équipement** — Assurez vous que chaque cordon d'alimentation est raccordé à des circuits de terre séparés. Débranchez les deux cordons d'alimentation avant toute intervention.

**Fusion neutre bipolaire** — Débranchez l'alimentation principale avant de procéder à une intervention d'entretien.

**Utilisez les points de levage appropriés** — Ne pas utiliser les verrous de la porte pour lever ou déplacer l'équipement.

**Évitez les dangers mécaniques** — Laissez le ventilateur s'arrêter avant de procéder à une intervention d'entretien.

## Mises en garde

Les mises en garde suivantes signalent les conditions et les pratiques susceptibles d'occasionner des dommages à l'équipement et aux installations:

**N'ouvrez pas l'appareil** — Toute ouverture prohibée de l'appareil aura pour effet d'annuler la garantie.

**Utilisez la source d'alimentation adéquate** — Ne branchez pas ce produit à une source d'alimentation qui utilise une tension supérieure à la tension nominale spécifiée pour ce produit.

**Assurez une ventilation adéquate** — Pour éviter toute surchauffe du produit, assurez une ventilation de l'équipement conformément aux instructions d'installation. Ne déposez aucun document sous l'appareil — ils peuvent gêner la ventilation. Placez l'appareil sur une surface plane.

**Utilisez des procédures antistatiques** - Les composants sensibles à l'électricité statique présents dans l'équipement sont susceptibles d'être endommagés par une décharge électrostatique. Utilisez des procédures, des équipements et des surfaces antistatiques durant les interventions d'entretien.

**N'utilisez pas la carte CF avec un PC** — La carte CF a été spécialement formatée. Le logiciel enregistré sur la carte CF risque d'être effacé.

**N'utilisez pas l'équipement si un dysfonctionnement est suspecté** — Si vous suspectez un dysfonctionnement du produit, faites inspecter celui-ci par un membre qualifié du personnel d'entretien.

**Acheminez les câbles correctement** — Acheminez les câbles d'alimentation et les autres câbles de manière à ce qu'ils ne risquent pas d'être endommagés. Supportez correctement les enroulements de câbles afin de ne pas endommager les connecteurs.

**Utilisez les cordons d'alimentation adéquats** — Les cordons d'alimentation de cet équipement, s'ils sont fournis, satisfont aux exigences de toutes les réglementations régionales. L'utilisation de cet équipement à des tensions dépassant les 130 V en c.a. requiert des cordons d'alimentation qui satisfont aux exigences des configurations NEMA. Les cordons internationaux, s'ils sont fournis, ont reçu l'approbation du pays dans lequel l'équipement est utilisé.

**Utilisez une pile de remplacement adéquate** — Ce produit renferme une pile. Pour réduire le risque d'explosion, vérifiez la polarité et ne remplacez la pile que par une pile du même type, recommandée par le fabricant. Mettez les piles usagées au rebut conformément aux instructions du fabricant des piles.

Cette unité ne contient aucune partie qui peut faire l'objet d'un entretien par l'utilisateur. Si un problème survient, veuillez contacter votre distributeur local.

# *Regulatory Notices*

## **Certifications and Compliances**

### **FCC Emission Control**

This equipment has been tested and found to comply with the limits for a Class A digital device, pursuant to Part 15 of the FCC Rules. These limits are designed to provide reasonable protection against harmful interference when the equipment is operated in a commercial environment. This equipment generates, uses, and can radiate radio frequency energy and, if not installed and used in accordance with the instruction manual, may cause harmful interference to radio communications. Operation of this equipment in a residential area is likely to cause harmful interference in which case the user will be required to correct the interference at his own expense. Changes or modifications not expressly approved by Grass Valley Group can affect emission compliance and could void the user's authority to operate this equipment.

### **Canadian EMC Notice of Compliance**

This digital apparatus does not exceed the Class A limits for radio noise emissions from digital apparatus set out in the Radio Interference Regulations of the Canadian Department of Communications.

Le présent appareil numérique n'émet pas de bruits radioélectriques dépassant les limites applicables aux appareils numériques de la classe A prescrites dans le Règlement sur le brouillage radioélectrique édicté par le ministère des Communications du Canada.

### **EN55022 Class A Warning**

In a domestic environment, products that comply with Class A may cause radio interference in which case the user may be required to take adequate measures.

## Canadian Certified Power Cords

Canadian approval includes the products and power cords appropriate for use in the North America power network. All other power cords supplied are approved for the country of use.

## Canadian Certified AC Adapter

Canadian approval includes the AC adapters appropriate for use in the North America power network. All other AC adapters supplied are approved for the country of use.

## Laser Compliance

### Laser Safety Requirements

The device used in this product is a Class 1 certified laser product. Operating this product outside specifications or altering from its original design may result in hazardous radiation exposure, and may be considered an act of modifying or new manufacturing of a laser product under U.S. regulations contained in 21CFR Chapter 1, subchapter J or CENELEC regulations in HD 482 S1. People performing such an act are required by law to recertify and reidentify this product in accordance with provisions of 21CFR subchapter J for distribution within the U.S.A., and in accordance with CENELEC HD 482 S1 for distribution within countries using the IEC 825 standard.

### Laser Safety

Laser safety in the United States is regulated by the Center for Devices and Radiological Health (CDRH). The laser safety regulations are published in the "Laser Product Performance Standard," Code of Federal Regulation (CFR), Title 21, Subchapter J.

The international Electrotechnical Commission (IEC) Standard 825, "Radiation of Laser Products, Equipment Classification, Requirements and User's Guide," governs laser products outside the United States. Europe and member nations of the European Free trade Association fall under the jurisdiction of the Comite European de Normalization Electrotechnique (CENELEC).

For the CDRH: The radiant power is detected through a 7 mm aperture at a distance of 200 mm from the source focused through a lens with a focal length of 100 mm.

For IEC compliance: The radiant power is detected through a 7 mm aperture at a distance of 100 mm from the source focused through a lens with a focal length of 100 mm.

## FCC Emission Limits

This device complies with Part 15 of the FCC Rules. Operation is subject to the following two conditions: (1) This device may not cause harmful interference, and (2) this device must accept any interference received, including interference that may cause undesirable operation. This device has been tested and found to comply with FCC Part 15 Class B limits for a digital device when tested with a representative laser-based fiber optical system that complies with ANSI X3T11 Fiber Channel Standard.

## Certification

Category	Standard	Designed/tested for compliance with:
Safety	UL1950	Safety of Information Technology Equipment, including Electrical Business Equipment (Second edition, 1993).
	IEC 950	Safety of Information Technology Equipment, including Electrical Business Equipment (Second edition, 1991).
	CAN/CSA C22.2, No. 950-93	Safety of Information Technology Equipment, including Electrical Business Equipment.
	EN60950	Safety of Information Technology Equipment, including Electrical Business Equipment.





# ESD Protection

Electronics today are more susceptible to electrostatic discharge (ESD) damage than older equipment. Damage to equipment can occur by ESD fields that are smaller than you can feel. Implementing the information in this section will help you protect the investment that you have made in purchasing Grass Valley equipment. This section contains Grass Valley's recommended ESD guidelines that should be followed when handling electrostatic discharge sensitive (ESDS) items. These minimal recommendations are based on the information in the [Sources of ESD and Risks](#) area. The information in [Grounding Requirements for Personnel on page 27](#) is provided to assist you in selecting an appropriate grounding method.

## Recommended ESD Guidelines

Follow these guidelines when handling Grass Valley equipment:

- Only trained personnel that are connected to a grounding system should handle ESDS items.
- Do not open any protective bag, box, or special shipping packaging until you have been grounded.

**Note** When a Personal Grounding strap is unavailable, as an absolute minimum, touch a metal object that is touching the floor (for example, a table, frame, or rack) to discharge any static energy before touching an ESDS item.

- Open the anti-static packaging by slitting any existing adhesive tapes. Do not tear the tapes off.
- Remove the ESDS item by holding it by its edges or by a metal panel.
- Do not touch the components of an ESDS item unless it is absolutely necessary to configure or repair the item.
- Keep the ESDS work area clear of all nonessential items such as coffee cups, pens, wrappers and personal items as these items can discharge static. If you need to set an ESDS item down, place it on an anti-static mat or on the anti-static packaging.

## Sources of ESD and Risks

The following information identifies possible sources of electrostatic discharge and can be used to help establish an ESD policy.

### Personnel

One of the largest sources of static is personnel. The static can be released from a person's clothing and shoes.

### Environment

The environment includes the humidity and floors in a work area. The humidity level must be controlled and should not be allowed to fluctuate over a broad range. Relative humidity (RH) is a major part in determining the level of static that is being generated. For example, at 10% - 20% RH a person walking across a carpeted floor can develop 35kV; yet when the relative humidity is increased to 70% - 80%, the person can only generate 1.5kV.

Static is generated as personnel move (or as equipment is moved) across a floor's surface. Carpeted and waxed vinyl floors contribute to static build up.

### Work Surfaces

Painted or vinyl-covered tables, chairs, conveyor belts, racks, carts, anodized surfaces, plexiglass covers, and shelving are all static generators.

### Equipment

Any equipment commonly found in an ESD work area, such as solder guns, heat guns, blowers, etc., should be grounded.

### Materials

Plastic work holders, foam, plastic tote boxes, pens, packaging containers and other items commonly found at workstations can generate static electricity.

## Grounding Requirements for Personnel

The information in this section is provided to assist you in selecting a grounding method. This information is taken from ANSI/ESD S20.20-2007 (Revision of ANSI/ESD S20.20-1999).

Table 1. Product Qualification

Personnel Grounding Technical Requirement	Test Method	Required Limits
Wrist Strap System*	ANSI/ESD S1.1 (Section 5.11)	$< 3.5 \times 10^7$ ohm
Flooring / Footwear System – Method 1	ANSI/ESD STM97.1	$< 3.5 \times 10^7$ ohm
Flooring / Footwear System – Method 2 (both required)	ANSI/ESD STM97.1 ANSI/ESD STM97.2	$< 10^9$ ohm $< 100$ V

Product qualification is normally conducted during the initial selection of ESD control products and materials. Any of the following methods can be used: product specification review, independent laboratory evaluation, or internal laboratory evaluation.

Table 2. Compliance Verification

Personnel Grounding Technical Requirement	Test Method	Required Limits
Wrist Strap System*	ESD TR53 Wrist Strap Section	$< 3.5 \times 10^7$ ohm
Flooring / Footwear System – Method 1	ESD TR53 Flooring Section and ESD TR53 Footwear Section	$< 3.5 \times 10^7$ ohm
Flooring / Footwear System – Method 2 (both required)	ESD TR53 Flooring Section and ESD TR53 Footwear Section	$< 1.0 \times 10^9$ ohm

\* For situations where an ESD garment is used as part of the wrist strap grounding path, the total system resistance, including the person, garment, and grounding cord, must be less than  $3.5 \times 10^7$  ohm.



# Introduction

## Overview

The instructions are for the original Trinix DV-33128, DV-33256 and DV-33512 routing switchers.

For Installation instructions for the newer NXT or Asymmetrical frames, see *Installation for NXT and Newer Frames* [on page 37](#). For more information about these frames see the *Trinix Installation and Service manual*.

The TRX-PS-BU series of products, sometimes referred to as “tertiary” power supplies, are designed to supplement the Trinix DV-33128, DV-33256 and DV-33512 internal power supplies to provide increased backup protection. Two packages are available:

- TRX-PS-BU1200 - 1 ea. 1200 watt module mounted in a 1 RU frame
- TRX-PS-BU2400 - 2 ea. 1200 watt modules mounted in a 1 RU frame

These packages can be used in various combinations with Trinix DV-33128, DV-33256, and DV-33512 routers. This flexibility is shown in [Figure 1](#) on the next page.

The power supplies are bussed together so that the power load is shared at all times. If one power supply fails, the remaining power supplies on that bus will continue to provide power. The failed power supply should be replaced as soon as possible.

Figure 1. TRX-PS-BU Trinix Backup Power Supplies

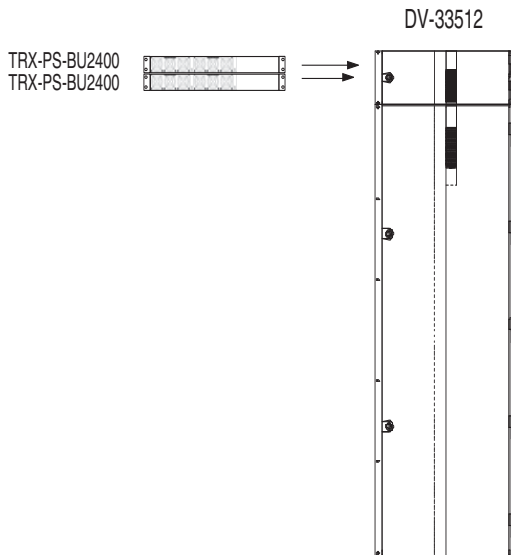
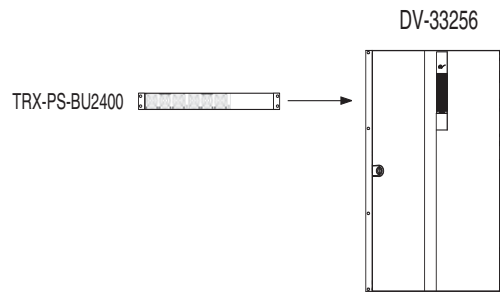
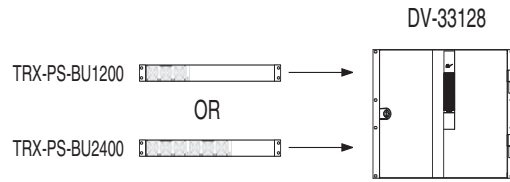

## DV-33128

For DV-33128 routers, installation of one **TRX-PS-BU1200** will provide a total of three on-line power supplies: two internally-mounted supplies and one supply mounted in the external chassis. Any one of these three supplies can fully power the DV-33128 router.

Installation of one **TRX-PS-BU2400** will provide a total of four on-line power supplies: two internally-mounted supplies and two supplies mounted in the external chassis. Any one of these four supplies can fully power the DV-33128 router.

## DV-33256

For DV-33256 routers, installation of one **TRX-PS-BU2400** will provide a total of four on-line power supplies: two internally-mounted supplies and two supplies mounted in the external chassis. Any one of these four supplies can fully power the DV-33256 router.

## DV-33512

For DV-33512 routers, installation of **two TRX-PS-BU2400s** will provide a total of eight on-line power supplies divided into two groups:

- One group consists of internal supplies A and B and the two supplies in one of the external chassis (total of four supplies). The four supplies in this group power half the boards in the router. Any one of the four supplies can provide all needed power to these boards.
- The opposite group consists of internal supplies C and D and the two supplies in the other external chassis (total of four supplies). The four supplies in this group power half the boards in the router. Any one of the four supplies can provide all needed power to these boards

## Materials Supplied

Each of the two packages includes the following items:

*Table 1. Contents of Each Package.*

Quantity	Description	Notes
1	Power cable assembly, power supply rack to Trinix, 10 ft. (3 m).	
1, 2	AC mains power cord kit (type varies per destination country)	
1, 2	Power supply, 1200 W 48 VDC	
1	Power supply rack	
1 or 2	Blank panels for power supply rack	
2	Small pattern 6 nut	spare
2	Split lock no. 6 washer	spare
2	4-40 x 1/4 SEMS screw	spare
4	6-32 x 1/4 SEMS screw	spare
2	1/4-20 UNC nut	spare
1	Internal lock washer	spare
1	No. 6 flat washer	spare
1	Manual	Part no. 071844303

## Equipment Required

TRX-PS-BU2400 installations:

1.75 in. (1 RU) rack space in Trinix or adjacent rack, and  
2 AC power outlets, 1200 W each (total 2400 W)

For DV-33512 ONLY:

TRX-PS-33500 chassis with ORing diodes installed.

**Note** Early versions of the TRX-PS33500 chassis did not include ORing diodes for the redundant DC inputs. The installation of this back-up power supply requires the TRX-PS-33500 chassis with the ORing diodes. To verify that your TRX-PS-33500 chassis has the required ORing diodes, see [Figure 2](#) and compare to your TRX-PS33500. The ORing diodes can be viewed through the rear panel grill work of the TRX-33500 chassis. The diode covers about 1 square inches and is clearly visible from the rear. Contact Grass Valley if your power supply does not have the ORing diode installed.



Figure 2. The TRX-PS33500 With Required ORing Diodes Highlighted

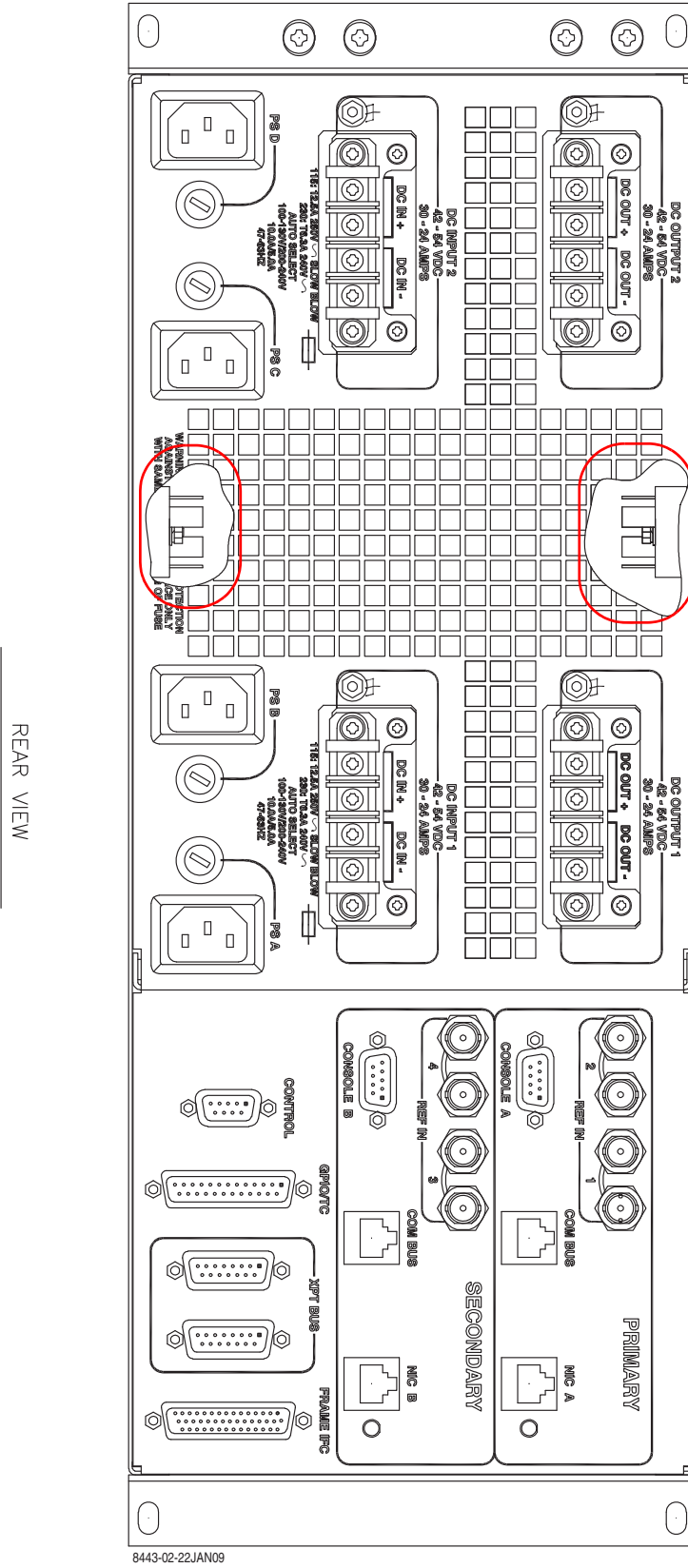

8443-02-22JAN09

## Software Required

No software changes are required.

## Specifications

For mechanical, environmental, and electrical specifications, see [Appendix A](#).

Trinix does not monitor the back-up power supplies. Operation of the external-back-up power supplies must be checked by monitoring the power supply status LEDs and Output voltage on the DC-Input connectors. Check the voltage on the DC input connector only at installation to verify proper connections. After that, you can verify operation with the LEDs on the front panel of the power supply.

# Ordering Information

Table 2. Power Supply Item and Description

TRX-PS-BU1200	POWER SUPPLY 1200 W 1 RU STAND ALONE DC OUTPUT
TRX-PS-BU2400	POWER SUPPLY 2400 W 1 RU STAND ALONE DC OUTPUT
TRX-PS-BU2400-47V	POWER SUPPLY 2400 W - 47 V 1 RU STAND ALONE DC OUTPUT



# Installation for NXT and Newer Frames

The newer NXT and Asymmetrical frames, have improved and simplified the power connections to a single connection.

To connect redundant power to the newer frames:

1. Attach the cable to either DC INPUT A or B ([Figure 1](#)).
2. Tighten the connector ring by turning it to the right.

Figure 1. Example of the NXT and Asymmetrical Frame - Connection Location

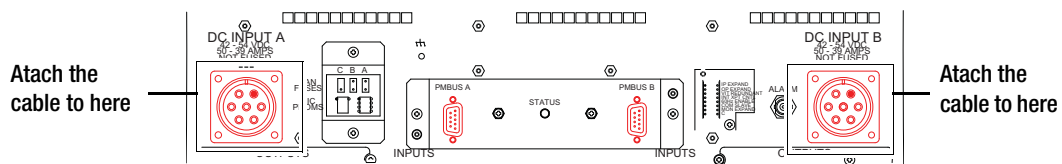

For more information about these frames see the *Trinix Installation and Service manual*.

## Lineage Power Supply Alarms

The Lineage PS modules have two known issues that may produce an alarm when the power is turned off:

- Removing the power supply and then re-inserting before the power supply's fans have stopped spinning.
- Cycling the power for short periods of time (approximately less than 10 Sec.) or a brief power failure.

The work around for each of these issues is described below.

**Note** These steps assume that the system is operational.

### Removing the Power Supply and Inserting Too Soon

When a power module is removed:

1. Wait until the module's fans have stopped spinning (approximately 10 sec.).
2. Re-Insert the module.

### Cycling the power for short periods of time or a Power Failure

When a power failure lasts between 1 to 10 seconds, the power supply may come back up in an alarm condition.

To correct the alarm condition, do one of the following:

#### Extract the power supply module

1. Extract the alarming power supply module.
2. Wait until the module's fans have stopped spinning (approximately 10 sec.).
3. Reinsert the power supply module.

#### Remove AC power to the System

1. Remove AC power to the system
2. Wait until the power supply module's fans have stopped spinning (approximately 10 sec.).
3. Reapply the AC power, simultaneously to all power supply modules.

For more information see Lineage's documentation for the CP1800-AC52 power supply.

## Reference

Page 5 of the the Linage manual, in the "hot Plug" section states:

When rapidly extracting and reinserting modules care should be taken to allow for discharging the internal bias supply so that a predictable restart could be achieved. The way to ensure that the circuit sufficiently discharges is to observe the spinning of the fans after an extraction. The unit should not be reinserted until the fans stop spinning.

Regarding hot-plug issues, it is possible to essentially lock up the processor during re-insertion if the Vcc of the processor is still decaying as the power supply is plugged in. That is why we request on the data sheet to refrain from re-inserting the supply until the fan stops spinning. This is a known issue that only occurs during a rapid reinsertion. No physical damage occurs, but a re-insertion is necessary.





# *Installation for Legacy Frames*

**CAUTION** Installation of this product on the DV-33128, DV33256, and DV33512 frames requires the connection of several 48 VDC power cables. The safest and recommended method to make these connections is to remove power to the Trinix, before making the connection. In other words, you must take the router and all associated signals off-line long enough to connect between six and fifteen cables to a terminal block(s), depending on the size of the router. If for some reason this connection can only be performed with power on, it must be made using special procedures and only by Grass Valley personnel.

## **Tools Required**

- The proper sized Phillips screwdrivers,
- Electrical tape,
- Cable tie wraps,
- Nut driver, size #P8 (1/4"),
- A light source

If powered down, you will need a Phillips screwdriver and nut driver (we need to tell them the size).

If powered up, electrical tape.

The light source may be helpful depending on the light available in the back of the rack.

Figure 1. Location of DV-33128 and DV-33256 Power Supply Connections

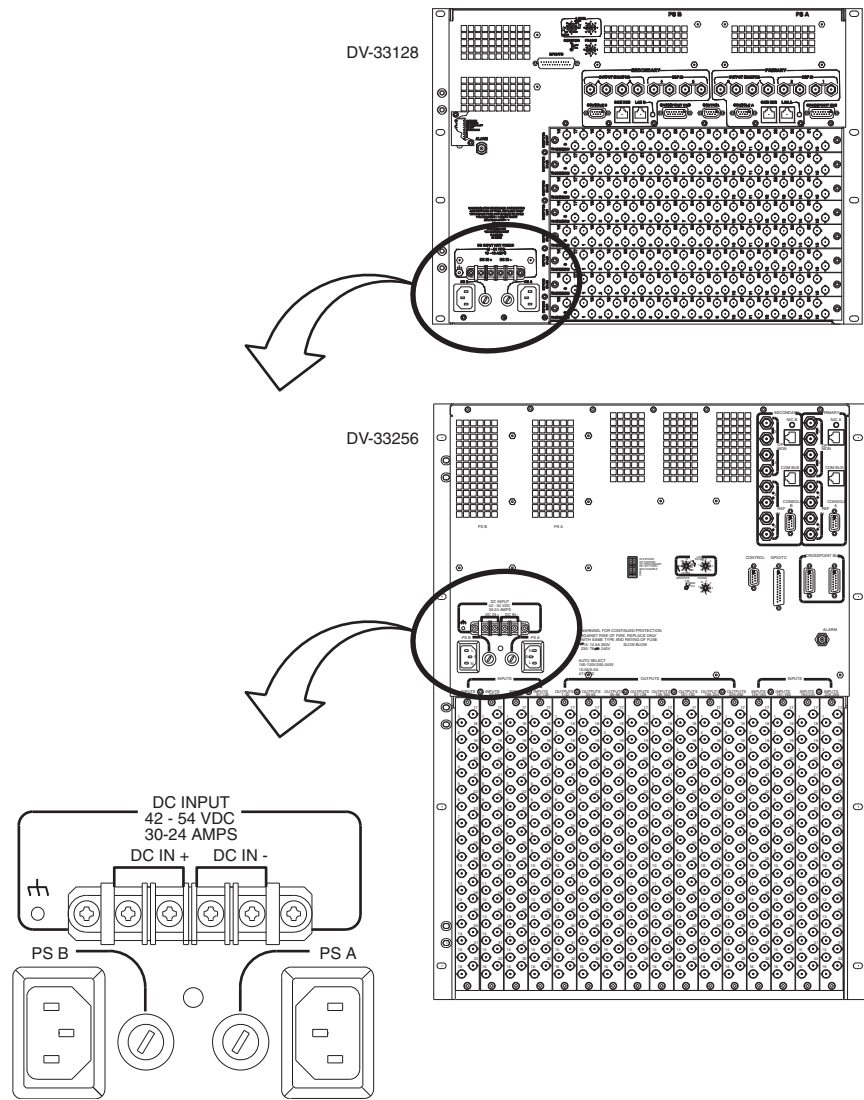

## Installation Procedure - DV-33128 and DV-33256 Units

1. Install the supplied 1RU Power supply rack-power supply frame:

- a. Install the external power supply frame in a suitable 19-inch equipment rack.

The frame is shipped with the DC cables already connected.

The power supply frame should be mounted in the same equipment rack as the Trinix, but it may be mounted in an adjacent rack if necessary. The cable provided for connection to the Trinix is approximately ten feet (3 m) long.

Leave 1RU rack space above and below the power supply for optimal cooling if extra rack space is available.

- b. Test the external supplies prior to connecting to the Trinix router. Temporarily apply electrical tape each of the DC output connectors (red, blue, white, yellow) to isolate them to prevent shorting out. Apply power to the external power supplies.
- c. Using a voltmeter, verify that the external frame's output voltage measures between 47 and 48.5 VDC.
- d. Unplug the external power supplies AC power cords.
- e. Unscrew the external supplies restraining screws and slide the supply out of the chassis 1 inch.

**CAUTION** The following step will interrupt all signals passing through the router until power is restored.

2. Proceed as follows:

- a. Power down the router by unplugging the AC cord of each of the internal power supplies.
- b. On the rear of the Trinix PS chassis, locate the "DC IN +" and "DC IN -" terminal blocks. See [Figure 2](#).

Figure 2. Power Connections Showing Reference Numbers Used for this Document

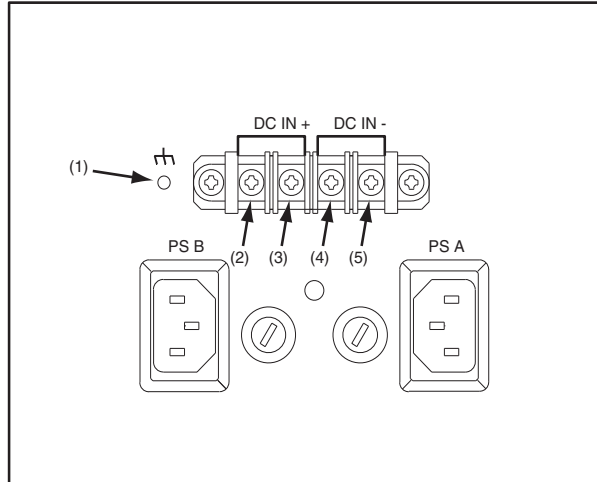

- c. Remove the "DC IN +" and "DC IN -" screws (2), (3), (4), and (5).
- d. Locate the DC power ground stud (1). Use a nut driver to remove one nut (only) and one washer (only) from the stud.
- e. Connect the supplied external power supply cables as shown in [Figure 3](#) and [Table 1](#).

Figure 3. DV-33128/256 External Power Supply Wiring (Partially Complete)

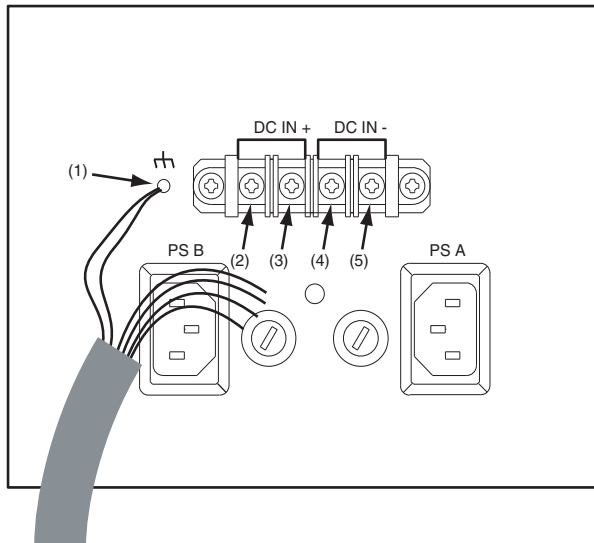

Table 1. External Power Supply Wiring (Complete)

Wire Color	Connect to Terminal
Yellow/green	(1)
Black	(1)
Red	(2)
Blue	(3)
White	(4)
Yellow	(5)

- f. All connections to the router itself are now done. Double check all wiring.
3. Connect the AC or DC power cords to the external power supplies.
4. At the front of the external power supply chassis, screw in each supply. Verify that the two LEDs on the front of each supply are green (AC good/DC good), and that the fans all rotate.
5. Restore power to the Trinix internal power supplies.
6. Check the DC voltage now being provided at the Trinix “DC In” connectors. Voltage should be between 47 and 48.5 VDC. If not, contact Grass Valley Technical Support.
7. Check the fail-over function of the new supply(s). This procedure should not cause any interruption to router operation. However, Grass Valley recommends that you perform this check when the consequences of possible signal interruption are at a minimum.
  - a. Pull the internal power supplies out a few inches. The router should remain powered up. Push the internal supplies back into position.
8. In some cases, the original Trinix system may have been supplied with a total of only one internal power supply. In this case, the SR/NR-33000’s sync card jumper JN2 must be moved to the “AC” position for the alarm system to operate properly.

**Note** For more information about this jumper, refer to the redundant power supply notes in the Installation section of the Trinix manual.

This completes the installation.

Figure 4. Location of DV-33512 Power Supply Connections

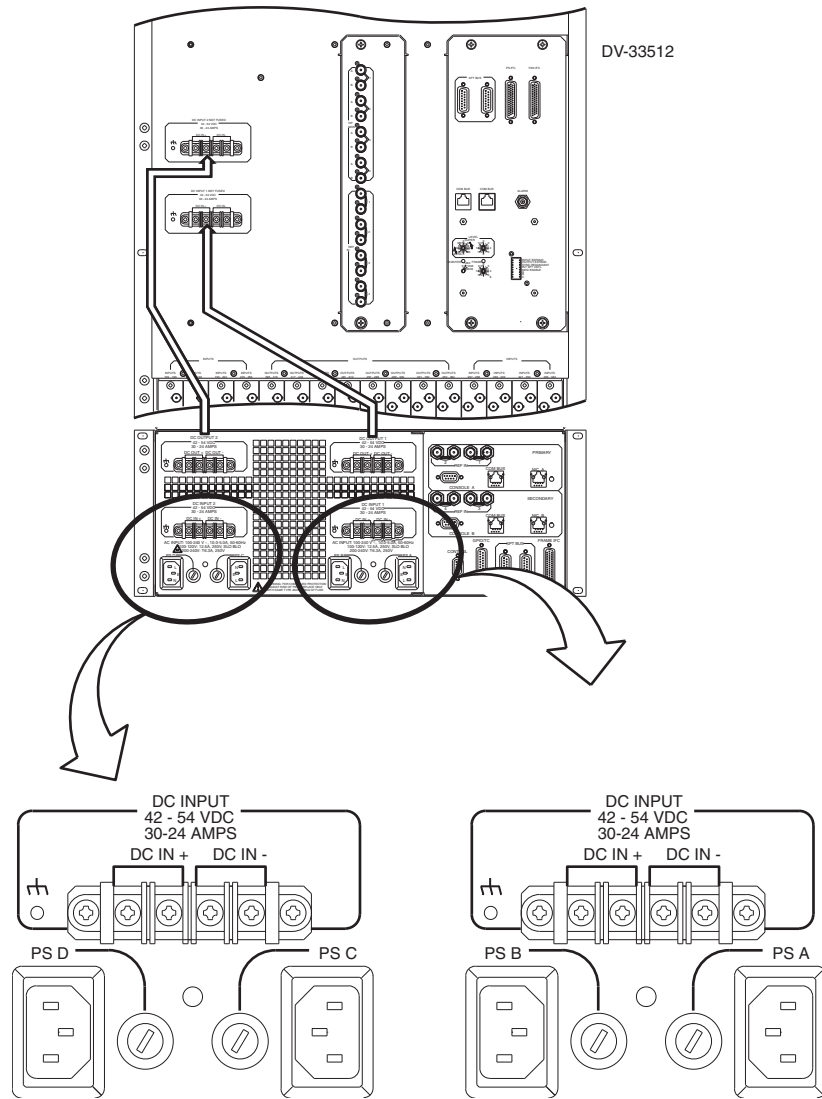

# Installation Procedure - DV-33512 Units

**Note** It is critical that the ORing diodes are present on the 512 PS frame. See the Note in the [Equipment Required](#) section.

1. 1R power supply frames:

- a. Install the external power supply frames in a suitable 19-inch equipment rack.

The frames are shipped with the DC cables already connected.

The power supply frames should be mounted in the same equipment rack as the Trinix, but they may be mounted in an adjacent rack if necessary. The cables provided for connection to the Trinix are approximately ten feet (3 m) long.

No special ventilation spacing is needed for these frames since the airflow is from front to back.

- b. Test the external supplies prior to connecting to the Trinix router. Temporarily apply electrical tape each of the DC output connectors (red, blue, white, yellow) to isolate them to prevent shorting out. Apply power to the external power supplies.
- c. Using a voltmeter, verify that the external frame's output voltage measures between 47 and 48.5 VDC. Contact Grass Valley Technical Support if the output voltage is not between this range.
- d. Unplug each of the external power supplies' AC power cords.
- e. Unscrew each of the external power supply's restraining screw and slide each supply out of the chassis 1 inch.

**CAUTION** The following steps will interrupt all signals passing through the router until power is restored.

2. Proceed as follows:

- a. Power down the router by unplugging the AC cord for each of the internal power supplies.
- b. On the rear of the Trinix PS chassis, locate the "DC IN +" and "DC IN -" terminal blocks. See [Figure 5](#).

**Note** The (1) reference is an extra ground check point. Currently it is not being used.

Figure 5. DV-33512 Power Supply Connectors Showing Reference Numbers Used in this Document

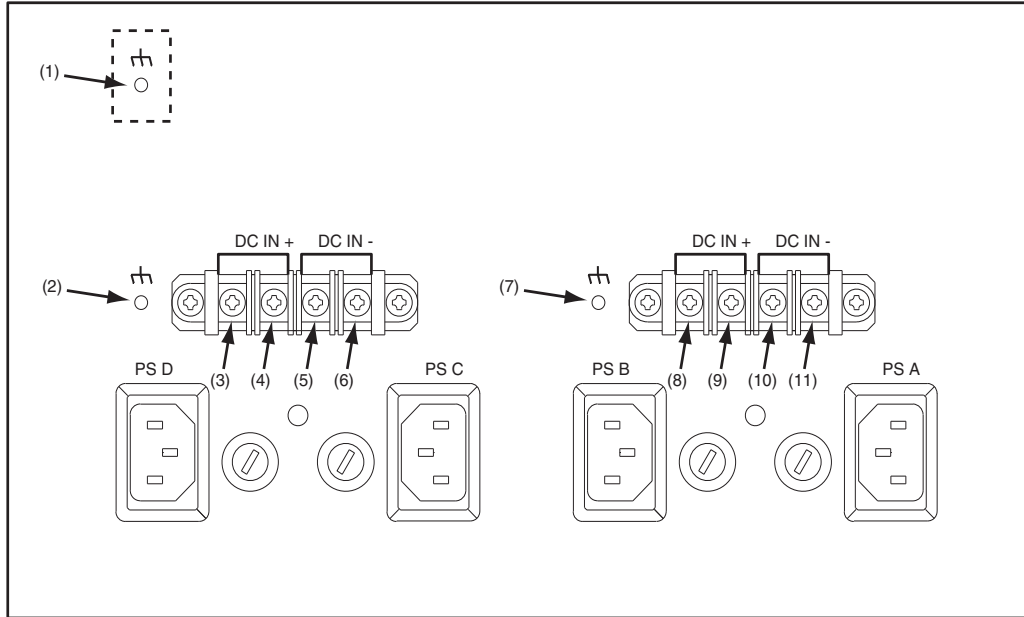

- c. Remove the “DC IN +” and “DC IN -” screws (3), (4), (5), (6), (8), (9), (10), and (11).
- d. Locate the two DC power ground studs (2) and (7). Use a nut driver to remove one nut (only) and one washer (only) from each stud.
- e. Connect the supplied jumper wires and external power supply cables as shown in [Figure 6](#) and [Table 2](#).

Figure 6. Jumper and External Power Supply Wiring (Partially Complete)

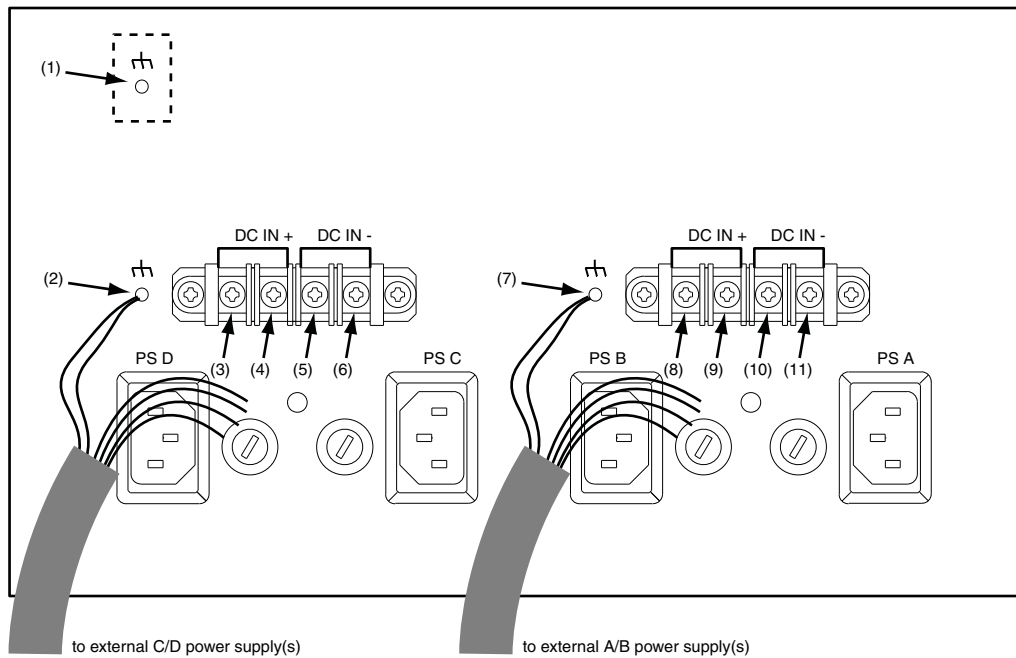



Table 2. Jumper and Power Cable Wiring (Complete)

Terminal	Power Cable
(2)	C/D yellow/green C/D black
(3)	C/D red
(4)	C/D blue
(5)	C/D white
(6)	C/D yellow
(7)	A/B yellow/green A/B black
(8)	A/B red
(9)	A/B blue
(10)	A/B white
(11)	A/B yellow

- f. All connections to the router itself are now done. Double check all wiring.
3. Connect the AC power cords for the external A/B power supplies and the external C/D power supplies.
4. At the front of the external power supplies chassis, screw in each external supply. Verify that the two LEDs on the front of each supply are green (AC good/DC good), and that the fans all rotate.
5. Restore power to the internal power supplies.
6. Check the DC voltage now being provided at the Trinix “DC In” connector(s). Voltage should be between 47 and 48.5 VDC. If not, contact Technical Support.
7. At an appropriate time, check the fail-over function of the new supplies. This procedure should not cause any interruption to router operation. However, Grass Valley recommends that you perform this check when the consequences of possible signal interruption are at a minimum.
  - First **make sure** that **both** external power supply frames are installed and powered on per the above procedure. Open the main chassis door. Open the Trinix power supply chassis and pull the A and B supplies out a few inches. The router should remain powered up. Replace the A and B supplies. Pull the C and D supplies; the router should remain powered. Replace the C and D supplies.
8. In some cases, the original system may have been supplied with a total of only two internal power supplies. In this case, the RP-33500 512 x 512 Rear Panel’s card jumper JN1 must now be moved to the “AC” position. This step ensures that the alarm system will operate properly.

**Note** For more information about this jumper, refer to the redundant power supply notes in the Installation section of the Trinix manual.

This completes the installation.

# Specifications

## Mechanical

Table 1. Mechanical Specifications

	Depth <sup>a</sup>	Width	Height	Weight <sup>b</sup>	Rack Units
TRX-PS-BU1200	11.56 in. / 294 mm	19.0 in. / 483 mm	1.75 in. / 44 mm	7.2 lb. / 3.2 kg	1
TRX-PS-BU2400	11.56 in. / 294 mm	19.0 in. / 483 mm	1.75 in. / 44 mm	10.3 lb. / 4.6 kg	1

<sup>a</sup> Allow a minimum of 6 in. (152 mm) of clear space at the rear of the MCP for proper cable clearance and air flow.

<sup>b</sup> All weights approximate.

## Environmental

Table 2.

Environmental Characteristics (operation with required forced air cooling)	
Operating temperature	32 to 104 degrees F (0 to 40 degrees C) ambient
Full specifications met	32 to 104 degrees F (0 to 40 degrees C)
Storage temperature	-40 to 185 F (-40 to +85 degrees C)

### Air Intake/Exhaust Locations

All modules draw cooling air through fans in the front. Warm air is exhausted through openings in the back. It is not necessary to leave open space above or below the chassis.

# Electrical

Table 3.

Output Power	1200 watts per module
Input voltage range	100 - 240 VAC
Input frequency	47 - 63 Hz
Hot-swap operation	Yes