

TRITON routing switcher

Analog Video Router 8x8

With Local Control Panel

Product model no. TTN-BVS-0808CP

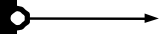

INSTALLATION MANUAL

MANUAL PART NO. 04-049745-002 Rev. 2

MARCH 04, 2003

the most watched worldwide

Headquarters

Thomson Broadcast Systems
17 rue du Petit Albi - BP 8244
95801 Cergy Pontoise Cedex
FRANCE

Thomson Broadcast and
Media Solutions, Inc.
P.O. Box 599000
Nevada City, CA 95959-7900
USA

Copyright 2003 Thomson Broadcast and Media Solutions, Inc. All rights reserved. Grass Valley, Jupiter, and Triton are trademarks of Thomson. Specifications subject to change without notice.

For customer service, please call (800) 547-8949. For comments or questions concerning this manual, please contact: Technical Publications Department, P.O. Box 30816, Salt Lake City, Utah 84130 USA. Phone: (801) 972-8000. Fax: (801) 977-1602. Email: SLCTechpubs@THmulti.com

Contents

Electromagnetic Radiation Notice	v
Hardware Warranty and Software License	vi
Parts and Service	vi
Revision history	vii
1 General	1
1.1 Specifications	1
1.2 Connection drawing	1
2 Power connection	2
3 Connecting the BVS-0808CP to your PC	2
3.1 Selection of router level	2
3.2 Pin-out of RS-232 connector	2
3.3 Maximum cable length	2
4 NCB connection	3
4.1 Several routers in one system	3
4.2 Connecting control panels	3
4.3 Pin-out and cable type	4
4.3.1 RJ45 connectors	4
4.3.2 5-pin DIN connectors	4
4.3.3 RJ45 to 5-pin DIN converter	5
4.4 Control bus structure	5
4.5 Maximum distance between NCB devices	5
4.6 Control Bus configuration notes	5
5 Router configuration	7
5.1 Router level	7
5.2 Router mode	8
5.3 Vertical interval trigger	9
5.4 Power up mode	10
5.5 Programming of restrictions	10
6 Connecting video signals to the BVS-0808CP	10
7 Control and connection of Triton systems, interface protocol	11
7.1 Important notes regarding the Triton Control Protocol	11
7.1.1 Binary Code	11
7.1.2 Echo	11
7.1.3 RS-422 Matrixes	11
7.1.4 Timeout	11
7.2 Basic principles	11

7.2.1	Example: A single unit with no NCB connected	11
7.2.2	Example: Several units connected by NCB	12
7.3	RS232	12
7.4	NCB	12
7.5	Commands	13
7.5.1	Audio crosspoint set	13
7.5.2	Audio crosspoint set acknowledge	13
7.5.3	Video crosspoint set	13
7.5.4	Video crosspoint set acknowledge	14
7.5.5	Crosspoint status request	14
8	Control panel operation	15
8.1	Front panel drawing	15
8.2	PANEL ENABLE button	15
8.3	V/A TOGGLE button	15
8.4	Operating crosspoints	15
8.5	TAKE function	15

Electromagnetic Radiation Notice

The following information is given to note compliance with the United States Government Federal Communications Commission (FCC) Rules (47 CFR Part 15) designed to limit interference to radio and TV reception. The ruling establishes measurement procedures and frequency criteria for Class A computing devices (commercial and industrial applications) with the following conduction and radiation limits:

CLASS A COMPUTING DEVICE: CONDUCTION LIMIT (Part 15.812)

<i>Frequency (MHz)</i>	<i>Maximum RF Line Voltage (uV)</i>
0.45 - 1.6	1000
1.6 - 30	3000

CLASS A COMPUTING DEVICE: RADIATION LIMIT (Section 15.810)

<i>Frequency (MHz)</i>	<i>Distance (meters)</i>	<i>Field Strength (uV/m)</i>
30 - 88	30	30
88 - 216	30	50
216 - 1000	30	70

The policy of Thomson is one of continual development and improvement. For that reason Thomson uses components and manufacturing techniques that provide the current state-of-the-art suppression of electromagnetic radiation. This equipment, in production before October 1, 1981, has not been tested to the above listed measurements. However, equipment such as this delivered after October 1, 1983 will have the measurements on record at the factory. Therefore, in compliance with the stated FCC Regulation, the following information is provided for the user:

NOTE

Interference to Radio Communications

This equipment generates, uses, and can radiate radio frequency energy and if not installed and used in accordance with the instruction manual, may cause interference to radio communications. As temporarily permitted by regulation it has not been tested for compliance with the limits for Class A computing devices pursuant to Subpart J of of Part 15 of FCC Rules, which are designed to provide reasonable protection against such interference. **Operation of this equipment in a residential area is likely to cause interference** in which case the user at his own expense will be required to take whatever measures may be required to correct the interference.

Hardware Warranty and Software License

Please contact your local Thomson representative for hardware warranty and software license information.

Parts and Service

Thomson maintains a full stock of replacement parts available for immediate shipment.

NORTH AMERICA PARTS AND SERVICE

Please call toll-free **1-800-547-8949**.

You will be switched automatically to the parts and service representative nearest you.

For email correspondence: broadcast-support@thmulti.com

Internet: <http://www.thomsongrassvalley.com>

INTERNATIONAL PARTS AND SERVICE

Contact your Thomson representative.

Revision history

Current revision of this document is the uppermost in the table below.

Revision	Replaces	Date	Change Description
2	1	04/03/03	Updated with the new Thomson/GVG design.
1	0	30/01/01	Corrected error in baud rate setting
0	-	10/10/00	Initial Revision

1 General

The BVS-0808CP is an 8x8 video router with vertical interval switching. This state of the art router provides high performance circuits in SMD technology for maximum system performance. The BVS-0808CP is designed for all demanding routing tasks in digital studio and broadcast environments. The built-in RS-232 interface allows the user to control the router via the Triton Router Control System PC software with many operational features. The control bus allows linking the unit to the BAS-0808 or BES-0808 audio router thus creating an 8x8 AFV router. Several units can be combined to form RGB, VGA or other matrix systems. One or several Triton remote control panels can control the BVS-0808CP as well.

Another unique feature of the Triton 8x8 series is the possibility to reconfigure the router via the configuration switch on the back plane to create several formats of routers:

8x8	Composite Video
4x4	Y/C (SVHS)
2x2	RGB/Sync

1.1 Specifications

Frequency response:	0-250MHz -3dB
Differential gain:	typ. 0.1% (3.58/4.43MHz)
Differential phase:	typ. 0.2° (3.58/4.43MHz)
Crosstalk:	< -55dB (3.58/4.43MHz)
Video S/N Ratio:	typ. 70dB
Bar tilt:	< 0.1%
Lum. Non-linearity:	< 0.1%
Number of inputs:	8, termination switchable
Number of outputs:	8
Impedance:	75 ohms
Return loss:	typ. 38dB
Max signal:	2 Vp-p
Coupling:	DC
DC offset:	typ. 5mV
Propagation delay:	5ns ± 1ns
Connector:	BNC
AC power:	External power supply 100 - 260 VAC
DC power:	±5V, connector DB9 male
Dimensions:	483 x 44 x 45 mm (19", 1RU)

1.2 Connection drawing

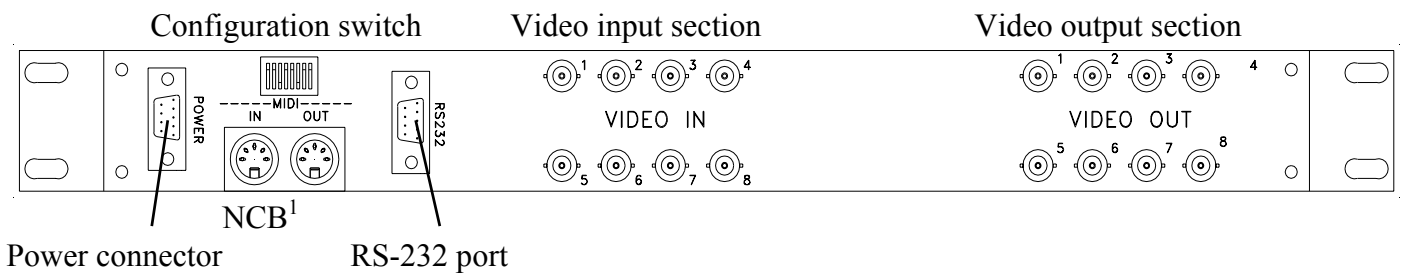

¹ Network Control Bus. The protocol of this bus is equal, and compatible to the MIDI bus protocol.

2 Power connection

Do not connect mains to the desktop power supply before connecting the power supply to the router.

Connect the DB9 female connector from the desktop power supply to the main unit. Tighten the screws to assure a proper contact. To connect mains to the desktop power supply you need a mains cord with IEC 320 connector.

The BVS-0808CP is normally delivered with the desktop power model **AC ±5V / 10W**. Upon customer request, BVS-0808CP can also be delivered with **DC ±5V / 30W**, which may be fed by a 36 – 72 VDC mains power source. A Frame mounted power supply solution is also available.

Please refer to the latest Triton Product Catalogue for power supply types, or call Thomson Grass Valley for this information.

If any third party power supply is used the BVS-0808CP router requires ±5V DC with a minimum current of 200mA. The following pin-out is used on the DB9 male power connector:

Pin 1	0V
Pin 2	+5V
Pin 6	-5V

3 Connecting the BVS-0808CP to your PC

For connection to a PC with Triton Router Control System, the RS-232 interface is used. The RS-232 port on all Triton devices uses the standard DCE pin-out, see pin-out table under 4.3.

A standard modem cable can be used for connecting the router to the PCs serial port.

3.1 Selection of router level

The router level depends on the system configuration the router is going to work with. See chapter 5 for more information. All routers are delivered with default level 1. Triton Router Control System offers the control of up to 16 different routers or combinations of routers.

3.2 Pin-out of RS-232 connector

The DB9 female connector for the RS-232 port has the following pin-out:

Pin 2	Tx
Pin 3	Rx
Pin 5	GND

3.3 Maximum cable length

The maximum cable length for an RS-232 connection is per definition 15m. Longer distances can be installed depending on the environmental conditions of the installation site. It is the responsibility of the installer / user to secure a proper installation of the RS-232 connection.

4 NCB connection

Via the Network Control Bus system several routers and control panels can be interconnected.

The standard MIDI interface is used on all NCB control ports. The BVS-0808CP router utilises 5-PIN DIN connectors for connecting to the NCB. This means that when you connect your BVS-0808CP router to other Triton devices, with RJ45 connectors, an RJ45 to 5-pin DIN interface is necessary.

This converter can be ordered from Thomson Grass Valley.

The NCB system allows connection of up to 16 routers with different levels on the same bus. Control panels dedicated to work with a specific router must be configured to the same level as the router. Several panels can work together with one specific router. Up to 16 single routers or combinations of routers can be controlled from the Triton Router Control System. The NCB system and all RS-232 ports interchange the system status.

4.1 Several routers in one system

The NCB system allows the interconnection of up to 16 routers with different levels in one system. A combination of routers working married counts as one level. This might for example be 1 audio router + 1 video router working as an audio follows video system or 3 video routers working as an RGB (YUV) system. The routers in such a constellation must be configured to the same level.

4.2 Connecting control panels

To get a control panel working with a specific router, configure the control panel to the same level as the router. Several panels can be configured to control the same router. The Triton panels can control 2 levels with breakaway function. If it is necessary to control more levels with breakaway an additional panel must be used. **Panels can also be connected to a router via the RS-232 interface. Please refer to your control panel manual for installation.**

4.3 Pin-out and cable type

4.3.1 RJ45 connectors

On some Triton devices, the NCB cable can be connected to RJ-45 connectors. The following pin-out is used:

- Pin 1 = Not Connected
- Pin 2 = Not Connected
- Pin 3 = Not Connected
- Pin 4 = data
- Pin 5 = data
- Pin 6 = Not Connected
- Pin 7 = Not Connected
- Pin 8 = Not Connected

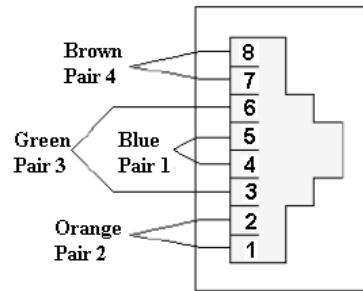

4.3.2 5-pin DIN connectors

However, the pin-out of most Network Control Bus ports, including that of the BVS-0808CP follows the standard MIDI specification. A 1:1 cable with 5pin DIN connector is used. The following pin-out is used:

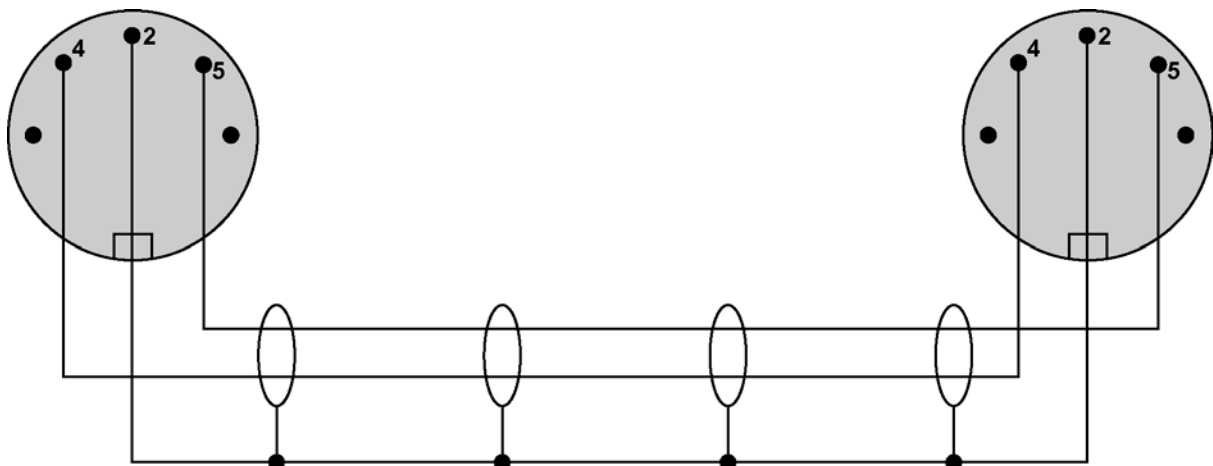

- Pin 1 = Not Connected
- Pin 2 = shield
- Pin 3 = Not Connected
- Pin 4 = data
- Pin 5 = data

The standard MIDI specification recommends the use of shielded twisted pair cable types for interconnection between the units.

4.3.3 RJ45 to 5-pin DIN converter

In configurations that include both devices with RJ45 connectors, and devices with 5-pin DIN connectors, an RJ45 to 5-pin DIN converter may be used to complete the control loop. This converter holds both connector types, and may work both ways, thus from RJ45 to 5-pin DIN, as well as from 5-pin DIN to RJ45.

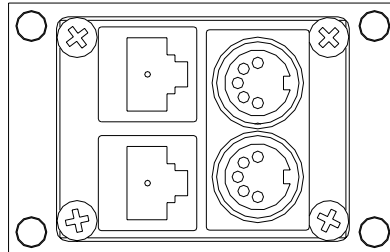

The converter is connected as follows:

RJ45 (Router/CP)	RJ45 (Converter)	5-pin DIN (Converter)	5-pin DIN (Router/CP)
IN	IN	IN	OUT
OUT	OUT	OUT	IN

4.4 Control bus structure

The Network Control Bus structure follows the standard MIDI bus definition. The NCB is defined as a closed chain of units. This means that the NCB OUT of the last unit must be connected to the NCB IN of the first unit in the NCB chain. To avoid problems with the control of Triton units the installer/user has to assure that the bus structure is installed according to this definition. The total number of Triton devices in an NCB chain is limited to 20.

4.5 Maximum distance between NCB devices

The standard MIDI definition allows a maximum cable length of 250 meters between two devices. Longer distances can be made with MIDI repeater units. To avoid grounding problems all NCB ports have opto-coupled inputs.

4.6 Control Bus configuration notes

In order to achieve a system that is easy to maintain and control, follow the important notes, presented hereunder.

- *Avoid using routers of different size, but same signal type (audio/video), on the same level.*
 Example: Do not configure a system with a BVS-1616 and a BVS-0808CP on the same level. If they were on the same level, crosspoint commands that were sent to the BVS-1616 lying outside the range of the BVS-0808CP would not be executed; the BVS-0808CP would throw them off the bus.
 However, a combination of a BVS-1616 and an BAS-0808 will work well, because commands are different for video- and audio routers.
- *Try to limit the number of devices on one Control Bus loop.* If possible, separate systems that are not to be controlled by one central control panel.
 If you need to have several systems in one loop, try to separate as follows, using the DIP switches on the rear of the devices:
 - Analogue Video + Analogue Audio + CP for analogue system on Level 1
 - SDI + AES/EBU + CP for digital system on Level 2

- RS-422 Data + CP for data on Level 3
- Universal Control Panel to control all devices above, with user configurable default level.
- Pay attention to the figure below, in order to achieve full controllability of all devices in the loop.

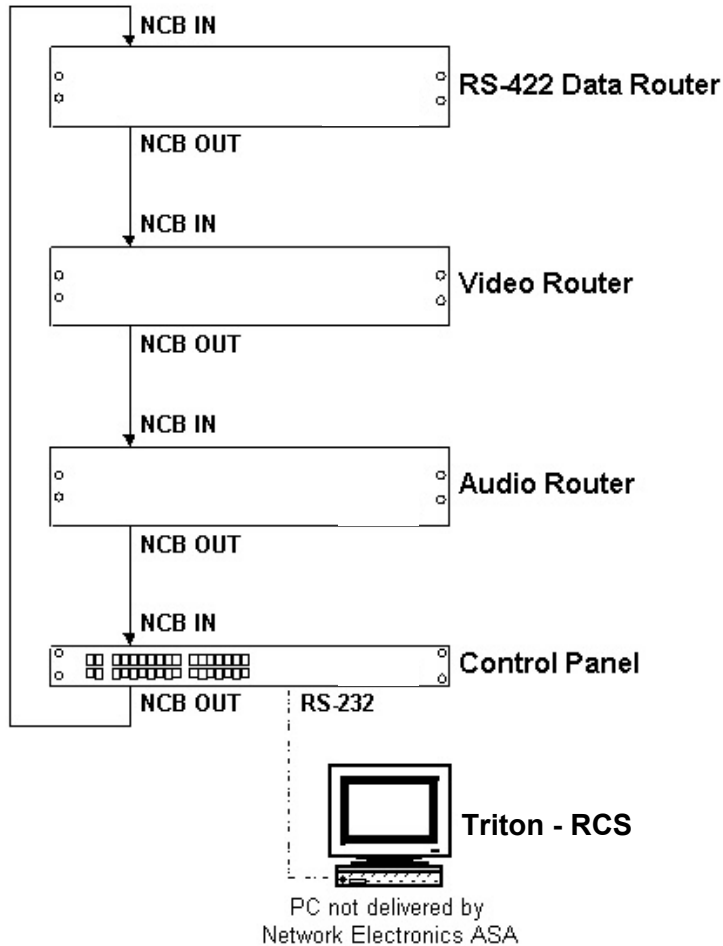

Note!
The Video and Audio Routers may swap positions in the loop. However, they **MUST** be positioned **AFTER** the RS-422 Data Router. The Control Panels **must** be the **last** devices before closing the loop.

- *Complete the Control loop, by connecting all Control bus connections to all Triton devices, before powering up any Triton device.*

5 Router configuration

5.1 Router level

Switch 1 - 4 on the configuration switch set the router's level for communication with the Triton Router Control System, and other units in the NCB system. The panels on the NCB dedicated to operate with the router must be configured to the same level as that router.

If several routers are combined to form an audio follows video, RGB or similar system, these routers must be configured to the same level.

The levels can be switched according to the following pattern:

- means switch down
- * means switch up

Default level is 1.

Switch	1	2	3	4	Level
-	-	-	-	-	1
-	-	-	-	*	2
-	-	*	-	-	3
-	-	*	*	*	4
-	*	-	-	-	5
-	*	-	*	*	6
-	*	*	*	-	7
-	*	*	*	*	8
*	-	-	-	-	9
*	-	-	*	*	10
*	-	*	*	-	11
*	-	*	*	*	12
*	*	-	-	-	13
*	*	-	*	*	14
*	*	*	*	-	15
*	*	*	*	*	16

5.2 Router mode

The BVS-0808CP router allows switching in different modes. You can choose among:

- 8x8 Composite Video
- 4x4 Y/C (SVHS)
- 2x2 RGB/Sync

Switch 5 - 6 on the configuration switch set the router's mode. The Triton Router Control System software must be configured according to the mode chosen on the router.

The modes can be switched according to the following pattern:

- means switch down
- * means switch up

Switch	5	6	Mode
	-	-	8x8 Composite Video
	-	*	4x4 Y/C (SVHS)
	*	-	2x2 RGB/Sync
	*	*	position is not in use

Default mode is 8x8 Composite Video.

Composite Video

Comp. Signal	Input	Comp. Signal	Output
1	1	1	1
2	2	2	2
3	3	3	3
4	4	4	4
5	5	5	5
6	6	6	6
7	7	7	7
8	8	8	8

Y/C (SVHS)

Y/C Signal	Input	Y/C Signal	Output
Y1	1	Y1	1
Y2	2	Y2	2
Y3	3	Y3	3
Y4	4	Y4	4
C1	5	C1	5
C2	6	C2	6
C3	7	C3	7

C4	8	C4	8
----	---	----	---

RGBS

<u>RGBS Signal</u>	<u>Input</u>	<u>RGBS Signal</u>	<u>Output</u>
S1	1	S1	1
S2	2	S2	2
G1	3	G1	3
G2	4	G2	4
B1	5	B1	5
B2	6	B2	6
R1	7	R1	7
R2	8	R2	8

5.3 Vertical interval trigger

The BVS-0808CP router provides vertical interval switching. Video input 1 is used as VIT reference. For all possible video formats the sync carrier has to be connected to video input 1.

Switch 7 on the configuration switch enables or disables the VIT sensing on video input 1. If VIT switching is enabled but a proper signal is missing, the router will automatically switch without VIT.

The VIT can be switched according to the following pattern:

- means switch down
- * means switch up

<u>Switch</u>	<u>7</u>	<u>VIT</u>
-		disabled
*		enabled

Default is VIT enabled.

5.4 Power up mode

Switch 8 on the configuration switch defines the power up mode. The BVS-0808CP router provides two modes for powering up the system.

Mode 1 switches all outputs to input 1.

Mode 2 switches all outputs according to the buffered information in the routers processor system.

The power up reset can be switched according to the following pattern:

- means switch down
- * means switch up

Switch	8	Power Up Reset
	-	Mode 2
	*	Mode 1

Default is Mode 2.

5.5 Programming of restrictions

If the user enables the Restrictions option, the previously programmed restrictions will be fetched from the on-board memory during power-up. New restrictions may be programmed by putting the panel in “Programming mode”. This is done, starting from Panel Disable state, by pushing and holding “V/A toggle”, “Take On/Off” and “Take” and then pushing “Panel Enable”. Blinking “Panel Enable” and “Take” indicates programming mode.

All the legal inputs for the selected output are shown by orange light in button. Pushing the appropriate input button does the Legal/Illegal toggle. When a new output is selected, the programming of the previous output is saved in the on-board memory and the old setting of the new output is fetched from the on-board memory.

Push Panel Disable to stop the programming mode when all necessary programming is finished.

Disabling all inputs for the given output disables an output completely. When in normal mode these outputs may be selected for viewing the status, but not controlled.

6 Connecting video signals to the BVS-0808CP

The BVS-0808CP router offers standard 75 ohms BNC connectors for video in- and outputs. All video inputs are terminated with 75 ohms.

7 Control and connection of Triton systems, interface protocol

7.1 Important notes regarding the Triton Control Protocol

7.1.1 Binary Code

The strings shown on the next pages are in binary coded format. Please be aware of the fact that any terminal program you may use to control a Triton unit from a PC must be able to generate hexadecimal characters. ASCII characters will not be accepted.

7.1.2 Echo

A matrix will reply on a crosspoint set command with an ECHO. In the case where a crosspoint is already set no ECHO will be sent. If the matrix is part of an NCB system two types of reply will be sent. Immediately after receiving the crosspoint set command the ECHO will be sent. The matrix will then wait for the command to pass the NCB system. After receiving the command from the NCB system the matrix will send the command as an ACKNOWLEDGE.

7.1.3 RS-422 Matrixes

RS-422 Data Routers do not accept distribution of an input signal to several outputs. An input signal can only be routed to one single output. The Firmware of our RS-422 routers takes care of these limitations. If an input (Source) is already connected to a particular output (Destination) any connection of this input to another output would disconnect the previous connection. The router will in this case send the following message for the disconnected output: Output connected to input 128. Input 128 is an internal default for the disconnect status. Please see Triton recommendations for use of RS-422 data routers for further information.

7.1.4 Timeout

The Crosspoint Status Request message has a timeout, which means that you need to wait 1 second in between request messages.

7.2 Basic principles

Any message on any level (address) that conforms to the standard arriving at either the NCB or the RS232 port will be re-sent on both NCB and RS232. The only exceptions are:

- a) A matrix that recognizes its address will not re-transmit the message if the crosspoint is already set.
- b) A matrix that recognizes its address will not re-transmit the message if the output number or input number exceeds its size.
- c) A unit (matrix or panel) will not re-transmit a message arriving at the NCB if it was re-transmitted a short while ago (typically 0.5 sec). This is done by grabbing a message storing it for the timeout period, and comparing it with new messages. After the timeout period the unit will grab a new message for compare. This is done to remove unwanted (read: unknown) messages from the NCB ring.
- d) A message arriving at the RS232 will always be re-transmitted unless it is a matrix, and one of the cases a) or b) is fulfilled.

7.2.1 Example: A single unit with no NCB connected

Messages sent to the RS232 of a single unit will be returned once no matter what address or input/output number the message has, unless it is a matrix which recognizes one of the conditions a) or b) above.

7.2.2 Example: Several units connected by NCB

Messages sent to the RS232 of a single unit will be returned once no matter what address or input/output number the message has, unless it is a matrix which recognizes one of the conditions a) or b) above.

If none of the cases a) or b) is fulfilled the message will also be transmitted on the NCB. Then if any unit on the NCB ring recognizes any of the cases a)/b) or c), the message will stop at that point. This means that the message will only be returned once on the RS232.

However, if none of the units on the NCB recognizes any of the cases a) to c), the message will return to the originator (the unit which received the message on RS232). This unit will re-transmit the message once more on both NCB and RS232. The message is therefore returned a second time on RS232. This time one of the cases a) or c) is sure to be identified by one of the units on the NCB, and the message is removed.

There is however one more special case: If several messages for unused addresses are transmitted with only little delay, one might experience that some messages are returned several times, as the store/compare/remove function in case c) can only handle a single message at the time. We therefore recommend that the user avoid sending messages to unused addresses.

7.3 RS232

The RS-232 port is used for external control of Triton units. The RS-232 port allows the customer to control the equipment via the Triton Router Control System PC program or self-defined customized solutions.

Connector for the RS-232 port is a DS9 female.

Pin 2 - Tx.

Pin 3 - Rx

Pin 5 - GND

A standard DCE (Data Communication Equipment) cable can be used for connection between PC and Triton equipment. The connection between the connectors is made one-to-one.

Data-rate is 19200 baud/sec with 8 data-bit, 1 stop-bit, no parity, if nothing else is specified in the user manual of the product.

7.4 NCB

The NCB is used for interconnection between several Triton units. Up to 20 routers and/or control panels can be linked together to form a routing system with many operational features.

The NCB utilises a 5 mA current loop with opto-coupled ports.

Standard connector is a 5pin DIN.

Standard MIDI cables can be used to interconnect several Triton units.

Data-rate is 31.25 Kbps.

1 start-bit, 8 data-bit, no parity, 1 stop-bit. Logical 0 = current ON.

7.5 Commands

7.5.1 Audio crosspoint set

Only for use with Audio routers.

Command for setting of crosspoints:

1001nnnn 0kkk kkkk 0vvv vvvv

- nnnn is the matrix address from 0 up to 15.
- kkk kkkk is the output which shall be controlled.
kkk kkkk = output number
0 = output 1
127 = output 128
- vvv vvvv is the input which shall be connected to the chosen output.
vvv vvvv = input number

7.5.2 Audio crosspoint set acknowledge

Only for use with Audio routers.

Command for acknowledging setting of crosspoints:

1000nnnn 0kkk kkkk 0vvv vvvv

- nnnn is the matrix address from 0 up to 15.
- kkk kkkk is the output which shall be controlled.
kkk kkkk = output number
0 = output 1
127 = output 128
- vvv vvvv is the input which shall be connected to the chosen output.
vvv vvvv = input number

7.5.3 Video crosspoint set

Only for use with Video routers.

Command for setting of crosspoints:

1010nnnn 0kkkkkkk 0vvvvvvv

- nnnn is the matrix address from 0 up to 15.
- kkk kkkk is the output which shall be controlled.
kkk kkkk = output number
0 = output 1
127 = output 128
- vvv vvvv is the input which shall be connected to the chosen output.
vvv vvvv = input number.

7.5.4 Video crosspoint set acknowledge

Only for use with Video routers.

Command for acknowledging setting of crosspoints:

1011nnnn 0kkkkkkk 0vvvvvvv

- nnnn is the matrix address from 0 up to 15.
- kkk kkkk is the output which shall be controlled.
 - kkk kkkk = output number
 - 0 = output 1
 - 127 = output 128
- vvv vvvv is the input which shall be connected to the chosen output.
 - vvv vvvv = input number.

7.5.5 Crosspoint status request

This command is used for status request on Audio and Video routers.

1100nnnn 0xxxxxxx

- nnnn is the matrix address from 0 up to 15.
- xxxxxxxx - do not carry any information

The requested router (Audio or Video) will send its crosspoint status on NCB OUT and RS232. The same command format as for crosspoint set is used.

8 Control panel operation

The built-in panel in the BVS-0808CP offers 8 input select buttons on the top row. The input buttons are equipped with two LED indicators for displaying both video and audio status during breakaway operations. The bottom row selects the 8 router outputs. The last selected output will be indicated with the LED. On the left hand side the panel provides 4 function keys with following functions:

- TAKE Executes the last operation
- TAKE ON/OFF Enables / disables Take function
- AUDIO / VIDEO Enables Audio, Video or AFV
- ENABLE Enables panel

8.1 Front panel drawing

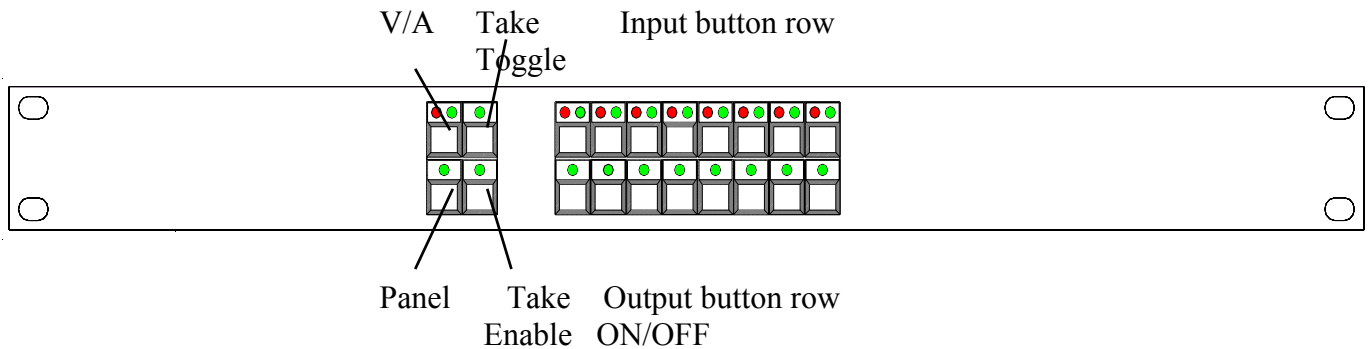

8.2 PANEL ENABLE button

After powering-up the control panel will be disabled. The LED`s in the buttons are only half illuminated. Press the PANEL ENABLE button to start operating. If you want to lock the control panel after use you simply disable by operating the PANEL ENABLE button once again.

8.3 V/A TOGGLE button

After powering-up the control panel will operate audio follow video. The red and green LED on the V/A TOGGLE button are illuminated. By operating the V/A toggle button you can select the layer you want to switch. Red LED illuminated means only audio. Green LED illuminated means only video.

8.4 Operating crosspoints

Operating crosspoints is an easy task with BVS-0808CP. You select the output you want to operate on the OUTPUT BUTTON row. With the next operation you select one of the inputs on the INPUT BUTTON row. The crosspoint operation will be executed while pressing the input button.

8.5 TAKE function

The BVS-0808CP provides a TAKE function which can be activated by pressing the TAKE ON/OFF button. The TAKE ON/OFF button will show green light if the TAKE function is activated. After selecting output and input like described under 4.3 the INPUT button and the TAKE button will start to blink. The crosspoint operation will be executed by pressing the TAKE button. If you work with video/audio breakaway you can first select the video layer, afterwards the audio layer and finally execute both operations at the same time with the TAKE button.