



Snell
Advanced
Media

User Manual

2460 Controller

Automation and Router Control

Contents

1. Information and Notices	3
1.1 Copyright and Disclaimer	3
1.2 Contact Details	3
2. Safety Notices	4
2.1 Lithium Batteries	4
3. Introduction	5
3.1 Overview	5
3.1.1 2460 Controller Card	5
3.1.2 IQ3HB 3U Enclosure	6
4. Controller Card Installation and Removal	7
4.1 Overview	7
4.2 Opening and Closing the Front Panel	8
4.3 Installing a New Controller Card	8
4.4 Removing a Controller Card	9
5. Controller Card Details	10
5.1 2460 Automation Controller Card Configuration	10
5.2 2460 Router Controller Card Configuration	10
5.3 Controller Card LEDs, Reset Button and USB Connectors	10
5.3.1 Reset Button	12
5.3.2 USB Connectors	12
6. Specification	13
6.1 Specifications	13
6.2 2460 Controller Card Rear Panel Types	14
6.2.1 1493 Rear Panel (Automation Control Systems Only)	14
6.2.2 1494 Rear Panel (Automation and Router Control Systems)	15
6.3 2460 Controller Card Rear Panel Connectors	16
6.3.1 Timecode	16
6.3.2 Ref and Ref Loop	16
6.3.3 VITC/Ref	16
6.3.4 SDI/SCR	16
6.3.5 GPIO	17
6.3.6 Ethernet (Master) & Ethernet (Slave) Connectors	17
6.3.7 USB (Master) & USB (Slave) Connectors	17
6.3.8 COMM 1-8 (37 Way)	18
6.3.9 COMM 9-16 (37 Way)	19
6.4 Serial Breakout Cable (Order Code 1748)	20

1. Information and Notices

1.1 Copyright and Disclaimer

Copyright protection claimed includes all forms and matters of copyrightable material and information now allowed by statutory or judicial law or hereinafter granted, including without limitation, material generated from the software programs which are displayed on the screen such as icons, screen display looks etc.

Information in this manual and software are subject to change without notice and does not represent a commitment on the part of SAM Limited. The software described in this manual is furnished under a license agreement and can not be reproduced or copied in any manner without prior agreement with SAM Limited, or their authorized agents.

Reproduction or disassembly of embedded computer programs or algorithms prohibited.

No part of this publication can be transmitted or reproduced in any form or by any means, electronic or mechanical, including photocopy, recording or any information storage and retrieval system, without permission being granted, in writing, by the publishers or their authorized agents.

SAM operates a policy of continuous improvement and development. SAM reserves the right to make changes and improvements to any of the products described in this document without prior notice.

1.2 Contact Details

Customer Support

For details of our Regional Customer Support Offices please visit the SAM web site and navigate to Support/247-Support.

www.s-a-m.com/support/247-support/

Customers with a support contract should call their personalized number, which can be found in their contract, and be ready to provide their contract number and details.

2. Safety Notices

2.1 Lithium Batteries

CAUTION

This equipment contains a lithium battery

There is a danger of explosion if this is replaced incorrectly
Replace only with the same or equivalent type.
Dispose of used batteries according to the manufacturers instructions.
Batteries **should only** be replaced by trained service technicians

The 2460 Controller card(s) contain a Lithium battery to provide non-volatile memory.

Note:

- Used batteries should be disposed of in accordance with the manufacturers instruction and any specific local legislation regarding the recycling of waste batteries and accumulators
- Ensure that the same make and model of battery is used if replacement is required and observe the correct polarity (a manufacturer recommended UL recognized equivalent can be used if the original type is not available)

3. Introduction

3.1 Overview

Two versions of the 2460 controller card are available; one version is used for Automation control systems such as SAM Morpheus and ICE, the second version is used for router control systems. The cards can be mixed in the IQ 3U enclosure as required. The card types are identified by printing on the plastic extractor handle on the front of each card (labelled **MOR-2460** and **IQRCTL2460** respectively).

The 2460 controller is a PC card where all the time critical commands for the system's broadcast devices are stored and executed. Each card can control any combination of serial, IP, and GPI controlled devices. A maximum of 16 serial connections and up to 16 GPI connections are available from each controller card. As the system is modular, command execution and latency are easily controlled by adding additional cards or 3U enclosures.

The 2460 controller cards can be used in a dual-redundant configuration where a backup card automatically takes over from a failed main card. In a dual-redundant system, pulling out a live card has no effect on the system as its backup will seamlessly take over.

Note: Router control systems are only available as dual-redundant pairs. Dual-redundant pairs occupy two enclosure slots and four rear panel positions.

3.1.1 2460 Controller Card

The 2460 cards store and execute all of the time critical commands for the system's broadcast devices. The configuration of the devices that each card controls is stored in persistent memory on the controller card.

A 2460 controller card, or a number of cards (working individually, or as dual-redundant paired cards) are fitted in a standard SAM IQH3B 3U enclosure. This is a 19 inch wide 3U high unit, which accommodates 2460 controller cards.

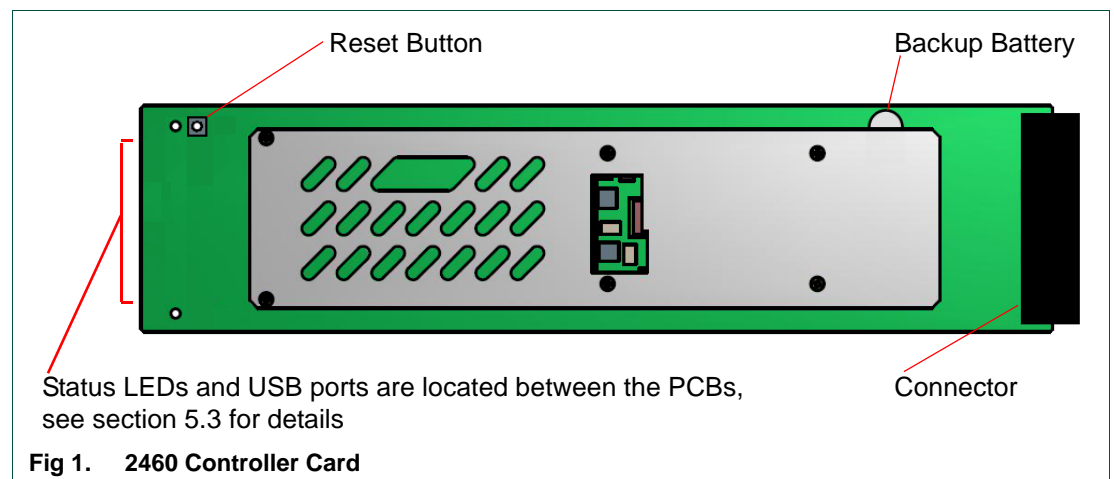

The main features of the 2460 controller cards are:

- 2460 controller cards and rear panels are hot-swappable
- Each controller card can control up to 16 devices
- RS232, RS485/422, TCP/IP
- Timecode input
- Reference input
- GPIO

3.1.2 IQ3HB 3U Enclosure

Each IQ enclosure can accommodate up to six 2460 controller cards in various combinations of single controller and dual-redundant pairs of controllers. Each 2460 controller uses two slots of the 16 slots available in an IQ enclosure. Rear panels are available for single controllers and dual-redundant pairs, and occupy three and four rear panel positions respectively. See Table 2 on page 13 for 2460 controller card combinations in a single enclosure.

Note: Router control systems are only available as dual-redundant pairs. Dual-redundant pairs occupy two enclosure slots and four rear panel positions.



Fig 2. IQH3B 3U Enclosure

For more information on the IQ3HB enclosure see the **IQH3B/IQH3BQ IQ Modular Enclosure Installation and User Manual** which can be found here:

<https://s-a-m.com/support/modular-infrastructure/>

in file "IQH3B_3U_Enclosure.pdf".

The main features of the IQH3B 3U enclosure are:

- Hot-swappable redundant power supplies with PSU status reporting through GPIs on the Gateway control card rear panel
- Dual-redundant in-service removable cooling fan unit
- Optional SNMP monitoring of PSU and fan status via the Ethernet connector on the rear panel of the Gateway control card
- Variable fan speed dependant on load and ambient temperature
- Full CE and UL compliance

4. Controller Card Installation and Removal

4.1 Overview

The controller cards fit into connector panels on the rear of the 3U enclosure. There are two types of connector panel depending on whether a single controller card or a pair of dual-redundant controller cards are fitted.

Note: The 2460 controller cards and rear panels are hot-swappable and so can be fitted or removed with the IQ3HB enclosure powered on.

- 1493 - single controller rear panel (three rear panel positions)
- 1494 - dual-redundant controller rear panel (four rear panel positions)

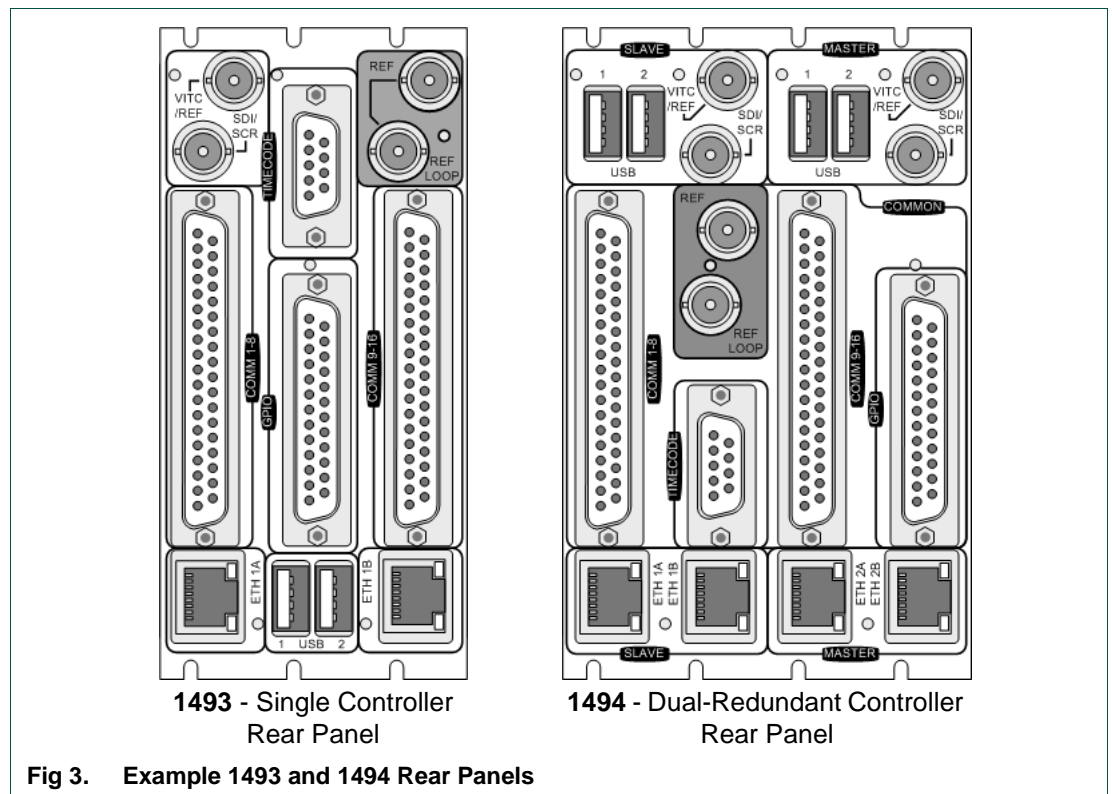

4.2 Opening and Closing the Front Panel

To open the front panel:

1. Turn the locking screw approximately half a turn to release the panel.
2. Pull the panel forward and downward using the handle that runs along the top edge of the panel.

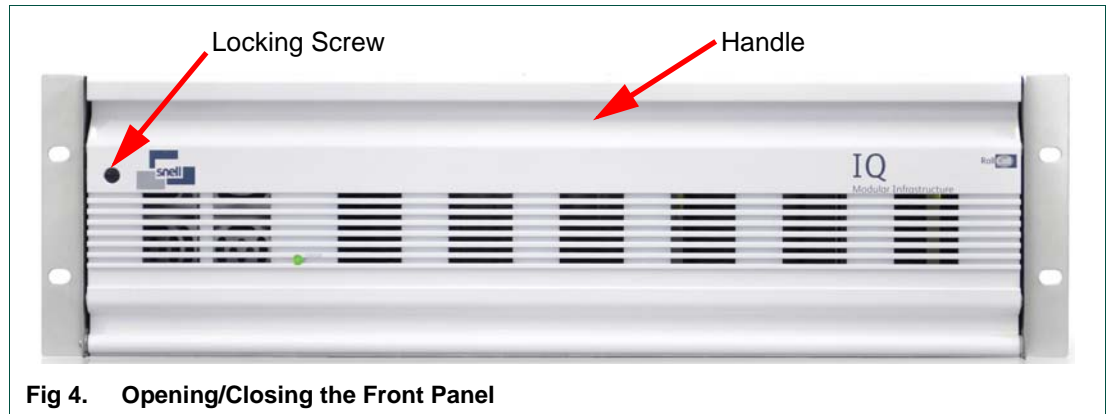

Fig 4. Opening/Closing the Front Panel

To close the front panel:

1. Pull the panel upward using the handle that runs along the top edge of the panel.
2. Turn the locking screw approximately half a turn to secure the panel.

4.3 Installing a New Controller Card

Note:

- A single controller requires two slots and three rear panel positions, see Fig 5.
- A pair of dual-redundant controllers require four slots and four rear panel positions, see Fig 5.

1. Open the front panel (see section 4.2).
2. Remove the module retaining bar.
3. Choose a pair of empty slots (4 consecutive slots are required if fitting a pair of control cards in a dual-redundant configuration).
4. Remove the screws securing the blanking plates at the rear of the enclosure associated with the chosen slot position. Store the blanking plates in a safe place for future use.
5. Ensuring correct orientation, fit the rear connecting panel (supplied with the new controller cards) to the rear of the enclosure in the vacant aperture and secure with the fixing screws provided.

6. Ensure correct orientation of the 2460 controller and that the left controller PCB is aligned with the upper and lower enclosure card guide slots, see Fig 5.
7. Carefully slide in the new module until it fully mates with the rear connector panel.

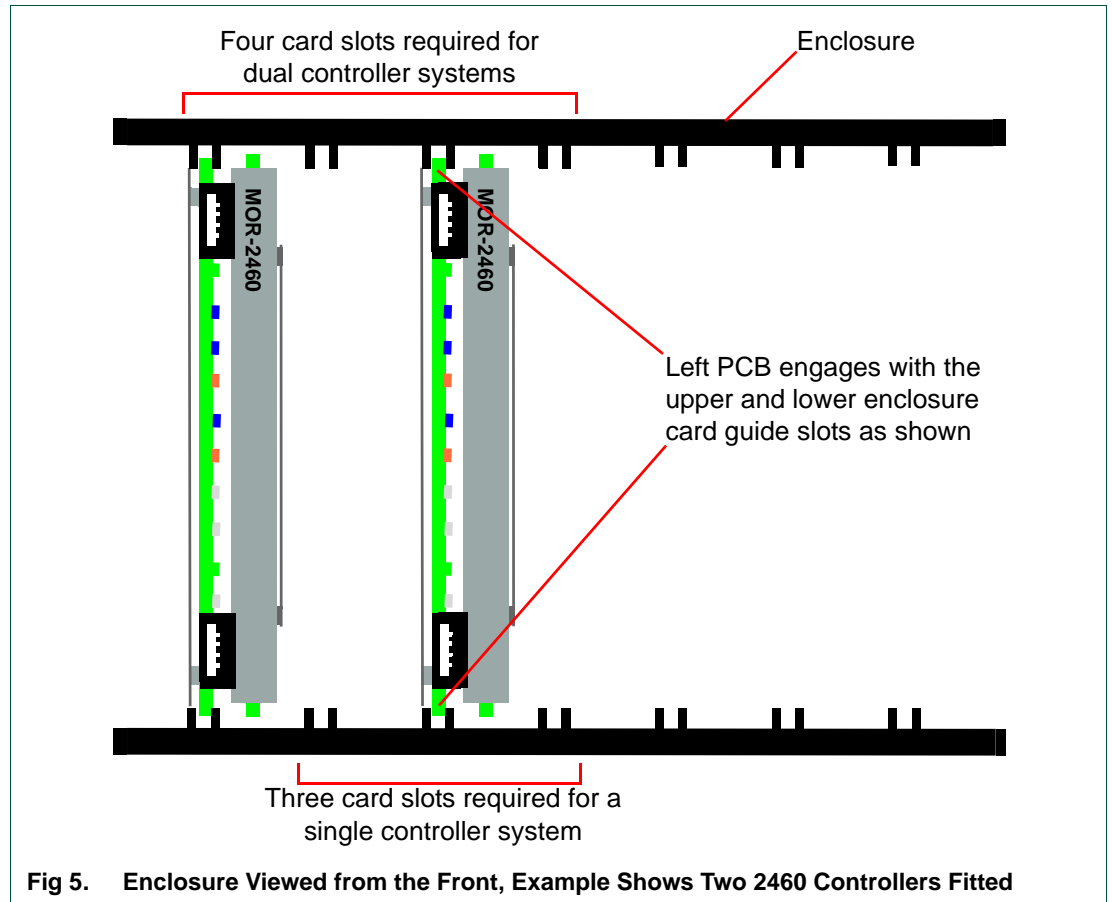

Fig 5. Enclosure Viewed from the Front, Example Shows Two 2460 Controllers Fitted

8. Refit the module retaining bar and close the front panel.

4.4 Removing a Controller Card

To remove a controller card:

1. Open the front panel (see section 4.2).
2. Remove the module retaining bar.
3. Carefully slide out the desired controller card by pulling the card extractor handle.
4. Refit the module retaining bar and close the front panel.

If the slots are to be left vacant, proceed as follows:

1. At the rear of the enclosure remove the now unused rear panel.
2. Fit the blanking plates in the associated position using the screws.

5. Controller Card Details

Two versions of the 2460 controller card are available; one version is used for Automation control systems such as SAM Morpheus and ICE, the second version is used for router control systems. The card types are identified by printing on the plastic extractor handle on the front of each card (labelled **MOR-2460** and **IQRCTL2460** respectively).

The 2460 controller cards are configured in software and no hardware configuration is required.

5.1 2460 Automation Controller Card Configuration

2460 Automation controller cards are shipped pre-configured for your system. For details on editing the configuration see the SAM Morpheus documentation supplied with your system.

5.2 2460 Router Controller Card Configuration

2460 Router controller cards are shipped pre-configured for your system. For details on editing the configuration see the Workbench user manual on the documentation CD delivered with your system.

5.3 Controller Card LEDs, Reset Button and USB Connectors

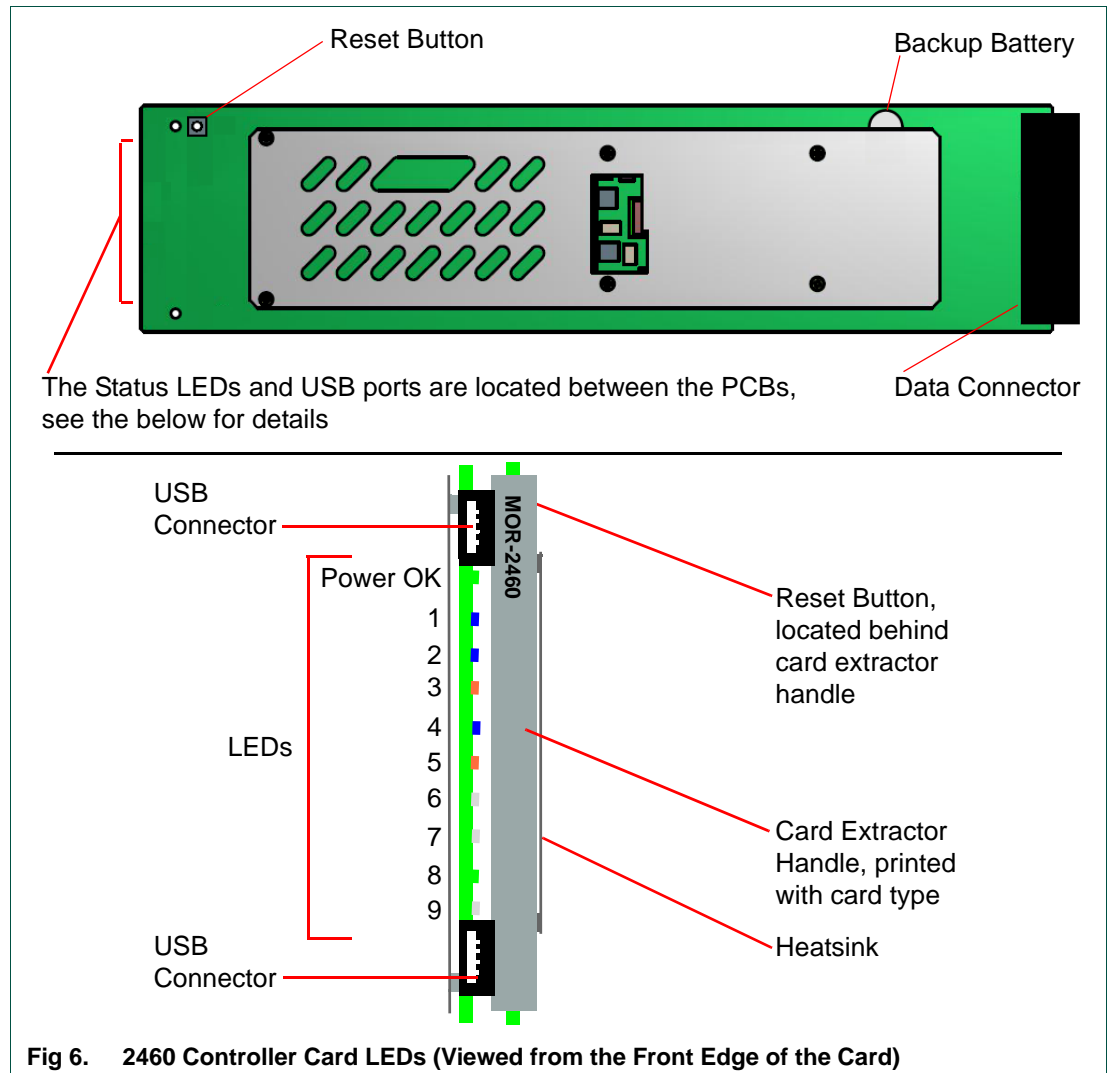

Fig 6. 2460 Controller Card LEDs (Viewed from the Front Edge of the Card)

Note: Jumpers and Headers are present on the 2460 controller card and these are for SAM Use Only.

The LEDs along the front edge of the card indicate the following:

LED	Routing	Automation
Power OK	Power OK <ul style="list-style-type: none"> Green = Power is connected and okay Off = Power not connected or not okay 	
1	Active/Idle <ul style="list-style-type: none"> Flashing Green = Active Flashing Blue = Idle 	Card Health Monitor <ul style="list-style-type: none"> Flashing Yellow = Controller working Off = Controller not working
2	Master/Slave <ul style="list-style-type: none"> Green = Master Controller Blue = Slave Controller 	Reference Present <ul style="list-style-type: none"> Solid Blue = Valid Ref present Off = Valid Ref not present
3	Watchdog Status <ul style="list-style-type: none"> Flashing Green = Watchdog enabled and running Flashing Orange = Watchdog disabled 	LTC Present <ul style="list-style-type: none"> Solid Blue = Valid LTC present Off = Valid LTC not present
4	Serial Link Between Controllers Displays the status of the serial link between the active and idle controllers. The serial link is used to replicate data between the active and idle controllers in a dual-redundant pair. <ul style="list-style-type: none"> Blue pulsing Green = Link okay, data is being transferred. Green pulsing Blue = Link okay, no data is being transferred. Magenta pulsing Blue = Link error, no connection with the other controller. Indicates; the other controller is not present/not running or the serial link is not working. Orange Pulses = Error, received data for unconfigured device Indicates; the other controller is configured differently from the controller receiving the data or it has no configuration. Red Pulses = Error, received data with invalid format. Check both controllers are running the same version of CentraController.rtb software. Workbench can be used to check the controller software versions loaded. 	Watchdog Status <ul style="list-style-type: none"> Flashing Green = Watchdog enabled and running Solid Red = Watchdog disabled

Table 1. 2460 Controller Card LEDs

LED	Routing	Automation
5	Not used	Not used
6	Not used	Not used
7	Not used	Not used
8	Not used	Active/Idle <ul style="list-style-type: none"> • Solid Green = Active • Solid Blue = Idle
9	Not used	Not used

Table 1. 2460 Controller Card LEDs

5.3.1 Reset Button

The reset button resets the controller card and will also failover control to the second controller in a dual-redundant controller system.

Single controllers:

Pressing the reset on a single controller will cause the 2460 controller to reboot.

Important:

All communication with the 2460 controller will be lost during the reset. Because of this no switching outputs or status messages will be available during the reset.

Dual-redundant controller pair:

Pressing the reset button on the active controller of a dual-redundant pair of controllers will reset the active controller and cause control to failover to the other controller in the pair.

Important:

IQRCTL2460 only:

If the Idle controller in the pair has recently been fitted in the enclosure the active controller may still be synchronizing its configuration to the idle controller over the network.

Do not fail-over to the idle controller until data synchronization is complete.

In practice the amount of time the controller takes to synchronize will depend on a number of factors such as; system size, system complexity, network conditions, the number of changes made from the default configuration, etc.

To be sure synchronization is complete check the Workbench Generic Online editor, see the Workbench user manual for details on using the Generic Online Editor:

Navigate to:

```
Controller | ConfigurationItems | ReplicatedPeer |
ReplicationComplete = True
```

Where:

- Synchronization complete, safe to failover = True
- Synchronization not complete, do not failover = False

Alternatively:

if you have no access to Workbench you should wait a minimum of 10 minutes from inserting a controller before failing over to it.

5.3.2 USB Connectors

The USB connectors on the front edge of the controller card can be used if USB peripherals such as a mouse or keyboard need to be attached to the controller.

6. Specification

6.1 Specifications

For a full list of the specifications for the IQ3HB 3U enclosure see the **IQH3B/IQH3BQ IQ Modular Enclosure Installation and User Manual** which can be found here:

<https://s-a-m.com/support/modular-infrastructure/>

in file "IQH3B_3U_Enclosure.pdf".

Specifications	
Temperature Range:	0 to 40°C operating, -20 to +85°C storage. A temperature and load sensitive cooling fan is fitted
Humidity Range:	10 to 85% (non condensing)
Power Rating Load Units (LU)	26 LU per 2460 Controller IQH3B enclosure; 165 LU Max.
IQ3HB 3U Enclosure Capacity:	3 x dual-redundant pairs of controllers
	or 2 x dual-redundant pairs of controllers + 2 single controllers
	or 1 x dual-redundant pairs of controllers + 4 single controllers
	or 5 single controllers

Table 2. Specifications - Mechanical

6.2 2460 Controller Card Rear Panel Types

The rear connector panels provide different levels of connectivity for either single or dual-redundant cards and the number of ports required. The panels share many similar connectors. All connectors are detailed in the Connectors section. See “2460 Controller Card Rear Panel Connectors” on page 16.

Note: Router control systems are only available as dual-redundant pairs. Dual-redundant pairs occupy two enclosure slots and four rear panel positions.

6.2.1 1493 Rear Panel (Automation Control Systems Only)

This rear panel variant provides 16-port capability for single controllers.

Note: Only connect one Ethernet cable to the controller rear panel, either Ethernet connector can be used. Connecting two Ethernet cables will result in communication failure.

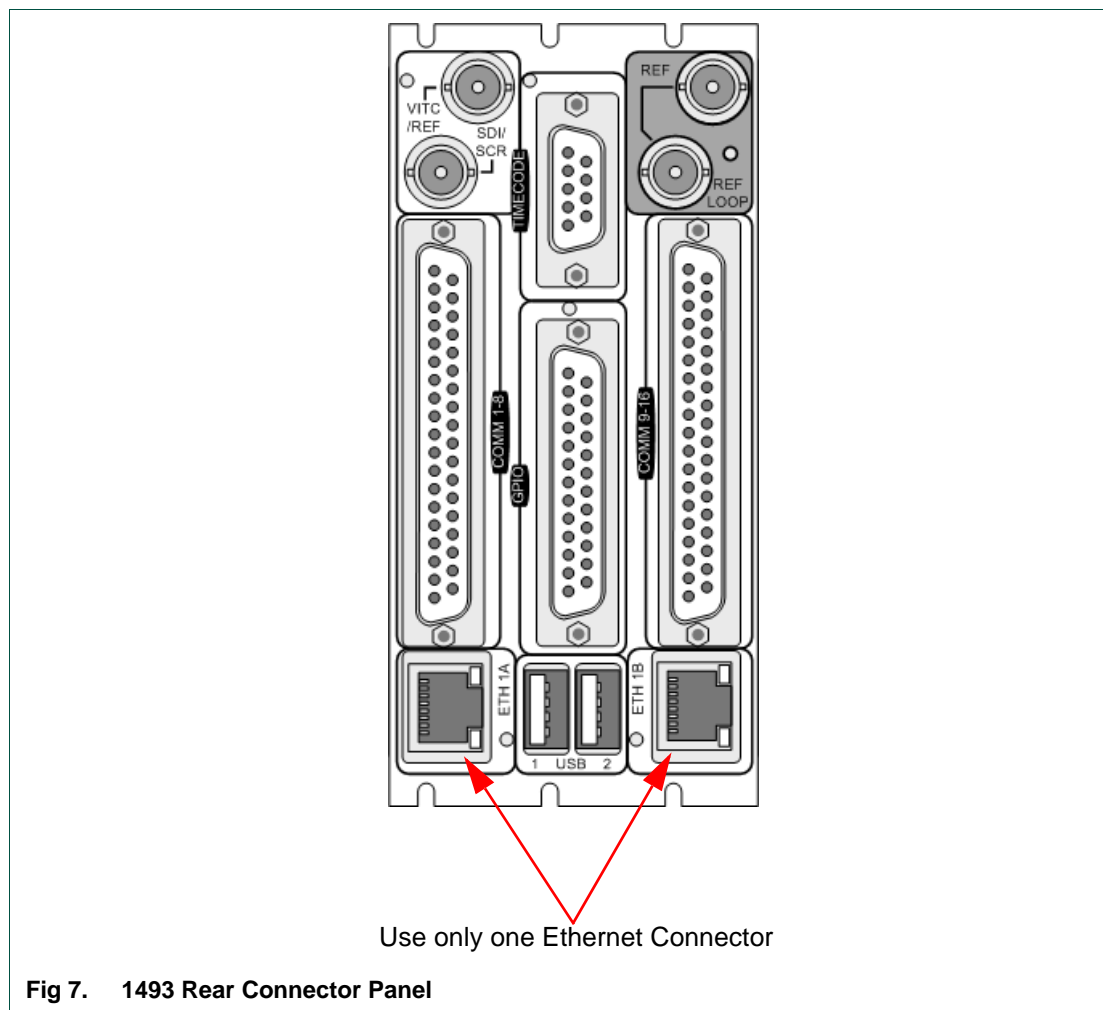

6.2.2 1494 Rear Panel (Automation and Router Control Systems)

This rear panel variant provides 16-port capability and dual-redundancy.

Note: Only connect one Ethernet cable to each controller, either of the controller Ethernet connectors can be used. Connecting two Ethernet cables to a controller will result in communication failure for that controller.

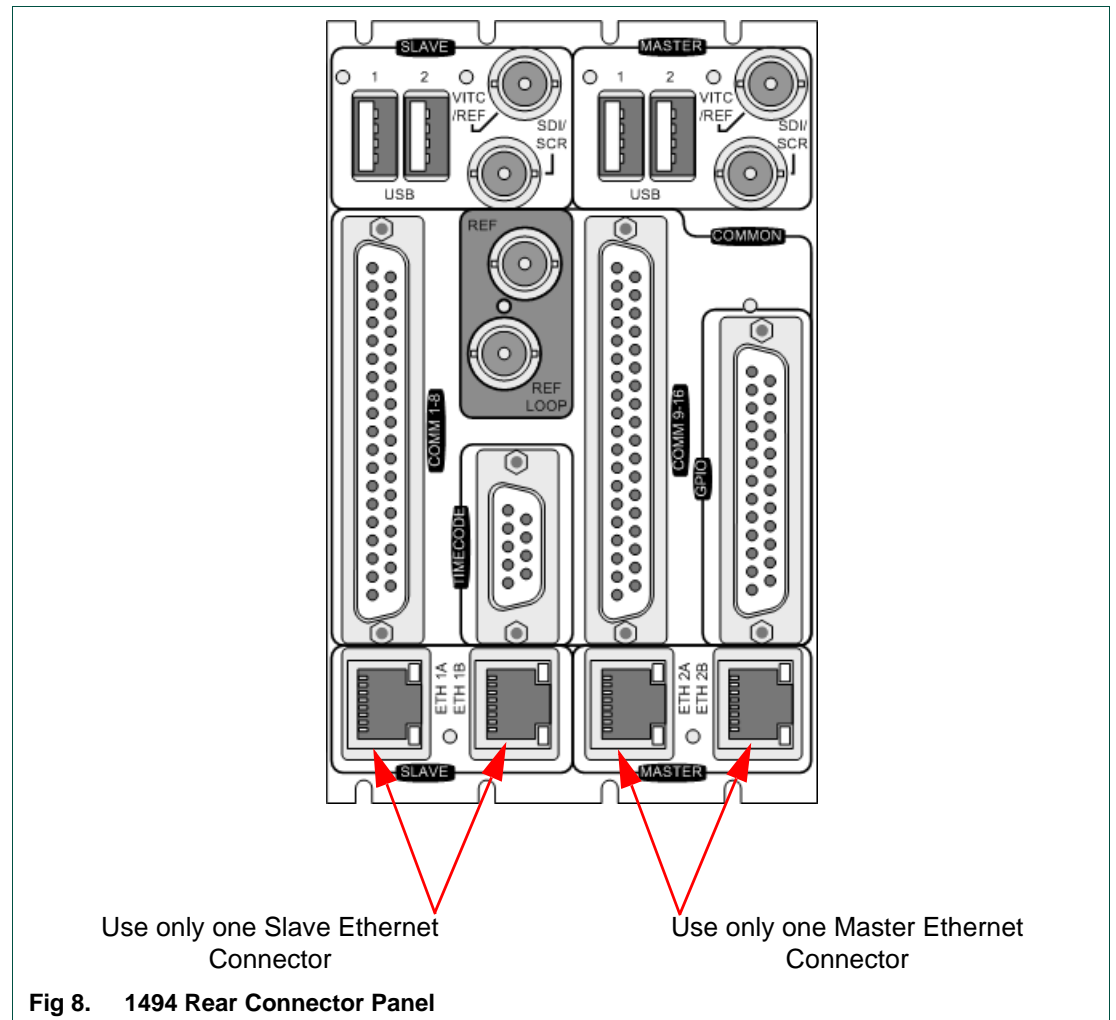

6.3 2460 Controller Card Rear Panel Connectors

6.3.1 Timecode

LTC signal input and balanced AES reference input available on the Timecode connector. The Timecode connector is a 9-way D-type socket (DE-9F) with the following pinouts:

Pin	Signal
1	LTC In +
2	AES In +
3	N/C
4	N/C
5	N/C
6	LTC In -
7	AES In -
8	N/C
9	GND

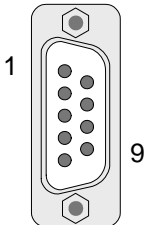

Fig 9. Timecode Connector

6.3.2 Ref and Ref Loop

Passive BNC video reference input and loop through connectors.

Analog video, auto sensing B+B (625 line PAL or 525 line NTSC) or HD Tri-level reference.

Note: No internal termination, 75 Ohm termination required at the end of a signal run.

Pin	Signal
1	Video Reference
2	GND

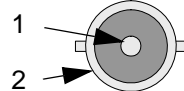

Fig 10. Ref Connector

6.3.3 VITC/Ref

Not Used.

6.3.4 SDI/SCR

The SDI/SCR BNC connector outputs debugging information that can be displayed on a screen that can accept a 720p50 SDI input.

The SDI/Screen connector is a BNC connector with the following connections:

Pin	Signal
1	SDI Monitor
2	GND

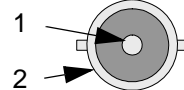

Fig 11. SDI/SCR Connector

6.3.5 GPIO

The GPIO connector is a 25-way D-type socket (DB-25F) with the following pinouts:

Pin	Signal	Pin	Signal
1	GPI_0	14	GPI_13
2	GPI_1	15	GPI_14
3	GPI_2	16	GPI_15
4	GPI_3	17	N/C
5	GPI_4	18	5V (0.5A max.)
6	GPI_5	19	N/C
7	GPI_6	20	GND
8	GPI_7	21	GND
9	GPI_8	22	GND
10	GPI_9	23	GND
11	GPI_10	24	GND
12	GPI_11	25	GND
13	GPI_12		

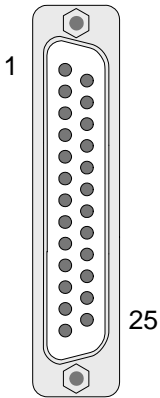

Fig 12. GPIO Connector

6.3.5.1 GPIO Outputs

As Outputs, the GPIOs are arranged in two banks of eight outputs; the first eight GPIOs in bank 1, and the second eight GPIOs in bank 2. Each bank of eight outputs is capable of sinking a maximum of 1.0A. Each output is capable of sinking up to a maximum of 500mA. Two of the eight outputs could sink the maximum of 0.5A. alternatively all outputs could sink 125mA and still be within the maximum limits.

Outputs can switch up to 50V.

6.3.5.2 GPIO Inputs

As Inputs the switch of the external equipment must be able to sink a minimum of 5mA with a maximum voltage of 5V.

6.3.6 Ethernet (Master) & Ethernet (Slave) Connectors

The Ethernet connectors are standard RJ-45 sockets with standard pinouts:

Note: Only connect one Ethernet cable to each controller, either of the controller Ethernet connectors can be used. Connecting two Ethernet cables to a controller will result in communication failure for that controller.

6.3.7 USB (Master) & USB (Slave) Connectors

USB 1 and USB 2 are standard Type A USB sockets with standard pinouts.

6.3.8 COMM 1-8 (37 Way)

The COMM 1-8 connector is a 37-way D-type socket (DC-37F) with the following pinouts:

Pin	2460 Port Functioning as an:		
	RS485/422 Controller	RS485/422 Device	RS232 Device (DCE)
1	Rx 1+	Tx 1+	-
2	Rx 1-	Tx 1-	Tx 1
3	Rx 2+	Tx 2+	-
4	Rx 2-	Tx 2-	Tx 2
5	Rx 3+	Tx 3+	-
6	Rx 3-	Tx 3-	TX 3
7	Rx 4+	Tx 4+	-
8	Rx 4-	Tx 4-	TX 4
9	Rx 5+	Tx 5+	-
10	Rx 5-	Tx 5-	N/A
11	Rx 6+	Tx 6+	-
12	Rx 6-	Tx 6-	N/A
13	Rx 7+	Tx 7+	-
14	Rx 7-	Tx 7-	N/A
15	Rx 8+	Tx 8+	-
16	Rx 8-	Tx 8-	N/A
17	GND	GND	GND
18	GND	GND	GND
19	GND	GND	GND
20	Tx 1+	Rx 1+	Rx 1
21	Tx 1-	Rx 1-	-
22	Tx 2+	Rx 2+	Rx 2
23	Tx 2-	Rx 2-	-
24	Tx 3+	Rx 3+	RX 3
25	Tx 3-	Rx 3-	-
26	Tx 4+	Rx 4+	RX 4
27	Tx 4-	Rx 4-	-
28	Tx 5+	Rx 5+	N/A
29	Tx 5-	Rx 5-	-
30	Tx 6+	Rx 6+	N/A
31	Tx 6-	Rx 6-	-
32	Tx 7+	Rx 7+	N/A
33	Tx 7-	Rx 7-	-
34	Tx 8+	Rx 8+	N/A
35	Tx 8-	Rx 8-	-
36	GND	GND	GND
37	GND	GND	GND

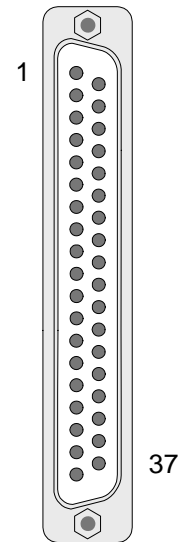

Fig 13. COMM 1-8 (37 Way) Connector

Important:

- The **Controller** and **Device** columns are shown in the table above for information. Signal direction is automatically swapped internally when the ports are defined as either controller or device ports.
- Only RS232 ports 1 to 4 are available on the **COMM 1-8** connector.

6.3.9 COMM 9-16 (37 Way)

The COMM 9-16 connector is a 37-way D-type socket (DC-37F) with the following pinouts:

Pin	2460 Port Functioning as an:	
	RS485/422 Controller	RS485/422 Device
1	Rx 9+	Tx 9+
2	Rx 9-	Tx 9-
3	Rx 10+	Tx 10+
4	Rx 10-	Tx 10-
5	Rx 11+	Tx 11+
6	Rx 11-	Tx 11-
7	Rx 12+	Tx 12+
8	Rx 12-	Tx 12-
9	Rx 13+	Tx 13+
10	Rx 13-	Tx 13-
11	Rx 14+	Tx 14+
12	Rx 14-	Tx 14-
13	Rx 15+	Tx 15+
14	Rx 15-	Tx 15-
15	Rx 16+	Tx 16+
16	Rx 16-	Tx 16-
17	GND	GND
18	GND	GND
19	GND	GND
20	Tx 9+	Rx 9+
21	Tx 9-	Rx 9-
22	Tx 10+	Rx 10+
23	Tx 10-	Rx 10-
24	Tx 11+	Rx 11+
25	Tx 11-	Rx 11-
26	Tx 12+	Rx 12+
27	Tx 12-	Rx 12-
28	Tx 13+	Rx 13+
29	Tx 13-	Rx 13-
30	Tx 14+	Rx 14+
31	Tx 14-	Rx 14-
32	Tx 15+	Rx 15+
33	Tx 15-	Rx 15-
34	Tx 16+	Rx 16+
35	Tx 16-	Rx 16-
36	GND	GND
37	GND	GND

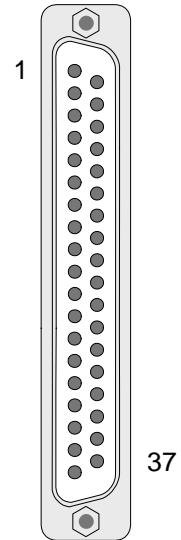

Fig 14. COMM 1-8 (37 Way) Connector

Important:

- The **Controller** and **Device** columns are shown in the table above for information. Signal direction is automatically swapped internally when the ports are defined as either controller or device ports.
- The **COMM 9-16** connector has no RS232 functionality.

6.4 Serial Breakout Cable (Order Code 1748)

The 1.5 metre Serial Breakout Cable has a 37-way D-type plug (DC-37M) and eight 9-way D-type sockets (DE-9F).

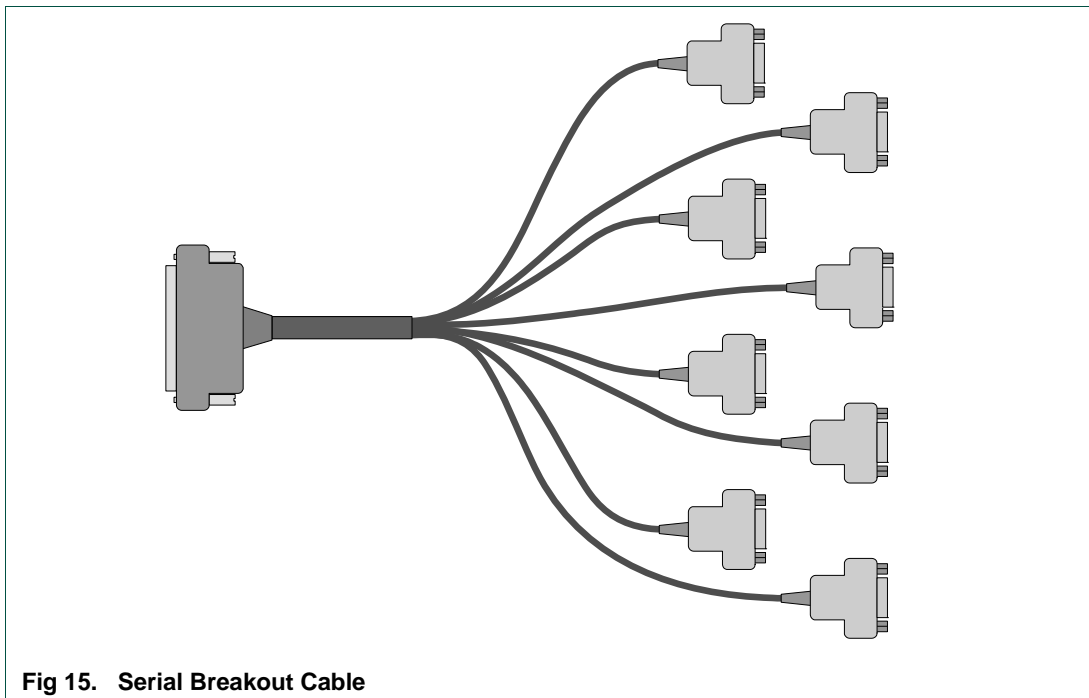

Fig 15. Serial Breakout Cable

For pin connections to the 37-way socket, see “COMM 1-8 (37 Way)” on page 18 and “COMM 9-16 (37 Way)” on page 19.

Each of the eight 9-way D-type sockets has the following pinouts:

Pin	2460 Port Functioning as an:			
	RS485/422 Controller	RS485/422 Device	RS232 Device (DCE)	
1	N/C	N/C	N/C	
2	RX -	TX -	TX	
3	TX +	RX +	RX	
4	GND	GND	GND	
5	GND	GND	GND	
6	GND	GND	GND	
7	RX +	TX +	N/C	
8	TX -	RX -	N/C	
9	GND	GND	GND	

Important:

The **Controller** and **Device** columns are shown in the table above for information; connection between SAM routers and SAM control panels require a pin to pin cable. Signal direction on the 9-way D-type is automatically swapped internally when the ports are defined as either controller or device ports.