

# Mach HD

## HD & SD Motion Compensated Standards Converter with Synchronizer, Up, Down, and Cross Conversion

# Operator's Manual

© December, 2008

Snell & Wilcox Ltd., Southleigh Park House, Eastleigh Road, Havant, Hants, PO9 2PE, United Kingdom.  
For General Enquiry's contact: Tel: +44 (0) 2392 489000 Fax: +44 (0)23 9245 1411  
For Technical assistance contact: Tel: +44 (0) 2392 489058 Fax: +44 (0) 2392 489057  
Web: <http://www.snellwilcox.com/support>  
Ftp: <ftp://ftp.snellwilcox.com/support>

## Explanation of Safety Symbols



- This symbol refers the user to important information contained in the accompanying literature. Refer to manual.
- This symbol indicates that hazardous voltages are present inside. No user serviceable parts inside. This unit should only be serviced by trained personnel.

## Safety Warnings



Servicing instructions where given, are for use by qualified service personnel only. To reduce risk of electric shock do not perform any servicing other than that contained in the operating instructions unless you are qualified to do so. Refer all servicing to qualified personnel.

- To reduce the risk of electric shock, do not expose this appliance to rain or moisture.
- Always ensure that the unit is properly earthed and power connections correctly made.
- This equipment must be supplied from a power system providing a PROTECTIVE EARTH (⊕) connection and having a neutral connection which can be reliably identified.
- The power outlet supplying power to the unit should be close to the unit and easily accessible

### Power connection in countries other than the USA

The equipment is normally shipped with a power cable with a standard IEC moulded free socket on one end and a standard IEC moulded plug on the other. If you are required to remove the moulded mains supply plug, dispose of the plug immediately in a safe manner.

The colour code for the lead is as follows:

- GREEN/YELLOW lead connected to E (Protective Earth Conductor)
- BLUE lead connected to N (Neutral Conductor)
- BROWN lead connected to L (Live Conductor)



- Caution If the unit has two mains supply inputs ensure that both power cords are plugged into mains outlets operating from the same phase.

## Légende :



- Ce symbole indique qu'il faut prêter attention et se référer au manuel.
- Ce symbole indique qu'il peut y avoir des tensions électriques à l'intérieur de l'appareil. Ne pas intervenir sans l'agrément du service qualifié.

## Précaution d'emploi :



Les procédures de maintenance ne concernent que le service agréé. Afin de réduire le risque de choc électrique, il est recommandé de se limiter aux procédures d'utilisation, à moins d'en être qualifié. Pour toute maintenance, contacter le service compétent.

- Pour réduire le risque de choc électrique, ne pas exposer l'appareil dans un milieu humide.
- Toujours s'assurer que l'unité est correctement alimentée, en particuliers à la liaison à la terre.
- La source électrique de cet équipement doit posséder une connexion à la terre (⊕), ainsi qu'une liaison « neutre » identifiable.
- La prise électrique qui alimente l'appareil doit être proche de celle-ci et accessible.

### Câble secteur de pays autres que les Etats-Unis

L'équipement est livré avec un câble secteur au standard IEC, moulé mâle/femelle.

Si vous souhaitez changer la prise mâle de votre cordon, voici les codes couleurs des fils :

- Le fil VERT/JAUNE est connecté à T (Terre)
- Le fil BLEU est connecté à N (Neutre)
- Le fil MARRON est connecté à P (Phase)



- Attention si l'appareil a 2 alimentations, s'assurer que les cordons soient branchés sur la même phase.

## Erklärung der Sicherheitssymbole



- Dieses Symbol weist den Benutzer auf wichtige Informationen hin, die in der begleitenden Dokumentation enthalten sind.
- Dieses Symbol zeigt an, dass gefährliche Spannung vorhanden ist. Es befinden sich keine vom Benutzer zu wartende Teile im Geräteinneren. Dieses Gerät sollte nur von geschultem Personal gewartet werden

## Sicherheits-Warnhinweise

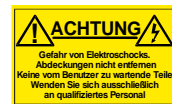

Die angeführten Service-/Reparatur-Anweisungen sind ausschließlich von qualifiziertem Service-Personal auszuführen. Um das Risiko eines Elektroschocks zu reduzieren, führen Sie ausschließlich die im Benutzerhandbuch eschriebenen Anweisungen aus, es sei denn, Sie haben die entsprechende Qualifikation. Wenden Sie sich in allen Service-Fragen an qualifiziertes Personal.

- Um das Risiko eines Elektroschocks zu reduzieren, setzen Sie das Gerät weder Regen noch Feuchtigkeit aus.
- Stellen Sie immer sicher, dass das Gerät ordnungsgemäß geerdet und verkabelt ist.
- Dieses Equipment muss an eine Netzsteckdose mit Schutzleiter angeschlossen werden und einen zuverlässig identifizierbaren Nullleiter haben.
- Die Netzsteckdose sollte nahe beim Gerät und einfach zugänglich sein.

### Netzanschluss in anderen Ländern als der USA

Das Equipment wird im Normalfall mit einem Netzkabel mit Standard IEC Anschlussbuchse und einem Standard IEC Anschlussstecker geliefert. Sollten Sie den angeschweißten Stecker auswechseln müssen, entsorgen Sie diesen bitte umgehend. Die farbliche Belegung des Netzkabels ist wie folgt:

- GRÜN GELB E = Schutzleiter (⊕)
- BLAU N = Nulleiter
- BRAUN L = P = Phase

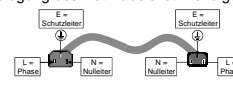

- Achtung: Wenn das Gerät zwei Anschlussbuchsen hat, stellen Sie bitte sicher, dass beide Netzkabel mit der selben Phase in die Netzsteckdose gesteckt werden.

## Explicación de los Símbolos de Seguridad



- Éste símbolo refiere al usuario información importante contenida en la literatura incluida. Referirse al manual.
- Éste símbolo indica que voltajes peligrosos están presentes en el interior. No hay elementos accesibles al usuario dentro. Esta unidad sólo debería ser tratada por personal cualificado.

## Advertencias de Seguridad



Las instrucciones de servicio cuando sean dadas, son sólo para uso de personal cualificado. Para reducir el riesgo de choque eléctrico no llevar a cabo ninguna operación de servicio aparte de las contenidas en las instrucciones de operación, a menos que se esté cualificado para realizarlas. Referir todo el trabajo de servicio a personal cualificado.

- Para reducir el riesgo de choque eléctrico, no exponer este equipo a la lluvia o humedad.
- Siempre asegurarse de que la unidad está propiamente conectada a tierra y que las conexiones de alimentación están hechas correctamente.
- Este equipo debe ser alimentado desde un sistema de alimentación con conexión a TIERRA (⊕) y teniendo una conexión neutra fácilmente identificable.
- La toma de alimentación para la unidad debe ser cercana y fácilmente accesible.

### Conexión de alimentación en otros países que no sean USA

El equipo es normalmente entregado con un cable de alimentación con un enchufe hembra estándar IEC en un extremo y con una clavija estándar IEC en el otro. Si se requiere eliminar la clavija para sustituirla por otra, disponer dicha clavija de una forma segura. El código de color a emplear es como sigue:

- VERDE/ AMARILLO conectado a E (Conductor de protección a Tierra -Earth en el original-)
- AZUL conectado a N (Conductor Neutro -Neutral en el original-)
- MARRÓN conectado a L (Conductor Fase -Live en el original-)

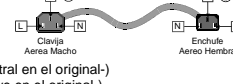

- Advertencia Si la unidad tuviera dos tomas de alimentación, asegurarse de que ambos cables de alimentación están conectados a la misma fase.

**Simboli di sicurezza:**

- Questo simbolo indica l'informazione importante contenuta nei manuali appartenenti all'apparecchiatura. Consultare il manuale.
- Questo simbolo indica che all'interno dell'apparato sono presenti tensioni pericolose. Non cercare di smontare l'unità. Per qualsiasi tipo di intervento rivolgersi al personale qualificato.

**Attenzione:**

Le istruzioni relative alla manutenzione sono ad uso esclusivo del personale qualificato. E' proibito all'utente eseguire qualsiasi operazione non esplicitamente consentita nelle istruzioni. Per qualsiasi informazione rivolgersi al personale qualificato.

- Per prevenire il pericolo di scosse elettriche è necessario non esporre mai l'apparecchiatura alla pioggia o a qualsiasi tipo di umidità.
- Assicurarsi sempre, che l'unità sia propriamente messa a terra e che le connessioni elettriche siano eseguite correttamente.
- Questo dispositivo deve essere collegato ad un impianto elettrico dotato di un sistema di messa a terra efficace.
- La presa di corrente deve essere vicina all'apparecchio e facilmente accessibile.

**Connessione elettrica nei paesi diversi dagli Stati Uniti**

L'apparecchiatura normalmente è spedita con cavo pressofuso con la presa e spina standard IEC. Nel caso della rimozione della spina elettrica, gettarla via immediatamente osservando tutte le precauzioni del caso. La leggenda dei cavi è la seguente:

VERDE/GIALLO cavo connesso ad "E" (terra)  
BLU cavo connesso ad "N" (neutro)  
MARRONE cavo connesso ad "L" (fase)



- Attenzione! Nel caso in cui l'apparecchio abbia due prese di corrente, assicurarsi che i cavi non siano collegati a fasi diverse della rete elettrica.

**Förklaring av Säkerhetssymboler**

- Denna symbol hänvisar användaren till viktig information som återfinns i litteraturen som medföljer. Se manualen.
- Denna symbol indikerar att livsfarlig spänning finns på insidan. Det finns inga servicevänliga delar inne i apparaten. Denna apparat få endast repareras av utbildad personal.

**Säkerhetsvarningar**

Serviceinstruktioner som anges avser endast kvalificerad och utbildad servicepersonal. För att minska risken för elektrisk stöt, utför ingen annan service än den som återfinns i medföljande driftinstruktionerna, om du ej är behörig. Överlätt all service till kvalificerad personal.

- För att reducera risken för elektrisk stöt, utsätt inte apparaten för regn eller fukt.
- Se alltid till att apparaten är ordentligt jordad samt att strömtillförseln är korrekt utförd.
- Denna apparat måste bli försörd från ett strömssystem som är försedd med jordanslutning (⏚) samt ha en neutral anslutning som lätt identifierbar.
- Vägguttaget som strömförsörjer apparaten bör finnas i närheten samt vara lättillgänglig.

**Strömkontakter i länder utanför USA**

Apparaten utrustas normalt med en strömkabel med standard IEC gjuten honkontakt på ena änden samt en standard IEC gjuten hankontakt på den andra änden. Om man måste avlägsna den gjutna hankontakten, avyttra denna kontakt omedelbart på ett säkert sätt. Färgkoden för ledningen är följande:

GRÖN/GUL ledning ansluten till E (Skyddsjordad ledare)  
BLÅ ledning ansluten till N (Neutral ledare)  
BRUN ledning ansluten till L (Fas ledare)



- Varning! Om enheten har två huvudsakliga elförsörjningar, säkerställ att båda strömkablarna som är inkopplade i enheten arbetar från samma fas.

**Forklaring på sikkerhedssymboler**

- Dette symbol gør brugeren opmærksom på vigtig information i den medfølgende manual.
- Dette symbol indikerer farlig spænding inden i apparatet. Ingen bruger servicebare dele i apparatet på brugerniveau. Dette apparat må kun serviceres af faglærte personer..

**Sikkerhedsadvarsler**

Serviceinstruktioner er kun til brug for faglærte servicefolk. For at reducere risikoen for elektrisk stød må bruger kun udføre anvisninger i betjeningsmanualen. Al service skal udføres af faglærte personer.

- For at reducere risikoen for elektrisk stød må apparatet ikke udsættes for regn eller fugt.
- Sørg altid for at apparatet er korrekt tilsluttet og jordet.
- Dette apparat skal forbindes til en nettilslutning, der yder BESKYTTENDE JORD (⏚) og 0 forbindelse skal være tydeligt markeret.
- Stikkontakten, som forsyner apparatet, skal være tæt på apparatet og let tilgængelig.

**Nettilslutning i andre lande end USA**

Udstyret leveres normalt med et strømkabel med et standard IEC støbt løst hanstik i den ene ende og et standard IEC støbt hanstik i den anden ende. Hvis et af de støbte stik på strømkablet er defekt, skal det straks kasseres på forsvarlig vis. Farvekoden for ledningen er som følger:

GRÖN/GUL leder forbundet til J (Jord)  
BLÅ leder forbundet til 0  
BRUN leder forbundet til F (Fase)



- Forsigtig Hvis enheden har to lysnetindgange, skal der sørges for at begge ledninger tilsluttes lysnetudgange fra den samme fase.

**Turvamerkkien selitys**

- Tämä merkki tarkoittaa, että laitteen mukana toimitettu kirjallinen materiaali sisältää tärkeitä tietoja. Lue käyttöohje.
- Tämä merkki ilmoittaa, että laitteen sisällä on vaarallisen voimakas jännite. Sisäpuolella ei ole mitään osia, joita käyttäjä voisi itse huoltaa. Huollon saa suorittaa vain alan ammattilainen.

**Turvaohjeita**

Huolto-ohjeet on tarkoitettu ainoastaan alan ammattilaisille. Älä suorita laitteelle muita toimenpiteitä, kuin mitä käyttöohjeissa on neuvottu, ellei ole asiantuntija. Voit saada sähköiskun. Jätä kaikki huoltotoimet ammattilaiselle.

- Sähköiskujen välttämiseksi suojaa laite sateelta ja kosteudelta.
- Varmistu, että laite on asianmukaisesti maadoitettu ja että sähkökytkennät on tehty oikein.
- Laitteelle tehoa syöttävässä järjestelmässä tulee olla SUOJAMAALITÄNTÄ (⏚) ja nolliälitännän on oltava luotettavasti tunnistettavissa.
- Sähköpistorasian tulee olla laitteen lähellä ja helposti tavoitettavissa.

**Sähkökytkentä**

Laitteen vakiovarusteena on sähköjohto, jonka toisessa päässä on muotittin valettu, IEC-standardin mukainen liitäntärasia ja toisessa päässä muotittin valettu, IEC-standardin mukainen pistoliitin. Jos pistoliitin tarvitsee poistaa, se tulee hävittää heti turvallisella tavalla. Johtimet kytketään seuraavasti:

KELTA-VIHREÄ suojamaajohtin E-napaan  
SININEN nollijohtin N-napaan  
RUSKEA vaihejohtin L-napaan



- Huom! Jos laitteessa on kaksi verkkojännitteen tuloliitäntää, niiden johdot on liitettävä verkkopistorasioihin, joissa on sama vaiheistus.

### Símbolos de Segurança



- O símbolo triangular adverte para a necessidade de consultar o manual antes de utilizar o equipamento ou efectuar qualquer ajuste.
- Este símbolo indica a presença de voltagens perigosas no interior do equipamento. As peças ou partes existentes no interior do equipamento não necessitam de intervenção, manutenção ou manuseamento por parte do utilizador. Reparações ou outras intervenções devem ser efectuadas apenas por técnicos devidamente habilitados.

### Avisos de Segurança



As instruções de manutenção fornecidas são para utilização de técnicos qualificados. Para reduzir o risco de choque eléctrico, não devem ser realizadas intervenções no equipamento não especificadas no manual de instalações a menos que seja efectuadas por técnicos habilitados.

- Para reduzir o risco de choque eléctrico, não expor este equipamento à chuva ou humidade.
- Assegurar que a unidade está sempre devidamente ligada à terra e que as ligações à alimentação estão correctas.
- O sistema de alimentação do equipamento deve, por razões de segurança, possuir ligação a terra de protecção (⊕) e ligação ao NEUTRO devidamente identificada.
- A tomada de energia à qual a unidade está ligada deve situar-se na sua proximidade e facilmente acessível.

#### Ligação da alimentação noutros países que não os EUA

O equipamento é, normalmente, enviado com cabo de alimentação com ficha IEC fêmea standard num extremo e uma ficha IEC macho standard no extremo oposto. Se for necessário substituir ou alterar alguma destas fichas, deverá remove-la e elimina-la imediatamente de maneira segura. O código de cor para os condutores é o seguinte:

Condutor VERDE/AMARELO ligado a E (Terra)  
 Condutor AZUL ligado a N (Neutro)  
 Condutor CASTANHO ligado a L (Vivo).



- Atenção: Se a unidade tem duas fontes de alimentação assegurar que os dois cabos de alimentação estão ligados a tomadas pertencentes à mesma fase.

### Επεξήγηση των Συμβόλων Ασφαλείας



- Αυτό το σύμβολο παραπέμπει το χρήστη σε σημαντικές πληροφορίες που συμπεριλαμβάνονται στο συνοδευτικό εγχειρίδιο.
- Αυτό το σύμβολο υποδεικνύει ότι στο εσωτερικό υφίστανται επικίνδυνες ηλεκτρικές τάσεις. Στο εσωτερικό δεν υπάρχουν επισκευάσιμα μέρη. Αυτή η μονάδα πρέπει να επισκευάζεται μόνο από ειδικά εκπαιδευμένο προσωπικό.

### Προειδοποίηση Ασφαλείας



Οδηγίες επισκευής, όπου παρέχονται, αναφέρονται αποκλειστικά και μόνο σε εξειδικευμένο προσωπικό. Για να μειωθεί ο κίνδυνος ηλεκτροπληξίας, μην εκτελείτε επισκευές παρά μόνο τις συμπεριλαμβανόμενες στο εγχειρίδιο των οδηγιών, εκτός και αν έχετε τα απαραίτητα προσόντα για να το κάνετε. Όλες οι επισκευές να εκτελούνται από ειδικά εκπαιδευμένο προσωπικό.

- Για να μειώσετε τον κίνδυνο ηλεκτροπληξίας μην εκθέτετε τη συσκευή σε βροχή ή υγρασία.
- Πάντα να εξασφαλίσετε τη σωστή γείωση της συσκευής και τη σωστή σύνδεση των συνδέσμων τροφοδοσίας.
- Ο εξοπλισμός πρέπει να τροφοδοτείται από ένα σύστημα τροφοδοσίας που να εξασφαλίζει ΠΡΟΣΤΑΤΕΥΤΙΚΗ ΓΕΙΩΣΗ (⊕) και να έχει καθορισμένες θέσεις ουδέτερου και φάσης.
- Ο εξοπλισμός που τροφοδοτεί τη συσκευή θα πρέπει να βρίσκεται κοντά στη συσκευή και να είναι εύκολα προσβάσιμος.

### Σύνδεση τροφοδοσίας σε χώρες εκτός των ΗΠΑ

Ο εξοπλισμός συνοδεύεται συνήθως από ένα καλώδιο τροφοδοσίας με ένα σταθερό βύσμα τροφοδοσίας ρεύματος τύπου πυραμίδας στη μια άκρη του και μια σταθερή υποδοχή τροφοδοσίας ρεύματος τύπου πυραμίδας στην άλλη άκρη του. Εάν χρειαστεί να αφαιρέσετε το σταθερό βύσμα τροφοδοσίας μην το επαναχρησιμοποιείτε, θεωρείται έχρηστο. Ο χρωματικός οδηγός για το καλώδιο τροφοδοσίας είναι ο παρακάτω:

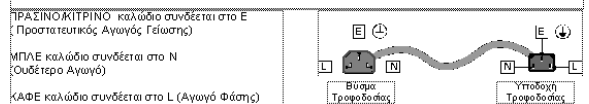

- ΠΡΟΣΟΧΗ! Αν η μονάδα έχει δύο τροφοδοτικά βεβαιωθείτε ότι και τα δύο καλώδια τροφοδοσίας είναι συνδεδεμένα σε εξόδους τροφοδοσίας που βρίσκονται στην ίδια φάση.

## Power cable supplied for the USA

The equipment is shipped with a power cord with a standard IEC molded free socket on one end and a standard 3-pin plug on the other. If you are required to remove the molded mains supply plug, dispose of the plug immediately in a safe manner. The color code for the cord is as follows:

- GREEN** lead connected to E (Protective Earth Conductor)
- BLACK** lead connected to L (Live Conductor)
- WHITE** lead connected to N (Neutral Conductor)



Note that for equipment that is not fitted with a mains power switch, to comply with EN60950 Clauses 1.7.2 and 2.6.9, the power outlet supplying power to the unit should be close to the unit and easily accessible.



## Safety Standard

The MACH HD conforms to the following standards:

**BS EN60950:2000** *Specification for safety of information technology equipment, including electrical business equipment.*

**UL 1419.** *Professional video equipment File No. E193966*

The MACH HD conforms to the following standard:

**BS EN60950:2001** *Specification for safety of information technology equipment, including electrical business equipment.*

## EMC Standards

These units conform to the following standards:

### **BS EN 55103-1 : 1997**

Electromagnetic Compatibility, Product family standard for audio, video, audio-visual and entertainment lighting control apparatus for professional use. Part 1. Emission

### **BS EN 55103-2 : 1997**

Electromagnetic Compatibility, Product family standard for audio, video, audio-visual and entertainment lighting control apparatus for professional use. Part 2. Immunity

Federal Communications Commission Rules Part 15, Class A :1998

## EMC Environment

The product(s) described in this manual conform to the EMC requirements for, and are intended for use in,

The controlled EMC environment (for example purpose-built broadcasting or recording studios), and the rural outdoor environment (far away from railways, transmitters, overhead power lines, etc.) E4

## EMC Performance of Cables and Connectors

Snell & Wilcox products are designed to meet or exceed the requirements of the appropriate European EMC standards. In order to achieve this performance in real installations it is essential to use cables and connectors with good EMC characteristics.

All signal connections (including remote control connections) shall be made with screened cables terminated in connectors having a metal shell. The cable screen shall have a large-area contact with the metal shell.

### COAXIAL CABLES

Coaxial cables connections (particularly serial digital video connections) shall be made with high-quality double-screened coaxial cables such as Belden 1694 or BBC type PSF1/2M.

### D-TYPE CONNECTORS

D-type connectors shall have metal shells making good RF contact with the cable screen. Connectors having "dimples" which improve the contact between the plug and socket shells, are recommended.

## About this Manual

This manual covers the installation and operation of the Mach HD Standards Converter.

## Packing List

The unit is supplied in a dedicated packing carton provided by the manufacturer and should not be accepted if delivered in inferior or unauthorized materials. Carefully unpack the carton and check for any shipping damage or shortages. Please retain the box and original packing materials in case the unit needs to be returned.

Enclosures:

- Product CD
- Mach HD
- Power cable

## Software Version Amendments

**Notes about Versions Fitted.....** 1.04

## Manufacturers Notice

Copyright protection claimed includes all forms and matters of copyrightable material and information now allowed by statutory or judicial law or hereinafter granted, including without limitation, material generated from the software programs which are displayed on the screen such as icons, screen display looks etc.

Reproduction or disassembly of embedded computer programs or algorithms prohibited.

**Copyrighted names:** Microsoft Windows™

Information in this manual and software are subject to change without notice and does not represent a commitment on the part of Snell & Wilcox Ltd. The software described in this manual is furnished under a license agreement and may not be reproduced or copied in any manner without prior agreement with Snell & Wilcox Ltd. or their authorized agents.



## Table of Contents

<b>About this Manual .....</b>	<b>6</b>
<b>Packing List.....</b>	<b>6</b>
<b>Software Version Amendments .....</b>	<b>6</b>
<b>Manufacturers Notice.....</b>	<b>6</b>
<b>Table of Contents .....</b>	<b>7</b>
<b>Description .....</b>	<b>8</b>
<b>Technical Profile .....</b>	<b>9</b>
<b>Installation.....</b>	<b>12</b>
<b>Operation via the Front Panel .....</b>	<b>17</b>
<b>Operation via the Web Interface .....</b>	<b>34</b>
<b>Appendix (Automated Aspect Ratio Control).....</b>	<b>47</b>
<b>Manual Revision Record.....</b>	<b>52</b>



## Description

The Mach HD is a HD/SD motion compensated standards and cross converter with synchronization capability.

In addition, the Mach HD handles embedded, AES (balanced and unbalanced) and analog audio, with a range of additional features such as aspect ratio conversion and color space conversion.

The Mach HD has dual redundant PSU capability, and is provided in a 1RU rack mounting housing with remote control capability via Ethernet.

### Front panel view



### Rear panel views



### Order Codes

- Mach HD (5068000)



## Technical Profile

### Product Features

Format conversion	SD (525i/625i) <> HD (720P/1080i) HD (720P) <> HD (1080i) Manual Zoom Control
Synchronization	HD to HD (720P/1080i) or SD to SD (525i/625i) HD/SD bi or tri sync reference Will also synchronize SD/HD output when up/down converting Cross-locking allowed: The output will lock to any input or reference of the same frequency. Ensures minimum latency and no frame drops or repeats when up/down converting.
Frame rate conversion	Motion-compensated frame rate conversion
Control	Via resident Web page or active front panel
Remote control	Ethernet: Enhanced TSL UMD (V4.0) protocol in direct UDP encapsulation. Multicast supported.
HANC data	PCM audio data (2 groups) processed. Other audio data is passed in same frame rate modes unless replaced by processed audio.
VANC data	Passed in same frame rate modes with same format in and out. Blanked in all other modes.
Processed audio	De-embed any channel (up to 2 groups). For SDI, audio must be PCM synchronous 48kHz. Embed to any 2 groups. Processed audio may be from external audio inputs or de-embedder and is simultaneously available on external audio outputs as the embedder source. Full sub-frame router with pair gain control.
Signalling	Decode incoming L23, Video Index and SMPTE 2016-1 (AFD) Real time clean conversion dependant on decoded signaling (if same frequency) Encode L23, Video Index and SMPTE 2016-1 (AFD) and insert on output

### External Interface Specification

Video input	2 x HD/SD SDI
Video output	2 x HD/SD SDI
Reference	Analog Bi/Tri sync in any operating video standard Loop-through. Impedance >20k (RL < -35dB to 10 MHz – target, not specified)
Digital video standards	SDI – 525i/625i (SMPTE 259M-C) HDSDI (SMPTE 292M) – 720P & 1080i @ 50, 59.94Hz
Input cable length	> 120m of Beldon 1694A @ 1.5Gbits/s > 350m of Beldon 1694A @ 270Mbits/s
Output jitter	HD timing jitter < 1UI HD alignment jitter < 0.2UI SD timing and alignment jitter < 0.2UI
Input/output return loss	< -15dB @ 1.5GHz
Remote control	10/100BaseT Ethernet
Indicators	Standby
Power Supply	2 x 100 – 240 VAC, 47 – 63Hz 0.4A. Three pin IEC power socket. Dual redundant

### Audio Options

2 x AES Output	Unbalanced BNC Balanced 25-way D type 48KHz PCM audio
2 x AES Input	Unbalanced BNC Balanced 25-way D type 48KHz PCM audio
AES output jitter	< 0.04UI
2 x Stereo Analog Audio Out	24 bit; THD , -91dB and +24dBu, flatness 20Hz – 20KHz ±0.05dB wrt 1KHz
2 x Stereo Analog Audio In	24 bit; < -87 dB at -1dBFS

## Control Features

Input select	A, B	Analog audio input level	+12 to +24dBu in 0.5 dBu steps
Manual image size	Zoom $\pm 20\%$	Analog audio output level	+12 to +24dBu in 0.5 dBu steps
Conversion scaling	Fit to height, 14:9, fit to width	Tone	Frequency: 100Hz to 10kHz in 100Hz steps
SD input format	Normal, anamorphic 16:9, letterbox 16:9	Genlock	Reference lock, input lock, free run. Genlock phase adjustment $\pm 0.5F$ in output pixel steps.
SD output format	Normal, anamorphic 16:9	Sync mode	Disables ARC feature when input and output formats are the same. Give lowest latency.
Pattern	Off, black, ramp, color bars	Signalling reader	The unit can be configured to automatically control the conversion depending on the read value of the incoming L23, VI, or SMPTE2016-1 (AFD) active format descriptors. When no valid signalling is recognized, the user can select whether to hold the current conversion or default to the current manual conversion setup. These conversions, assuming the input and output are of the same frequency, will be clean. Additional controls are provided to allow configuration of the format and standard of each of the signalling types: L23 - Standard ETSI/AFD - Line 10-23 VI - Standard SMPTE/AFD HD inputs only support SMPTE2016-1 (AFD), L23 is valid only on 625 inputs and VI on all SD inputs.
Conversion	Linear / motion compensated		
Black level	$\pm 100\text{mV}$ in 0.8mV steps		
Contrast	$\pm 6\text{dB}$ in 0.2dB steps		
Color saturation	$\pm 6\text{dB}$ in 0.2dB steps		
Gamma	Luminance only (black stretch). Range 0.4 to 1.7		
Freeze	Frame (synchronize mode) or field freeze (convert mode)		
Safe area markers	Off, 16:9, 4:3. Rectangular white marker box with color suppress. Vertical extent always 93% (16:9) or 70% (4:3)		
Processed audio source	For each processed channel: Analog A, Analog B, AES A, AES B, De-embed pair 1-8, tone, silence. Pair or channel routing options. Selection of balanced or unbalanced AES outputs.		
Audio gain	For each processed pair $\pm 18\text{dB}$ in 0.1dB steps.		
Embed group	Processed pairs A & B: 1, 2, 3, 4, Off (priority selection) Processed pairs c & D: 1, 2, 3, 4, Off		
AES output source 1 & 2	Processed pairs A & B (fixed – no control)		
DAC output source 1 & 2	Processed pairs A & B (fixed – no control)		



**Output signaling** Individual control for each of L23, VI and SMPTE2016-1 (AFD) to be inserted on the output, to allow Automatic generation, deletion, passing or always forcing to a user configured value. There are also a number of controls to allow configuration of the format and standard of the output signalling:

**L23**

- Standard ETSI/AFD
- Line 10 – 23
- pass/setting of non Aspect ratio bits

**VI**

- standard SMPTE/AFD
- pass/delete non AFD data

SMPTE 2016 is valid on all output standards, VI is valid on SD outputs and L23 is valid only on 625 outputs.

**DHCP** Enables/disables DHCP address discovery.

**IP Address** Manual setting of static IP address for non-DHCP networks (Default IP address 192.168.0.100), net mask, default gateway.

**Processing**

**Scaling/De-interlacing** Horizontal scaling employs a linear filter

**Color matrix** Automatic correction with HD/SD conversions

**Data width** >= 10 bit YCbCr throughout

**Processing delay** Minimum delay in synchronize mode (ARC disabled): 80µs (SD), <40µs (HD)  
Conversion delay 60ms typ.

**Audio** ADC/DAC conversion is 24 bit  
Digital audio is 24 bit throughout  
Delay smoothly tracks video delay  
Minimum audio delay < 3ms

**General**

**Dimensions** H44mm x W440mm x D255mm

**Weight** 2.25kg

## Installation

### Power Connections

The MACH HD unit has two IEC320 mains power connectors suitable for a standard IEC type power. A cable fitted with fused type plug should be used and a fuse rated at 3A installed.

### Supply Voltage

The power supply is auto switching for input voltages in the ranges of 100 V to 240 V nominal.

No voltage adjustment procedure is required.



**CAUTION: THIS UNIT MUST NOT BE OPERATED WITHOUT AN EARTH CONNECTION.**

### Power On/Off Switch

There is no power On/Off switch. The switch on the front panel is a standby switch.

Power ON will be indicated by the illumination of the front panel display. Standby mode is indicated by a red LED on the front panel.

*Note that for equipment that is not fitted with a mains power switch, to comply with EN60950 Clauses 1.7.2 and 2.6.9, the power outlet supplying power to the unit should be close to the unit and easily accessible.*

## Input Connections

### HDSDI/SDI In

There are two SD/HD SDI inputs to the unit via BNC connectors.



### Reference

Where suitable signals are connected to this input, the video output of the unit will be synchronized to the reference signal source when the genlock function is selected. If no signal is present, the unit will automatically revert to internal free-running operation.

BNC loop-through connectors are provided and the signal may black burst or Trisync video at standard level.

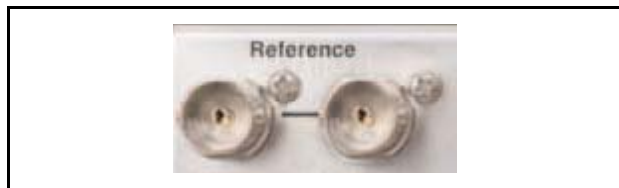

### Audio AES In (Unbalanced)

There are two AES Audio inputs to the unit via BNC connectors.



### Audio AES In (Balanced)

AES audio input is via the 25 way D-Type connector.



### Analogue Audio

Analogue audio input is via the 25 way D-Type connector.

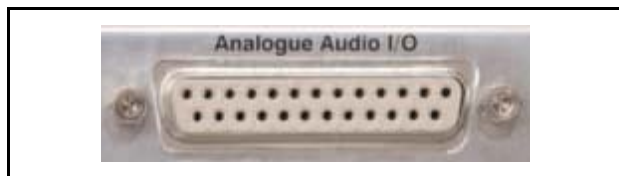

### Output Connections

#### HDSDI/SDI Out

There are two SD/HD SDI outputs from the unit via BNC connectors.



#### Audio AES Out (Unbalanced Option)

There are two AES Audio outputs from the unit via BNC connectors.

AES Out A outputs the audio selected for processed pair A, and AES Out B outputs the audio selected for processed pair B.



#### Audio AES Out (Balanced Option)

There are two AES Audio outputs from the unit via the 25 way D-Type connector.

AES Out A outputs the audio selected for processed pair A, and AES Out B outputs the audio selected for processed pair B.



#### Analogue Audio

Analogue audio Output is via the 25 way D-Type connector.

There are two stereo analog outputs available from this connector, containing the audio selectee for processed pair A and processed pair B respectively.

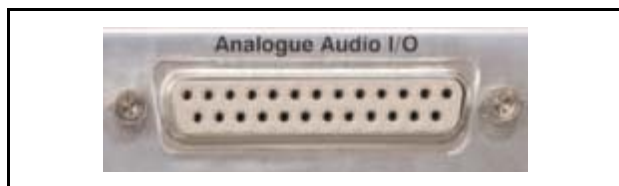

### Control Connections

#### Ethernet

Connection to a Web browser can be made via the 10/100 BaseT Ethernet connection.



**Analog Input/Output Pin Connections**

**AES Input/Output Pin Connections**

25 D-Sub Pin Description (Analog Input/Output)		
Pin	Name	Signal
1	Chassis	Ground
14	GND1	Analog In Pair 1 Left G
2	1+	Analog In Pair 1 Left +
15	1-	Analog In Pair 1 Left -
3	2+	Analog In Pair 1 Right +
16	2 -	Analog In Pair 1 Right -
4	GND2	Analog In Pair 1 Right G
17	GND3	Analog In Pair 2 Left G
5	3+	Analog In Pair 2 Left +
18	3-	Analog In Pair 2 Left -
6	4+	Analog In Pair 2 Right +
19	4-	Analog In Pair 2 Right -
7	GND4	Analog In Pair 2 Right G
20	GND5	Analog Out Pair 1 Left G
8	5+	Analog Out Pair 1 Left +
21	5-	Analog Out Pair 1 Left -
9	6+	Analog Out Pair 1 Right +
22	6_	Analog Out Pair 1 Right -
10	GND6	Analog Out Pair 1 Right G
23	GND7	Analog Out Pair 2 Left G
11	7+	Analog Out Pair 2 Left +
24	7-	Analog Out Pair 2 Left -
12	8+	Analog Out Pair 2 Right +
25	8-	Analog Out Pair 2 Right -
13	GND8	Analog Out Pair 2 Right G

25 D-Sub Pin Description (AES Input/Output)		
Pin	Name	Signal
1	Chassis	No Connection
14	GND1	AES In Pair 1 Left G
2	1+	AES In Pair 1 Left +
15	1-	AES In Pair 1 Left -
3	2+	AES In Pair 2 Right +
16	2 -	AES In Pair 2 Right -
4	GND2	AES In Pair 2 Right G
17	GND3	No Connection
5	3+	No Connection
18	3-	No Connection
6	4+	No Connection
19	4-	No Connection
7	GND4	No Connection
20	GND5	AES Out Pair 1 Left G
8	5+	AES Out Pair 1 Left +
21	5-	AES Out Pair 1 Left -
9	6+	AES Out Pair 2 Right +
22	6_	AES Out Pair 2 Right -
10	GND6	AES Out Pair 2 Right G
23	GND7	No Connection
11	7+	No Connection
24	7-	No Connection
12	8+	No Connection
25	8-	No Connection
13	GND8	No Connection

**D-Type Connector (On Unit)**

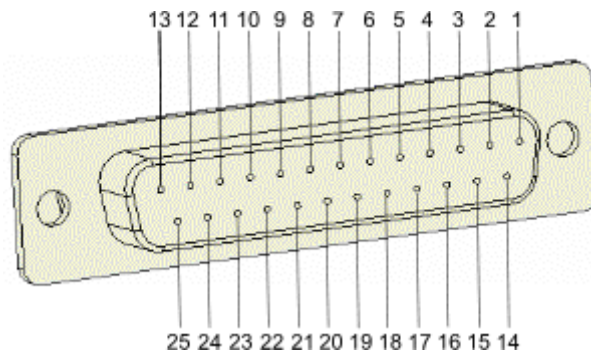



**Block Diagram**

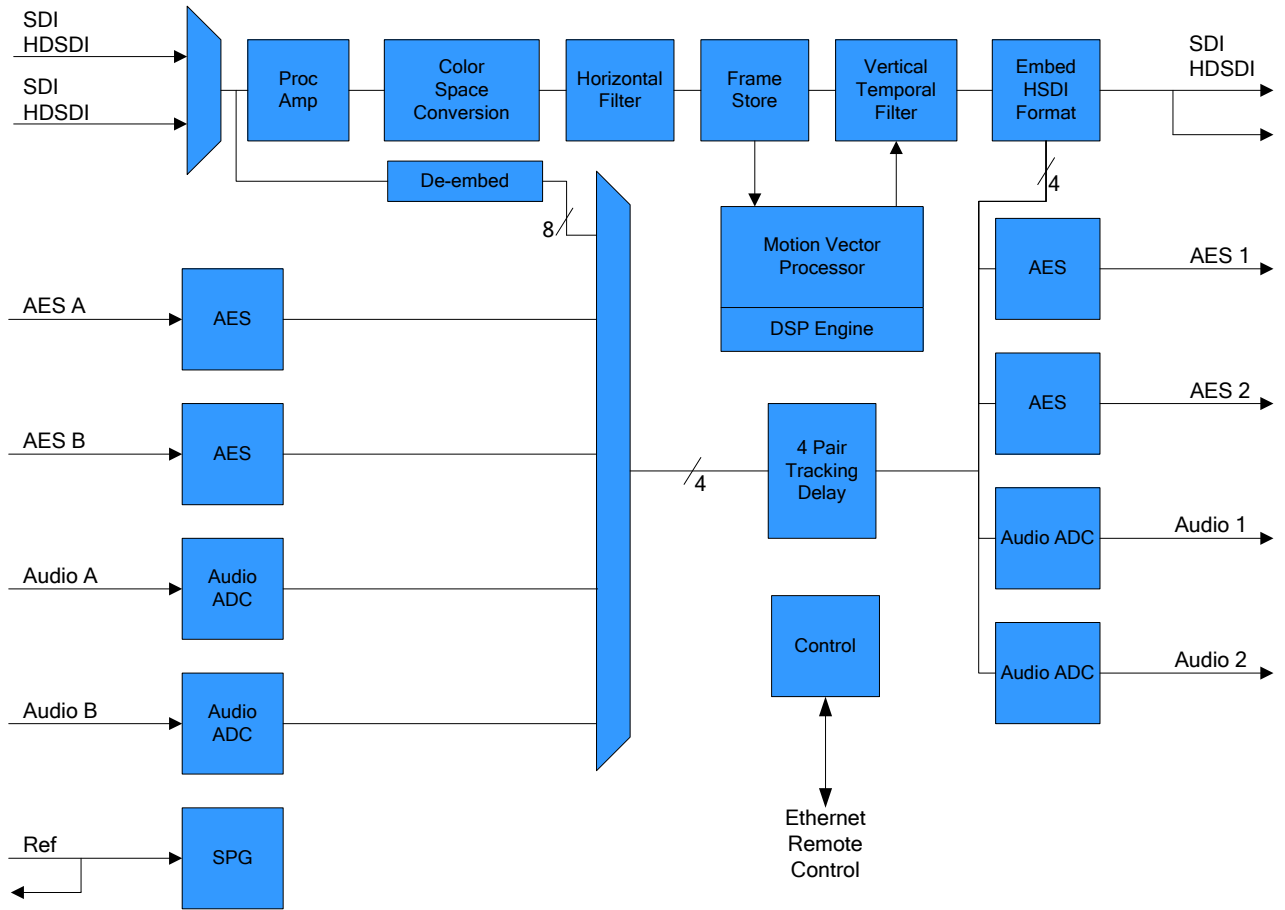

## Operation via the Front Panel

The layout of the active front panel is shown below. Applying power activates the unit; if it was powered down in standby mode, switch on using the standby button. Direct access functions are available via six buttons. The action of the control knob and function selection buttons is indicated by the display and varies depending upon the mode selected.

Note that certain settings and functions cannot be adjusted by means of the front panel, and can only be adjusted by means of the Web interface. These are:

- Net Mask
- Default IP Add
- Default Gateway

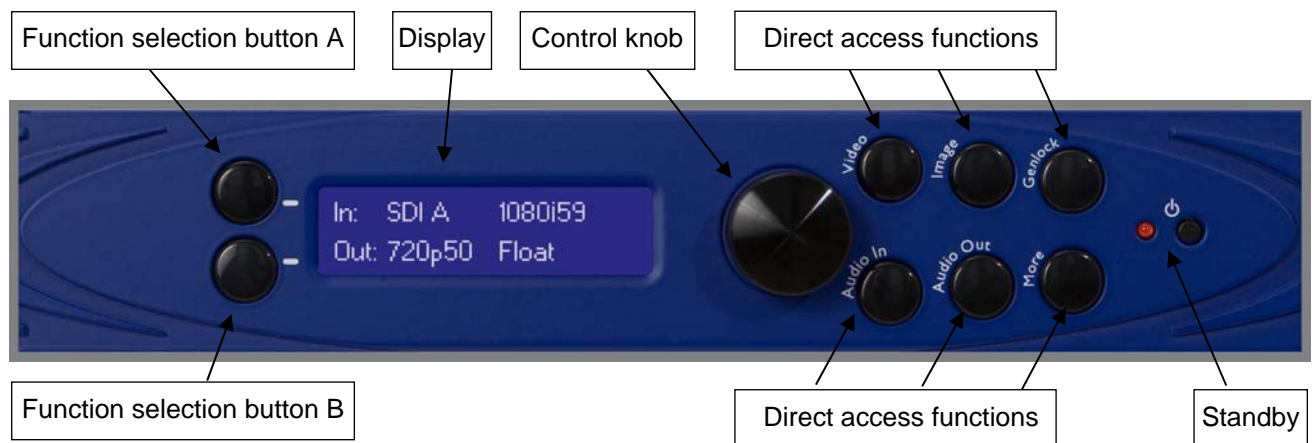

Item	Description
Standby	When the unit is switched off the LED is illuminated. When the unit is switched on the display and controls are active and the LED is extinguished.
Display	Provides status and control information
Control knob	Rotate to scroll through functions
Function selection button A	This button has two functions <ul style="list-style-type: none"> <li>• This button toggles between the default screen (showing the status of the input, output and genlock) and the Input selection screen.</li> <li>• When the word 'Back' is shown on the display adjacent to this button, pressing it returns to the previous menu.</li> </ul>
Function selection button B	The button has three functions <ul style="list-style-type: none"> <li>• This selects the Output selection screen.</li> <li>• When the word 'Select' is shown on the display adjacent to this button, pressing it selects the desired user selection</li> <li>• When the word 'Preset' is shown on the display adjacent to this button, pressing it presets the chosen control.</li> </ul>
Direct access functions	These buttons provide access to the unit's Video, Image, Genlock, Audio In and Audio Out menus, as well as to the More menu, which provides access to additional setup functions.



**Selected items - indication**

Selected items are highlighted with a – sign at the beginning and end of the name.

**Default display**

The product defaults to show the state of the input and output.



**Upper Soft Button**

This will allow the input signal type to be selected.

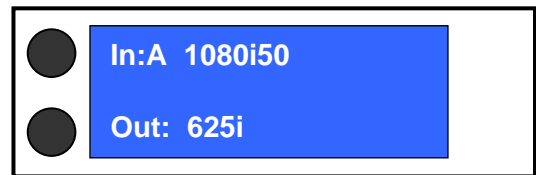

**Input Options**

- A
- B

The selected input is indicated by dashes (-) at either end of the name.

Rotate the knob to show alternate input and then press Select.

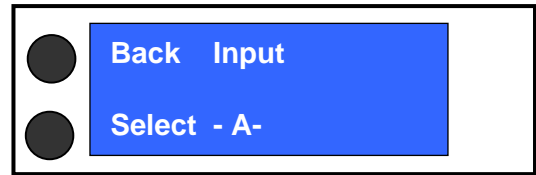

**Note that for this and most other menus:**  
To return to the default menu press **Back** or wait for the time out.



**Lower Soft Button**

This will allow the format of the output signal to be selected.

**Output Options**

- 625i
- 525i
- 720P50
- 720P59.94
- 1080i50
- 1080i59.94

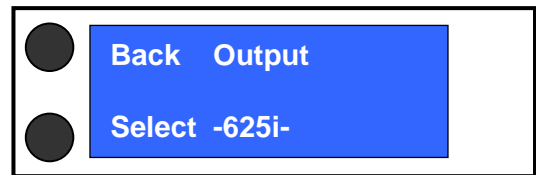

## ● Video

### Video Controls

#### Black Level

Rotate the knob to adjust the Black Level by  $\pm 100\text{mV}$  in  $0.8\text{mV}$  steps.

Preset will return the Black Level to  $0\text{mV}$ .

●	Back	Black Level
●	Preset	0.0mV

#### Y Gama

Rotate the knob to select the Y gamma curve between 0.4 and 1.7 in 0.1 steps

Preset will return the Y Gama 0.

●	Back	Y Gama
●	Preset	0

#### Contrast

Rotate the knob to adjust the Luma Gain by  $\pm 6\text{dB}$  in  $0.2\text{dB}$  steps.

Preset will return the Luma Gain to  $0\text{dB}$ .

●	Back	Contrast
●	Preset	0.0dB

#### Color Saturation

Rotate the knob to adjust the Chroma Gain by  $\pm 6\text{dB}$  in  $0.2\text{dB}$  steps.

Preset will return the Chroma Gain to  $0\text{dB}$ .

●	Back	Color Saturation
●	Preset	0.0dB



## Image

### Image Controls

#### Motion Process

When enabled (**On**), the Mach HD uses powerful motion compensation techniques when standards converting. When disabled (**Off**), standards conversions are performed with a linear process.

#### Auto Zoom

Enables (**On**) or disables (**Off**) the auto zoom function.

#### Manual Zoom

Rotate the knob to adjust the zoom from 120% to 80%.

#### Convert Scaling

Rotate the knob to select conversion scaling method. The available options are:

- Fit to Height
- 14:9
- Fit to Width

#### SD Input Format

Rotate the knob to select the SD input format. The available options are:

- Normal 4:3
- 16:9 LB
- 16:9 An

#### SD Output Format

Rotate the knob to select the SD output format. The available options are:

- Normal 4:3
- 16:9 An

#### Sync Mode

When Sync Mode is On, the scaling filters are disabled, giving transparent operation while using the unit as a synchronizer. This control is only effective if the input and output formats are identical.

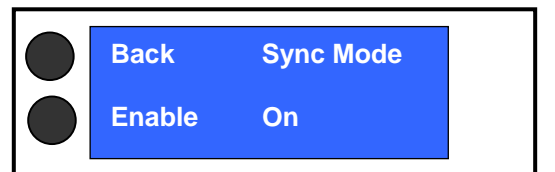
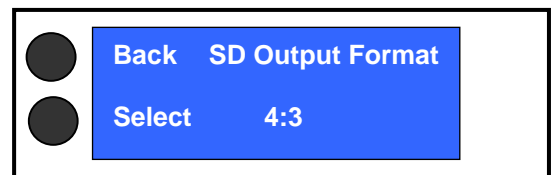
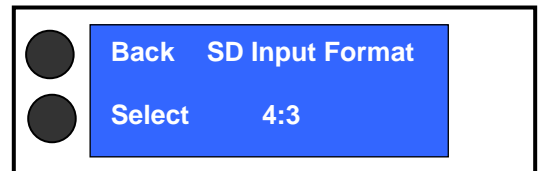
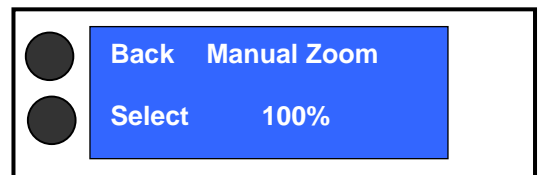
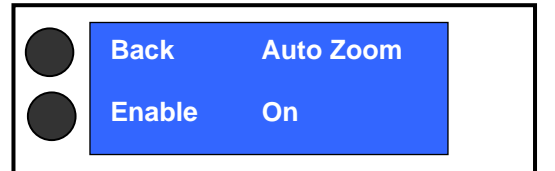
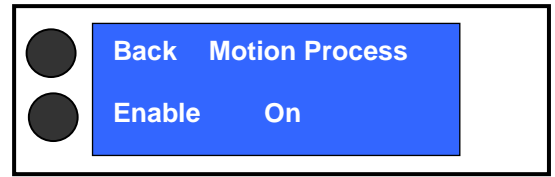

### Aperture

Rotate the knob to adjust the detail content of the output image.

- **Sharp** preserves the most vertical resolution from the input pictures.
- **Normal** provides the best compromise for typical input pictures.
- **Soft** is designed to prevent objectionable aliases in the output pictures.

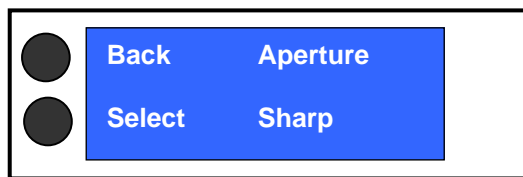

## ● Audio In

### Audio Input Controls

#### Audio in A - Left

This specifies the Left audio A input source. Rotate the knob to select from the following options:

- De-embed ch 1 to De-embed ch 16
- Analog A – Left
- Analog A – Right
- Analog B – Left
- Analog B – Right
- AES A – Left
- AES A – Right
- AES B – Left
- AES B – Right
- Tone
- Silence

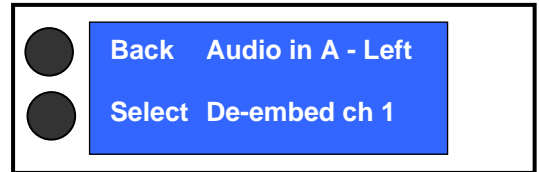

#### Audio in A – Right

This specifies the right audio A input source. Selections are the same as Audio in A – Left.

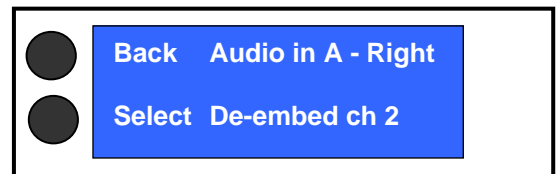

#### Pair Routing A

This control Enables or Disables pair routing for audio input pair A.

Select Pair Routing, for example, for stereo audio inputs. With Pair Routing enabled and after selecting a source for Audio in A – Left, the unit will automatically route the corresponding channel to Audio in A – Right. E.g. If De-embed ch 8 is selected for Audio in A – Left the unit will automatically route ch 9 to Audio in A – Right.

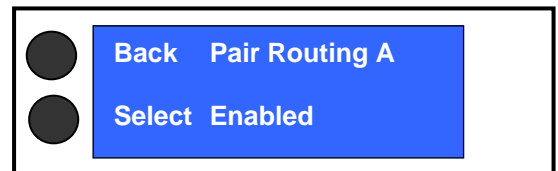

#### Audio in B – Left

This specifies the Left audio B input source. Selections are the same as Audio in A – Left.

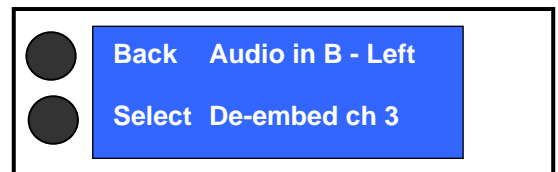

#### Audio in B – Right

This specifies the right audio B input source. Selections are the same as Audio in A – Left.

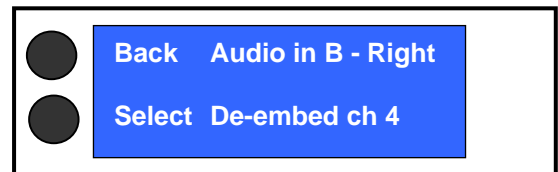

#### Pair Routing B

This control Enables or Disables pair routing for audio input pair B.

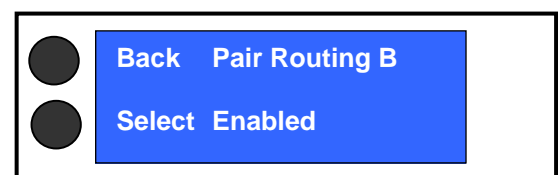



**Audio in C – Left**

This specifies the Left audio C input source.  
Selections are the same as Audio in A – Left.

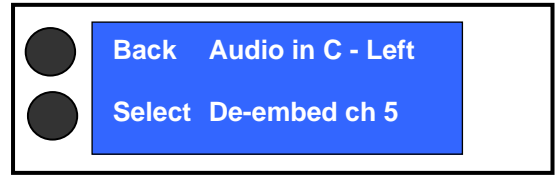

Control panel for Audio in C - Left. It features two circular buttons on the left. The top button is labeled 'Back Audio in C - Left' and the bottom button is labeled 'Select De-embed ch 5'.

**Audio in C – Right**

This specifies the right audio C input source.  
Selections are the same as Audio in A – Left.

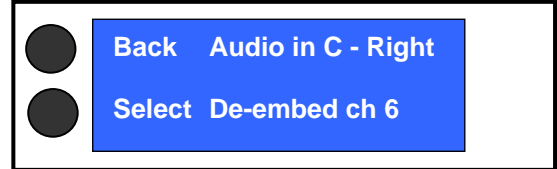

Control panel for Audio in C - Right. It features two circular buttons on the left. The top button is labeled 'Back Audio in C - Right' and the bottom button is labeled 'Select De-embed ch 6'.

**Pair Routing C**

This control Enables or Disables pair routing for audio input pair C.

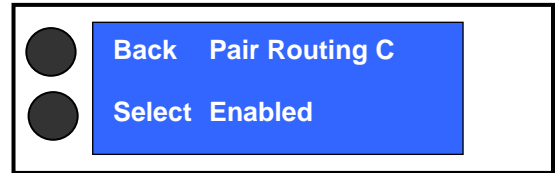

Control panel for Pair Routing C. It features two circular buttons on the left. The top button is labeled 'Back Pair Routing C' and the bottom button is labeled 'Select Enabled'.

**Audio in D – Left**

This specifies the Left audio D input source.  
Selections are the same as Audio in A – Left.

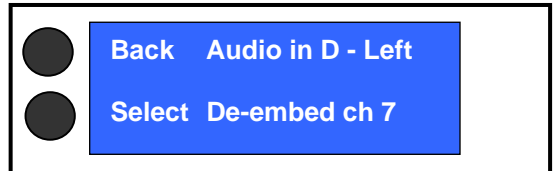

Control panel for Audio in D - Left. It features two circular buttons on the left. The top button is labeled 'Back Audio in D - Left' and the bottom button is labeled 'Select De-embed ch 7'.

**Audio in D – Right**

This specifies the right audio D input source.  
Selections are the same as Audio in A – Left.

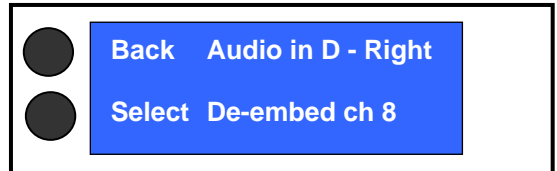

Control panel for Audio in D - Right. It features two circular buttons on the left. The top button is labeled 'Back Audio in D - Right' and the bottom button is labeled 'Select De-embed ch 8'.

**Pair Routing D**

This control Enables or Disables pair routing for audio input pair D.

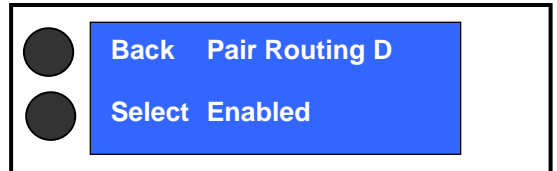

Control panel for Pair Routing D. It features two circular buttons on the left. The top button is labeled 'Back Pair Routing D' and the bottom button is labeled 'Select Enabled'.

### ADC A Headroom

Rotate the knob to adjust the ADC A headroom between +12 dBu and +24dBu in 0.5dB steps

The preset value is 18dBu.

Note that if the applied audio level exceeds the value set for the Headroom the processed audio will be clipped.

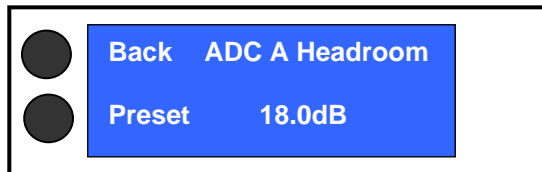

### ADC B Headroom

Rotate the knob to adjust the ADC B headroom between +12 dBu and +24dBu in 0.5dB steps

The preset value is 18dBu.

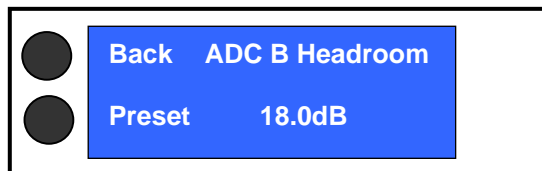

### Tone Frequency

Rotate the knob to adjust the tone frequency between 100Hz and 10kHz in 100Hz steps.

The preset value is 1000Hz.

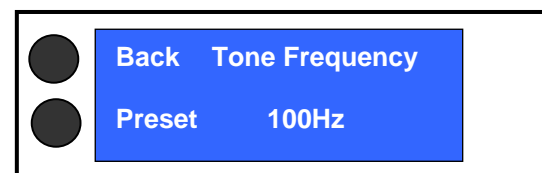

### AES Source

Rotate the knob to determine whether balanced or unbalanced AES inputs are used in the Audio In selection process.

- Balanced
- Unbalanced

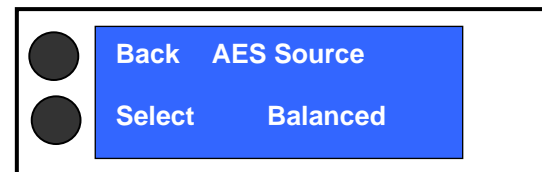

## ● Audio Out

### Audio Output Controls

#### Gain Pair A

This control adjusts the gain on audio pair A (L & R).

Rotate the knob to adjust the pair gain  $\pm 18$ dB in 0.1dB steps.

The preset value is 0dB.

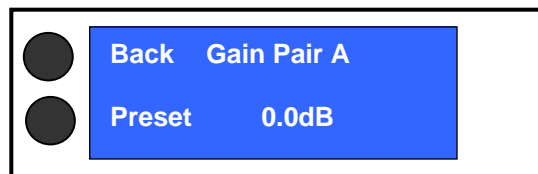

#### Gain Pair B

This control adjusts the gain on audio pair B (L & R).

Rotate the knob to adjust the pair gain  $\pm 18$ dB in 0.1dB steps.

The preset value is 0dB.

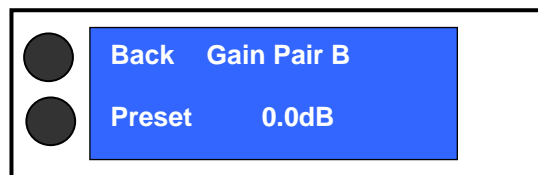

#### Gain Pair C

This control adjusts the gain on audio pair C (L & R).

Rotate the knob to adjust the pair gain  $\pm 18$ dB in 0.1dB steps.

The preset value is 0dB.

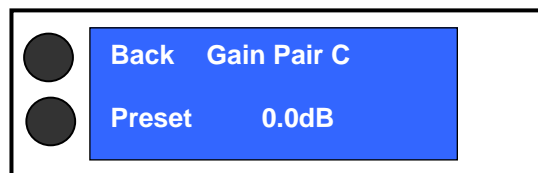

#### Gain Pair D

This control adjusts the gain on audio pair D (L & R).

Rotate the knob to adjust the pair gain  $\pm 18$ dB in 0.1dB steps.

The preset value is 0dB.

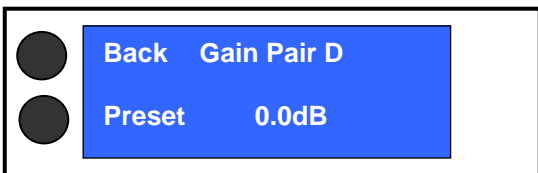

### Embed grp pair AB

Select the embed group for audio selected under the Audio A and Audio B tabs. Audio A will be embedded into pair 1 of the selected group and Audio B will be embedded to pair 2.



### Embed grp pair CD

Select the embed group for audio selected under the Audio A and Audio B tabs. Audio A will be embedded into pair 1 of the selected group and Audio B will be embedded to pair 2. Note that if the same group is selected for AB and CD only audio AB will be embedded.

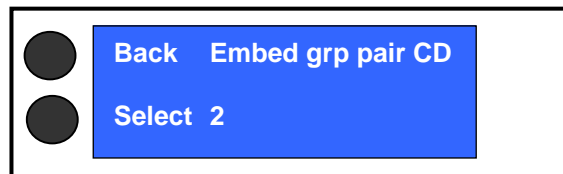

### DAC 1 Level

Use the rotary control to adjust the DAC 1 audio output level for 0dBFS between +12 dBu and +24dBu in 0.5dB steps

DAC 1 outputs audio selected under the Audio A tab.

The preset value is 18.0 dBu.

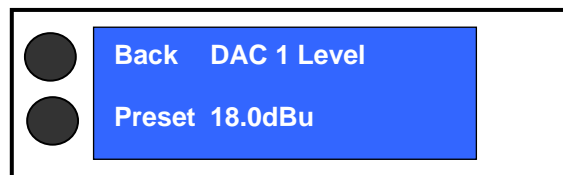

### DAC 2 Level

Use the rotary control to adjust the DAC 2 audio output level for 0dBFS between +12 dBu and +24dBu in 0.5dB steps

DAC 2 outputs audio selected under the Audio B tab.

The preset value is 18.0 dBu.

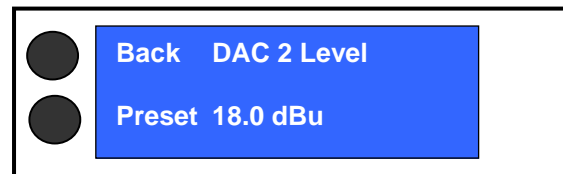

## ● Genlock

### Genlock

The selected genlock mode is indicated by – signs at either end of the name.

Rotate the knob to show the alternative Genlock modes (Ref Lock, Input Lock, Follow input, Freerun) and then press Select.

Repeated presses of the Genlock button will move through the following menus.

### HD Gen phase

HD Gen phase is used to specify the phase offset between the reference and the HDSDI output when outputting HD in Reference Lock mode with an appropriate HD reference applied.

Rotate the knob to select the genlock offset between +32us and -32us in 13.5ns steps

Preset is 0us.

### SD Gen phase

SD Gen phase is used to specify the phase offset between the reference and the SDDSI output when outputting SD in Reference Lock mode with an appropriate SD reference applied.

Rotate the knob to select the genlock offset between +32us and -32us in 37ns steps

Preset is 0us.

## Genlock

### Reference Lock

Output video is locked to an external reference. The offset between the external reference and the output can be adjusted over a range of approximately +/- 32us using the Genlock phase controls.

### Input Lock

Output video, if the same line and frame standard, is locked to the selected input video source. When converting between line or frame standards this mode is not available.

### Follow input

In this mode the output will lock the frame rate of the output to the input. When converting between frame standards this mode is not available. This mode allows the locking of SD to HD and vice versa when both are of the same frame rate, and so prevents frame drops or repeats appearing on the output.

### Free run

Output video is locked to an internal reference clock.

**Note:** The Reference Lock and Input Lock modes will only lock when the output is exactly the same format as the reference or input. For example, 720p 50 will not lock to 1080i 50.

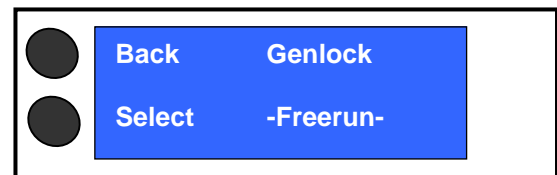
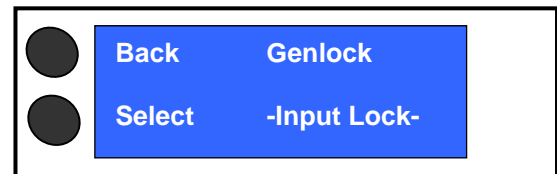
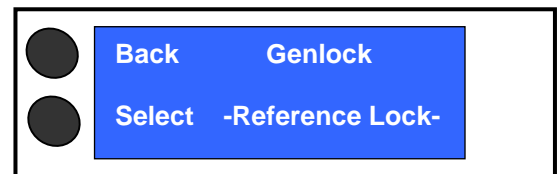
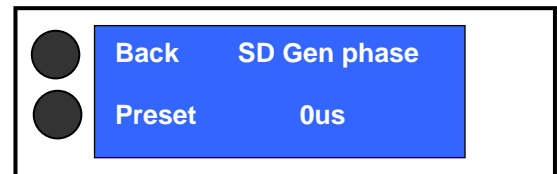
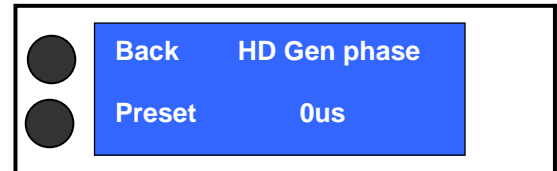



**More: Additional menu items**

The More menu enables further menus to be accessed. Rotate the knob to the desired function then press select.

*Note that the text in the upper right hand area of the display shows the previous function and the text in the lower right hand area shows the next function.*

**More (1) / Image**

**Pattern**

This control enables and disables the pattern output, and specifies the type of pattern output if enabled.

Rotate the control knob to select one of the following options:

- Off
- Ramp
- Bars
- Black

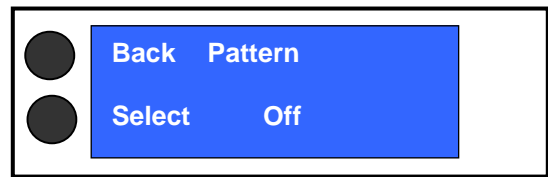

**Freeze**

This control freezes the output when enabled.



**Safe Area Marks**

Markers may be inserted appropriate to the output aspect ratio to indicate the nominal safe area. The safe area is 93% of the effective picture height and width.

- Off
- 16:9
- 4:3



### In Signaling (SD)

Rotate the control knob to select which input signaling type should be enabled for an SD source, and if applicable, how it should be interpreted.

See "Operation via the Web interface" for more details.

- SMPTE2016
- VI SMPTE
- VI AFD
- L23 AFD
- L23 ETSI



### L23 In Line

Rotate the control knob to select which source line will be used for L23 signaling extraction.

See "Operation via the Web interface" for more details.

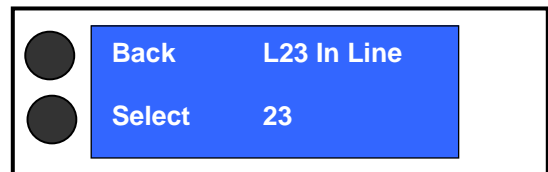

### L23 Out Line

Rotate the control knob to select which line to embed L23 signaling on at the output.

See "Operation via the Web interface" for more details.

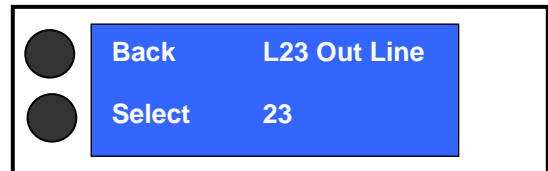

### L23 Out

Rotate the control knob to select how L23 signaling is generated at the output.

See "Operation via the Web interface" for more details.

- Auto
- Pass
- Force
- Delete

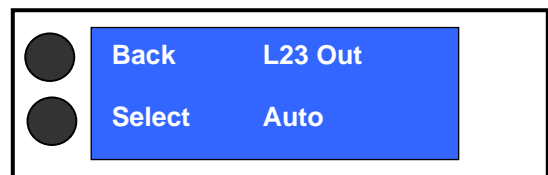

### L23 Out Format

Rotate the control knob to select which L23 signaling standard should be used

See "Operation via the Web interface" for more details.

- AFD
- ETSI
- Force
- Delete

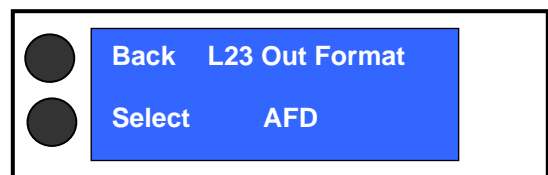



### L23 user bits

Rotate the control knob to select the user set enhanced L23 bits. (Enabled by L23 force bits)

See "Operation via the Web interface" for more details.

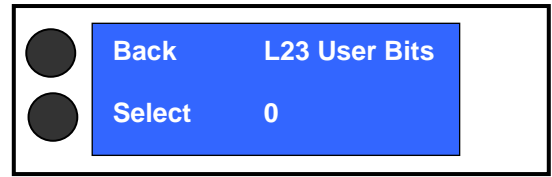

### L23 force bits

Rotate the control knob to determine whether the L23 user bits control should be actioned

See "Operation via the Web interface" for more details.

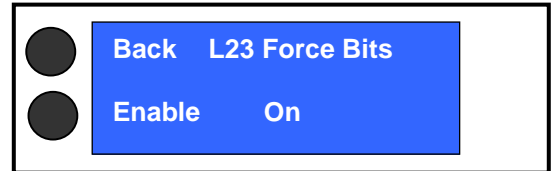

### VI Out

Rotate the control knob to select how the VI signaling is generated at the output.

See "Operation via the Web interface" for more details.

- Auto
- Pass
- Force
- Delete



### VI Out Format

Rotate the control knob to select which VI signaling standard should be used

See "Operation via the Web interface" for more details.

- SMPTE
- AFD

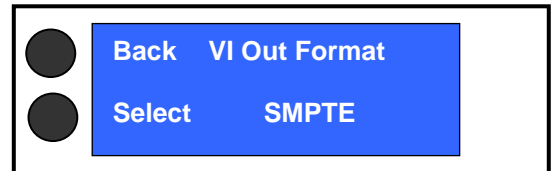

### VI Pass Data

Rotate the control knob to select whether the VI data other than coded frame and AFD are blanked, or passed from the input if selected.

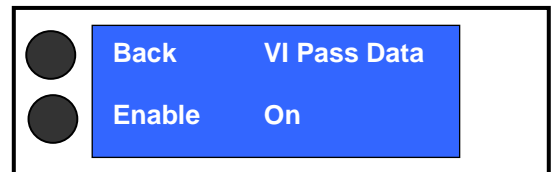

### SMPTE 2016 Out

Rotate the control knob to select how the SMPTE 2016 signaling is generated at the output.

See "Operation via the Web interface" for more details.

- Auto
- Pass
- Force
- Delete

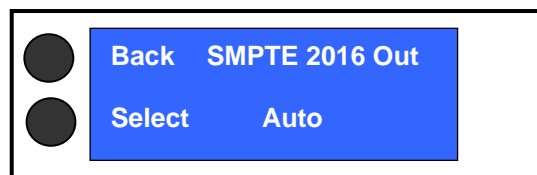

### Force RP186

Rotate the control knob to select the coded frame to be sent when VI Out is set to "Force"

See "Operation via the Web interface" for more details.

- 4/3
- 16/9

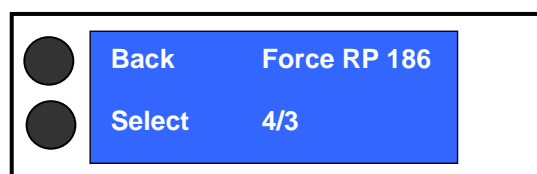

### Force AFD

Rotate the control knob to select the AFD to be sent when VI or L23 signaling has been forced, and the Out mode is set to AFD.

See "Operation via the Web interface" for more details.

- 4/3 AFD 0 to 7
- 16:9 AFD 0 to 7

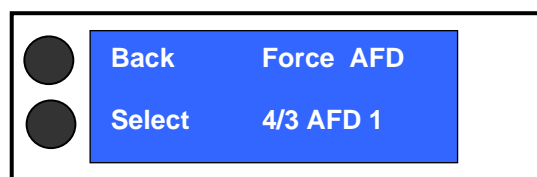

### Force ETSI

Rotate the control knob to select the ETSI code to be sent when L23 signaling has been forced, and the Out mode is set to ETSI.

See "Operation via the Web interface" for more details.

- 4/3 FF
- 14/9 centre
- 14/9 top
- 16/9 centre
- 16/9 top
- >16/9 centre
- 4:3 SP 14/9
- 16/9 FF

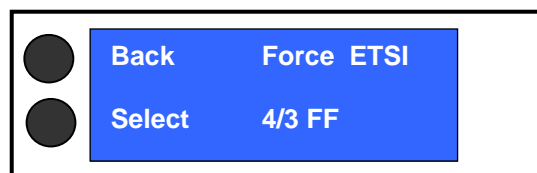

**Force 2016**

Rotate the control knob to select the AFD to be sent when SMPTE 2016 signaling has been forced.

See "Operation via the Web interface" for more details.

- 4/3 AFD 0 to 7
- 16:9 AFD 0 to 7

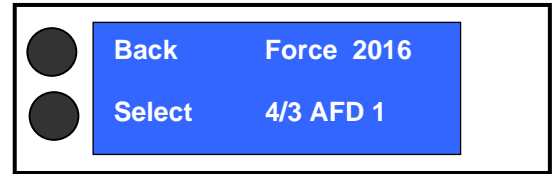

**More (2) / Initial Set-Up**

The Mach HD can be controlled by means of a Web interface via an Ethernet connection. These settings allow the connection details of the unit, such as its IP address to be specified.

**DHCP**

To use a dynamically assigned IP address from a DHCP server, enable the DHCP option.

If a DHCP server is not available, the unit details must be configured as described below.

**Net Mask, Default IP Add, Default Gateway**

These parameters can be adjusted on the Initial Setup tab of the Web interface. Currently, there is no means of setting these parameters from the front panel.

**IP Multicast**

This sets the IP multi-cast group to which the unit may be assigned for simultaneous control of multiple units.

**ID Multicast**

Sets the individual unit identity within the multicast group.

**More (3) / About**

**Version**

This displays the software version number of the unit.

**IP**

This displays the unit's current IP address.

In DHCP mode, it will display 0.0.0.0 when disconnected from the network.

**MAC Address**

This displays the unit's MAC address.

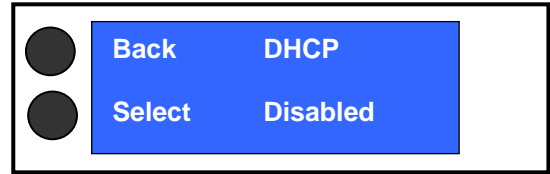

## Operation via the Web Interface

In addition to the unit front controls, the Mach HD can also be controlled by means of a Web interface accessed via the 10/100 BaseT Ethernet connection.

Connection to the Web interface can either be made directly or via a DHCP network.

### To connect directly to a PC or laptop:

1. Connect the unit to the network port of the PC using a 'cross-wired' Ethernet cable (RJ45).
2. Click the Windows **Start** button and select **Control Panel > Network Connections** then select the network **Local Area Connection**. If several local connections are shown, ensure that the one corresponding to the port to which the unit is connected is selected.
3. Open the Properties window for the Local Area Connection and on the **General** tab select **Internet Protocol (TCP/IP)** and click the **Properties** button.

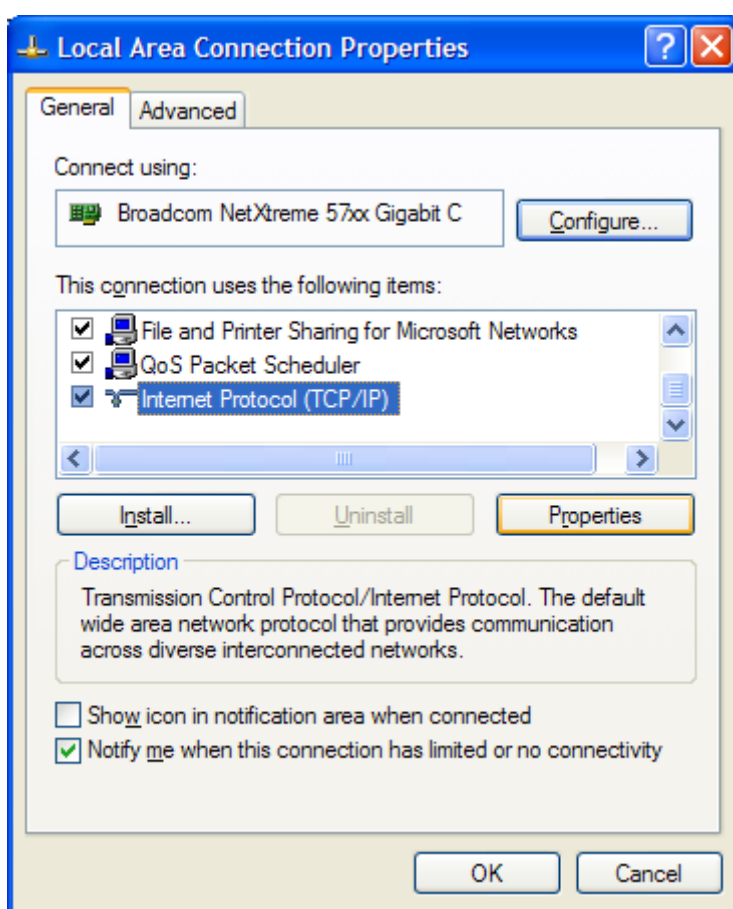

4. In the Internet Protocol (TCP/IP) Properties window, select **Use the following IP address** and enter an **IP address** of 192.168.0.1 and a **Subnet mask** of 255.255.255.0 then click **OK**.

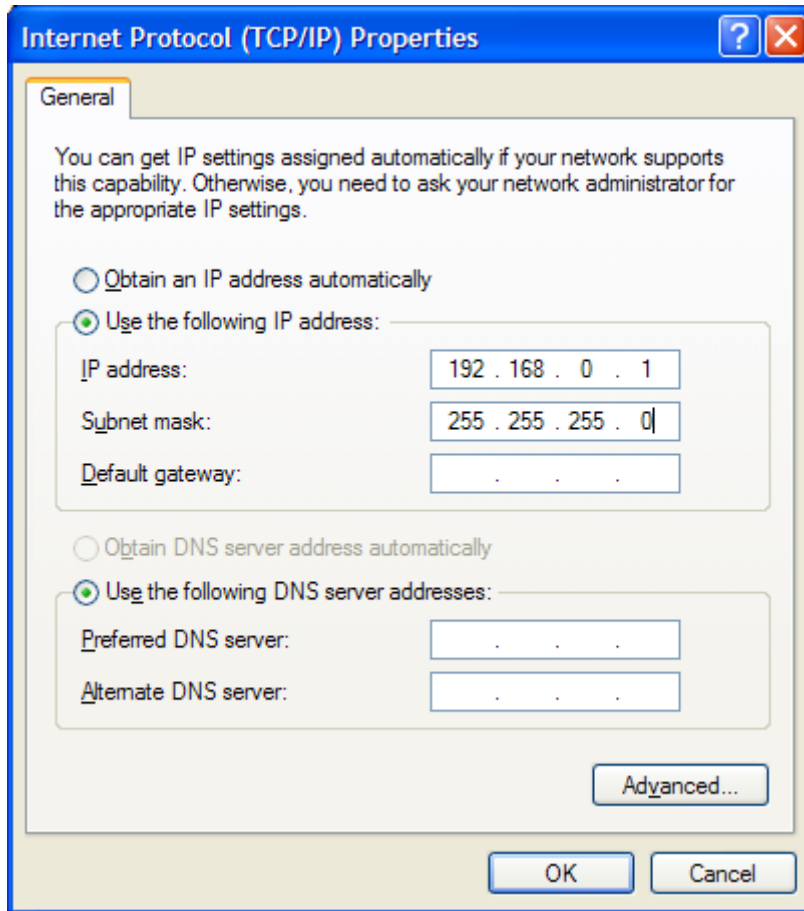

5. Connect to the unit by entering the address 192.168.0.100 (or enter http://192.168.0.100) into your web browser.

**To connect through a DHCP network:**

1. Ascertain from the Network Administrator the allocated IP address that corresponds to the unit's MAC address (as written on the unit itself).
2. Connect the unit to a network hub or switch using a standard (i.e. not 'cross-wired') ethernet (RJ45) cable.
3. Connect to the unit by entering the given address into your web browser, preceded by "http://" if necessary.

## Initial Setup

### DHCP

To use a dynamically assigned IP address from a DHCP server, enable the DHCP option.

If a DHCP server is not available, the unit details must be configured as described below.

### IP net mask, Default IP add, Default gateway

Enter manual network set-up parameters here

### Restart

Click **Restart** to shut the unit down and then automatically start it again.

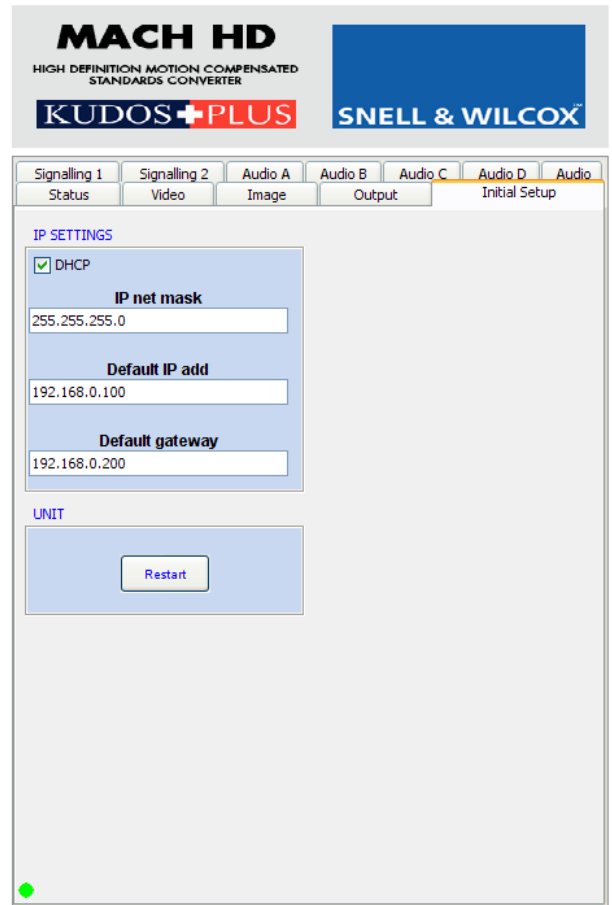

### Connection Status

The dot visible in the bottom Left-hand corner indicates the connection status. Red indicates that the browser is not currently controlling the unit, while green indicates the connection is functioning normally.



## Status

The Status tab displays information about the current operational state of the unit.

### Input standard

This displays the current input standard. If no input is detected, it displays **none**.

### Output standard

This displays the currently selected output standard.

### Reference

This displays the current reference standard. If no reference is detected, it displays **None**. If the current reference standard cannot be used with the selected lock mode, it displays **Error**.

*Note that this information is only available on the Web Interface; it is not shown on the unit display*

### Input source

This displays the currently selected input source. Either **A** or **B**.

### SDI Audio present

This displays the presence of SDI audio, and the channels on which the audio is present.

*Note that this information is only available on the Web Interface; it is not shown on the unit display.*

### AES Audio present

This displays the presence of AES audio, and the channels on which the audio is present.

*Note that this information is only available on the Web Interface; it is not shown on the unit display.*

### Genlock mode

This displays the current genlock status:

- Reference lock
- Input lock
- Freerun
- Follow input

*Note that this information is only available on the Web Interface; it is not shown on the unit display.*

### Version

This displays the software version number of the unit.

### IP

This displays the unit's current IP address.

In DHCP mode, it will display 0.0.0.0 when disconnected from the network.

### MAC Address

This displays the unit's MAC address.

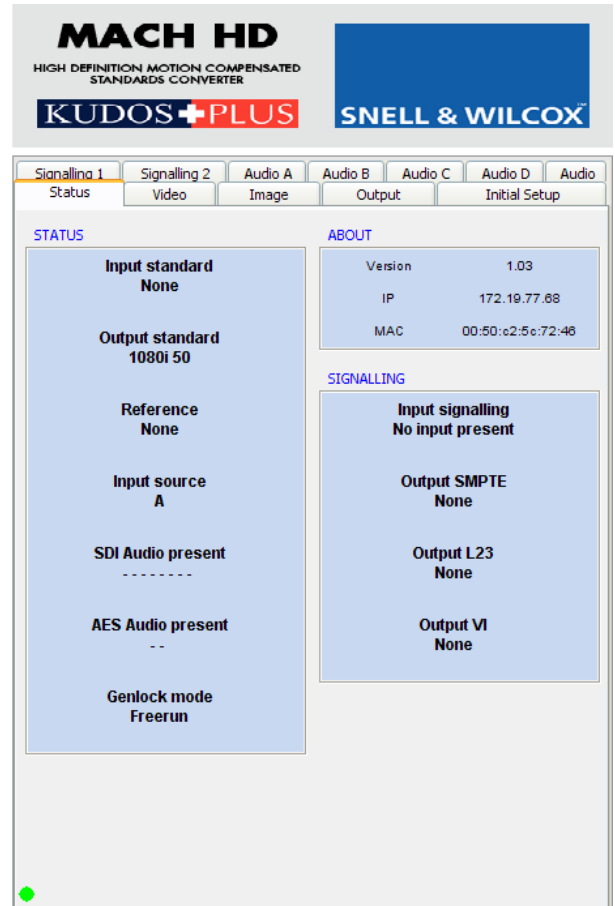

### Input signaling

This displays the current input signalling type.

### Output SMPTE

This displays the current SMPTE output signalling type,

### Output L23

This displays the current L23 output signalling type.

### Output VI

This displays the current Video Index output signalling type.

## Video

The controls on the Video tab enable the unit's video input source to be selected and the procamp controls adjusted.

### Black level

Use the slider bar to adjust the black level over a range of  $\pm 100\text{mV}$ .

Click reset to return the control to its preset value of  $0\text{mV}$ .

### Contrast

Use the slider bar to adjust the contrast over a range of  $\pm 6\text{dB}$  in  $0.2\text{dB}$  steps.

Click reset to return the control to its preset value of  $0\text{dB}$ .

### Colour saturation

Use the slider bar to adjust the colour saturation over a range of  $\pm 6\text{dB}$  in  $0.2\text{dB}$  steps.

Click reset to return the control to its preset value of  $0\text{dB}$ .

### Y gamma

Use the slider bar to adjust the Y gamma curve over a range of  $0.4$  to  $1.7$  in steps of  $0.1$ .

Click reset to return the control to its preset value of  $1$ .

### Input select

This allows the video input source to be selected. Click the corresponding radio button to select either input **A** or input **B**.

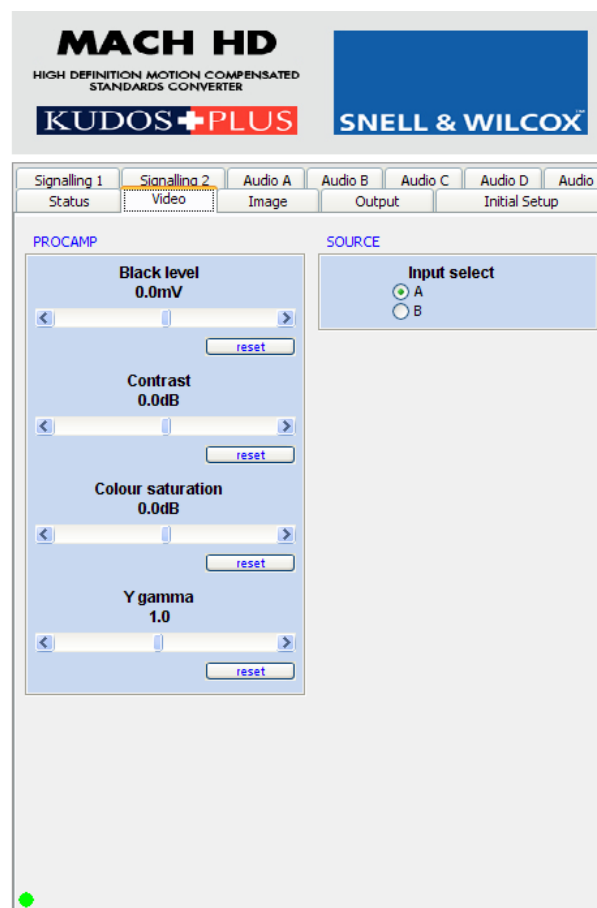

## Image

The controls on the Image tab enable the size, control, and scaling options to be adjusted.

### Motion process

Select this option to enable motion compensation.

### Auto zoom

Select the check box to enable auto zoom. Clear the check box to disable auto zoom.

By default, auto zoom is enabled.

### Manual zoom

Clear the Auto zoom check box and use the slider bar to manually adjust the zoom over a range of 120% to 80% in 1% steps.

Click reset to return the control to its default value of 100%.

### Pattern

This control enables and disables the pattern output, and specifies the type of pattern output if enabled. The options are:

- Off
- Ramp
- Bars
- Black

### Freeze

This control freezes the output when enabled

### Signalling

- Use signaling: When this option is selected, the unit will use the signalling options as specified on the Signalling 1 and Signalling 2 tabs.
- Unknown is manual: When option is selected the unit will use manual aspect conversions if the input signal type is not recognized.

### Convert Scaling

Use this option to select conversion scaling method. The available options are:

- Fit to Height
- 14:9
- Fit to Width

### SD Input Format

Use this option to select the SD input format. The available options are:

- Normal 4:3
- 16:9 LB
- 16:9 An

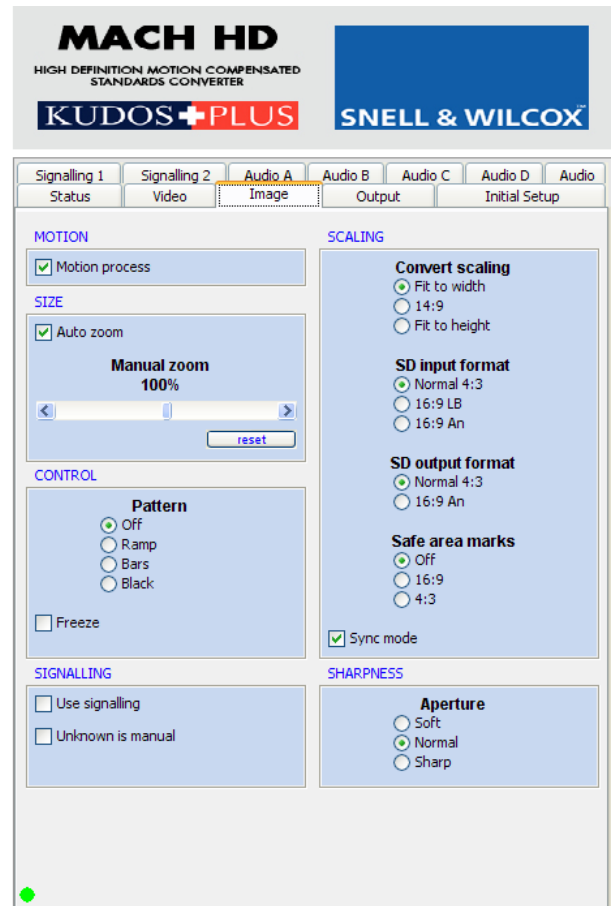

### SD Output Format

Use this option to select the SD output format. The available options are:

- Normal 4:3
- 16:9 An

### Safe area marks

Markers may be inserted appropriate to the output aspect ratio to indicate the nominal safe area. The safe area is 93% of the effective picture height and width. The available options are:

- Off
- 16:9
- 4:3

### Sync Mode

When Sync Mode is On, the scaling filters are disabled giving transparent operation while using the unit as a synchronizer. This control is only effective if the input and output formats are identical.

**Aperture**

**Sharp** preserves the most vertical resolution from the input pictures.

**Normal** provides the best compromise for typical input pictures.

**Soft** is designed to prevent objectionable aliases in the output pictures.

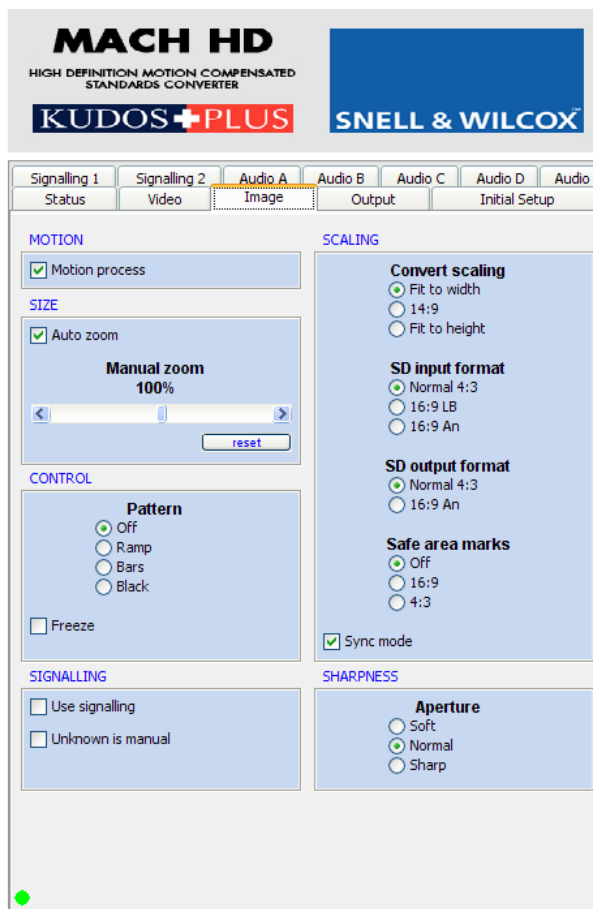

## Output

The options on the Output tab allow the output format and genlock settings to be specified.

### Output format

Use this control to select the output format from the following supported standards:

- 625i
- 525i
- 720P 50
- 720P 59.54
- 1080i 50
- 1080i 59.94

### Genlock

- Reference lock: Output video is locked to an external reference. The offset between the external reference and the output can be adjusted over a range of approximately +/- 32us using the Genlock phase controls
- Input lock: Output video, if the same line and frame standard, is locked to the selected input video source. When converting between line or frame standards this mode is not available.
- Input follow: In this mode the output will lock the frame rate of the output to the input. When converting between frame standards, this mode is not available. This mode allows the locking of SD to HD and vice versa when both are of the same frame rate, and so prevents frame drops or repeats appearing on the output.
- Free run: Output video is locked to an internal reference clock.

### HD phase

Use the slider to select the genlock offset between +32us and -32us in 13.5ns steps.

**SD Gen phase:** Use the slider to select the genlock offset between +32us and -32us in 37ns steps.

Click the reset button to return the control to its preset value of 0us.

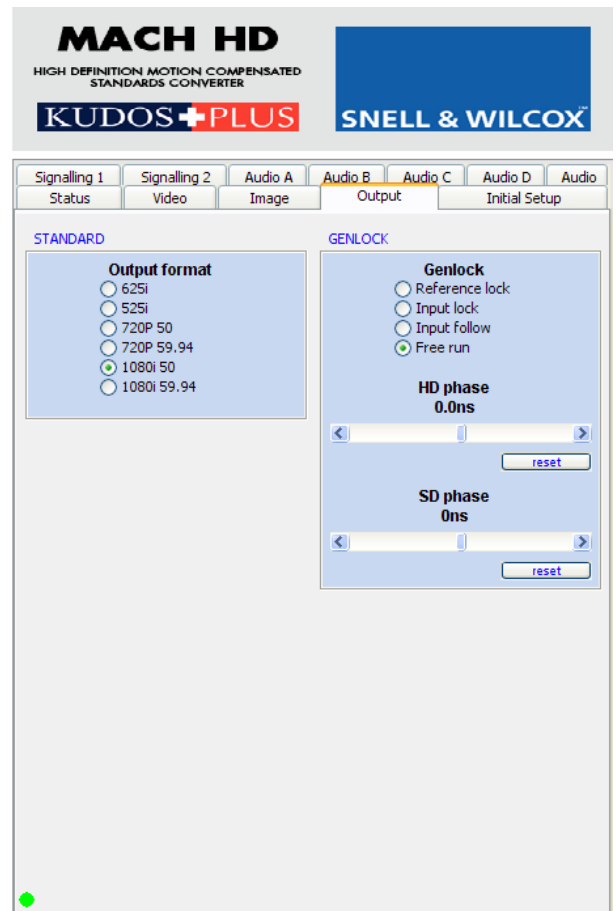

**Note:** The Reference Lock and Input Lock modes will only lock when the output is exactly the same format as the reference or input. For example, 720p 50 will not lock to 1080i 50.

## Signalling 1

The options on the Signalling 1 tab allow the parameters that control automatic Aspect Ratio Conversion to be specified.

### In signaling (SD)

This option specifies the type of input signaling the unit will respond to.

- SMPTE 2016: Embedded VANC packet according to SMPTE 2016 standard. This format is for Active Format Description only, and is supported in both SD and HD
- VI SMPTE: Video Index according to SMPTE RP186, supported in SD only, line 11/324 (625), 14/277 (525).
- VI AFD: Video Index, plus a 3 bit AFD according to ARDSPEC1, supported in SD only.
- L23 AFD: Video Index, transported using Line 23 (WSS) signaling.
- L23 ETSI: Line 23 (WSS) signalling according to ETSI EN 300 294 (2003) Group 1, supported in SD only.

### SMPTE2016:

These options specify the SMPTE 2016 output actions.

SMPTE 2016 out:

- Auto: This option automatically sets the conversion based on a combination of the input output standards.
- Pass: If this option is selected, SMPTE 2016 information will be passed through the unit unchanged.
- Force: If this option is selected, the unit will force the conversion specified on the Signalling 2 tab.
- Delete: If the option is selected, SMPTE 2016 information will be deleted from the output signal.

### Video Index

These options specify the VI output actions

VI Pass Data:

These options specify whether any user data from the source VI is used at the output. If pass data is not enabled, the VI data other than coded frame and AFD are blanked, otherwise, they are passed from the input if appropriate.

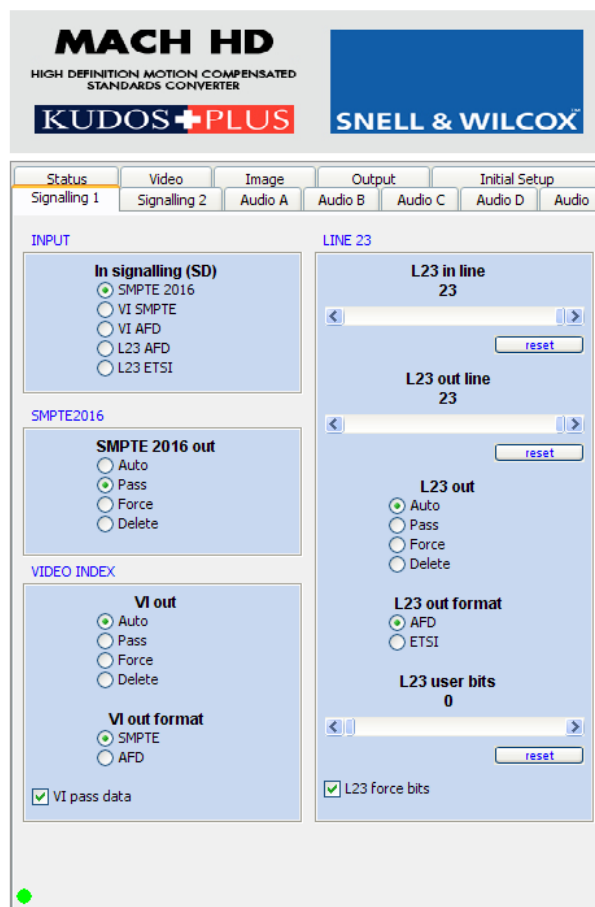

VI out:

- Auto: This option automatically sets the conversion based on a combination of the input output standards.
- Pass: If this option is selected, VI information will be passed through the unit unchanged.
- Force: If this option is selected, the unit will force the conversion specified on the Signalling 2 tab.
- Delete: If the option is selected, VI information will be deleted from the output signal.

VI out format:

- SMPTE: Select this option to output Video Index information according to SMPTE RP186.
- AFD: Select this option to output Video Index information according to ARDSPEC1.

## Signalling 1 (Continued)

### Line 23

These options specify the Line 23 (WSS) input and output parameters.

L23 in line:

- By default, L23 information is carried on line 23. However, if the information occurs on a different line, use the slider to specify the line on which it is carried in the input. The range of adjustment is from line 10 to line 23.

L23 out line:

- By default, L23 information is carried on line 23. However, if the information is required on a different line, use the slider to specify the line on which it is carried in the output. The range of adjustment is from line 10 to line 23.

L23 out:

- Auto:** This option automatically sets the conversion based on a combination of the input output standards.
- Pass:** If this option is selected, L23 information will be passed through the unit unchanged.
- Force:** If this option is selected, the unit will force the conversion specified on the Signalling 2 tab.
- Delete:** If the option is selected, L23 information will be deleted from the output signal.

L23 out format:

- Select AFD to insert L23 information in AFD format.
- Select ETSI to insert L23 information in ETSI format.

L23 user bits:

- Set enhanced L23 bits. Use the slider control to select between 15 preset bit combinations.

L23 force bits:

- Determines whether the L23 user bits set above are forced into the L23 output.

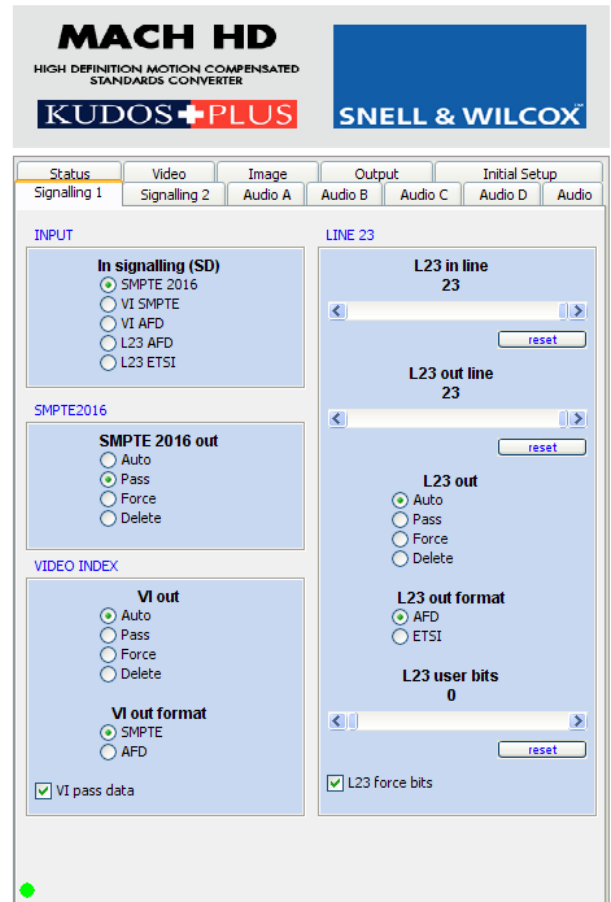

### Signalling 2

The options on the Signalling 2 tab specify the output that will be forced if the corresponding Force option is selected on the Signalling 1 tab.



## Audio A, Audio B, Audio C, and Audio D

The settings on these four tabs enable the audio input sources to be specified for the Left and right channels. Since each tab differs only in the audio pair that is controlled, it is described only once.

### Audio in A/B/C/D Left

These specify the Left audio input source.

- De-embed ch 1  
-to-  
De-embed ch 16
- Analog A – Left
- Analog A – Right
- Analog B – Left
- Analog B – Right
- AES A – Left
- AES A – Right
- AES B – Left
- AES B – Right
- Tone
- Silence

### Audio in A/B/C/D right

These specify the right audio input source. The options are the same as the Left input source.

### Preset Values

The audio input channels have the following default values:

- Audio in A Left: De-embed ch 1
- Audio in A right: De-embed ch 2
- Audio in B Left: De-embed ch 3
- Audio in B right: De-embed ch 4
- Audio in C Left: De-embed ch 5
- Audio in C right: De-embed ch 6
- Audio in D Left: De-embed ch 7
- Audio in D right: De-embed ch 8

### Pair Routing A/B/C/D

Select this option to configure the Left and right as a pair.

With Pair Routing enabled and after selecting a source for Audio in A – Left, the unit will automatically route the corresponding stereo channel to Audio in A – Right. E.g. If De-embed ch 8 is selected for Audio in A – Left the unit will automatically route ch 9 to Audio in A – Right.

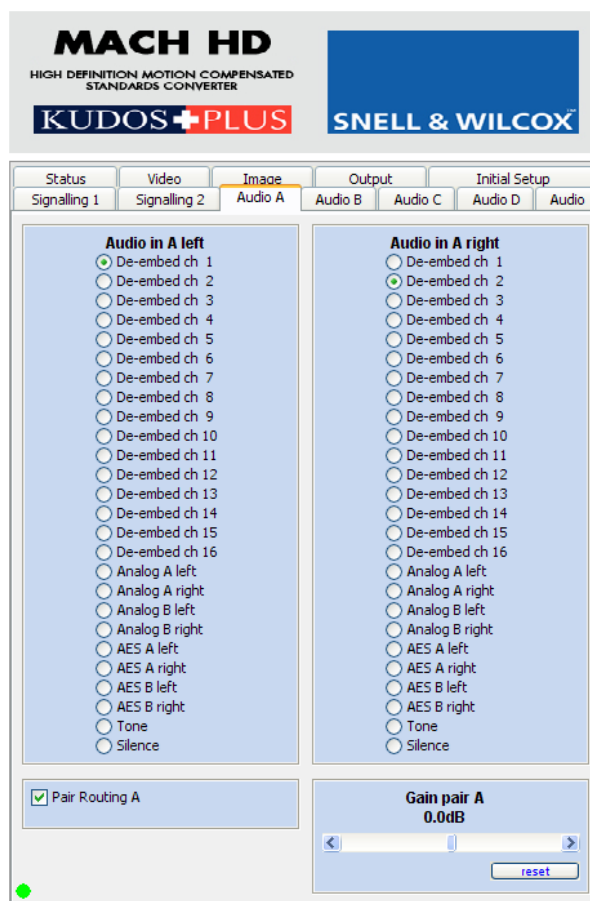

### Gain pair A/B/C/D

Use the slider to apply a gain to the audio pair of  $\pm 18$ dB in 0.1dB steps.

Click reset to return the control to its preset value of 0dB.

## Audio

### ADC A Headroom

Use the slider bar to adjust the ADC A headroom between +12 dBu and +24dBu in 0.5dB steps

Click reset to return the control to its default value of 18dBu.

Note that if the applied audio level exceeds the value set for the Headroom the processed audio will be clipped.

### ADC B Headroom

Use the slider bar to adjust the ADC B headroom between +12 dBu and +24dBu in 0.5dB steps

Click reset to return the control to its default value of 18dBu.

### DAC 1 level

Use the slider bar to adjust the DAC 1 audio output level for 0dBFS between +12 dBu and +24dBu in 0.5dB steps

DAC 1 outputs audio selected under the Audio A tab..

### DAC 2 level

Use the slider bar to adjust the DAC 2 audio output level for 0dBFS between +12 dBu and +24dBu in 0.5dB steps

DAC 2 outputs audio selected under the Audio B tab..

### Embed grp AB

Select the embed group for audio selected under the Audio A and Audio B tabs. Audio A will be embedded into pair 1 of the selected group and Audio B will be embedded to pair 2.

### Embed grp CD

Select the embed group for audio selected under the Audio A and Audio B tabs. Audio A will be embedded into pair 1 of the selected group and Audio B will be embedded to pair 2. Note that if the same group is selected for AB and CD only audio AB will be embedded.

### Tone Frequency

Use the slider to adjust the tone frequency between 100Hz and 10kHz in 100Hz steps.

The screenshot displays the MACH HD software interface, which is a High Definition Motion Compensated Standards Converter. The interface is titled 'MACH HD' and 'KUDOS+PLUS' with the SNELL & WILCOX logo. It features a navigation bar with tabs for Status, Video, Image, Output, and Initial Setup. The 'Audio' tab is selected, showing various audio control sections:

- INPUT HEADROOM:** Contains two slider controls for 'ADC A headroom' and 'ADC B headroom', both set to 18.0dBu. Each has a 'reset' button.
- OUTPUT LEVEL:** Contains two slider controls for 'DAC 1 level' and 'DAC 2 level', both set to 18.0dBu. Each has a 'reset' button.
- EMBEDDER:** Contains two sections: 'Embed grp AB' and 'Embed grp CD'. Each has radio buttons for options 1, 2, 3, 4, and 'off'. In the 'Embed grp CD' section, option 2 is selected.
- TONE:** Contains a slider control for 'Tone frequency' set to 1000Hz, with a 'reset' button.
- AES SOURCE:** Contains radio buttons for 'AES source' with options 'Balanced' (selected) and 'Unbalanced'.

### AES Source

Use this control to specify the AES source – either Balanced or Unbalanced.

## Appendix (Automated Aspect Ratio Control)

### Recognized Input Signalling

The Mach-HD can be configured to respond automatically to a variety of Aspect Ratio signalling standards, controlling both the ARC conversion that is performed, and the new signalling that can be inserted at the unit's video outputs.

The table below shows how the three signalling content types are interpreted, depending on whether the signalling was received from an SD or HD source.

SMPTE 2016 can be extracted from both SD and HD sources

AFD can be extracted from SD Video Index, or 625i with L23

ETSI is only extractable from 625i with L23

**Table 1**

Detected Signalling			Interpretation	
SMPTE 2016	AFD	ETSI	SD Input	HD Input
4/3 AFD 8 Coded Frame 4/3 AFD 9 Coded Frame	4/3 AFD 0 Coded Frame	4/3 FF	Normal 4/3	Normal 16/9
4/3 AFD 8 Coded Frame 4/3 AFD 9 Coded Frame	4/3 AFD 1 – 4/3	4/3 FF	Normal 4/3	Normal 16/9
4/3 AFD 10 16/9LB	4/3 AFD 2 – 16/9	16/9 Center	16/9 LB	Normal 16/9
4/3 AFD 11 14/9 LB	4/3 AFD 3 – 14/9	14/9 Center	Normal 4/3	Normal 16/9
4/3 AFD 4 > 16/9 LB	4/3 AFD 4 4/3	>16/9 Center	16/9 LB	Normal 16/9
4/3 AFD 13 4/3 Alt 14/9	4/3 AFD 5 – 4/3 SP 14/9	SP 14/9	Normal 4/3	Normal 16/9
4/3 AFD 14 16/9LB Alt 14/9	4/3 AFD 6 – 16/9 SP 14/9		16/9LB	Normal 16/9
4/3 AFD 15 16/9LB Alt 4/3	4/3 AFD4/3 7 – 16/9 SP 4/3		16/9LB	Normal 16/9
16/9 AFD 2 Coded Frame 16/9 AFD 10 16/9 16/9 AFD 8 Coded Frame	16/9 AFD 0 - Coded Frame	16/9FF	16/9 Anamorphic	Normal 16/9
16/9 AFD 9 4/3PB	1 16/9 AFD 1 - 4/3		16/9 Anamorphic	Normal 16/9
16/9 AFD 2 Coded Frame 16/9 AFD 10 16/9 16/9 AFD 8 Coded Frame	16/9 AFD 2 – 16/9	16/9FF	16/9 Anamorphic	Normal 16/9
16/9 AFD 3 14/9PB 16/9 AFD 11 14/9PB	16/9 AFD 3 - 14/9		16/9 Anamorphic	Normal 16/9
16/9 AFD 4 >16/9LB	16/9 AFD 4 – AFD 4		16/9 Anamorphic	Normal 16/9
16/9 AFD 13 4/3PB Alt 14/9	16/9 AFD 5 - 4/3 SP 14/9		16/9 Anamorphic	Normal 16/9
16/9 AFD 14 16/9 Alt 14/9	16/9 AFD 6 – 16/9 SP 14/9		16/9 Anamorphic	Normal 16/9
16/9 AFD 15 16/9 Alt 4/3	16/9 AFD 7 – 16/9 SP 4/3		16/9 Anamorphic	Normal 16/9
4/3 AFD 3 14/9LB Top		14/9 Top	Normal 4/3	Normal 16/9
4/3 AFD 2 16/9LB Top		16/9 Top	Normal 4/3	Normal 16/9
4/3 AFD 0 Undefined			Normal 4/3	Normal 16/9
4/3 AFD 1 Reserved			Normal 4/3	Normal 16/9
4/3 AFD 5 Reserved			Normal 4/3	Normal 16/9
4/3 AFD 6 Reserved			Normal 4/3	Normal 16/9
4/3 AFD 7 Reserved			Normal 4/3	Normal 16/9
4/3 AFD 12 Reserved			Normal 4/3	Normal 16/9



16/9 AFD 0 Undefined				<i>16/9 Anamorphic</i>	<i>Normal 16/9</i>
16/9 AFD 1 Reserved				<i>16/9 Anamorphic</i>	<i>Normal 16/9</i>
16/9 AFD 5 Reserved				<i>16/9 Anamorphic</i>	<i>Normal 16/9</i>
16/9 AFD 6 Reserved				<i>16/9 Anamorphic</i>	<i>Normal 16/9</i>
16/9 AFD 7 Reserved				<i>16/9 Anamorphic</i>	<i>Normal 16/9</i>
16/9 AFD 12 Reserved				<i>16/9 Anamorphic</i>	<i>Normal 16/9</i>

**Applied Signalling**

The “Interpretation type”, from table 1, for example “Normal 4/3” is used in the table 2, along with the conversion settings, to identify what conversion will be performed (the “Output” column), and its associated signalling.

**Table 2**

Conversion					Signalling Out		
Conversion type	Input	Convert Scaling	SD Out Format	Output	SMPTE 2016	AFD	ETSI
HD -> HD	HD Normal 16/9	X	X	HD Normal 16/9	16/9 AFD 8 Coded Frame		
SD -> HD	SD Normal 4/3	Fit to width	X	HD Normal 16/9	16/9 AFD 8 Coded Frame		
	SD Normal 4/3	14/9	X	HD Normal 16/9	16/9 AFD 11 14/9PB		
	SD Normal 4/3	Fit to height	X	HD Normal 16/9	16/9 AFD 9 4/3PB		
	SD 16/9 LB	X	X	HD Normal 16/9	16/9 AFD 8 Coded Frame		
	SD 16/9 Anamorphic	X	X	HD Normal 16/9	16/9 AFD 8 Coded Frame		
HD -> SD	HD Normal 16/9	Fit to width	Normal 4/3	SD Normal 4/3	4/3 AFD 10 16/9LB	4/3 AFD 2 -16/9	16/9 Centre
	HD Normal 16/9	14/9	Normal 4/3	SD Normal 4/3	4/3 AFD 11 14/9LB	4/3 AFD 3 -14/9	14/9 Centre
	HD Normal 16/9	Fit to height	Normal 4/3	SD Normal 4/3	4/3 AFD 8 Coded Frame	4/3 AFD 0-Coded Frame	4/3 FF
	HD Normal 16/9	X	16/9 Anamorphic	SD 16/9 Anamorphic	16/9 AFD 8 Coded Frame	16/9 AFD 0-Coded Frame	16/9FF
SD -> SD	SD Normal 4/3	X	Normal 4/3	SD Normal 4/3	4/3 AFD 8 Coded Frame	4/3 AFD 0-Coded Frame	4/3 FF
	SD 16/9 LB	Fit to width	Normal 4/3	SD 16/9 LB	4/3 AFD 10 16/9LB	4/3 AFD 2 – 16/9	16/9 Centre
	SD 16/9 LB	14/9	Normal 4/3	SD 14/9 LB	4/3 AFD 11 14/9LB	4/3 AFD 3 -14/9	14/9 Centre
	SD 16/9 LB	Fit to height	Normal 4/3	SD Normal 4/3	4/3 AFD 8 Coded Frame	4/3 AFD 0-Coded Frame	4/3 FF
	SD 16/9 Anamorphic	Fit to width	Normal 4/3	SD 16/9 LB	4/3 AFD 10 16/9LB	4/3 AFD 2 – 16/9	16/9 Centre
	SD 16/9 Anamorphic	14/9	Normal 4/3	SD 14/9 LB	4/3 AFD 11 14/9LB	4/3 AFD 3 – 14/9	14/9 Centre
	SD 16/9 Anamorphic	Fit to height	Normal 4/3	SD Normal 4/3	4/3 AFD 8 Coded Frame	4/3 AFD 0-Coded Frame	4/3 FF
	SD Normal 4/3	Fit to width	16/9 Anamorphic	SD 16/9 Anamorphic	16/9 AFD 8 Coded Frame	16/9 AFD 0-Coded Frame	16/9FF
	SD Normal 4/3	14/9	16/9 Anamorphic	SD 16/9 Anamorphic	16/9 AFD 11 14/9PB	16/9 AFD 3 – 14/9	16/9FF
	SD Normal 4/3	Fit to height	16/9 Anamorphic	SD 16/9 Anamorphic	16/9 AFD 9 4/3PB	16/9 AFD 1 – 4/3	16/9FF
	SD 16/9 LB	X	16/9 Anamorphic	SD 16/9 Anamorphic	16/9 AFD 8 Coded Frame	16/9 AFD 0-Coded Frame	16/9FF
	SD 16/9 Anamorphic	X	16/9 Anamorphic	SD 16/9 Anamorphic	16/9 AFD 8 Coded Frame	16/9 AFD 0-Coded Frame	16/9FF



## ***Product Support Procedure***

If you experience any technical or operational difficulties with a Snell & Wilcox product please do not hesitate to contact us or utilize our online form to request assistance.

There is a lot of information you can give us that will enable us to diagnose your problem swiftly. Please read the following guidelines, as these suggestions will help us to help you.

### **Basic Information**

For Units .....Please provide the exact product Model, unit Serial Number and Software Version information.

For Cards or Modules ..Please provide the Sub-Assembly Number, card Serial Number and the Software Version information.

### **Basic Application**

Inputs .....Please provide full details of the Input Signals being used including any references etc. and where they are being generated.

Outputs .....Please provide full details of the Output Signals required and how they are being monitored.

System .....Please provide a brief description of the system in which your S&W equipment is currently being used.

### **Basic Tests**

Preset Unit .....Please use the Preset Unit function to return the settings back to the factory default.

RollCall .....Is your unit currently connected to a RollCall capable PC? This software is obtainable for free and provides a very user friendly GUI for virtually all S&W equipment - perfect for complex products, large systems or those with passive front panels.

Card Edge Info. ....What is the status of the card edge LEDs or display? These can often provide information such as power status and input detection conditions.

Internal TPG .....Many S&W products have an internal test pattern/tone generator. Please activate this to assist you with your problem analysis.

In addition to the above, please do not forget to provide us with all of the necessary contact information:

- Names
- Telephone & Fax numbers
- e-mail addresses
- Business address

A form has been provided for this information and will be found on the next page or an on-line form is available on the Snell & Wilcox website at:

<http://www.snellwilcox.com/support/request>



## Product Support Request Form

<b>Name: *</b>		
<b>Company:</b>		
<b>Address Details: *</b>		
<b>Post/ZIP Code:</b>		
<b>Country: *</b>		
<b>Telephone: *</b>		
<b>Fax:</b>		
<b>Email: *</b>		
<b>Local S&amp;W Center: *</b>		
<b>Product Name: *</b>		
<b>Product Type: *</b>	Switchers (i.e. Magic DaVE, Switchpack, Kahuna)	
	File & Data Transfer Products (i.e. RollCall, Memphis & iCR)	
	Video Products (i.e. Modular, Kudos Plus and Alchemist)	
<b>Unit Serial Number: *</b>		
<b>Fault/Spare Part Information: *</b>		
(please advise us how many units show this fault and the system layout showing all other manufacturers' products)		
<b>* Preferred Method of Contact:</b>	e-mail	
	Phone	

- Item is required.

<b>Please mail to:</b> Snell & Wilcox Ltd., Southleigh Park House, Eastleigh Road, Havant, Hants, PO9 2PE. United Kingdom.	<b>Service Contact Information:</b> Tel: +44 (0) 2392 489058 Fax: +44 (0) 2392 489057 <a href="http://www.snellwilcox.com/support">http://www.snellwilcox.com/support</a> <a href="ftp://ftp.snellwilcox.com/support">ftp://ftp.snellwilcox.com/support</a>
--	---



### Manual Revision Record

Date	Version No.	Issue No.	Change	Comments
03/12/08	1	1		First Issue
12/12/08	1	2	Added Connection section.	New Issue