

IQDLY00/01**8 Channel AES/EBU Audio Synchronizer, Delay and Shuffler Module***Table of Contents*

MODULE DESCRIPTION	2	AUDIO BUS A AND B/AUDIO BUS C AND D	18
REAR PANEL VIEWS	2	AES OUT	19
BLOCK DIAGRAM	6	AUDIO DELAY SETUP	20
FEATURES	6	AUDIO SETUP	21
TECHNICAL PROFILE	7	GENLOCK	23
INPUTS	9	GPI	24
AES INPUTS (UNBALANCED)	9	ROLLTRACK	26
AES INPUTS (BALANCED)	9	MEMORIES	29
REFERENCE INPUT (LOOP THROUGH)	10	LOGGING 1 AND 2	30
REFERENCE INPUT	10	ROLLCALL LOG FIELDS	31
GPI I/O	10	SETUP	32
OUTPUTS	11	OPERATION FROM AN ACTIVE CONTROL PANEL 33	
AES OUTPUTS (BALANCED)	11	MAIN MENU	36
AES OUTPUTS (UNBALANCED)	11	AUDIO	36
25 WAY D TYPE CONNECTION DETAILS	12	USER MEM(ORIES)	40
CARD EDGE INDICATORS	14	GENLOCK...	41
ROLLCALL PC CONTROL PANEL SCREENS	15	SETUP...	41
AES INPUT	15	ROLLCALL LOG FIELDS	50
AES INPUT DELAY	16	IQDLY00 ROLLCALL COMMANDS	52
AUDIO MIX 1, 2, 3 AND 4	17	ROLLTRACK AUDIO DELAY TRACKING	56
		MANUAL REVISION RECORD	61

Module Description

The IQDLY00/01 provides synchronization, tracking or preset audio delay, proc. amp control and channel level routing for up to four AES streams. In short it is a complete AES processing solution in one package. Audio can be synchronized to a video reference, tracked to a video synchronizer, or synchronized to an audio reference. Tracking delay control is available via RollTrack or TTL signal. Bypass paths allow for the passing of non-PCM audio such as Dolby E.

Rear Panel Views

IQDLY0115-1A

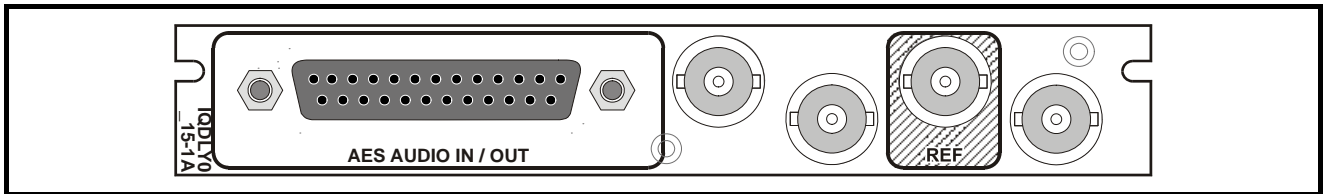

IQDLY0117-2A

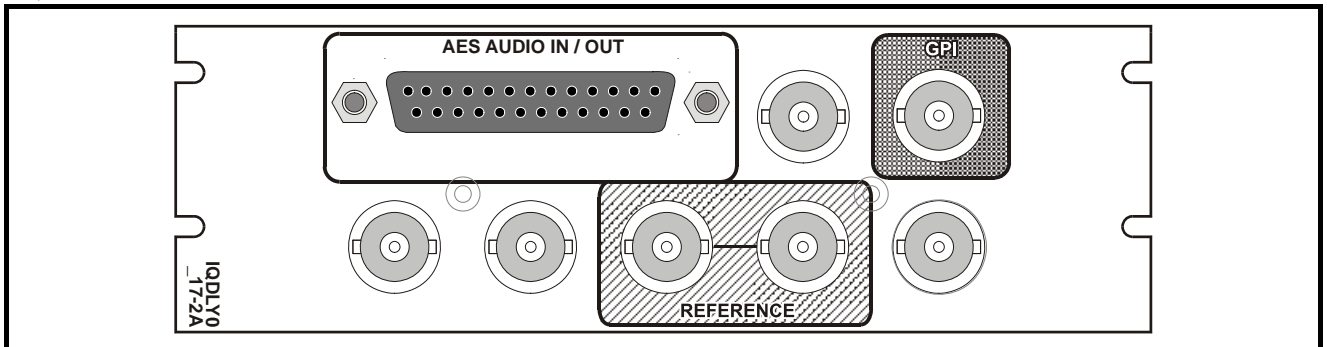

IQDLY0160-2A

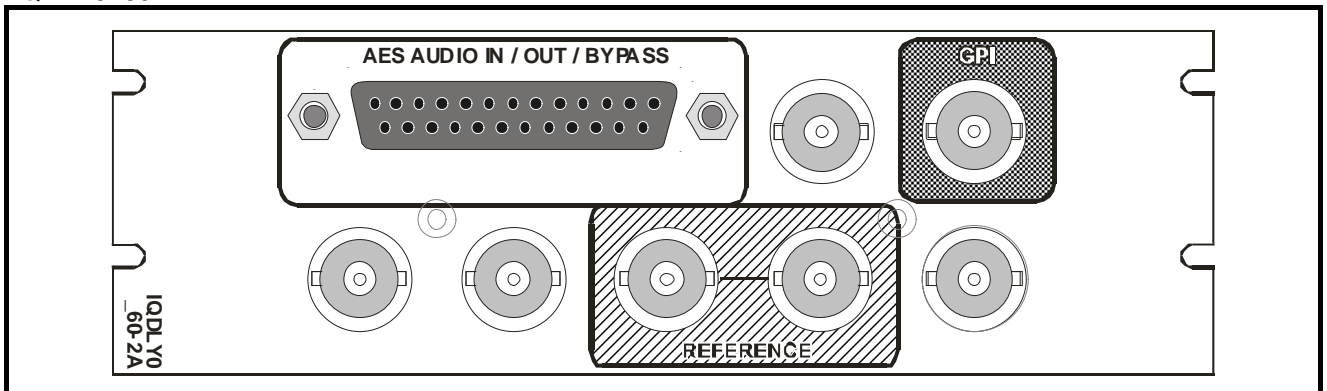

IQDLY0006-2A

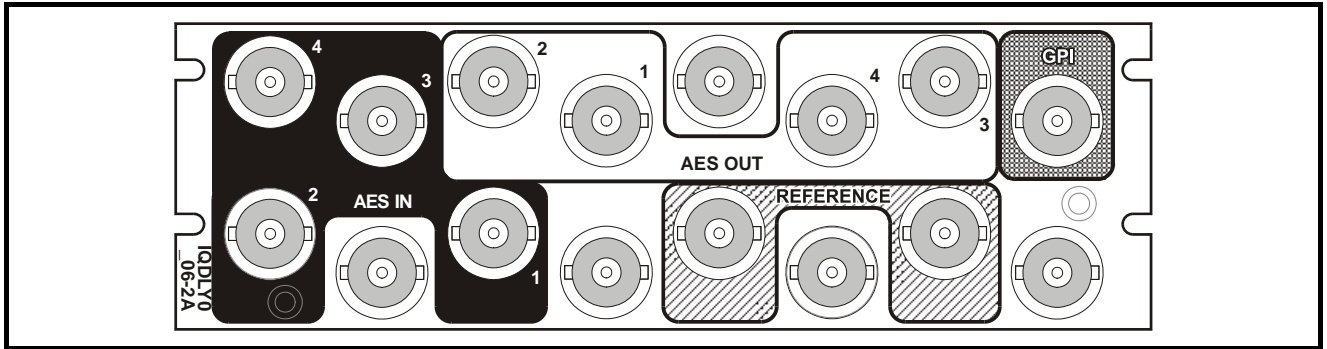

IQDLY0116-2

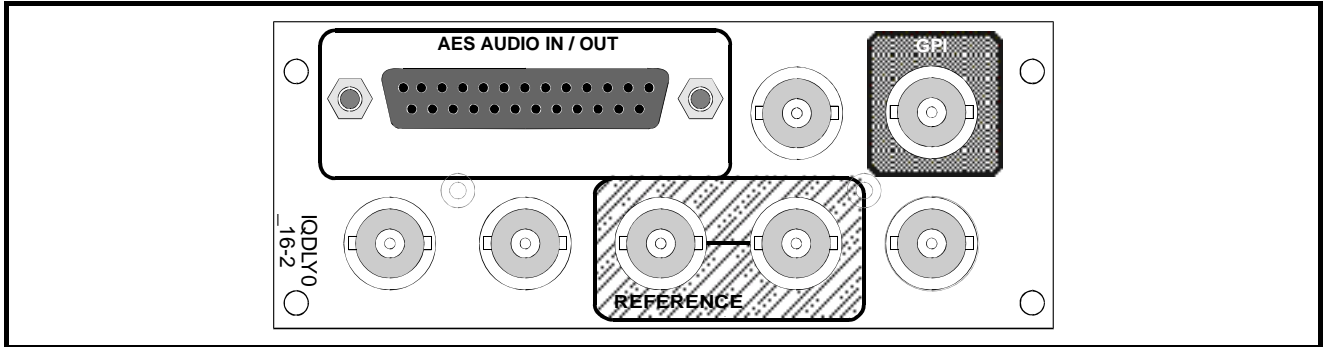

IQDLY0114-1

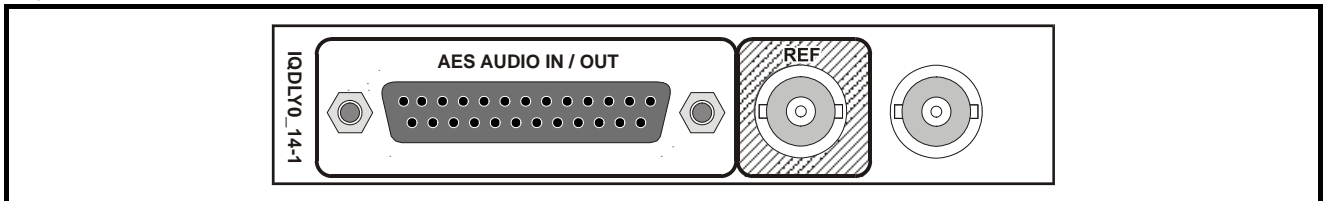

This manual covers the following products:

IQDLY0115-1A 8 channel AES Audio Synchronizer, Delay and Shuffler Module . Balanced AES connection via 25 way D type. 4 AES inputs, 4 AES outputs, AES/Video reference

IQDLY0117-2A 8 channel AES Audio Synchronizer, Delay and Shuffler Module . Balanced AES connection via 25 way D type. 4 AES inputs, 4 AES outputs, AES/Video reference and 1 x GPI

IQDLY0160-2A 8 channel AES Audio Synchronizer, Delay and Shuffler Module . Balanced AES connection via 25 way D type. 4 AES inputs, 4 AES outputs, AES/Video reference, Relay Bypass and 1 x GPI

IQDLY0006-2A 8 channel AES Audio Synchronizer, Delay and Shuffler Module . Unbalanced AES connection via BNC. 4 AES inputs, 4 AES outputs, AES/Video reference and 1 x GPI

IQDLY0116-2 8 channel AES Audio Synchronizer, Delay and Shuffler Module . Balanced AES connection via 25 way D type. 4 AES inputs, 4 AES outputs, AES/Video reference and 1 x GPI

IQDLY0114-1 8 channel AES Audio Synchronizer, Delay and Shuffler Module . Balanced AES connection via 25 way D type. 4 AES inputs, 4 AES outputs, AES/Video reference

Product Comparison

Product	AES Inputs/Outputs		GPI	AES/Video Reference	Relay Bypass	Width & Style
	Number	Type				
IQDLY0115-1A	4	BAL	No	Single	No	Single A
IQDLY0117-2A	4	BAL	1	Loop-through	No	Double A
IQDLY0160-2A	4	BAL	1	Loop-through	Yes	Double A
IQDLY0006-2A	4	U/B	1	Loop-through	No	Double A
IQ DLY0116-2	4	BAL	1	Loop-through	No	Double 0
IQ DLY0114-1	4	BAL	No	Single	No	Single 0

Note that there are two styles of rear panels available. They are not interchangeable between the two styles of enclosures. However, the cards may be fitted into any style of enclosure.

'A' Style Enclosure

Rear panels **with** the suffix A may only be fitted into the 'A' style enclosure shown below.

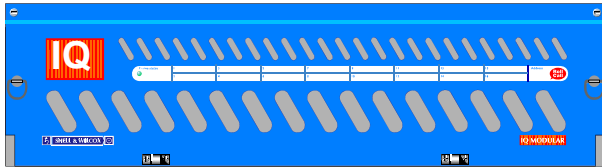

(Enclosure order codes IQH3A-E-0, IQH3A-E-P, IQH3A-0-0, IQH3A-0-P)



(Enclosure order codes IQH3A-S-0, IQH3A-S-P)

'O' Style Enclosures

Rear panels **without** the suffix A may only be fitted into the 'O' style enclosures shown below.

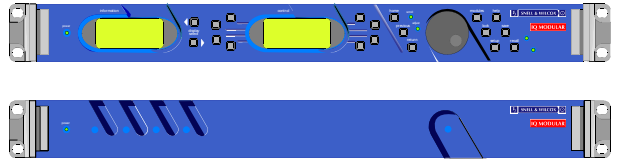

(Enclosure order codes IQH1S-RC-0, IQH1S-RC-AP, IQH1U-RC-0, IQH1U-RC-AP, Kudos Plus Products)

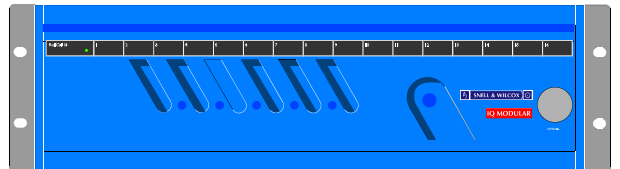

(Enclosure order codes IQH3N-0, IQH3N-P)



(Enclosure order codes IQH3U-RC-0, IQH3U-RC-P)

Block Diagram

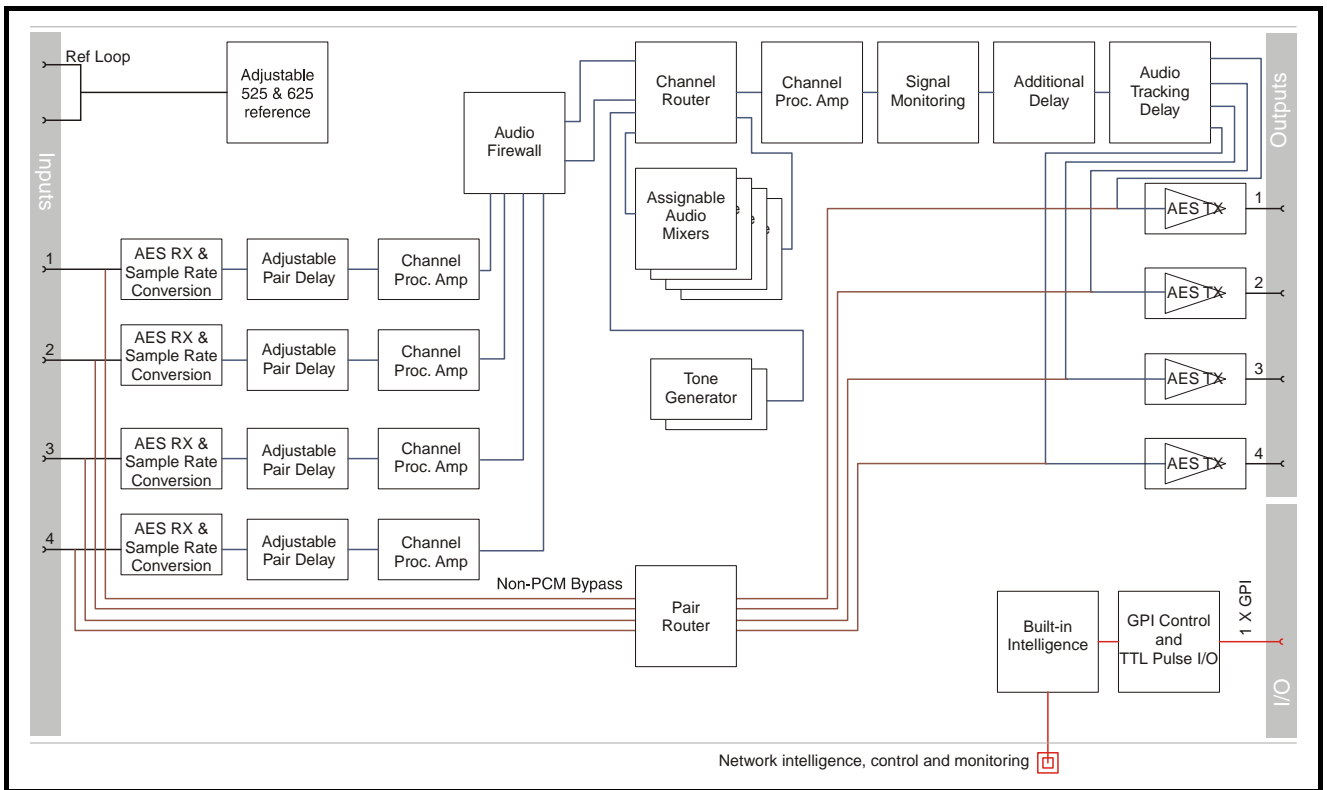

Features

- 4 x balanced or unbalanced AES paths
- Synchronizes AES inputs
- Proc. amp control of audio channels
- Flexible preset and tracking delay
- Channel-level shuffling
- 4 off assignable 4 input mixers
- References to video or AES signals
- Professional standard 48kHz operation, sample rate converts non-48kHz signals
- Firewall for processed PCM audio to provide a continuous output regardless of input
- Passes non-PCM AES signals including Dolby E
- Pair-level Dolby E routing

Technical Profile

Signal Inputs

Video / AES ReferenceComposite video / AES/EBU (BNC)
 Unbalanced digital audio.....4 x AES/EBU, AC3, Dolby E (BNC)
 Balanced digital audio4 x AES/EBU, AC3, Dolby E (25
 Way D-Type)

Card Edge Controls

NONE

Card Edge Indicators

AES Input Present1 x LED per pair
 Reference Loss
 CPU running / PowerOne green LED, flashing = OK

RollCall Functions

Audio Controls

Set headroom.....4 to 24 dB in 1 dB steps
 Set audio detector thresholds
 High and low levels, time delay
 Input audio delay.....Up to 1.5 s additional delay in 1 ms
 steps
 Input side control proc. - audio gain and polarity
 Independent Gain, Mute, Polarity
 control input channels. +18 dB to –
 18 dB in 0.1 dB steps.
 Channel routingOutput channels routed from AES
 pairs 1 to 4, test tone and silence
 Output side control proc. - gain and polarity
 Independent Gain, Mute, & Polarity
 control over AES output channels.
 +18 dB to –18 dB in 0.1 dB steps.
 Global delay offsetup to +1.5 s in 1 ms steps, common
 to all processed audio.
 Variable audio delay control source
 Up to 0.5 s from RollTrack + GPI

Signal Outputs

Unbalanced digital audio.....4 x AES/EBU, AC3, Dolby E (BNC)
 Balanced digital audio4 x AES/EBU, AC3, Dolby E (25
 Way D-Type)

Control Interface

GPI1x Closing contact I/O interface
 (BNC)

Tone frequency, amplitude & Ident

2-channel tone generator. 100 Hz
 to 15 kHz in 100 Hz steps.

Tone Setup:

Frequency100 Hz to 15 kHz in 100 Hz steps
 Channel Ident.....0.5 s interruption every 2 s

Other Controls

User Memories.....Name, clear, save and read 8 user
 memories
 Default Audio Output.....Silence
 GPI/O set-upMay be attached to any memory
 function/polarity

Reporting (* also Logged)

No reference*No reference present
 Audio Silence, High Level, Low Level, Overflow
 For processed audio channels only

RollTrack Input

DelayAudio delay – Fixed, RollTrack +
 fixed

RollTrack Output

DelayCurrent audio delay
 Reference state.....Ref Lost, Ref Present, Ref Error
 External AES Audio state....Pair Present/Lost
 GPI stateLow, High, Inactive

Technical Profile (continued)**Specifications**

Reference Return LossBetter than -35 dB to 5.8 MHz
Reference Input Level.....1 V p-p \pm 3 dB
THD+N< -117 dB @ 700 Hz (24 bits) AES
to AES

Digital Audio Input (Balanced)

Connector/Format25 W D
Sample Frequency25 – 96 kHz (48 kHz for Reference)
Input Cable Length.....>150 m of AES3 cable
Impedance110 Ohms

Digital Audio Input (Unbalanced)

Connector/FormatBNC
Sample Frequency25 – 96 kHz (48 kHz for Reference)
Input Cable Length.....>500 m of RG59 cable
Impedance75 Ohms
Output Sampling48 kHz frame locked to 48 kHz
AES/EBU Reference in AES lock
mode

Digital Audio Output (Balanced)

Connector/Format25 W D
Level.....3 V p-p typical into 110 Ohms
Digital Audio Output (Unbalanced)
Connector/FormatBNC
Level.....1 V p-p typical into 75 Ohms

Power Consumption

Module Power Consumption
8.5 W

INPUTS

AES Inputs (unbalanced)

Unbalanced AES inputs are made to the unit via BNC connectors which terminate in 75 Ohms.

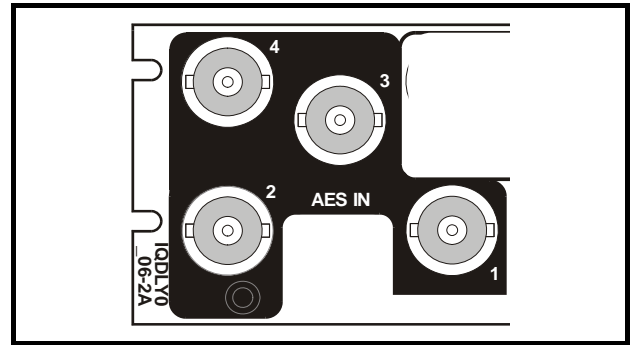

AES Inputs (balanced)

Balanced AES inputs are made to the unit via a 25 way D Type connector.

Note: On modules equipped with the relay bypass (IQDLY0160-2A) In the event of power failure, the relay bypass will pass AES IN 1 to AES OUT 1 and AES IN 3 to AES OUT 2. The relays have a power-on delay of around 16 seconds. This is to maintain the bypass signal path until the Module has finished booting.

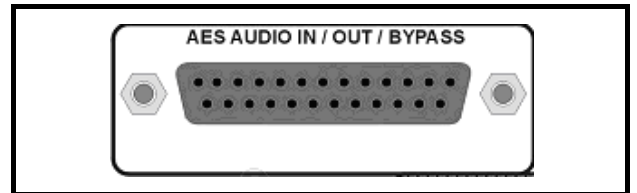
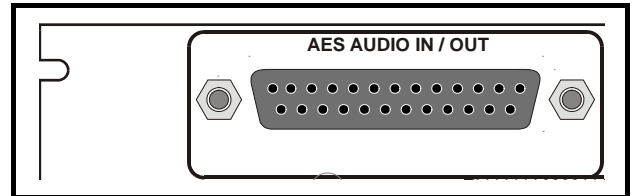
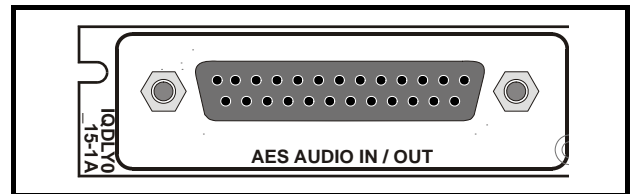

Reference Input (loop through)

The Video / AES Reference input to the unit is made via the passive loop-through BNC connectors for 75 Ohms.

Note that if the loop-through facility is not used the unused BNC socket must be fitted with a 75 Ohm terminator or the Reference Input Termination link on the card set to the 75 ohm position.

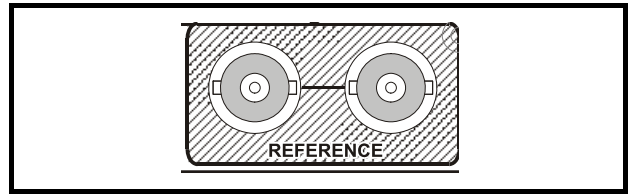
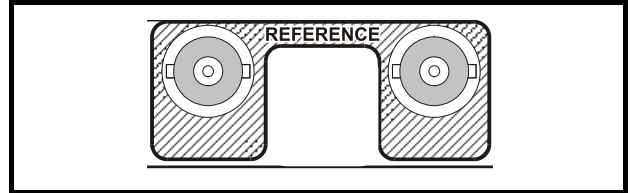
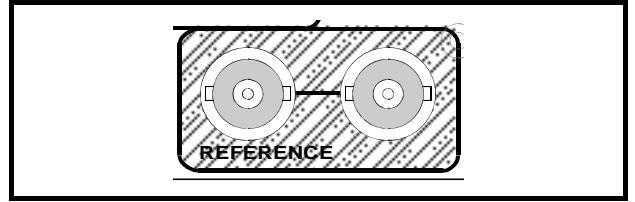

Reference Input

The Video / AES Reference input to the unit is made via this BNC connector that may be terminated in 75 Ohms or a high impedance.

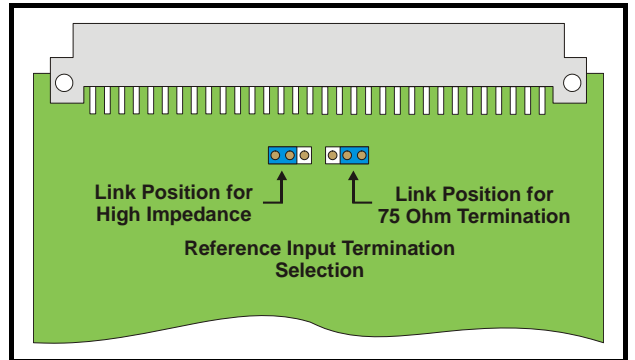
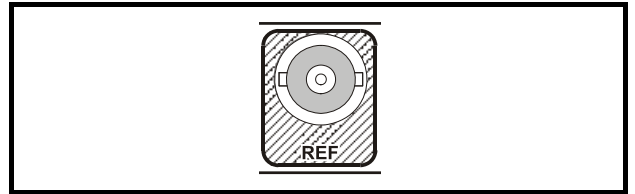

GPI I/O

This connector is used for accepting GPI information (from mechanical switch contacts, relay contacts etc.) The resulting action that the unit takes may be programmed via RollCall.

It may also be configured as an output.

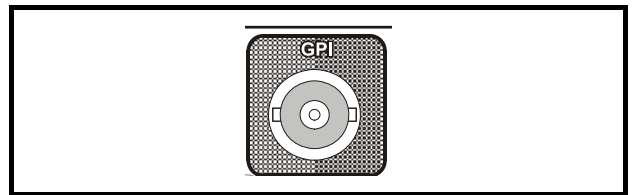

OUTPUTS

AES Outputs (balanced)

All balanced AES outputs are available via a 25 way D type connector.

Note: On modules equipped with the relay bypass (IQDLY0160-2A) In the event of power failure, the relay bypass will pass AES IN 1 to AES OUT 1 and AES IN 3 to AES OUT 2. The relays have a power-on delay of around 16 seconds. This is to maintain the bypass signal path until the Module has finished booting.

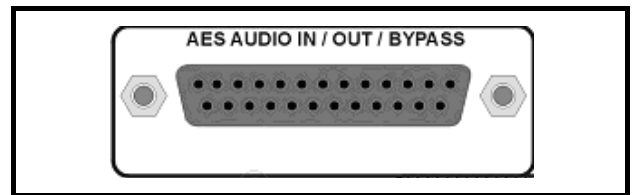
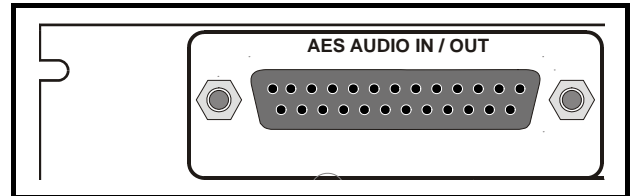
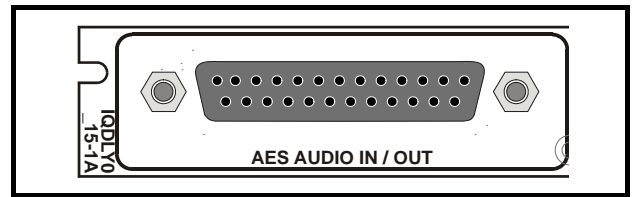

AES Outputs (unbalanced)

All unbalanced AES outputs are available via BNC connectors for 75 Ohms.

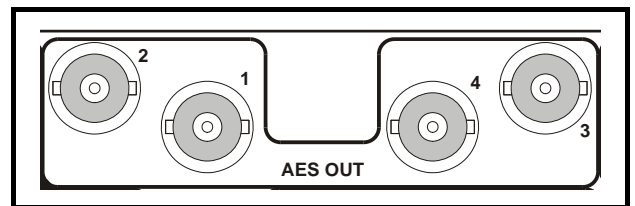

25 Way D Type Connection Details

25 Way D Connector Pin Number	For AES Inputs and Outputs	Standard Pin Assignment	DLY0160, on power fail
1		CHASSIS	
14	AES IN 1 Ground	GND1	
2	AES IN 1 +	1+	to AES OUT 1+ (Pin 12, 8+)
15	AES IN 1 -	1-	to AES OUT 1- (Pin 25, 8-)
3	AES IN 2 +	2+	
16	AES IN 2 -	2-	
4	AES IN 2 Ground	GND2	
17	AES IN 3 Ground	GND3	
5	AES IN 3 +	3+	to AES OUT 2+ (Pin 11, 7+)
18	AES IN 3 -	3-	to AES OUT 2- (Pin 24, 7-)
6	AES IN 4 +	4+	
19	AES IN 4 -	4-	
7	AES IN 4 Ground	GND4	
20	AES OUT 4 Ground	GND5	
8	AES OUT 4 +	5+	
21	AES OUT 4 -	5-	
9	AES OUT 3 +	6+	
22	AES OUT 3 -	6-	
10	AES OUT 3 Ground	GND6	
23	AES OUT 2 Ground	GND7	
11	AES OUT 2 +	7+	
24	AES OUT 2 -	7-	
12	AES OUT 1 +	8+	
25	AES OUT 1 -	8-	
13	AES OUT 1 Ground	GND8	

Example of Connection Details to XLR Connectors

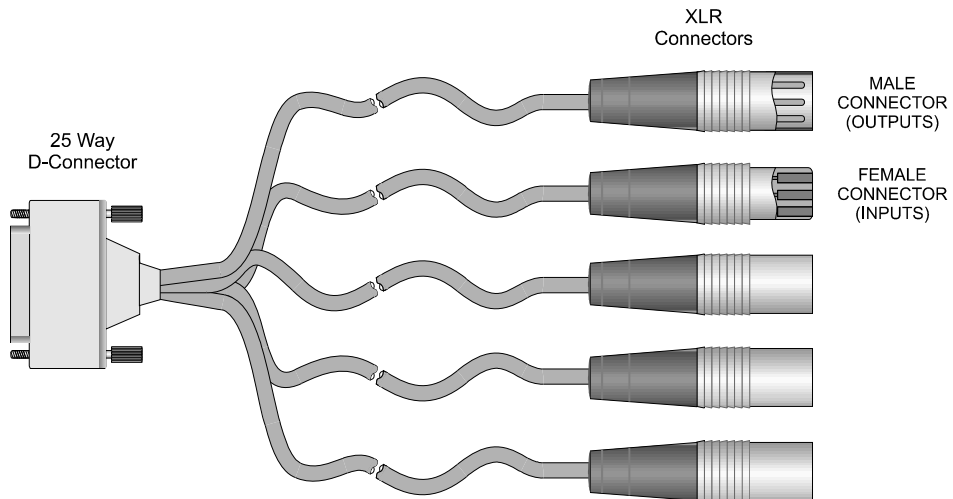

Generic Connections (actual function will depend on the type of product)

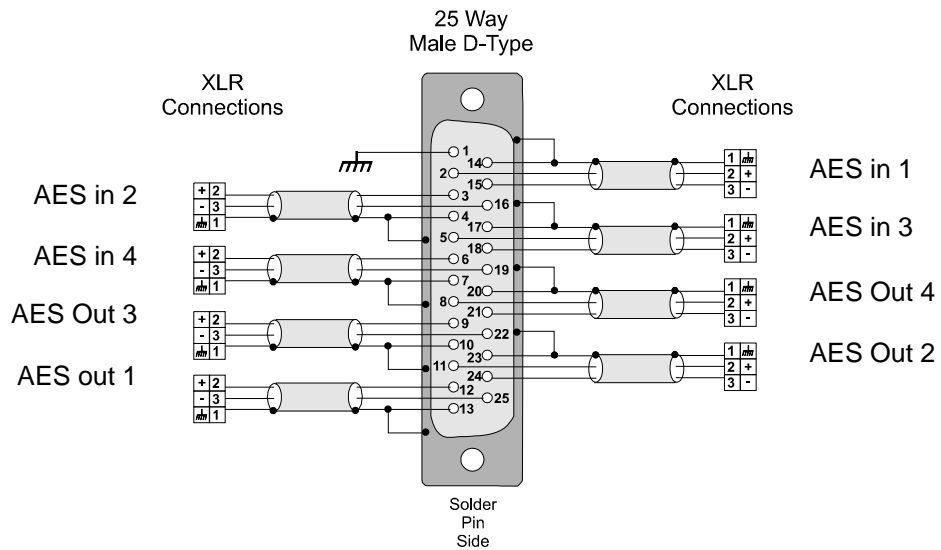

CARD EDGE INDICATORS

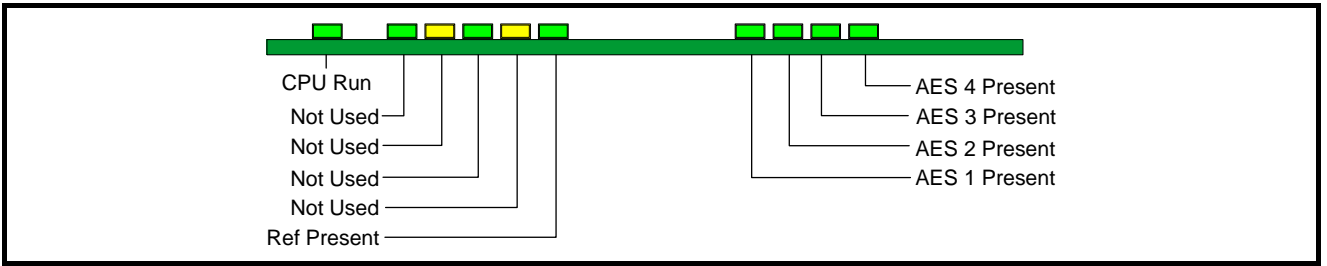

Note that only the LED's associated with the particular version of the product will be active.

CPU Run (Green)

This LED will flash to indicate that the CPU is running.

Ref Present (Green)

When illuminated this will indicate that a valid AES/Video reference signal is present.

AES 1, 2, 3 and 4 Present (Green)

When illuminated these LED's will indicate that the associated AES input pair is present.

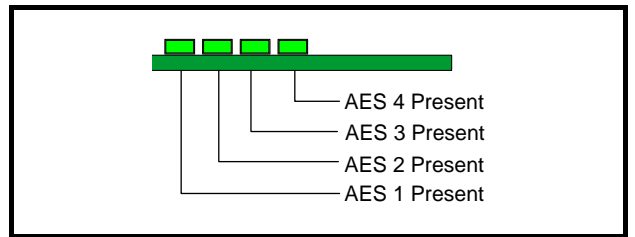
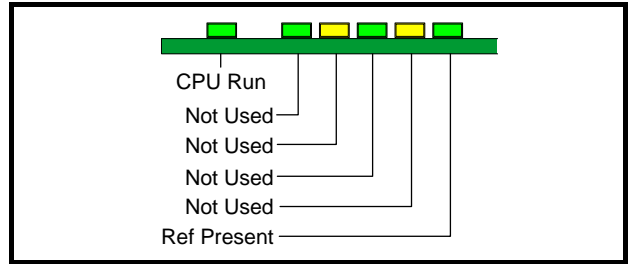

AES Input

This allows control of Gain, Mute, and Polarity over the AES pairs.

L and R

These scrollbars allow the gain of the Left and Right channels to be adjusted over a range of ± 18 dB in 0.1dB steps. Preset is to 0 dB.

Invert

When checked the signal polarity will be inverted.

Mute

When checked the signal will be muted.

Stereo

When checked the left and right channels will be configured as a stereo pair and any adjustments made to one channel will automatically be applied to both channels.

*Note that non-PCM AES input signals cannot be processed (see block diagram on page B8.4) but may be passed through to a selected AES output by selecting an AES Direct input via the **AES Out** screen.*

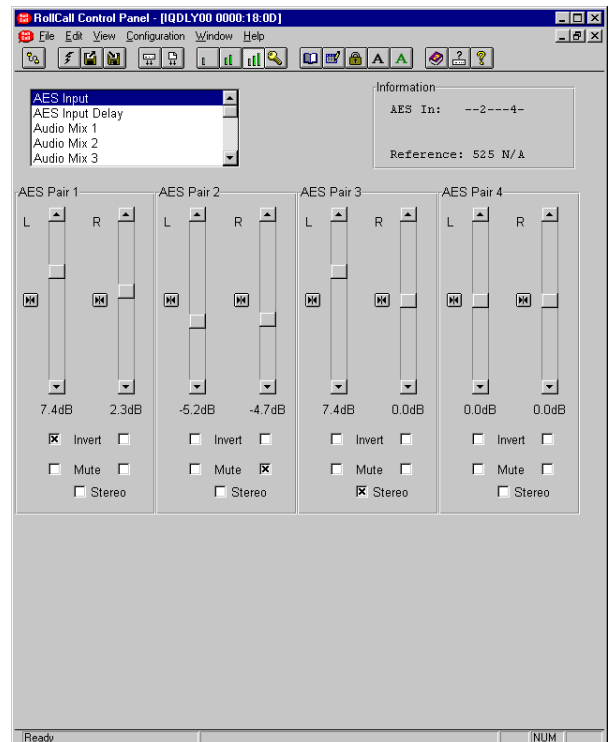

AES Input Delay

This allows the AES inputs to be delayed.

AES Input 1, 2, 3 and Delay

These scrollbars allow the delay to be adjusted be from 0 to 1500 ms in steps of 1 ms. Preset is to 0 ms.

*Note that this delay will not be included in the RollTrack audio delay or in the Total Delay measurement displayed on the **Audio Delay Setup** screen.*

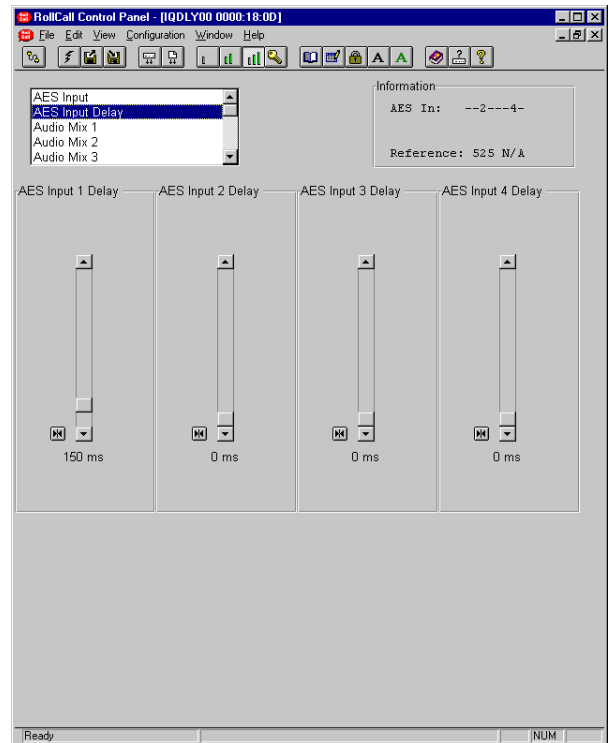

Audio Mix 1, 2, 3 and 4

There are four separate audio mixers Mix 1, 2, 3 and 4.

Each mixer has four inputs with individual gain controls that allow the mixing levels for each of the input signals, to be adjusted. The range of adjustment is from 0 to -90 dB and to Off. 0 to -60 dB is in steps of 1 dB, -60 dB to -90 dB is in steps of 3 dB.

The inputs can be selected from the list in the Source 1, 2, 3 and 4 items.

The outputs of these mixers provide four extra input selections for the Channel Router.

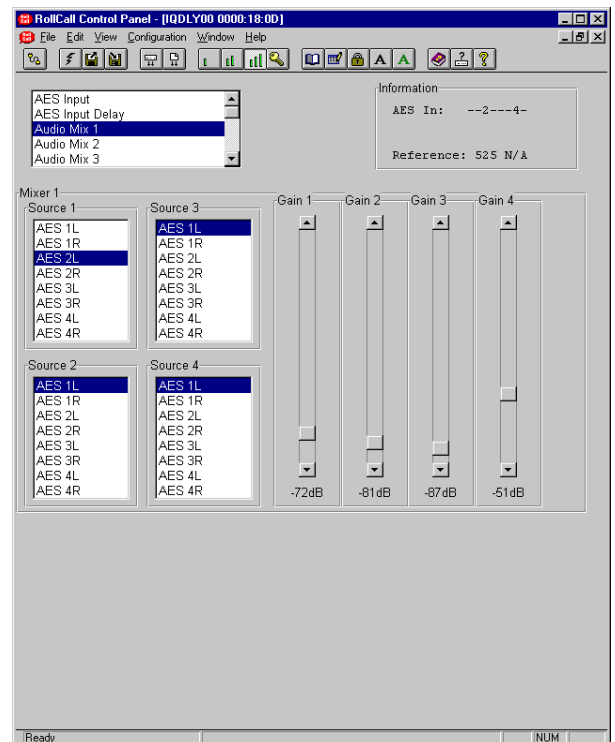

Audio Bus A and B/Audio Bus C and D

This function allows the inputs for the four audio buses of the router to be selected.

For each bus any source may be selected from the list for the left and right channels.

L and R

These scrollbars allow the gain to be adjusted over a range of ± 18 dB in 0.1dB steps. Preset is to 0 dB.

Invert

When checked the signal polarity will be inverted.

Mute

When checked the signal will be muted.

Stereo

When checked the left and right channels will be configured as a stereo pair and any adjustments made to one channel will automatically be applied to both channels.

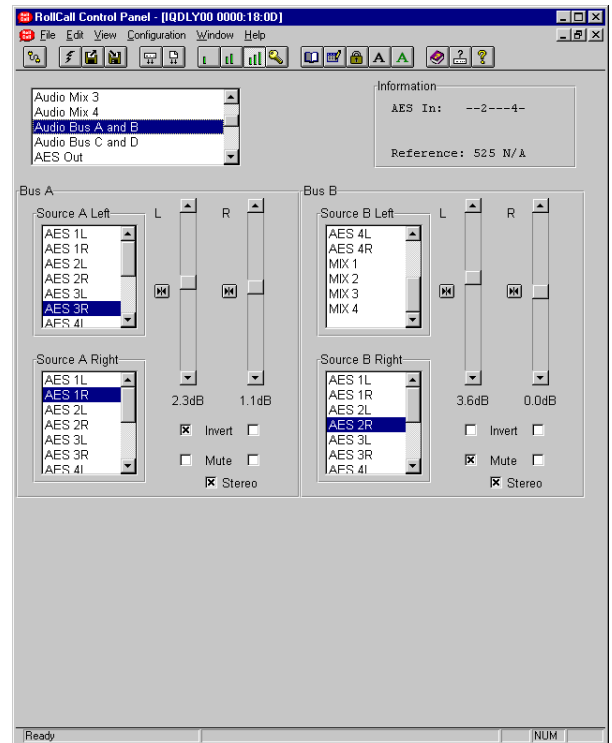

AES Out

This allows the signal source for the AES output to be selected from the list of items for the four AES sources. Silence and audio test tones may also be selected.

Note that non-PCM AES input signals cannot be processed (see block diagram on page B8.4) but may be passed through to a selected AES output by selecting an AES Direct input via this screen.

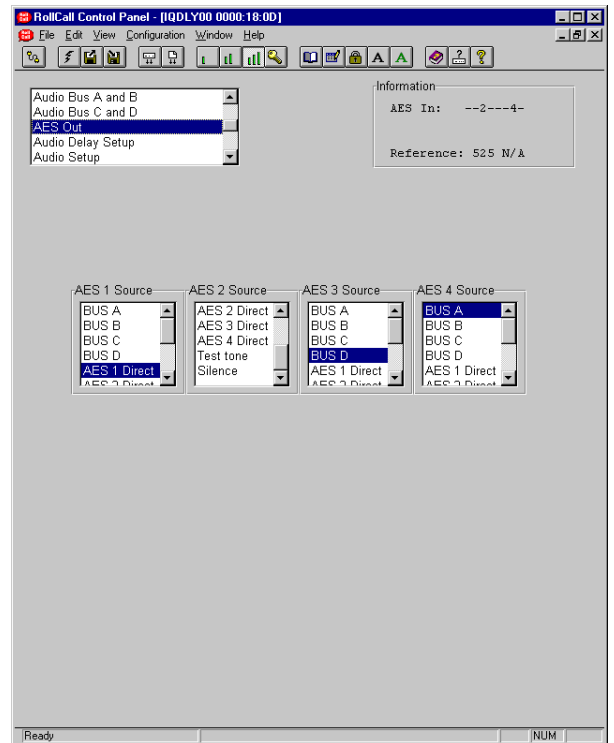

Audio Delay Setup

This screen allows the amount of delay to be set and type of audio delay mechanism to be selected.

Manual Delay

This will affect all processed audio signals equally.

The delay may be set to up to +1.5 s in 1ms steps.

Delay Select

This allows the type of audio delay mechanism to be selected. One or more of the types may be checked. The amount of delay applied will be the sum of the delay from the enabled delay mechanisms.

*Note that up to 0.5 s of delay may be applied from the sum of the **Internal** + **GPI** + **RollTrack** delay inputs.*

Internal

When checked, an audio delay equal to the video delay in the unit will be applied.

Manual

When checked an audio delay set by the **Manual Delay** control will be applied.

GPI

When checked an audio delay will be applied that is equal to the width of the pulse arriving at the GPI connector.

Note that an audio delay pulse of more than 500 ms, applied to the GPI Input will be treated as invalid. This will result in the GPI delay returning to zero.

Note that the GPI must be configured correctly for this function to operate. Please see page 20 for details.

RollTrack 14, 15, 16 and 17

Then selected source(s) of the RollTrack input signal(s) will apply an audio delay.

Total Delay

This will show the audio total delay (due to all selected delay mechanisms) through the unit in ms.

*Note that this delay figure does not include the individual pair delay times for **AES input 1, 2, 3 and 4** as their values may differ.*

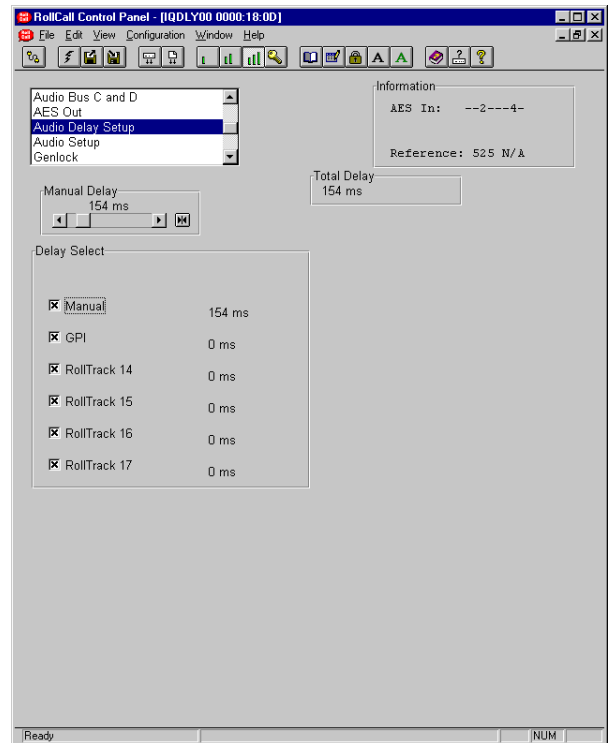

Audio Setup

Audio Monitoring

The four audio buses are monitored and level detectors provide status information and logging data.

Silence

The level at which the signal is considered to have dropped to silence may be set with this control.

The range is from -80 dB to 0 dB in steps of 1 dB. Preset is to -70 dB.

Low Level

The level at which the signal is considered to have dropped to a Low Level may be set with this control.

The range is from -80 dB to 0 dB in steps of 1 dB. Preset is to -60 dB.

High Level

The level at which the signal is considered to have risen to a High Level may be set with this control.

The range is from -80 dB to 0 dB in steps of 1 dB. Preset is to -10 dB.

Overload

The level at which the signal is considered to have risen to an Overload condition may be set with this control.

The range is from -80 dB to 0 dB in steps of 1 dB. Preset is to 0 dB.

Warning Timer

All the above monitoring facilities will only operate after a time interval set by this control. A valid signal is reported immediately.

The range is from 1 to 20 seconds. Preset is to 10 seconds.

Audio Tone

The frequency of the Audio Test Tone may be set using this control. Left and right channels may be set independently.

Frequency L and R

The range is from 100 Hz to 15 kHz in steps of 100 Hz. Preset is to 400 Hz.

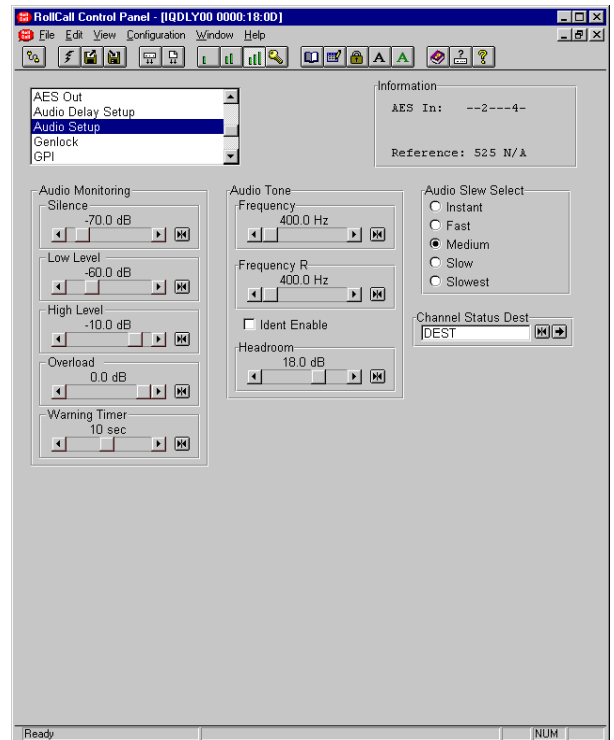

Audio Setup (continued)

Ident Enable

When enabled the right channel will be identified by the signal being muted for 0.5 second every 2.5 seconds.

Headroom

This allows the headroom to be set. The range is from 4 dB to 24dB in 1 dB steps. Preset is to 18 dB.

Note that in this product headroom is defined as:

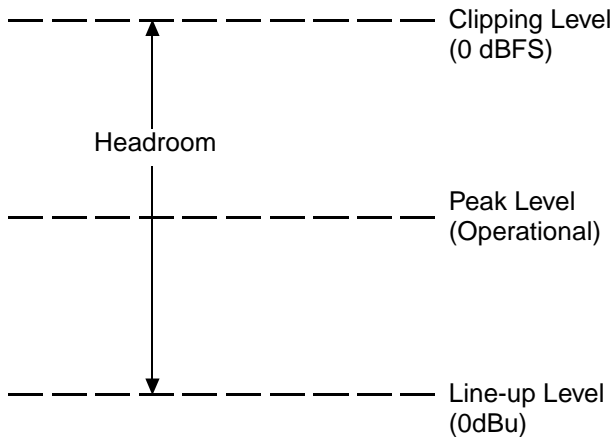

Headroom = Clipping Level – Line-up level

Audio Slew Select

This is the time taken for the audio to slew when the audio mixing and routing controls have changed.

The options are:

- Instant....The response is immediate
- Slowest ..Change takes approximately one second
- SlowChange takes 75% of Slowest time
- Medium ..Change takes 50% of Slowest time
- Fast.....Change takes 25% of Slowest time

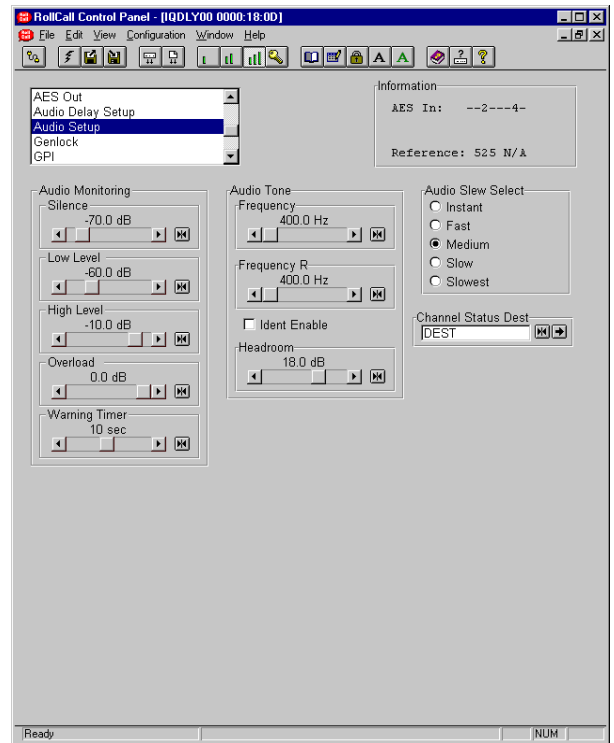

Channel Status Dest(ination)

This will set the four character name used in the destination field of the audio channel status.

To change the text, type the new text in the text area and then select  (return).

Selecting Preset  will return the text to the default text (DEST).

Note that the Channel Status Origin data is automatically set by the module to AVS0 and cannot be changed.

Genlock

This allows the genlock options to be selected.

Lock to Reference

When selected and the unit will lock to the external reference signal.

Free Run

When selected the unit will not be locked to any input signals and the unit will free run.

Lock to Input

When selected the unit will lock to AES Input 1.

Freerun Freq(uency)

This allows the freerun frequency of the internal sync generator to be adjusted in steps of arbitrary units. Preset is to 0.

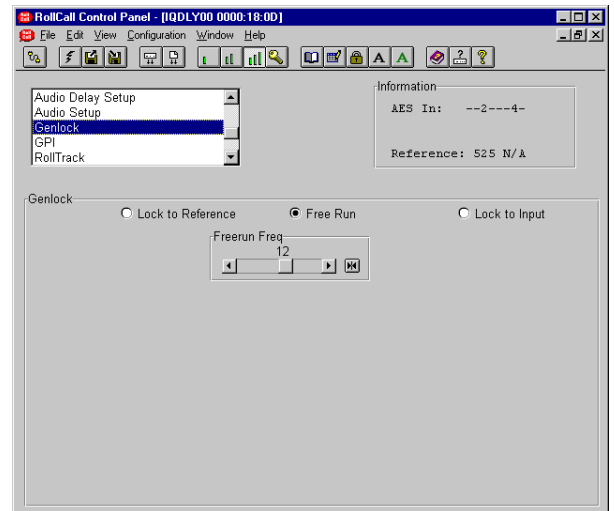

GPI

This screen allows the GPI functions to be configured and their actions defined.

Disable Inputs

When selected all GPI input functions will be disabled.

Input Functions

When configured as an input the GPI connection may be used for accepting GPI information (from mechanical switch contacts, relay contacts etc.) The resulting action that the unit takes may be selected using this item.

The GPI input functions that may be selected are as follows:

- | | |
|------------------|--|
| Unused | The unit will perform no function. This is also the Preset Setting. |
| Memory
1 to 8 | The unit will use the settings in the selected memory location when the input changes from open to closed. |
| Mem1-2 | The unit will toggle between the settings of memory locations 1 and 2.
Open to Closed = Memory 1 settings
Closed to Open = Memory 2 settings |
| Mem 3-4 | The unit will toggle between the settings of memory locations 3 and 4.
Open to Closed = Memory 3 settings
Closed to Open = Memory 4 settings |
| Mem 5-6 | The unit will toggle between the settings of memory locations 5 and 6.
Open to Closed = Memory 5 settings
Closed to Open = Memory 6 settings |
| Mem 7-8 | The unit will toggle between the settings of memory locations 7 and 8.
Open to Closed = Memory 7 settings
Closed to Open = Memory 8 settings |

GPI In Status

This will display the current status of the selected GPI input.

This may show either High or Low. When low, the associated function will be triggered.

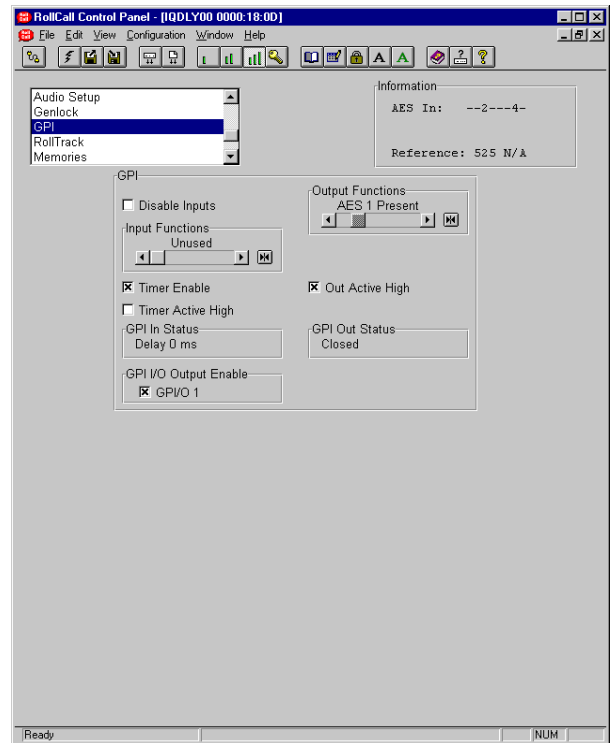

GPI (continued)

Output Functions

The GPO may be configured to produce an output corresponding to one of the following conditions:

- Unused
- AES 1 Present
- AES 2 Present
- AES 3 Present
- AES 4 Present
- Delay

The preset setting for the output is to Unused.

When the condition is not true the output will float but when the condition is true the output is closed to ground via a transistor.

Note that when delay mode is selected the output is a negative going TTL pulse. The width of the pulse represents the delay through the unit to the nearest millisecond.

GPI Out Status

This will display the current status of the GPI output. This may show either Unused, High, low or video delay in milliseconds.

Timer Enable

When checked the GPI will be monitored. The width of the pulse represents the delay that can be used to control audio delays in this unit.

Note that an audio delay pulse of more than 500 ms, applied to the GPI Input will be treated as invalid. This will result in the GPI delay returning to zero.

Timer Active High

When checked the GPI will measure the positive going pulse. When unchecked the negative pulse is measured.

Out Active High

This determines the sense of the asserted GPI output signal. When checked the GPI is active the output sense is high. When unchecked the GPI is active low.

GPI I/O Output Enable

When checked the GPI is configured as an output. When unchecked the GPI is configured as input.

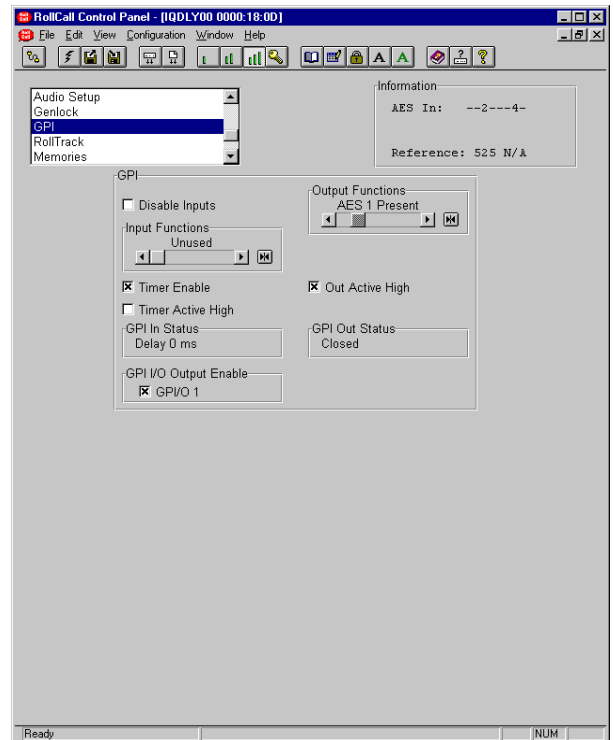

RollTrack

This function allows information to be sent, via the RollCall™ network, to other compatible units connected on the same network.

For example, it can enable compatible audio delay units to produce an audio delay dependent on this and other similar units. The audio delay unit will dynamically follow or track the received delay-time information. This allows processed video signals to be timed correctly with audio signals. This automatic tracking system via the RollCall™ network is called **RollTrack**.

For more detailed information, see the RollTrack section (Appendix) at the end of this manual.

RollTrack Index

This item allows up to 70 destinations to be selected.

RollTrack Source

This allows the source of information that triggers the transmission of data to be selected. Options are:

Unused (off)	AES 1 Lost
Audio Delay	AES 1 PCM
Reference Lost	AES 1 NPCM
Reference Present	to
Reference Error	AES 4 Lost
	AES 4 PCM
	AES 4 NPCM
	GPI 1 Inactive

The destination for the information is set by the network code address as follows:

Network Address

This item allows the address of the selected destination unit to be set.

To change the address, type the new destination in the text area and then select  (return).



(Preset) returns to the default destination

The full **RollTrack** address has four sets of numbers

For example: 0000:10:01*362

The first set (0000) is the network segment code number

The second set (10) is the number identifying the (enclosure/mainframe) unit.

The third set (01) is the slot number in the unit

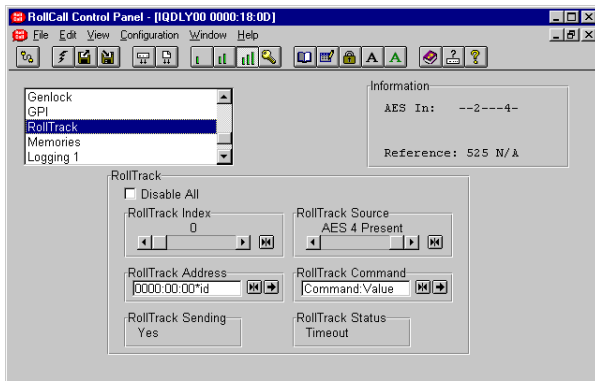

The Fourth Set (362)

Each RollCall unit has a unique identification embedded in the units' software. In this example 362 represents an IQDMX00, 412 would represent an IQDEC00, 161 a Mach 1 etc. Inserting this number in the RollTrack address ensures that only the correct type of unit (in this example an IQDMX00) will respond to the RollTrack command; any other unit will ignore the command.

If this number were set to 00 **any type** of unit at this location would respond to the RollTrack command, possibly causing unpredictable results.

The unit ID of a module on the RollCall network may be found under *RollCall Control Panel/RollCall Listing/Unit Information* or via the *RollCall Control Panel Help/About Current Unit* function.

RollTrack Command The full **RollTrack** command has two sets of numbers

For example: 84*156

The first set (84) is the **RollTrack** command number

Note that only command numbers 14,15,16 and 17 should be used for audio delay

The second set (156) is the value sent with the **RollTrack** command number

*Note that when video delay is selected as the **RollTrack** source the value sent with the **RollTrack** command is the video delay value not the value set.*

For details of the RollCall command values for specific units please contact your local Snell & Wilcox agent.

RollTrack (continued)

Disable All

When this item is checked all RollTrack items will be disabled.

RollTrack Sending

This item shows when the unit is actively sending the RollTrack command.

This may show:

String	A string value is always being sent.
Number	A number value is always being sent.
No	The message is not being sent.
Yes	The message is being sent.
Internal Type Error	Inconsistent behavior; please contact your local Snell & Wilcox agent.

RollTrack Status

This item will show the status of the currently selected RollTrack index.

This may show:

OK	RollTrack message sent and received OK.
Unknown	Rolltrack message has been sent but it has not yet completed.
Timeout	RollTrack message sent but acknowledgement not received. This could be because the destination unit is not at the location specified.
Error	This indicates a broken RollCall state.
Bad	This indicates a broken RollCall packet.

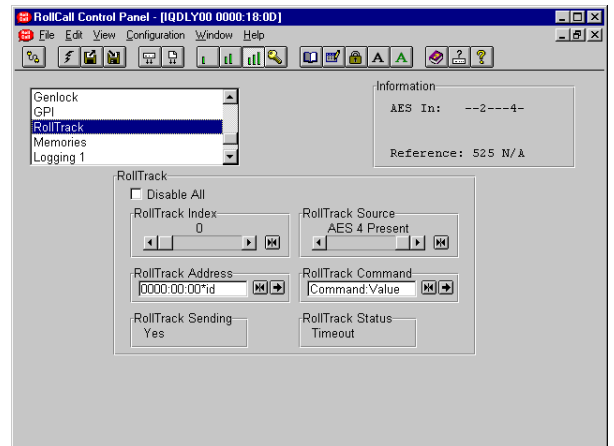

Memories

This function allows a number of particular setups of the unit to be saved and recalled. There are 8 memory locations available.

To change the memory name, type the new name in the text area and then select  (return).

Selecting Preset  will return the text to the default name.



This item allows the memory location to be cleared and returned to the default (preset) setting. This empties the memory location and the Recall button will then appear grayed out.



This function allows the settings of all items to be saved at the memory location.



This function allows the settings saved at the memory location to be recalled. When this button appears grayed out it indicates that the memory location is empty and therefore cannot be recalled. This will occur when the memory is cleared.

Note that all the above functions are a momentary action.

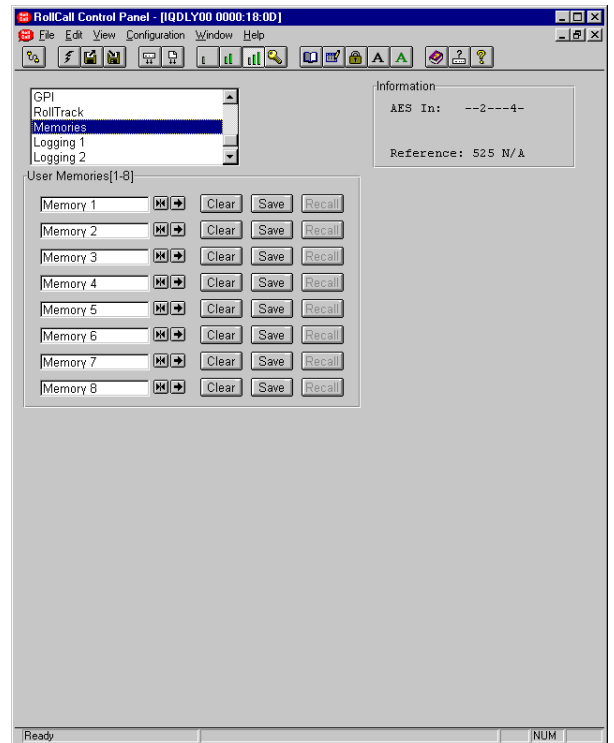

Logging 1 and 2

Information about various parameters can be made available to a logging device that is attached to the RollCall™ network by checking the appropriate box.

The status is shown to the right of the item.

Any of the items may be selected from the list.

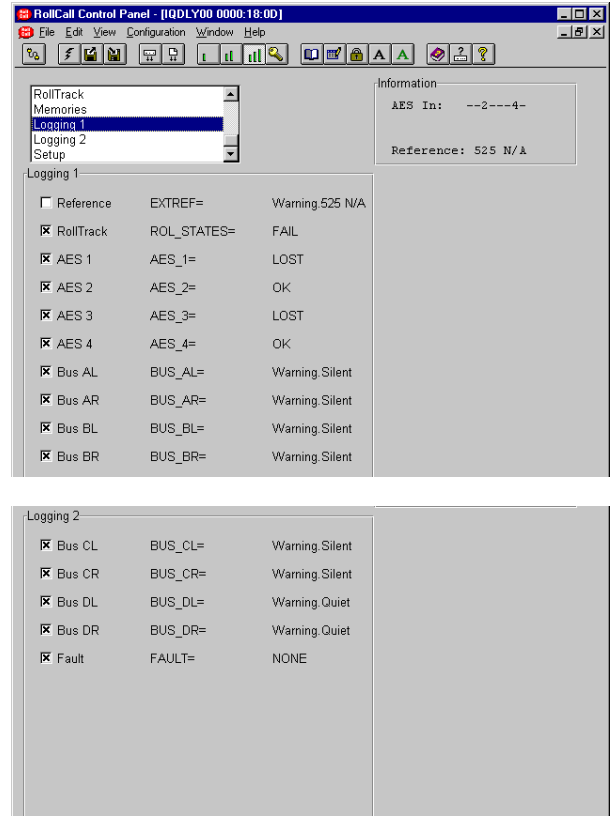

ROLLCALL LOG FIELDS

**Note that these log values are either for future use or may be logged during a transitional state whilst acquiring or loosing an input signal. It is very unlikely that these states and the associated log values will become permanent.*

Log Field	Log Value	Description
EXTREF=	NONE 525 AES ERROR WARNING 625	No reference signal present Valid 525 reference signal Valid AES reference signal Reference/Output standard mismatch Reference signal available but not selected Valid 625 reference signal
ROL_STATES=	OK FAIL	RollTrack message sent and received OK RollTrack message not acknowledged
AES_1=	NONPCM OK LOST	Non-PCM signal present on AES input 1 Valid signal present on AES input 1 Signal not present at AES input 1
AES_2=	NONPCM OK LOST	Non-PCM signal present on AES input 2 Valid signal present on AES input 2 Signal not present at AES input 2
AES_3=*	NONPCM OK LOST	Non-PCM signal present on AES input 3 Valid signal present on AES input 3 Signal not present at AES input 3
AES_4=*	NONPCM OK LOST	Non-PCM signal present on AES input 4 Valid signal present on AES input 4 Signal not present at AES input 4
BUS_AL=	OK WARNING	Router BUS A Left channel has valid signal selected Router BUS A Left channel is receiving silence, low level, high level or overload signal
BUS_AR=	OK WARNING	Router BUS A Right channel has valid signal selected Router BUS A Right channel is receiving silence, low level, high level or overload signal
BUS_BL=	OK WARNING	Router BUS B Left channel has valid signal selected Router BUS B Left channel is receiving silence, low level, high level or overload signal
BUS_BR=	OK WARNING	Router BUS B Right channel has valid signal selected Router BUS B Right channel is receiving silence, low level, high level or overload signal
BUS_CL=	OK WARNING	Router BUS C Left channel has valid signal selected Router BUS C Left channel is receiving silence, low level, high level or overload signal
BUS_CR=	OK WARNING	Router BUS C Right channel has valid signal selected Router BUS C Right channel is receiving silence, low level, high level or overload signal
BUS_DL=	OK WARNING	Router BUS D Left channel has valid signal selected Router BUS D Left channel is receiving silence, low level, high level or overload signal
BUS_DR=	OK WARNING	Router BUS D Right channel has valid signal selected Router BUS D Right channel is receiving silence, low level, high level or overload signal
FAULT=	NONE FAIL	No Internal errors detected Internal error detected
SN=	Runtime string	Serial number of unit

Setup

Information Window

This will display abbreviated information about the current status of the unit.

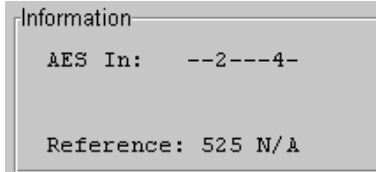

AES In: This shows the detected AES inputs to the module.

Reference: This will show the status of the reference signal.



Selecting this item sets all audio setup items that include a preset facility, to their preset values.

Note that this is a momentary action.



This will reboot the unit simulating a power-down power-up cycle restoring power-up settings.

Software version

This item shows the version of the software fitted in the module.

Serial Number

This item shows the serial number of the module

Build Number

This will indicate the factory build number. This number defines all parameters of the unit (software versions, build level etc.) for identification purposes.

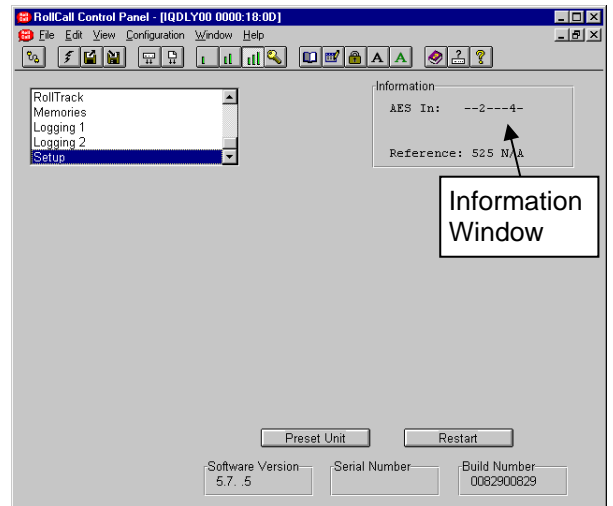

 Operation from an Active Control Panel

The card may be operated from an active control panel via the RollCall™ network.

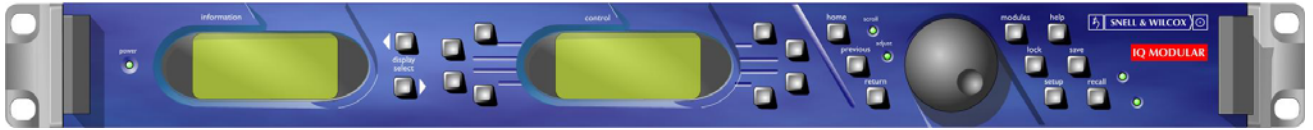

All operational parameters and selections are made using a system of menus displayed in two LCD windows.

Operational details for the remote control panel can be found in the Modular System Operator's Manual.

Information Window

The Information window has four lines of text indicating the current state of the unit.

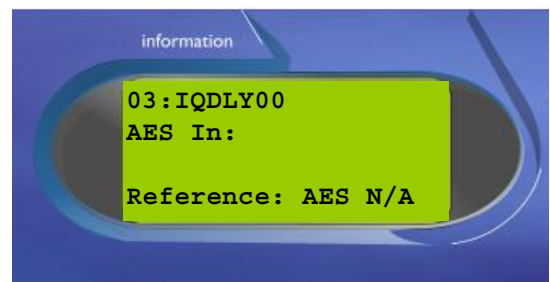

For details of the abbreviations used please see page 27.

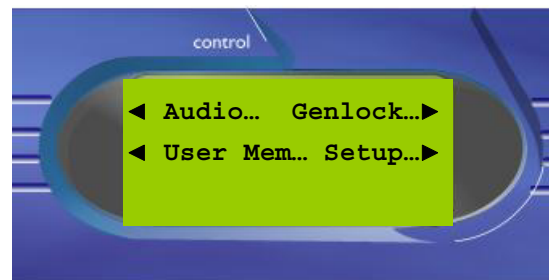

Control Window

The **Control** window displays all Selection Menus and sub-menus.

The selection is made by pressing the button adjacent to the required item.

The menu structure is detailed in the following pages.

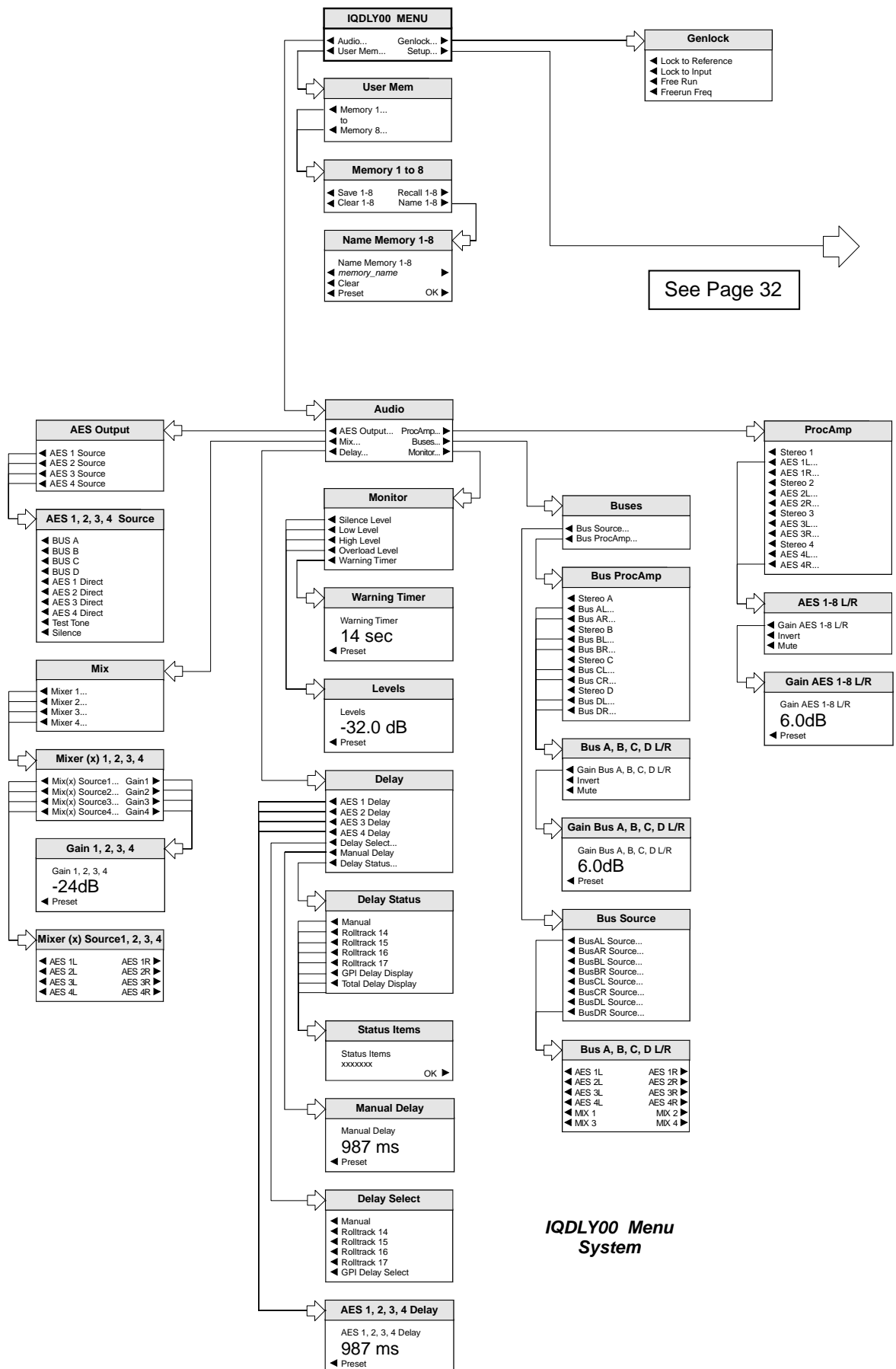

See Page 32

IQDLY00 Menu System

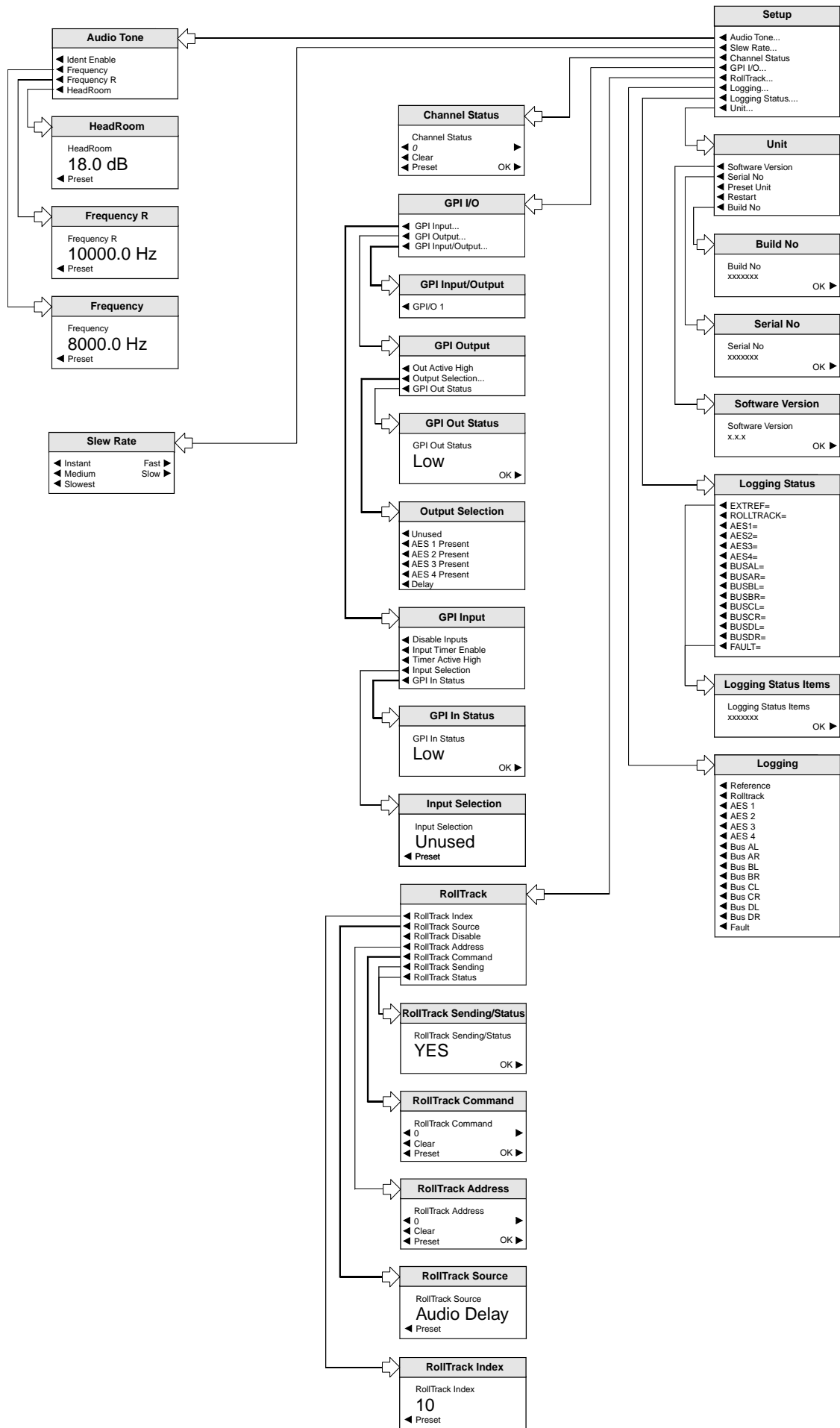

MENU DETAILS

(see IQDLY00 Menu System on previous pages)

MAIN MENU

The main or top level menu allows various sub-menus to be selected by pressing the button adjacent to the required text line.

Note that where a menu item is followed by three dots (...) this indicates that a further sub-menu may be selected.

Whenever a menu item is selected the parameters of that selection will be displayed in the Information window of the front panel. Where the selection is purely a mode selection and does not enable a sub-menu, the text will become reversed (white-on-black) indicating that the mode is active. If the mode is not available for selection the text will remain normal.

Also refer to the block diagram on page 4 for more information.

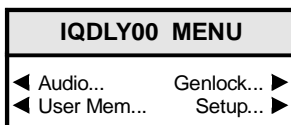
MAIN MENU**Audio**

This menu allows the audio processing functions to be set up.

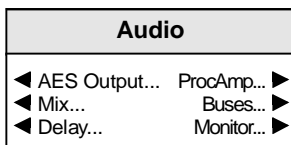
**ProcAmp ▶**

This allows the control of Gain, Mute, and Polarity of the AES channels.

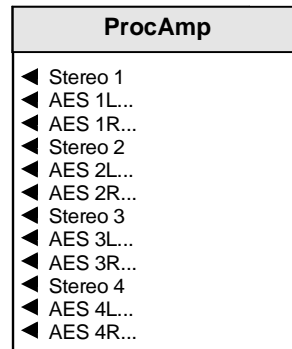

◀ Stereo (1, 2, 3, 4, 5, 6, 7, 8)

When selected the left and right channels will be configured as a stereo pair and any adjustments made to one channel will automatically be applied to both channels.

◀ AES 1-8 L/R

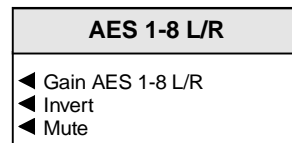

This allows the AES signals to be adjusted and configured.

◀ Gain De-embed (1-8) Left/Right

This allows the gain of the selected AES signal to be adjusted.

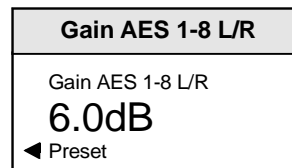

The gain may be adjusted over a range of ± 18 dB in 0.1 dB steps. Preset is to 0 dB.

◀ Invert

When selected the signal polarity of the selected bus signal will be inverted.

◀ Mute

When selected the selected bus signal will be muted.

Mix ▶

There are four separate audio mixers Mix 1, 2, 3 and 4. The outputs of these mixers provide four extra input selections for the Channel Router. This menu allows each of the mixers to be selected and configured.

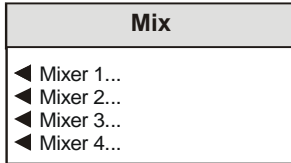

◀ Mixer 1, 2, 3 and 4

Each mixer has four inputs and this item allows the mixer input to be selected and the gain of that channel adjusted.

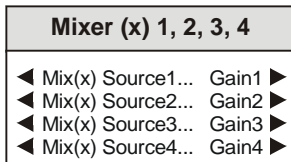

◀ Mixer 1, 2, 3 and 4 Source 1-4 (inputs)

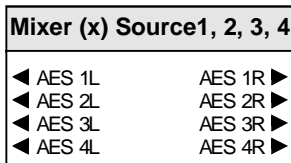

This allows the signal source for the selected input of the selected mixer, to be chosen.

Gain 1-4 ▶

These are the individual gain controls that allow the mixing levels for each of the input signals, to be adjusted.

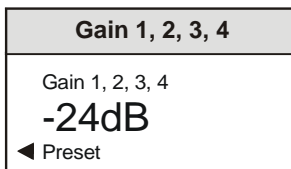

The range of adjustment is from 0 to -90 dB and to Off. 0 to -60 dB is in steps of 1 dB; -60 dB to -90 dB is in steps of 3 dB.

Delay ▶

This menu allows the amount of delay to be set and type of audio delay mechanism to be selected.

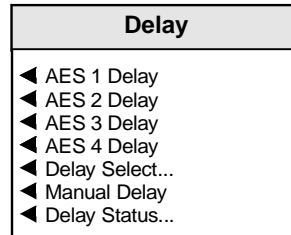

◀ AES 1, 2, 3, 4 Delay

This allows the AES inputs to be delayed.

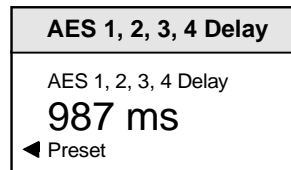

The delay may be adjusted be from 0 to 1500 ms in steps of 1 ms. Preset is to 0 ms.

*Note that this delay will not be included in the RollTrack audio delay or in the Total Delay measurement displayed in the **Delay Status** sub-menu.*

◀ Delay Select

This allows the type of audio delay mechanism to be selected. One or more of the types may be checked. The amount of delay applied will be the sum of the delay from the enabled delay mechanisms.

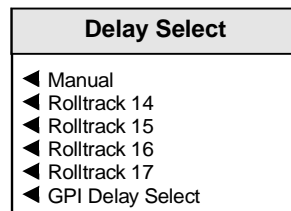

◀ Manual

When selected an audio delay set by the **Manual Delay** control will be applied, immediately.

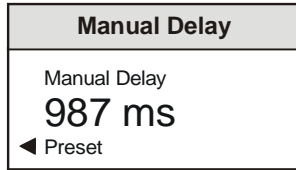

◀ RollTrack 14, 15, 16 and 17

The selected source(s) of the RollTrack input signal(s) will apply an audio delay, smoothly compensating. Also see page 22.

◀ GPI Delay Select

When selected an audio delay will be applied that is equal to the width of the pulse arriving at the GPI connector.

Note that an audio delay pulse of more than 500 ms, applied to the GPI Input will be treated as invalid. This will result in the GPI delay returning to zero.

Note that the GPI must be configured correctly for this function to operate. Please see page 38 for details.

◀ Delay Status

The status (and amount) of delay produced by each of the delay methods may be chosen from this menu.

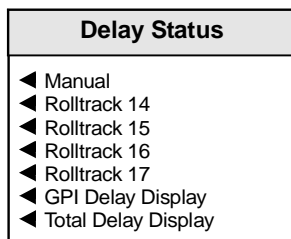

◀ Status Items

The status (and amount) of delay of the chosen item will be displayed in this window.

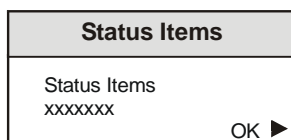

AES Output ▶

This allows the AES signal source for the AES output to be selected.

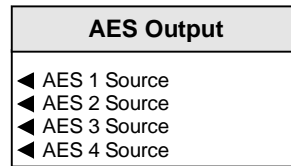

◀ AES 1, 2, 3, 4 Source

This allows the signal from the AES source to be selected. Silence and audio test tones may also be selected.

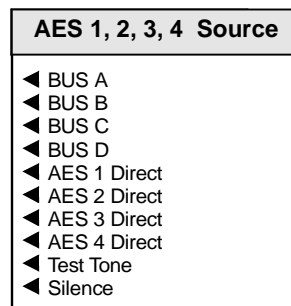

◀ Buses

This function allows the inputs for the four audio buses of the router to be selected and adjusted.

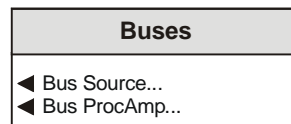

For each bus any source may be for the left and right channels.

◀ Bus Source

This allows the bus source to be selected.

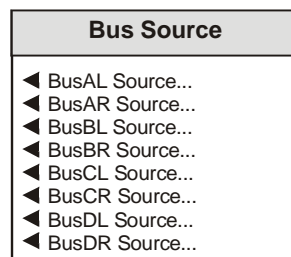

◀ Bus (A, B, C, D) L/R Source

This allows the audio source for the left and right channels of the bus to be selected.

Bus A, B, C, D L/R	
◀ AES 1L	AES 1R ▶
◀ AES 2L	AES 2R ▶
◀ AES 3L	AES 3R ▶
◀ AES 4L	AES 4R ▶
◀ MIX 1	MIX 2 ▶
◀ MIX 3	MIX 4 ▶

The audio source for the left and right channels of the bus may be selected from the AES signals or the output of one four mixers.

◀ Bus ProcAmp

This allows the bus signals to be configured and adjusted.

Bus ProcAmp
◀ Stereo A
◀ Bus AL...
◀ Bus AR...
◀ Stereo B
◀ Bus BL...
◀ Bus BR...
◀ Stereo C
◀ Bus CL...
◀ Bus CR...
◀ Stereo D
◀ Bus DL...
◀ Bus DR...

◀ Stereo (A, B, C, D)

When selected the left and right channels will be configured as a stereo pair and any adjustments made to one channel will automatically be applied to both channels.

◀ Bus (A, B, C, D) Left/Right

Bus A, B, C, D L/R
◀ Gain Bus A, B, C, D L/R
◀ Invert
◀ Mute

This allows the bus signals to be adjusted and configured.

◀ Gain Bus (A, B, C, D) Left/Right

This allows the gain of the selected bus signal channel to be adjusted.

Gain Bus A, B, C, D L/R
Gain Bus A, B, C, D L/R
6.0dB
◀ Preset

The gain may be adjusted over a range of ±18 dB in 0.1 dB steps. Preset is to 0 dB.

◀ Invert

When selected the signal polarity of the selected bus signal will be inverted.

◀ Mute

When selected the selected bus signal will be muted.

◀ Monitor

The four audio buses are monitored and level detectors provide status information and logging data.

Monitor
◀ Silence Level
◀ Low Level
◀ High Level
◀ Overload Level
◀ Warning Timer

Levels

Levels
Levels
-32.0 dB
◀ Preset

These levels may be adjusted by rotating the spinwheel.

◀ Silence Level

The level at which the signal is considered to have dropped to silence may be set with this control.

The range is from -80 dB to 0 dB in steps of 1 dB. Preset is to -70 dB.

◀ Low Level

The level at which the signal is considered to have dropped to a Low Level may be set with this control.

The range is from -80 dB to 0 dB in steps of 1 dB. Preset is to -60 dB.

◀ High Level

The level at which the signal is considered to have risen to a High Level may be set with this control.

The range is from -80 dB to 0 dB in steps of 1 dB. Preset is to -10 dB.

◀ Overload

The level at which the signal is considered to have risen to an Overload condition may be set with this control.

The range is from -80 dB to 0 dB in steps of 1 dB. Preset is to 0 dB.

◀ Warning Timer

All the above monitoring facilities will only operate after a time interval set by this control. When OK it will operate immediately.



The range is from 1 to 20 seconds. Preset is to 10 seconds.

User Mem(ories)

This function allows a number of particular setups of the IQDLY00 to be saved and recalled. There are 8 memory locations available.

This item allows any of the 8 memory locations to be selected.

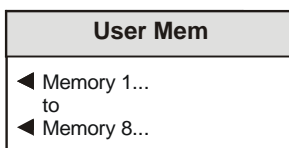

◀ Memory 1 to 8

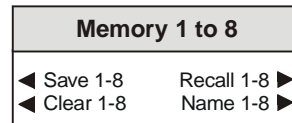

When a memory location has been selected this item allows it to be saved, recalled, cleared or renamed.

◀ Save 1-8

When selected the current settings will be saved at this location.

Recall 1-8 ▶

When selected the settings will be recalled from this location and applied to the unit.

◀ Clear 1-8

When selected the memory location will be cleared and returned to the default (preset) setting.

Name 1-8 ▶

The selected memory location may be renamed with this function.

To compile/edit the text the right ▶ and left ◀ buttons adjacent to the upper text line in the menu should be used to select the character position in the text and the spinwheel used to select the character.

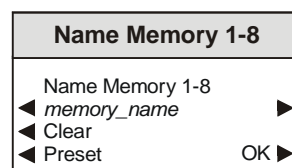

The ◀ **Clear** function blanks the selected character.

The ◀ **Preset** function loads the default text, for example, **Memory 1**.

O.K. ▶ saves the memory name text and returns to the main menu.

Genlock...

This allows the genlock options to be selected.

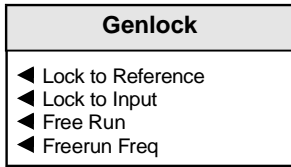

◀ Lock to Reference

When selected and the unit will lock to the external reference signal.

◀ Lock to Input

When selected the unit will lock to AES Input 1.

◀ Free Run

When selected the unit will not be locked to any input signals and the unit will free run.

◀ Freerun Freq(uecy)

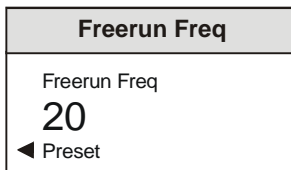

This allows the freerun frequency of the internal sync generator to be adjusted in steps of arbitrary units. Preset is to 0.

Setup...

This allows various functions to be setup.

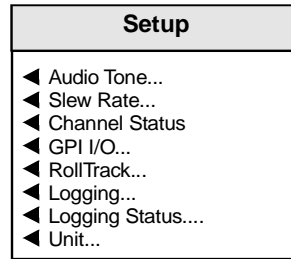

◀ Audio Tone

The frequency of the Audio Test Tone may be set using this control. Left and right channels may be set to different frequencies.

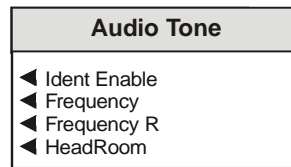

◀ Ident Enable

When selected the right channel will be identified by the signal being muted for 0.5 second every 2.5 seconds.

◀ Frequency

This adjusts the frequency of the test tone for the left channel only.

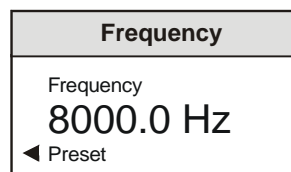

The range is from 100 Hz to 15 kHz in steps of 100 Hz. Preset is to 400 Hz.

◀ Frequency R

This adjusts the frequency of the test tone for the right channel only.

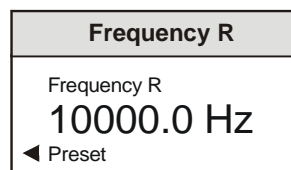

The range is from 100 Hz to 15 kHz in steps of 100 Hz. Preset is to 400 Hz.

◀ Headroom

This allows the headroom to be set.

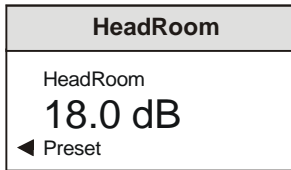

The range is from 4 dB to 24dB in 1 dB steps. Preset is to 18 dB.

Note that in this product headroom is defined as:

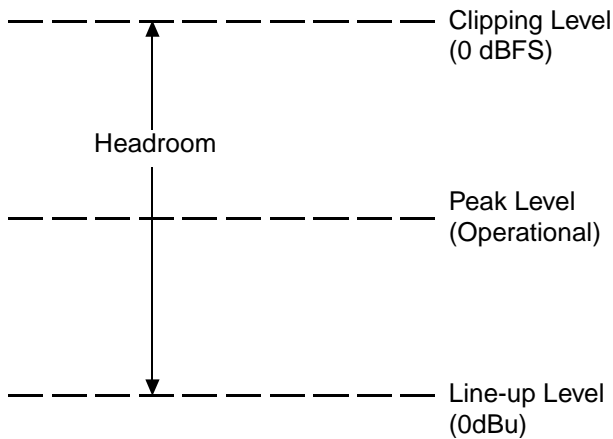

Headroom = Clipping Level – Line-up level

◀ Slew Rate

This is the time taken for the audio to slew when the audio mixing and routing controls have changed.

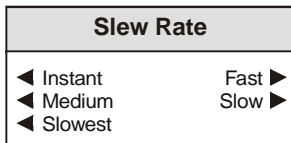

The options are:

Instant....The response is immediate

Slowest..Change takes approximately one second

SlowChange takes 75% of Slowest time

Medium..Change takes 50% of Slowest time

Fast.....Change takes 25% of Slowest time

◀ Channel Status

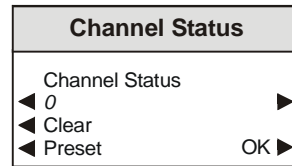

This will set the four character name used in the destination field of the audio channel status.

Note that the Channel Status Origin data is automatically set by the module to DLY00 and cannot be changed.

◀ GPI I/O

This function allows the GPI functions to be configured and their actions defined.

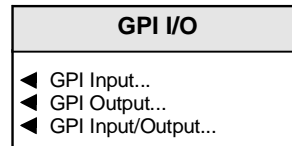

◀ GPI Input

This item allows the GPI input functions to be configured.

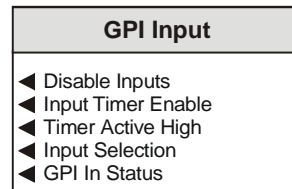

◀ Disable Inputs

When selected all GPI input functions will be disabled.

◀ Input Timer Enable

When checked the GPI will be monitored. The width of the pulse represents the delay that can be used to control audio delays in this unit.

Note that an audio delay pulse of more than 500 ms, applied to the GPI Input will be treated as invalid. This will result in the GPI delay returning to zero.

◀ Timer Active High

When checked the GPI will measure the positive going pulse.
When unchecked the negative pulse is measured.

◀ Input Selection

When configured as an input the GPI connection may be used for accepting GPI information (from mechanical switch contacts, relay contacts etc.)

The resulting action that the unit takes may be selected using this item.

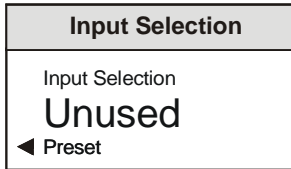

The GPI input functions that may be selected are as follows:

- Unused The unit will perform no function. This is also the Preset Setting.
- Pattern The unit will produce a pattern chosen from the Pattern menu when the input changes from open to closed.
- Memory 1 to 8 The unit will use the settings in the selected memory location when the input changes from open to closed.
- Mem1-2 The unit will toggle between the settings of memory locations 1 and 2.
Open to Closed = Memory 1 settings
Closed to Open = Memory 2 settings
- Mem 3-4 The unit will toggle between the settings of memory locations 3 and 4.
Open to Closed = Memory 3 settings
Closed to Open = Memory 4 settings
- Mem 5-6 The unit will toggle between the settings of memory locations 5 and 6.
Open to Closed = Memory 5 settings
Closed to Open = Memory 6 settings
- Mem 7-8 The unit will toggle between the settings of memory locations 7 and 8.
Open to Closed = Memory 7 settings
Closed to Open = Memory 8 settings

◀ GPI In Status

This will display the current status of the selected GPI input.

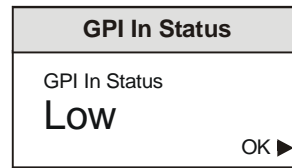

This may show either High or Low. When low, the associated function will be triggered.

On a transition, the associated function will be triggered.

◀ GPI Output

This item allows the GPI output functions to be configured.

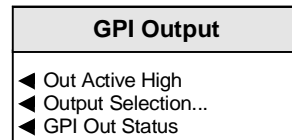

◀ Out Active High

Determines the sense of the asserted GPI output signal.

When checked GPI is active the output sense is high. When unchecked the GPI is active low.

◀ Output Selection

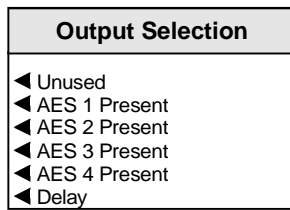

The GPO may be configured to produce an output corresponding to one of the following conditions:

- Unused
- AES 1 Present
- AES 2 Present
- AES 3 Present
- AES 4 Present
- Delay

The preset setting for the output is to Unused.

When the condition is not true the output will float but when the condition is true the output is closed to ground via a transistor.

Note that when delay mode is selected the output is a negative going TTL pulse. The width of the pulse represents the delay through the unit to the nearest millisecond.

◀ GPI Out Status

This will display the current status of the GPI output.

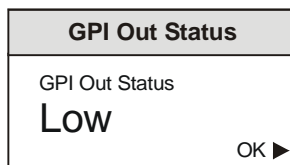

This may show either Unused, High, low or video delay in milliseconds.

◀ GPI I Input/Output

This allows the GPI port to be configured as an input or an output.

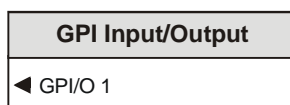

When selected the GPI is configured as an output. When unselected the GPI is configured as an input.

◀ **RollTrack**

This function allows information to be sent, via the RollCall™ network, to other compatible units connected on the same network.

For example, it can enable compatible audio delay units to produce an audio delay dependent on this and other similar units. The audio delay unit will dynamically follow or track the received delay-time information. This allows processed video signals to be timed correctly with audio signals. This automatic tracking system via the RollCall™ network is call **RollTrack**.

Reference Error	AES 4 Lost
	AES 4 PCM
	AES 4 NPCM
	GPI 1 Inactive

RollTrack
<ul style="list-style-type: none"> ◀ RollTrack Index ◀ RollTrack Source ◀ RollTrack Disable ◀ RollTrack Address ◀ RollTrack Command ◀ RollTrack Sending ◀ RollTrack Status

For more detailed information, see the RollTrack section (Appendix) at the end of this manual.

◀ RollTrack Index

RollTrack Index
RollTrack Index 10 ◀ Preset

This item is used to select which RollTrack Index is set up using the RollTrack Source, RollTrack Address and RollTrack Command functions.

It allows up to 70 destinations to be selected.

◀ RollTrack Source

RollTrack Source
RollTrack Source Audio Delay ◀ Preset

This allows the source of information that triggers the transmission of data to be selected. Options are:

Unused (off)	AES 1 Lost
Audio Delay	AES 1 PCM
Reference Lost	AES 1 NPCM
Reference Present	to

The destination for the information is set by the network code address.

Panel/RollCall Listing/Unit Information or via the *RollCall Control Panel Help/About Current Unit* function.

◀ RollTrack Address

This item allows the address of the selected destination unit to be set.

RollTrack Address	
RollTrack Address	
◀ 0 ▶	
◀ Clear ▶	
◀ Preset ▶	OK ▶

To compile/edit the text the right ▶ and left ◀ buttons adjacent to the upper text line in the menu should be used to select the character position in the text and the spinwheel used to select the character.

The ◀ **Clear** function blanks the selected character.

The ◀ **Preset** function loads the default address.

O.K. ▶ saves the address and returns to the main menu.

The full **RollTrack** address has four sets of numbers

For example: 0000:10:01*362

The first set (0000) is the network segment code number

The second set (10) is the number identifying the (enclosure/mainframe) unit.

The third set (01) is the slot number in the unit

The Fourth Set (362)

Each RollCall unit has a unique identification embedded in the units' software. In this example 362 represents an IQDMX00, 412 would represent an IQDEC00, 161 a Mach 1 etc. Inserting this number in the RollTrack address ensures that only the correct type of unit (in this example an IQDMX00) will respond to the RollTrack command; any other unit will ignore the command.

If this number were set to 00 **any type** of unit at this location would respond to the RollTrack command, possibly causing unpredictable results.

The unit ID of a module on the RollCall network may be found under *RollCall Control*

◀ **RollTrack Disable**

When this item is selected all RollTrack items will be disabled.

◀ RollTrack Command

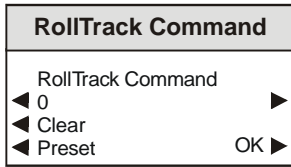

The full **RollTrack** command has two sets of numbers

For example: 84*156

The first set (84) is the **RollTrack** command number

Note that only command numbers 14, 15, 16 and 17 should be used for audio delay

The second set (156) is the value sent with the **RollTrack** command number.

*Note that when video delay or audio delay is selected as the **RollTrack** source the value sent with the **RollTrack** command is the video delay value not the value set.*

For details of the RollCall command values for specific units please contact your local Snell & Wilcox agent.

◀ RollTrack Sending

This item shows when the unit is actively sending the RollTrack command.

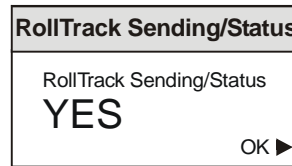

This may show:

- String A string value is always being sent.
- Number A number value is always being sent.
- No The message is not being sent.
- Yes The message is being sent.
- Internal Inconsistent behavior; please contact your local Snell & Wilcox agent.
- Type Error

◀ RollTrack Status

This item will show the status of the currently selected RollTrack index.

This may show:

- OK RollTrack message sent and received OK.
- Unknown Rolltrack message has been sent but it has not yet completed.
- Timeout RollTrack message sent but acknowledgement not received. This could be because the destination unit is not at the location specified.
- Error This indicates a broken RollCall state.
- Bad This indicates a broken RollCall packet.

◀ **Logging**

Information about up to 25 parameters can be made available to a logging device that is attached to the RollCall™ network by selecting the appropriate item.

Logging
◀ Reference
◀ Rolltrack
◀ AES 1
◀ AES 2
◀ AES 3
◀ AES 4
◀ Bus AL
◀ Bus AR
◀ Bus BL
◀ Bus BR
◀ Bus CL
◀ Bus CR
◀ Bus DL
◀ Bus DR
◀ Fault

Any of the items may be selected from the list.

◀ **Logging Status**

Logging Status
◀ EXTREF=
◀ ROLLTRACK=
◀ AES1=
◀ AES2=
◀ AES3=
◀ AES4=
◀ BUSAL=
◀ BUSAR=
◀ BUSBL=
◀ BUSBR=
◀ BUSCL=
◀ BUSCR=
◀ BUSDL=
◀ BUSDR=
◀ FAULT=

This will show the status of the selected item.

Logging Status Items	
Logging Status Items xxxxxxxx	OK ▶

ROLLCALL LOG FIELDS

**Note that these log values are either for future use or may be logged during a transitional state whilst acquiring or loosing an input signal. It is very unlikely that these states and the associated log values will become permanent.*

Log Field	Log Value	Description
EXTREF=	NONE 525 AES ERROR WARNING 625	No reference signal present Valid 525 reference signal Valid AES reference signal Reference/Output standard mismatch Reference signal available but not selected Valid 625 reference signal
ROL_STATES=	OK FAIL	RollTrack message sent and received OK RollTrack message not acknowledged
AES_1=	NONPCM OK LOST	Non-PCM signal present on AES input 1 Valid signal present on AES input 1 Signal not present at AES input 1
AES_2=	NONPCM OK LOST	Non-PCM signal present on AES input 2 Valid signal present on AES input 2 Signal not present at AES input 2
AES_3=*	NONPCM OK LOST	Non-PCM signal present on AES input 3 Valid signal present on AES input 3 Signal not present at AES input 3
AES_4=*	NONPCM OK LOST	Non-PCM signal present on AES input 4 Valid signal present on AES input 4 Signal not present at AES input 4
BUS_AL=	OK WARNING	Router BUS A Left channel has valid signal selected Router BUS A Left channel is receiving silence, low level, high level or overload signal
BUS_AR=	OK WARNING	Router BUS A Right channel has valid signal selected Router BUS A Right channel is receiving silence, low level, high level or overload signal
BUS_BL=	OK WARNING	Router BUS B Left channel has valid signal selected Router BUS B Left channel is receiving silence, low level, high level or overload signal
BUS_BR=	OK WARNING	Router BUS B Right channel has valid signal selected Router BUS B Right channel is receiving silence, low level, high level or overload signal
BUS_CL=	OK WARNING	Router BUS C Left channel has valid signal selected Router BUS C Left channel is receiving silence, low level, high level or overload signal
BUS_CR=	OK WARNING	Router BUS C Right channel has valid signal selected Router BUS C Right channel is receiving silence, low level, high level or overload signal
BUS_DL=	OK WARNING	Router BUS D Left channel has valid signal selected Router BUS D Left channel is receiving silence, low level, high level or overload signal
BUS_DR=	OK WARNING	Router BUS D Right channel has valid signal selected Router BUS D Right channel is receiving silence, low level, high level or overload signal
FAULT=	NONE FAIL	No Internal errors detected Internal error detected
SN=	Runtime string	Serial number of unit

◀ **Unit**

This provides various items of information about the unit.

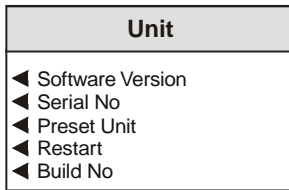

◀ **Software Version**

This item reveals a display showing the version of the software fitted in the module.

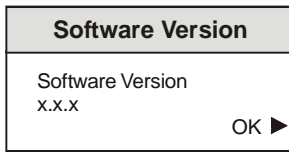

Select OK to return to the Unit Menu.

◀ **Serial No**

This item reveals a display showing the serial number of the module.

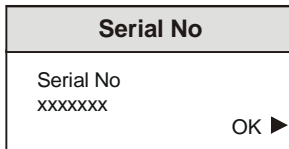

Select OK to return to the Unit Menu.

◀ **Preset Unit**

Selecting this item sets all audio setup items that include a preset facility, to their preset values.

Note that this is a momentary action.

◀ **Restart**

This will reboot the unit simulating a power-down power-up cycle restoring power-up settings.

◀ **Build No**

This will indicate the factory build number. This number defines all parameters of the unit (software versions, build level etc.) for identification purposes.

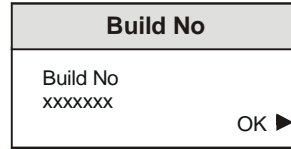

Select OK to return to the Unit Menu.

IQDLY00 RollCall Commands

Supervisor Level

Command No.		Command Name	Values
Hex	Dec		
0001	1	Serial No	Static Display (no control)
0002	2	Software Version	Static Display (no control)
0003	3	<RETURN>	1=Preset Unit 1=Restart
0005	5	Build No	Static Display (no control)
000E	14	Rolltrack 14	Static Display (no control)
000F	15	Rolltrack 15	Static Display (no control)
0010	16	Rolltrack 16	Static Display (no control)
0011	17	Rolltrack 17	Static Display (no control)
0419	1049	<RETURN>	0=Lock to Reference 1=Lock to Input 2=Free Run
0426	1062	Reference	clear=0 set=1 (toggle=2)
042D	1069	Fault	clear=0 set=1 (toggle=2)
0452	1106	RollTrack	clear=0 set=1 (toggle=2)
0454	1108	AES 1	clear=0 set=1 (toggle=2)
0455	1109	AES 2	clear=0 set=1 (toggle=2)
0456	1110	AES 3	clear=0 set=1 (toggle=2)
0457	1111	AES 4	clear=0 set=1 (toggle=2)
0458	1112	Bus AL	clear=0 set=1 (toggle=2)
0459	1113	Bus AR	clear=0 set=1 (toggle=2)
045A	1114	Bus BL	clear=0 set=1 (toggle=2)
045B	1115	Bus BR	clear=0 set=1 (toggle=2)
045C	1116	Bus CL	clear=0 set=1 (toggle=2)
045D	1117	Bus CR	clear=0 set=1 (toggle=2)
045E	1118	Bus DL	clear=0 set=1 (toggle=2)
045F	1119	Bus DR	clear=0 set=1 (toggle=2)
05D7	1495	RollTrack Index	min=0 max=15 Step=1
05D8	1496	RollTrack Source	min=-1 max=3 Step=1
05D9	1497	RollTrack Address	Edit String
05DA	1498	RollTrack Command	Edit String
05E7	1511	RollTrack Status	Static Display (no control)
05E9	1513	RollTrack Disable	clear=0 set=1 (toggle=2)
05EA	1514	RollTrack Sending	Static Display (no control)
0640	1600	<Memory 1>	1=Save 1
0641	1601	<Memory 1>	1=Recall 1
0642	1602	<Memory 1>	1=Clear 1
0643	1603	Name 1	Edit String
0644	1604	<Memory 2>	1=Save 2
0645	1605	<Memory 2>	1=Recall 2
0646	1606	<Memory 2>	1=Clear 2
0647	1607	Name 2	Edit String
0648	1608	<Memory 3>	1=Save 3
0649	1609	<Memory 3>	1=Recall 3
064A	1610	<Memory 3>	1=Clear 3
064B	1611	Name 3	Edit String
064C	1612	<Memory 4>	1=Save 4
064D	1613	<Memory 4>	1=Recall 4
064E	1614	<Memory 4>	1=Clear 4
064F	1615	Name 4	Edit String
0650	1616	<Memory 5>	1=Save 5
0651	1617	<Memory 5>	1=Recall 5
0652	1618	<Memory 5>	1=Clear 5
0653	1619	Name 5	Edit String
0654	1620	<Memory 6>	1=Save 6
0655	1621	<Memory 6>	1=Recall 6
0656	1622	<Memory 6>	1=Clear 6
0657	1623	Name 6	Edit String
0658	1624	<Memory 7>	1=Save 7
0659	1625	<Memory 7>	1=Recall 7
065A	1626	<Memory 7>	1=Clear 7
065B	1627	Name 7	Edit String
065C	1628	<Memory 8>	1=Save 8
065D	1629	<Memory 8>	1=Recall 8
065E	1630	<Memory 8>	1=Clear 8
065F	1631	Name 8	Edit String
07DB	2011	Input Selection	min=-1 max=12 Step=1
0800	2048	GPI In Status	Static Display (no control)
0801	2049	GPI Out Status	Static Display (no control)
0991	2449	Freerun Freq	min=-60 max=60 Step=1
09B7	2487	Frequency	min=100 max=15000 Step=100
09B8	2488	Frequency R	min=100 max=15000 Step=100

09B9	2489	Ident Enable	clear=0 set=1 (toggle=2)				
09D5	2517	Low Level	min=-96 max=0 Step=1				
09D6	2518	Warning Timer	min=1 max=20 Step=1				
0A08	2568	Manual	clear=0 set=1 (toggle=2)				
0A09	2569	Rolltrack 14	clear=0 set=1 (toggle=2)				
0A0A	2570	Rolltrack 15	clear=0 set=1 (toggle=2)				
0A0B	2571	Rolltrack 16	clear=0 set=1 (toggle=2)				
0A0C	2572	Rolltrack 17	clear=0 set=1 (toggle=2)				
0A0D	2573	Manual Delay	min=-40 max=1500 Step=1				
0A0D	2573	Manual	Static Display (no control)				
0A2D	2605	Disable Inputs	clear=0 set=1 (toggle=2)				
0B36	2870	RollTrack Index	min=0 max=15 Step=1				
0B37	2871	RollTrack Source	min=-1 max=3 Step=1				
0B38	2872	RollTrack Address	Edit String				
0B39	2873	RollTrack Command	Edit String				
0B3B	2875	Input Selection	min=-1 max=12 Step=1				
0B70	2928	AES 1 Delay	min=0 max=1500 Step=1				
0B71	2929	AES 2 Delay	min=0 max=1500 Step=1				
0B72	2930	AES 3 Delay	min=0 max=1500 Step=1				
0B73	2931	AES 4 Delay	min=0 max=1500 Step=1				
0B87	2951	<AES 1 Source>	0=BUS A 1=BUS B 2=BUS C 3=BUS D 4=AES 1 Direct 5=AES 2 Direct 6=AES 3 Direct 7=AES 4 Direct 8=Test tone 9=Silence				
0B88	2952	<AES 2 Source>	0=BUS A 1=BUS B 2=BUS C 3=BUS D 4=AES 1 Direct 5=AES 2 Direct 6=AES 3 Direct 7=AES 4 Direct 8=Test tone 9=Silence				
0B89	2953	<AES 3 Source>	0=BUS A 1=BUS B 2=BUS C 3=BUS D 4=AES 1 Direct 5=AES 2 Direct 6=AES 3 Direct 7=AES 4 Direct 8=Test tone 9=Silence				
0B8A	2954	<AES 4 Source>	0=BUS A 1=BUS B 2=BUS C 3=BUS D 4=AES 1 Direct 5=AES 2 Direct 6=AES 3 Direct 7=AES 4 Direct 8=Test tone 9=Silence				
0B9C	2972	<Slew Rate>	0=Instant 1=Fast 2=Medium 3=Slow 4=Slowest				
0BA3	2979	Total Delay Display	Static Display (no control)				
0BAA	2986	EXTREF=	Static Display (no control)				
0BAD	2989	ROLLTRACK=	Static Display (no control)				
0BAE	2990	FAULT=	Static Display (no control)				
0BB2	2994	AES1=	Static Display (no control)				
0BB3	2995	AES2=	Static Display (no control)				
0BB4	2996	AES3=	Static Display (no control)				
0BB5	2997	AES4=	Static Display (no control)				
0BB6	2998	BUSAL=	Static Display (no control)				
0BB7	2999	BUSAR=	Static Display (no control)				
0BB8	3000	BUSBL=	Static Display (no control)				
0BB9	3001	BUSBR=	Static Display (no control)				
0BBA	3002	BUSCL=	Static Display (no control)				
0BBB	3003	BUSCR=	Static Display (no control)				
0BBC	3004	BUSDL=	Static Display (no control)				
0BBD	3005	BUSDR=	Static Display (no control)				
0BEB	3051	GPI Delay Select	clear=0 set=1 (toggle=2)				
0BEC	3052	GPI Delay Display	Static Display (no control)				
0BED	3053	InputTimer Enable	clear=0 set=1 (toggle=2)				
0BEE	3054	TimerActive High	clear=0 set=1 (toggle=2)				
0BEF	3055	HeadRoom	min=4 max=24 Step=1				
0BF0	3056	Silence Level	min=-96 max=0 Step=1				
0BF1	3057	High Level	min=-96 max=0 Step=1				
0BF2	3058	Overload Level	min=-96 max=0 Step=1				
0BF4	3060	Channel Status	Edit String				
0C08	3080	Gain Bus AL	min=-180 max=180 Step=1 Div=10				
0C09	3081	Gain Bus AR	min=-180 max=180 Step=1 Div=10				
0C0A	3082	Gain Bus BL	min=-180 max=180 Step=1 Div=10				
0C0B	3083	Gain Bus BR	min=-180 max=180 Step=1 Div=10				
0C0C	3084	Gain Bus CL	min=-180 max=180 Step=1 Div=10				
0C0D	3085	Gain Bus CR	min=-180 max=180 Step=1 Div=10				
0C0E	3086	Gain Bus DL	min=-180 max=180 Step=1 Div=10				
0C0F	3087	Gain Bus DR	min=-180 max=180 Step=1 Div=10				
0C10	3088	Gain AES 1L	min=-180 max=180 Step=1 Div=10				
0C11	3089	Gain AES 1R	min=-180 max=180 Step=1 Div=10				
0C12	3090	Gain AES 2L	min=-180 max=180 Step=1 Div=10				
0C13	3091	Gain AES 2R	min=-180 max=180 Step=1 Div=10				
0C14	3092	Gain AES 3L	min=-180 max=180 Step=1 Div=10				
0C15	3093	Gain AES 3R	min=-180 max=180 Step=1 Div=10				
0C16	3094	Gain AES 4L	min=-180 max=180 Step=1 Div=10				
0C17	3095	Gain AES 4R	min=-180 max=180 Step=1 Div=10				
0C58	3160	Invert	clear=0 set=1 (toggle=2)				

0C59	3161	Invert	clear=0	set=1	(toggle=2)			
0C5A	3162	Invert	clear=0	set=1	(toggle=2)			
0C5B	3163	Invert	clear=0	set=1	(toggle=2)			
0C5C	3164	Invert	clear=0	set=1	(toggle=2)			
0C5D	3165	Invert	clear=0	set=1	(toggle=2)			
0C5E	3166	Invert	clear=0	set=1	(toggle=2)			
0C5F	3167	Invert	clear=0	set=1	(toggle=2)			
0C60	3168	Invert	clear=0	set=1	(toggle=2)			
0C61	3169	Invert	clear=0	set=1	(toggle=2)			
0C62	3170	Invert	clear=0	set=1	(toggle=2)			
0C63	3171	Invert	clear=0	set=1	(toggle=2)			
0C64	3172	Invert	clear=0	set=1	(toggle=2)			
0C65	3173	Invert	clear=0	set=1	(toggle=2)			
0C66	3174	Invert	clear=0	set=1	(toggle=2)			
0C67	3175	Invert	clear=0	set=1	(toggle=2)			
0CA8	3240	Mute	clear=0	set=1	(toggle=2)			
0CA9	3241	Mute	clear=0	set=1	(toggle=2)			
0CAA	3242	Mute	clear=0	set=1	(toggle=2)			
0CAB	3243	Mute	clear=0	set=1	(toggle=2)			
0CAC	3244	Mute	clear=0	set=1	(toggle=2)			
0CAD	3245	Mute	clear=0	set=1	(toggle=2)			
0CAE	3246	Mute	clear=0	set=1	(toggle=2)			
0CAF	3247	Mute	clear=0	set=1	(toggle=2)			
0CB0	3248	Mute	clear=0	set=1	(toggle=2)			
0CB1	3249	Mute	clear=0	set=1	(toggle=2)			
0CB2	3250	Mute	clear=0	set=1	(toggle=2)			
0CB3	3251	Mute	clear=0	set=1	(toggle=2)			
0CB4	3252	Mute	clear=0	set=1	(toggle=2)			
0CB5	3253	Mute	clear=0	set=1	(toggle=2)			
0CB6	3254	Mute	clear=0	set=1	(toggle=2)			
0CB7	3255	Mute	clear=0	set=1	(toggle=2)			
0CF8	3320	Stereo A	clear=0	set=1	(toggle=2)			
0CF9	3321	Stereo B	clear=0	set=1	(toggle=2)			
0CFA	3322	Stereo C	clear=0	set=1	(toggle=2)			
0CFB	3323	Stereo D	clear=0	set=1	(toggle=2)			
0CFC	3324	Stereo 1	clear=0	set=1	(toggle=2)			
0CFD	3325	Stereo 2	clear=0	set=1	(toggle=2)			
0CFE	3326	Stereo 3	clear=0	set=1	(toggle=2)			
0CFF	3327	Stereo 4	clear=0	set=1	(toggle=2)			
0D20	3360	Gain1	min=-71	max=0	Step=1			
0D21	3361	Gain2	min=-71	max=0	Step=1			
0D22	3362	Gain3	min=-71	max=0	Step=1			
0D23	3363	Gain4	min=-71	max=0	Step=1			
0D24	3364	Gain1	min=-71	max=0	Step=1			
0D25	3365	Gain2	min=-71	max=0	Step=1			
0D26	3366	Gain3	min=-71	max=0	Step=1			
0D27	3367	Gain4	min=-71	max=0	Step=1			
0D28	3368	Gain1	min=-71	max=0	Step=1			
0D29	3369	Gain2	min=-71	max=0	Step=1			
0D2A	3370	Gain3	min=-71	max=0	Step=1			
0D2B	3371	Gain4	min=-71	max=0	Step=1			
0D2C	3372	Gain1	min=-71	max=0	Step=1			
0D2D	3373	Gain2	min=-71	max=0	Step=1			
0D2E	3374	Gain3	min=-71	max=0	Step=1			
0D2F	3375	Gain4	min=-71	max=0	Step=1			
0D70	3440	<RETURN>	0=AES 1L	1=AES 1R	2=AES 2L	3=AES 2R		
			4=AES 3L	5=AES 3R	6=AES 4L	7=AES 4R		
0D71	3441	<RETURN>	0=AES 1L	1=AES 1R	2=AES 2L	3=AES 2R		
			4=AES 3L	5=AES 3R	6=AES 4L	7=AES 4R		
0D72	3442	<RETURN>	0=AES 1L	1=AES 1R	2=AES 2L	3=AES 2R		
			4=AES 3L	5=AES 3R	6=AES 4L	7=AES 4R		
0D73	3443	<RETURN>	0=AES 1L	1=AES 1R	2=AES 2L	3=AES 2R		
			4=AES 3L	5=AES 3R	6=AES 4L	7=AES 4R		
0D74	3444	<RETURN>	0=AES 1L	1=AES 1R	2=AES 2L	3=AES 2R		
			4=AES 3L	5=AES 3R	6=AES 4L	7=AES 4R		
0D75	3445	<RETURN>	0=AES 1L	1=AES 1R	2=AES 2L	3=AES 2R		
			4=AES 3L	5=AES 3R	6=AES 4L	7=AES 4R		
0D76	3446	<RETURN>	0=AES 1L	1=AES 1R	2=AES 2L	3=AES 2R		
			4=AES 3L	5=AES 3R	6=AES 4L	7=AES 4R		
0D77	3447	<RETURN>	0=AES 1L	1=AES 1R	2=AES 2L	3=AES 2R		
			4=AES 3L	5=AES 3R	6=AES 4L	7=AES 4R		
0D78	3448	<RETURN>	0=AES 1L	1=AES 1R	2=AES 2L	3=AES 2R		
			4=AES 3L	5=AES 3R	6=AES 4L	7=AES 4R		
0D79	3449	<RETURN>	0=AES 1L	1=AES 1R	2=AES 2L	3=AES 2R		
			4=AES 3L	5=AES 3R	6=AES 4L	7=AES 4R		
0D7A	3450	<RETURN>	0=AES 1L	1=AES 1R	2=AES 2L	3=AES 2R		
			4=AES 3L	5=AES 3R	6=AES 4L	7=AES 4R		
0D7B	3451	<RETURN>	0=AES 1L	1=AES 1R	2=AES 2L	3=AES 2R		
			4=AES 3L	5=AES 3R	6=AES 4L	7=AES 4R		
0D7C	3452	<RETURN>	0=AES 1L	1=AES 1R	2=AES 2L	3=AES 2R		

0D7D	3453	<RETURN>	4=AES 3L	5=AES 3R	6=AES 4L	7=AES 4R
			0=AES 1L	1=AES 1R	2=AES 2L	3=AES 2R
			4=AES 3L	5=AES 3R	6=AES 4L	7=AES 4R
0D7E	3454	<RETURN>	0=AES 1L	1=AES 1R	2=AES 2L	3=AES 2R
			4=AES 3L	5=AES 3R	6=AES 4L	7=AES 4R
0D7F	3455	<RETURN>	0=AES 1L	1=AES 1R	2=AES 2L	3=AES 2R
			4=AES 3L	5=AES 3R	6=AES 4L	7=AES 4R
0DC0	3520	<RETURN>	0=AES 1L	1=AES 1R	2=AES 2L	3=AES 2R
			4=AES 3L	5=AES 3R	6=AES 4L	7=AES 4R
			8=MIX 1	9=MIX 2	10=MIX 3	11=MIX 4
0DC1	3521	<RETURN>	0=AES 1L	1=AES 1R	2=AES 2L	3=AES 2R
			4=AES 3L	5=AES 3R	6=AES 4L	7=AES 4R
			8=MIX 1	9=MIX 2	10=MIX 3	11=MIX 4
0DC2	3522	<RETURN>	0=AES 1L	1=AES 1R	2=AES 2L	3=AES 2R
			4=AES 3L	5=AES 3R	6=AES 4L	7=AES 4R
			8=MIX 1	9=MIX 2	10=MIX 3	11=MIX 4
0DC3	3523	<RETURN>	0=AES 1L	1=AES 1R	2=AES 2L	3=AES 2R
			4=AES 3L	5=AES 3R	6=AES 4L	7=AES 4R
			8=MIX 1	9=MIX 2	10=MIX 3	11=MIX 4
0DC4	3524	<RETURN>	0=AES 1L	1=AES 1R	2=AES 2L	3=AES 2R
			4=AES 3L	5=AES 3R	6=AES 4L	7=AES 4R
			8=MIX 1	9=MIX 2	10=MIX 3	11=MIX 4
0DC5	3525	<RETURN>	0=AES 1L	1=AES 1R	2=AES 2L	3=AES 2R
			4=AES 3L	5=AES 3R	6=AES 4L	7=AES 4R
			8=MIX 1	9=MIX 2	10=MIX 3	11=MIX 4
0DC6	3526	<RETURN>	0=AES 1L	1=AES 1R	2=AES 2L	3=AES 2R
			4=AES 3L	5=AES 3R	6=AES 4L	7=AES 4R
			8=MIX 1	9=MIX 2	10=MIX 3	11=MIX 4
0DC7	3527	<RETURN>	0=AES 1L	1=AES 1R	2=AES 2L	3=AES 2R
			4=AES 3L	5=AES 3R	6=AES 4L	7=AES 4R
			8=MIX 1	9=MIX 2	10=MIX 3	11=MIX 4

RollTrack Audio Delay Tracking

RollTrack is a feature of RollCall™ (Snell & Wilcox's proprietary remote control system), that allows devices to communicate across the RollCall network with no direct user intervention.

RollTrack Audio Delay Tracking enables Snell & Wilcox RollCall™ compatible audio delay products to track delay introduced by RollCall™ compatible video processing products.

The current products that implement RollTrack Audio Delay Tracking are:

Audio Delay Modules	Video Modules	Other Products	
IQBAAD	IQD1FSY	ALCHEMIST	MDD3000
IQBADC	IQDMSDS	CPP100	MDD550
IQBDAC	IQDAFS	CPP200	MDD560
IQBDAD	IQDMSDS	NRS500	MDD570
IQBSYN	IQDMSDP	HD5050	MDD2000
IQBADCD	IQDSYN		

The simplest configuration is a single video unit and a single audio delay in a RollCall™ system. The audio delay will have the same delay as through the video path. If the delay changes the audio delay will track.

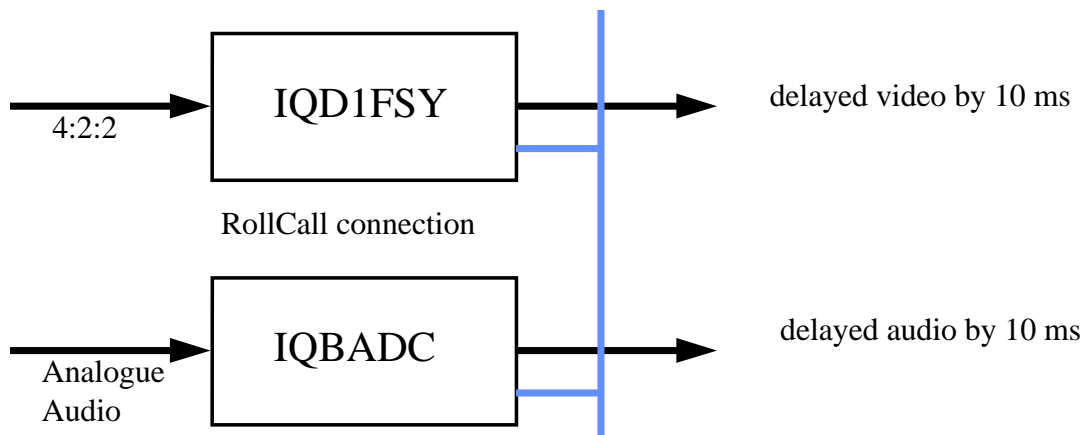

The next level of configuration is where there are multiple Frame Synchronizers (for example) each connected through RollCall™ to their own tracking Audio Delay. (It is worth stating that the synchronizers and audio delays do not have to be in the same enclosure; the addressing scheme, discussed later, allows for the units to be positioned anywhere in the RollCall™ domain.)

The maximum number of video units and audio delays in a RollCall™ system is set by the maximum limit of the number of modules in a RollCall™ network and is currently 3840 on a single network without bridges.

The unique identification of the destination unit (a decimal number) for various modules is as follows:

Module	ID
IQBADC	51
IQBDAC	52
IQBAAD	53
IQBDAD	54
IQBSYN	89
IQBADCD	107

The next level of complexity is a *vertical delay cluster* where a video unit can have up to eight audio delays tracking - of the same or different types.

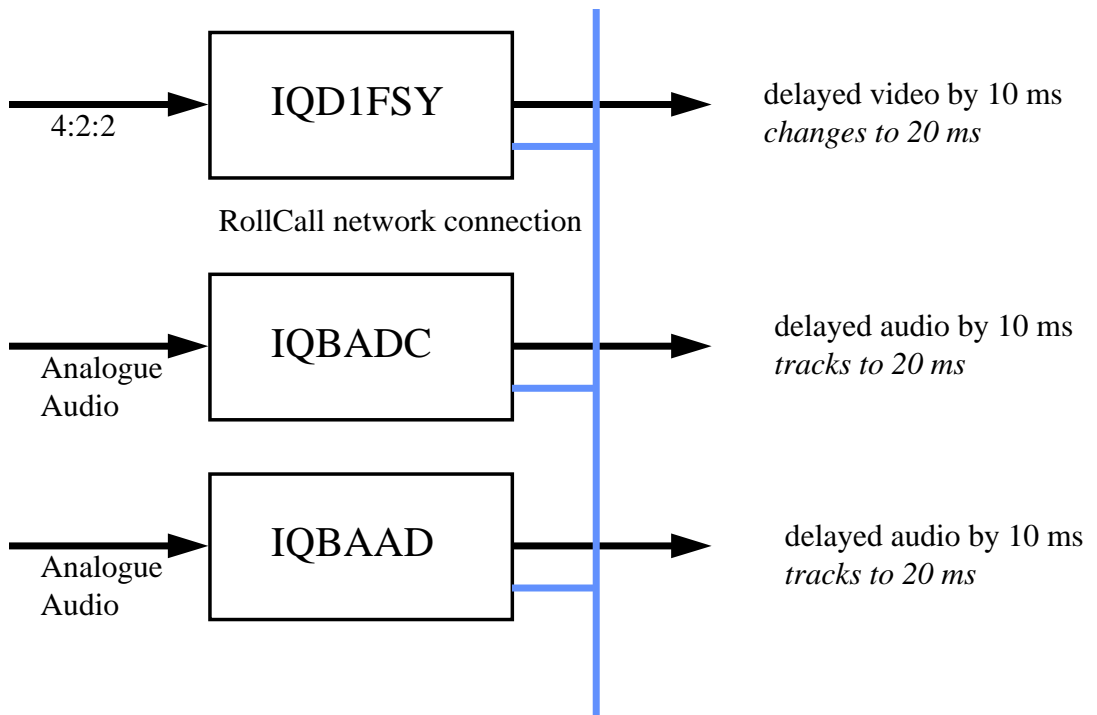

From one to eight audio delay products can be connected via RollCall™ to a single frame synchronizer, for example. If the synchronizer delay changes, then however many audio delays are connected will track the delay. The audio delays can also have a manual delay which will be added to the RollTrack delay.

The next level of complexity is a *horizontal delay cluster* where an audio delay can track up to four video units.

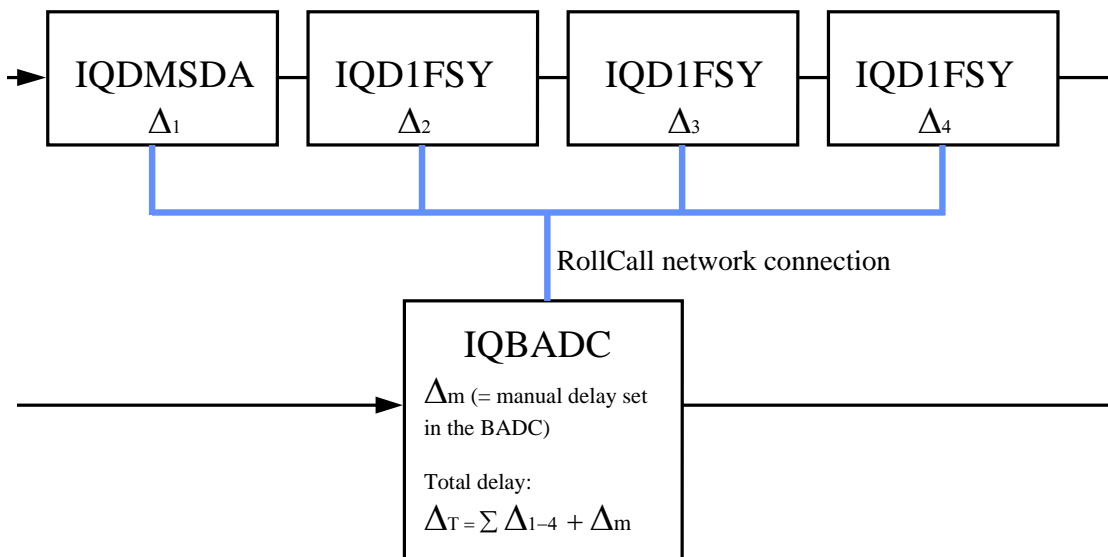

The total delay time through the audio delay is then the sum of the individual delays introduced by the video units plus the manual delay of the audio unit. The manual delay can be set to compensate for any fixed propagation delay in the video path or may be set to zero.

The next level of complexity is a *matrix delay cluster* where each audio delay (up to eight) can track up to four video units. This configuration is in effect a four by eight matrix of video units and audio delay units. The total delay time through the audio delay units is then the sum of the individual delays introduced by the video units plus the manual delay of the audio unit.

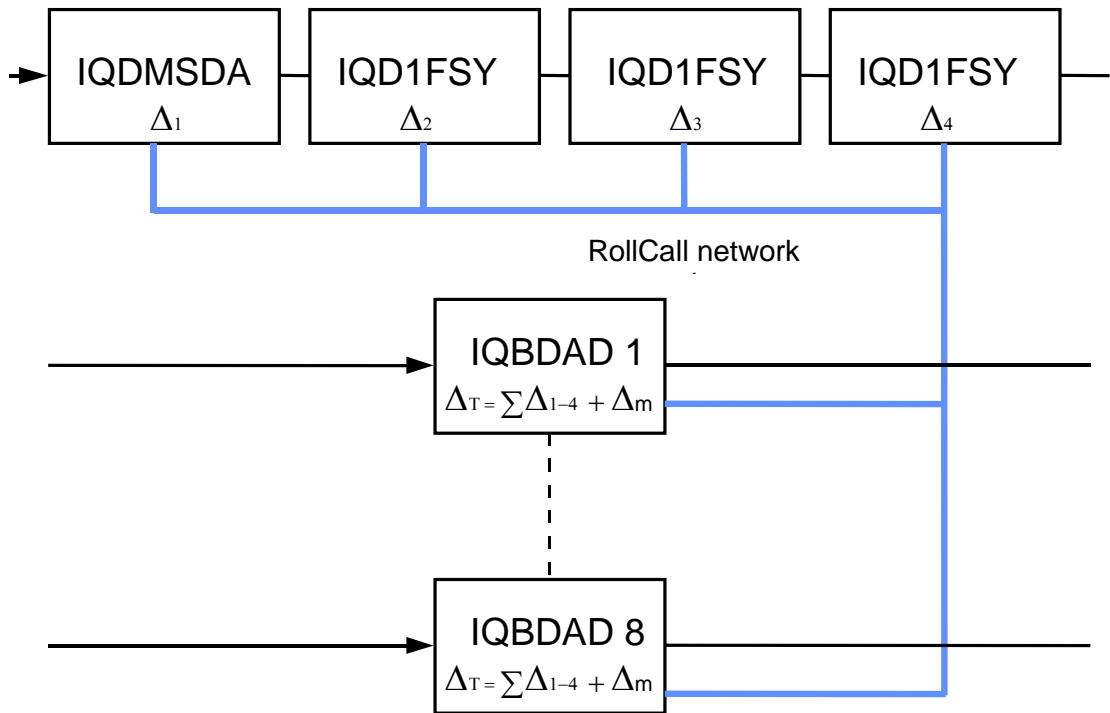

As any of the delay times change in the video path so will the audio delay time track this delay. A virtual connection is made between from, say, an IQD1FSY to an IQBDAD by:

- selecting the *Setup...* Menu of the IQD1FSY
- then selecting the *Audio_Delay...* Menu
- then choosing from *Unit_1* to *Unit_8*
- then entering the unique network address of the IQBDAD in the form *nnnn:xx:yy*z*d*
- where *nnnn* = network address and in most cases will be 0000(hex);
- xx* = IQ enclosure address (hex);
- yy* = slot address of the IQBDAD (hex)
- z* = the connection (or channel) number (decimal) - see table below.
- d* = the unique identification of the destination unit (decimal) The ID entered must match the

receiving units own ID or else the command will be ignored. If the ID value is set to 00, the receiving unit does not perform an ID match and will always accept the incoming command

- then selecting the *Delay...* Menu of the IQBDAD
- then selecting *RollTrack*

Example of Network Addresses with Channel Numbers and ID Numbers

	D1FSY 1	D1FSY 2	D1FSY 3	D1FSY 4
Audio delay 1	0000:10:01*14*54	0000:10:01*15*54	0000:10:01*16*54	0000:10:01*17*54
Audio delay 2	0000:10:03*14*54	0000:10:03*15*54	0000:10:03*16*54	0000:10:03*17*54
Audio delay 3	0000:10:05*14*54	0000:10:05*15*54	0000:10:05*16*54	0000:10:05*17*54
Audio delay 4	0000:10:07*14*54	0000:10:07*15*54	0000:10:07*16*54	0000:10:07*17*54
Audio delay 5	0000:10:09*14*54	0000:10:09*15*54	0000:10:09*16*54	0000:10:09*17*54
Audio delay 6	0000:10:0B*14*54	0000:10:0B*15*54	0000:10:0B*16*54	0000:10:0B*17*54
Audio delay 7	0000:10:0D*14*54	0000:10:0D*15*54	0000:10:0D*16*54	0000:10:0D*17*54
Audio delay 8	0000:10:0F*14*54	0000:10:0F*15*54	0000:10:0F*16*54	0000:10:0F*17*54

The most complex system would be an array of matrix delay clusters

