

IQADA00

Single/Dual Channel Analog Audio Distribution Amplifier



Module Description	2
Rear Panel Views.....	2
Product Comparison	2
Block Diagram	4
Features.....	4
Technical Profile.....	5
INPUT AND OUTPUT CONNECTIONS	6
Analog IN (IQADA0010-1A, 0012-2).....	6
Audio IN (IQADA0036-1A)	6
Analog OUT (IQADA0010-1A, 0012-2).....	7
Audio OUT (IQADA0036-1A)	7
25 Way D Type Connection Details for Connector 1 and Connector 2.....	8
CARD EDGE INDICATORS	10
RollCall PC Control Panel Screens.....	11
Setup	11
Information Window.....	12
Logging.....	13
ROLLCALL LOG FIELDS	13
RollTrack	14
Operation from an Active Control Panel.....	16
MAIN MENU.....	18
Setup... ..	18
Logging.....	20
ROLLCALL LOG FIELDS	20
RollTrack	21
Manual Revision Record.....	23

Module Description

The IQADA00 provides dual analog inputs with up to five outputs per input, or a single analog input with up to ten outputs.

Rear Panel Views

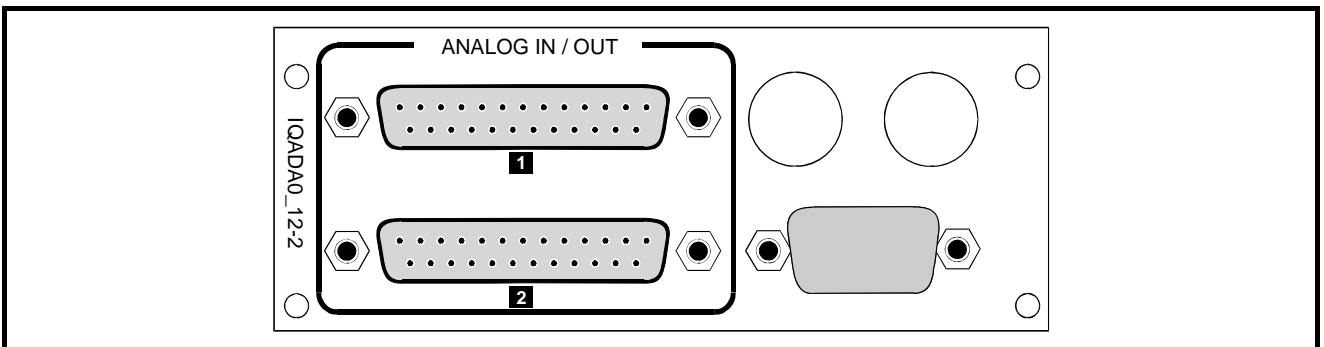
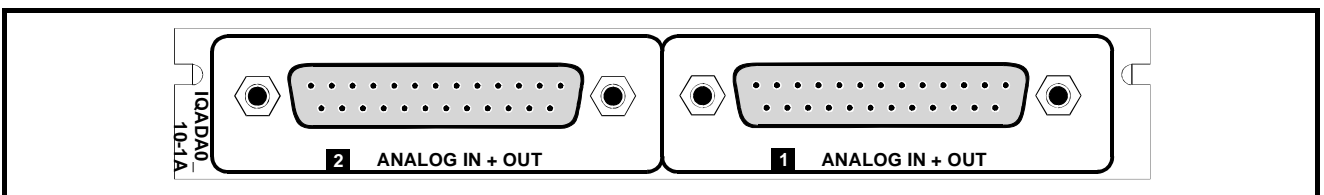
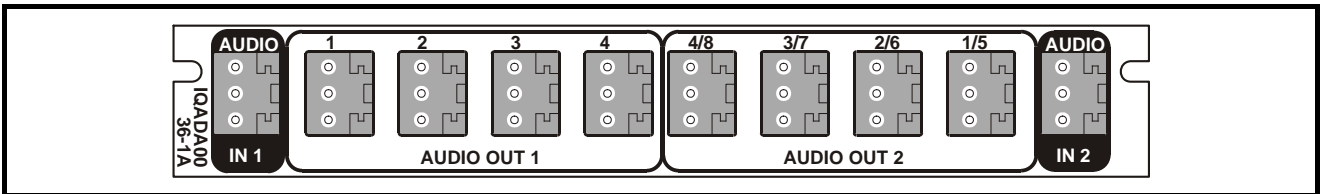

This manual covers the following products:

IQADA0036-1A Single/Dual Channel Analog DA. Balanced Screw-terminal Audio Connections. Configurable for 1 input to 8 outputs or 2 inputs to 4 outputs per input
 IQADA0010-1A Single/Dual Channel Analog DA. Balanced D-type Audio Connections. Configurable

for 1 input to 10 outputs or 2 inputs to 5 outputs per input
 IQADA0012-2 Single/Dual Channel Analog DA. Balanced D-type Audio Connections. Configurable for 1 input to 10 outputs or 2 inputs to 5 outputs per input

Product Comparison

Product	Analog Inputs	Analog Outputs	Width & Style
IQADA0036-1A	1 Balanced Screw-terminal	8 Balanced Screw-terminal	Single A
	2 Balanced Screw-terminal	4 Balanced Per Input Screw-terminal	
IQADA0010-1A	1 Balanced D-type	10 Balanced D-type	Single A
	2 Balanced D-type	5 Balanced Per Input D-type	
IQADA0012-2	1 Balanced D-type	10 Balanced D-type	Double O
	2 Balanced D-type	5 Balanced Per Input D-type	

Note that there are two styles of rear panels available. They are not interchangeable between the two styles of enclosures. However, the cards may be fitted into any style of enclosure.

'A' Style Enclosure

Rear panels **with** the suffix A may only be fitted into the 'A' style enclosure shown below.

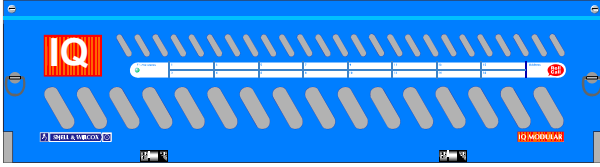

(Enclosure order codes IQH3A-E-0, IQH3A-E-P, IQH3A-0-0, IQH3A-0-P)



(Enclosure order codes IQH3A-S-0, IQH3A-S-P)



(Enclosure order code IQH1A-S-P)

'0' Style Enclosures

Rear panels **without** the suffix A may only be fitted into the '0' style enclosures shown below.

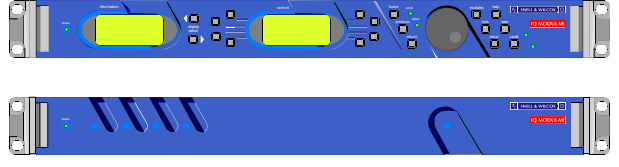

(Enclosure order codes IQH1S-RC-0, IQH1S-RC-AP, IQH1U-RC-0, IQH1U-RC-AP, Kudos Plus Products)

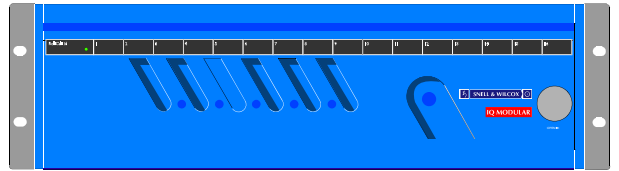

(Enclosure order codes IQH3N-0, IQH3N-P)



(Enclosure order codes IQH3U-RC-0, IQH3U-RC-P)

Block Diagram

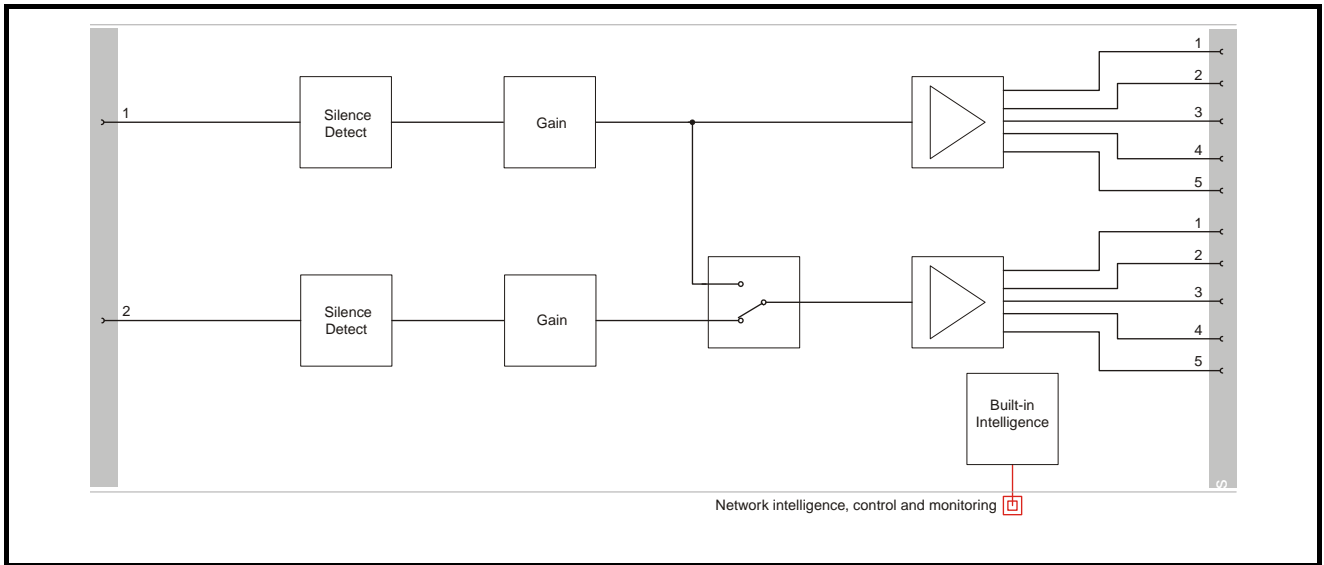

Block diagram for IQADA0010-1A shown

Features

- Configurable for 1 input to 10 outputs, or 2 inputs to 5 outputs per input (dependant on rear panel type)
- Very low THD+N
- Output gain remotely adjustable from +24 dB to -24 dB with fine control
- +24 dBu headroom

Technical Profile

Signal Inputs

Analog.....2 channels balanced via screw-terminal or D-type connector

Signal Outputs

Analog.....4 (5) per input channel balanced via screw-terminal (or D-type connector)

Note: Configurable for 1 input to 8 (10) output operation

Indicators

Power up or CPU faultGood = Off/Fault = Red

CPU running but input 1 not detected (both inputs or primary input when in single channel mode)
Input detected = Off/Not Detected = Yellow

CPU running but input 2 not detected (both inputs or primary input when in single channel mode)
Input detected = Off/Not detected = Yellow

Normal operation with input detected (either input or primary input when in single channel mode)
Input not detected = Off/Input detected = Green

Controls

ModeSingle, Dual channel

Fine Gain Adjustment..... ± 0.5 dB additional to the coarse gain level, separately adjustable for each input

Functions Available via RollCall

Gain (Separate L and R)....+24 dB to -24 dB in 0.5 dB steps

Silence Detect.....Level adjustable, - 15 to -25 dBu in 1 dB steps

Warning Timer 1 to 60s (for silence detection)

Reporting (* also Logged)

Silence Detected.....*Silence Detected (L and R)

RollTrack ControlsOn/Off, Index, Source, Address, Command, Status, Sending.

RollTrack.....Unused
Input 1 Present
Input 1 Silent
Input 2 Present
Input 2 Silent

Specifications

Analog Input/Output Level...Headroom set to:
+24 dBu (17.5 V pk to pk) Gain at Unity

Analog Input Impedance10 k Ohms (600 Ohm Option)

Analog Output Impedance ..Balanced <50 ohms

Total Harmonic Distortion + Noise
<-94 dBu (0.002%) at 700 Hz,
24 dBu input and 0 dB gain

Gain Accuracy< ± 0.2 dB @ 0 dB

Gain Error (Channel 1 to Channel 2)
< ± 0.2 dB @ 0 dB

Common Mode Rejection....<-70 dB (20 Hz to 20 kHz)

Frequency Response ± 0.1 dB(20 Hz to 20 kHz with reference to 1 kHz)

Channel 1 to 2 cross talk<-110 dB at 1 kHz

Headroom (in and out)24 dBu (Note: a maximum of 3 outputs can be driven at 24 dBu when using 600 Ohm terminations)

Power Consumption

Module Power Consumption
8.8 W max

INPUT AND OUTPUT CONNECTIONS

Note that these units may be configured as single or dual input amplifiers by setting links on the card. Please see page 10 for details.

Analog IN (IQADA0010-1A, 0012-2)

All balanced input connections are made via these 25 way female D-type connectors.

For connection data consult the tables on page 8.

Note that when configured as a single input, ten output amplifier connector 1 should be used for the input signal.

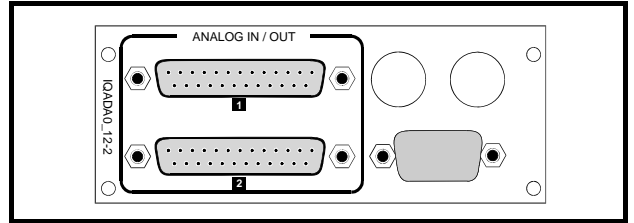
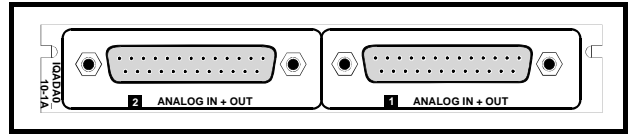

Audio IN (IQADA0036-1A)

All balanced connections are made via a screw-terminal connector as shown below.

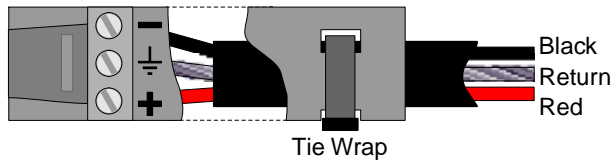

Cable used for AES screw terminals should equal or exceed Belden 1800B specifications for full module performance and the wire tails MUST be as short as possible and be assembled as shown above.

Note that when configured as a single input, eight output amplifier connector 1 should be used for the input signal.

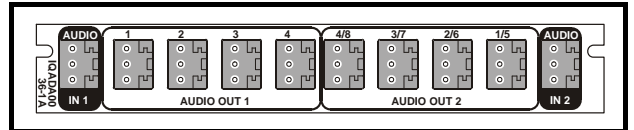

Analog OUT (IQADA0010-1A, 0012-2)

All balanced output connections are made via the 25 way female D-type connectors.

For connection data consult the tables on page 8.

Note that when configured as a single input, ten output amplifier the additional five outputs will be available on connector 2.

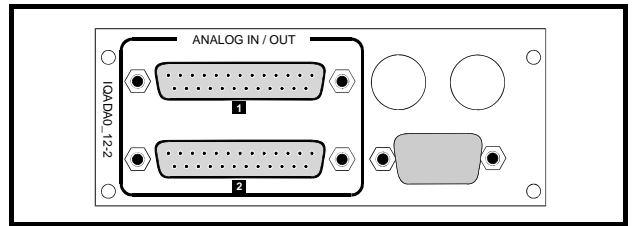
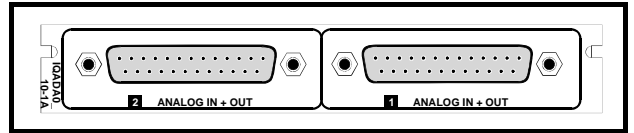

Audio OUT (IQADA0036-1A)

All balanced output connections are made via a screw-terminal connector as shown above.

*Note that when configured as a single input, eight output amplifier the additional four outputs will be available via **Audio Out 2**.*

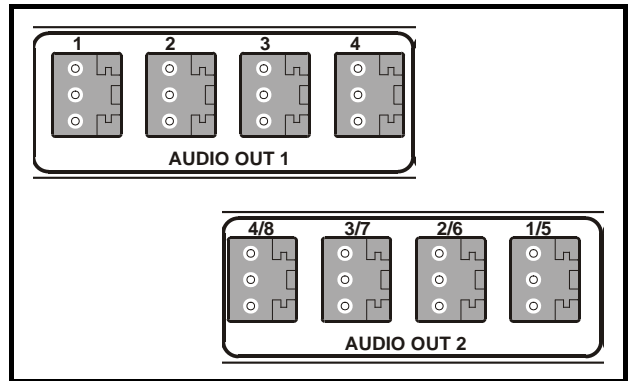
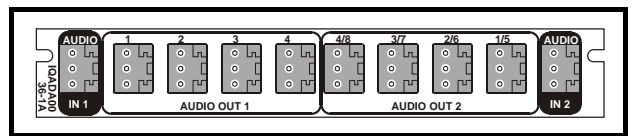

25 Way D Type Connection Details for Connector 1 and Connector 2

By Pin Number

Pin No	Description	Connection
1	Chassis Ground	Ground
2	Channel 1 +	Do not use
3	Channel 2 +	Do not use
4	Ground (2)	Ground
5	Channel 3 +	Analog Audio Output 5 +
6	Channel 4 +	Analog Audio Output 4 +
7	Ground (4)	Ground
8	Channel 5 +	Analog Audio Output 3 +
9	Channel 6 +	Analog Audio Output 2 +
10	Ground (6)	Ground
11	Channel 7 +	Analog Audio Output 1 +
12	Channel 8 +	Analog Input +
13	Ground (8)	Ground
14	Ground (1)	Ground
15	Channel 1 –	Do not use
16	Channel 2 –	Do not use
17	Ground (3)	Ground
18	Channel 3 –	Analog Audio Output 5 –
19	Channel 4 –	Analog Audio Output 4 –
20	Ground (5)	Ground
21	Channel 5 –	Analog Audio Output 3 –
22	Channel 6 –	Analog Audio Output 2 –
23	Ground (7)	Ground
24	Channel 7 –	Analog Audio Output 1 –
25	Channel 8 –	Analog Input –

By Function

Pin No	Description	Connection
1	Chassis Ground	Ground
2	Channel 1 +	Do not use
15	Channel 1 –	Do not use
14	Ground (1)	Ground
3	Channel 2 +	Do not use
16	Channel 2 –	Do not use
4	Ground (2)	Ground
5	Channel 3 +	Analog Audio Output 5 +
18	Channel 3 –	Analog Audio Output 5 –
17	Ground (3)	Ground
6	Channel 4 +	Analog Audio Output 4 +
19	Channel 4 –	Analog Audio Output 4 –
7	Ground (4)	Ground
8	Channel 5 +	Analog Audio Output 3 +
21	Channel 5 –	Analog Audio Output 3 –
20	Ground (5)	Ground
9	Channel 6 +	Analog Audio Output 2 +
22	Channel 6 –	Analog Audio Output 2 –
10	Ground (6)	Ground
11	Channel 7 +	Analog Audio Output 1 +
24	Channel 7 –	Analog Audio Output 1 –
23	Ground (7)	Ground
12	Channel 8 +	Analog Input +
25	Channel 8 –	Analog Input –
13	Ground (8)	Ground

Note that when configured as a single input, ten output amplifier, connector 1 should be used for the input signal. The additional five outputs will be available on connector 2.

Example of Connection to XLR Connectors

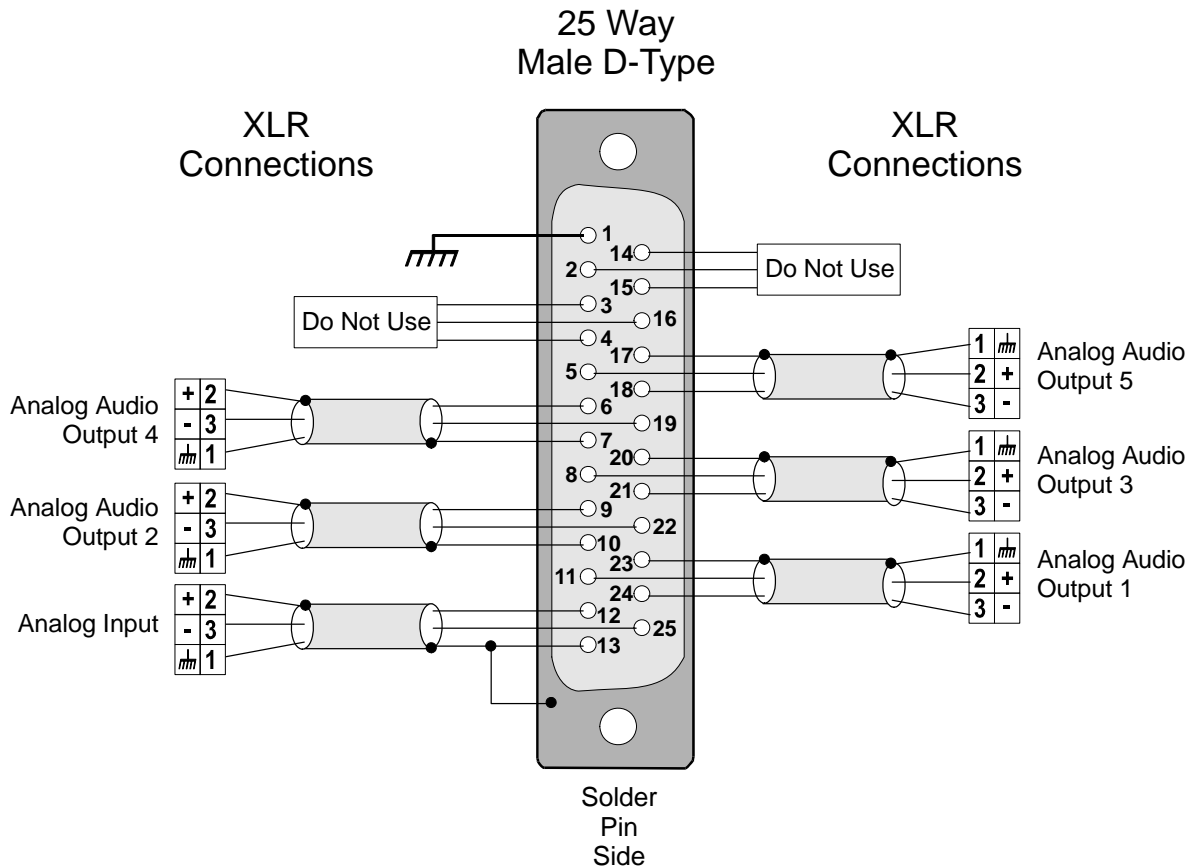
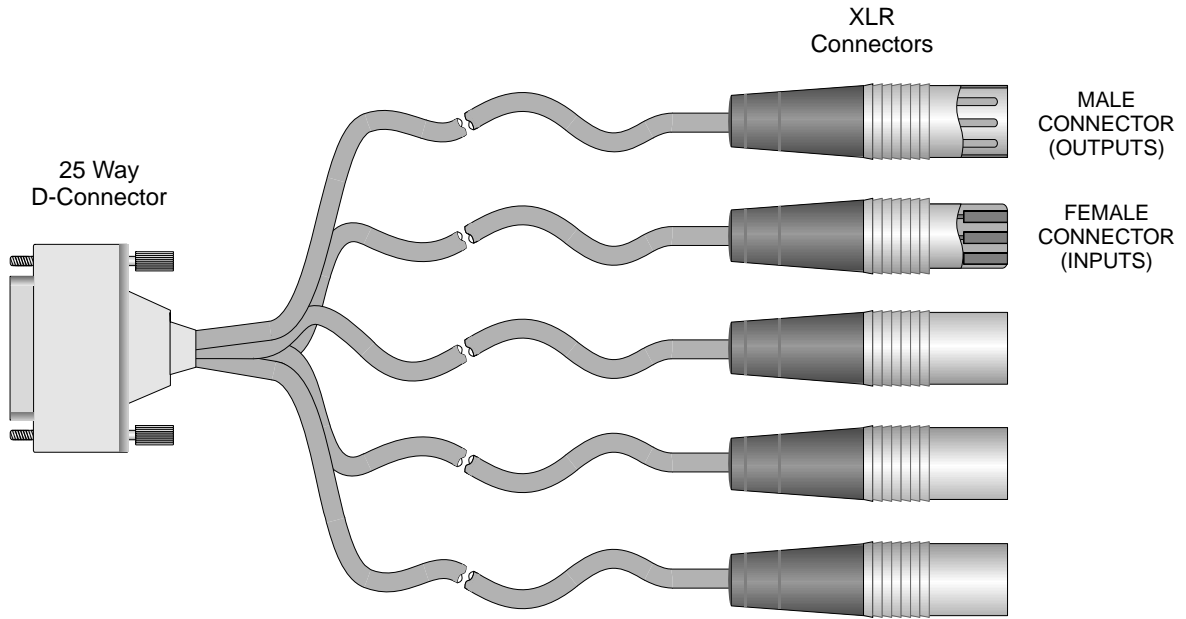

CARD EDGE INDICATORS

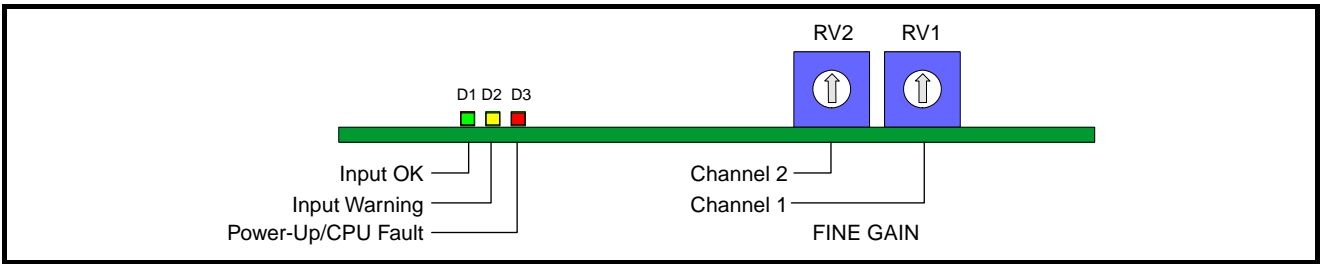

Adjustment of the settings of the IQADA00 is available either via card edge controls and/or via a more comprehensive remote control system using RollCall™

The adjustments are located on the front edge of the card.

D1 Input OK (Green)

This LED will illuminate if either input or the primary input (when in single channel mode) is present.

D2 Input Warning (Yellow)

This LED will illuminate if either input or the primary input (when in single channel mode) is missing.

D3 Power-up or CPU fault (Red)

This LED will illuminate during power-up or indicate a CPU fault.

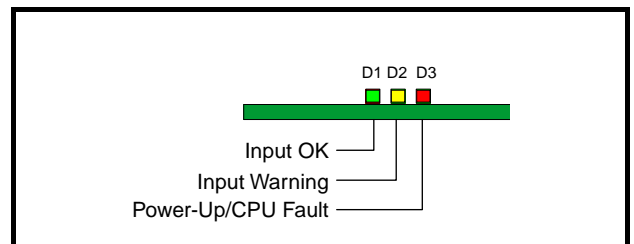

RV1 and RV2

These controls allow the fine adjustment of gain for channel 1 and channel 2 when dual channel mode.

When in single channel mode RV1 controls the gain.

The range of control is ±0.5 dB and is in addition to the coarse gain control.

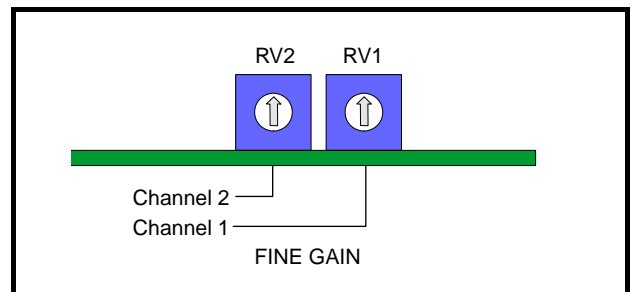

LK1 and LK2 Single/Dual Channel Select Links

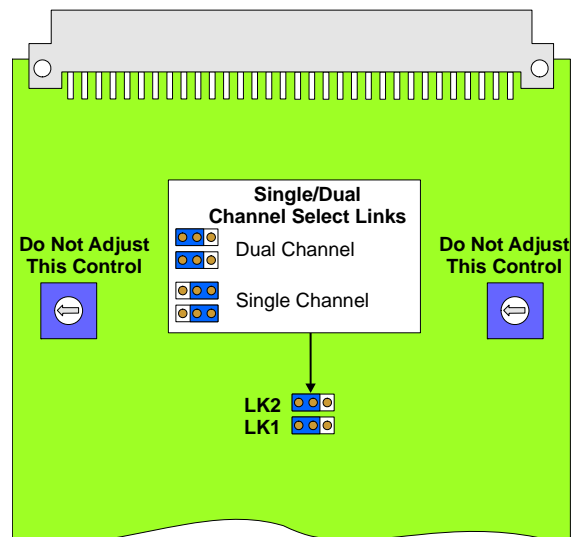

These links allow the unit to be configured as either a single channel or a dual channel amplifier.



RollCall PC Control Panel Screens

Setup

Note that for this and other screens the following applies to the scroll bars:

The  and  symbols at the ends of the scroll bar allow the value to be adjusted in discrete steps.

The numerical value will be shown above the scroll bars and selecting Preset  will return the setting to the calibrated value for that item.

Gain 1 and Gain 2

When configured as a dual input amplifier these controls allow the gain of the two input channels to be adjusted. The range is ± 24 dB in steps of 0.5 dB. Preset is to -0.0 dB.

Note that when configured as single input amplifier only the Gain 1 control will be available.

Silence Level

The level at which the signal is considered to have dropped to silence may be set with this control.

The range is from -25 dB to -15 dB in steps of 1 dB. Preset is to -20 dB.

Silence Detect Time

The Silence Level detect facility will only operate after a time interval set by this control. A valid signal is reported immediately.

The range is from 1 to 60 seconds. Preset is to 10 seconds.



Selecting this item sets all adjustment functions that include a preset facility, to their preset values.

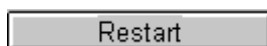

This will reboot the unit simulating a power-down power-up cycle restoring power-up settings.

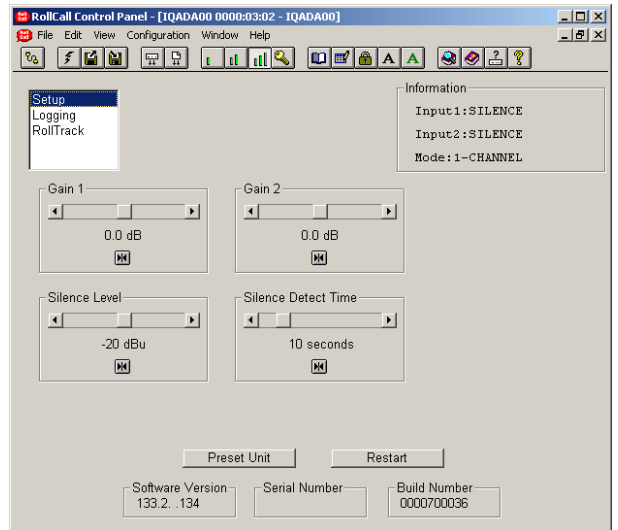

Software version

This item shows the version of the software fitted in the module.

Serial Number

This item shows the serial number of the module

Build Number

This will indicate the factory build number. This number defines all parameters of the unit (software versions, build level etc.) for identification purposes

Information Window

This will display basic information about the status of the unit.

Input 1: and Input 2:

This will show the status of the input. It can show:

- SILENCE** The input signal has been lost
- OK** The module is receiving a valid input signal
- Mode:** Shows whether the unit is in single channel (1-CHANNEL) or two channel (2-CHANNEL) mode

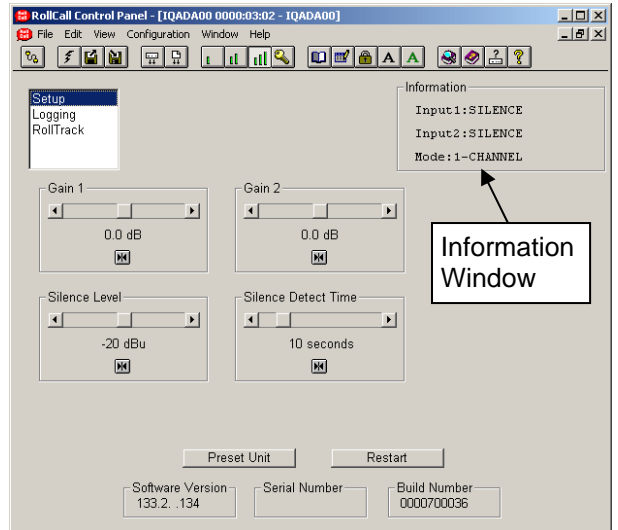

Single Channel Mode

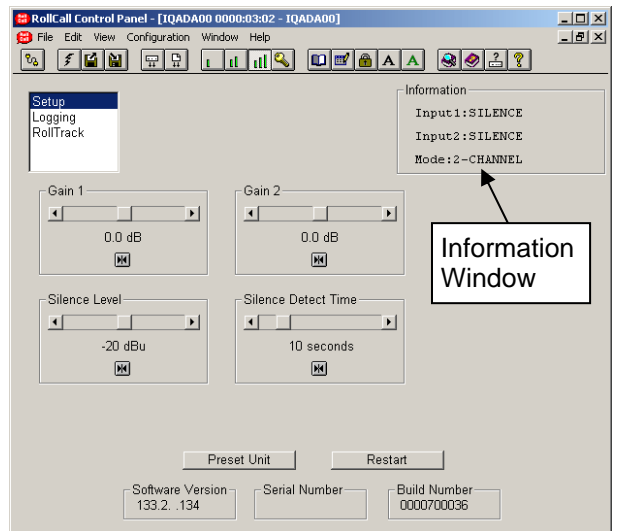

Two Channel Mode

Logging

Information about various parameters can be made available to a logging device that is attached to the RollCall™ network by checking the appropriate box.

The status is shown to the right of the item.

Any of the items may be selected from the list.

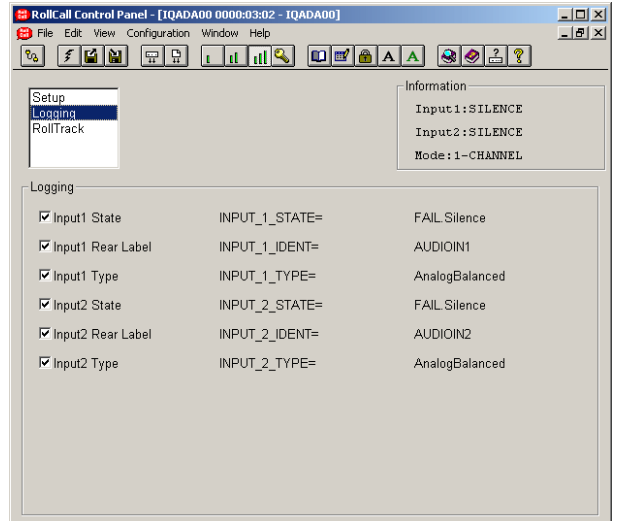

ROLLCALL LOG FIELDS

(Where Applicable)

Log Field	Log Value	Description
INPUT_1_STATE	OK WARN: Silence	Status of the input signal
INPUT_1_IDENT=	Audio In1	Input rear label
INPUT_1_TYPE=	Analog Balanced	Type of signal the module processes
INPUT_2_STATE	OK WARN: Silence	Status of the input signal
INPUT_2_IDENT=	Audio In2	Input rear label
INPUT_2_TYPE=	Analog Balanced	Type of signal the module processes

RollTrack

This function allows information to be sent, via the RollCall™ network, to other compatible units connected on the same network. For example, it can enable compatible audio delay units to produce an audio delay dependent on this and other similar units. The audio delay unit will dynamically follow or track the received delay-time information. This allows processed video signals to be timed correctly with audio signals. This automatic tracking system via the RollCall™ network is call **RollTrack**.

For more detailed information, see the RollTrack section (Appendix) at the end of this manual.

RollTrack Index

This item allows up to 16 destinations to be selected.

RollTrack Source

This allows the source of information that triggers the transmission of data to be selected.

Where applicable options are:

Unused (off)
Input 1 Present
Input 1 Silent
Input 2 Present
Input 2 Silent

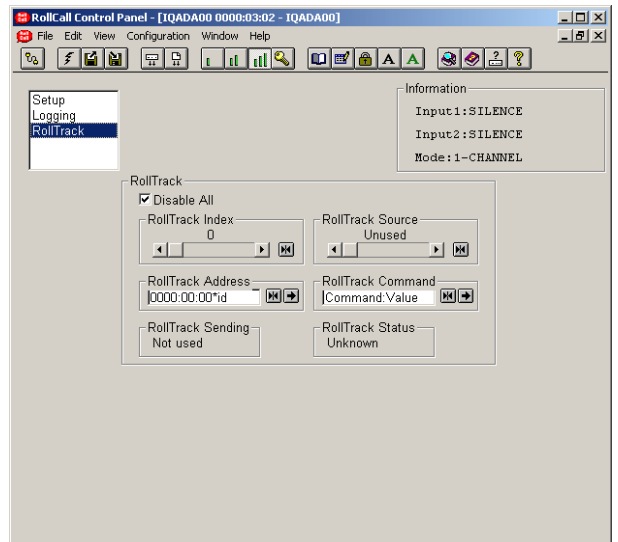

The destination for the information is set by the network code address as follows:

Network Address

This item allows the address of the selected destination unit to be set.

To change the address, type the new destination in the text area and then select  (return).

 (Preset) returns to the default destination

The full **RollTrack** address has four sets of numbers

For example: 0000:10:01*99

The first set (0000) is the network segment code number

The second set (10) is the number identifying the (enclosure/mainframe) unit.

The third set (01) is the slot number in the unit

The Fourth Set (99)

Each RollCall unit has a unique identification embedded in the units' software. In this example 99 represents an IQBAXR, 142 would represent an IQDAMDD, 255 a TBS100D etc. Inserting this number in the RollTrack address ensures that only the correct type of unit (in this example an IQBAXR) will respond to the RollTrack command; any other unit will ignore the command.

If this number was set to 00 **any type** of unit at this location would respond to the RollTrack command, possibly causing unpredictable results.

RollTrack (continued)

RollTrack Command

The full **RollTrack** command has two sets of numbers

For example: 84*156

The first set (84) is the **RollTrack** command number

The second set (156) is the value sent with the **RollTrack** command number

Disable All

When this item is checked all RollTrack items will be disabled.

RollTrack Sending

This item shows when the unit is actively sending the RollTrack command.

This may show:

- Not Used RollTrack destination not in use
- String A string value is always being sent.
- Number A number value is always being sent.
- No The message is not being sent.
- Yes The message is being sent.
- Internal Inconsistent behavior; please contact your local Snell & Wilcox agent
- Type Error

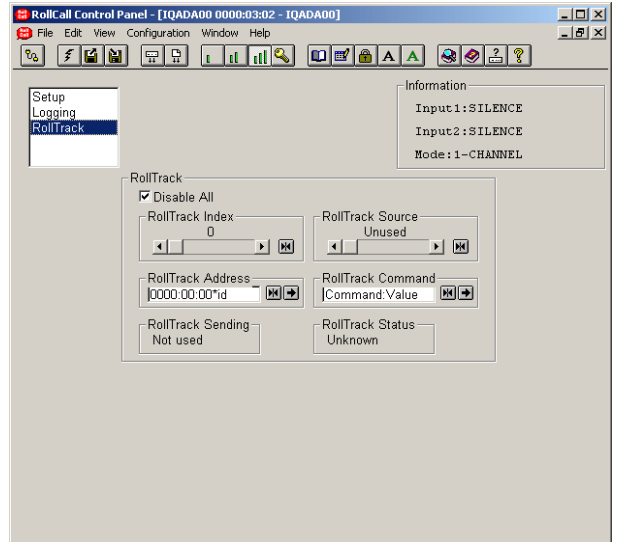

RollTrack Status

This item will show the status of the currently selected RollTrack index.

This may show:

- OK RollTrack message sent and received OK.
- Unknown Rolltrack message has been sent but it has not yet completed.
- Timeout RollTrack message sent but acknowledgement not received. This could be because the destination unit is not at the location specified.
- Error This indicates a broken RollCall state.
- Bad This indicates a broken RollCall packet.

Operation from an Active Control Panel

The card may be operated from an active control panel via the RollCall™ network.

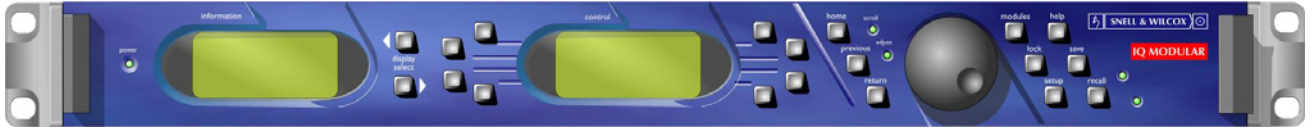

All operational parameters and selections are made using a system of menus displayed in two LCD windows.

Operational details for the remote control panel can be found in the Modular System Operator's Manual.

Information Window

The Information window has four lines of text indicating the current state of the unit.

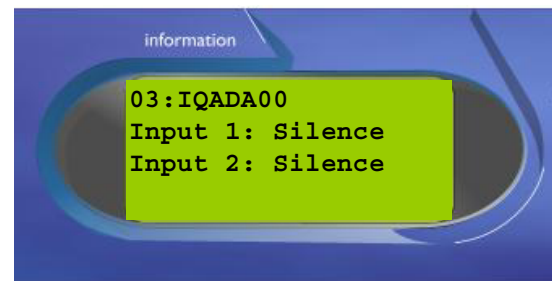

Control Window

The **Control** window displays all Selection Menus and sub-menus.

The selection is made by pressing the button adjacent to the required item.

The menu structure is detailed in the following pages.

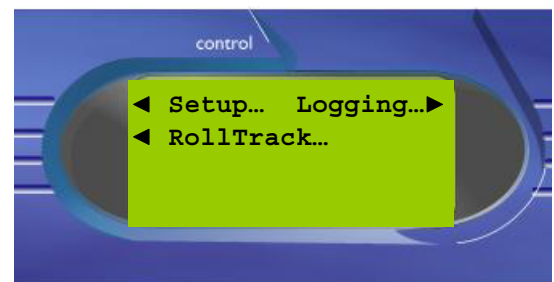

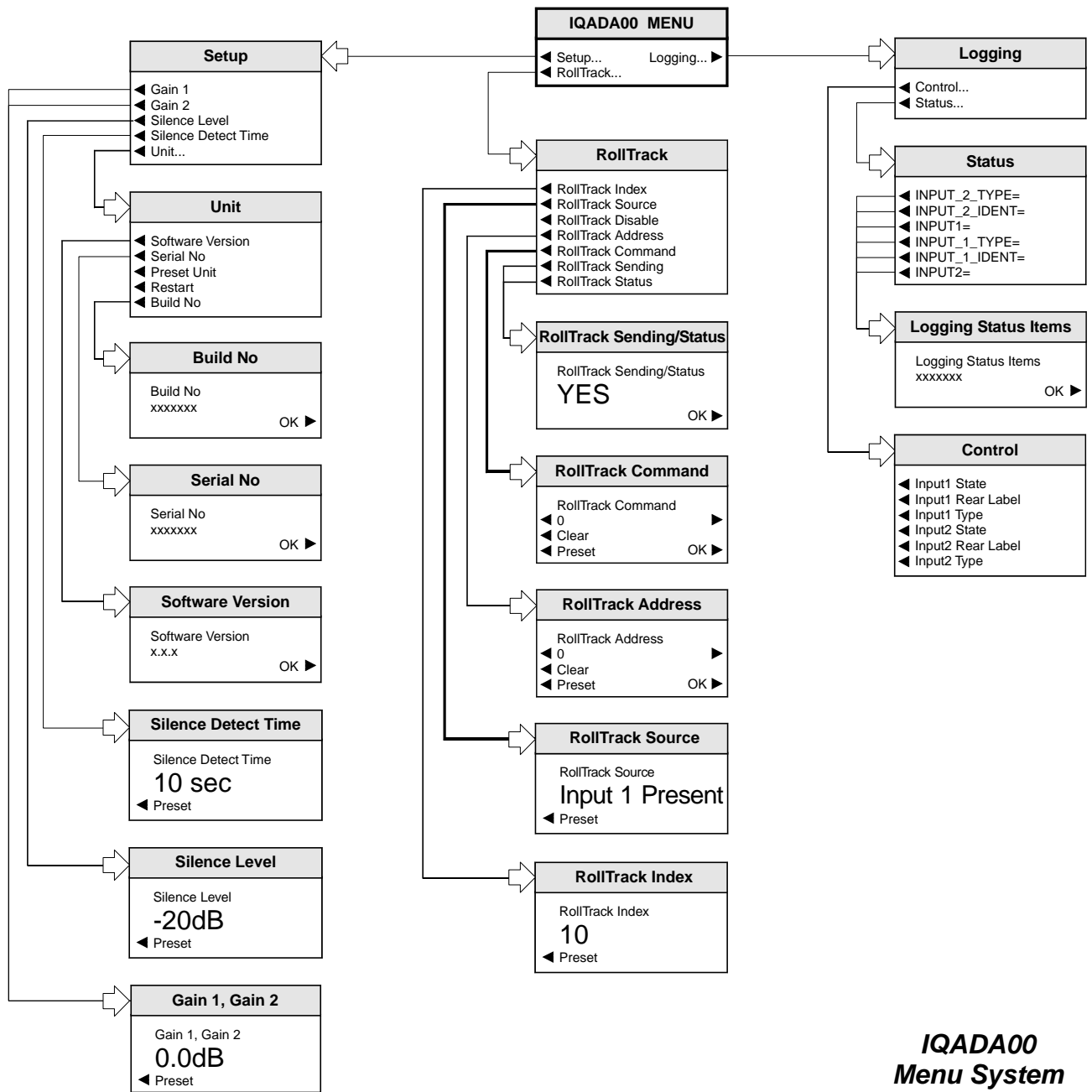

***IQADA00
Menu System***

MENU DETAILS

(see IQADA00 Menu System on previous pages)

MAIN MENU

The main or top level menu allows various sub-menus to be selected by pressing the button adjacent to the required text line.

Note that where a menu item is followed by three dots (...) this indicates that a further sub-menu may be selected.

Whenever a menu item is selected the parameters of that selection will be displayed in the Information window of the front panel. Where the selection is purely a mode selection and does not enable a sub-menu, the text will become reversed (white-on-black) indicating that the mode is active. If the mode is not available for selection the text will remain normal.

Also refer to the block diagram on page 4 for more information.

MAIN MENU

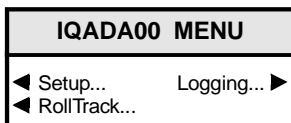

Setup...

This allows various functions to be setup.

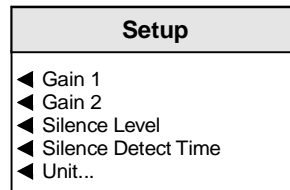

Gain 1 and Gain 2

When configured as a dual input amplifier these controls allow the gain of the two input channels to be adjusted.

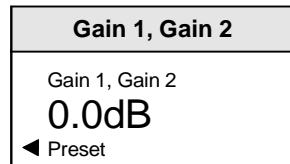

The range is ± 24 dB in steps of 0.5 dB. Preset is to 0.0 dB.

Note that when configured as single input amplifier only the Gain 1 control will be available.

Silence Level

The level at which the signal is considered to have dropped to silence may be set with this control.

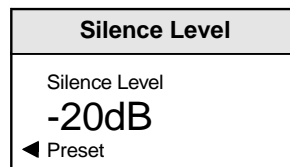

The range is from -25 dB to -15 dB in steps of 1 dB. Preset is to -20 dB.

Silence Detect Time

The Silence Level detect facility will only operate after a time interval set by this control. A valid signal is reported immediately.

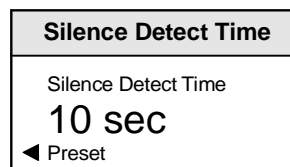

The range is from 1 to 60 seconds. Preset is to 10 seconds.

Unit

This provides information about the unit and some basic functions.

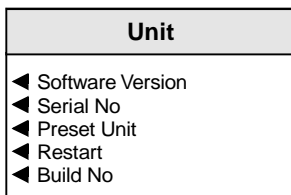

Software Version

This item reveals a display showing the version of the software fitted in the module.

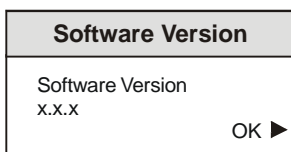

Select OK to return to the Unit Menu.

Serial No

This item reveals a display showing the serial number of the module.

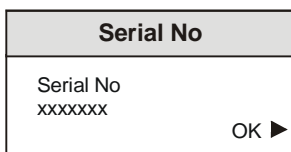

Select OK to return to the Unit Menu.

Preset Unit

Selecting this item sets all adjustment functions that include a preset facility, to their preset values.

Note that this is a momentary action.

Restart

This will reboot the unit simulating a power-down power-up cycle restoring power-up settings.

Build No

This will indicate the factory build number. This number defines all parameters of the unit (software versions, build level etc.) for identification purposes.

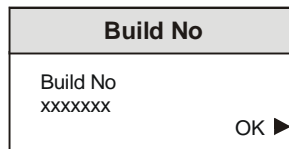

Select OK to return to the Unit Menu.

Information Window

This will display basic information about the status of the unit.

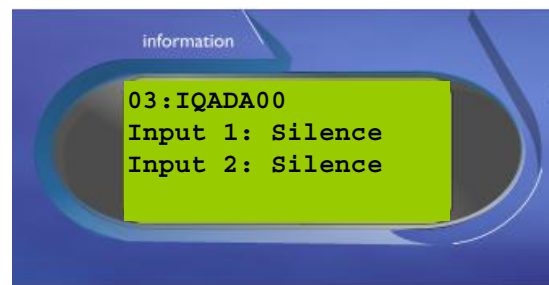

Input 1: and Input 2:

This will show the status of the input. It can show:

- Silence** The input signal has been lost
- OK** The module is receiving a valid input signal

Logging

Information about various parameters can be made available to a logging device that is attached to the RollCall™ network by selecting the appropriate item from the Control menu.

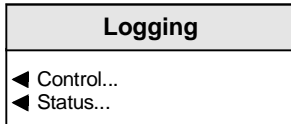

Control

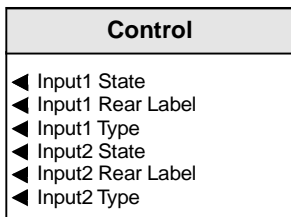

Logging Status

By selecting an item in this menu the status of the item will be shown in the display window.

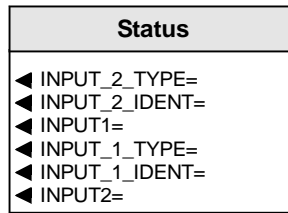

Display Window

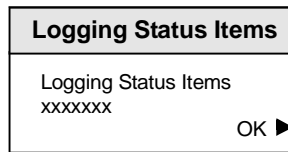

ROLLCALL LOG FIELDS

(Where Applicable)

Log Field	Log Value	Description
INPUT_1_STATE	OK WARN: Silence	Status of the input signal
INPUT_1_IDENT=	Audio In1	Input rear label
INPUT_1_TYPE=	Analog Balanced	Type of signal the module processes
INPUT_2_STATE	OK WARN: Silence	Status of the input signal
INPUT_2_IDENT=	Audio In2	Input rear label
INPUT_2_TYPE=	Analog Balanced	Type of signal the module processes

RollTrack

This function allows information to be sent, via the RollCall™ network, to other compatible units connected on the same network. For example, it can enable compatible audio delay units to produce an audio delay dependent on this and other similar units. The audio delay unit will dynamically follow or track the received delay-time information. This allows processed video signals to be timed correctly with audio signals. This automatic tracking system via the RollCall™ network is call **RollTrack**.

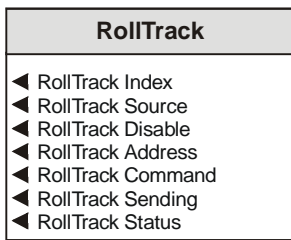

For more detailed information, see the RollTrack section (Appendix) at the end of this manual.

RollTrack Index

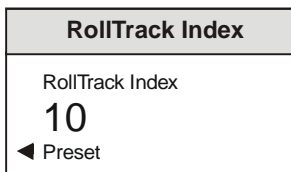

This item is used to select which RollTrack Index is set up using the RollTrack Source, RollTrack Address and RollTrack Command functions. RollTrack Source

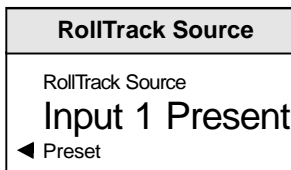

This allows the source of information that triggers the transmission of data to be selected.

Where applicable options are:

Unused (off)
Input 1 Present
Input 1 Silent
Input 2 Present
Input 2 Silent

The destination for the information is set by the network code address.

RollTrack Disable

When this item is selected all RollTrack items will be disabled.

RollTrack Address

This item allows the address of the selected destination unit to be set.

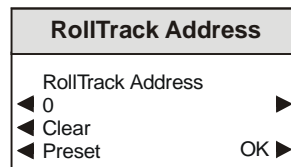

To compile/edit the text the right ► and left ◀ buttons adjacent to the upper text line in the menu should be used to select the character position in the text and the spinwheel used to select the character.

The **Clear** function blanks the selected character.

The **Preset** function loads the default address.

O.K. ► saves the address and returns to the main menu.

The full **RollTrack** address has four sets of numbers

For example: 0000:10:01*99

- The first set (0000) is the network segment code number
- The second set (10) is the number identifying the (enclosure/mainframe) unit.
- The third set (01) is the slot number in the unit
- The Fourth Set (99)

Each RollCall unit has a unique identification embedded in the units' software. In this example 362 represents an IQDMX00, 412 would represent an IQDEC00, 161 a Mach 1 etc. Inserting this number in the RollTrack address ensures that only the correct type of unit (in this example an IQDMX00) will respond to the RollTrack command; any other unit will ignore the command.

If this number were set to 00 **any type** of unit at this location would respond to the RollTrack command, possibly causing unpredictable results.

The unit ID of a module on the RollCall network may be found under *RollCall Control Panel/RollCall Listing/Unit Information* or via the *RollCall Control Panel Help/About Current Unit* function.

RollTrack Command

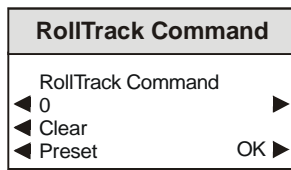

The full **RollTrack** command has two sets of numbers

For example: 84*156

The first set (84) is the **RollTrack** command number

The second set (156) is the value sent with the **RollTrack** command number.

RollTrack Sending

This item shows when the unit is actively sending the RollTrack command.

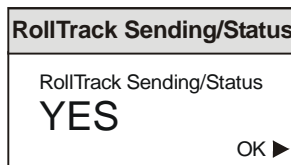

This may show:

- | | |
|---------------------|--|
| String | A string value is always being sent. |
| Number | A number value is always being sent. |
| No | The message is not being sent. |
| Yes | The message is being sent. |
| Internal Type Error | Inconsistent behavior; please contact your local Snell & Wilcox agent. |

RollTrack Status

This item will show the status of the currently selected RollTrack index.

This may show:

- | | |
|---------|---|
| OK | RollTrack message sent and received OK. |
| Unknown | Rolltrack message has been sent but it has not yet completed. |
| Timeout | RollTrack message sent but acknowledgement not received. This could be because the destination unit is not at the location specified. |
| Error | This indicates a broken RollCall state. |
| Bad | This indicates a broken RollCall packet. |

