



Aspect Ratio Converter with Signaling

Table of Contents

Module Description	2	WSS/VI Input	27
Rear Panel Views	2	WSS/VI Output	28
Block Diagram.....	4	WSS/VI Mapping ETSI	29
Features.....	4	WSS/VI Mapping AFD	30
Technical Profile.....	5	WSS/VI Mapping SMPTE.....	30
Input Connections	7	Logging 1 and 2.....	31
Serial Digital Video Input	7	Setup	32
Bypass.....	7	Status	33
Output Connections	7	Help SDI Input	34
Serial Mon Out	7	Help Aspect Ratios	34
Serial Digital Video Output	7	Help Signaling	34
Modules fitted with the Bypass Facility	7	Operation from an Active Control Panel	35
GPI	8	Main Menu.....	37
25 way Pin Connections by name.....	8	ARC... ..	37
GPI Timing	9	Video	40
Card Edge Controls.....	10	Mode.....	41
RollCall Control Templates for the IQARC00..	14	Blanking.....	41
ARC	14	Bypass.....	41
Minimum Delay.....	18	Freeze	41
Border Colour	20	User Mem	42
Blanking.....	20	Setup	43
Video	21	APPENDIX 1 – Video Index and Enhanced Line	23
Pattern & Caption	22	23	58
General Purpose Interface	23	Background Information on Video Index	58
RollTrack	24	Manual Revision Record.....	60
Memories.....	26		

Module Description

The IQARC00 is a broadcast quality 10-bit bi-directional aspect ratio converter with serial digital input and outputs, plus additional serial digital monitoring outputs. A comprehensive selection of fixed up and down conversion modes are available

with ultra smooth adjustment of picture position both horizontally and vertically. In addition to the preset values, horizontal zoom and active picture size can be smoothly adjusted over a 2:1 to 1:2 range.

Rear Panel Views

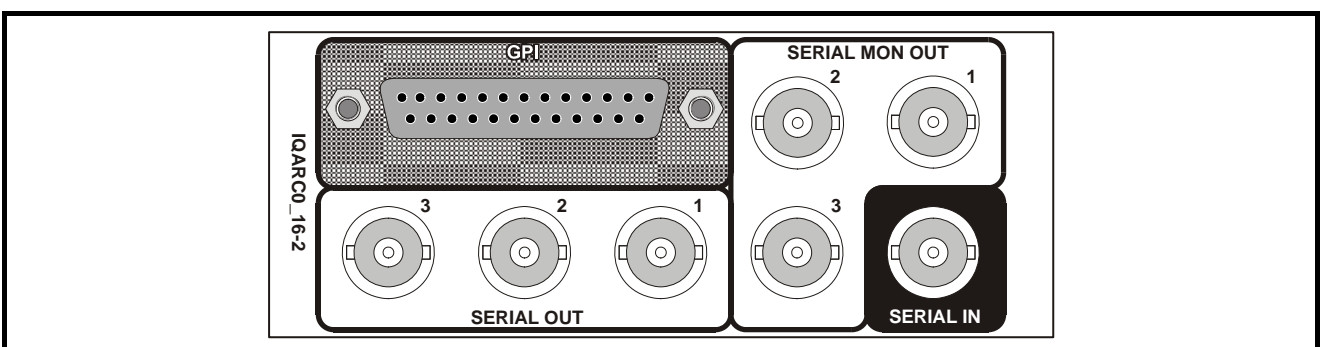
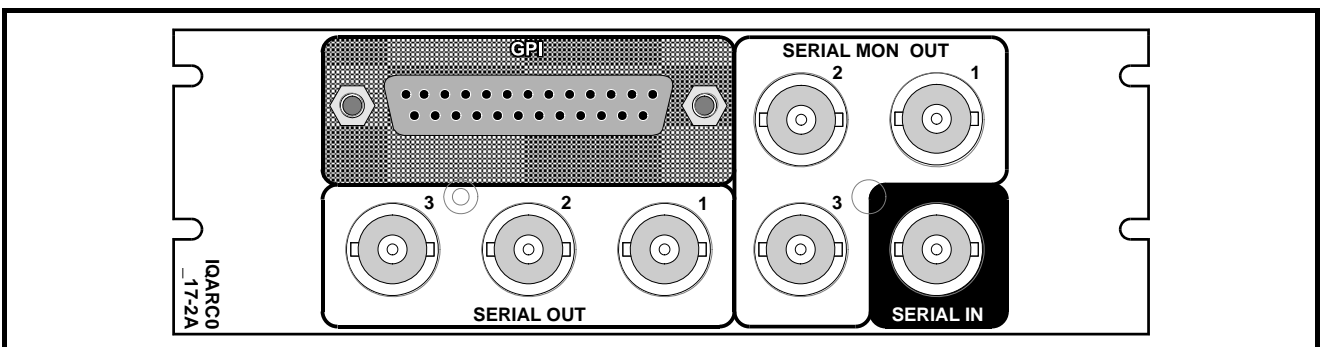
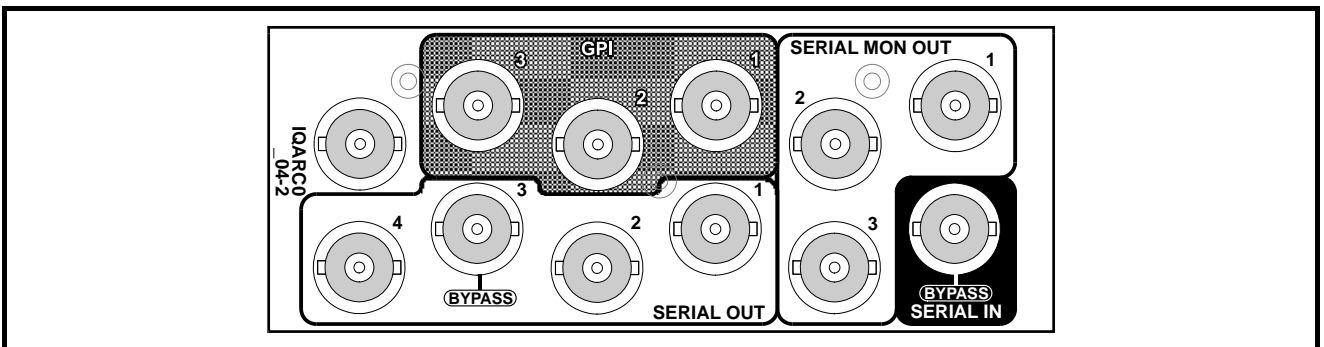
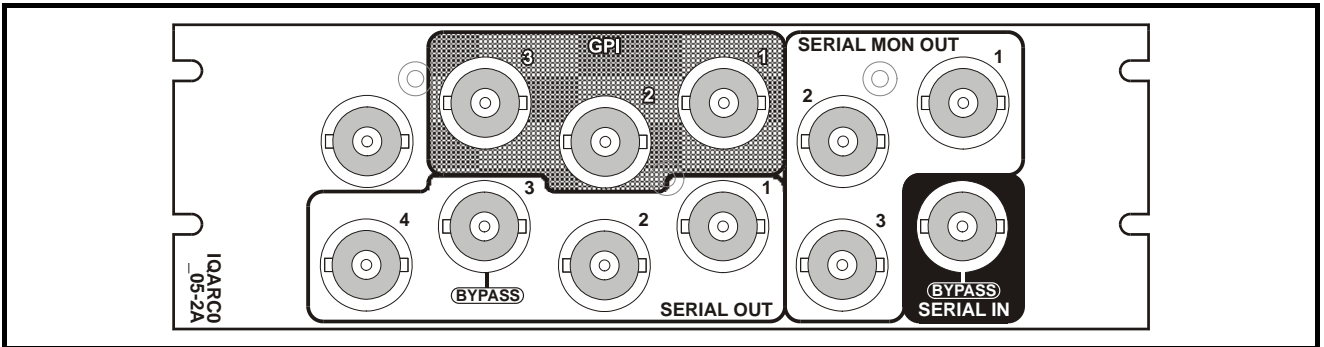

Versions of the module cards available are:

IQARC0004-2 SDI Aspect Ratio Converter with Signalling. 4 SDI outputs with relay input bypass/ 3 SDI monitoring outputs.

IQARC0005-2A SDI Aspect Ratio Converter with Signalling. 4 SDI outputs with relay input bypass/ 3 SDI monitoring outputs.

IQARC0016-2 SDI Aspect Ratio Converter with Signalling. 3 SDI main/ 3 SDI monitoring outputs.

IQARC0017-2A SDI Aspect Ratio Converter with Signalling. 3 SDI main/ 3 SDI monitoring outputs.

Note that there are two styles of rear panels available. They are not interchangeable between the two styles of enclosures. However, the cards may be fitted into any style of enclosure.

‘A’ Style Enclosure

Rear panels **with** the suffix A may only be fitted into the ‘A’ style enclosure shown below.

(Enclosure order codes IQH3A-S-0, IQH3A-S-P)



(Enclosure order codes IQH3A-E-0, IQH3A-E-P, IQH3A-0-0, IQH3A-0-P)

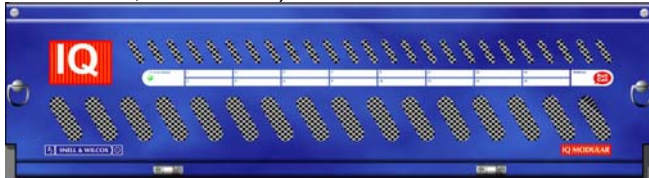

(Enclosure order code IQH1A-S-P)



‘O’ Style Enclosures

Rear panels **without** the suffix A may only be fitted into the ‘O’ style enclosures shown below.

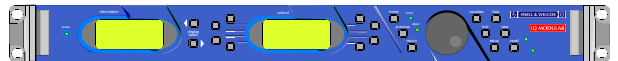

(Enclosure order codes IQH1S-RC-0, IQH1S-RC-AP, IQH1U-RC-0, IQH1U-RC-AP, Kudos Plus Products)

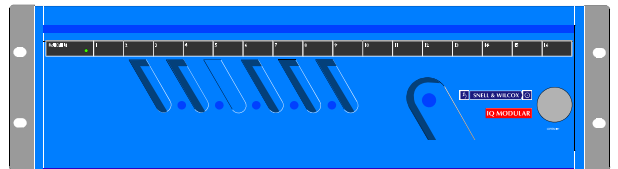

(Enclosure order codes IQH3N-0, IQH3N-P)



(Enclosure order codes IQH3U-RC-0, IQH3U-RC-P)

Block Diagram

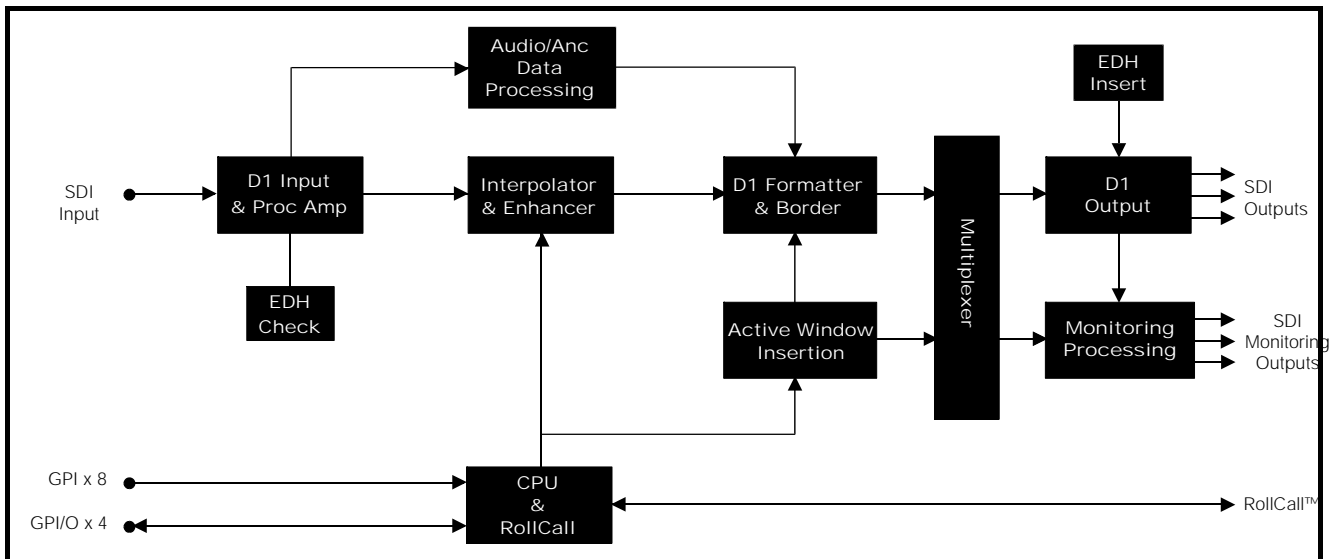

Features

- Aspect ratio conversion using vertical-temporal filtering
- 9 fixed up and down conversion modes
- Bi-directional ultra smooth variable aspect ratio between 2:1 and 1:2
- Ultra smooth dynamic pan & tilt
- Input and output blanking controls
- Line 23 WSS and Video Index signalling (reading and writing)
- On screen display of line 23 WSS, Video Index information and unit status
- SDI monitoring outputs
- Fixed 1 frame or minimum delay modes, for easy installation
- Transparent to horizontal and vertical interval data
- Background colour control
- Auto field freeze on input loss
- Y and C gain controls
- Y black adjustment
- Y and C clippers for minimum and maximum values
- Pattern generation
- Caption insertion
- 8 GPI inputs and 4 input/outputs for rapid control
- 16 user definable memories
- Un-interruptable valid output
- RollTrack audio delay tracking
- Automatic 625 & 525 operation
- EDH checking and insertion to SMPTE RP165
- RollCall remote control and monitoring

Technical Profile

Signal Inputs

Serial Digital 1 x SDI
 Standards SMPTE 259M-C-1997 and
 embedded audio SMPTE 272M-A-
 1994

Control Interface

GPI 8 Closing Contact style
 4 Closing Contact Inputs/Outputs
 via 25 way D connector

Card Edge Controls (also available via RollCall)

Conversion Mode Select Terms

AA Active image aspect
 ratio with reference to 9
 (4:3 is 12:9 = 12)
 B Display Format
 P for pillar-box
 L for letter-box
 F for full-frame
 CC Raster aspect ratio with
 reference to 9
 (4:3 is 12:9 = 12)

Conversion Mode Select

Input → Output	Comment (output)
12F12 → 12P16	16:9 pillar-box
12F12 → 14P16	16:9 pillar-box vertically cropped
12F12 → 16F16	Full 16:9 picture
16L12 → 12F12	Side cropped
16L12 → 14L12	Side cropped 14:9 letterbox
16L12 → 16F16	Full 16:9 picture
16F16 → 12F12	Side cropped
16F16 → 14L12	Side cropped 14:9 letterbox
16F16 → 16L12	16:9 letter box

Aspect ratio Smooth adjustment between 2:1
 and 1:2
 Size Smooth adjustment between 2:1
 and 1:2
 Pan control Smooth adjustment across input
 active picture
 Tilt control Smooth adjustment across input
 active picture

Signal Outputs

Serial Digital 3 x SDI
 Serial Digital 3 x SDI Monitoring
 Standards SMPTE 259M-C-1997 and
 embedded audio SMPTE 272M-A-
 1994

Input blanking Smooth adjustment of top, bottom,
 left and right
 Output blanking Smooth adjustment of top, bottom,
 left and right
 L23 and Video Index Comprehensive control of Video
 Index & Line 23 including
 Automatic read, Automatic or
 Manual write, or removal
 Y Gain Adjust ± 6 dB in 0.1 dB steps
 C Gain Adjust ± 6 dB in 0.1 dB steps
 Black Level Adjust ± 100 mV in 0.8mV steps
 Y Min/Max Clipper value - 50 mV to + 50 mV and 635 mV to
 765 mV in 0.8 mV steps
 C Min/Max Clipper value + 200 mV to + 400 mV in 0.8 mV
 steps
 Line 23, Video Index and unit status on screen display
 Insert on Monitoring outputs
 (On/Off)
 Auto Freeze Freeze on Input Loss (Default is
 Pattern Output) (On/Off)
 Mode Manual / Automatic response to
 incoming video index or wide
 screen signalling / Minimum Delay
 Border control Black, Blue, Red, Green, White,
 Grey or 2 user Defined R, G, B
 Caption Edit, On/Off, 1 or 10 line and where
 inserted (processed or
 unprocessed path)
 Pattern Select Off, Black, EBU Bars, 100% Bars,
 Multiburst, Valid Ramp, Pulse and
 Bar, Green
 Monitoring Output Output Input and monitoring
 information / Aspect ratio converted
 output
 Ratio Terminology WRT-9, PB/LB, Ratio
 User Memories 16 recall locations
 Standard 525 / 625 / Auto
 Preset Unit Returns all settings to factory
 defaults

Functions available via RollCall only

Technical Profile (continued)

LoggingEDH, Input Loss, Input Standard,
Input and Output Video Index
Signalling, Input and Output Wide
Screen Signalling, Video Index and
Wide Screen Signalling AFD
conflict, Unit mode

User Memories.....16 save / recall

RollTrack™Video Delay, Input Present, Input
Missing, Input Standard, Input and
Output Video Index Signalling,
Input and Output Wide Screen
Signalling, Video Index and Wide
Screen Signalling AFD conflict

GPI configuration Select the function of each GPI input and
output from a predefined list of options

Specifications

Serial Input Return LossBetter than 15 dB to 270 MHz

Maximum Input Cable length
>200 m (PSF1/2 or equiv. cable)

Serial Output Level800 mV \pm 10%

Output Overshoot.....<700 mV

Output Jitter.....< 0.2 UI

DelayNormal: 1Frame plus approx. 2 μ S
or Min Delay: approx. 37 μ S

Power Consumption

Module Power Consumption 13.5 W max

Input Connections

Serial Digital Video Input

The serial digital input to the unit is made via this BNC connector which terminates in 75 Ohms.

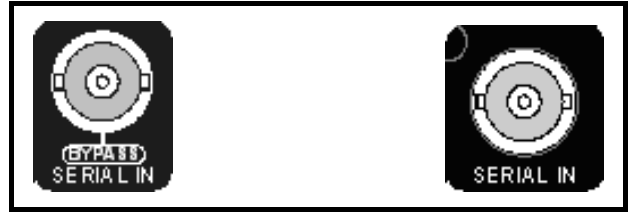

Bypass

If the card is not operating (e.g. not powered) or is not fitted in the enclosure the input signal will be connected to output 3 via a relay contact. Note that if the card is un-powered or withdrawn from the enclosure while processing a signal the output signal will suffer a short disturbance.

Output Connections

Serial Mon Out

Three isolated monitoring outputs are available from these BNC connectors.

Note that these outputs may be used as additional main outputs. They may be configured as processed or unprocessed outputs.

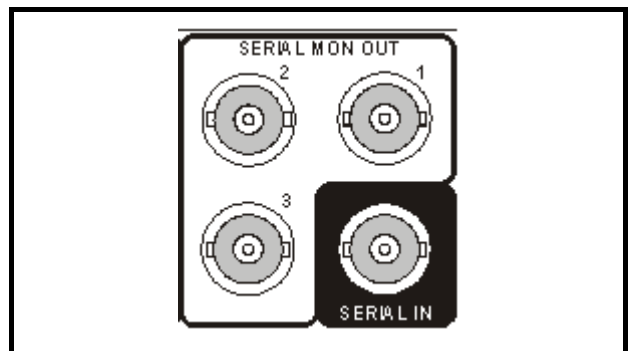
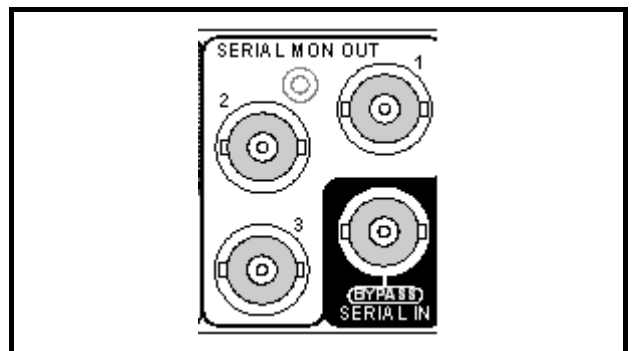

Serial Digital Video Output

These are the four/three isolated Serial Digital outputs of the unit via BNC connectors for 75 Ohms.

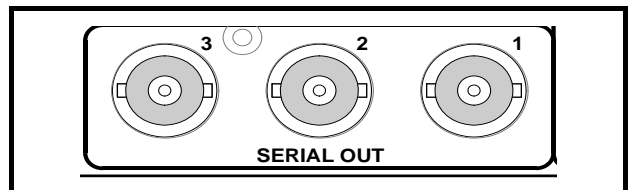

Modules fitted with the Bypass Facility

The bypass output connector (output 3) must be terminated in 75 Ohms at all times. If this output is not used a BNC 75 Ohm terminator should be fitted. If these precautions are not taken the input signal will become unterminated if the card is un-powered or withdrawn from the enclosure.

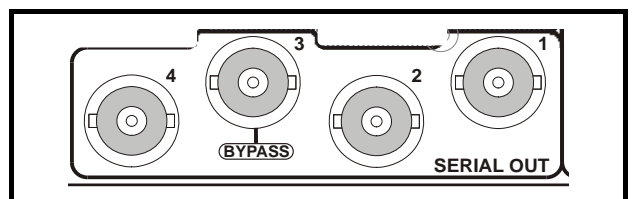

GPI

The General Purpose Interfaces (GPI's) are accessed via a 25 way D type female connector or the three BNC connectors. In the table GPI refers to inputs and GPO refers to outputs.

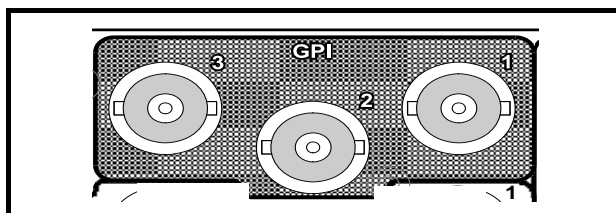
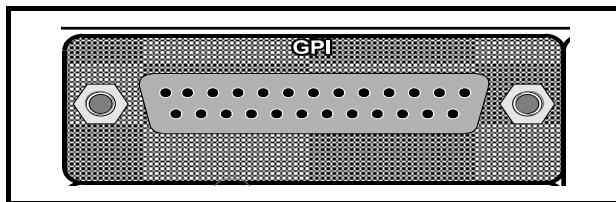

25 way Pin Connections by name

PIN	NAME	DESCRIPTION
1	GPI 1 RET	Return GPI 1
14	GPI 1	Signal GPI 1
16	GPI 2 RET	Return GPI 2
15	GPI 2	Signal GPI 2
4	GPI 3 RET	Return GPI 3
17	GPI 3	Signal GPI 3
19	GPI 4 RET	Return GPI 4
18	GPI 4	Signal GPI 4
8	GPI 5 RET	Return GPI 5
21	GPI 5	Signal GPI 5
9	GPI 6 RET	Return GPI 6
22	GPI 6	Signal GPI 6
24	GPI 7 RET	Return GPI 7
23	GPI 7	Signal GPI 7
25	GPI 8 RET	Return GPI 8
12	GPI 8	Signal GPI 8
2	GPI/O 1 RET	Return GPI/O 1 (BNC 1)
3	GPI/O 1	Signal GPI/O 1 (BNC 1)
6	GPI/O 2 RET	Return GPI/O 2 (BNC 2)
5	GPI/O 2	Signal GPI/O 2 (BNC 2)
11	GPI/O 3 RET	Return GPI/O 3 (BNC 3)
10	GPI/O 3	Signal GPI/O 3 (BNC 3)
7	GPI/O 4 RET	Return GPI/O 4
20	GPI/O 4	Signal GPI/O 4
13	Ground	GND

25 way Pin Connections by pin number

PIN	NAME	DESCRIPTION
1	GPI 1 RET	Return GPI 1
14	GPI 1	Signal GPI 1
2	GPI/O 1 RET	Return GPI/O 1 (BNC 1)
15	GPI 2	Signal GPI 2
3	GPI/O 1	Signal GPI/O 1 (BNC 1)
16	GPI 2 RET	Return GPI 2
4	GPI 3 RET	Return GPI 3
17	GPI 3	Signal GPI 3
5	GPI/O 2	Signal GPI/O 2 (BNC 2)
18	GPI 4	Signal GPI 4
6	GPI/O 2 RET	Return GPI/O 2 (BNC 2)
19	GPI 4 RET	Return GPI 4
7	GPI/O 4 RET	Return GPI/O 4
20	GPI/O 4	Signal GPI/O 4
8	GPI 5 RET	Return GPI 5
21	GPI 5	Signal GPI 5
9	GPI 6 RET	Return GPI 6
22	GPI 6	Signal GPI 6
10	GPI/O 3	Signal GPI/O 3 (BNC 3)
23	GPI 7	Signal GPI 7
11	GPI/O 3 RET	Return GPI/O 3 (BNC 3)
24	GPI 7 RET	Return GPI 7
12	GPI 8	Signal GPI 8
25	GPI 8 RET	Return GPI 8
13	Ground	GND

25 way Pin Connections

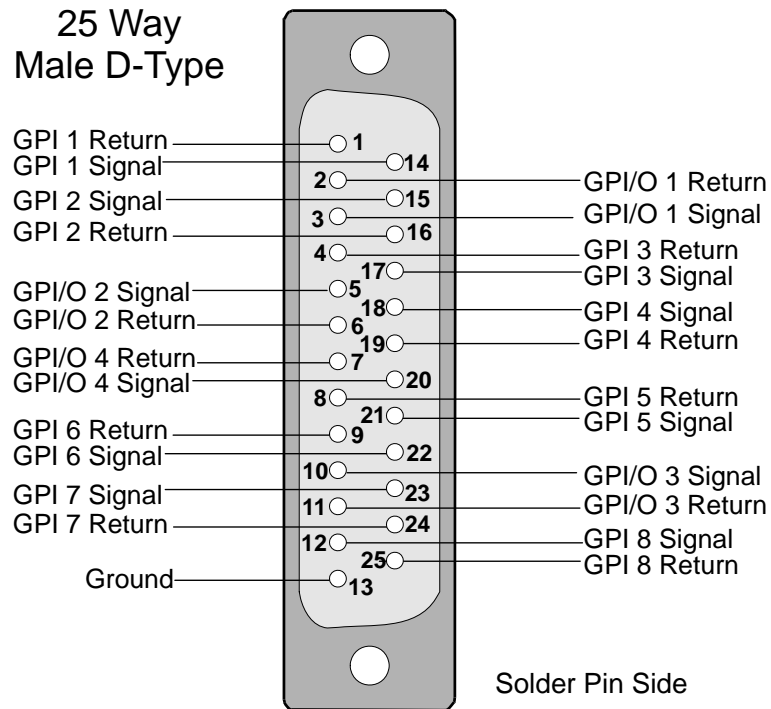

GPI Timing

The GPI inputs are sampled at frame rate, on a frame boundary (field2 to field1 transition), with a guard period of 4ms before and 2ms after the sampling point. The GPI input signal has to remain a steady state during the guard period to ensure a GPI is triggered and registered correctly. Any GPI changes of state during the guard period will produce an undetermined result. The function that is linked to respond to a GPI input will appear on the output after two frames of delay. The following diagram shows a GPI signal being accepted at the A2 / B1 frame boundary, which in turn causes the change in video output within the C2 / D1 frame.

NOTE: This timing applies to memory recalls. Caption and Freeze are handled on the next output Frame.

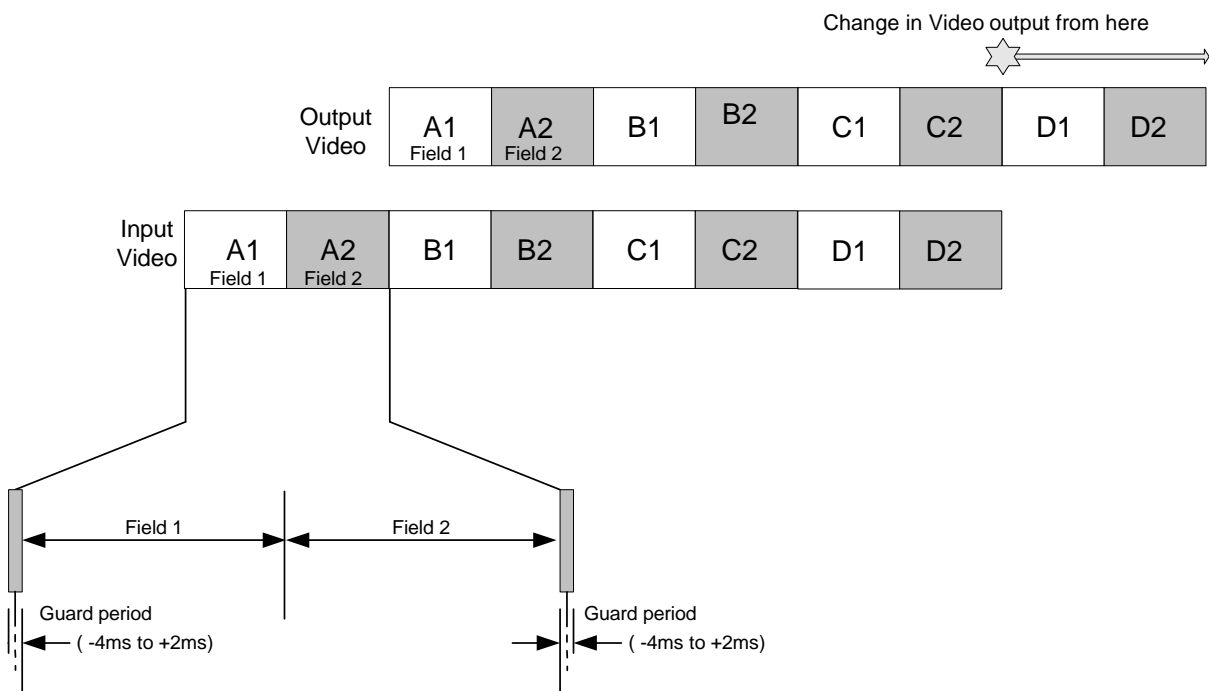

The guard period between repeated memory recalls using GPI inputs is 12 frames.

Card Edge Controls

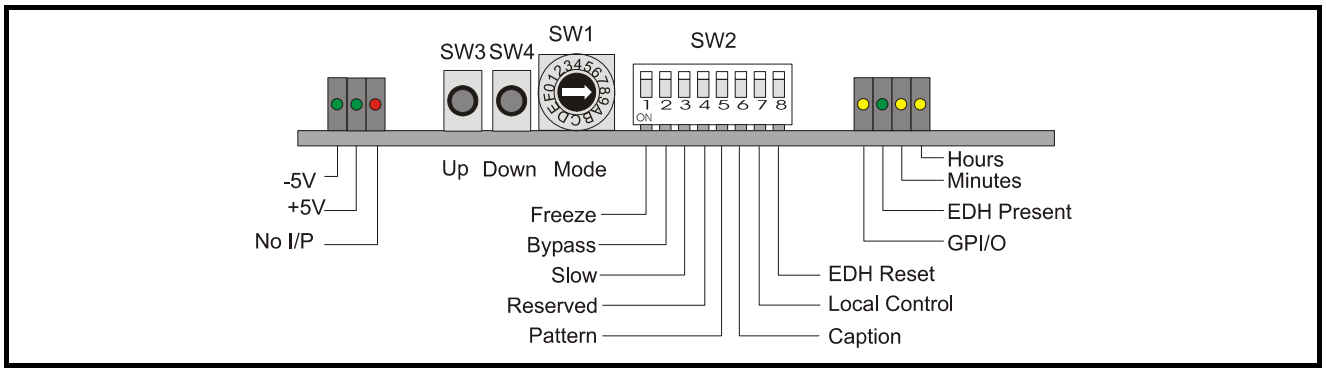

The unit will respond to both local and remote control, one system overriding the settings of the other. For cards using the RollCall™ remote control system, activating these switches will override the remote control settings. The RollCall™ control panel will then follow these settings.

LED Indicators

+5V and -5V

When illuminated these LED's indicate that the +5 V and -5 V supplies are present.

No I/P

The **No I/P** LED will be continuously illuminated when the unit is not receiving an input signal.

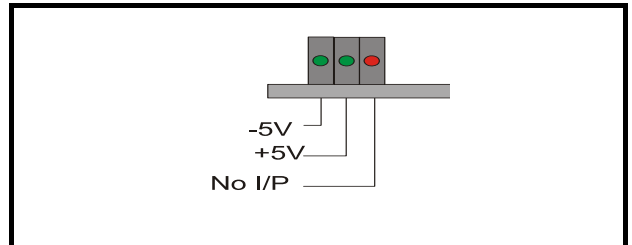

GPI/O

The function of this LED is reserved for future use.

EDH Reporting

The **EDH Present** LED will be illuminated if EDH data is present on the incoming signal.

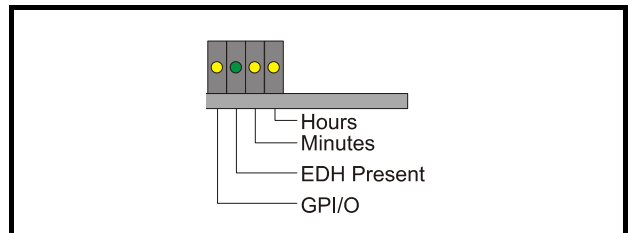

The **Hour** LED indicates that an error has occurred in the last hour and the **Minutes** LED indicates that an error has occurred in the last minute.

Note that SW2/8 resets these indicators.

Adjustment of the settings of the IQARC00 is available either via card edge controls and/or via a more comprehensive remote control system using RollCall™

Switches

Two push buttons, a Hex switch and an 8 way DIL switch allow various functions and modes to be set.

The DIL switch SW2 selects a particular function and the Hex switch SW1 selects a mode or variable parameter.

The push buttons SW3, SW4 allow the value of the selected function/parameter to be adjusted.

The Mode select switch may select a mode or a parameter that may be adjusted.

Note that to select the preset value both buttons should be pressed together.

Function and Mode Selections

DIL Switch Functions SW2

By setting these switches various modes of operation may be selected. (Down is ON and Up is OFF)

Position 1

This allows the freeze mode to be selected.

Position 2

Setting to ON selects the **Bypass** mode.

When enabled the input signal will pass through the electronics of the unit with everything at default settings.

Position 3

When the output picture size changes this function allows control over the way that the change of picture size occurs.

When selected the picture size will change smoothly to the new size when the IQARC00 is in manual mode.

Position 4 This position is reserved

Position 5

Setting this to ON, the selected Test Pattern is switched to the output.

Note that if the caption is ON the pattern will be black.

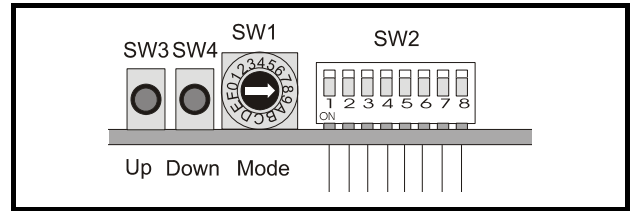

These switches allow the module to be operated when an active front panel is not available.

More detailed information about these functions will be found under *MENU DETAILS* starting on page 10.

The pattern selection is made using the hex switch SW1.

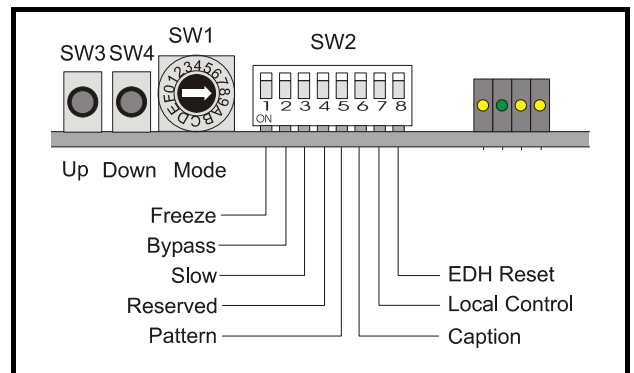

Position 6

Setting this to ON, the 10 line display is switched to the output.

Position 7

This position is reserved for future use.

Position 8

Setting this to ON, resets the EDH's Elapsed-Time count, as well as resetting the "Minute EDH" and "Hour EDH" LEDs.

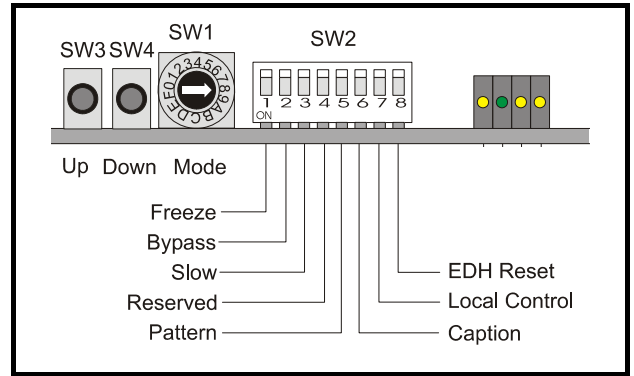

SW1

This HEX switch selects a parameter that may be adjusted with the push-buttons SW3 and SW4. *Note that SW4 decreases a setting and SW3 increases a setting. Continual pressure on the button will cause the setting to change continuously, the rate of change increasing with time. Pressing both together sets functions to their default values.*

Position 0 Aspect Ratio

This allows a fixed aspect ratio to be selected from the following list and in this order.

- Pass (Output the same as input aspect ratio)
- 12F12->12P16 4:3 > 16:9 PB
 - 12F12->14P16 4:3 > 14:9 PB
 - 12F12->16F16 4:3 > 16:9 FH
 - 16L12->12F12 16:9 LB > 4:3
 - 16L12->14L12 16:9 LB > 14:9 LB
 - 16F16->12F12 16:9 FH > 4:3
 - 16F16->14L12 16:9 FH > 14:9 LB
 - 16F16->16L12 16:9 FH > 4:3 LB

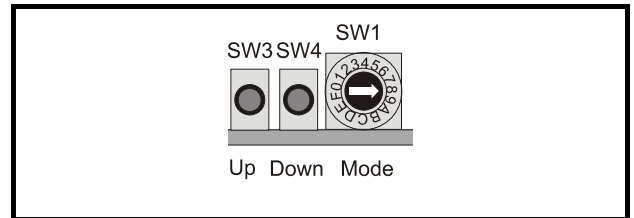

SW1 (cont)

Position 1 Pan

This selects the Pan function. This will adjust the horizontal position of the output image.

The range of adjustment is ± 3700 in steps of 1.

Position 2 Tilt

This selects the Tilt function. This will adjust the vertical position of the output image.

The range of adjustment is ± 3000 in steps of 1.

Position 3 Size

This selects the Size function. This will adjust the size of the whole image.

The range of adjustment is from 0.5 to 2.0 in steps of 0.001.

Position 4 Aspect

This selects the Aspect function. The output aspect ratio may be adjusted using this control.

The range of adjustment is from 0.5 to 2.0 in steps of 0.001.

Position 5 Output Routing

This selects the Output Routing function that allows what type of signal that appears at the three Monitoring outputs. Selections are either Processed path or Unprocessed path.

Position 6 Default Standard

This selects the Default Output function. If the input signal fails the main SDI outputs may be configured to become either Freeze (a frozen picture) or Black.

Positions 8 and 9 are not used.

Position A Pattern Select

When SW2/5 is selected the pattern that becomes the output can be chosen from this list.

Black
EBU Colour bars
100% Colour bars
Ramp
Multiburst
Pulse & bar
Green

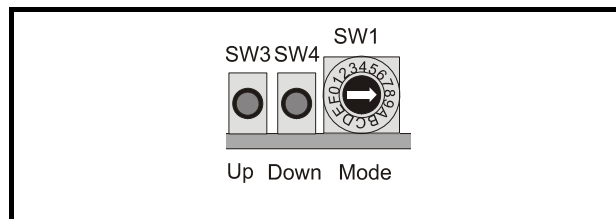

Position B Border Colour

This function selects the Border Colour (the unused area outside the picture) to be selected.

Selections are:

Black
Blue
Red
Green
White
Grey
User A
User B

Position C Luma Gain

This function allows the Luma Gain to be adjusted by ± 6 dB in steps of 0.1 dB.

Position D Chroma Gain

This function allows the Chroma Gain to be adjusted by ± 6 dB in steps of 0.1 dB.

Position E Black Level

This function allows the Black Level to be adjusted by ± 100 mV in steps of 0.8 mV.

Position F Preset Unit

In this position, pressing SW1 and SW2 together sets all parameters to the default/pre-set conditions.

RollCall Control Templates for the IQARC00

ARC

This screen allows settings to be made for the aspect ratio conversion parameters.

Bypass

When checked this function allows the input signal to be passed through to the output without any processing.

Freeze

When selected the output will become a frozen frame.

Mode

This function allows the overall operating mode of the IQARC00 to be selected.

Manual

When checked the picture size will respond to the parameters set by the manual controls.

Auto

When checked this enables the mode that automatically responds to the chosen version of wide screen Signaling or video index.

Minimum delay

When checked the picture size will respond to the parameters set by the Minimum Delay control settings.

Enhancer

The Enhancer allows High Band (High Frequency) and Mid Band (Medium Frequency) enhancement to be applied to the processed signal. The non-linear process prevents enhancement of low-amplitude signals typical of noise.

The Enhancer options are:

- Normal (Enhancement is not applied)
- High Band
- Mid Band Low
- Mid Band Medium
- Mid Band High

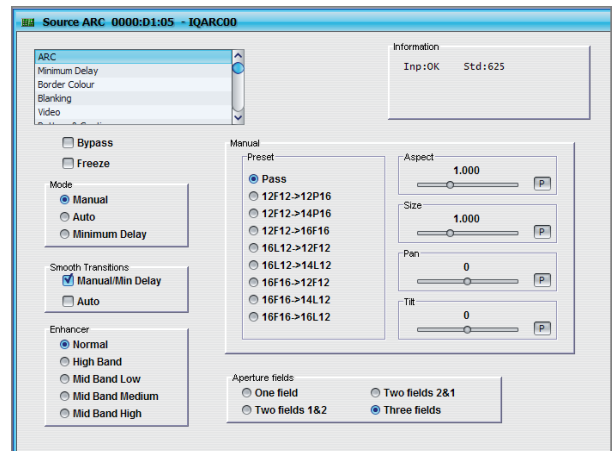

Smooth Transitions

When the output picture size changes this function allows control over the way that the change of picture size occurs.

Manual/Min Delay

When checked the picture size will change smoothly to the new size when the IQARC00 is in manual mode.

Auto

When checked the picture size will change smoothly to the new size when the IQARC00 is in auto mode.

Note that for this and other screens the following applies:

The **P** symbol represents the Preset function and will return the function to the default setting.

The numerical value will be shown above the scroll bars and selecting Preset will return the setting to the calibrated value of 0 for items on this screen.

Aperture Fields

This function allows the fields used for interpolation to be chosen.

One Field

The two and three field apertures will produce better results than the one field aperture. However in some special cases (e.g. programme material containing DVE moves or scrolling captions) a one field aperture may be preferred.

Two Fields 1&2

This aperture pairs fields 1 and 2 together as a set and applies a two field aperture to them.

Two Fields 2&1

As Two Fields 1&2 above but pairs the set across the other field boundaries. i.e. field 2 of one frame and field 1 of the next.

Three Fields (default)

This applies the best quality three field aperture to aspect ratio conversions.

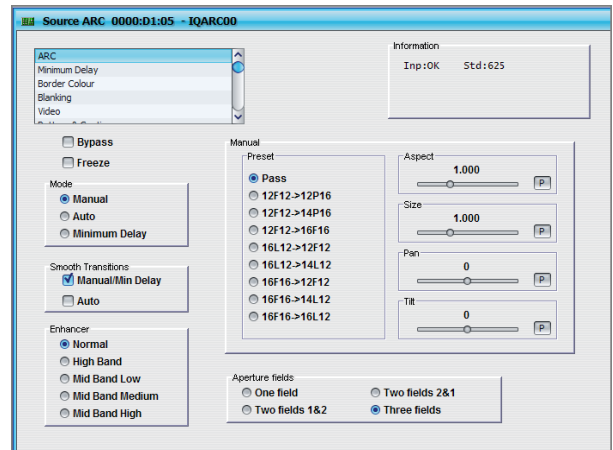

Manual ARC

This function allows the input-to-output aspect ratio conversion to be set.

Preset

Preset values of aspect conversion may be chosen from the list:

Pass (Output the same as input aspect ratio)

- 12F12->12P16 4:3 > 16:9 PB
- 12F12->14P16 4:3 > 14:9 PB
- 12F12->16F16 4:3 > 16:9 FH
- 16L12->12F12 16:9 LB > 4:3
- 16L12->14L12 16:9 LB > 14:9 LB
- 16F16->12F12 16:9 FH > 4:3
- 16F16->14L12 16:9 FH > 14:9 LB
- 16F16->16L12 16:9 FH > 16:9 LB

Other values of aspect ratio conversion may be set up using the following controls:

*Note that when a **Preset** aspect ratio is selected the numerical values for that aspect ratio will be shown by the Aspect, Size, Pan and Tilt controls. These controls will then allow adjustments to be made to the selected **Preset** value. Note that when any of these settings are changed the Preset value will be deselected.*

Aspect

The output aspect ratio may be adjusted using this control. The range of adjustment is from 0.5 to 2.0 in steps of 0.001.

Preset is to 1



Original Picture

Size

This will adjust the size of the whole image. Both vertical and horizontal size change together while maintaining the aspect ratio of the image.

The range of adjustment is from 0.5 to 2.0 in steps of 0.001.

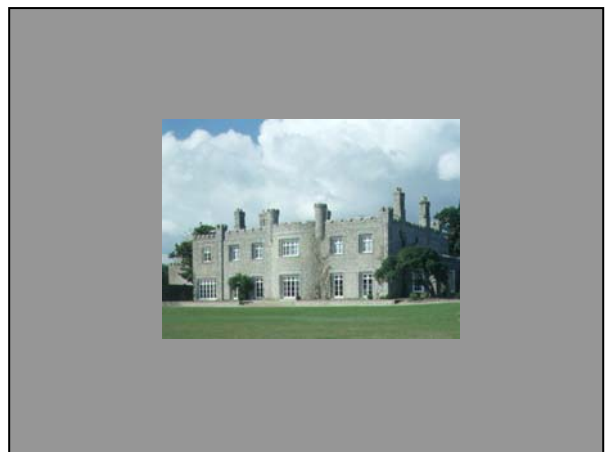

Effect of applying 0.5 Size

Pan

This will adjust the horizontal position of the output image.

The range of adjustment is ± 3700 in steps of 1.



Effect of a pan

Tilt

This will adjust the vertical position of the output image.

The range of adjustment is ± 3000 in steps of 1.

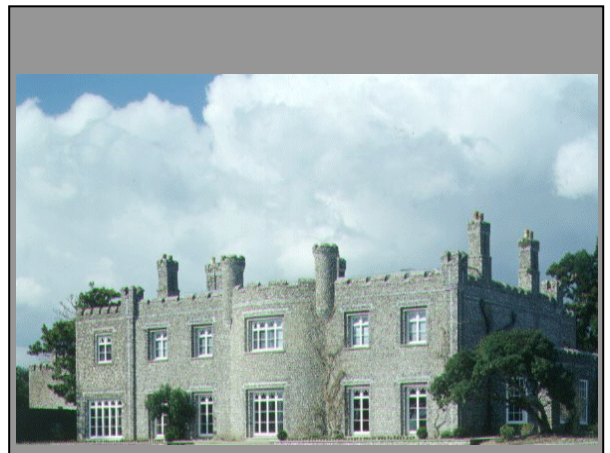

Effect of Tilt

Minimum Delay

This mode produces the minimum input/output delay by disabling vertical size changes; therefore only a reduced selection of preset aspect rations conversions are available.

When **Minimum Delay** mode is selected the aspect ratio conversion may be set by the following items:

Minimum Delay

Preset

Preset values of aspect conversion may be chosen from the list:

Pass (Output the same as input aspect ratio)
 12F12->12P16 4:3 > 16:9 PB
 16F16->12F12 16:9 FH > 4:3

Default setting is to Pass

Aspect

The output aspect ratio may be adjusted using this control.
 The range of adjustment is from 0.5 to 2.0 in steps of 0.001.

Preset is to 1





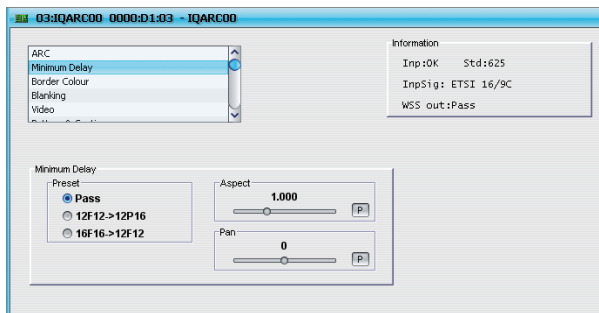

Pan

This will adjust the horizontal position of the output image.

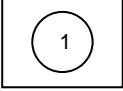
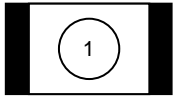
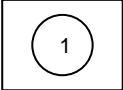
The range of adjustment is ±3700 in steps of 1.

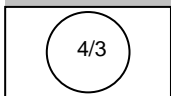
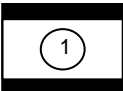
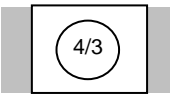
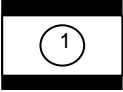

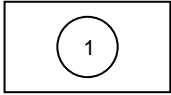
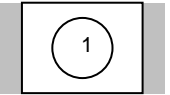
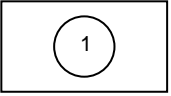
CONVERSION DETAILS

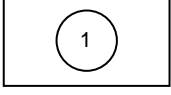
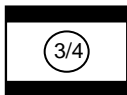
Input		Transformation	Output	
4:3	16:9		4:3	16:9
		Description: 4:3 to 16:9 PB Menu: 12F12 to 12P16 Ratios: V: 1 H: ¾		
		Description: 4:3 to 14:9 PB Menu: 12F12 to 14P16 Ratios: V: 7/6 H: 7/8	Active image is vertically cropped	
		Description: 4:3 to 16:9 FH Menu: 12F12 to 16F16 Ratios: V: 4/3 H: 1		
		Description: 16:9 LB to 4:3 Menu: 16L12 to 12F12 Ratios: V: 4/3 H: 4/3		Active image is side cropped
		Description: 16:9 LB to 14:9 LB Menu: 16L12 to 14L12 Ratios: V: 8/7 H: 8/7		Active image is side cropped
		Description: 16:9 FH to 4:3 Menu: 16F16 to 12F12 Ratios: V: 1 H: 4/3		Active image is side cropped
		Description: 16:9 FH to 14:9 LB Menu: 16F16 to 14L12 Ratios: V: 6/7 H: 8/7		Active image is side cropped
		Description: 16:9 FH to 4:3 LB Menu: 16F16 to 16L12 Ratios: V: ¾ H: 1		

Border Colour

This function allows the Border Colour (the unused area outside the picture) to be selected.

Colour

Specific colours may be selected or two custom set-ups are available from the User A and User B items.

Set Colour selections are:

- | | |
|--------|--------|
| Black | Blue |
| Red | Green |
| White | Grey |
| User A | User B |

Set User A, Set User B

This function allows custom settings of red, green and blue to be adjusted using the scroll bars.

The range of control is from 0 to 255 units in steps of 1 unit.

Preset is to 0.

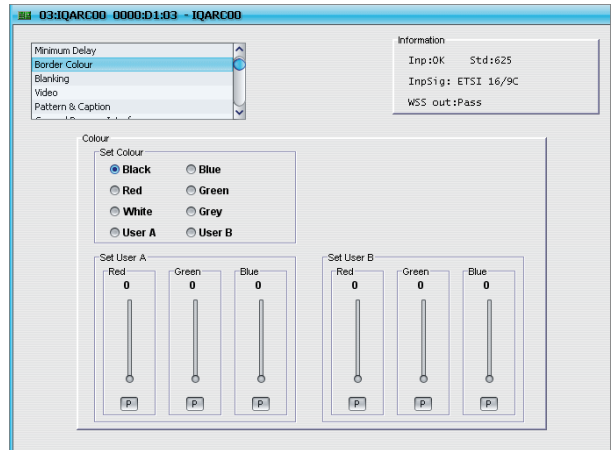

Blanking

This function allows the left/right horizontal and the top/bottom blanking edges to be moved in both the input and output active picture.

Input and Output

Left/Right

The Left/Right edge may be moved from 0 to 13.246 μ s of the picture width in steps of 148 ns.

Top/Bottom

The Top/Bottom edge may be moved from 0 to 200 lines of the picture height in steps of 1 line.

Std525 Line 21/283 (525 line systems only)

This allows the selection of line 21/283 as a video line or a VITS line (usually closed captioning).

Picture

Selects line 21/283 as a video line.

Closed Caption

Selects line 21/283 as a vertical blanking line.
Note: When this option is selected the control of 'Input Blanking Top' should be manually set to be at least two lines to prevent closed caption appearing in the active picture.

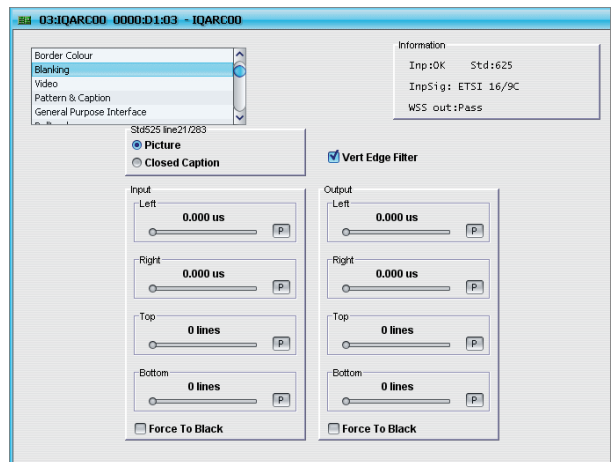

Vert Edge Filter

When selected a one line cross fade action is introduced on the horizontal edge transition between picture and blanking which helps to remove twitter.

Force to Black (Input & Output)

Selecting this function will force the input (output) blanking to black therefore allowing the input (output) blanking to be black and the other to be a colour.

Video

Proc Amp

This selection allows various adjustments to be made to the processed signal.

Luma Gain

This selection reveals a numerical readout display for the gain of the luminance signal.

By using the scroll bar the gain may be adjusted by ± 6 dB in steps of 0.1 dB.

Selecting Preset returns the setting to the calibrated value of 0.

Black Level

This selection reveals a numerical readout display for the Y pedestal or black level.

By using the scroll bar the pedestal may be adjusted by ± 100 mV in steps of 0.8 mV.

Selecting Preset returns the setting to the calibrated value of 0.

Chroma Gain

This selection reveals a numerical readout display for the gain of the chrominance signal.

By using the scroll bar the gain may be adjusted by ± 6 dB in steps of 0.1 dB.

Limiting

These functions allow Y and C signal excursions to be limited by setting minimum and maximum clipping levels. All adjustments are made in steps of 0.8 mV.

Y Clipper Min

The minimum clip level for the luminance signal may be set between -50 mV and $+49.2$ mV

Preset value is -50 mV

Y Clipper Max

The maximum clip level for the luminance signal may be set between $+635$ mV and $+764.6$ mV

Preset value is $+764.6$ mV

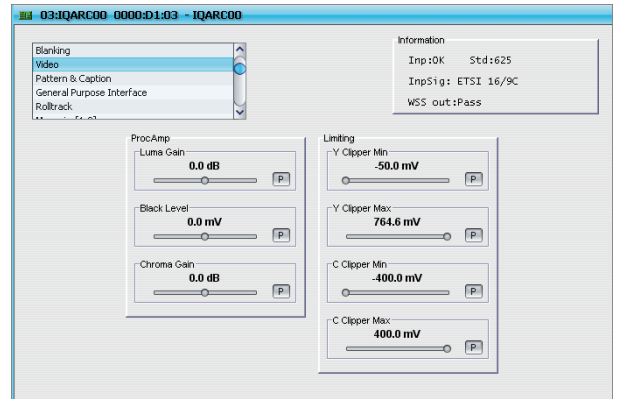

C Clipper Min

The minimum clip level for the chrominance signal may be set between -400 mV and -200 mV

Preset value is -400 mV

C Clipper Max

The maximum clip level for the chrominance signal may be set between $+200$ mV and $+400$ mV

Preset value is $+400$ mV

Pattern & Caption

This item allows a pattern to be selected as the output, a caption to be setup and a character display of 10 lines to be displayed.

Note that the picture behind the caption will appear at half amplitude luminance.

Caption

Edit Caption

A 1 line caption of 19 characters may be set up by editing the text string.

Preset is ARC00

Select Caption

The caption may be selected as

- Caption Off The caption will not appear
- 1 Line Caption The 1 line caption will appear as set up by the Edit Caption function
- 10 Lines Display The 10 lines display will appear. This is an automatically generated display of current settings.

Insertion

This item allows the pattern, caption and display to be inserted into either the Processed path or the Unprocessed path or both.

Pattern

This function will allow various patterns to be used as the output signal.

Pattern On

When this item is selected a pattern from the list, will become the output signal.

Note: if patterns and caption are turned on at the same time then the pattern will default to black.

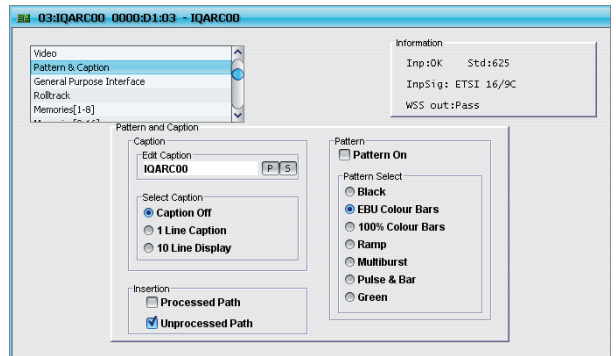

Example of On Screen Display

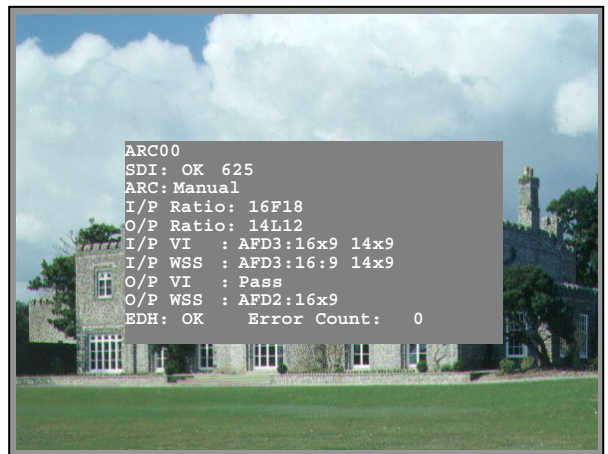

Pattern Select

The pattern may selected from the following list:

- Black
- EBU Colour Bars
- 100% Colour bars
- Ramp
- Multiburst
- Pulse & bar
- Green

General Purpose Interface

When fitted with a 25 way D connector the IQARC00 has eight GPI inputs and four others that may be configured as inputs or outputs.

When fitted with BNC connectors the IQARC00 has three GPI inputs that may be configured as inputs or outputs.

GPI In

By using the scroll bar one of the GPI's may be selected from the following:

GPI 1 to 8 and GPIO IN 1 to 4

Input Functions

When the GPI input is activated the IQARC00 may be configured to respond in one of the following ways:

- Unused The function not active. This is also the Preset Setting.
- Pattern ON The unit will produce a pattern output. Note that the caption function must be switched OFF.
- Freeze The unit will enter the freeze mode.
- Memory 1 to 16 The unit will use the settings stored in the selected memory location.
- Memory 1-2 The unit will toggle between the settings of memory locations 1 and 2. Open to Closed = Memory 1 settings
Closed to Open = Memory 2 settings

Disable Inputs

When selected all GPI input functions will be disabled.

GPI In Status

This will show the current status of the GPI input.

GPI Out Status

This will show the current status of the GPI output.

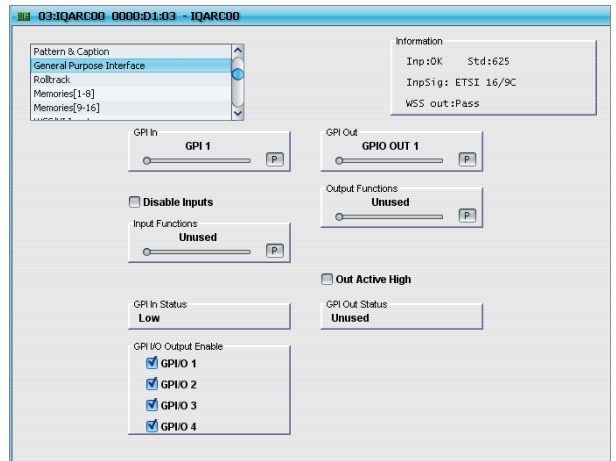

GPI out

By using the scroll bar one of the four configurable GPI's may be selected from the following:

GPIO OUT 1 to 4

When a GPI is configured as an output it can provide an output corresponding to one of the following conditions:

Output Functions

The GPO may be configured to produce an output corresponding to one of the following conditions:

- Unused The function is not active (Preset setting)
- Input Lost Produces an output if the input signal is lost
- Standard 625 Produces an output if the operating line standard is 625
- AFD Conflict Produces an output if there is a conflict between WSS and VI AFD information.
- Video delay Produces a high output signal corresponding to the video delay through the unit

GPI I/O Output Enable

Normally GPI 1, 2, 3, and 4 are configured as inputs. By checking a box the associated GPI will be configured as an output.

RollTrack

This function allows information to be sent, via the RollCall™ network, to other compatible units connected on the same network.

For example, it can enable compatible audio delay units to produce an audio delay dependent on this and other similar units. The audio delay unit will dynamically follow or track the received delay-time information. This allows processed video signals to be timed correctly with audio signals. This automatic tracking system via the RollCall™ network is called **RollTrack**.

For more detailed information, see the *RollTrack* section (Appendix) at the end of this manual.

RollTrack Index

This item allows up to 16 destinations to be selected.

RollTrack Source

This allows the source of information that triggers the transmission of data to be selected. Options are:

Unused	IN SMPTE 4/3
Video Delay	IN SMPTE 16/9
Input Present	IN SMPTE none
Input Missing	*WSS ETSI4/3FF
Standard 525	*WSS ETSI14/9C
Standard 625	*WSS ETSI14/9T
No AFD Conflict	*WSS ETSI116/9C
AFD Conflict	*WSS ETSI116/9T
IN ETSI 4/3FF	*WSS ETSI>16/9C
IN ETSI 14/9C	*WSS ETSISP14/9
IN ETSI 14/9T	*WSS ETSI16/9FF
IN ETSI 16/9C	*WSS AFD0 4/3
IN ETSI 16/9T	to
IN ETSI >16/9C	*WSS AFD7 4/3
IN ETSI SP14/9	*WSS AFD0 16/9
IN ETSI 16/9FF	to
IN ETSI None	*WSS AFD7 16/9
IN AFD0 4/3	*VI AFD0 4/3
to	to
IN AFD7 4/3	*VI AFD7 4/3
IN AFD0 16/9	*VI AFD0 16/9
to	to
IN AFD7 16/9	*VI AFD7 16/9
IN AFD none	*VI SMPTE 4/3
	*VI SMPTE 16/9

*These refer to the signaling currently being outputted by the unit.

*Note that ETSI 0 to 7 corresponds to the following ETSI signaling: 4/3 FF, 14/9 Center, 14/9 Top, 16/9 Center, 16/9 Top, >16/9 Center, SP 14/9, 16/9 FF respectively.

The destination for the information is set by the network code address as follows:

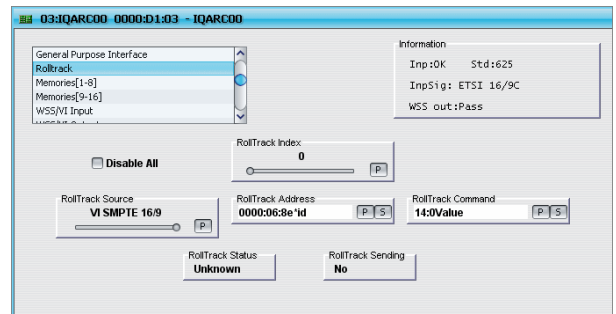

RollTrack Address

This item allows the address of the selected destination unit to be set.

To change the address, type the new destination in the text area and then select **S** (return)

(Preset) returns to the default destination

The full RollTrack address has four sets of numbers.

For example: 0000:10:01*99

The first set (0000) is the network segment code number

The second set (10) is the number identifying the (enclosure/mainframe) unit

The third set (01) is the slot number in the unit

The fourth set (99) is a user settable ID number to help identify the sender in a multi-unit system

RollTrack Command

The full **Rolltrack** command has two sets of numbers.

For example: 84*156

The first set (84) is the **Rolltrack** command number

Note that only command numbers 14, 15, 16 and 17 should be used for audio delay

The second set (156) is the value sent with the **Rolltrack** command number

Note that when video delay is selected as the Rolltrack source the value sent with the Rolltrack command is the video delay value not the value set

For details of the RollCall command values for specific units please contact your local Snell & Wilcox agent.

RollTrack (continued)**RollTrack Sending**

This item shows when the unit is actively sending the RollTrack command.

This may show:

- String A string value is always being sent.
- Number A number value is always being sent.
- No The message is not being sent.
- Yes The message is being sent.

Internal Type Error

Inconsistent behavior; please contact your local Snell & Wilcox agent.

Disable All

When this item is checked all RollTrack items will be disabled.

RollTrack Status

This item will show the status of the RollTrack system.

RollTrack Sending

This item shows when the unit is actively sending the RollTrack command.

This may show:

- String A string value is always being sent.
- Number A number value is always being sent.
- No The message is not being sent.
- Yes The message is being sent.

Internal Type Error

Inconsistent behavior; please contact your local Snell & Wilcox agent.

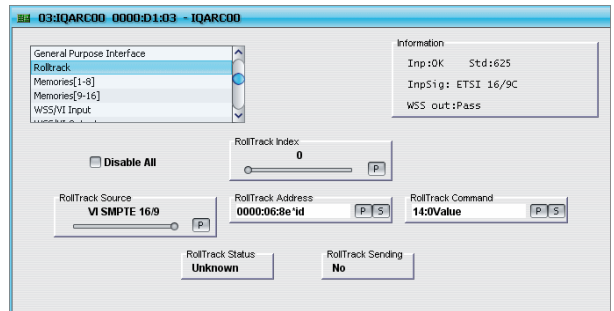

Memories

User Memories (1 to 8) and (9 to 16)

This function allows a number of particular setups of the IQARC00 to be saved and recalled. There are 16 memory locations available.

To change the name of a memory location type the new name in the text area and then select **S** (return)

(Preset) returns the name to the default name.

Clear

This item allows the memory location to be cleared and returned to the default (preset) setting.

Save

This function allows the settings of all items to be saved at the memory location.

Recall

This function allows the saved settings (as selected by the **Memory Index** function) to be recalled.

Memory Index

When a setup is saved at a particular memory location all parameters are saved.

When the memory location is recalled only the checked parameters from the list below will be recalled.

- Video Setup
- ARC Mode
- Manual Setup
- Automatic Setup
- Others

Any or all of these items may be selected.

The required memory location for the memory index function (Memory 1 to 16) should be selected using the scroll bar.

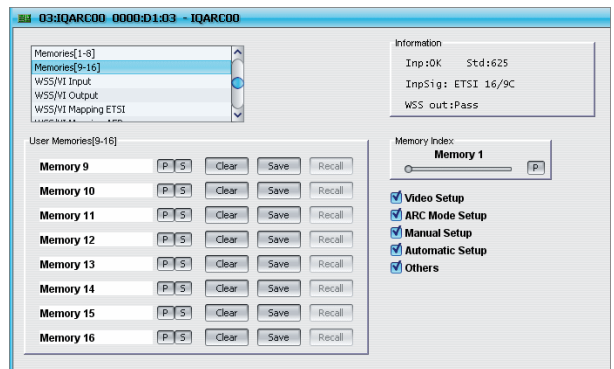
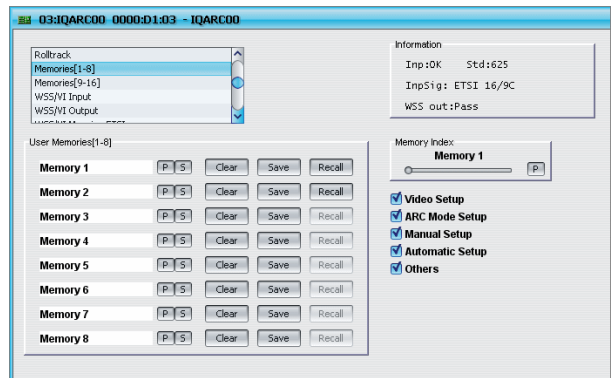

WSS/VI Input

Wide Screen Signaling and Video Index (Input)

This allows the parameters relating to the source of automatic aspect ratio control to be selected.

Input Source

This function allows the fundamental type of Signaling that the unit will respond to.

WSS Type

WSS ETSI Wide screen signaling
(European Telecommunications Standards Institute)

WSS AFD Wide screen signaling
Active Format Descriptor

VI Type

VI SMPTE Video Index SMPTE

VI AFD Video Index
Active Format Descriptor

AFD Input

The Active Format Descriptor input may be chosen to be

AFD & ScanSys Active Format Descriptor and the scan system used

AFD only Active Format Descriptor only

WSS Waveform

This item allows the unit to respond to wide screen Signaling waveform that is either

Normal or
Non Standard

Read WSS Line

The wide screen Signaling data would normally be read from line 23; this item allows any line from line 7 to line 23 to be chosen.

Delete WSS Line

This item allows the data from the line selected above to be deleted.

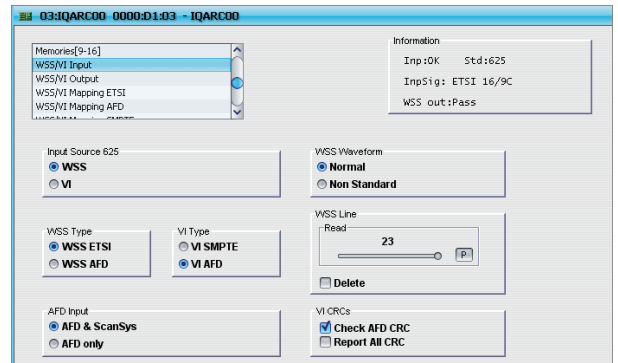

VI CRC's

The Video Index Cyclic Redundancy Checksums may be selected to do the following:

Check AFD CRC Check the Active Format Descriptor Cyclic Redundancy Checksum only and error if incorrect.

Report All CRC Report all Cyclic Redundancy Checksums errors.

WSS/VI Output

This allows the output data parameters relating to automatic aspect ratio control to be selected.

WSS (Wide Screen Signaling)

Forced The appropriate values in forced mode will be output.

UserBits On Inserts the user set enhanced WSS bits.

Use the slider control to select between 15 preset bit combinations. As the slider bar is moved, the check boxes below it indicate the enhanced bits that have been selected. Bits 12 and 13 are not included in any of the combinations controlled by the slider bar, but they can be manually selected. Selecting a bit combination using the check boxes will move the slider bar to the corresponding position.

Set User Bits Sets the 4 bits of the enhanced WSS system

Write to Line The line to insert the Wide Screen Signaling may be selected from here.

WSS Output Type

Pass If Wide Screen Signaling is present then regenerate the waveform with data unchanged otherwise delete the first half of selected line.

ETSI ETSI format WSS data will be inserted

AFD Insert WSS AFD only.

AFD & ScanSys AFD and scanning system data will be inserted.

Delete All WSS data will be deleted.

VI (Video Index)

Forced The appropriate values in forced mode will be output.

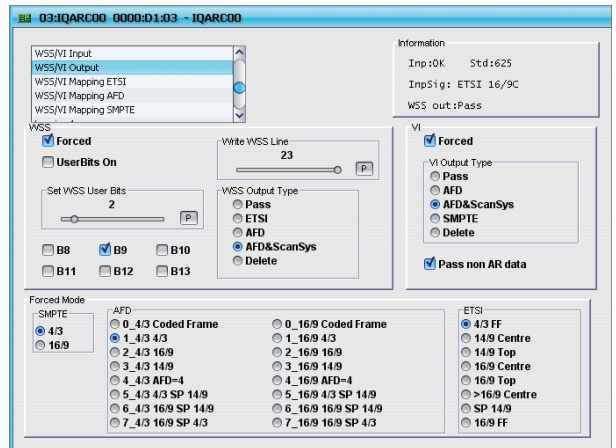

VI Output Type

This selects what form of video index output signal is generated. Options are:

Pass When selected the input VI will be passed through the unit.

AFD Insert VI AFD only.

AFD & ScanSys AFD and scanning system data will be inserted.

SMPTE SMPTE format VI data will be inserted

Delete All data will be deleted.

Aspect Ratio Control

AR only Inserts new information and blanks all other sets of signaling.

AR & Pass Inserts new information and passes all other sets of signaling.

Forced mode

For each standard of Signaling select value to be inserted when in appropriate forced mode and correct standard.

Abbreviations

WSS Wide screen signaling

VI Video Index

AFD Active Format Descriptor

ETSI European Telecommunications Standards Institute

SMPTE Society of Motion Picture and Television Engineers

CRC Cyclic Redundancy Checksum

WSS/VI Mapping ETSI

This function sets up how the unit responds to the input Signaling of the input standard.

For each possible input Signaling setup the Aspect, Size, Pan and Tilt plus output Signaling is required.

ETSI In

This function allows a different output configuration to be selected for each input.

ETSI/AFD/SMPTE Out

This function shows the selection for output mapping for each of the input selections.

Controls

Follow online

When selected, changes made are applied to the picture regardless of input Signaling value. When not selected they are only applied when correct Signaling value is read.

Save

This function saves the settings of this function for selected input Signaling value.

Note that every input function must be saved individually.

Recall

This function recalls the settings for the selected input Signaling value.

Bypass

When selected this function acts as a bypass for the selected input.

None Enable

When selected this enables no input Signaling as an input type.

When not selected then holds the last good Signaling if input Signaling is lost.

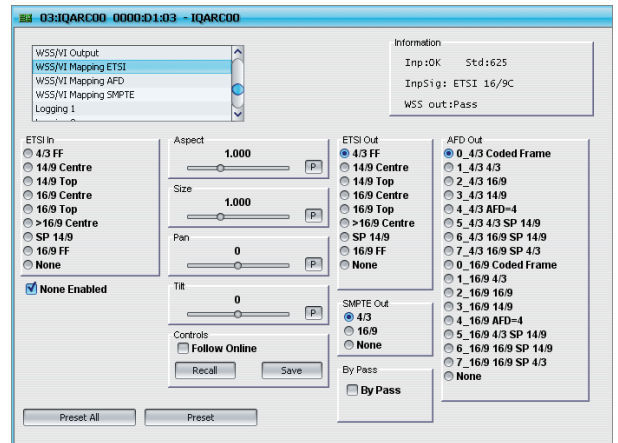

Aspect

The output aspect ratio may be adjusted using this control.

The range of adjustment is from 0.5 to 2.0 in steps of 0.001.

Preset is to 1

Size

This will adjust the size of the whole image. Both vertical and horizontal size change together while maintaining the aspect ratio of the image.

The range of adjustment is from 0.5 to 2.0 in steps of 0.001.

Pan

This will adjust the horizontal position of the output image.

The range of adjustment is ± 3700 in steps of 1.

Tilt

This will adjust the vertical position of the output image.

The range of adjustment is ± 3000 in steps of 1.

WSS/VI Mapping AFD

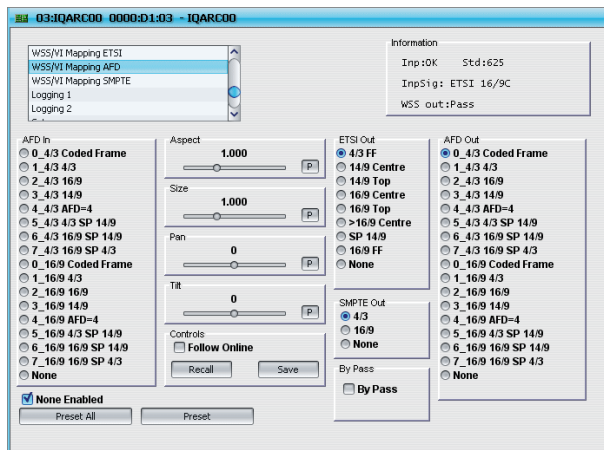

Functionality as ETSI above but for AFD inputs.

WSS/VI Mapping SMPTE

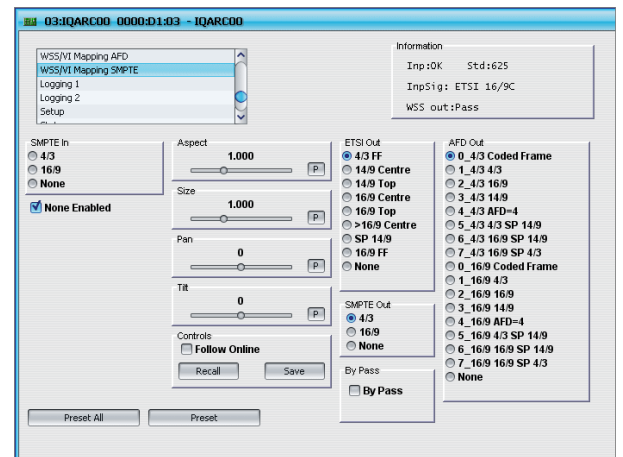

Functionality as ETSI above but for SMPTE input signaling.

Logging 1 and 2

Logging

If a logging device is attached to the RollCall™ network, information about various parameters can be made available to such a device.

Any of the items may be selected from the list.

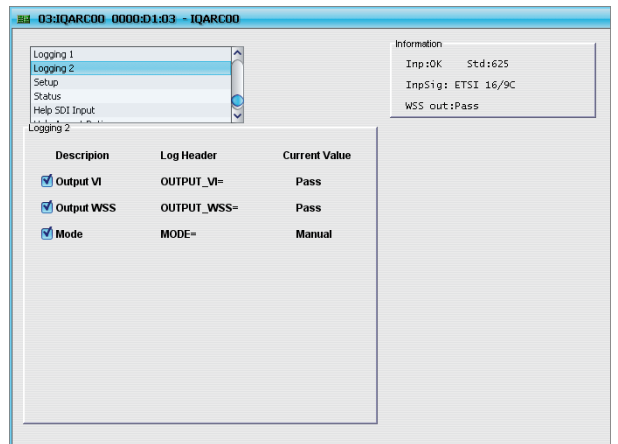
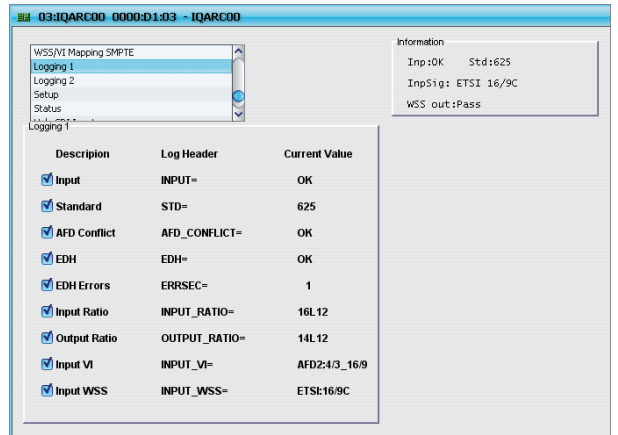

Setup

This item allows various basic functions to be set up.

Input Standard

525 If only this item is selected the unit will be forced to only accept a 525 line standard

625 If only this item is selected the unit will be forced to only accept a 625 line standard

If both 525 and 625 are selected the unit will automatically operate at the incoming line standard.

If neither of the items are selected the unit will remain in the state of the last selection.

Terminology

The notation used to express the aspect ratio may be chosen with this item.

WRT9 Aspect ratio of active image area expressed as a two digit abbreviated numeric value where the comparison ratio is against a height of 9.
e.g. 12 is used for 4 by 3 (12 by 9).

PB/LB The visual effect of the image and display raster aspect ratios combined.
PB (Pillar Box) is full height but with black down the sides. LB (Letter Box) is full width with black top and bottom.

Ratio The aspect ratio expressed as a numerical ratio of width to height.

Default output

If the input signal fails the output may be configured to become either Black or Freeze (a frozen picture)

Note that the default output for the unprocessed path will always be to black.

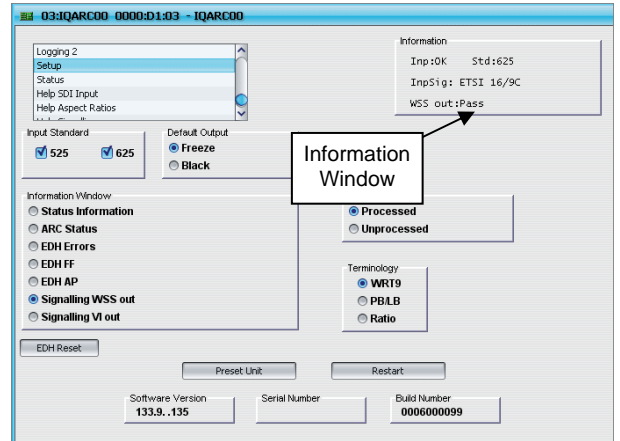

Information Window

This item allows the type of data shown in the information window, to be selected.

Options are:

Status Information Shows the status of the unit
e.g. FRZ BYP MIN PAT
Where FRZ = Picture freeze
BYP= Unit in Bypass
MIN = Unit in Min Delay mode
PAT = Pattern On

ARC Status Shows the status of the aspect ratio conversion

EDH Errors Shows EDH Error seconds

EDH FF Shows Full Field checksum
Note that field 2 checksum is shown on the left and field 1 on the right of the display.

EDH AP Shows Active Picture Checksum
Note that field 2 checksum is shown on the left and field 1 on the right of the display.

Signaling WSS out This displays the WSS output type.

Signaling VI out This displays the VI output type.

Setup (cont)

Monitoring Output

This function allows what type of signal that will appear at the three Monitoring outputs.

- Processed The signal via a fully processed path with procamp, Signaling etc. enabled.
- Unprocessed The unprocessed path is the input signal with optional OSD, pattern and signaling.

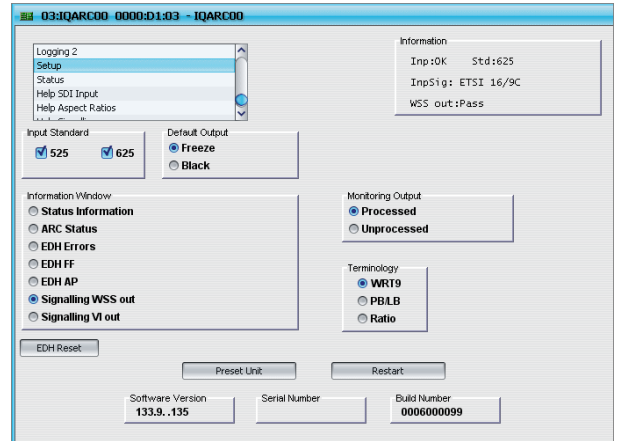

EDH Reset

This will reset the EDH error counter to zero.

Preset Unit

Selecting this item sets all adjustment functions that include a preset facility, to their preset values.

Note that this is a momentary action.

Restart

This will reboot the unit simulating a power-down power-up cycle restoring power-up settings.

Software Version

This item shows the version of the software fitted in the module.

Serial Number

This item shows the serial number of the module

Build Number

This item shows the build number of the module

Status

This item displays the overall status of the unit on a single screen.

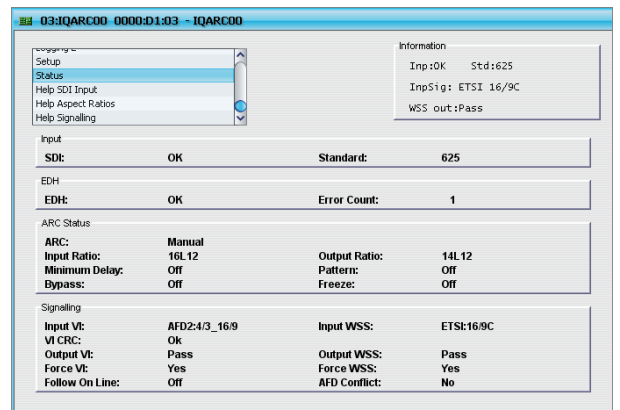

Help SDI Input

This screen explains the meanings of abbreviations used in the information window associated with the input signal.

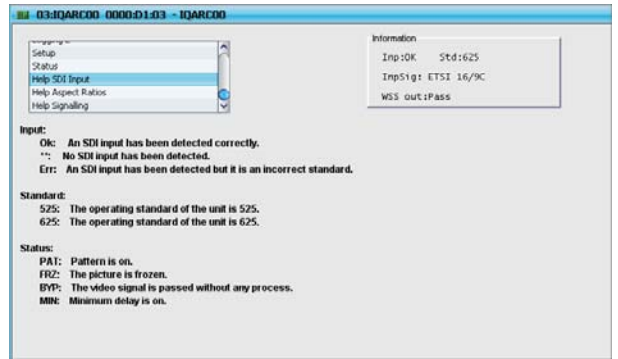

Help Aspect Ratios

This screen explains the meanings of abbreviations used in the information window associated with aspect ratios

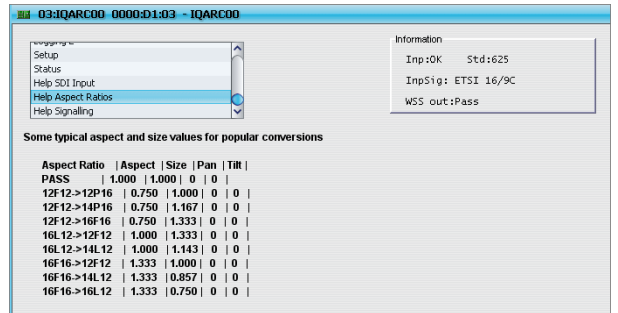

Help Signaling

This screen explains the meanings of abbreviations used in the information window associated with signaling.

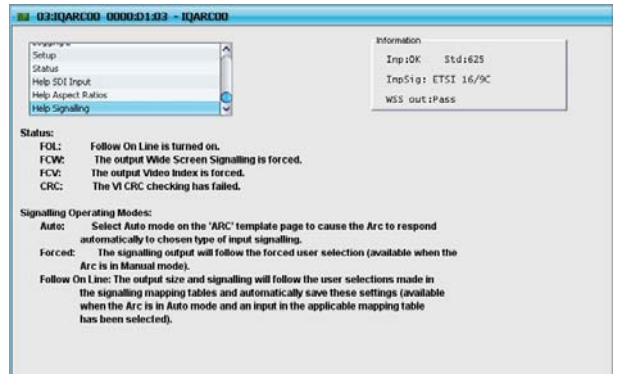

Operation from an Active Control Panel

The card may be operated from an active control panel via the RollCall™ network.



All operational parameters and selections are made using a system of menus displayed in two LCD windows. Operational details for the remote control panel can be found in the Modular System Operator's Manual.

Information Window

The Information window has four lines of text indicating the current state of the unit.

For details of the abbreviations used please see page 55.

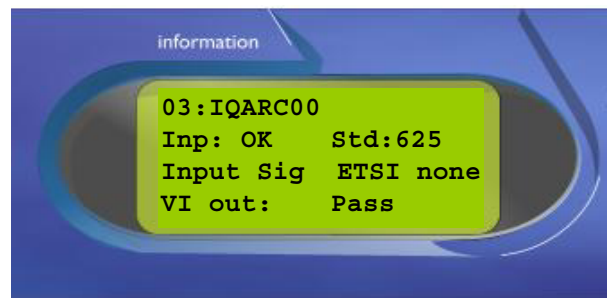

Control Window

The Control window displays all Selection Menus and sub-menus.

The selection is made by pressing the button adjacent to the required item.

The menu structure is detailed in the following pages.

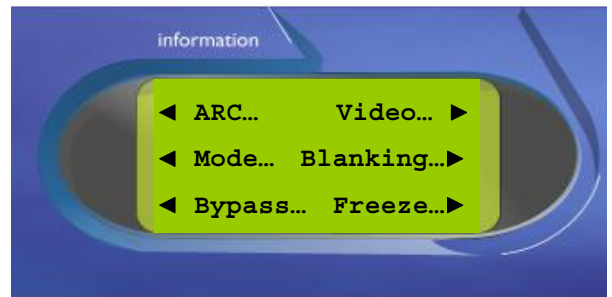

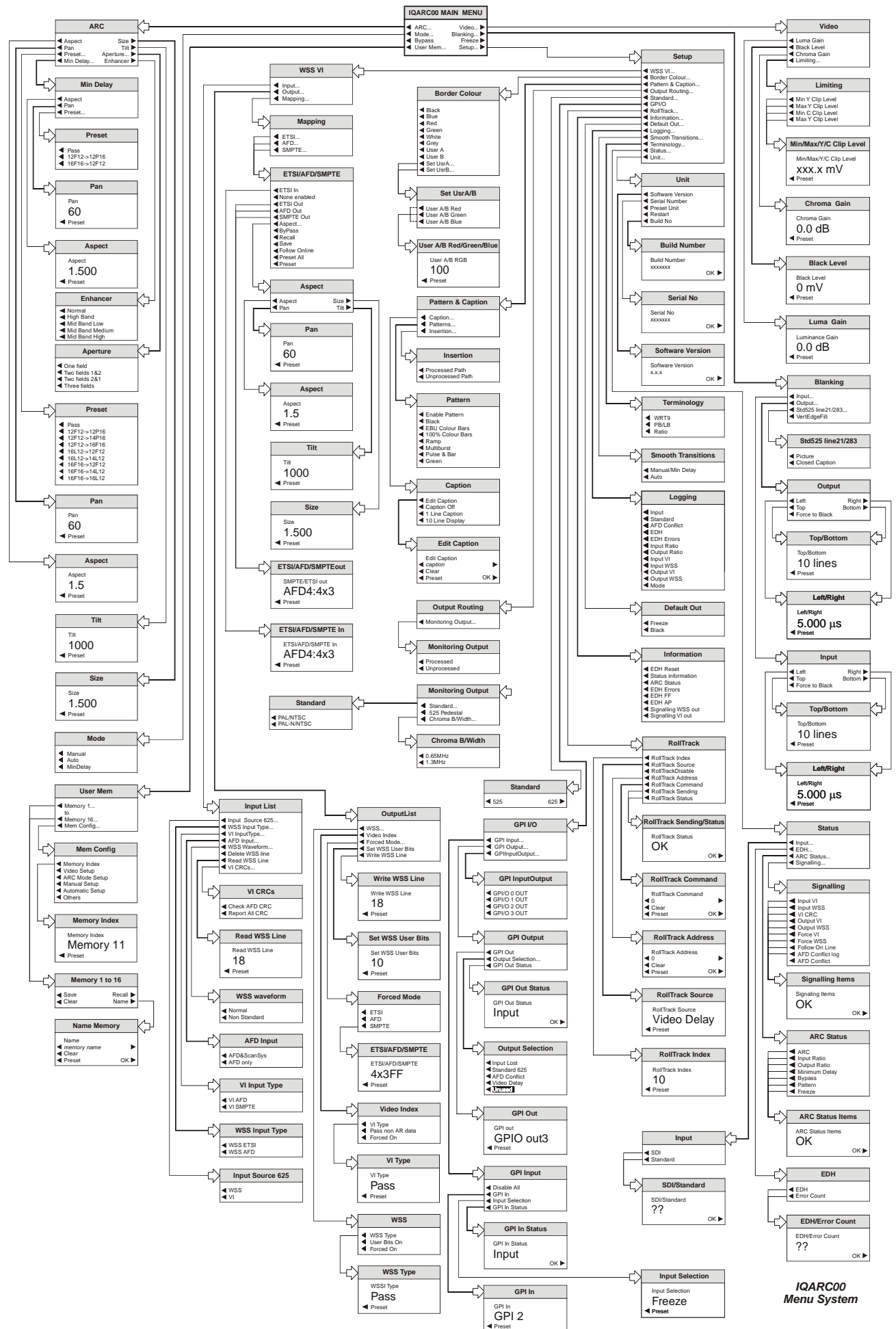

IQARC00
Menu System

Operation From an Active Control Panel

The card may be operated with an active control panel via the RollCall™ network. The menus available for this card are shown opposite and will appear in the Control display window.

Operational details for the remote control panel will be found in SECTION 1 of the Modular System Operator's Manual.

(See IQARC00 Menu System drawing on previous page)

The system may be considered structured as a set of menus and sub-menus that are displayed in the LCD window.

A new menu is selected by pressing the appropriate dedicated function button.

If necessary a sub-menu may be then be selected by pressing the push button adjacent to the arrowhead in the text line of the menu name.

This sub-menu will then be displayed in the window and will have the option of selecting another sub-menu in the same manner, or allow the adjustment of a particular parameter. Parameters enabled will appear as highlighted reverse text (white text on a black background)

Main Menu

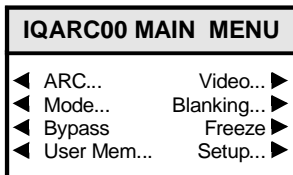

ARC...

This screen allows settings to be made for the aspect ratio conversion parameters.

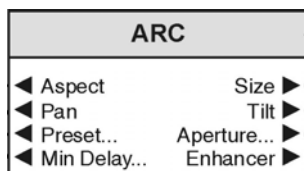

◀ Aspect

The output aspect ratio may be adjusted using this control.

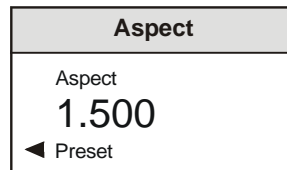

The range of adjustment is from 0.5 to 2.0 in steps of 0.001.

Preset is to 1

Size ▶

This will adjust the size of the whole image.

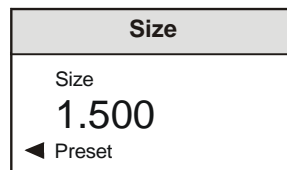

Both vertical and horizontal size change together while maintaining the aspect ratio of the image.

The range of adjustment is from 0.5 to 2.0 in steps of 0.001.

◀ Pan

This will adjust the horizontal position of the output image.

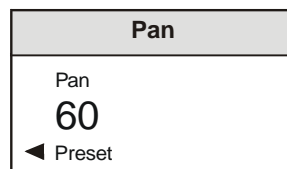

The range of adjustment is ±3700 in steps of 1.

Tilt ▶

This will adjust the vertical position of the output image.

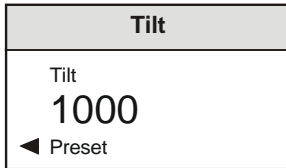

The range of adjustment is ±3000 in steps of 1.

◀ Preset

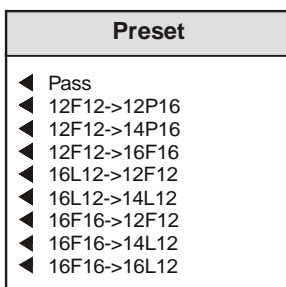

Preset values of aspect conversion may be chosen from the list:

- Pass (Output the same as input aspect ratio)
- 12F12->12P16 4:3 > 16:9 PB
- 12F12->14P16 4:3 > 14:9 PB
- 12F12->16F16 4:3 > 16:9 FH
- 16L12->12F12 16:9 LB > 4:3
- 16L12->14L12 16:9 LB > 14:9 LB
- 16F16->12F12 16:9 FH > 4:3
- 16F16->14L12 16:9 FH > 14:9 LB
- 16F16->16L12 16:9 FH > 4:3 LB

*Note that when a **Preset** aspect ratio is selected the numerical values for that aspect ratio will be shown by the Aspect, Size, Pan and Tilt controls. These controls will then allow adjustments to be made to the selected **Preset** value.
Note that when any of these settings are changed the Preset value will be deselected.*

◀ Aperture

This function allows the fields used for interpolation to be chosen.

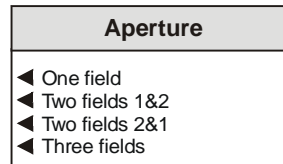

◀ One Field

The two and three field apertures will produce better results than the one field aperture. However in some special cases (e.g. program material containing DVE moves or scrolling captions) a one field aperture may be preferred.

◀ Two Fields 1&2

This aperture pairs fields 1 and 2 together as a set and applies a two field aperture to them.

◀ Two Fields 2&1

As Two Fields 1&2 above but pairs the set across the other field boundaries. i.e. field 2 of one frame and field 1 of the next.

◀ Three Fields (default)

This applies the best quality three field aperture to aspect ratio conversions.

◀ Enhancer

The Enhancer allows High Band (High Frequency) and Mid Band (Medium Frequency) enhancement to be applied to the processed signal. The non-linear process prevents enhancement of low-amplitude signals typical of noise.

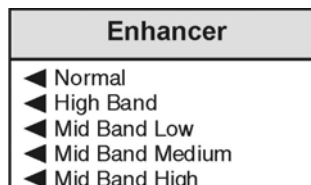

Minimum Delay ▶

This mode produces the minimum input/output delay by disabling vertical size changes; therefore only a reduced selection of preset aspect ration conversions are available.

When **Minimum Delay** mode is selected the aspect ratio conversion may be set by the following items:

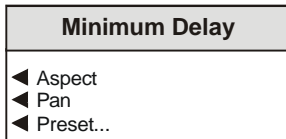

◀ Aspect

The output aspect ratio may be adjusted using this control.

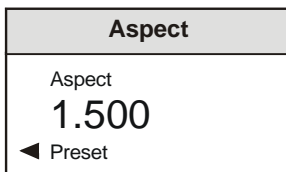

The range of adjustment is from 0.5 to 2.0 in steps of 0.001.

Preset is to 1

◀ Pan

This will adjust the horizontal position of the output image.

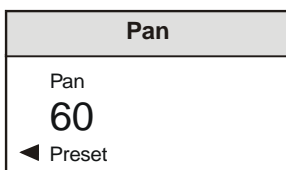

The range of adjustment is ±3700 in steps of 1

◀ Preset

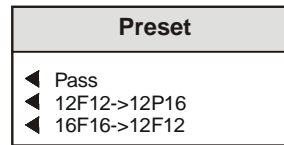

Preset values of aspect conversion may be chosen from the list:

Pass (Output the same as input aspect ratio)
 12F12->12P16 4:3 > 16:9 PB
 16F16->12F12 16:9 FH > 4:3

Default setting is to Pass

Video

This selection allows various adjustments to be made to the processed signal.

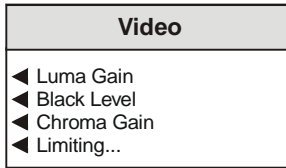

◀ Luma Gain

This selection reveals a numerical readout display for the gain of the luminance signal.

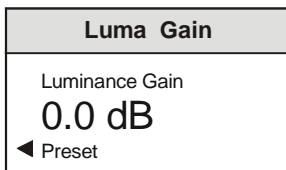

By using the scroll bar the gain may be adjusted by ±6 dB in steps of 0.1 dB.

Selecting Preset returns the setting to the calibrated value of 0.

◀ Black Level

This selection reveals a numerical readout display for the Y pedestal or black level.

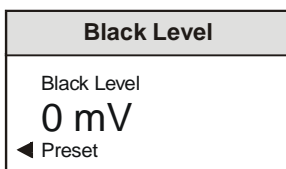

By using the scroll bar the pedestal may be adjusted by ±100 mV in steps of 0.8 mV.

Selecting Preset returns the setting to the calibrated value of 0.

◀ Chroma Gain

This selection reveals a numerical readout display for the gain of the chrominance signal.

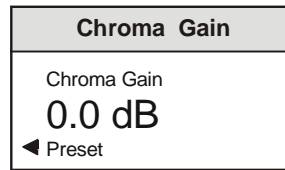

By using the scroll bar the gain may be adjusted by ±6 dB in steps of 0.1 dB.

Selecting Preset returns the setting to the calibrated value of 0.

◀ Limiting

This function allows Y and C signal excursions to be limited by setting minimum and maximum clipping levels.

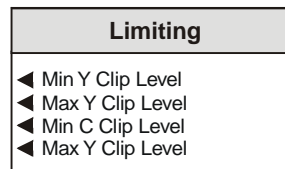

All adjustments are made in steps of 0.8 mV.

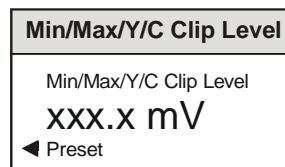

◀ Min Y Clip level

The minimum clip level for the luminance signal may be set between -50 mV and +49.2 mV

Preset value is -50 mV

◀ Max Y Clip level

The maximum clip level for the luminance signal may be set between +635 mV and +764.6 mV

Preset value is +764.6 mV

◀ Min C Clip level

The minimum clip level for the chrominance signal may be set between -400 mV and -200 mV

Preset value is -400 mV

◀ Max C Clip level

The maximum clip level for the chrominance signal may be set between +200 mV and +400 mV

Preset value is +400 mV

Mode

This function allows the overall operating mode of the IQARC00 to be selected.

Mode
<ul style="list-style-type: none"> ◀ Manual ◀ Auto ◀ MinDelay

◀ Manual

The picture size will respond to the parameters set by the manual controls.

◀ Auto

This enables the mode that automatically responds to the chosen version of wide screen Signaling or video index.

◀ Minimum delay

The picture size will respond to the parameters set by the Minimum Delay control settings.

Blanking

This function allows the left/right horizontal and the top/bottom blanking edges to be moved in both the input and output active picture.

Blanking
<ul style="list-style-type: none"> ◀ Input... ◀ Output... ◀ Std525 line21/283... ◀ VertEdgeFilt

◀ Input and ◀ Output

Input
<ul style="list-style-type: none"> ◀ Left Right ▶ ◀ Top Bottom ▶ ◀ Force to Black

Output
<ul style="list-style-type: none"> ◀ Left Right ▶ ◀ Top Bottom ▶ ◀ Force to Black

◀ Left/Right ▶

The Left/Right edge may be moved from 0 to 13.246 μ s of the picture width in steps of 148 ns.

Left/Right
Left/Right 5.000 μs ◀ Preset

◀ Top/Bottom ▶

The Top/Bottom edge may be moved from 0 to 200 lines of the picture height in steps of 1 line.

Top/Bottom
Top/Bottom 10 lines ◀ Preset

Std525 Line 21/283 (525 line systems only)

Std525 line21/283
<ul style="list-style-type: none"> ◀ Picture ◀ Closed Caption

This allows the selection of line 21/283 as a video line or closed captioning.

◀ Picture

Selects line 21/283 as a video line.

◀ Closed Caption

Selects line 21/283 as a closed caption line.
Note: When this option is selected the control of 'Input Blanking Top' should be manually set to be at least two lines to prevent closed caption appearing in the active picture.

◀ VertEdgeFilt

When selected a one line cross fade action is introduced on the horizontal edge transition between picture and blanking which helps to remove twitter.

Bypass

When enabled the input signal will pass through the electronics of the unit with everything at default settings.

Freeze

When selected the output will become a frozen frame picture.

User Mem

This function allows a number of particular setups of the IQARC00 to be saved and recalled. There are 16 memory locations available.

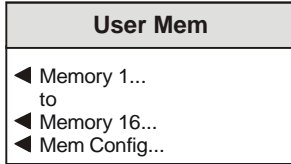

Selecting a memory location will reveal the memory display that allows the current settings to be saved to or recalled from that memory location. The memory location may also be given a specific name.

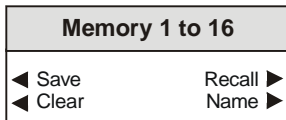

Save

This item will save the current settings in the memory location.

Recall

This function allows the saved settings (as selected by the **Mem Config/Memory Index** function) to be recalled.

Clear

This item will return the contents of the memory location to the default (factory) values.

Name

This selection allows renaming of the memory location.

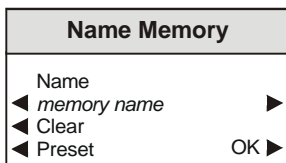

To compile/edit the text the right **▶** and left **◀** buttons adjacent to the upper text line in the menu should be used to select the character position in the text and the spinwheel used to select the character.

The **◀ Clear** function blanks out the selected character.

The **◀ Preset** function loads the default text, for example **Memory 1**.

O.K. ▶ saves the caption text and returns to the main menu.

Mem Config

This allows the parameters that are recalled, to be chosen.

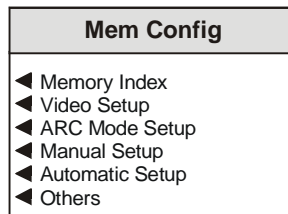

Memory Index

When a setup is saved at a particular memory location all parameters are saved.



When the memory location is recalled only the selected parameters from the list below will be recalled.

◀ Video Setup

◀ ARC Mode

◀ Manual Setup

◀ Automatic Setup

◀ Others

Any or all of these items may be selected.

The required memory location for the memory index function (Memory 1 to 16) should be selected using the spinwheel.

Setup

This item allows various functions to be set up.

Setup
<ul style="list-style-type: none"> ◀ WSS VI... ◀ Border Colour... ◀ Pattern & Caption... ◀ Output Routing... ◀ Standard... ◀ GPI/O ◀ RollTrack... ◀ Information... ◀ Default Out... ◀ Logging... ◀ Smooth Transitions... ◀ Terminology... ◀ Status... ◀ Unit...

◀ WSS VI (Wide Screen Signaling and Video Index)

WSS VI
<ul style="list-style-type: none"> ◀ Input... ◀ Output... ◀ Mapping...

◀ Input

This allows the parameters relating to the source of automatic aspect ratio control to be selected.

Input List
<ul style="list-style-type: none"> ◀ Input Source 625... ◀ WSS Input Type... ◀ VI InputType... ◀ AFD Input... ◀ WSS Waveform... ◀ Delete WSS line ◀ Read WSS Line ◀ VI CRCs...

◀ Input Source

Input Source
<ul style="list-style-type: none"> ◀ WSS ◀ VI

This function allows the fundamental type of Signaling that the unit will respond to.

◀ WSS Input Type

WSS Input Type
<ul style="list-style-type: none"> ◀ WSS ETSI ◀ WSS AFD

- ◀ WSS ETSI Wide screen signaling (European Telecommunications Standards Institute)
- ◀ WSS AFD Wide screen signaling Active Format Descriptor

◀ VI Input Type

VI Input Type
<ul style="list-style-type: none"> ◀ VI AFD ◀ VI SMPTE

- ◀ VI AFD Video Index Active Format Descriptor
- ◀ VI SMPTE Video Index SMPTE

◀ AFD Input

The Active Format Descriptor input may be chosen to be

AFD Input
<ul style="list-style-type: none"> ◀ AFD&ScanSys ◀ AFD only

- ◀ AFD & ScanSys Active Format Descriptor and the scan system used
- ◀ AFD only Active Format Descriptor only

◀ WSS Waveform

WSS waveform
<ul style="list-style-type: none"> ◀ Normal ◀ Non Standard

This item allows the unit to respond to wide screen Signaling waveform that is either

Normal or Non Standard

◀ Delete WSS Line

When selected this will delete the input WSS line.

◀ Read WSS Line

Read WSS Line
Read WSS Line 18 ◀ Preset

The wide screen Signaling data would normally be read from line 23; this item allows any line from line 7 to line 23 to be chosen.

◀ VI CRC's

VI CRCs
◀ Check AFD CRC ◀ Report All CRC

The Video Index Cyclic Redundancy Checksums may be selected to do the following:

- ◀ Check AFD CRC Check the Active Format Descriptor Cyclic Redundancy Checksum only and error if incorrect.
- ◀ Report All CRC Report all Cyclic Redundancy Checksums errors.

WSS VI (Wide Screen Signaling and Video Index)

◀ Output

This allows the output data parameters relating to automatic aspect ratio control to be selected.

OutputList
◀ WSS... ◀ Video Index ◀ Forced Mode... ◀ Set WSS User Bits ◀ Write WSS Line

◀ Output List

WSS
◀ WSS Type ◀ User Bits On ◀ Forced On

◀ WSS Type

WSS Type
WSSI Type Pass ◀ Preset

- Pass** If Wide Screen Signaling is present then regenerate the waveform with data unchanged otherwise delete the first half of selected line.
- ETSI** ETSI format WSS data will be inserted
- AFD** Insert WSS AFD only.
- AFD & SS** AFD and scanning system data will be inserted.
- Delete** All WSS data will be deleted.

◀ UserBits On

Inserts the user set enhanced WSS bits.

◀ Forced On

The appropriate values in forced mode will be output.

◀ Video Index

Video Index
◀ VI Type ◀ Pass non AR data ◀ Forced On

This selects what form of video index output signal is generated.

VI Type
VI Type Pass ◀ Preset

- Pass** When selected the input VI will be passed through the unit.
- AFD** Insert VI AFD only.
- AFD & SS** AFD and scanning system data will be inserted.
- SMPTE** SMPTE format VI data will be inserted
- Delete** All data will be deleted.

◀ **Forced Mode**

Forced Mode
<ul style="list-style-type: none"> ◀ ETSI ◀ AFD ◀ SMPTE

For each standard of Signaling select value to be inserted when in appropriate forced mode and correct standard.

ETSI/AFD/SMPTE
ETSI/AFD/SMPTE 4x3FF ◀ Preset

◀ **Set WSS User Bits**

Set WSS User Bits
Set WSS User Bits 10 ◀ Preset

This sets the 4 bits of the enhanced WSS system

◀ **Write WSS Line**

Write WSS Line
Write WSS Line 18 ◀ Preset

The Wide Screen Signaling data would normally be written to line 23; this item allows any line from line 7 to line 23 to be chosen.

◀ **Mapping**

This function sets up how the unit responds to the input Signaling of the input standard.

Mapping
<ul style="list-style-type: none"> ◀ ETSI... ◀ AFD... ◀ SMPTE...

For each possible input Signaling setup the Aspect, Size, Pan and Tilt plus output Signaling is required.

ETSI/AFD/SMPTE
<ul style="list-style-type: none"> ◀ ETSI In ◀ None enabled ◀ ETSI Out ◀ AFD Out ◀ SMPTE Out ◀ Aspect... ◀ ByPass ◀ Recall ◀ Save ◀ Follow Online ◀ Preset All ◀ Preset

◀ **ETSI/AFD/SMPTE In**

This function provides a selection of each of the different input signals for ETSI/AFD/SMPTE.

ETSI/AFD/SMPTE In
ETSI/AFD/SMPTE In AFD4:4x3 ◀ Preset

For each of the input selections a definition of the output WSS/VI is defined using the ETSI/AFD/SMPTE output menus.

SMPTE/ETSI out
SMPTE/ETSI out AFD4:4x3 ◀ Preset

AFD out
AFD out AFD4:4x3 ◀ Preset

◀ Aspect

Aspect	
◀ Aspect	Size ▶
◀ Pan	Tilt ▶

◀ Aspect (Ratio)

Aspect
Aspect 1.500
◀ Preset

The output aspect ratio may be adjusted using this control.
The range of adjustment is from 0.5 to 2.0 in steps of 0.001.

Preset is to 1

◀ Pan

This will adjust the horizontal position of the output image.

Pan
Pan 60
◀ Preset

The range of adjustment is ± 3700 in steps of 1.

Size ▶

This will adjust the size of the whole image.

Size
Size 1.500
◀ Preset

Both vertical and horizontal size change together while maintaining the aspect ratio of the image.

The range of adjustment is from 0.5 to 2.0 in steps of 0.001.

Tilt ▶

This will adjust the vertical position of the output image.

Tilt
Tilt 1000
◀ Preset

The range of adjustment is ± 3000 in steps of 1.

None Enabled ▶

When selected this enables no input Signaling as an input type.

When not selected the unit holds the last good Signaling if input Signaling is lost.

◀ Bypass

When selected this function sets the unit to the bypass mode.

Recall

This function recalls the settings for the selected input Signaling value.

◀ Save

This function saves the settings of this function for selected input Signaling value.
Note that every input function must be saved individually.

Follow online ▶

When selected, changes made are applied to the picture regardless of input Signaling value. When not selected they are only applied when correct Signaling value is read.

◀ Preset All

This function presets all parameters for the selected WSS/VI type.

Preset ▶

This function presets only the selected input WSS/VI type.

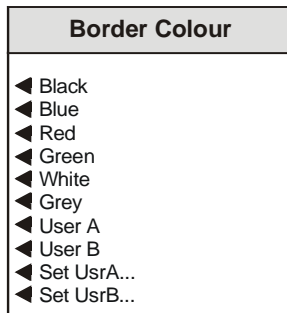
◀ **Border Colour**

This allows the **Border Colour** (the unused area outside the picture) to be selected.

Specific colours may be selected or two custom set-ups are available from User A and User B items.

Selections are:

Black
 Blue
 Red
 Green
 White
 Grey
 User A
 User B
 Set Usr A
 Set Usr B

◀ **User A and User B**

This selects either User A or User B

◀ **Set Usr A and Set Usr B**

This function allows custom settings of red, green and blue to be adjusted.



This function allows custom settings of red, green and blue to be adjusted using the spin wheel.

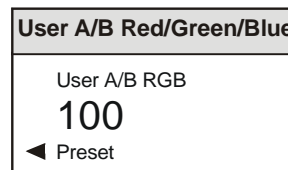

The range of control is from 0 to 255 units in steps of 1 unit.

Preset is to 0.

◀ Pattern & Caption

This item allows a pattern to be selected as the output, a caption to be setup and a character display of 10 lines to be displayed.

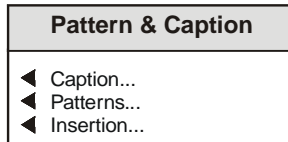

Note that the picture behind the caption will appear at half amplitude luminance.

◀ Caption

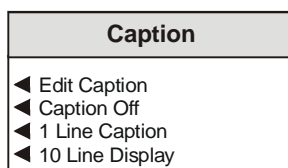

◀ Edit Caption

A 1 line caption of 19 characters may be set up by editing the text string.

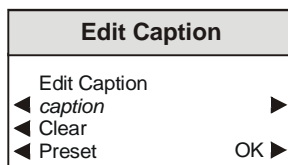

Preset is IQARC00

The caption may be selected as

◀ Caption Off

The caption will not appear

◀ 1 Line Caption

The 1 line caption will appear as set up by the Edit Caption function

◀ 10 Line Display

The 10 lines display will appear. This is an automatically generated display of current input and output status.

The first line of this display is the same as the 1 line caption text.

◀ **Pattern**

This function will allow various patterns to be used as the output signal.

Pattern
◀ Enable Pattern
◀ Black
◀ EBU Colour Bars
◀ 100% Colour Bars
◀ Ramp
◀ Multiburst
◀ Pulse & Bar
◀ Green

◀ **Enable Pattern**

When this item is selected a pattern from the list, will become the output signal.

Note: if patterns and caption are turned on at the same time then the pattern will default to black.

◀ **Insertion**

This item allows the pattern, caption and display to be inserted into either the Processed path or the Unprocessed path or both.

Insertion
◀ Processed Path
◀ Unprocessed Path

◀ **Output Routing**

This function allows what type of signal that appears at the three Monitoring outputs.

Output Routing
◀ Monitoring Output...

◀ **Monitoring Output**

This function allows the monitoring output signal path to be selected.

Monitoring Output
◀ Processed
◀ Unprocessed

◀ **Processed**

The signal will be fully processed path with aspect ratio, procamp, Signaling etc. controls enabled.

◀ **Unprocessed**

The unprocessed path is the input signal with optional OSD, pattern and signaling.

◀ **Standard (Input Standard)**

This allows the input standard to be selected.

Standard
◀ 525 625 ▶

◀ **525**

If only this item is selected the unit will be forced to only accept a 525 line standard

625 ▶

If only this item is selected the unit will be forced to only accept a 625 line standard

If both 525 and 625 are selected the unit will automatically operate at the incoming line standard.

If neither of the items are selected the unit will remain in the state of the last selection.

◀ **GPI/O**

This item allows the GPI connections to be configured.

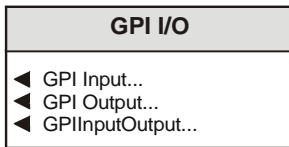

◀ **GPI Input**

This item reveals the GPI input configuration menu.

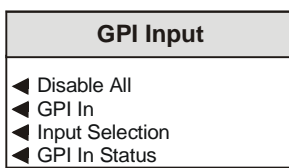

◀ **Disable All**

When selected all GPI functions will be disabled.

◀ **GPI In**

The GPI input may be selected using this item.

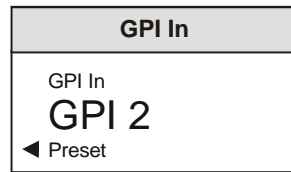

Selections available are:

- GPI 0 to 7
- GPI IN 0 to 3

◀ **Input Selection**

The GPI input functions that may be selected using this menu.

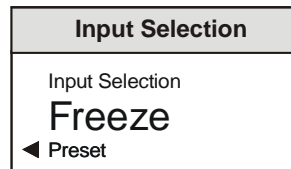

Selections available are:

- Unused The function not active. This is also the Preset Setting.
- Pattern ON The unit will produce a pattern output. Note that the caption function must be switched OFF.
- Freeze The unit will enter the freeze mode.
- Memory 1 to 16 The unit will use the settings stored in the selected memory location.

◀ **GPI In Status**

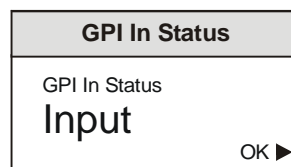

This will show the current status of the GPI input.

◀ **GPI Output**

This item reveals the GPI output configuration menu.

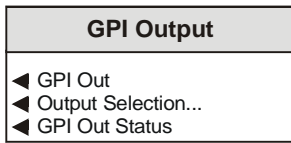

◀ **GPI Out**

The GPI output may be selected using this item.

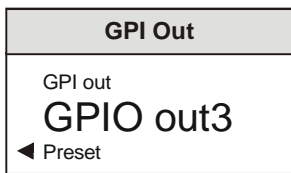

◀ **Output Selection**

The GPO may be configured to produce an output corresponding to one of the following conditions selected from this menu.

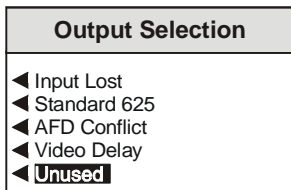

Input Lost	Produces a high TTL level output if the input signal is present
Standard 625	Produces a high TTL level output if the operating line standard is 625
AFD Conflict	Produces a high TTL level output if there is a conflict between WSS and VI AFD information.
Video delay	Produces a high TTL level pulse the length of which corresponds to the video delay through the unit
Unused	The function is not active (Preset setting)

◀ **GPI Input Output**

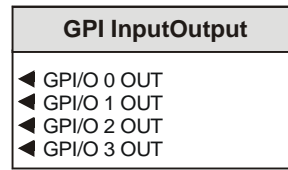

Four of the GPI inputs are configurable as GPI Outputs (GPI/O). When this is selected the corresponding GPI input is reconfigured as a GPI output.

◀ **GPI Out Status**

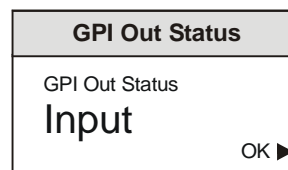

This will show the current status of the GPI output.

◀ **RollTrack**

This function allows information to be sent, via the RollCall™ network, to other compatible units connected on the same network.

For example, it can enable compatible audio delay units to produce an audio delay dependent on this and other similar units. The audio delay unit will dynamically follow or track the received delay-time information. This allows processed video signals to be timed correctly with audio signals. This automatic tracking system via the RollCall™ network is called **RollTrack**.

For more detailed information, see the RollTrack section (Appendix) at the end of this manual.

RollTrack
<ul style="list-style-type: none"> ◀ RollTrack Index ◀ RollTrack Source ◀ RollTrackDisable ◀ RollTrack Address ◀ RollTrack Command ◀ RollTrack Sending ◀ RollTrack Status

◀ **RollTrack Index**

RollTrack Index
RollTrack Index 10 ◀ Preset

This item allows up to 16 destinations to be selected.

◀ **RollTrack Disable**

When selected all RollTrack functions will be disabled.

◀ **RollTrack Source**

This allows the source of information that triggers the transmission of data to be selected.

RollTrack Source
RollTrack Source Video Delay ◀ Preset

Options are:

Unused	IN SMPTE 4/3
Video Delay	IN SMPTE 16/9
Input Present	IN SMPTE none
Input Missing	*WSS ETSI4/3FF
Standard 525	*WSS ETSI14/9C
Standard 625	*WSS ETSI14/9T
No AFD Conflict	*WSS ETSI116/9C
AFD Conflict	*WSS ETSI116/9T
IN ETSI 4/3FF	*WSS ETSI>16/9C
IN ETSI 14/9C	*WSS ETSISP14/9
IN ETSI 14/9T	*WSS ETSI16/9FF
IN ETSI 16/9C	*WSS AFD0 4/3 to
IN ETSI 16/9T	
IN ETSI >16/9C	
IN ETSI SP14/9	*WSS AFD0 16/9
IN ETSI 16/9FF	to
IN ETSI None	*WSS AFD7 16/9
IN AFD0 4/3	*VI AFD0 4/3
to	to
IN AFD7 4/3	*VI AFD7 4/3
IN AFD0 16/9	*VI AFD0 16/9
to	to
IN AFD7 16/9	*VI AFD7 16/9
IN AFD none	*VI SMPTE 4/3
	*VI SMPTE 16/9

*These refer to the signaling currently being outputted by the unit.

Note that ETSI 0 to 7 corresponds to the following ETSI signaling: 4/3 FF, 14/9 Center, 14/9 Top, 16/9 Center, 16/9 Top, >16/9 Center, SP 14/9, 16/9 FF respectively.

◀ **RollTrack Address**

RollTrack Address
RollTrack Address ◀ 0 ▶ ◀ Clear ▶ ◀ Preset ▶ OK ▶

This item allows the Rolltrack Address code to be set up using the adjacent push buttons to edit the text.

To edit the text the buttons adjacent to the upper text line in the menu are used to select the character position in the text and the spinwheel used to select the character.

(The right ▶ and left ◀ buttons select the cursor position and the spinwheel selects the character; the clear button sets the text line to all zero's and the OK button accepts the network address)

For more detailed information see the RollTrack section of this manual.

The full **RollTrack** address has four sets of numbers

For example: 0000:10:01*99

The first set (0000) is the network segment code number

The second set (10) is the number identifying the (enclosure/mainframe) unit

The third set (01) is the slot number in the unit

The fourth set (99) is a user settable ID number to help identify the sender in a multi-unit system

◀ **RollTrack Command**

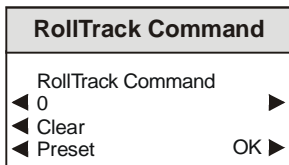

The full **Rolltrack** command has two sets of numbers.

For example: 84*156

The first set (84) is the **Rolltrack** command number

Note that only command numbers 14,15,16 and 17 should be used for audio delay

The second set (156) is the value sent with the **Rolltrack** command number

*Note that when video delay is selected as the **Rolltrack** source the value sent with the **Rolltrack** command is the video delay value not the value set*

For details of the RollCall command values for specific units please contact your local Snell & Wilcox agent.

◀ **RollTrack Sending**

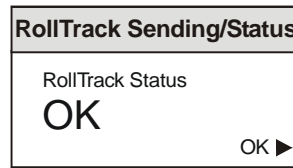

This item shows when the unit is actively sending the RollTrack command.

This may show:

- String A string value is always being sent.
- Number A number value is always being sent.
- No The message is not being sent.
- Yes The message is being sent.

Internal Type Error
Inconsistent behavior; please contact your local Snell & Wilcox agent.

◀ RollTrack Status

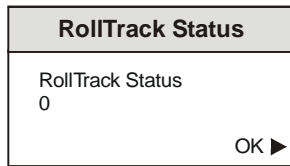

This item will display the status of RollTrack.

◀ Information

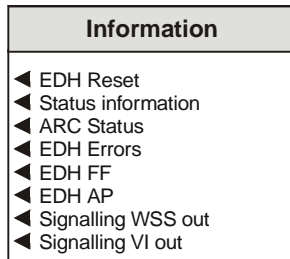

This item allows the type of data shown in the information window, to be selected.

Options are:

EDH Reset Resets EDH errors to zero

Status Information Shows the status of the unit
 e.g. FRZ BYP MIN PAT

Where FRZ = Picture freeze
 BYP= Unit in Bypass
 MIN = Unit in Min Delay mode
 PAT = Pattern On

ARC Status Shows the status of the
 aspect ratio conversion

EDH Errors Shows EDH Error seconds

EDH FF Shows Full Field checksum
*Note that field 2 checksum is
shown on the left and field 1
on the right of the display.*

EDH AP Shows Active Picture
 Checksum.
*Note that field 2 checksum is
shown on the left and field 1
on the right of the display.*

Signalling WSS out Displays the selected input
 Signaling and WSS output
 signaling

Signalling VI out Displays the selected input
 Signaling and VI output
 signaling

◀ Default Out

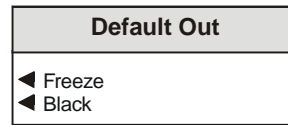

If the input signal fails the output may be configured to become either Freeze (a frozen picture) or Black.

Note that the default output for the unprocessed path will always be to black.

◀ Logging

If a logging device is attached to the RollCall™ network, information about various parameters can be made available to such a device.

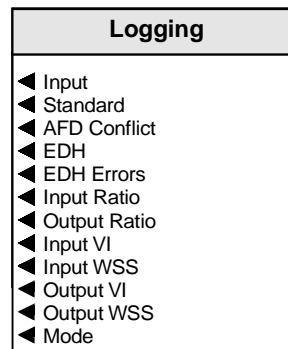

Any of the items may be selected from the list.

◀ Smooth Transitions

When the output picture size changes this function allows control over the way that the change of picture size occurs.

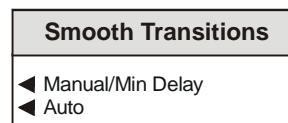

◀ Manual/Min Delay

When selected the picture size will change smoothly to the new size when the IQARC00 is in manual/Min Delay mode.

◀ Auto

When selected the picture size will change smoothly to the new size when the IQARC00 is in auto mode.

◀ Terminology

The notation used to express the aspect ratio may be chosen with this item.

Terminology
◀ WRT9
◀ PB/LB
◀ Ratio

◀ WRT9

Aspect ratio of active image area expressed as a two digit abbreviated numeric value where the comparison ratio is against a height of 9.
e.g. 12 is used for 4 by 3 (12 by 9).

◀ PB/LB

The visual effect of the image and display raster aspect ratios combined.
PB (Pillar Box) is full height but with black down the sides. LB (Letter Box) is full width with black top and bottom.

◀ Ratio

The aspect ratio expressed as a numerical ratio of width to height.

◀ Status

This item allows the status of selected parameters to be displayed.

Status
<ul style="list-style-type: none"> ◀ Input... ◀ EDH... ◀ ARC Status... ◀ Signalling...

◀ Input

Input
<ul style="list-style-type: none"> ◀ SDI ◀ Standard

This will allow the status of the SDI input signal and its line standard to be displayed.

SDI/Standard
SDI/Standard ??
OK ▶

◀ EDH

EDH
<ul style="list-style-type: none"> ◀ EDH ◀ Error Count

This will allow the status of EDH and the error count to be displayed.

EDH/Error Count
EDH/Error Count ??
OK ▶

◀ ARC Status

ARC Status
<ul style="list-style-type: none"> ◀ ARC ◀ Input Ratio ◀ Output Ratio ◀ Minimum Delay ◀ Bypass ◀ Pattern ◀ Freeze

◀ ARC Status Items

This will show the status of the selected ARC item.

ARC Status Items
ARC Status Items OK
OK ▶

◀ Signaling

Signalling
<ul style="list-style-type: none"> ◀ Input VI ◀ Input WSS ◀ VI CRC ◀ Output VI ◀ Output WSS ◀ Force VI ◀ Force WSS ◀ Follow On Line ◀ AFD Conflict log ◀ AFD Conflict

◀ Signaling Items

This will show the status of the selected signaling item.

Signalling Items
Signaling Items OK
OK ▶

◀ Unit

This item allows information about the unit to be displayed and other functions to be activated.

Unit
◀ Software Version ◀ Serial Number ◀ Preset Unit ◀ Restart ◀ Build No

◀ Software Version

Software Version
Software Version x.x.x OK ▶

This item shows the version of the software fitted in the module.

◀ Serial No.

Serial No
Serial No xxxxxxx OK ▶

This item shows the serial number of the module

◀ Build Number

Build Number
Build Number xxxxxxx OK ▶

This will indicate the factory build number. This number defines all parameters of the unit (software versions, build level etc.) for identification purposes.

APPENDIX 1 – Video Index and Enhanced Line 23

Video index is a signal embedded in the D1 output stream that can be used to convey aspect ratio information. The basic version of video index is described in SMPTE document RP186. An enhanced version of video index incorporating more aspect ratio information has been introduced in the United Kingdom for control of MPEG encoders. The IQARC00 supports both forms of video index and, they are referred to as SMPTE186 and AFD Spec' version throughout. (AFD is active format descriptor). The serial data format of the video index is described in SMPTE document SMPTE125M-1995.

In the United Kingdom, a modified version of line 23 Signaling which allows the embedding of the same information as that in AFD spec Video Index signals has been defined. The IQARC00 supports this AFD spec version of line 23 at both it's input and output. The new line 23 will be referred to as L23 AFD and the previous version of line 23 as L23 ETSI throughout.

Background Information on Video Index

The original SMPTE RP186 video index scheme includes in the very first data byte (Class 1.1 data Octet 1) a scanning system field. This can signal either 4:3 or 16:9 using the bottom 3 bits of the data byte as shown below.

Octet Value	Meaning	B2	B1	B0
0	no information	0	0	0
1	525/59.94 4:3	0	0	1
2	625/50 4:3	0	1	0
3	Reserved	0	1	1
4	Reserved	1	0	0
5	525/59.94 16:9	1	0	1
6	625/50 16:9	1	1	0
7-255	Reserved	1	1	1

Within Europe an extension to this data byte has been defined and is known as the ARDSPEC version. AFD being Active Region Descriptor. This retains the meaning of the bottom 3 bits of the data byte as 4:3 or 16:9 but in addition, it defines the meanings of the next 3 bits as follows.

Active format	Intended aspect ratio of active region	B5	B4	B3
0	Active region is same as coded frame	0	0	0
1	4:3	0	0	1
2	16:9	0	1	0
3	14:9	0	1	1
4	Reserved for future use	1	0	0
5	4:3 with shoot-and-protect 14:9 centre	1	0	1
6	16:9 with shoot-and-protect 14:9 centre	1	1	0
7	16:9 with shoot-and-protect 4:3 centre	1	1	1

The enhanced version of Line 23 (L23 AFD) basically embeds the same information in the line 23 data. i.e. the Scanning system and AFD fields. In addition, it provides four User bits.

The IQARC00 can read incoming aspect ratio Signaling and output it. This means that the aspect ratio conversion it performs can be automatically controlled by the incoming video signaling. It is possible to program the action that the IQARC00 takes for each of the incoming Signaling values.

Frame accurate timings include:

1. Output picture Size.
2. Output picture Aspect ratio.
3. Output picture Horizontal position.
4. Output picture Vertical position.
5. Output line 23 signal.
6. Output video index signal.

The video index information is inserted on line 11 and 324 for 625 line systems and lines 14 and 277 for 525 line systems.

Manual Revision Record

Date	Version No.	Issue No.	Change	Comments
290405	1	1		First Issue released
050505	1	2	To GPI timing text and drawing	New issue released
150307	1	3	RollTrack source list amended	New issue released
210808	1	4	New software version	New issue