

# IQBAAI 4 Channel Analog Embedder



### Module Description

The IQBAAI inserts two analog stereo audio pairs, or four mono channels, into a SDI (270 MBit) video stream. Each audio input is sampled at 48 kHz synchronous to video with 24-bit ADCs, the 20 MSBs being embedded. The audio input may be set to terminate at 600 Ohms or >10k Ohms and is factory set to accept +24 dBu input for full scale. Insertion may be set to any group independently for each stereo pair. Existing embedded audio groups may be renamed or tagged for deletion.

If there is insufficient ancillary data space remaining then existing data may be removed. Insertion is fully compliant with SMPTE 291M and SMPTE 272M-A. The minimum standard implementation of the AES control channel is supported. Four IQBAAI cards may be connected in series to insert all 16 audio channels. The SDI input is equalized to >200 m of cable and two SDI outputs are provided. Full EDH monitoring and re-insertion is included. All audio connections are via a 25 way D connector

### REAR PANEL VIEWS

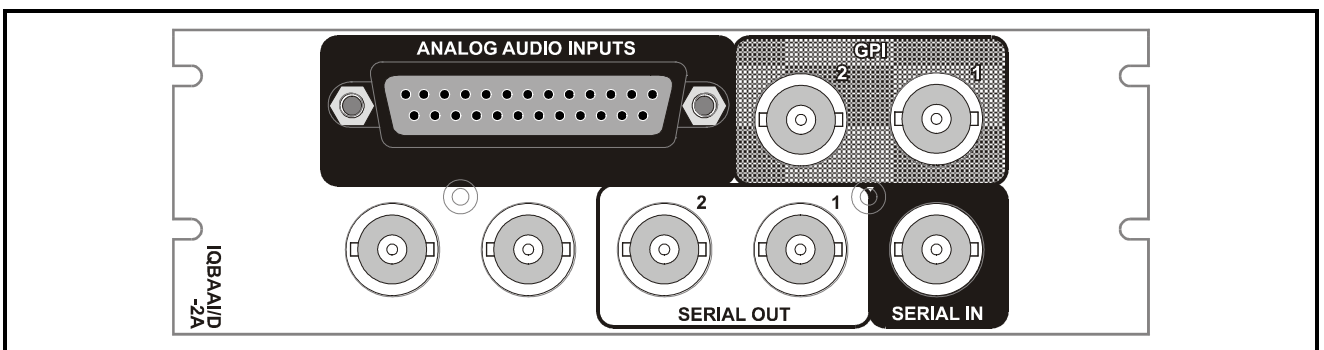
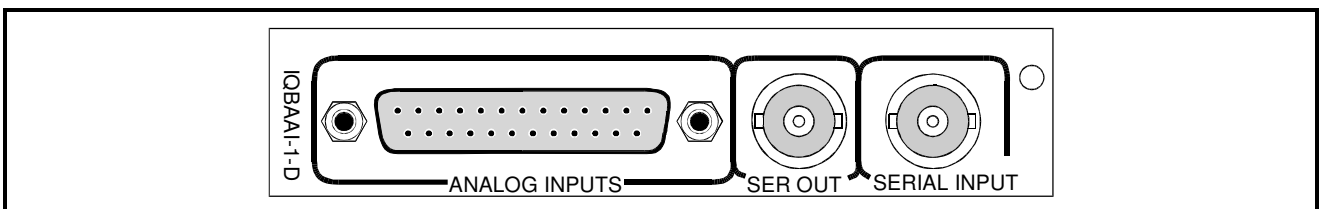
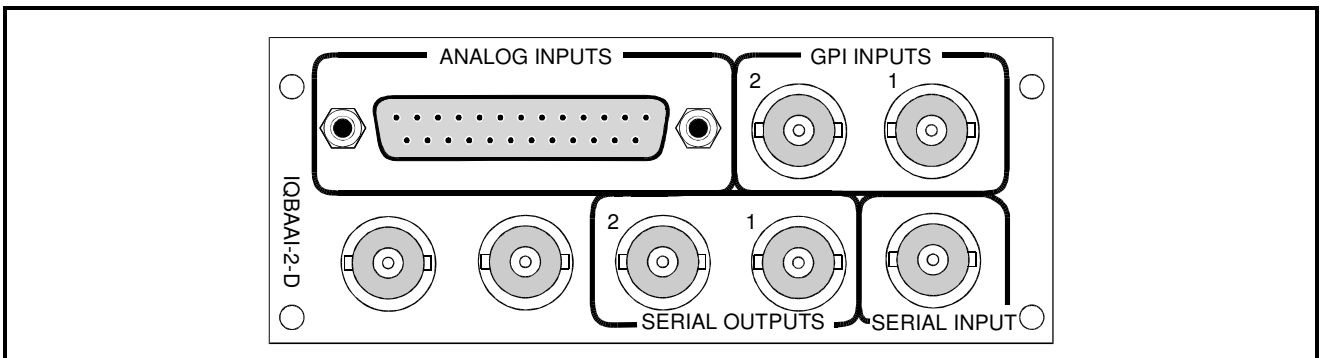

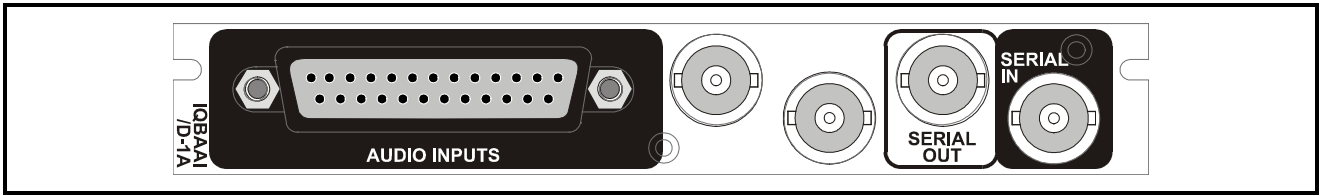

Versions of the module cards available are:

IQBAAI-2-D-0	Analog Audio Inserter Balanced	Double width module
IQBAAI-1-D-0	Analog Audio Inserter Balanced	Single width module
IQBAAI-2A-D-0	Analog Audio Inserter Balanced	Double width module
IQBAAI-1A-D-0	Analog Audio Inserter Balanced	Single width module

**Note that there are two styles of rear panels available. They are not interchangeable between the two styles of enclosures. However, the cards may be fitted into any style of enclosure.**

**‘A’ Style Enclosure**

Rear panels **with** the suffix A may only be fitted into the ‘A’ style enclosure shown below.

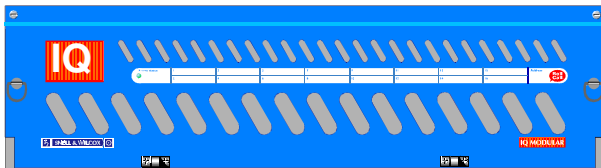

(Enclosure order codes IQH3A-E-0, IQH3A-E-P, IQH3A-0-0, IQH3A-0-P)

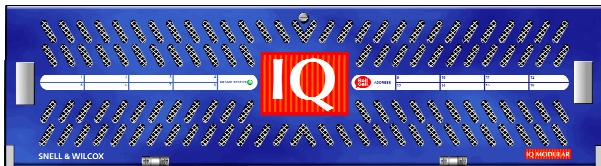

(Enclosure order codes IQH3A-S-0, IQH3A-S-P)

**‘O’ Style Enclosures**

Rear panels **without** the suffix A may only be fitted into the ‘O’ style enclosures shown below.

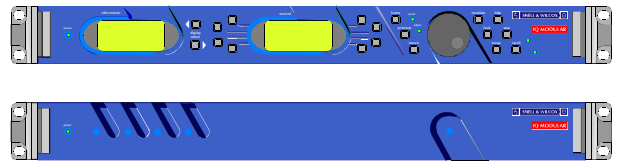

(Enclosure order codes IQH1S-RC-0, IQH1S-RC-AP, IQH1U-RC-0, IQH1U-RC-AP, Kudos Plus Products)

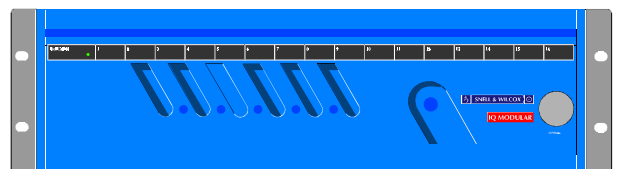

(Enclosure order codes IQH3N-0, IQH3N-P)



(Enclosure order codes IQH3U-RC-0, IQH3U-RC-P)

## Block Diagram

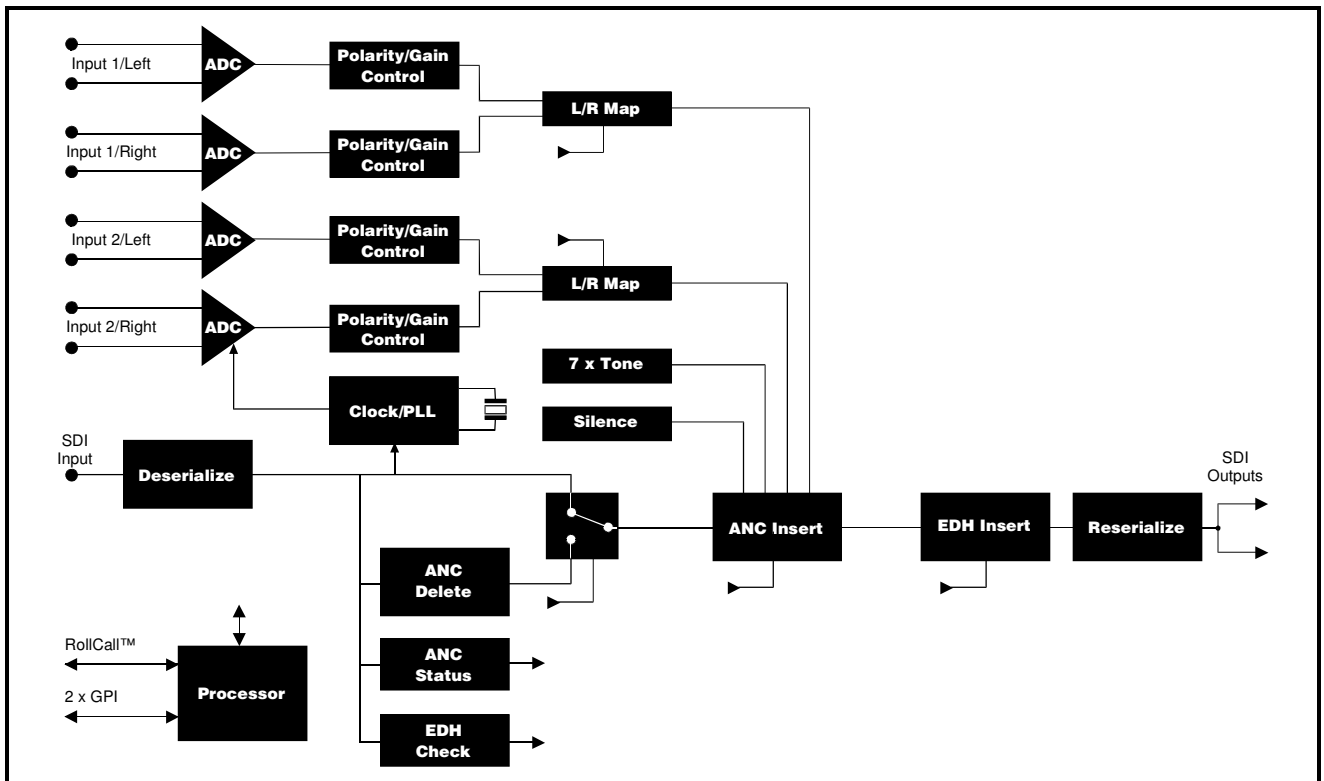

## Features

Inserts four analog channels into SDI video

- 1 / 2 (left/right) swapping
- Audio insertion group and pair selectable
- Preserves existing audio data
- 24-bit, 48 kHz audio sampling, -100 dB THD+N, 109 dB dynamic range typical
- Audio sample rate locked to video
- Automatic 525 and 625 line operation
- Input headroom level adjustable +1 to +24 dBu
- Gain control on analog inputs
- Independent input polarity invert selectable
- Eight selectable internal test tones
- Ancillary data space overflow indication
- Embedded audio presence indication
- EDH monitoring and Insertion
- RollCall control
- Two general purpose control inputs (GPI)

# Technical Profile

## Features

### Signal Inputs

Analog Audio .....	4 x Channels (2 Stereo Pairs)
Digital Video .....	1 x Serial Digital
GPI .....	2 x General Purpose Inputs
Standards .....	SMPTE 259M-C-1997, SMPTE 272M-A-1994

### Signal Outputs

Digital Video .....	2 x Serial Digital
Standards .....	SMPTE 259M-C-1997, SMPTE 272M-A-1994

### Card Edge Controls (also available via RollCall)

Input Assign.....	Assign to Stereo Pair, Test Tone or Silence
Strip ANC Data.....	Remove all ANC data before insertion
Select Tone/Silence Insertion	Select Test Tone or Silence for Insertion
Local/Remote Control Select	Local operation or via RollCall™ remote control
Analog Input Headroom Links	Preset Headroom for each input +24, +21, +18, +15 dBu

### Indicators

EDH Error History.....	Presence/Minute/Hour
No D1 .....	Loss of SDI D1 Input
ANC Error.....	Checksum Errors in Embedded Ancillary Data
ANC Full .....	No Space Left for Embedding
Insertion Status .....	Operational Status of Embedded streams

### Functions available via RollCall only

Re-assign .....	Re-assign Existing Embedded Audio
Reporting.....	Audio Data Channels Present
Map Channels .....	Map Selected Pair
Polarity Invert .....	Invert Polarity of Selected Input
Tone Selection .....	8 Internally Generated
Input Gain Control .....	±14 dB in 0.1 dB steps
Attempted Insertion .....	Report Failure
EDH Error History .....	Errors & time since last reset.
Line Standard Reporting.....	Report 525 or 625
Naming.....	Naming of each Audio Channel (User reference only)

## Specifications

Serial Input Return Loss ....	Better than 15 dB to 270 MHz
Serial Output Return Loss..	Better than 15 dB to 270 MHz
Analog Audio Inputs.....	Gain Adjustable ±14 dB via RollCall
Preset Headroom .....	+24, +21, +18 and +15 dBu
Input Impedance.....	>10 k ohm, selectable 600 ohm Termination
THD + Noise .....	-100 dB (0 dB Additional Gain, Full Headroom used)
Dynamic Range .....	105 dB (0 dB Additional Gain, Full Headroom used)
Audio Delay .....	1.4 ms
Video Delay .....	0.75 µs
Sampling .....	24-bit, 48 kHz synchronous to D1 video stream (20 MSBs inserted)

## Power Consumption

Module Power Consumption 7.4 W max

**INPUTS**

Balanced analog input connections are made via this 25 way female D-type connector. (-2-D and -1-D versions)

For connection data consult the tables on page 6.

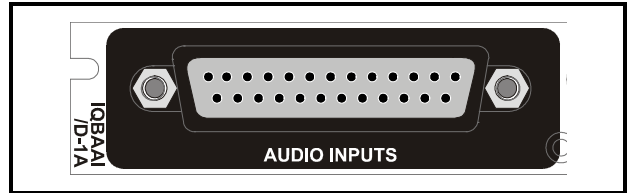
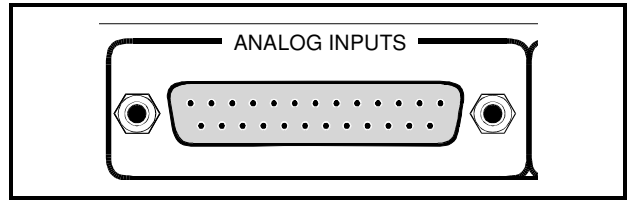

**Serial Digital Video Input**

The serial digital input to the unit is made via this BNC connector which terminates in 75 Ohms.



**GPI INPUTS**

These two GPI connectors are used for accepting GPI information (from mechanical switch contacts, relay contacts etc.)

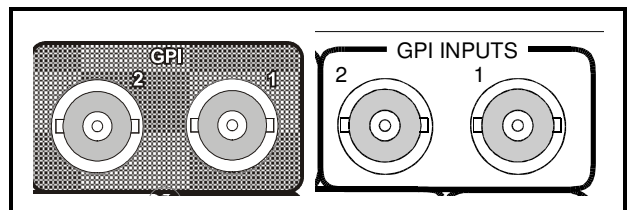

**OUTPUTS**

**Serial Digital Video Outputs**

These are the two (-2-D) or one (-1-D) isolated Serial Digital outputs of the unit via BNC connectors for 75 Ohms.

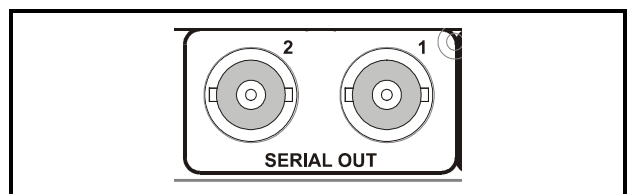
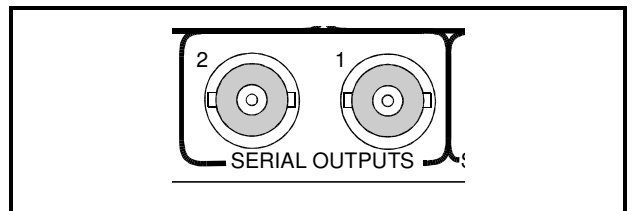

## INPUT IMPEDANCE

Each input may be terminated by 600 Ohms by the fitting of a link, as shown opposite.

If the link is not fitted the input impedance will be greater than 10 K Ohms.

## INPUT ATTENUATION

Each input may be attenuated by the fitting of links, as shown opposite.

## ANALOG INPUT HEADROOM

The analog input 'headroom' indicates the level of peak audio that can be applied before the A-to-D converters clip at their full-scale output.

The outputs of the A-to-D converters can have up to +14 dB of additional gain applied via RollCall, independently for each channel. Adding gain in the digital domain will result in the digital signal clipping before the analog input exceeds the A-to-D converter limits, thus the effective input headroom will be reduced.

For example, if the analog input attenuator is set for +24 dBu headroom and an additional gain of +10 dBu is applied the digital signal will clip when the analog input is at only  $24-10 = +14$  dBu.

In this way the system operating headroom may be adjusted by simply adding gain in the digital domain, however this effectively reduces the number of bits available for representing the analog signal, therefore reducing the overall THD+N performance.

+10 dB of gain will typically reduce the THD+N performance by 6 dB.

To offset this THD+N loss when lower system headroom is required each ADC input attenuator has two preset links, providing four commonly used headroom settings of +15 dBu, +18 dBu, +21 dBu and +24 dBu. These are coarse attenuations and for accuracy their settings should be entered under RollCall so that a calibration correction can be applied.

The combination of coarse attenuator links and gain control in the digital domain via RollCall allows the operating headroom for each analog input to be set anywhere between + 1 dBu and +24 dBu, with 0.1 dB resolution.

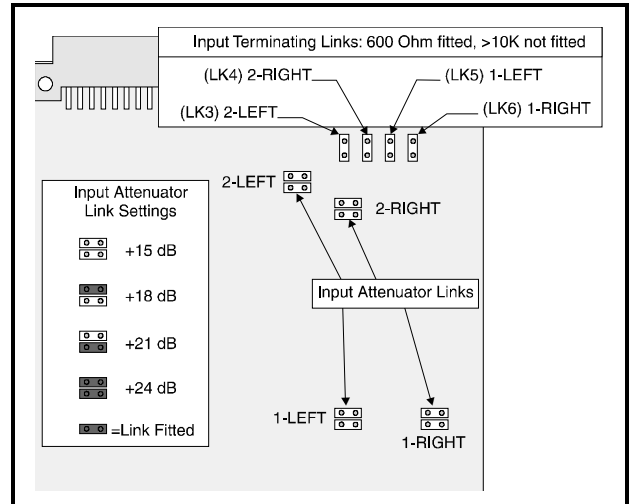

### Practical setting of the card attenuation links and the headroom level control.

For a particular system setup proceed as follows:

1. Decide on a headroom value for the left and right channels to suit the expected input signal levels.
2. Set the links to a headroom value closest to (but not below) the required headroom.
3. From the RollCall menu system select the **Links** item in the **Setup** menu. (See page 19 )
4. In the **Links** menu select each of the ADC channels in turn and set the value to the same value as the corresponding link setting.
5. Select **Return** on the front panel to enter this value.

This procedure will ensure that 0 dB Full Scale will be reached without clipping for maximum input signal levels.

Connection Details to XLR Female Connectors (for Balanced AES input versions)

25 Way D Connector Pin Number	Description	Ribbon Cable Strand Number	Standard Pin Assignment
1	Chassis	1	0V
14		2	GND1
2		3	1+
15		4	1-
3		5	2+
16		6	2-
4		7	GND2
17		8	GND3
5		9	3+
18		10	3-
6		11	4+
19		12	4-
7		13	GND4
20	INPUT B LEFT GND	14	GND5
8	INPUT B LEFT +	15	5+
21	INPUT B LEFT -	16	5-
9	INPUT B RIGHT +	17	6+
22	INPUT B RIGHT -	18	6-
10	INPUT B RIGHT GND	19	GND6
23	INPUT A LEFT GND	20	GND7
11	INPUT A LEFT +	21	7+
24	INPUT A LEFT -	22	7-
12	INPUT A RIGHT +	23	8+
25	INPUT A RIGHT -	24	8-
13	INPUT A RIGHT GND	25	GND8/CHASSIS

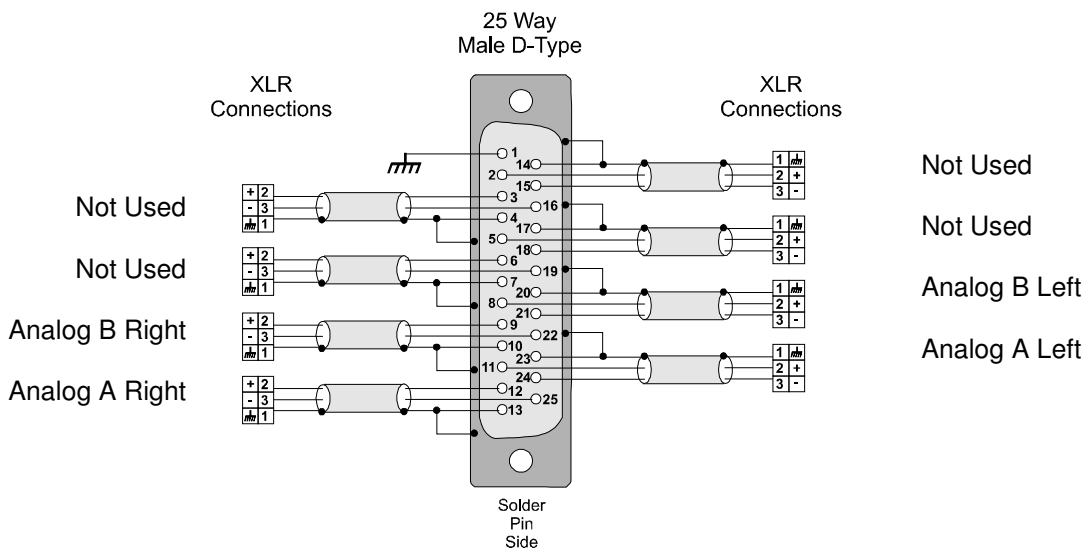

CARD EDGE CONTROLS

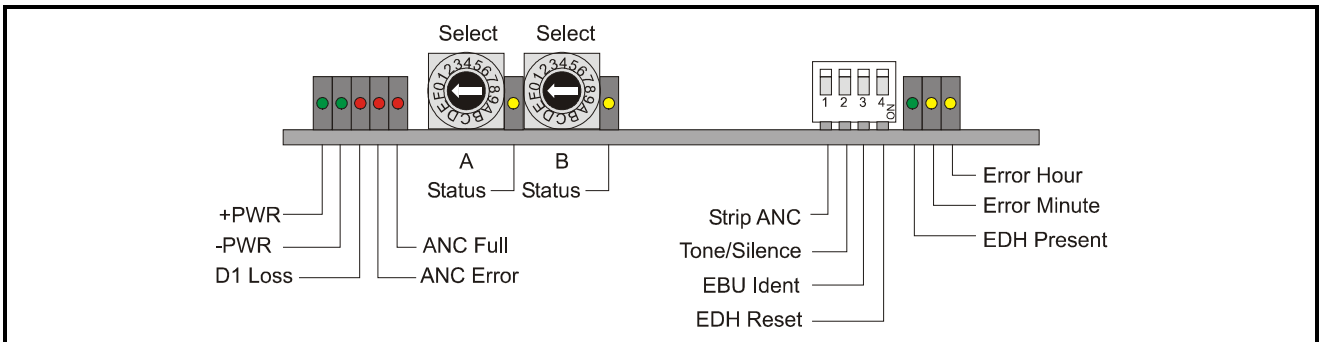

Note that the unit will respond to both local and remote control, one system overriding the settings of the other. For cards using the RollCall™ remote control system, activating these switches will override the remote control settings. The RollCall™ control panel will then follow these settings.

Note that in Main-frames where RollCall™ is not available the link LK2 (Remote) located near the CPU at the front of the card, should be set to the OFF (unconnected) position. This ensures that when the unit is powered-up the factory default settings of parameters not available as card edge adjustments, are loaded. With the link in the ON (connected) position card will power-up with the last settings sent by the remote control panel.

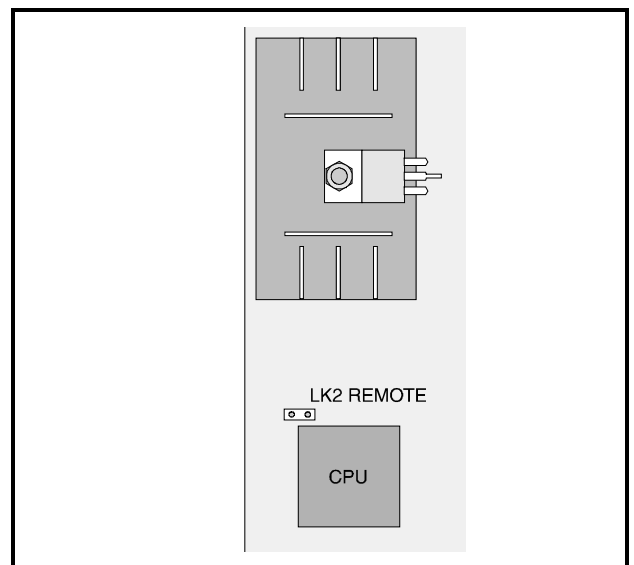

LED INDICATORS

Power

These two PWR indicators are illuminated when the positive and negative supplies are present.

D1 (Serial Video) Loss

This LED will become illuminated when there is no 4:2:2 input.

ANC ERROR

This LED will become illuminated for a short interval each time a checksum error is detected in the embedded ancillary data packets.

ANC FULL

This LED will flash when insufficient ancillary data space for audio insertion remains or for attempted insertion over existing audio.

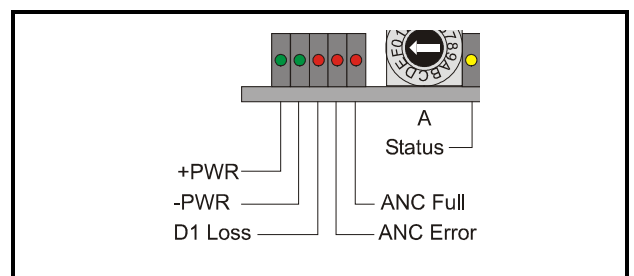



HEX SELECT SWITCHES

These switches assign embedding addresses to the inserter channels, and enable tone or silence insertion.

Settings are as follows:

1 to 8	Channel-Pair Assign
1	Pair 1
2	Pair 2
3	Pair 3
4	Pair 4
5	Pair 5
6	Pair 6
7	Pair 7
8	Pair 8
9 to 0	insert test-tone or silence, assignments as for 1 to 8 above

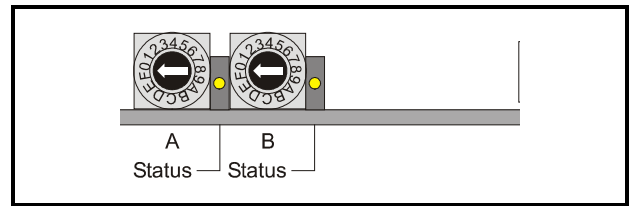

INSERTER PRIORITIES

In the event of channel-pair assignments clashing with each other and/or existing embedded data the conflicts will be resolved based on the following priorities:

Highest Priority: Embedded Data

Inserter B

Lowest Priority: Inserter A

If an inserter is disabled the associated status LED will flash.

STATUS LED's

These LED's will

1. **Become illuminated** when tone/silence is embedded at selected destinations (9....0)

**Flash** if selected destination is already occupied (inserter disabled)  
or  
insufficient ANC space left (inserter disabled)

2. **Will not be illuminated** if the inserter channel is embedding at selected destinations (1....8)

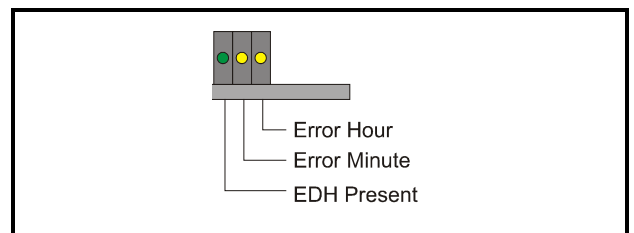

EDH PRESENT / ERROR

This LED will become illuminated if the input D1 video has embedded EDH data.

This LED will also briefly blink off whenever EDH errors are detected.

EDH MIN / HOUR

These LED's provide the EDH error minute & hour history, indicating occurrence of errors within their respective time periods.

These LED's will remain OFF if no errors have occurred within their time period, or if the incoming D1 video does not contain EDH data.

**4-WAY DIP SWITCH**

*Setting to the DOWN (ON) position enables the function.*

**STRIP ANCILLARY DATA**

Removes all ANC data prior to insertion

**TONE / SILENCE**

Selects tone (down) or silence (up) for insertion.  
(9 to 0 on the Hex switches)

**EDH RESET**

When enabled this will clear EDH error history.

**SMPTE 272M SUPPORT**

The cards conform to SMPTE 272M-A

A synchronous audio at 48 kHz; 20-bit audio data packets

The cards do not support  
SMPTE 272M-B, C, D, E, F, G, H, I, J

- B synchronous audio for composite video
- C 48 kHz synchronous, with audio & extended data packets
- D asynchronous audio
- E 44.1 kHz audio
- F 32 kHz audio
- G 32 kHz to 48 kHz continuous sampling rate range
- H audio frame sequence
- I time delay tracking (monitor only)
- J non-coincident 'Z' bits in a channel pair

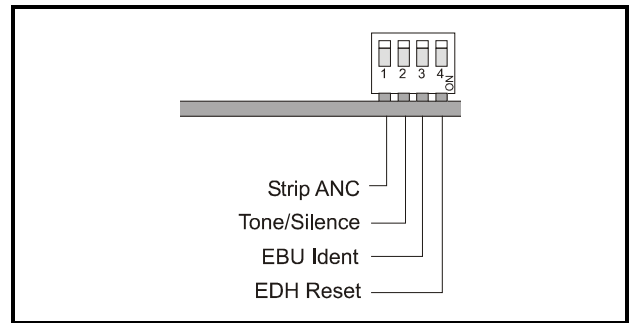

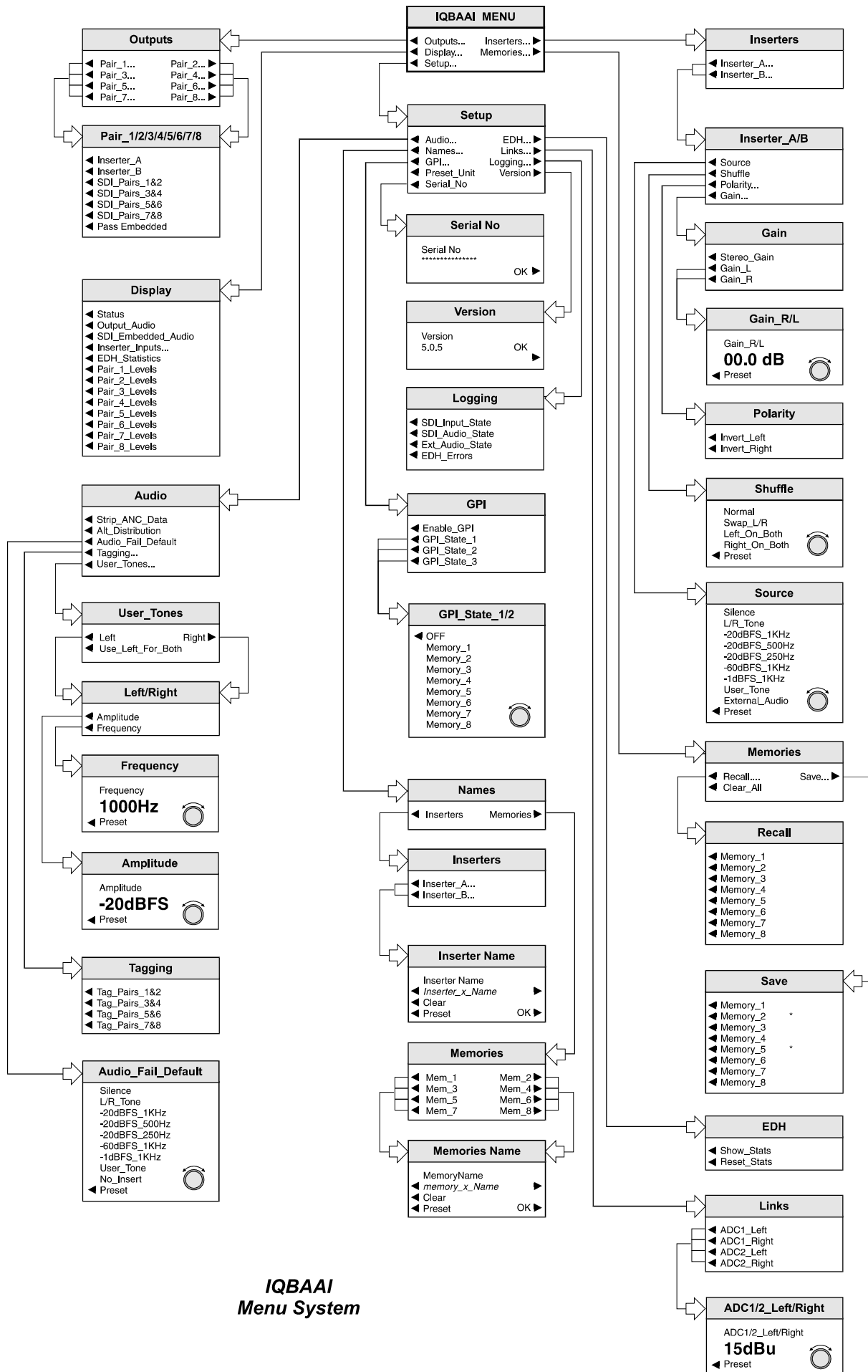

***IQBAAI  
Menu System***

**OPERATION FROM AN ACTIVE CONTROL PANEL**

The card may be operated with an active control panel via the RollCall™ network.

The menus available for this card are shown on page opposite and will appear in the Control display window.

Operational details for the remote control panel will be found in SECTION 1 of the Modular System Operator's Manual.

**MENU DETAILS**

(see IQ Menu System Opposite)

**MAIN MENU**

The main or top level menu allows various sub-menus to be selected by pressing the button adjacent to the required text line.

Note that where a menu item is followed by three dots (...) this indicates that a further sub-menu may be selected.

Whenever a menu item is selected the parameters of that selection will be displayed in the Information window of the front panel. Where the selection is purely a mode selection and does not enable a sub-menu, the text will become reversed (white-on-black) indicating that the mode is active. If the mode is not available for selection the text will remain normal.

**MAIN MENU**

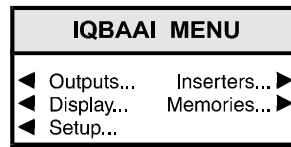

**◀ Outputs...**

This will reveal a sub-menu that will allow the assignment of any of the eight output pairs.

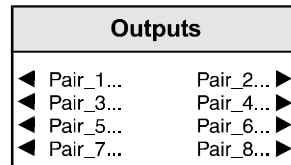

The pair should be selected and then the function chosen from the next menu.

**◀ Pair\_1/2/3/4/5/6/7/8**

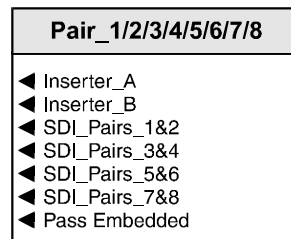

*Note that if an inserter is assigned to an output where audio data is already present on the SDI stream the inserter **will not** be enabled until that data has been moved or tagged.*

**Inserters... ▶**

The inserters may be independently selected and configured.

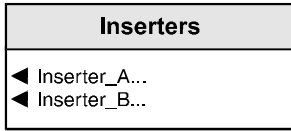

Either ◀ **Inserter\_A** or **B** may be selected.

Note that the inserter names may be renamed via the **Setup/Names/Inserters** function.

**◀ Inserter\_A/B**

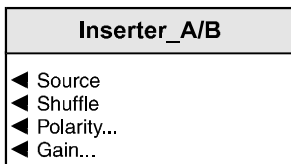

The resulting sub-menu will then allow the following options to be enabled:

**◀ Source**

The selected inserter may be set to the one of the signals from the following menu:

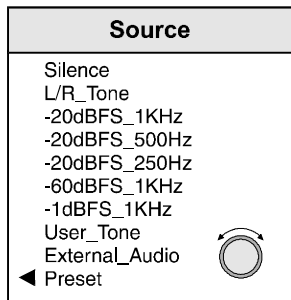

The **User\_Tone** is setup via the **Setup/Audio/User\_Tones** menu function.

Pressing the **Return** button on the front panel will select the value that is displayed in the window.

L/R\_Tone  
 Left = -20 dBFS at 1 kHz  
 Right = -20 dBFS at 500 Hz+2 kHz mixed

Preset selects external audio.

**◀ Shuffle**

This function reveals a sub-menu that allows the left/right channels of the selected inserter to be changed from normal to a different function.

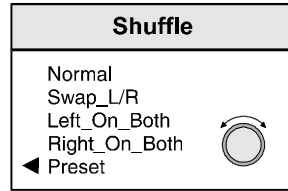

Preset is to Normal.

**◀ Polarity**

This allows the inversion of left and right signals of the selected inserter. (phase swapping of 180°).

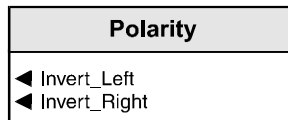

**◀ Gain**

This menu structure allows input gain to be adjusted. This only adjusts the gain of the analog inputs for inserters A and B.

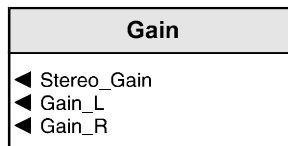

**◀ Stereo\_Gain**

When this item is selected the Left and Right gain controls will be locked together (ganged) such that the gain of both channels will be adjusted together and by the same amount.

**◀ Gain\_R/L**

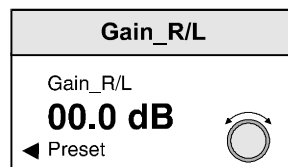

When **Gain\_Left** or **Gain\_Right** is selected a numerical display will appear and by operating the spinwheel the gain of the Left /Right channel may be adjusted. The range of adjustment is ±14 dB in steps of 0.1 dB.

Pressing the **Return** button on the front panel will select the value that is displayed in the window.

◀ **Display...**

This menu allows information about the selected item to be displayed in the Information LCD window.

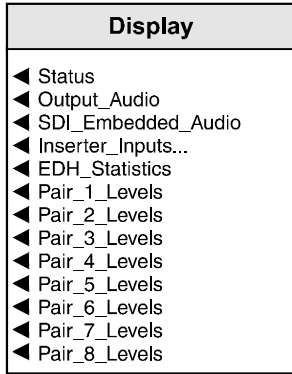

**Abbreviations used in the display**

General

SAD	Strip ANC Data
AFE	Ancillary Full Error
STD	Standard Distribution
ALT	Alternative Distribution

Inserters A B

(E)	External Audio
(T)	Tone
(S)	Silence
(P)	Pass Through
(t)	Tagged

**Memories... ▶**

This function reveals a sub-menu that allows 8 different settings of all items to be recalled from the 8 memory locations as saved in the Save function.

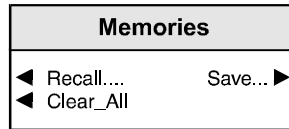

◀ **Recall...**

This function reveals a sub-menu that allows 8 different settings of all items to be recalled from the 8 memory locations as saved in the **Save** function.

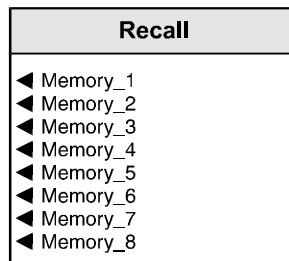

**Save ▶**

This function reveals a sub-menu that allows the settings of all items to be saved. Up to 8 different set-ups may be saved in the 8 memory locations

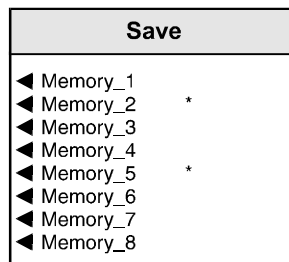

Note that if a memory location already contains saved data, an asterisk \* will appear to the right of the memory location number.

◀ **Clear\_All**

This selection allows all memory locations to be cleared and returned to their default (preset) settings.

*Note that the memory locations may be renamed via the **Setup/Names/Memories** function.*

◀ **Setup...**

This selection reveals a sub-menu that allows various functions to be set

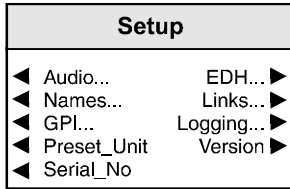

◀ **Audio...**

This allows audio functions to be set.

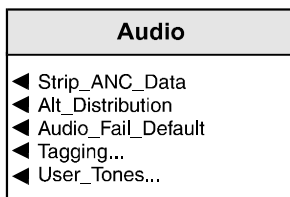

◀ **Strip\_ANC\_Data**

When set (text highlighted) this 'toggle' function will result in the stripping of all embedded ancillary data on the input D1 stream.

◀ **Alt\_Distribution (Sample packing)**

When highlighted the Alternative distribution scheme is enabled; when normal the Standard distribution scheme is enabled.

Embedded digital audio shares the SDI-D1 horizontal ancillary data space with other data packets.

Generally the positions of ancillary packets follow SMPTE-272 and can appear on any line, but there are industry-standard specifications and recommendations for some types.

The EDH packet, for example, must be on specific lines (5 & 318 for 625-lines, 9 & 272 for 525-lines) at specific positions within the data space.

Lines 6 & 319 (625, 10 & 273 for 525) are designated positions for SDI routers to switch streams.

Doing so will render the following ancillary space (next line) unusable due to the receiving SDI de-serialisers having to resynchronise to the new stream.

Lines 8 & 321 (625, 12 & 275 for 525) are the designated locations for the 'Audio Control' data packets, required if the embedded audio sample rate is anything other than video clock-synchronous

48 ksp/s. While these are quite small they do consume valuable ancillary space on these lines.

Embedders must avoid using the ancillary space following the SDI switch point. The presence of EDH data in a non-SMPTE272 standard position and the possible 'audio control' packets can also prove problematic for embedders since additional precautions have to be taken to avoid the possibility of corrupting horizontal ancillary space or even destroying the SDI-D1 format.

The IQBAAI module has two packet distribution schemes, selectable via RollCall.

◀ **Standard**

The Standard packet distribution does not use lines 5,6,7,8,318,319,320 and 321 for 625-lines and 9,10,11,12,272,273,274 and 275 for 525-lines. In this way it avoids problems with SDI switching, EDH packets, and audio control packets. However, the lack of audio samples for four consecutive lines each field does require that any subsequent de-embedders have sufficient FIFO buffer memory. For the 'standard' IQBAAI distribution scheme a de-embedder must buffer a minimum of 14 samples. The SMPTE-272 recommendation is for de-embedders to have a buffer of 40 samples but many designs will have less. Some may even not have enough buffer space for this sample distribution so an alternative scheme is available.

◀ **Alternative**

The Alternative distribution scheme is less secure in that it uses the lines defined as the locations for the audio control packets.

While the integrity of ancillary space and the SDI format will not be compromised there will be less space for audio data packets on these lines if the control packets are present

If the horizontal ancillary space is heavily loaded the embedder may not have enough space to insert all of its data. The 'alternative' scheme does not use lines 5,7,318,320 for 625-lines (9,11,272,274 for 525-lines). For this packing distribution a de-embedder must buffer a minimum of 6 samples.

Standard distribution is the default setting

◀ Audio\_Fail\_Default

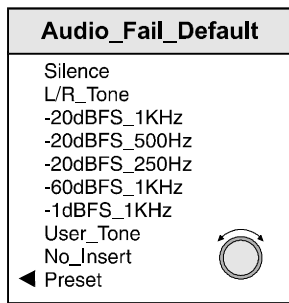

When the input is absent the output is set to this default signal.

This menu function defines the default signal to be inserted. It can be an internally generated signal, a user tone or to disable the inserter (No\_Insert).

L/R\_Tone

Left = -20 dBFS at 1 kHz

Right = -20 dBFS at 500 Hz+2 kHz mixed

Pressing the **Return** button on the front panel will select the value that is displayed in the window.

The factory preset is to

No Insert In non-RollCall mode (Link OFF)

No Insert In RollCall mode (Link ON)

◀ Tagging...

Normally the embedded audio is passed through the unit.

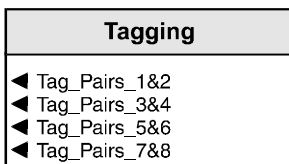

This function allows the data already present on a selected pair (text highlighted) to be disabled. For more details see page 29 **Inserter Operation**.

◀ User\_Tones...

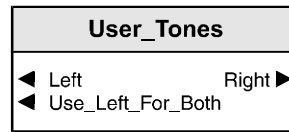

An audio tone may be selected for the inserters. The frequency and amplitude may be set for the left and right channels separately or the left settings used for both channels.

Selecting

◀ Left or Right ▶

will reveal a menu to allow the amplitude or frequency of the signal to be set.



◀ Amplitude

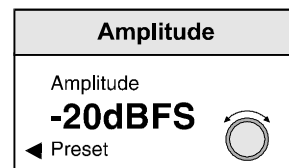

The amplitude may set from -100 dBFS to 0 dBFS in steps of 1 dBFS

Pressing the **Return** button on the front panel will select the value that is displayed in the window.

Preset value is -20 dBFS



◀ Frequency

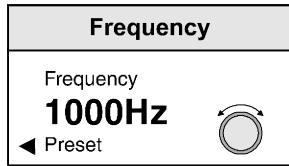

The frequency may set from 250 Hz to 20 kHz in steps of 250 Hz.

Pressing the **Return** button on the front panel will select the value that is displayed in the window.

Preset value is 1000 Hz

◀ EDH

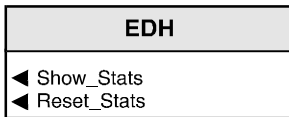

The input 4:2:2 stream is continuously monitored for EDH errors. Basic information on this can be monitored and/or reset here.

The following functions may be selected:

- ◀ Show\_Stats      The information will be displayed in the LCD window
- ◀ Reset\_Stats      Data will be reset

A regenerated EDH packet is inserted on the output 4:2:2 stream.

◀ Names

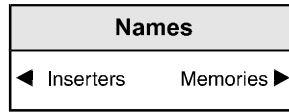

The inserters and the memories have default names. For convenience they can be given specific names.

To edit an Inserter name, select

◀ Inserters

This will reveal a menu that allows the inserter to be selected.

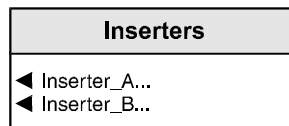

Select the desired inserter (this will reveal an editing window) and edit the name using the spinwheel/push buttons.

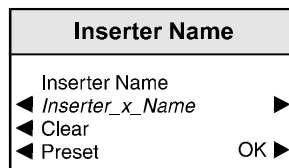

To compile/edit the text the right ► and left ◀ buttons adjacent to the upper text line in the menu should be used to select the character position in the text and the spinwheel used to select the character.

The ◀ **Clear** function blanks out the selected character.

The ◀ **Preset** function loads the default text.

**O.K.** ► saves the caption text and returns to the main menu.

To edit a memory location name, select

**Memories ▶**

This will reveal a menu that allows a memory location to be selected.

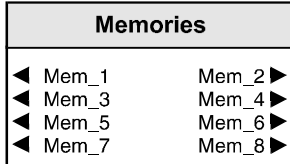

Select the desired memory location (this will reveal an editing window)

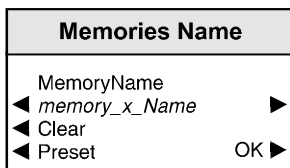

and edit the name using the same method as for naming inserters.

**Links ▶**

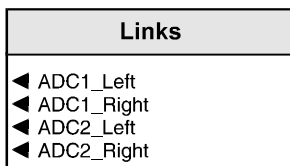

The input signal to the four ADC's may be set to one of four initial headroom values using links on the card. (See page 6) For internal calculations these link settings must be reported to the software via this menu.

The base headroom will be shown in the numerical display in dBu's. The value may be adjusted using the spinwheel and pressing the **Return** button on the front panel will select the value displayed.

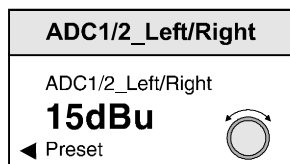

**◀ GPI...**

The two GPI connectors are used for accepting GPI information (from mechanical switch contacts, relay contacts etc.) The resulting action that the unit takes may be selected using this menu.

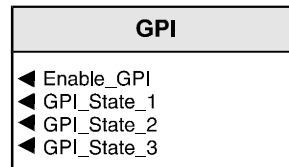

**◀ Enable\_GPI**

When highlighted this will make all GPI functions active.

**◀ GPI\_State\_1/2/3**

The two GPI inputs form a 2-bit binary coded signal producing the following action:

GPI 1	GPI 2	GPI State
Open	Open	Not valid
Closed	Open	GPI_State_1
Open	Closed	GPI_State_2
Closed	Closed	GPI_State_3

The three GPI states can be used to configure the unit to settings stored in a memory location. The desired GPI state should be selected from the GPI menu and then the memory location selected from the GPI\_State menu.

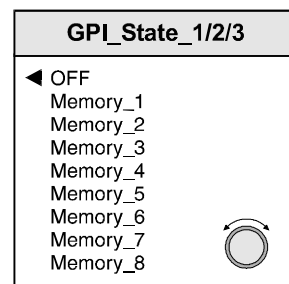

When the selected GPI state is activated the unit will be configured to the settings located in the Pressing the Return button on the front panel will select the location that is displayed in the window.

Alternatively, the function may be set to OFF and the unit will have no response to the GPI inputs. memory location chosen from this menu.

### Logging ►

If a logging device is attached to the RollCall™ network, information about various parameters will be reported to the logging device assigned in the Remote Control Interface system. (See Section 1, The RCIF Menu System)

The logging sub-menu allows the following information to be made available for logging:

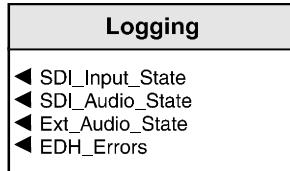

Factory preset is nothing enabled

#### ◀ Preset\_Unit

Selecting this item sets all adjustment functions that include a preset facility, to their preset values. Note that this is a momentary action and the text will not become reversed

#### ◀ Version

Selecting this item reveals a display showing the version of the software fitted in the module. Select OK to return to the Setup Menu.

#### ◀ Serial Number

Selecting this item reveals a display showing the serial number of the module. Select OK to return to the Setup Menu.

**RollCall Control via a PC**

*For full details please see the operator's manual for the IQSPCR, **RollCall™ Software Installation Guide & Operational Overview***

IQSPCR is a PC application that runs under Windows 3.1x or 95. It allows full remote control of RollCall for this and other compatible units.

**SOFTWARE INSTALLATION GUIDE**

**System Requirements**

The minimum requirement for installing the RollCall software is:  
 RollCall PC Control Software (IQSPCR).  
 IQ Modular 1RU or 3RU rack with Gateway card installed.  
 PC running Microsoft Windows 3.1x or Windows '95 .  
 Either a RollCall PC card (IQPC) or a RS232 to RS422 9 way converter fitted to the PC.

Connecting the hardware:

There are two choices for connecting the PC to the Modular IQ System:

1. 75 Ohm co-axial cable BNC for box-to-box connections running at 2.5 Mbs.

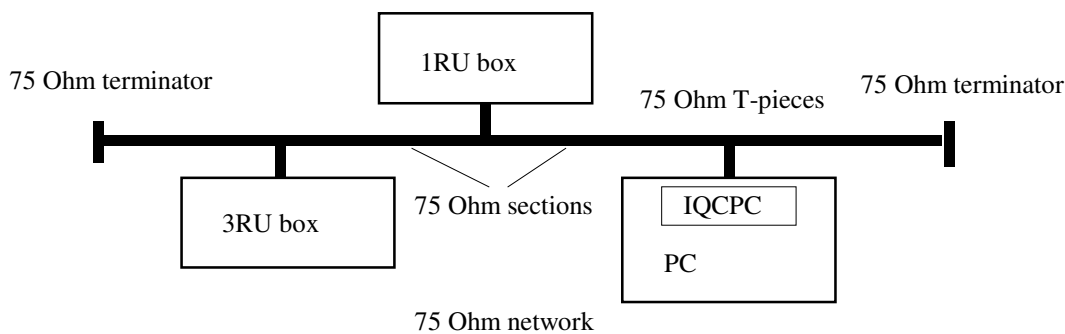

Each unit is physically joined via a T-piece connector. Each T-piece is connected by 75 Ohm co-ax cable to create a section. Each section of cable can be up to 400m. Each end of the network is terminated by a 75 Ohm terminator.

2. RS422 running at 38.4 kbs asynchronous:

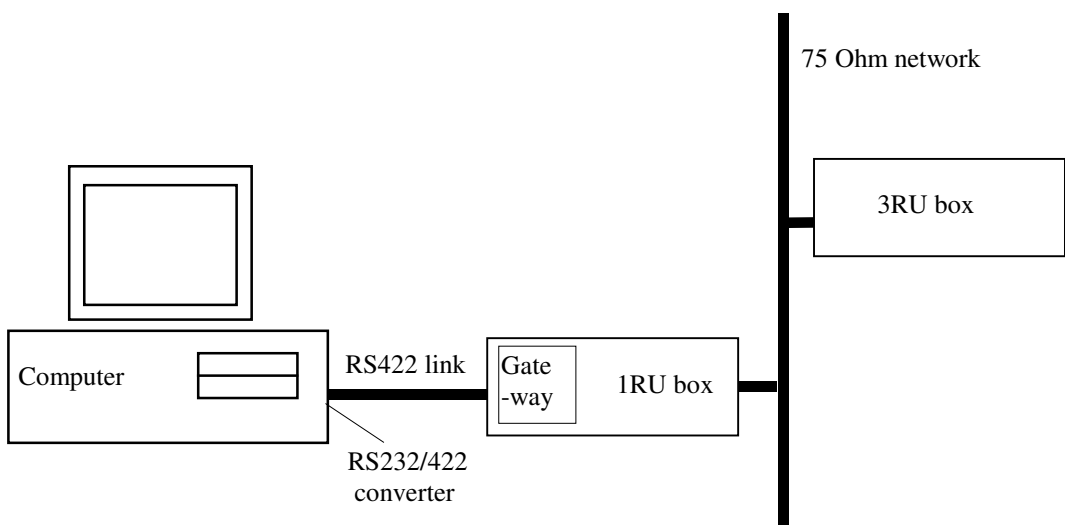

Connect the RS232/RS422 converter to COM1 or COM2 of the PC and connect this via RS422 cable to the 9 pin 'D' on the IQ modular unit. This interface is specifically designed for third party connections into the system. This allows PC's or any other serial device access to any of the units within the system. Every active 1RU or 3RU box has one of these ports.

**Physical Interface - RollCall RS422**

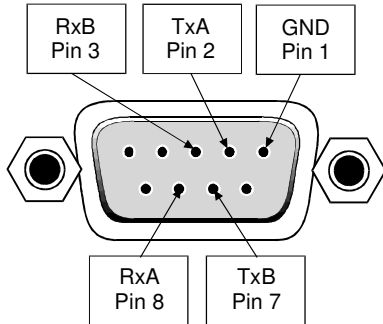

N.B. Connector is a socket, viewed from mating face. Equivalently, this is a plug, viewed from the rear, cable face.

For reference, the A signal is at 0V at line idle, and the B signal at 5V.

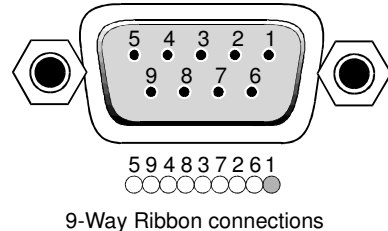

**Standard Connections**

9-way Connector	FUNCTION
1	Frame Ground
2	Transmit A (Tx-)
3	Receive B (Rx+)
4	Receive Common
5	[No connection]
6	Transmit Common
7	Transmit B (Tx+)
8	Receive A (Rx-)
9	Frame Ground

N.B. The D connector on the Gateway card could also be configured as RS485.

Selection of the interface format is by a switch on the card.

Note that RS485 interconnections should be pin to pin and only be used for Snell & Wilcox RollNet applications.

DOWN i.e. towards the PCB selects RS422

UP i.e. away from the PCB selects RS485

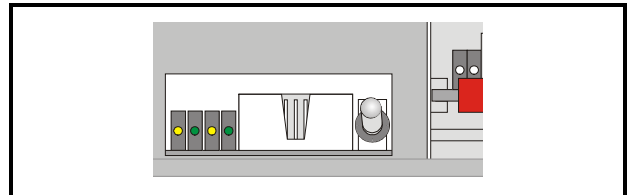

Switch set to RS485

## Software Installation

Run SETUP.EXE from the installation diskette to install the suite of Rollcall programs. Product code IQSPCR contains the Rollcall Remote Control (rollcall.exe) and communications driver (commtrol.exe) programs. Product code IQSPCD contains the Rollcall Remote Control (rollcall.exe), communications driver (commtrol.exe), logserver (rolllog.exe) and logviewer (rollview.exe) programs.

On startup, the setup program prompts for an installation directory. The default installation directory is C:\ROLLCALL. The set-up procedure will copy all the necessary files to this directory. Set-up will also create a Windows Group called RollCall.

Depending on the product code of the diskette, Either two icons (RollCall and Commtrol for IQSPCR) or four icons (RollCall, Commtrol, LogServer and LogViewer for IQSPCD) will appear in the group.

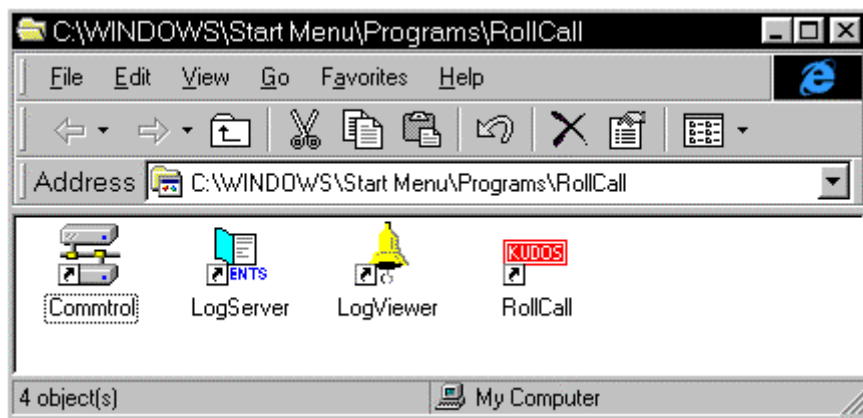

## Overview

### ROLLCALL.EXE:

This program allows control of RollCall compatible units. (IQ Modules, Supervisor, other S&W units with RollCall gateway). Each unit has a 'control template' window for control of that device. The user can configure the program for USER, ENGINEER or SUPERVISOR access levels with password protection. It can install "template" files from new units automatically or by user request.

### ROLLLOG.EXE:

This is the Log Server application that collects logging information from units on the network. Keeps a running log file of every event received. Writes a current status file for configured units and allows the LogViewer program to display the information.

### ROLLVIEW.EXE:

This program displays the current status file written by ROLLLOG.EXE in a tabulated form. Coloured conditions highlight warning and failure states. Can be configured for network access for remote monitoring using share information from the LogServer program.

### COMMTROL.EXE:

This program is called automatically by ROLLCALL.EXE or ROLLLOG.EXE and normally runs minimized. Usually, there is no need to run this program by itself. This program provides the basic communications with the PC card, serial comms ports or TCP/IP protocols. It also has monitoring facilities for data analysis.

**For more details see the operator's manual for the IQSPCR Section 3**

RollCall Control Templates for the IQBAAI

The first item in the menu is

**Control**

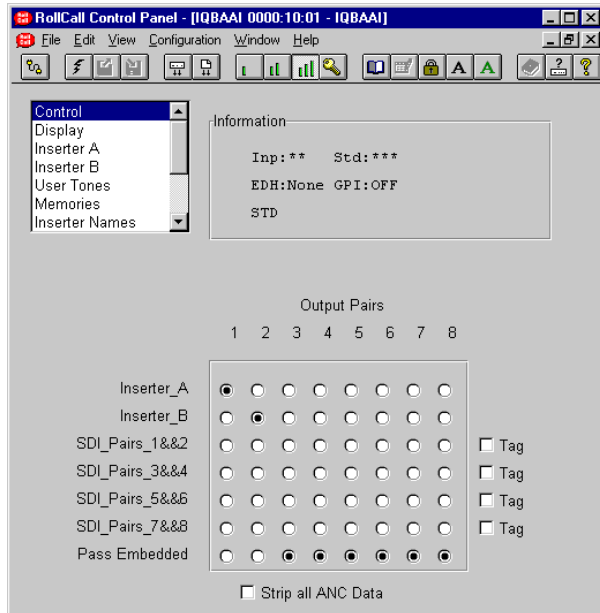

This allows the output pairs to be assigned various functions.

By clicking on the intersecting location in the matrix the function shown on the left of the matrix will be assigned to the output pair shown above the matrix.

The SDI pairs may also be tagged by enabling the **Tag** box (this function allows the data already present on a selected pair to be disabled)

Checking the **Strip all ANC Data** box will result in the stripping of all embedded ancillary data on the input D1 stream.

The **Information** area will show basic details of the operational status of the unit and will appear on all of the windows.

**Display**

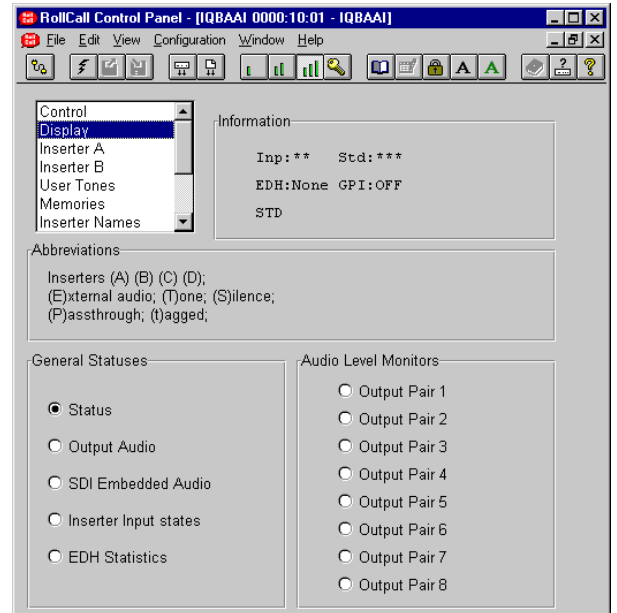

This allows information about the selected item to be displayed in the Information area.

**General Statuses**

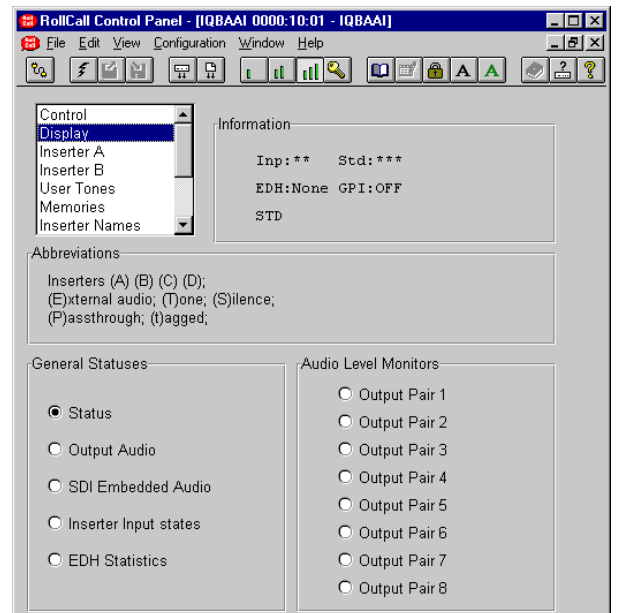

This will show basic details of the operational status of the unit.

Output Audio

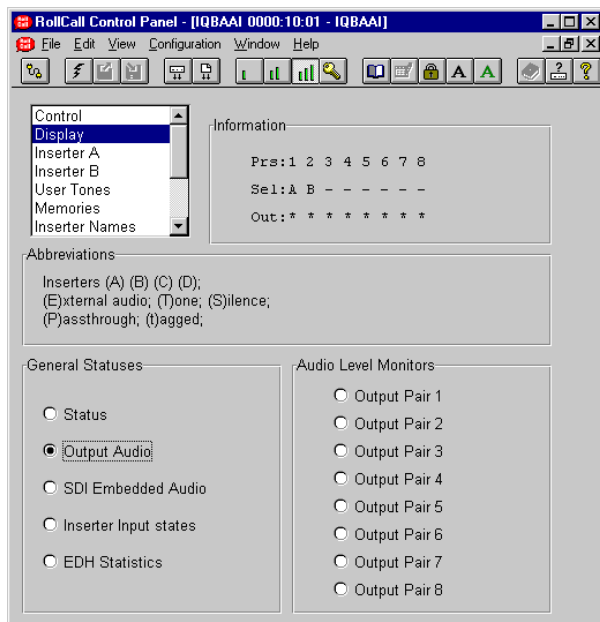

This function will present information about the output pairs 1 to 8, the selected inserters A to D and the type of output signal. The abbreviations used for this purpose are explained in this window.

Inserters Input States

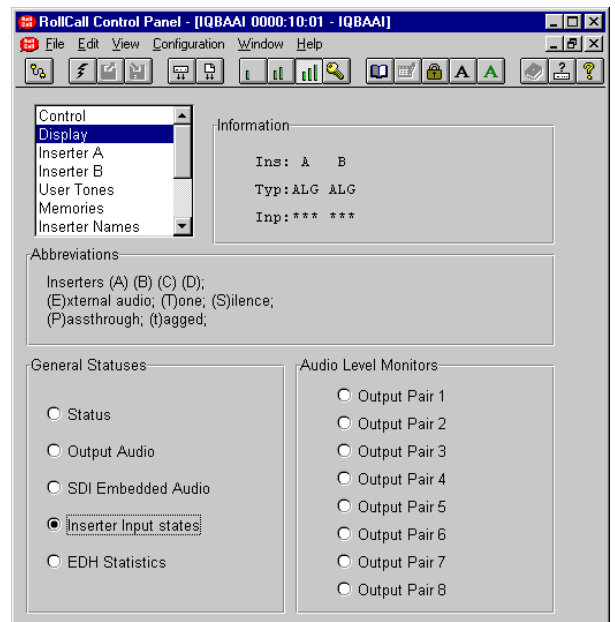

The Inserters A and B Input States are displayed with this function.

Abbreviations used for **Type** are as follows:

ALG Analog Signals

SDI Embedded Audio

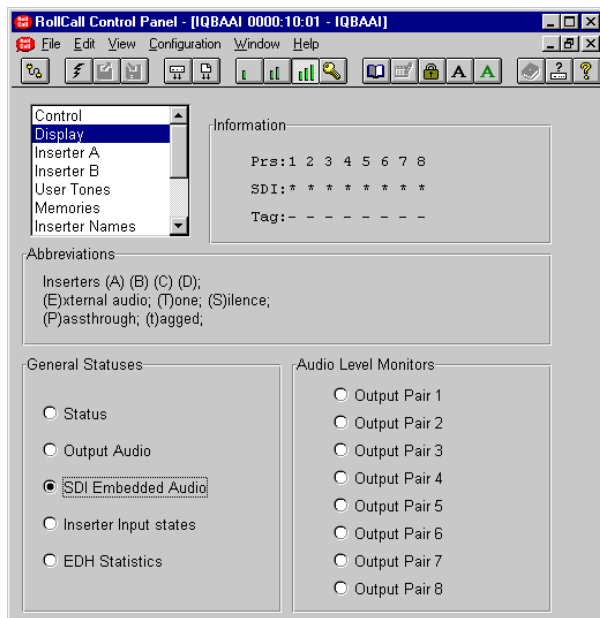

This function presents information about the SDI Embedded Audio in a similar way to Output Audio above.



EDH Statistics

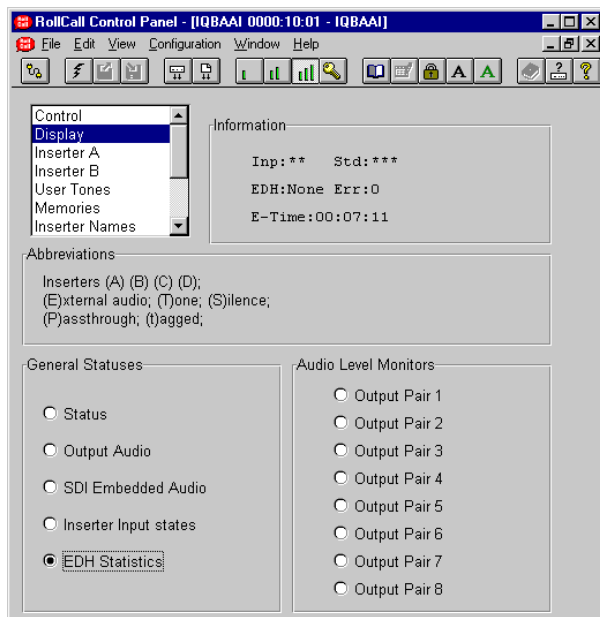

This function will display all EDH statistics including the presence of errors, the number of errors and the error time.

Audio Level Monitors

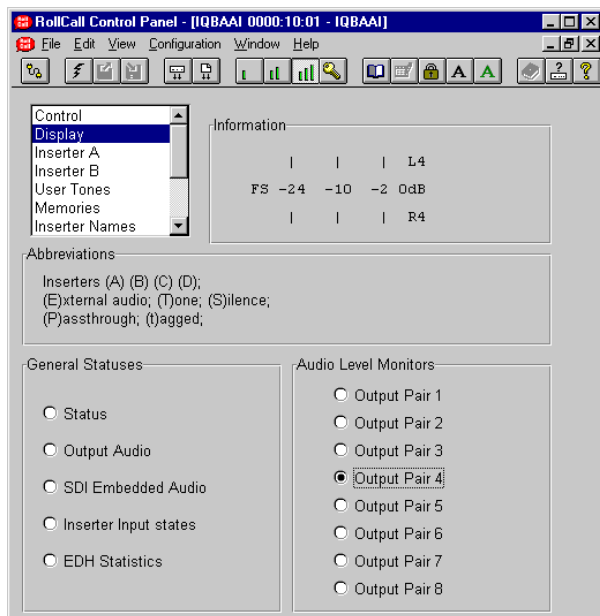

This function allows an output pair to be selected and the level in dB (for both left and right channels) to be displayed by a bargraph type display.

**Inserters A and B**

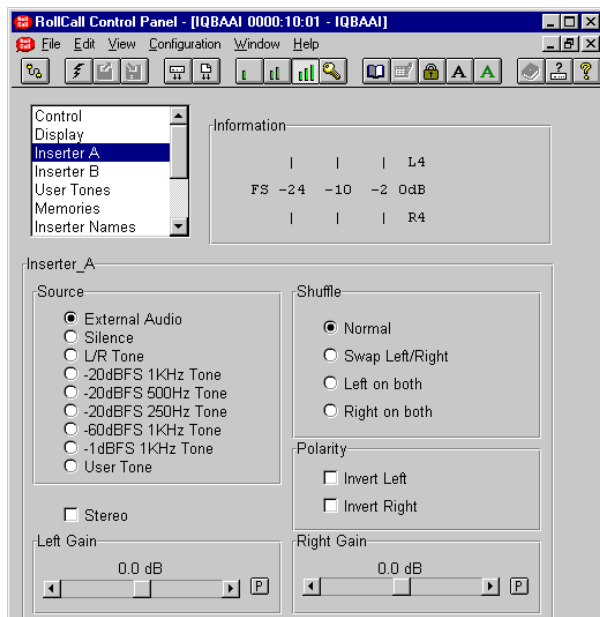

The inserters may be independently selected and configured. Either Inserter A or B may be selected.

**Source**

The selected inserter may be set to the one of the signals from the list.

The User Tone is setup via the User Tones function.

**Shuffle**

This function allows the left/right channels of the selected inserter to be changed from normal to a different function as shown in the list.

**Polarity**

This allows the inversion of left and right signals of the selected inserter. (phase swapping of 180°).

**Left Gain and Right Gain**

When Left Gain or Right Gain is selected the gain of the Left /Right channel may be adjusted using the scrollbar. The range of adjustment is from 0 to ±14 dB in steps of 0.1 dB.

Preset is to 0 dB

**Stereo**

When this item is selected the Left and Right gain controls will be locked together (ganged) such that the gain of both channels will be adjusted together and by the same amount.

**User Tones**

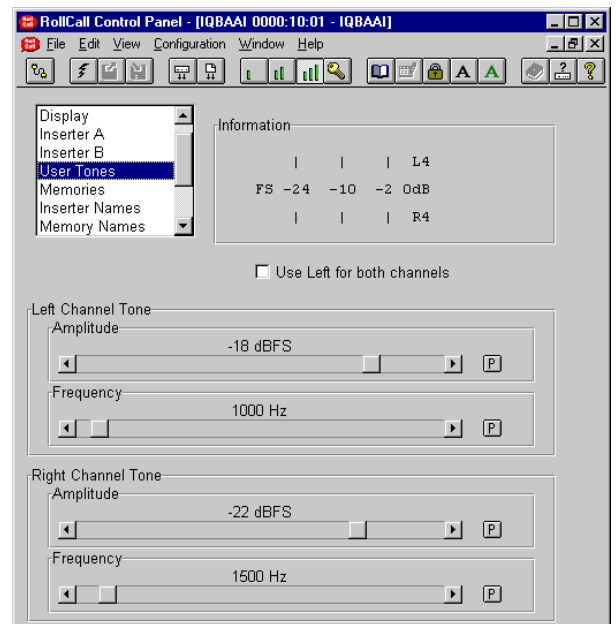

This allows an audio tone may be selected for the inserters. The frequency and amplitude may be set for the left and right channels separately or the left settings used for both channels (Check the 'Use Left for both channels' box)

The amplitude may set from –100 dBFS to 0 dBFS in steps of 1 dB

Preset value is -20 dB

The frequency may set from 250 Hz to 20 kHz in steps of 250 Hz.

Preset value is 1000 Hz

**Memories**

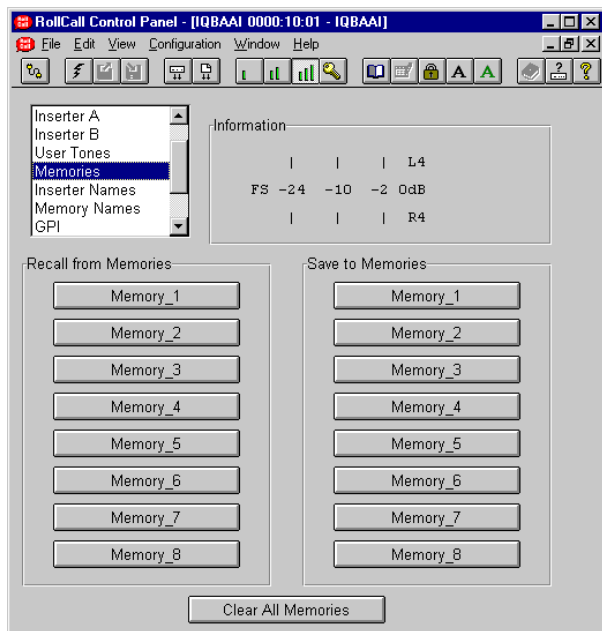

**Recall from Memories**

This function allows 8 different settings of all items to be recalled from the 8 memory locations as saved in the **Save to Memories** function.

**Save to Memories**

This function allows the settings of all items to be saved. Up to 8 different set-ups may be saved in the 8 memory locations

Note that if a memory location already contains saved data, an asterisk \* will appear to the right of the memory location number.

**Clear All Memories**

This item allows all memory locations to be cleared and returned to their default (preset) settings.

**Insertor Names**

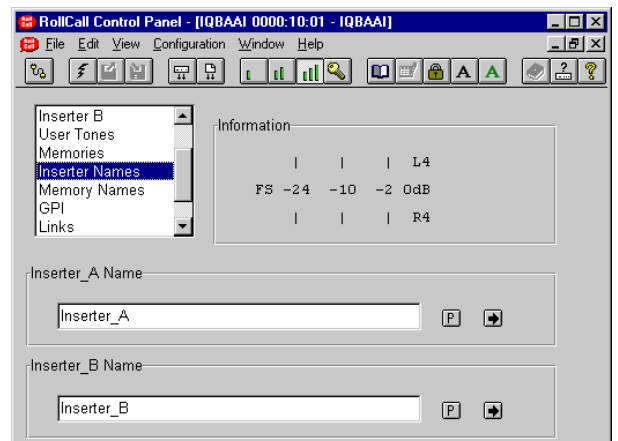

The insertors have default names of Insetrer A and B. For convenience they can be given specific names.

To change a name type the new name in the text area and select  (return)

Preset returns to the default names.

**Memory Names**

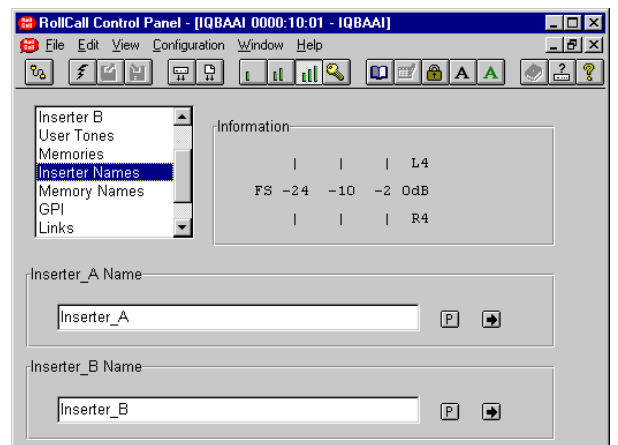

The 8 memory locations may be renamed in a similar way.

**GPI**

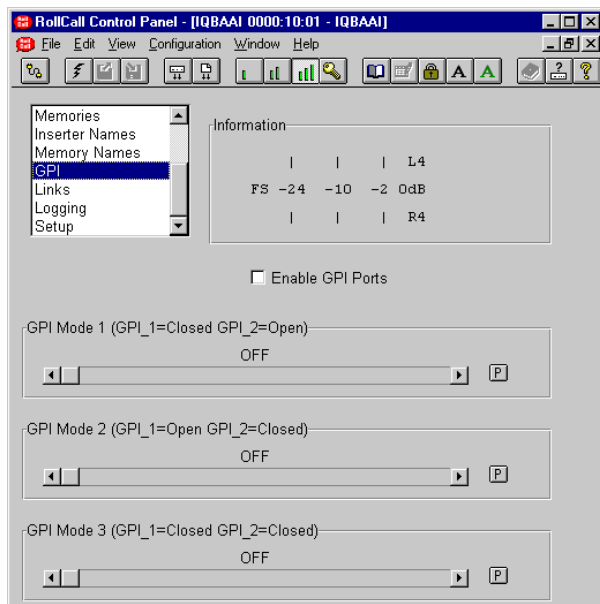

The three GPI connectors on the rear panel are used for accepting GPI information (from mechanical switch contacts, relay contacts etc.) The resulting action that the unit takes may be selected using this function.

**Enable GPI Ports**

When this box is checked this will make all GPI functions active.

**GPI Modes**

The two GPI inputs form a 2-bit binary coded signal producing the following action:

GPI 1	GPI 2	GPI Mode
Open	Open	Not valid
Closed	Open	GPI Mode 1
Open	Closed	GPI Mode 2
Closed	Closed	GPI Mode 3

The three GPI modes can be used to configure the unit to settings stored in a memory location. Each GPI mode scroll bar may be used to select a memory location.

When the selected GPI mode is activated the unit will be configured to the settings located in the memory location chosen from this menu. Preset for each of the GPI modes is to OFF; the unit will then have no response to the GPI inputs.

**Links**

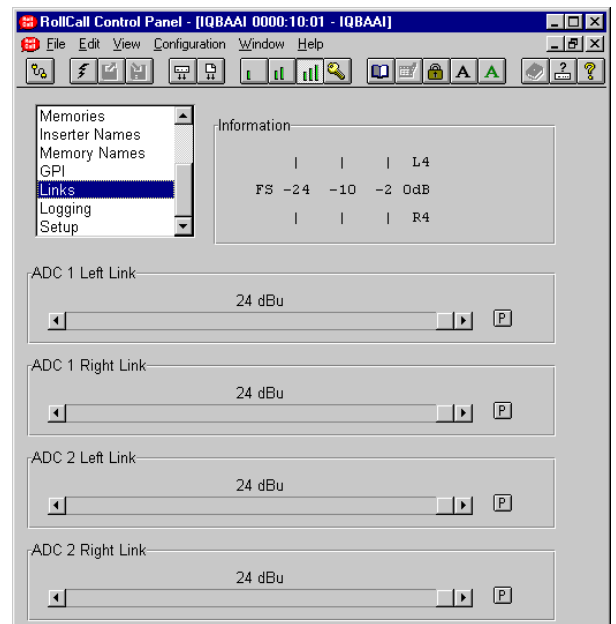

The input signal to the four ADC's may be set to one of four initial headroom values using links on the card. (See page 6) For internal calculations these link settings must be reported to the software via this menu.

**Logging**

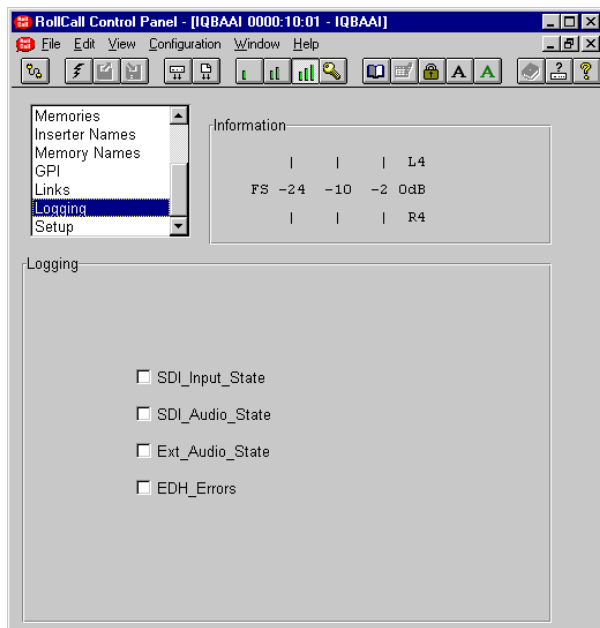

If a logging device is attached to the RollCall™ network, information about various parameters will be reported to the logging device assigned in the Remote Control Interface system. (See Section 1, The RCIF Menu System)

Checking the boxes will allow that information to be made available for logging.

Preset is nothing enabled.

**Setup**

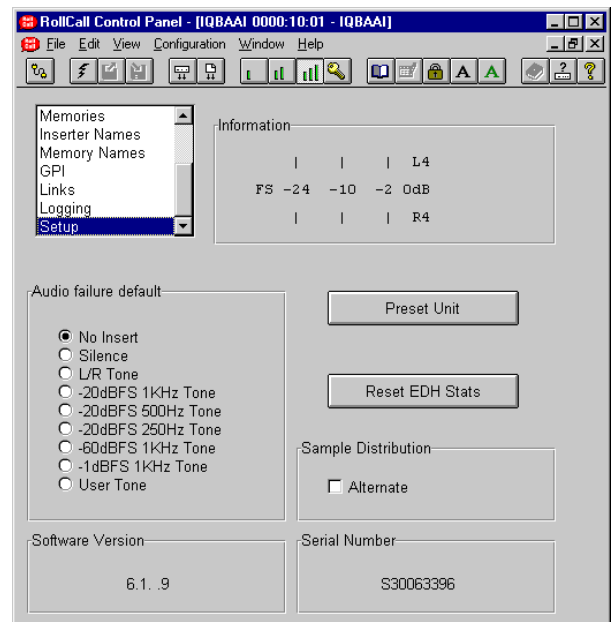

**Audio Failure Default**

If an audio failure occurs this may be used to select the signal to replace it.

The User Tone is setup via the User Tones function.

**Preset Unit**

Selecting this item sets all adjustment functions that include a preset facility, to their preset values.

**Reset EDH Stats**

The input 4:2:2 stream is continuously monitored for EDH errors. Enabling this function will reset all EDH statistics.

A regenerated EDH packet is inserted on the output 4:2:2 stream.

**Sample Distribution**

Alternate (see page 16 for more details)

When checked the Alternative distribution scheme is enabled; when unchecked the Standard distribution scheme is enabled.

The software version and serial number will also be displayed here.

## Inserter Operation

The SMPTE 272M standard specification allows for up to four groups of AES/EBU digital audio to be embedded in a component D1 digital video stream. Each group consists of two stereo pairs (four channels), giving a total of sixteen audio channels for all four groups.

A single IQBAAI module is capable of inserting two pairs of audio data (four channels). Four IQBAAI cards are required to embed all sixteen possible channels.

The input analog audio is sampled at 48 kHz, clock-synchronous to the video stream. Asynchronous operation is not supported.

A total of exactly 1920 audio samples occur within one frame of 625-line video. For 525-line video the relationship is 8008 audio samples over five video frames.

The audio data is distributed evenly throughout each video frame, situated in the non-active picture regions between the end of one line and the start of the next. The majority of lines contain three audio samples, some four, and a couple of reserved lines contain no samples.

Audio Control and Extended Data packets as defined in SMPTE-272M are not inserted, but are handled correctly by the 'remapping' and 'tagging' functions.

Block numbering as defined in SMPTE-272M is not supported.

The IQBAAI module contains two independent inserter streams that operate with either external audio analog inputs or internally generated tone or silence. They operate in sequence with stream A first and stream B second.

The inserter streams are given individual address assignments for destination group and stereo pair (1&2 or 3&4). Control software ensures that the addresses are mutually exclusive and do not clash with those of existing embedded audio data. In this way embedded data integrity is assured.

The SMPTE 291M standard defines the structure and space formatting for ancillary data within digital component or composite video streams. For D1 component data space ancillary packets follow immediately after the EAV (end of active video) and are contiguous with each other.

Complying with SMPTE 291M, the inserter control section looks for the first free space after EAV. Once found the embedding process is initiated with the first enabled inserter. However, before starting the embedding for any of the inserter streams the remaining data space is checked to ensure that there is enough room for the ancillary packet. If not, all inserters still waiting to be serviced are disabled to prevent corruption of the D1 video format or generation of invalid ancillary data packets. This situation is reported over the RollCall™ network and indicated on the card edge LEDs.

If desired, existing embedded ancillary data may be stripped off or 'renamed'. If stripped, the card inserters will embed data immediately following the EAV markers, otherwise the existing ancillary data will be appended to, provided that there is sufficient room remaining.

Each audio ancillary data packet contains an 'identity' word that indicates which group (1, 2, 3, 4) the data belongs to. This address label can be altered for existing embedded audio data, thus 'renaming' the packets. For example, the group 1 audio data from a Digital Betacam VCR could become group 3 if the inserter assignments needed to be for group 1. Alternatively, the identity word can be changed to 'TAG'. This indicates that the ancillary packet is to be ignored by downstream equipment, or removed during a reformatting process. The packet cannot simply be blanked out because that would violate the SMPTE 291M requirement that ancillary packets be contiguous.

Embedded ancillary data which does not conform to the space formatting requirements of SMPTE 291M may not be recognized, and so could be destroyed by the IQBAAI card. For example, if the data packets do not start immediately following the EAV marker the inserters will overwrite the packets. Similarly, if a data packet does start in the correct place but a second packet does not immediately follow the first one the second packet will be overwritten.

The first situation above applies to the embedded audio data from the Tektronix TSG-422 pattern generator, where the packets do not start until four words after the EAV marker.

The second situation can occur where an upstream embedder puts particular groups in to specific positions in the ancillary space.

**Embedder Packet distribution (Standard)****D1 625:**

1 .. 4	4 lines	4 audio samples per packet
5 .. 8	4 lines	0 samples
9 .. 11	3 lines	4 samples
12 .. 308	297 lines	27 x [10 lines of 3 samples + 1 line of 4 samples]
309 .. 312	4 lines	3 samples
313 .. 317	5 lines	4 samples
318 .. 321	4 lines	0 samples
322 .. 324	3 lines	4 samples
325 .. 621	297 lines	27 x [10 lines of 3 samples + 1 line of 4 samples]
622 .. 625	4 lines	3 samples

Total samples = 1920 / frame

Max. buffer excursion = 13 samples

**D1 525:**

1 .. 3	3 lines	3 samples
4	1 line	4 samples on frames 1, 3, & 5
		3 samples on frames 2 & 4 (5 frame sequence)
5 .. 8	4 lines	3 samples
9 .. 12	4 lines	0 samples
13 .. 21	9 lines	8 lines of 3 samples + 1 line of 4 samples
22 .. 261	240 lines	24 x [9 lines of 3 samples + 1 line of 4 samples]
262 .. 271	9 lines	3 samples
272 .. 275	4 lines	0 samples
276 .. 283	8 lines	7 lines of 3 samples + 1 line of 4 samples
284 .. 523	240 lines	24 x [9 lines of 3 samples + 1 line of 4 samples]
524 .. 525	2 lines	3 samples

Total samples = 8008 / 5 frames

Max. buffer excursion = 14 samples

### **Manual Revision Record**

Date	Version No.	Issue No.	Change	Comments
300798	1	1		New manual issued
300998	1	2	Lots of VJ mods	New manual issued
240699	1	3	Changes to menus, A,B to 1,2	New manual issued
020799	1	4	Corrections to text	New manual issued
031299	1	5	Changes for new code	New manual issued
100402	1	6	Now includes information for the 3A enclosure modules	New manual issued
310303	1	7	Power consumption added to techspec	New manual issued
261103	1	8	New templates for latest software	New manual issued
201206	1	9	Title corrected on page 1	New manual issued