

# IQDAMDA Advanced Multi-standard Decoder - 12 bit



### Module Description

The IQDAMDA provides multi-standard digital decoding of PAL, NTSC, NTSC-J, PAL-N, PAL-M, N443 and SECAM composite using enhanced Golden Gate technology with spatio-temporal filters. The composite input is sampled with 12-bit resolution and decoded using adaptive 3D frame comb filter techniques to ensure optimum picture sharpness. Signal correction features include luminance and chrominance gain, black level, NTSC hue, picture position and Y/C horizontal timing. The decoder will lock to noisy and unstable signal sources (e.g. VHS sources), and seamlessly select the appropriate comb mode.

A full frame synchronizer with horizontal and vertical phasing controls synchronize the output to

a studio reference. The normal video delay will be 1 frame plus synchronizer delay (up to 1 frame) and includes a minimum delay mode.

4 SDI outputs are provided with EDH insertion. In addition a test pattern generator can be switched in with a 19-character caption generator to identify the decoder within a system.

8 user-programmable memories are available. Full RollCall remote control is included with additional limited control available on the card edge. A GPI port may be configured to recall any memory function or force a selected pattern. Tracking of an external audio delay is possible through RollTrack or directly via a GPI port..

### REAR PANEL VIEW

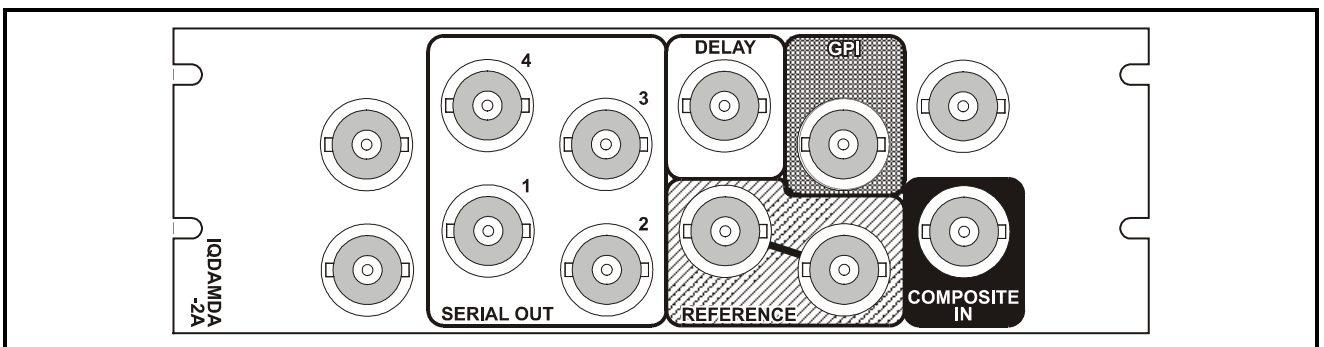
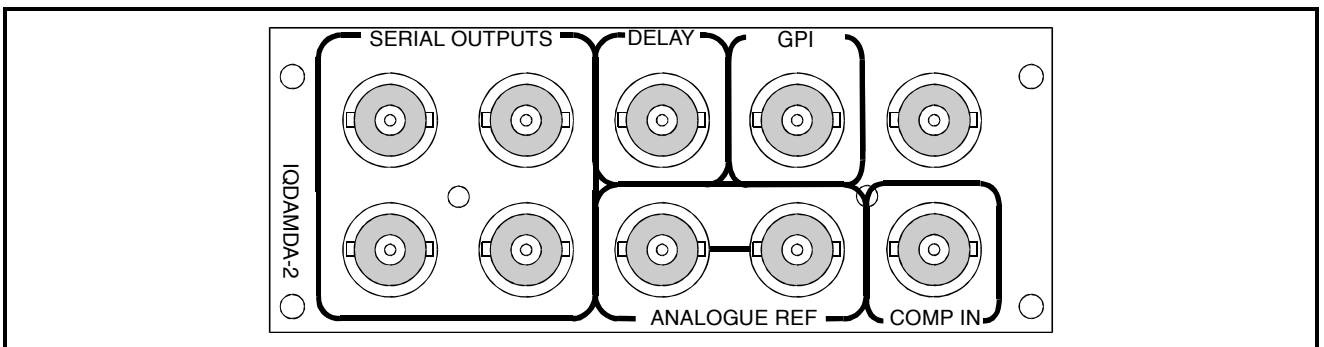

Versions of the module cards available are:

- IQDAMDA-2      Multi-standard digital decoder
- IQDAMDA-2A      Multi-standard digital decoder

- Double width module
- Double width module

**Note that there are two styles of rear panels available. They are not interchangeable between the two styles of enclosures. However, the cards may be fitted into any style of enclosure.**

### 'A' Style Enclosure

Rear panels **with** the suffix A may only be fitted into the 'A' style enclosure shown below.

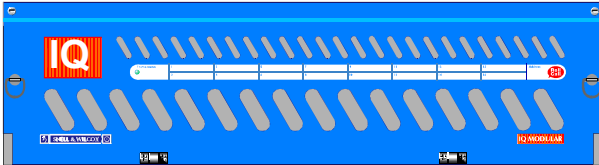

(Enclosure order codes IQH3A-E-O, IQH3A-E-P, IQH3A-N-O, IQH3A-N-P)

### 'O' Style Enclosures

Rear panels **without** the suffix A may only be fitted into the 'O' style enclosures shown below.

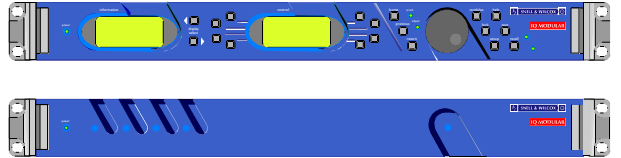

(Enclosure order codes IQH1S-RC-O, IQH1S-RC-AP, IQH1U-RC-O, IQH1U-RC-AP, Kudos Plus Products)

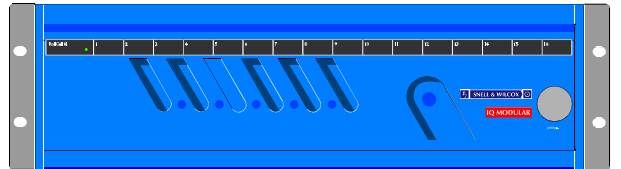

(Enclosure order codes IQH3N-O, IQH3N-P)

## BLOCK DIAGRAM

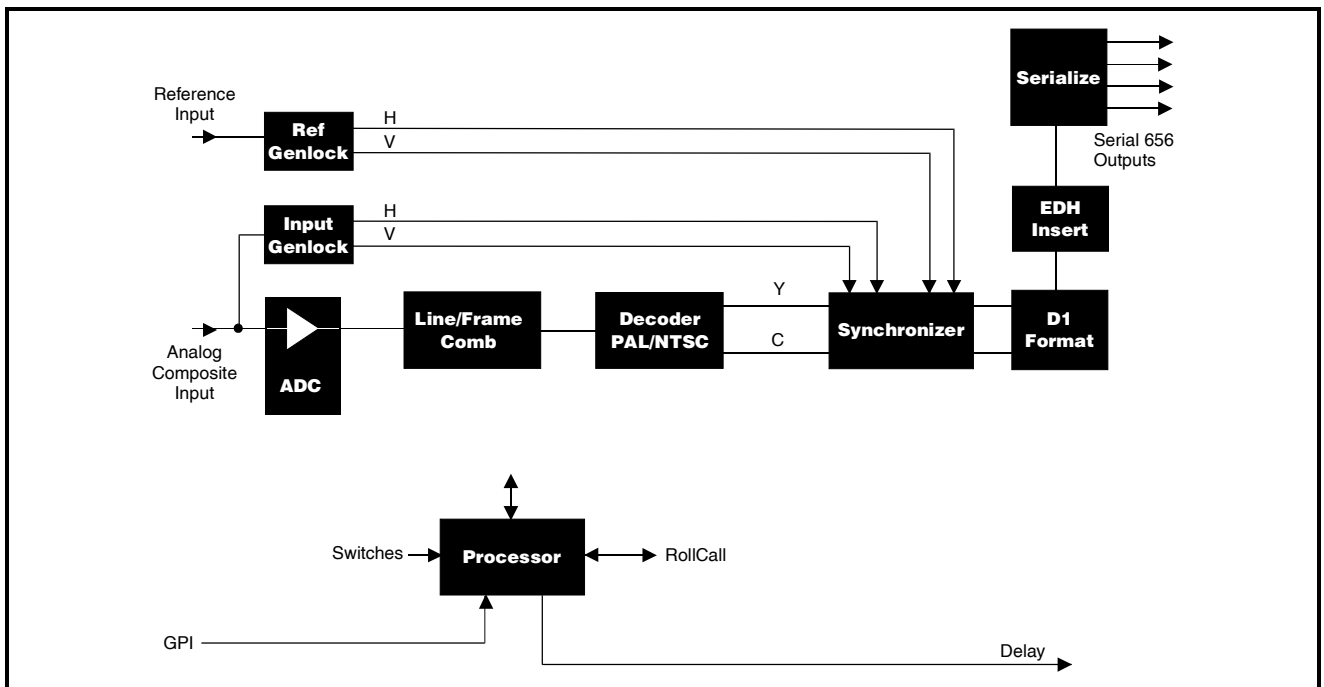

## Features

- Uses enhanced Golden Gate technology with spatio-temporal filters for accurate luminance and chrominance separation
- Input standards - PAL, NTSC, NTSJ, PALN, PALM, SECAM and N4.43
- Frame synchronizer with H and V phasing controls
- 12-bit over-sampled ADC with '601' filtering
- Adjustment of luminance gain, black level, chrominance gain, picture position and horizontal Y/C timing
- Locks to unstable inputs including VHS with automatic comb mode selection
- 4 x 10-bit serial component outputs
- Test signal generator (Black, EBU Color Bars, 100% Color Bars, Ramp, Multiburst, Pulse & Bar, and Green)
- Programmable 19 character caption generator overlaid on patterns or default output
- Selectable VBI pass through (pass flat or blank for each VBI line)
- Full RollCall remote control
- 8 user memories
- GPI input to recall any memory function or force pattern
- GPI output/delay flag and full support for RollTrack audio delay tracking
- EDH insertion

**TECHNICAL PROFILE****Features****Signal Inputs**

Composite Video .....	1 x Differential input
Standards .....	PAL/NTSC//NTSC-J/PAL-M /PAL-N/SECAM/N4.43
Reference .....	1 x Loop-through
GPI .....	Closing contact style input

**Signal Outputs**

10-bit Serial Digital .....	4 x SDI outputs
Standards .....	SMPTE 259M-C-1997
GPI Output/Delay .....	TTL levels, sink or source current <10 mA

**Card Edge Controls (also available via RollCall)**

Luminance Gain .....	± 6 dB in 0.1 dB steps
Black level .....	±120mV in 1mV steps
Chrominance Gain .....	± 6 dB in 0.1 dB steps
NTSC Hue .....	± 45 deg. in 1 degree steps
Y/C Timing .....	± 592 ns in 148 ns steps
Picture position .....	± 592 ns in 37 ns steps
Genlock mode .....	Lock to Ref/Lock to input and Freerun
Genlock H phase .....	±32µs in 37ns steps
Genlock V phase .....	± 262/312 lines in 1 line steps
Pattern Select .....	On/Off (Black /EBU Bars/100% Bars/Ramp/ Multiburst / Pulse & Bar and Green)
Caption .....	On/Off

**Specifications**

Internal Processing .....	12-bit analog to digital conversion, >12 bit luma/chroma processing, 10 bit serial output
Y Frequency Response .....	5.75MHz ±0.1dB
PbPr Frequency Response .....	1.5MHz -3dB
Signal / Noise .....	Better than -65dB (Weighted, ramp)
K-2T .....	Better than 0.5%
Y Non Linearity .....	Better than 0.5% (5 step staircase)
Subcarrier Rejection .....	Better than -46dB (PAL, NTSC)
Differential Gain .....	Less than 0.5% (5 step modulated staircase)

**Indicators**

Power ok
Input Loss
Input Error
Reference Loss

**Functions Available via RollCall™ Only**

Standards Selection .....	PAL / NTSC / NTSCJ / PALN/ PAL-M / SECAM / N443
Decoder .....	Studio/Simple/Minimum Delay
Bypass .....	Returns video settings to default while selected
Preset Unit .....	Returns all settings to default
User Memories .....	Name, clear, save and recall 8 user memories
Default Output .....	Video / Freeze/ Pattern
Caption Generator .....	Programmable up to 19 characters
VBI Pass .....	Selectable pass or blank for each vertical interval line
GPI Input set-up .....	Programmable to recall any memory or force pattern
GPI Output/Delay Flag .....	Programmable output port for input present, standard 625 or video delay flag
RollTrack .....	Enable / program address of receiving unit
Logging .....	Input Loss, Input line Standard, Reference loss

Differential Phase .....	Less than 0.5deg (5 step modulated staircase)
Input Return Loss (Analog) .....	Better than -38 dB to 5 MHz
Output Return Loss (Digital) .....	Better than -15 dB to 270 MHz
Insertion Delay .....	Normal mode: 1 frame + approximately 13 µs + synchronizer delay. Min delay mode: 1 line + approximately 13 µs + synchronizer delay.
Power Consumption .....	
Module Power Consumption .....	10.8W max

INPUT CONNECTIONS

**Composite Input**

This is the Composite video input to the decoder module via BNC connector. Nominal input level is 1 V p-p terminated in 75 Ohms.

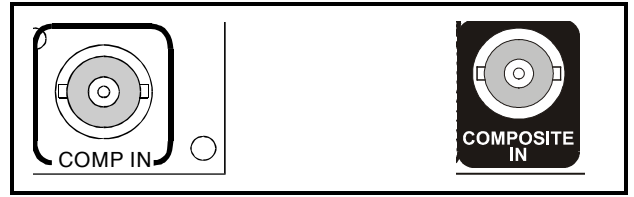

**GPI**

Input Functions: Selects pattern as output.  
Recalls memory.

GPI Levels: Open >2.5 V or floating  
Closed < 0.8 V or short circuit

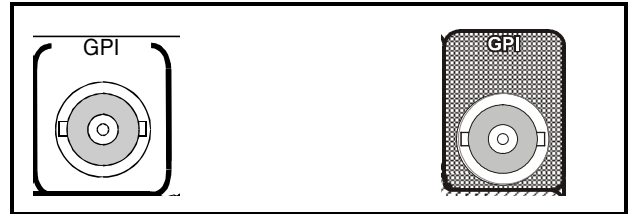

**Reference**

These are the loop-through connections via BNC connectors for 75 Ohms, for a black burst reference signal for the synchronizer.

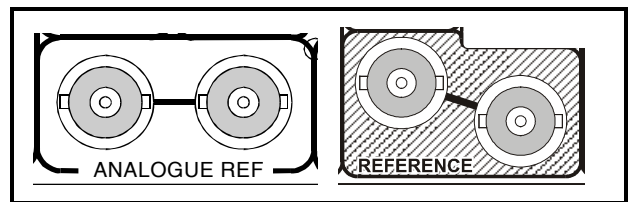

OUTPUT CONNECTIONS

**Serial Outputs**

These connectors provide 4 outputs of 10-bit serial component video.

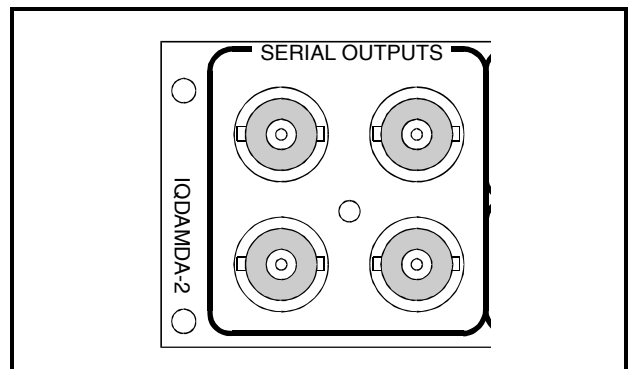

**Delay**

This output may be configured to produce an output corresponding to the following conditions:

Input Present True  
Standard 625 True

Video Delay A positive going TTL pulse. The pulse width corresponds to the delay through the unit.

Levels: True < 1 V @ -10 mA  
Not true > 3.5 V @ + 10 mA

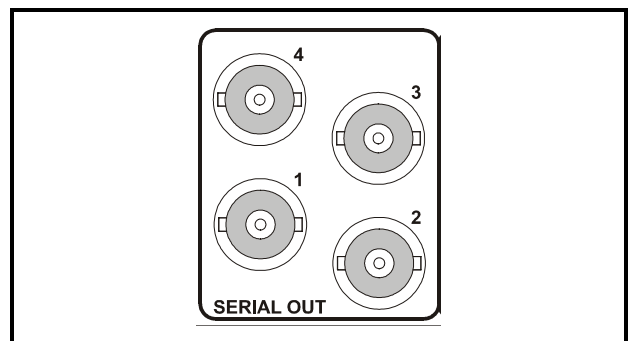

CARD EDGE CONTROLS

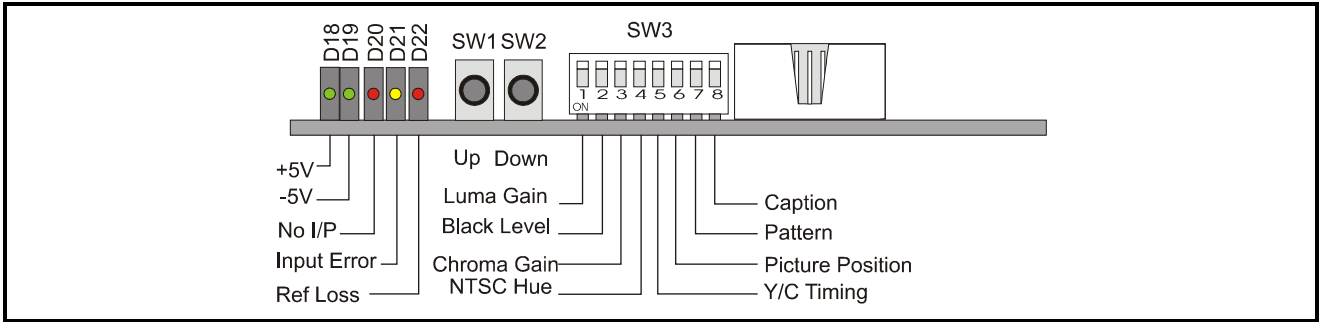

The unit will respond to both local and remote control, one system overriding the settings of the other. For cards using the RollCall™ remote control system, activating these switches will override the remote control settings. The RollCall™ control panel will then follow these settings.

LED INDICATORS

**+5V and -5V**

When illuminated these LED's indicate that the +5 V and -5 V supplies are present.

**No I/P**

The **No I/P** LED will be continuously illuminated when the unit is not receiving an input signal.

**Input Error**

This LED will be illuminated when the incoming signal is a different line standard to the selected input standard.

**Ref Loss**

This LED will be illuminated when the unit is not receiving a valid reference signal.

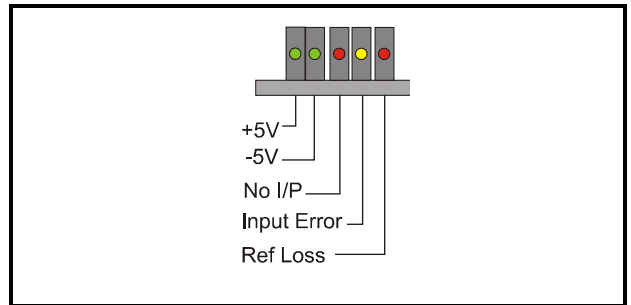

Adjustment of the settings of the IQDAMDA is available either via card edge controls and/or via a more comprehensive remote control system using RollCall™

## SWITCHES

Two push buttons and an 8 way DIL switch allow various functions to be selected and adjusted.

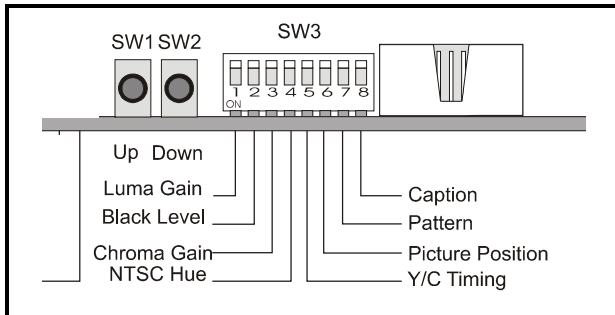

The push buttons SW1, SW2 allow the value of the selected function/parameter to be adjusted.

*Note that SW1 increases a setting and SW2 decreases a setting. Continual pressure on the button will cause the setting to change continuously, the rate of change increasing with time*

These switches allow the module to be operated when an active front panel is not available.

**Note that to select the preset value both buttons should be pressed together.**

More detailed information about these functions will be found under *MENU DETAILS* starting on page 9.

### DIL SWITCH FUNCTIONS SW3

By setting these switches various modes of operation may be selected.

*Note that the mode is selected when the switch is set to the DOWN position.*

#### Position 1

This allows the **Luminance Gain** of the unit to be adjusted.

The overall range of adjustment is  $\pm 6$  dB in 0.1 dB steps.

Preset setting is to the calibrated value of 0 dB

#### Position 2

This allows the **Black Level** of the unit to be adjusted.

The overall range of adjustment is  $\pm 120$  mV in 1 mV steps.

Preset setting is to the calibrated value of 0 mV.

#### Position 3

This allows the **Chrominance Gain** of the unit to be adjusted.

The overall range of adjustment is  $\pm 6$  dB in 0.1 dB steps.

Preset setting is to the calibrated value of 0 dB

#### Position 4

This allows the **Hue** of an NTSC signal to be adjusted. The overall range of adjustment is  $\pm 45$  deg. in steps of 1 degree.

Preset returns the setting to the calibrated value of  $0^\circ$

#### Position 5

This allows the **Y/C Timing** to be adjusted.

The overall range of adjustment  $\pm 592$  ns in 148 ns steps.

Default setting is to the calibrated value of 0 ns.

#### Position 6

This allows the **Picture Position** to be adjusted.

The overall range of adjustment is  $\pm 592$  ns in 37 ns steps.

Default setting is to the calibrated value of 0 ns.

#### Position 7

This position switches the test pattern On.

*Note that when the test pattern is selected the ProcAmp controls are bypassed.*

#### Position 8

This position allows the caption to be added to the output picture.

## OPERATION FROM AN ACTIVE CONTROL PANEL

The card may be operated with an active control panel via the RollCall™ network.

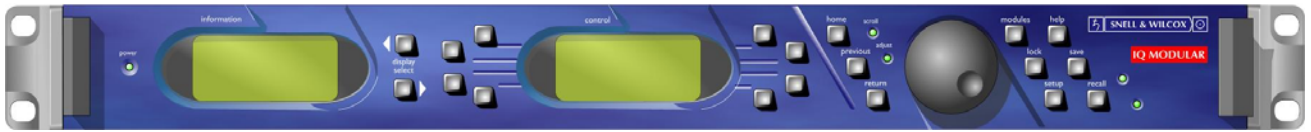

All operational parameters and selections are made using a system of menus displayed in two LCD windows.

### Information Window

The Information window has four lines of text indicating the current state of the unit.

The **first line** will show the unit name.

The **second line** shows the status of the input.

This may show the following states:

<b>In:</b>	<b>OK</b>	Input is present and recognized.
	<b>**</b>	No input present.
	<b>ERR</b>	Unrecognized input.
<b>Std:</b>	<b>ERR</b>	Standard not detected.
	<b>PAL</b>	PAL standard detected.
	<b>PAL-N</b>	PAL-N standard detected.
	<b>SECAM</b>	SECAM standard detected.
	<b>NTSC</b>	NTSC standard detected.
	<b>NTSCJ</b>	NTSC-J standard detected.
	<b>PAL-M</b>	PAL-M standard detected.
	<b>N443</b>	N4.43 standard detected.
	<b>525</b>	525 line standard detected. No color standard detected.
	<b>625</b>	625 line standard detected. No color standard detected.

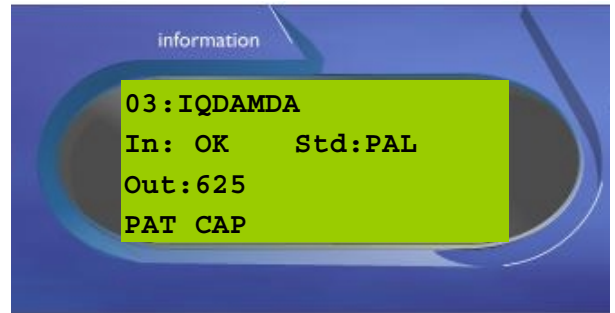

The **third line** shows the output line standard of the unit and the status of the genlock reference.

This may show the following states:

<b>Out:</b>	<b>525</b>	Output line standard is 525.
	<b>625</b>	Output line standard is 625.
<b>Ref:</b>	<b>INPUT</b>	<b>Lock to Input</b> has been selected and the unit will be genlocked to the input signal. If there is no input present, the unit will default to <b>Freerun</b> .
	<b>ERR</b>	<b>Lock to Ref</b> has been selected but the reference signal does not match the input standard. The unit will default to the <b>Freerun</b> mode.
	<b>FREE</b>	<b>Freerun</b> has been selected and the unit will be locked to an internally generated signal.
	<b>**</b>	<b>Lock to Ref</b> has been selected but there is no reference present or it is an unrecognised standard. The unit will default to <b>Freerun</b> mode.
	<b>OK</b>	<b>Lock to Ref</b> has been selected and the reference standard matches the input standard. The output of the unit will be genlocked to the incoming reference signal.



The **fourth line** shows the state of various settings.

This may show the following abbreviations:

- PAT** The pattern has been enabled on the video output.
- CAP** The caption has been enabled on the video output.
- BYP** The bypass option has been selected and all video control settings are bypassed.
- CO<sub>n</sub>** The Color Killer Chroma On option has been selected.
- CO<sub>f</sub>** The Color Killer Chroma Off option has been selected.
- FRZ** The freeze function has been selected.

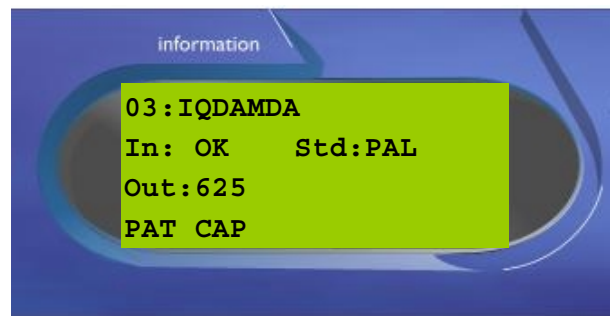

### Control Window

The **Control** window displays all Selection Menus and sub-menus.

The selection is made by pressing the button adjacent to the required item.

The menu structure is detailed in the following pages.

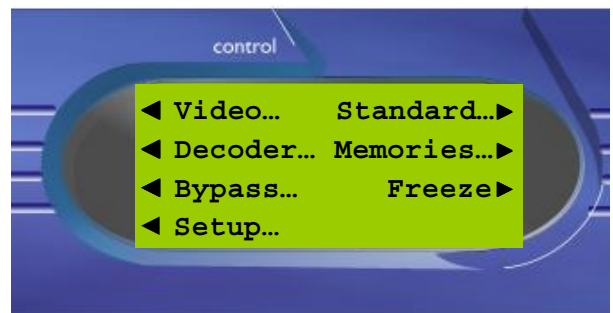

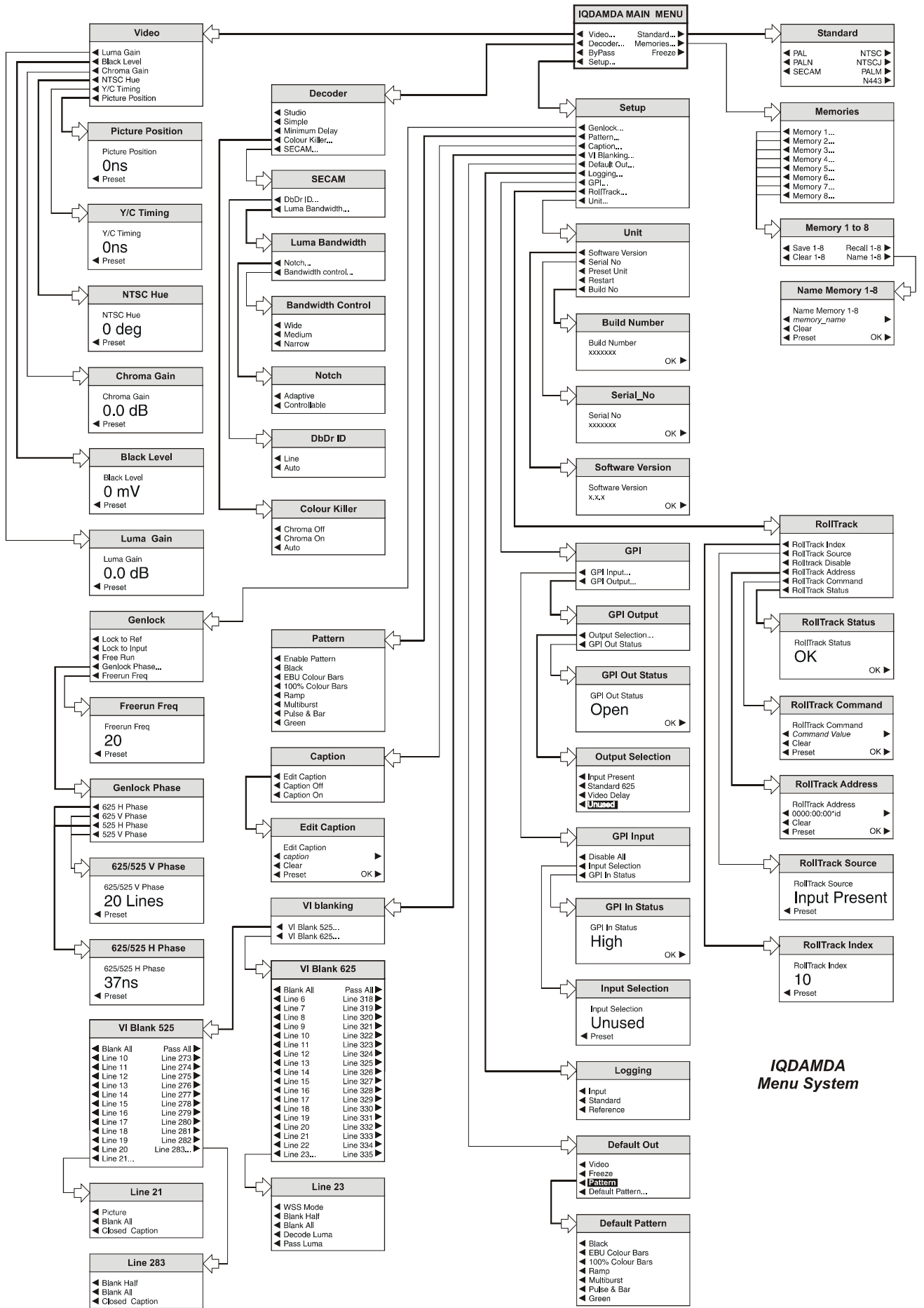

**IQDAMDA Menu System**

OPERATION FROM AN ACTIVE CONTROL PANEL

The card may be operated with an active control panel via the RollCall™ network. The menus available for this card are shown on the previous page and will appear in the Control display window.

Operational details for the remote control panel will be found in SECTION 1 of the Modular System Operator's Manual.

**MAIN MENU**

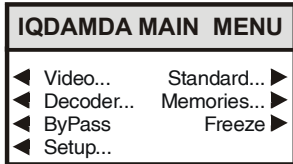

**◀ Video...**

This menu will allow the settings of the Luma Gain, Black Level, Chroma Gain, NTSC Hue, Y/C timing and Picture Position to be adjusted.

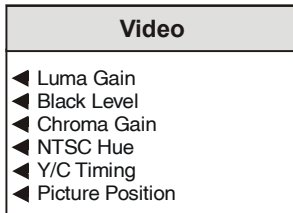

**◀ Luma Gain**

This item allows the gain of the luminance signal to be adjusted.

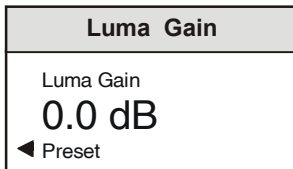

By using the spinwheel the gain may be adjusted by ± 6 dB in steps of 0.1 dB.

Preset is to 0.0 dB.

**◀ Black Level**

This item allows the Y pedestal or black level to be adjusted.

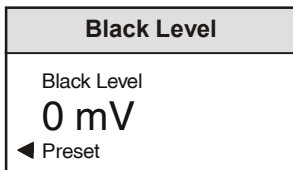

By using the spinwheel the pedestal may be adjusted by ±120mV in steps of 1 mV.

Preset is to 0 mV

**◀ Chroma Gain**

This item allows the gain of the chrominance signal to be adjusted.

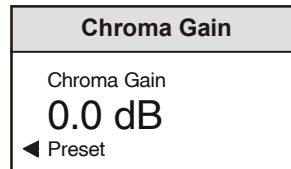

By using the spinwheel the gain may be adjusted by ± 6 dB in steps of 0.1 dB.

Preset is to 0.0 dB.

**◀ NTSC Hue**

This item allows the Hue of an NTSC signal to be adjusted.



By using the spinwheel the Hue may be adjusted by ± 45 deg. in steps of 1degree.

Preset is to 0.0 deg.

**◀ Y/C Timing**

This item allows the timing of the chrominance signal relative to the luminance signal to be adjusted, (i.e. Y to Cb/Cr timing) in nanoseconds.

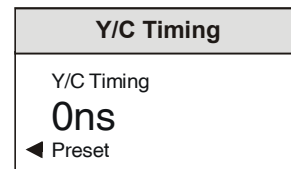

By using the spinwheel the timing may be adjusted by ± 592 ns in 148 ns steps.

Preset is to 0 ns.

◀ **Picture Position**

This item allows the picture position to be changed.

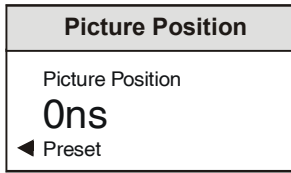

By using the spinwheel the timing may be adjusted by  $\pm 592$  ns in 37 ns steps.

Preset is to 0 ns.

**Standard ▶**

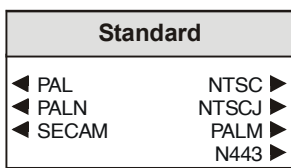

This menu selects the input standards that will be recognized.

625 line standards are listed on the left and 525 line standards on the right. The required standards should be selected and then the decoder will automatically detect between the selected line standards.

**Notes**

*When more than one standard has been selected the unit will operate in the auto standards detection mode.*

*If only one of the line standards is selected the IQDAMDA will be forced to that standard when an input line rate of that standard is detected.*

*For noisy input signals it is recommended that only one standard should be selected that matches the standard of the input signal.*

625 Line Standards

- ◀ PAL
- ◀ PAL-N
- ◀ SECAM

525 Line Standards

- ◀ NTSC
- ◀ NTSCJ
- ◀ PALM
- ◀ N443

Note that either NTSC **or** NTSCJ may be selected but not both.

◀ **Decoder...**

This function allows different decoding modes to be selected.

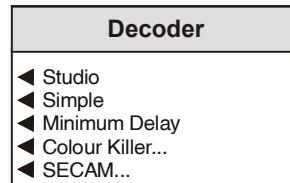

◀ **Studio**

This mode uses enhanced Golden Gate technology. The composite input is sampled with 12-bit resolution and decoded using adaptive line and frame comb filters to ensure optimum decoding performance.

*Note that when an unstable input is detected the IQDAMDA will automatically change its processing mode to produce the best output picture.*

◀ **Simple**

This simple decode mode incorporates a wide bandwidth subcarrier notch filter. This mode is for reference only and should not be used for normal composite material.

◀ **Minimum Delay**

This mode produces the minimum input/output delay and may be used where audio delay problems may exist and cannot be compensated for. It uses the same adaption technique as the Studio mode but has asymmetric frame stores.

This mode can be used with both Studio and Simple decoding modes.

*This mode is not recommended for U-matic SECAM or sources containing occasional DbDr phase reversals.*

◀ Colour Killer

This function controls the color content of the picture.

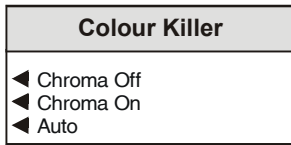

◀ Chroma Off

When selected the color content of the picture will be removed. The luma signal is produced using a narrow bandwidth notch filter.

◀ Chroma On

When selected the color content of the picture will be maintained regardless of the level of the color burst.

◀ Auto

When this item is enabled the picture will become monochrome if the input color burst disappears or the level drops below a critical amplitude. The picture will return to color when the burst level reappears.

◀ SECAM

This function allows adjustments to decoding parameters for a SECAM signal.

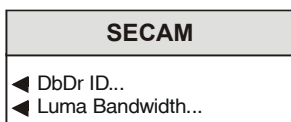

◀ DbDr ID

This item allows the DbDr sequence of the SECAM signal to be identified in various ways.

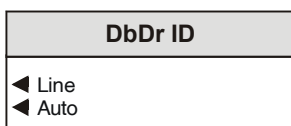

◀ Line

When selected the DbDr color ident of a SECAM signal will be derived from the bursts of un-modulated chroma on the line sync back porch.

◀ Auto

When selected the DbDr sequence will be automatically be derived from the SECAM Bottles if present or Line sync data if bottles cannot be found.

◀ Luma Bandwidth

This function allows the luminance part of a SECAM signal to be processed in various ways.

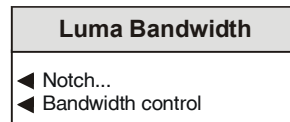

◀ Notch

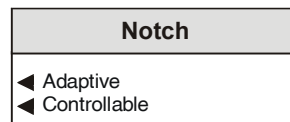

Either the Adaptive or the Controllable luminance notch filter may be enabled with this item.

◀ Bandwidth Control

This function allows the bandwidth of the decoded luminance to be adjusted when the notch filter is set to Controllable.

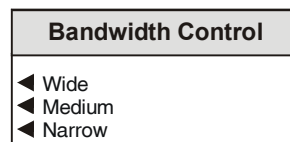

◀ Wide      The signal will be processed at full bandwidth (3.4 MHz)

◀ Medium    The signal will be processed with a bandwidth of approximately 2.6 MHz.

◀ Narrow    The signal will be processed with a bandwidth of approximately 1.7 MHz.

◀ Bypass

Selecting this item bypasses all video settings i.e. Gain, YC Timing, Black Level, Hue, Position, Caption and Pattern.

When not selected, the video settings will be applied to the signal.

◀ Setup...

This item allows various functions to be set up.

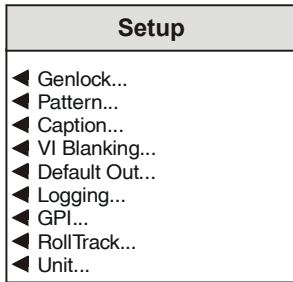

◀ Genlock

This item allows settings to be made to the Genlock function.

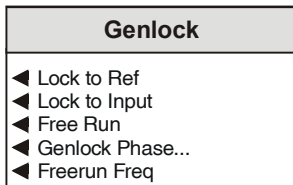

◀ Lock to Ref

When this item is selected (text highlighted) the unit will lock to a valid signal connected to the Reference input.

◀ Lock to Input

When this item is selected the unit will lock to the input signal.

◀ FreeRun

When enabled the output signal will be free running and locked to an internally generated signal. In this mode the frequency will be that set by the **Freerun Freq** control.

◀ Genlock Phase

This function allows the timing between the output signal relative to the reference sync signal, to be adjusted.

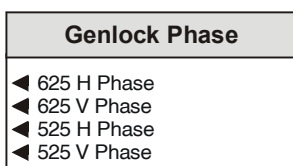

◀ 625 and 525 H Phase

Selecting this item reveals a display showing the horizontal timing of the output signal relative to the reference sync signal, in nanoseconds.

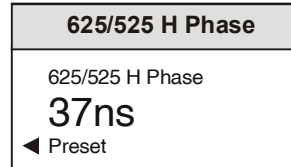

Rotating the spin-wheel will adjust this value. The range of control is  $\pm 32\mu s$  in 37ns steps.

Selecting Preset returns the setting to zero (output coincident with reference).

*Note that the Preset Unit function in the Setup menu will not change this setting.*

◀ 625 and 525 V Phase

Selecting this item reveals a display showing the vertical timing of the output signal relative to the reference sync signal, in picture lines.

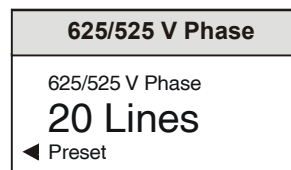

Rotating the spin-wheel will adjust this value. The range of control is  $\pm 262/312$  lines in 1 line steps (525/625).

Selecting Preset returns the setting to zero (output coincident with reference).

*Note that the Preset Unit function in the Setup menu will not change this setting.*

◀ Freerun Freq

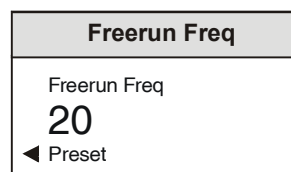

The frequency of the free-running internally generated sync signal may be adjusted with this function.

The range of control is  $\pm 60$  units represents a change in frequency of approximately  $\pm 15$  ppm.

Preset returns the unit to the factory calibrated frequency.

◀ **Pattern**

This function allows the output to become a selected pattern.

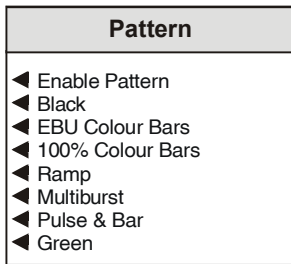

◀ **Enable Pattern**

When selected the output will become the pattern chosen from the list.

When deselected the output will be the processed video signal.

◀ **Caption**

This function allows control of the caption.

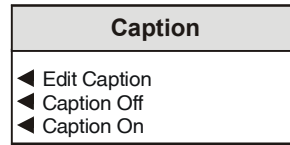

◀ **Edit caption**

This function allows a caption to be edited and downloaded to the unit.

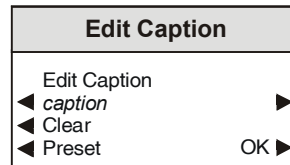

To compile/edit the text the right ▶ and left ◀ buttons adjacent to the upper text line in the menu should be used to select the character position in the text and the spinwheel used to select the character.

The ◀ **Clear** function blanks out the selected character.

The ◀ **Preset** function loads the default caption text.

**O.K.** ▶ saves the caption text and returns to the main menu.

*Note that a maximum of 19 characters may be used for the caption.*

◀ **Caption Off**

When selected the caption will not appear on screen.

◀ **Caption On**

When selected the caption will appear on screen.

◀ VI Blanking

VI blanking	
◀ VI Blank 525...	
◀ VI Blank 625...	

This function allows the user to select which vertical interval lines to pass through to the output and which to blank.

◀ VI Blank 525

This section allows lines 10 to 21 and lines 273 to 283 of 525 line signals to be selected and passed through to the output by checking the appropriate box.

VI Blank 525	
◀ Blank All	Pass All ▶
◀ Line 10	Line 273 ▶
◀ Line 11	Line 274 ▶
◀ Line 12	Line 275 ▶
◀ Line 13	Line 276 ▶
◀ Line 14	Line 277 ▶
◀ Line 15	Line 278 ▶
◀ Line 16	Line 279 ▶
◀ Line 17	Line 280 ▶
◀ Line 18	Line 281 ▶
◀ Line 19	Line 282 ▶
◀ Line 20	Line 283... ▶
◀ Line 21...	

◀ Blank All Pass All ▶

This section allows all vertical interval lines to be selected and either passed to, or blanked from, the output signal.

◀ Line 21

This function allows line 21 to be processed in various ways.

Line 21	
◀ Picture	
◀ Blank All	
◀ Closed Caption	

◀ Picture

When enabled, line 21 of the input signal will be processed and the ProcAmp controls will effect these lines.

◀ Blank All

When enabled, line 21 of the input signal will be blanked from the output.

◀ Closed Caption

This item controls the processing of closed captioning information on line 21 of incoming 525 line video signals.

When enabled the luminance will be decoded and the chrominance will be blanked.

*Note that only one of these items may be selected.*

◀ Line 283

This function allows line 283 to be processed in various ways.

Line 283	
◀ Blank Half	
◀ Blank All	
◀ Closed Caption	

◀ Blank Half

When selected, the first half of line 283 will be blanked from the output and the second half is decoded and passed as picture.

◀ Blank All

When enabled, line 283 of the input signal will be blanked from the output.

◀ Closed Caption

This item controls the processing of closed captioning information on line 283 of incoming 525 line video signals.

When enabled the luminance will be decoded and the chrominance will be blanked.



◀ VI Blank 625

This section allows lines 6 to 23 and lines 318 to 335 of 625 line signals to be selected and passed through to the output by checking the appropriate box.

VI Blank 625	
◀ Blank All	Pass All ▶
◀ Line 6	Line 318 ▶
◀ Line 7	Line 319 ▶
◀ Line 8	Line 320 ▶
◀ Line 9	Line 321 ▶
◀ Line 10	Line 322 ▶
◀ Line 11	Line 323 ▶
◀ Line 12	Line 324 ▶
◀ Line 13	Line 325 ▶
◀ Line 14	Line 326 ▶
◀ Line 15	Line 327 ▶
◀ Line 16	Line 328 ▶
◀ Line 17	Line 329 ▶
◀ Line 18	Line 330 ▶
◀ Line 19	Line 331 ▶
◀ Line 20	Line 332 ▶
◀ Line 21	Line 333 ▶
◀ Line 22	Line 334 ▶
◀ Line 23...	Line 335 ▶

◀ Blank All Pass All ▶

This section allows all vertical interval lines to be selected and either passed to or blanked from the output signal.

◀ Line 23

This function allows line 23 to be processed in various ways.

Line 23
◀ WSS Mode
◀ Blank Half
◀ Blank All
◀ Decode Luma
◀ Pass Luma

◀ WSS Mode

When enabled, the luminance of the first half of the line will be decoded and the chrominance will be blanked; the second half of the line will be treated as picture and decoded.

◀ Blank Half

When selected, the first half of line 23 will be blanked from the output and the second half is decoded and passed as picture.

◀ Blank All

When enabled, line 23 of the input signal will be blanked from the output.

◀ Decode Luma

When enabled, the luminance will be decoded and then passed through to the output. The chrominance is blanked.

◀ Pass Luma

When enabled, the luminance will be passed directly through to the output without being decoded. The chrominance is blanked.

*Note that only one of these items may be selected.*

◀ Default Out

If the input signal fails or is of poor quality this function will determine what the output signal will become under such conditions.

Default Out
◀ Video
◀ Freeze
◀ <b>Pattern</b>
◀ Default Pattern...

◀ Video

If the input signal is of poor quality the unit will attempt to provide the best possible output picture. If the input signal has failed completely the unit will provide a fully formatted output but with undefined picture.

◀ Freeze

When selected the output will become a frozen picture of the last valid frame.

◀ Pattern

When selected the output will become a pattern chosen from the **Default Pattern** list.

◀ **Default Pattern...**

The default pattern may be chosen from this menu.

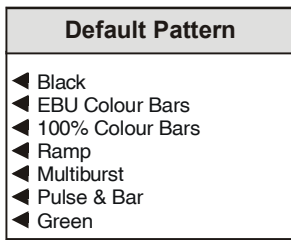

◀ **Logging**

If a logging device is attached to the RollCall™ network, information about various parameters can be made available to such a device.

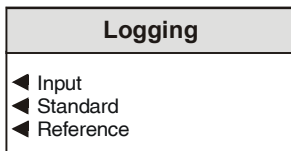

Selecting this item reveals a display that allows information to be made available for logging.

◀ **Input**

When activated, a loss of input signal condition will be available for the logging device.

◀ **Standard**

When activated a change of input line standard will be available for the logging device.

◀ **Reference**

When activated, a loss of reference signal condition will be available for the logging device.

◀ **GPI**

This function allows the GPI functions to be configured and their actions defined.

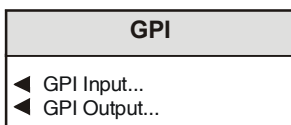

◀ **GPI Input**

This reveals the GPI input menu that allows the GPI input to be configured.

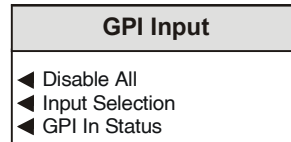

◀ **Disable All**

When selected all GPI functions will be disabled.

◀ **Input Selection**

When configured as an input the GPI connection may be used for accepting GPI information (from mechanical switch contacts, relay contacts etc.) The resulting action that the unit takes may be selected using this item.

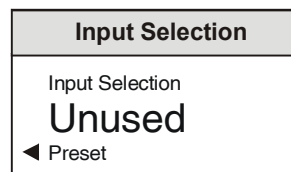

The GPI input may be configured to become one of the following when the input condition changes.

The GPI input functions that may be selected are as follows:

- Unused**      The unit will perform no function. This is also the Preset Setting.
- Pattern**      The unit will produce a pattern chosen from the Pattern menu when the input changes from open to closed.
- Memory 1 to 8**      The unit will use the settings in the selected memory location when the input changes from open to closed.
- Mem1-2**      The unit will toggle between the settings of memory locations 1 and 2.  
Open to Closed = Memory 1 settings  
Closed to Open = Memory 2 settings
- Mem 3-4**      The unit will toggle between the settings of memory locations 3 and 4.  
Open to Closed = Memory 3 settings  
Closed to Open = Memory 4 settings
- Mem 5-6**      The unit will toggle between the settings of memory locations 5 and 6.  
Open to Closed = Memory 5 settings  
Closed to Open = Memory 6 settings
- Mem 7-8**      The unit will toggle between the settings of memory locations 7 and 8.  
Open to Closed = Memory 7 settings  
Closed to Open = Memory 8 settings

◀ GPI In Status

This will display the current status of the selected GPI input.

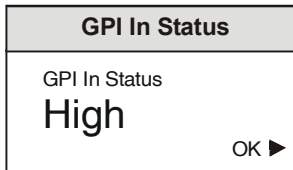

This may show either High or Low. When low, the associated function will be triggered.

◀ GPI Output

This reveals the GPI Output menu that allows the GPI output to be configured.

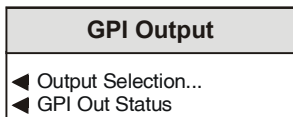

◀ Output Selection

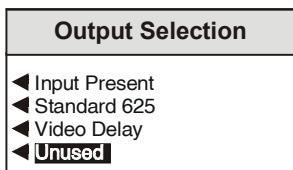

The GPO may be configured to produce an output corresponding to one of the following conditions:

- Input Present
- Standard 625
- Video Delay
- Unused

When the condition is not true the output will float but when the condition is true the output is closed to ground via a transistor.

*Note that when video delay mode is selected the output is a positive going TTL pulse. The width of the pulse represents the video delay through the unit to the nearest millisecond.*

The preset setting for the output is Unused.

◀ GPI Out Status

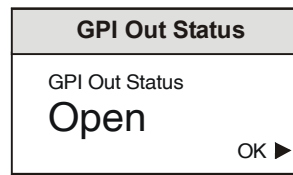

This will display the current status of the GPI output.

This may show either Unused, Open, Closed or video delay in milliseconds.

◀ RollTrack

This function allows information to be sent, via the RollCall™ network, to other compatible units connected on the same network.

For example, it can enable compatible audio delay units to produce an audio delay dependent on this and other similar units. The audio delay unit will dynamically follow or track the received delay-time information. This allows processed video signals to be timed correctly with audio signals. This automatic tracking system via the RollCall™ network is call **RollTrack**.

*For more detailed information, see the RollTrack section (Appendix) at the end of this manual.*

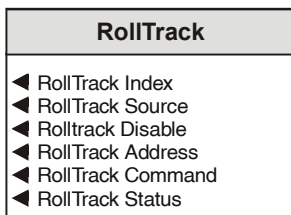

◀ RollTrack Index

This item allows up to 16 destinations to be selected.

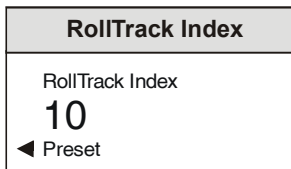

◀ RollTrack Source

This allows the source of information that triggers the transmission of data, to be selected.

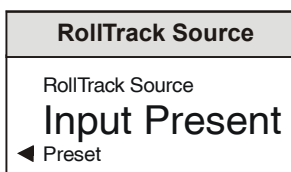

- Unused (off)
- Video Delay
- Input Present
- Input Missing
- Standard 525
- Standard 625
- Reference lost
- Reference present

◀ RollTrack Disable

When this item is selected all RollTrack items will be disabled.

◀ RollTrack Address

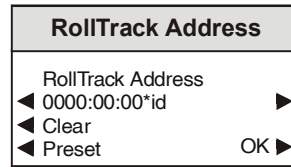

This item allows the RollTrack Address code to be set up using the adjacent push buttons to edit the text.

To edit the text the buttons adjacent to the upper text line in the menu are used to select the character position in the text and the spinwheel used to select the character.

(The right ▶ and left ◀ buttons select the cursor position and the spinwheel selects the character; the clear button sets the text line to all zero's and the OK button accepts the network address)

*For more detailed information see the RollTrack section of this manual.*

The full **RollTrack** address has four sets of numbers

For example: 0000:10:01\*99

The first set (0000) is the network segment code number

The second set (10) is the number identifying the (enclosure/mainframe) unit

The third set (01) is the slot number in the unit

The fourth set (99) is a user settable number that is a unique identification number for the destination unit in a multi-unit system. This ensures that only the correct unit will respond to the command. If left at 00 an incorrectly fitted unit may respond inappropriately.

◀ RollTrack Command

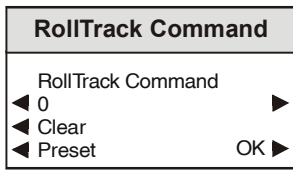

The full **RollTrack** command has two sets of numbers.

For example: 84\*156

The first set (84) is the **RollTrack** command number

*Note that only command numbers 14,15,16 and 17 should be used for audio delay*

The second set (156) is the value sent with the **RollTrack** command number

*Note that when video delay is selected as the **RollTrack** source the value sent with the **RollTrack** command is the video delay value not the value set*

*For details of the RollCall command values for specific units please contact your local Snell & Wilcox agent.*

◀ RollTrack Status

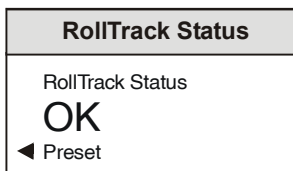

This item will show the status of the RollTrack system.

◀ Unit

This item allows information about the unit to be displayed and other functions to be activated.

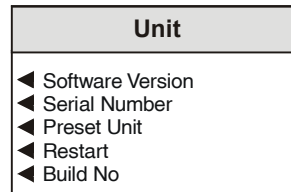

◀ Software version

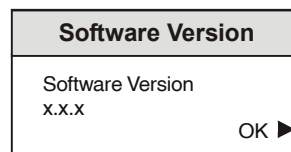

This item shows the version of the software fitted in the module.

◀ Serial Number

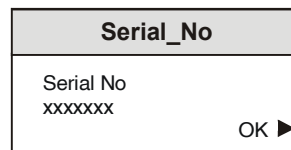

This item shows the serial number of the module

◀ Preset Unit

Selecting this item sets all adjustment functions that include a preset facility, to their preset values.

*Note that this is a momentary action.*

◀ Restart

This will reboot the unit simulating a power-down power-up cycle restoring power-up settings.

◀ Build Number

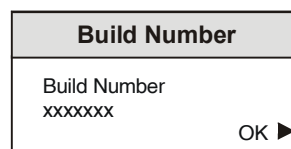

This will indicate the factory build number. This number defines all parameters of the unit (software versions, build level etc.) for identification purposes.

### ◀ Memories

This function allows a number of particular setups of the unit to be saved, recalled, cleared and re-named. There are 8 memory locations available.

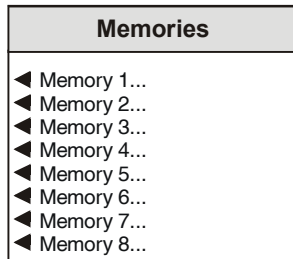

Selecting a memory location will reveal the memory display that allows the current settings to be saved to or recalled from that memory location. The memory location may also be given a specific name.

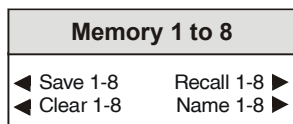

### ◀ Save 1-8

This item will save the current settings in the memory location.

### ◀ Recall 1-8

This item will recall the settings in the memory location.

### ◀ Clear 1-8

This item will return the contents of the memory location to the default (factory) values.

### ◀ Name 1-8

This selection allows renaming of the memory location.

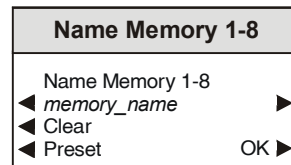

To compile/edit the text the right ▶ and left ◀ buttons adjacent to the upper text line in the menu should be used to select the character position in the text and the spinwheel used to select the character.

The ◀ **Clear** function blanks out the selected character.

The ◀ **Preset** function loads the default text, for example **Memory 1**.

**O.K.** ▶ saves the caption text and returns to the main menu.

### RollCall Control Templates for the IQDAMDA

Each template shows the same information as the information window on the active front panel.

#### Information Window

This window shows the current state of the unit and will show the following abbreviations:

The **first line** shows the status of the input.

This may show the following states:

**In:**   **OK**       Input is present and recognized.  
           **\*\***        No input present.  
           **ERR**     Unrecognized input.

**Std:**   **ERR**     Standard not detected.  
           **PAL**     PAL standard detected.  
           **PAL-N**   PAL-N standard detected.  
           **SECAM**   SECAM standard detected.  
           **NTSC**    NTSC standard detected.  
           **NTSCJ**   NTSC-J standard detected.  
           **PAL-M**    PAL-M standard detected.  
           **N443**     N4.43 standard detected.  
           **525**     525 line standard detected.  
                     No color standard detected.  
           **625**     625 line standard detected.  
                     No color standard detected.

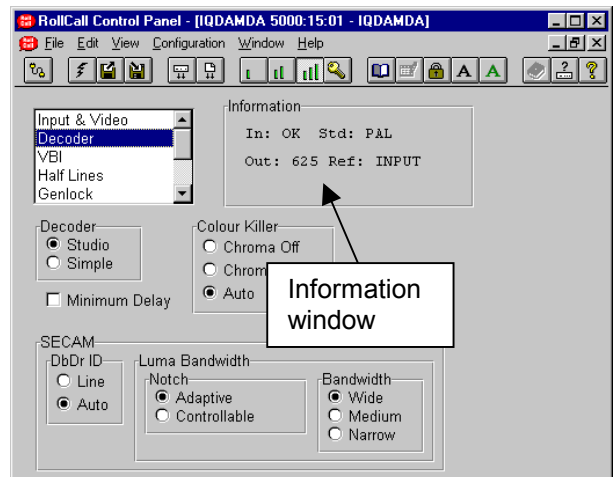

### Information Window (continued)

The **second line** shows the output line standard of the unit and the status of the genlock reference.

This may show the following states:

- Out: 525** Output line standard is 525.  
**625** Output line standard is 625.
- Ref: INPUT** **Lock to Input** has been selected and the unit will be genlocked to the input signal. If there is no input present, the unit will default to **Freerun**.
- ERR** **Lock to Ref** has been selected but the reference signal does not match the input standard. The unit will default to the **Freerun** mode.
- FREE** **Freerun** has been selected and the unit will be locked to an internally generated signal.
- \*\*** **Lock to Ref** has been selected but there is no reference present or it is an unrecognised standard. The unit will default to **Freerun** mode.
- OK** **Lock to Ref** has been selected and the reference standard matches the input standard. The output of the unit will be genlocked to the incoming reference signal.

The **third line** shows the state of various settings.

This may show the following abbreviations:

- PAT** The pattern has been enabled on the video output.
- CAP** The caption has been enabled on the video output.
- BYP** The bypass option has been selected and all video control settings are bypassed.
- CO<sub>n</sub>** The Color Killer Chroma On option has been selected.
- CO<sub>f</sub>** The Color Killer Chroma Off option has been selected.
- FRZ** The freeze function has been selected.

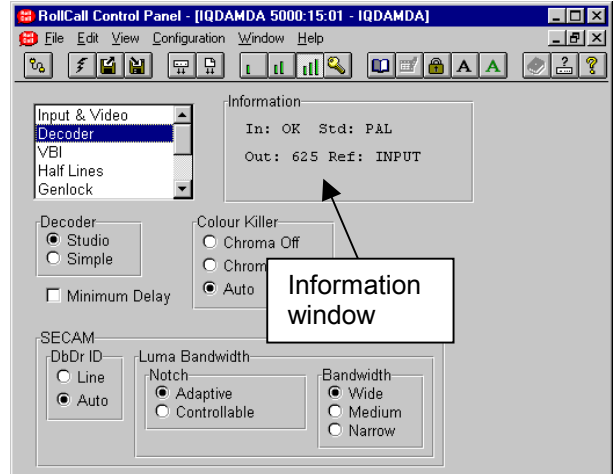



## Input & Video

This screen allows the input standard to be selected and adjustments made to the processing amplifier controls.

### Input Standard

This menu selects the input standards that will be recognized.

625 line standards are listed on the left and 525 line standards on the right. The required standards should be selected and then the decoder will automatically detect between the selected line standards.

### Notes

*When more than one standard has been selected the unit will operate in the auto standards detection mode.*

*If only one of the line standards is selected the IQDAMDA will be forced to that standard when an input line rate of that standard is detected.*

*For noisy input signals it is recommended that only one standard should be selected that matches the standard of the input signal.*

### 625 Line Standards

PAL  
PALN  
SECAM

### 525 Line Standards

NTSC  
NTSCJ  
PALM  
N443

Note that either NTSC **or** NTSCJ may be selected but not both.

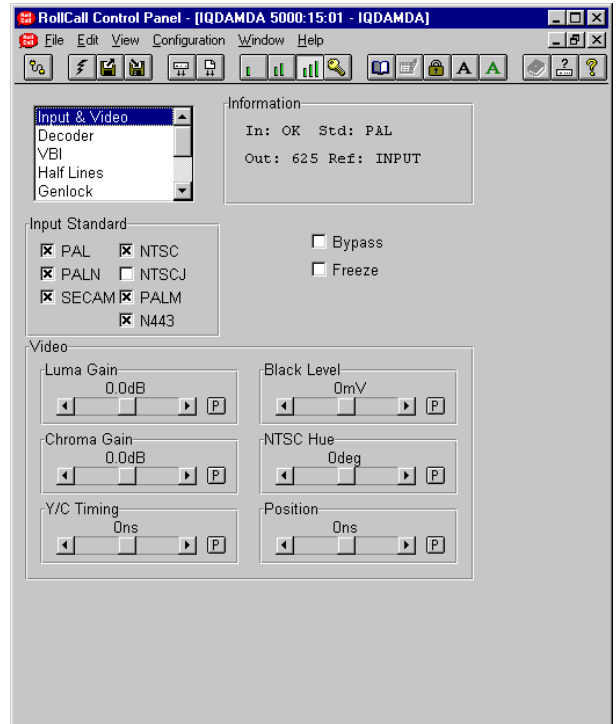

### Bypass

Selecting this item bypasses all video settings i.e. Gain, YC Timing, Black Level, Hue, Position, Caption and Pattern.

When not selected, the video settings will be applied to the signal.

*Note that if video controls are adjusted when Bypass is selected the output will remain unaffected but the template will indicate the settings.*

### Freeze



When selected the output will become a frozen picture of the last picture frame.

## Input & Video (continued)

### Video

*Note that for this and other screens the following applies:*

The  symbol represents the Preset function and will return the function to the default setting.

The  and  symbols at the ends of the scroll bar allow the value to be adjusted in discrete steps.

The numerical value will be shown above the scroll bars.

This screen will allow the settings of the Luma Gain, Black Level, Chroma Gain, Hue, Y/C Timing and Picture position to be adjusted.

#### Luma Gain

This item allows the gain of the luminance signal to be adjusted.

By using the scroll bar the gain may be adjusted by  $\pm 6$  dB in steps of 0.1 dB.

#### Black Level

This item allows the Y pedestal or black level to be adjusted.

By using the scroll bar the pedestal may be adjusted by  $\pm 120$  mV in steps of 1 mV.

#### Chroma Gain

This item allows the gain of the chrominance signal to be adjusted.

By using the scroll bar the gain may be adjusted by  $\pm 6$  dB in steps of 0.1 dB.

#### NTSC Hue

This item allows the Hue of signals to be adjusted.

By using the scroll bar the Hue may be adjusted by  $\pm 45$  deg. in steps of 1 degree.

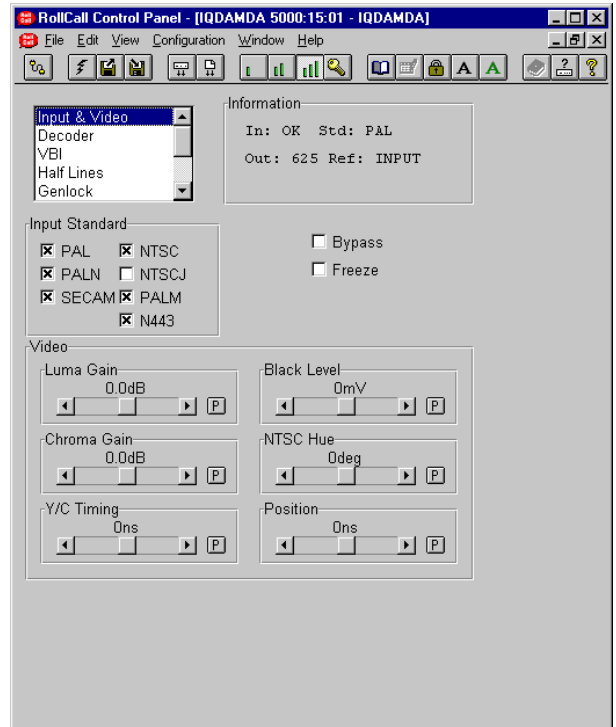

#### Y-C Timing

This item allows the timing of the chrominance signal relative to the luminance signal to be adjusted, (i.e. Y to Cb/Cr timing) in nanoseconds. By using the scroll bar the timing may be adjusted by  $\pm 592$  ns in 148 ns steps.

#### Position

This item allows the timing of the picture position relative to the normal value, to be adjusted. By using the scroll bar the timing may be adjusted by  $\pm 592$  ns in 37 ns steps.

## Decoder

This function allows different decoding modes to be selected.

### Decoder

#### Studio

This mode uses enhanced Golden Gate technology. The composite input is sampled with 12-bit resolution and decoded using adaptive line and frame comb filters to ensure optimum decoding performance.

*Note that when an unstable input is detected the IQDAMDA will automatically change its processing mode to produce the best output picture.*

#### Simple

This simple decode mode incorporates a wide bandwidth subcarrier notch filter. This mode is for reference only and should not be used for normal composite material.

#### Minimum delay

This mode produces the minimum input/output delay and may be used where audio delay problems may exist and cannot be compensated for. It uses the same adaption technique as the Studio mode but has asymmetric frame stores. This mode can be used with both Studio and Simple decoding modes.

*This mode is not recommended for U-matic SECAM or sources containing occasional DbDr phase reversals.*

### Colour Killer

This function controls the color content of the picture.

#### Chroma Off

When selected the color content of the picture will be removed. The luma signal is produced using a narrow bandwidth notch filter.

#### Chroma On

When selected the color content of the picture will be maintained regardless of the level of the color burst.

#### Auto

When this item is enabled the picture will become monochrome if the input color burst disappears or the level drops below a critical amplitude. The picture will return to color when the burst level reappears.

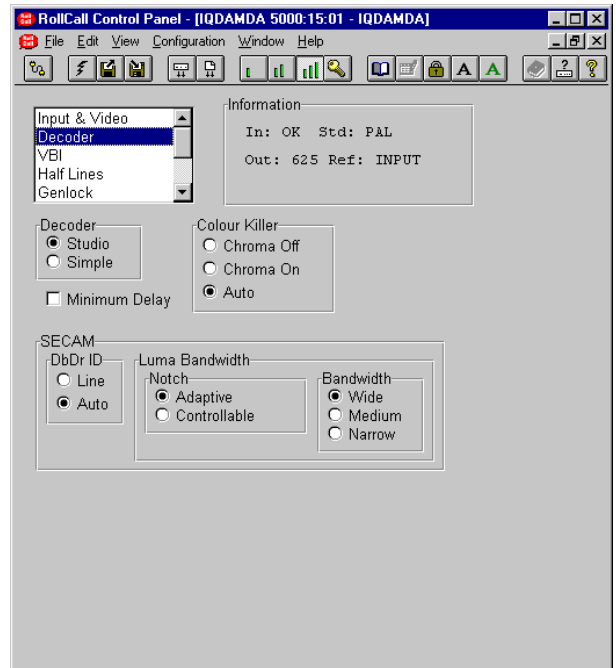

**Decoder (continued)****SECAM**

This function allows adjustments to decoding parameters for a SECAM signal.

**Luma Bandwidth**

This function allows the luminance part of a SECAM signal to be processed in various ways.

**Notch**

Either the Adaptive or the Controllable luminance notch filter may be chosen with this item.

**Bandwidth Control**

This function allows the bandwidth of the decoded luminance to be adjusted when the notch filter is set to Controllable.

**Wide** The signal will be processed at full bandwidth (3.4 MHz).

**Medium** The signal will be processed with a bandwidth of approximately 2.6 MHz.

**Narrow** The signal will be processed with a bandwidth of approximately 1.7 MHz.

**DbDr ID**

This item allows the DbDr sequence of the SECAM signal to be identified in various ways.

**Line**

When selected the DbDr color ident of a SECAM signal will be derived from the bursts of unmodulated chroma on the line sync back porch.

**Auto**

When selected the DbDr sequence will be automatically be derived from the SECAM Bottles if present or Line sync data if bottles cannot be found.

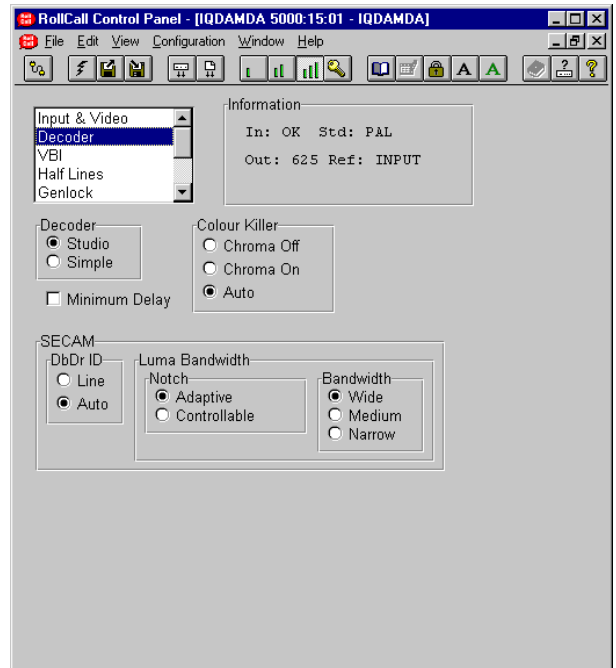

**VBI**

This function allows the user to select which vertical interval lines to pass through to the output and which lines to blank.

**525 Pass**

This section allows lines 10 to 20 and lines 273 to 282 of 525 line signals to be selected and passed through to the output by checking the appropriate box.

**625 Pass**

This section allows lines 6 to 22 and lines 318 to 335 of 625 line signals to be selected and passed through to the output by checking the appropriate box.

**All**

This section allows all vertical interval lines to be selected and either passed to or blanked from the output signal.

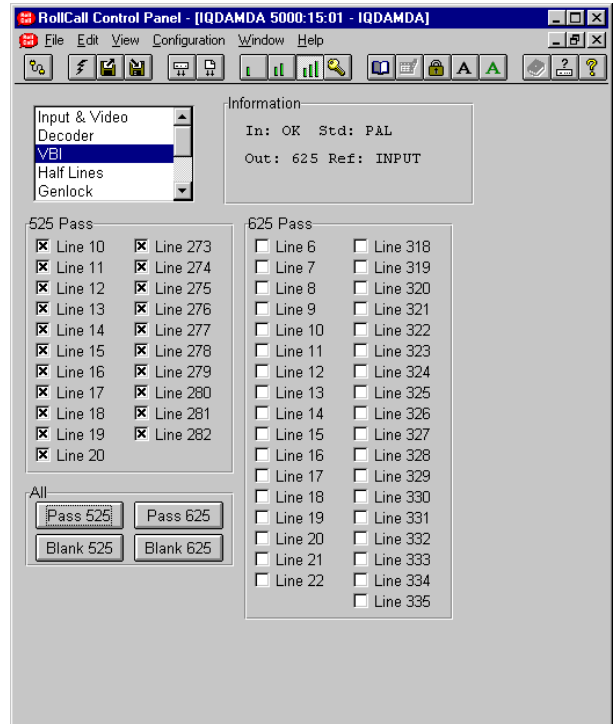
**Pass 525**

Selecting this item will select all vertical interval lines in the 525 line list and allow them to passed through to the output.

**Pass 625**

Selecting this item will select all vertical interval lines in the 625 line list and allow them to passed through to the output.

**Blank 525**

Selecting this item will select all vertical interval lines in the 525 line list and blank them from the output.

**Blank 625**

Selecting this item will select all vertical interval lines in the 625 line list and blank them from the output.

## Half Lines

The method of processing specific lines may be chosen from this section.

### 525 Line 21

Line 21 of 525 line signals may be processed as

Picture

When enabled, line 21 of the input signal will be processed and the ProcAmp controls will effect these lines.

Blank All

When enabled, line 21 of the input signal will be blanked from the output.

Closed Caption

This item controls the processing of closed captioning information on lines 21 of incoming 525 line video signals. When enabled the luminance will be decoded and the chrominance will be blanked.

*Note that only one of these items may be selected.*

### 525 Line 283

Line 283 of 525 line signals may be processed as

Blank Half

When selected, the first half of line 283 will be blanked from the output and the second half is decoded and passed as picture.

Blank All

When enabled, line 283 of the input signal will be blanked from the output.

Closed Caption

This item controls the processing of closed captioning information on lines 283 of incoming 525 line video signals. When enabled the luminance will be decoded and the chrominance will be blanked.

*Note that only one of these items may be selected.*

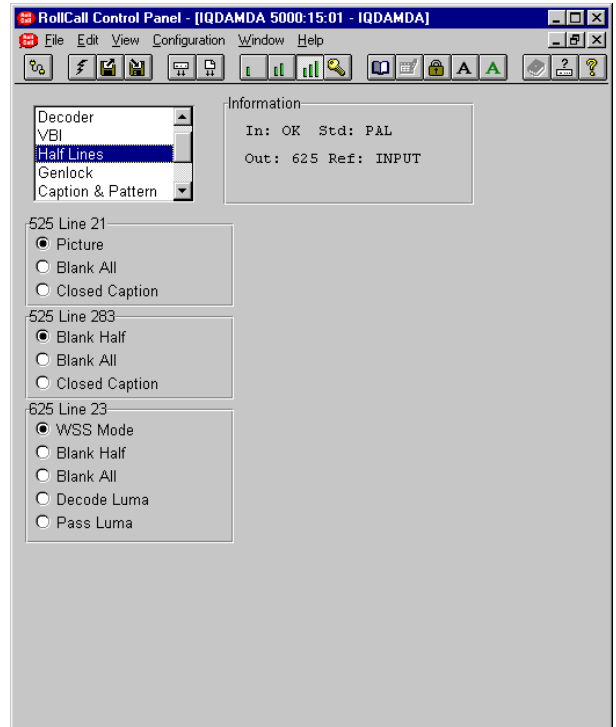

### 625 Line 23

Line 23 of 625 line signals may be processed as

WSS Mode

When selected, the luminance of the first half of the line will be decoded and the chrominance will be blanked; the second half of the line will be treated as picture and decoded.

Blank Half

When selected, the first half of line 23 will be blanked from the output and the second half is decoded and passed as picture.

Blank All

When enabled, line 23 of the input signal will be blanked from the output.

Decode Luma

When selected, the luminance will be decoded and then passed through to the output. The chrominance is blanked.

Pass Luma

When selected, the luminance will be passed directly through to the output without being decoded. The chrominance is blanked.

*Note that only one of these items may be selected.*

## Genlock

This item allows Genlock function settings to be selected.

### Lock to Ref

When this item is selected (text highlighted) the unit will lock to a valid signal connected to the Reference input.

### Lock to Input

When this item is selected the unit will lock to the input signal.

### Free Run

When enabled the output signal will be free running and locked to an internally generated signal.

In this mode the frequency will be that set by the **Freerun Frequency** control.

### 625 and 525 H Phase

This item shows the horizontal timing of the output signal relative to the reference sync signal, in microseconds.

By using the scroll bar the value may be adjusted. The range of control is  $\pm 32\mu\text{s}$  in 37ns steps.

Selecting Preset returns the setting to zero (output coincident with reference).

*Note that the Preset Unit function in the Setup menu will not change this setting.*

### 625 and 525 V Phase

This item shows the vertical timing of the output signal relative to the reference sync signal, in picture lines.

The range of control is  $\pm 262/312$  lines in 1 line steps (525/625).

Selecting Preset returns the setting to zero (output coincident with reference).

### Freerun Frequency

The range of control is  $\pm 60$  units representing a change in frequency of approximately  $\pm 15$  ppm.

Preset returns the unit to the factory calibrated frequency.

*Note that the Preset Unit function in the Setup menu will not change this setting.*

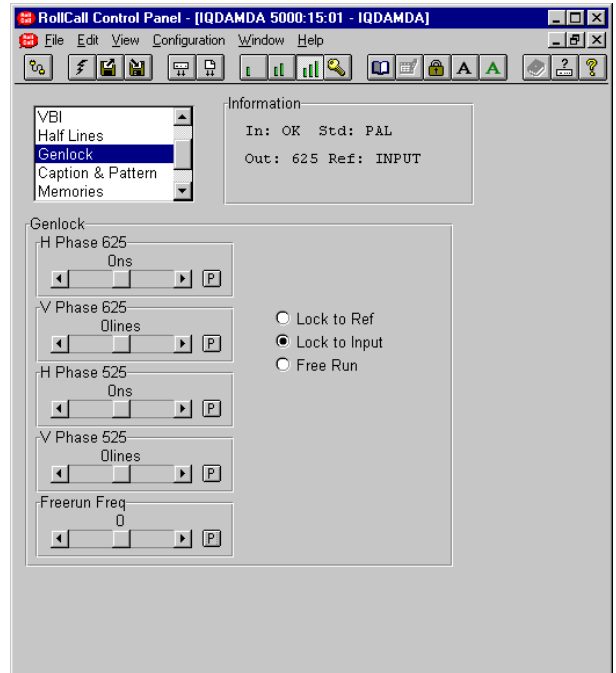

**Caption & Pattern**

This function will allow a caption to be edited and selected and various patterns to be used as the output signal when the Pattern On function is selected.

**Caption**

This function allows control of the caption.

Edit caption

To change the caption, type the new text in the text area and then select  (return).

Selecting Preset  will return the text to the default text (IQDAMDA).

**Select Caption**

- Caption Off      The caption will not appear
- Caption On        The caption will appear on screen

**Pattern**

Pattern On

When selected the output will become the pattern selected from the **Pattern Select** list.

Pattern Select

One of the patterns (including Black) may be selected from the list.

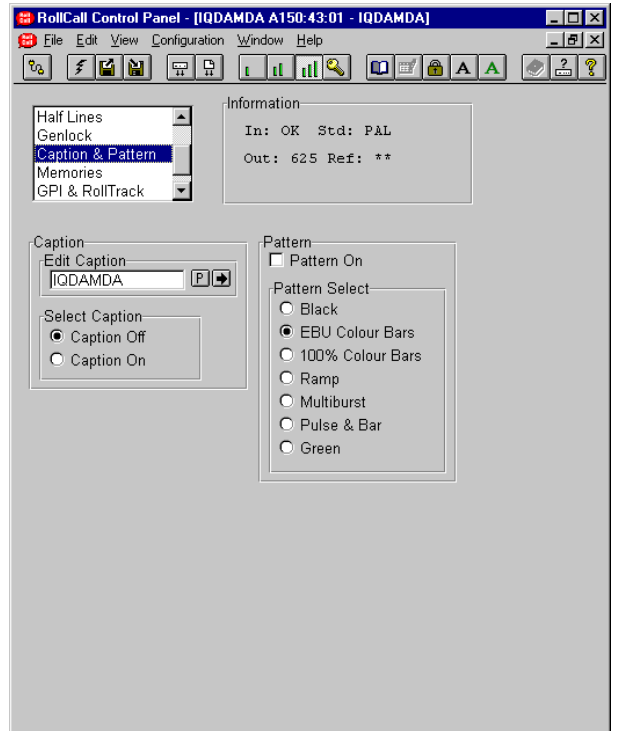



**Memories**

This function allows a number of particular setups of the unit to be saved and recalled. There are 8 memory locations available.

To change the memory name, type the new name in the text area and then select  (return).

Selecting Preset  will return the text to the default name.



This item allows the memory location to be cleared and returned to the default (preset) setting.



This function allows the settings of all items to be saved at the memory location.



This function allows the settings saved at the memory location to be recalled.

*Note that all the above functions are a momentary action.*

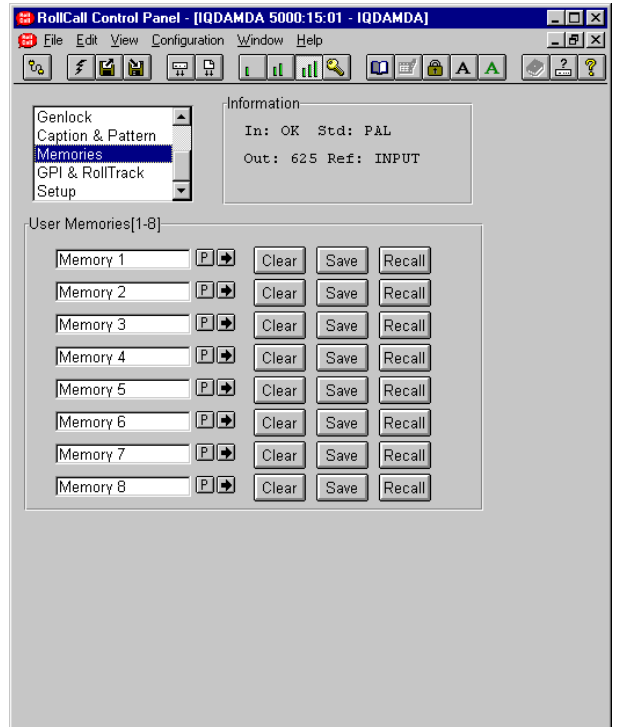

## GPI & RollTrack

### GPI

This screen allows the GPI functions to be configured and their actions defined.

#### Input Functions

When configured as an input the GPI connection may be used for accepting GPI information (from mechanical switch contacts, relay contacts etc.) The resulting action that the unit takes may be selected using this item.

The GPI input functions that may be selected are as follows:

- |               |  |
|---------------|--|
| Unused        | The unit will perform no function. This is also the Preset Setting.  |
| Pattern       | The unit will produce a pattern chosen from the Pattern menu when the input changes from open to closed.   |
| Memory 1 to 8 | The unit will use the settings in the selected memory location when the input changes from open to closed.   |
| Mem1-2        | The unit will toggle between the settings of memory locations 1 and 2.<br>Open to Closed = Memory 1 settings<br>Closed to Open = Memory 2 settings |
| Mem 3-4       | The unit will toggle between the settings of memory locations 3 and 4.<br>Open to Closed = Memory 3 settings<br>Closed to Open = Memory 4 settings |
| Mem 5-6       | The unit will toggle between the settings of memory locations 5 and 6.<br>Open to Closed = Memory 5 settings<br>Closed to Open = Memory 6 settings |
| Mem 7-8       | The unit will toggle between the settings of memory locations 7 and 8.<br>Open to Closed = Memory 7 settings<br>Closed to Open = Memory 8 settings |

#### Disable Inputs

When selected all GPI input functions will be disabled.

#### GPI In Status

This will display the current status of the selected GPI input.

This may show either High or Low. When low, the associated function will be triggered.

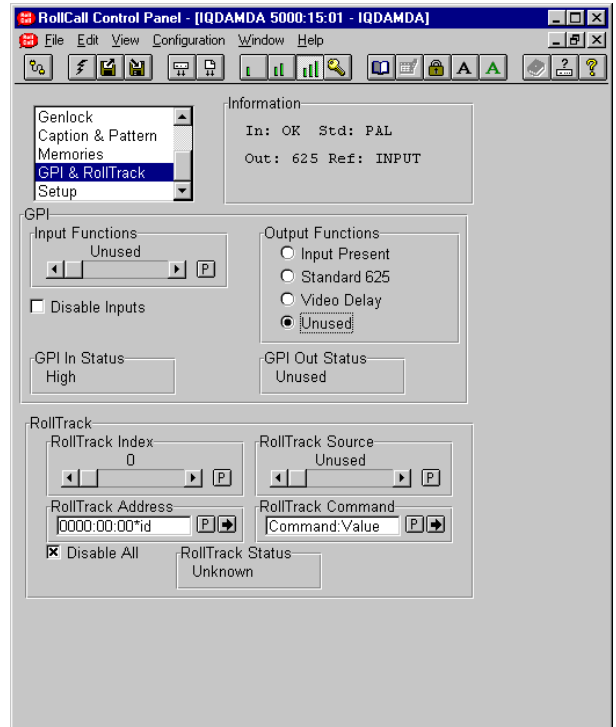

#### Output Functions

The GPO may be configured to produce an output corresponding to one of the following conditions:

- Input Present
- Standard 625
- Video Delay
- Unused

When the condition is not true the output will float but when the condition is true the output is closed to ground via a transistor.

*Note that when video delay mode is selected the output is a positive going TTL pulse. The width of the pulse represents the video delay through the unit to the nearest millisecond.*

The preset setting for the output is Unused.

#### GPI Out Status

This will display the current status of the GPI output.

This may show either Unused, Open, Closed or video delay in milliseconds.

**GPI & RollTrack (continued)**

**RollTrack**

This function allows information to be sent, via the RollCall™ network, to other compatible units connected on the same network.

For example, it can enable compatible audio delay units to produce an audio delay dependent on this and other similar units. The audio delay unit will dynamically follow or track the received delay-time information. This allows processed video signals to be timed correctly with audio signals. This automatic tracking system via the RollCall™ network is call **RollTrack**.

*For more detailed information, see the RollTrack section (Appendix) at the end of this manual.*

**RollTrack Index**

This item allows up to 16 destinations to be selected.

**RollTrack Source**

This allows the source of information that triggers the transmission of data to be selected. Options are:

- |                |                   |
|----------------|-------------------|
| Unused (off)   | Input Missing     |
| Video Delay    | Standard 525      |
| Input Present  | Standard 625      |
| Reference lost | Reference present |

The destination for the information is set by the network code address as follows:

**Network Address**

This item allows the address of the selected destination unit to be set.

To change the address, type the new destination in the text area and then select  (return)

 (Preset) returns to the default destination

The full **RollTrack** address has four sets of numbers

For example: 0000:10:01\*99

The first set (0000) is the network segment code number

The second set (10) is the number identifying the (enclosure/mainframe) unit.

The third set (01) is the slot number in the unit

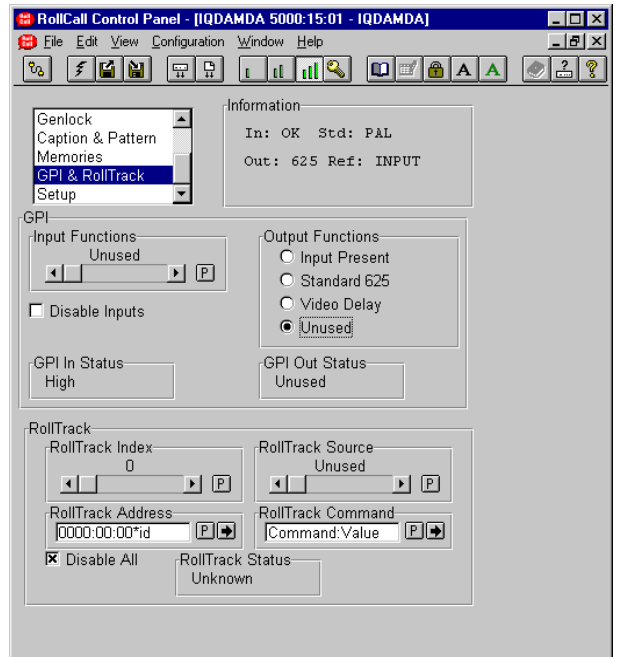

The fourth set (99) is a user settable number that is a unique identification number for the destination unit in a multi-unit system. This ensures that only the correct unit will respond to the command. If left at 00 an incorrectly fitted unit may respond inappropriately.

**RollTrack Command**

The full **RollTrack** command has two sets of numbers

For example: 84\*156

The first set (84) is the **RollTrack** command number

*Note that only command numbers 14,15,16 and 17 should be used for audio delay*

The second set (156) is the value sent with the **RollTrack** command number

*Note that when video delay is selected as the RollTrack source the value sent with the RollTrack command is the video delay value not the value set.*

*For details of the RollCall command values for specific units please contact your local Snell & Wilcox agent.*

**Disable**

When this item is checked all RollTrack items will be disabled.

**RollTrack Status**

This item will show the status of the RollTrack system.

**Setup**

**Logging**

If a logging device is attached to the RollCall™ network, information about various parameters can be made available to such a device.

This screen allows information about the **Input State**, and the **Input Standard** to be made available for logging by selecting the appropriate box or boxes.

**Default Output**

If the input signal fails or is of poor quality this function will determine what the output signal will become under such conditions.

Video

If the input signal is of poor quality the unit will attempt to provide the best possible output picture. If the input signal has failed completely the unit will provide a fully formatted output but with undefined picture.

Freeze

If the input signal fails or is of poor quality the unit will produce a frozen picture.

Pattern

If the input signal fails or is of poor quality the output will become a pattern chosen from the **Default Pattern** list.

**Default Pattern**

The default pattern may be chosen from this list.

Preset Unit

Selecting this item sets all adjustment functions that include a preset facility, to their preset values.

*Note that this is a momentary action.*

Restart

This will reboot the unit simulating a power-down power-up cycle restoring power-up settings.

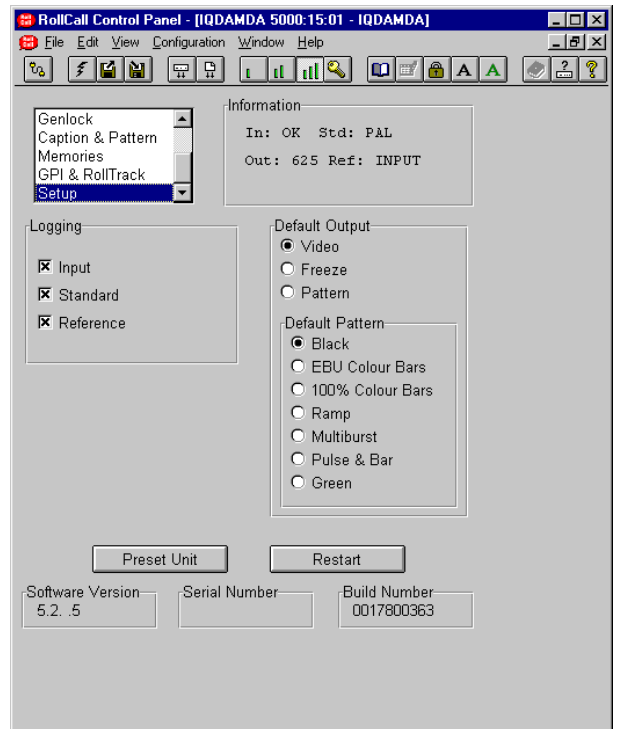

**Software version**

This item shows the version of the software fitted in the module.

**Serial Number**

This item shows the serial number of the module

**Build Number**

This will indicate the factory build number. This number defines all parameters of the unit (software versions, build level etc.) for identification purposes.

## RollTrack Audio Delay Tracking

RollTrack is a feature of RollCall™ (Snell & Wilcox's proprietary remote control system), that allows devices to communicate across the RollCall network with no direct user intervention.

RollTrack Audio Delay Tracking enables Snell & Wilcox RollCall™ compatible audio delay products to track delay introduced by RollCall™ compatible video processing products.

The current products that implement RollTrack Audio Delay Tracking are:

Audio Delay Modules	Video Modules	Other Products	
IQBAAD	IQD1FSY	ALCHEMIST	MDD3000
IQBADC	IQDMSDS	CPP100	MDD550
IQBDAC	IQDAFS	CPP200	MDD560
IQBDAD	IQDMSDS	NRS500	MDD570
IQBSYN	IQDMSDP	HD5050	MDD2000
IQBADCD	IQDSYN		

The simplest configuration is a single video unit and a single audio delay in a RollCall™ system. The audio delay will have the same delay as through the video path. If the delay changes the audio delay will track.

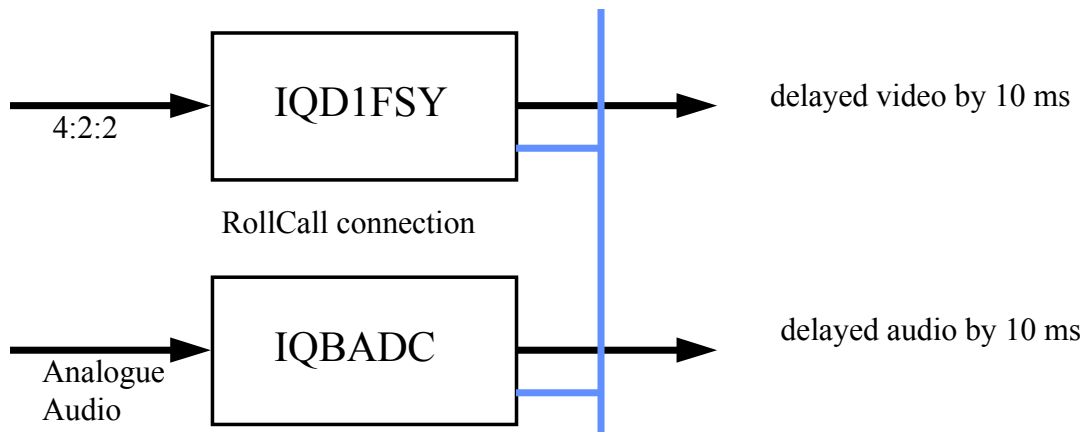

The next level of configuration is where there are multiple Frame Synchronizers (for example) each connected through RollCall™ to their own tracking Audio Delay. (It is worth stating that the synchronizers and audio delays do not have to be in the same enclosure; the addressing scheme, discussed later, allows for the units to be positioned anywhere in the RollCall™ domain.)

The maximum number of video units and audio delays in a RollCall™ system is set by the maximum limit of the number of modules in a RollCall™ network and is currently 3840 on a single network without bridges.

The unique identification of the destination unit (a decimal number) for various modules is as follows:

Module	ID
IQBADC	51
IQBDAC	52
IQBAAD	53
IQBDAD	54
IQBSYN	89
IQBADCD	107

The next level of complexity is a *vertical delay cluster* where a video unit can have up to eight audio delays tracking - of the same or different types.

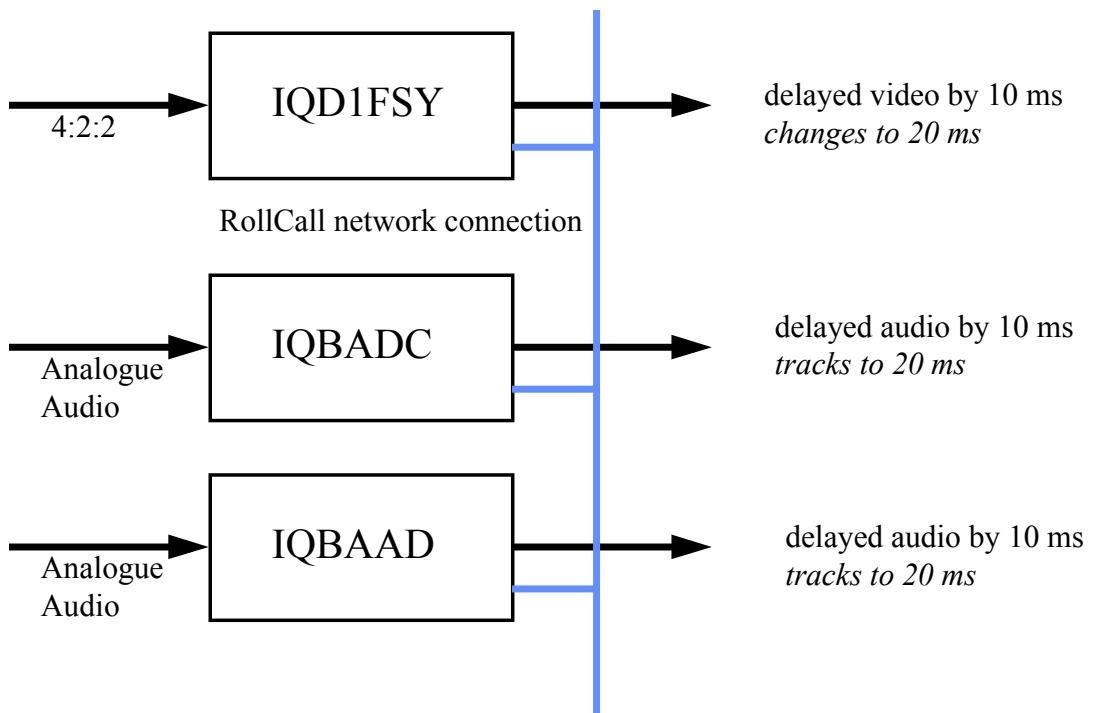

From one to eight audio delay products can be connected via RollCall™ to a single frame synchronizer, for example. If the synchronizer delay changes, then however many audio delays are connected will track the delay. The audio delays can also have a manual delay which will be added to the RollTrack delay.

The next level of complexity is a *horizontal delay cluster* where an audio delay can track up to four video units.

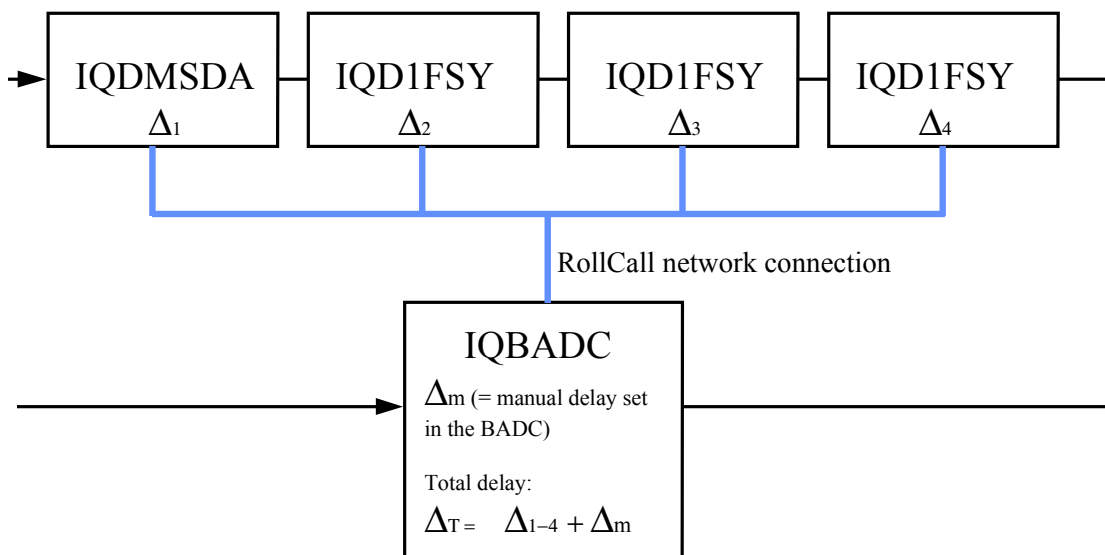

The total delay time through the audio delay is then the sum of the individual delays introduced by the video units plus the manual delay of the audio unit. The manual delay can be set to compensate for any fixed propagation delay in the video path or may be set to zero.

The next level of complexity is a *matrix delay cluster* where each audio delay (up to eight) can track up to four video units. This configuration is in effect a four by eight matrix of video units and audio delay units. The total delay time through the audio delay units is then the sum of the individual delays introduced by the video units plus the manual delay of the audio unit.

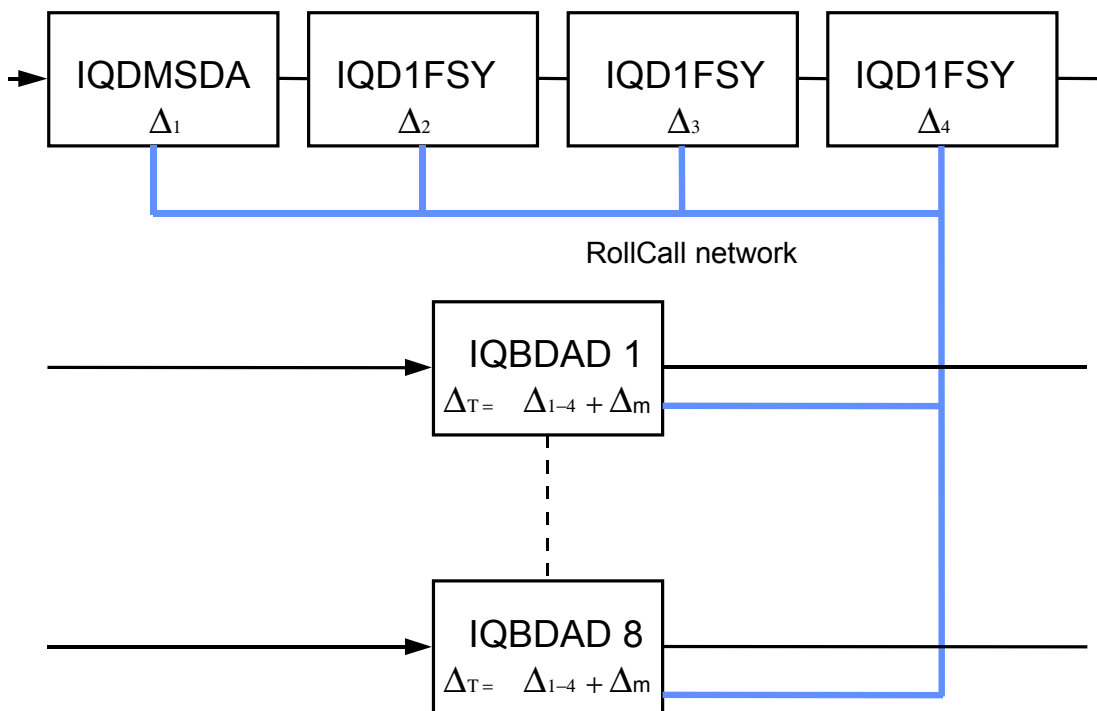

As any of the delay times change in the video path so will the audio delay time track this delay. A virtual connection is made between from, say, an IQD1FSY to an IQBDAD by:

- selecting the *Setup...* Menu of the IQD1FSY
- then selecting the *Audio\_Delay...* Menu
- then choosing from *Unit\_1 to Unit\_8*
- then entering the unique network address of the IQBDAD in the form *nnnn:xx:yy\*z\*d*
- where *nnnn* = network address and in most cases will be 0000(hex);
- xx* = IQ enclosure address (hex);
- yy* = slot address of the IQBDAD (hex)
- z* = the connection (or channel) number (decimal) - see table below.
- d* = the unique identification of the destination unit (decimal) The ID entered must match the receiving units own ID or else the command will be ignored. If the ID value is set to 00, the receiving unit does not perform an ID match and will always accept the incoming command
- then selecting the *Delay...* Menu of the IQBDAD
- then selecting *RollTrack*

Example of Network Addresses with Channel Numbers and ID Numbers

	D1FSY 1	D1FSY 2	D1FSY 3	D1FSY 4
<b>Audio delay 1</b>	0000:10:01*14*54	0000:10:01*15*54	0000:10:01*16*54	0000:10:01*17*54
<b>Audio delay 2</b>	0000:10:03*14*54	0000:10:03*15*54	0000:10:03*16*54	0000:10:03*17*54
<b>Audio delay 3</b>	0000:10:05*14*54	0000:10:05*15*54	0000:10:05*16*54	0000:10:05*17*54
<b>Audio delay 4</b>	0000:10:07*14*54	0000:10:07*15*54	0000:10:07*16*54	0000:10:07*17*54
<b>Audio delay 5</b>	0000:10:09*14*54	0000:10:09*15*54	0000:10:09*16*54	0000:10:09*17*54
<b>Audio delay 6</b>	0000:10:0B*14*54	0000:10:0B*15*54	0000:10:0B*16*54	0000:10:0B*17*54
<b>Audio delay 7</b>	0000:10:0D*14*54	0000:10:0D*15*54	0000:10:0D*16*54	0000:10:0D*17*54
<b>Audio delay 8</b>	0000:10:0F*14*54	0000:10:0F*15*54	0000:10:0F*16*54	0000:10:0F*17*54

The most complex system would be an array of matrix delay clusters

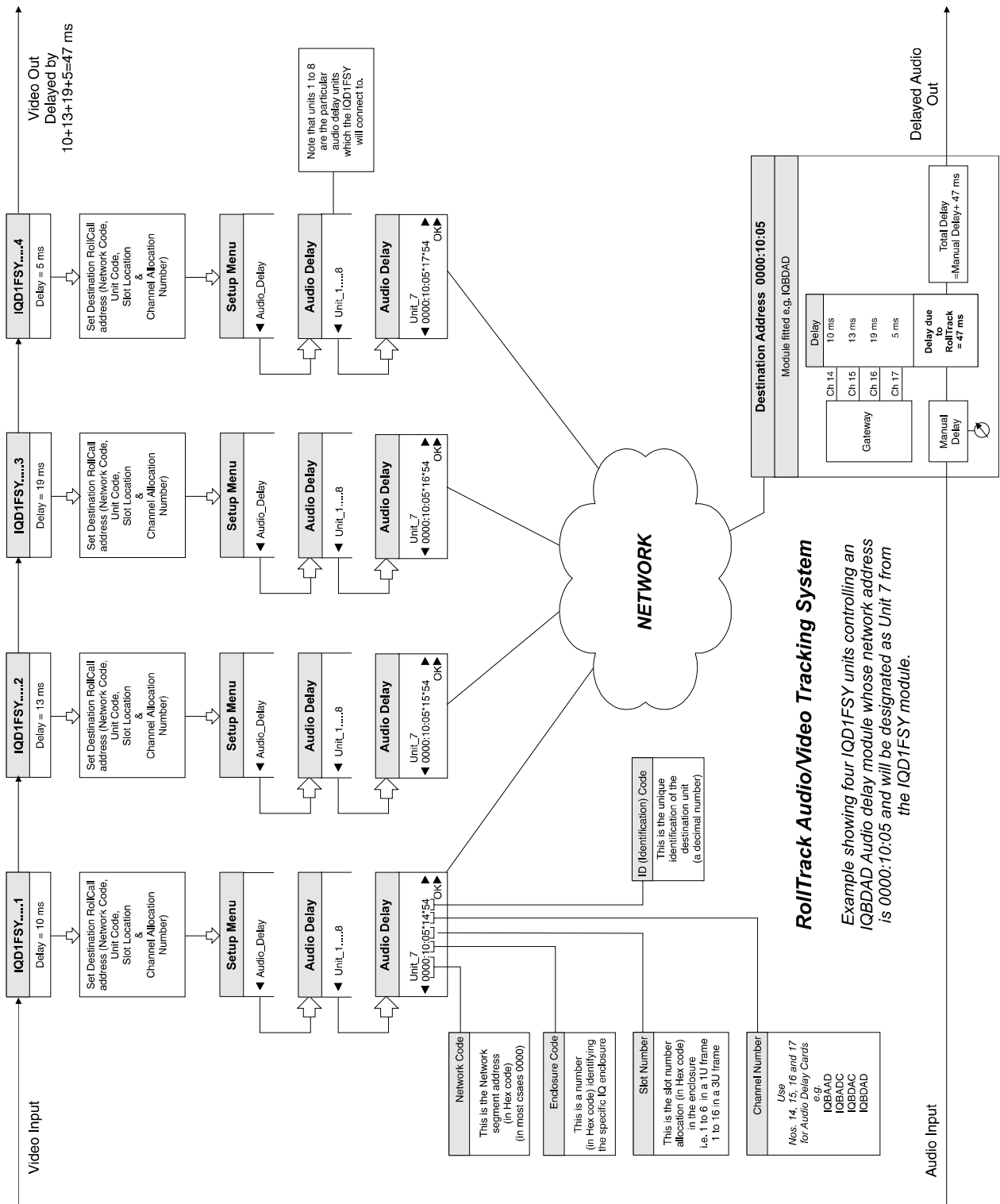



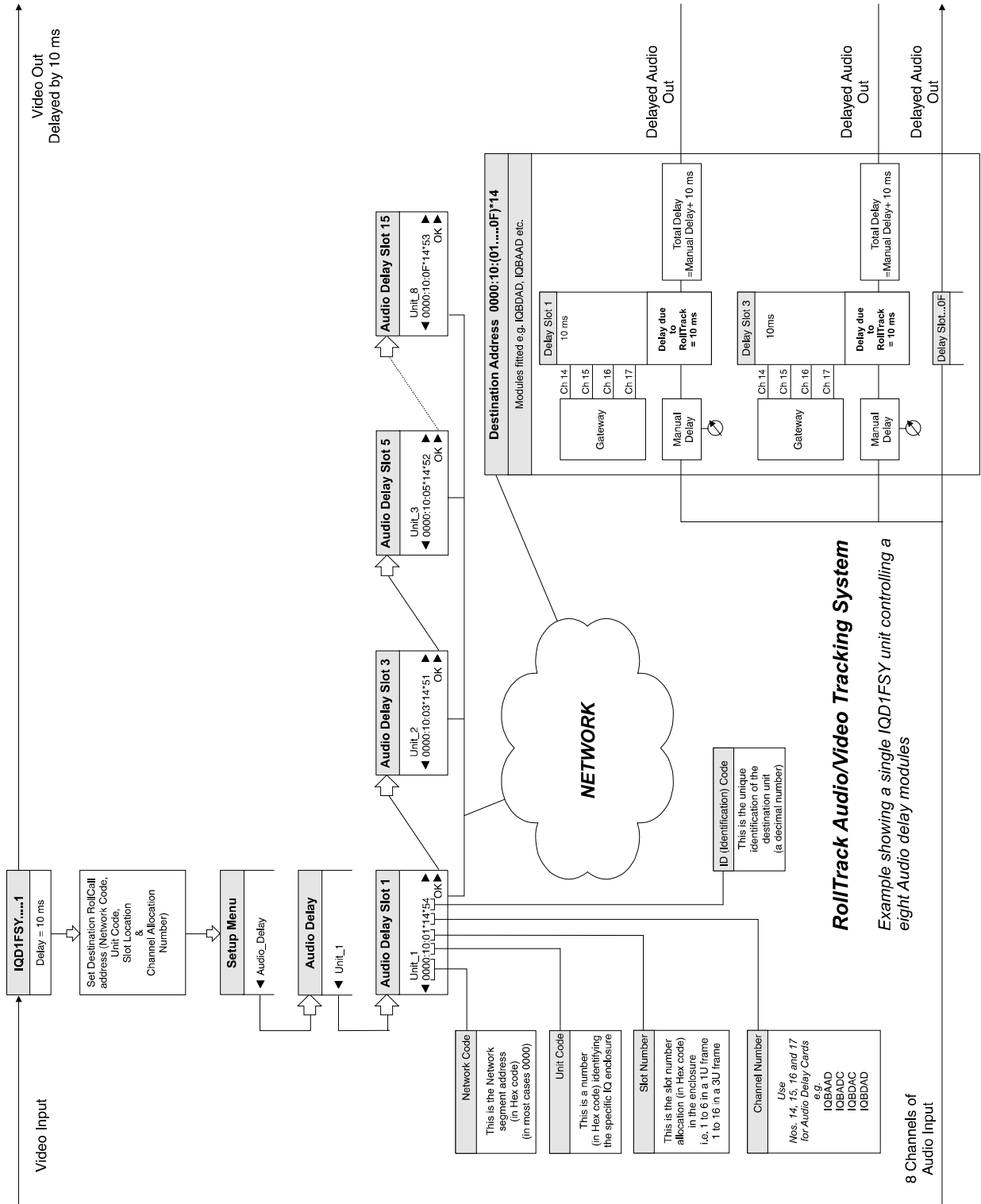

### ***Manual Revision Record***

Date	Version No.	Issue No.	Change	Comments
111102	1	1		First issue released
280303	1	2	Power consumption added to techspec	New manual issued
010703	1	3	Module description corrected P1	New manual issued