

IQDEC03**Composite Decoder, Synchronizer, Audio Embedder with
Noise Reduction and Auxiliary SDI Input – 12 bit****Table of Contents**

Module Description	2	Audio Setup	27
Rear Panel View	2	Genlock	30
Product Comparison.....	3	VBI & HANC Blank(ing)	32
Block Diagram.....	5	Caption & Pattern	34
Features.....	5	GPI.....	36
Technical Profile	6	RollTrack	38
INPUT CONNECTIONS	9	Memories	40
SERIAL IN	9	Logging	41
COMP IN A and B (-2 version)	9	ROLLCALL LOG FIELDS	42
COMPOSITE A and B (-2A version)	9	Setup	44
Separated Y C (-2 and -2A versions)	9	Operation from an Active Control Panel	47
ANALOG AUDIO IN	9	MAIN MENU	51
REFERENCE	10	Video.....	51
GPI (-2A only).....	10	Decoder.....	55
OUTPUTS.....	11	Freeze.....	56
Serial Digital Video Outputs	11	Audio.....	57
AES OUT (-2 version)	11	Genlock.....	63
AES OUT (-2A version)	11	Setup.....	65
25 Way D Type Connection Details	12	Pattern.....	65
CARD EDGE INDICATORS	14	Caption	66
RollCall PC Control Panel Screens.....	15	VBI & HANC Blank(ing).....	67
Video	15	GPI I/O	70
ProcAmp.....	17	RollTrack	72
Decoder	19	Logging.....	74
De-embed Pair 1-4 and 5-8.....	21	ROLLCALL LOG FIELDS.....	75
Analog Audio Pair 1-2	22	Default Output	77
Audio Mixer 1, 2, 3 and 4	23	Information Window.....	77
Audio Bus A and B	24	User Mem(ories).....	79
Audio Outputs.....	25	IQDEC03 RollCall Commands	80
Audio Delay Setup.....	26	RollTrack Audio Delay Tracking.....	87
		Appendix 1 The Firewall	92
		Manual Revision Record.....	94

Module Description

The IQDEC03 provides a complete analog front-end with 12-bit composite decoding, synchronization and analog audio ingest in one compact module. It is ideal for providing the bridge between analog legacy operations and digital environments. When paired with an upconverter this module completes the bridge between analog and HD domains. What makes the IQDEC03 so powerful for these applications are using adaptive 2D filtering. The IQDEC03 handles most composite analog signal formats including PAL, NTSC-M, NTSC-J, PALN, N4.43, PAL60, PALM and SECAM. The full frame synchronizer with horizontal and vertical phasing controls allows the output to be timed to your house or studio

reference. In addition to its awesome video performance, the IQDEC03 can digitize up to 4 channels of analog audio for both embedding into the SDI stream and outputting as two AES streams. What is more, an auxiliary SDI input is included so that the IQDEC03 can be easily integrated into mixed analog/digital environments. Proc. amp controls and a powerful built-in noise reducer complete the specification. The noise reduction is targeted at preserving the original content while eliminating the objectionable artifacts of analog working. The noise reduction algorithms are tuned to ensure optimum quality and lowest bit-rates if the signal is subsequently compressed.

Rear Panel View

IQDEC0318-2A

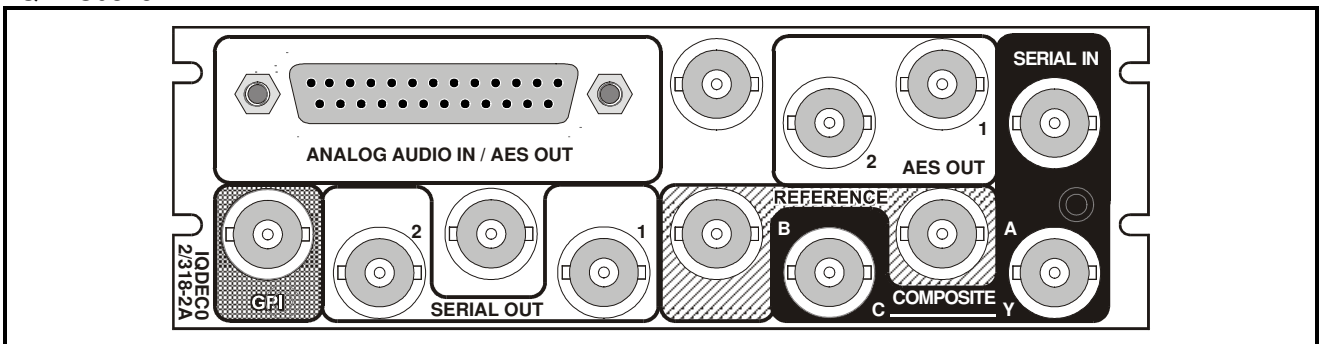

IQDEC0316-2

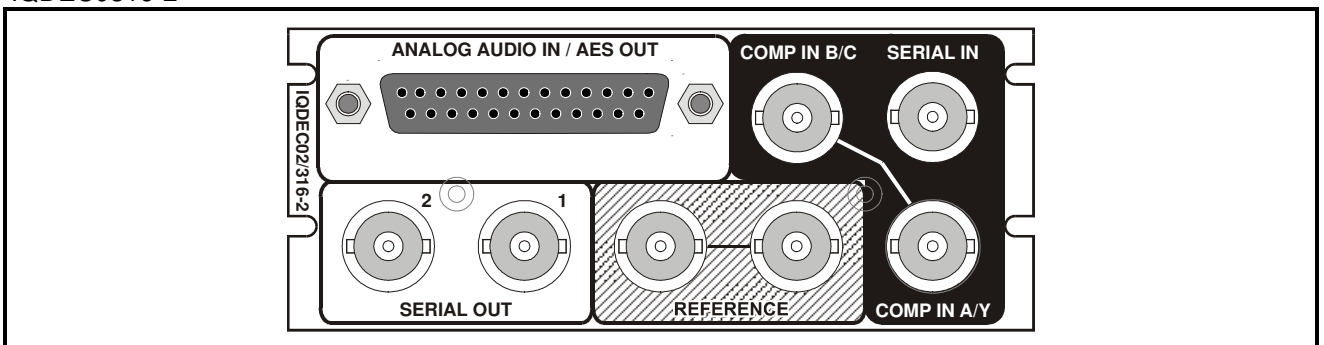

This manual covers the following products:

IQDEC0318-2A 12 bit decoder with synchronizer, analog audio embedder and noise reduction. 2 composite, 1 Y/C and 1 SDI inputs, 2 SDI outputs, 4 analog audio inputs, 2 AES outputs (balanced, on 25D, and unbalanced on 25D and BNC)

IQDEC0316-2 12 bit decoder with synchronizer, analog audio embedder and noise reduction. 2 composite, 1 Y/C and 1 SDI inputs, 2 SDI outputs, 4 analog audio inputs, 2 AES outputs (balanced and unbalanced on 25D)

Product Comparison

Product	CVBS Inputs	Y/C Inputs	SDI Inputs	Analog Inputs		AES Outputs		SDI Outputs	GPI	Genlock	Width & Style
IQDEC0318-2A	2	1	1	4	BAL	2 2+2	BAL U/B	2	1	Loop-through	Double A
IQDEC0316-2	2	1	1	4	BAL	2 2	BAL U/B	2	No	Loop-through	Double 0

Note that there are two styles of rear panels available. They are not interchangeable between the two styles of enclosures. However, the cards may be fitted into any style of enclosure.

‘A’ Style Enclosure

Rear panels **with** the suffix A may only be fitted into the ‘A’ style enclosure shown below.

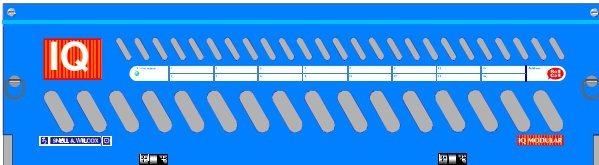

(Enclosure order codes IQH3A-E-0, IQH3A-E-P, IQH3A-0-0, IQH3A-0-P)



(Enclosure order codes IQH3A-S-0, IQH3A-S-P)

‘O’ Style Enclosures

Rear panels **without** the suffix A may only be fitted into the ‘O’ style enclosures shown below.

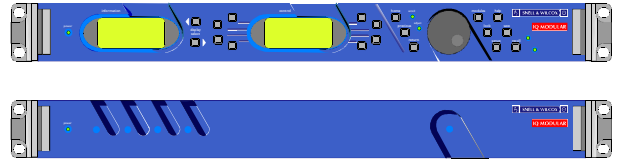

(Enclosure order codes IQH1S-RC-0, IQH1S-RC-AP, IQH1U-RC-0, IQH1U-RC-AP, Kudos Plus Products)

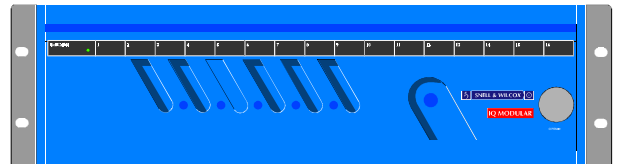

(Enclosure order codes IQH3N-0, IQH3N-P)



(Enclosure order codes IQH3U-RC-0, IQH3U-RC-P)

Block Diagram

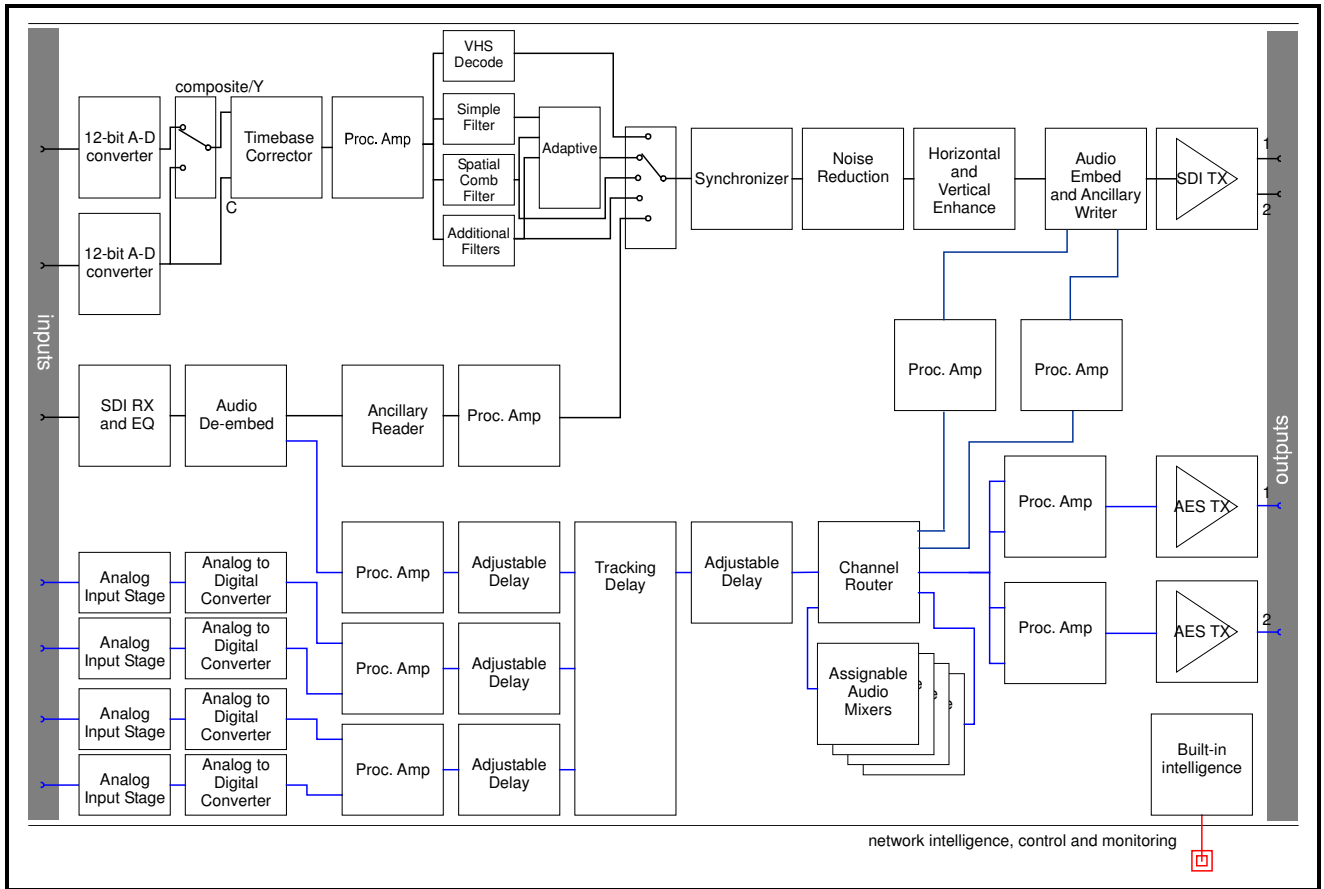

Features

- 12-bit multi-standard decoder with frame synchronizer and analog audio embedder
- Adaptive line comb decoding
- Input standards – PAL*, NTSC*, NTSC-J, N4.43, PAL60, PALN*, PALM* or SECAM*
- *Auto detection of input standards
- Minimal delay through the unit - < 7 lines (lock to input, decoder and noise reducer in minimum delay mode)
- Firewall for video and processed PCM audio to provide a continuous valid output
- Motion adaptive recursive noise reducer with automatic noise floor measurement
- Horizontal and vertical enhancer
- VHS mode: Rugged sync and clock recovery ensures reliable operation for VHS playback and other noisy or unstable inputs
- Y/C input, composite and SDI inputs available
- SECAM adaptive notch and chroma median filters
- Selectable default output on loss of input - Frame freeze, pattern or input pass
- Selectable VBI pass through (pass flat or blank for each VITS line)
- Adjustment of video gain, black level, chroma gain, NTSC hue, horizontal Y/C timing and picture position
- A total of 4 channels of embedded audio can be processed, 2 pairs selectable from any of the four groups
- 4 x assignable 8 channel audio mixers
- Flexible audio delay features including:
 - Tracking audio delay to keep audio in perfect sync with its associated video
 - Up to 1.5s of audio delay for each external audio input pair
 - Additional variable audio delay offset of up to 2.5s, common to all processed audio
- Full audio proc-amp including - gain, mute, polarity invert, and channel routing

Technical Profile

Signal Inputs

Composite Video2 via BNC connectors, isolated
 Y-C1 via BNC connectors
 Serial Digital1 via BNC connectors
 Analog Audio4 Channels (2 Stereo Pairs) via
 25D connector
 StandardsPAL/NTSC//NTSC-J/PAL-M
 /PAL-N/SECAM/N4.43
 Reference1 analog loop through via BNC
 connectors

Signal Outputs

Serial Digital 2 x SDI via BNC connectors
 AES Audio 2 pairs (4 channels) balanced and
 unbalanced via 25D and
 unbalanced via BNC connectors
 (Note: Compatible with PCM
 embedded audio sources only)
 Standards SMPTE 259M-C-1997, SMPTE
 272M-A-1994, AES3-1992

Control Interface

GPI/OClosing contact input/output via
 BNC connector

Card Edge Controls

None

Card Edge Indicators

CPU running/PowerFlashing = OK
 Analog Video PresentLost = Off, Good = On (Green)
 SDI PresentLost = Off, Good = On (Green)
 Analog Video ErrorGood = Off, Error = On (Yellow)
 SDI ErrorGood = Off, Error = On (Yellow)
 Reference PresentLost = Off, Good = On (Green)
 Reference ErrorGood = Off, Error = On (Yellow)

Channel Mixing Mixer channels routed from analog
 pair 1, analog pair 2, test tone and
 SDI
 Output Side Control Proc... Independent Gain, Mute, Polarity &
 Mono control over embedded and
 AES output channels.
 Digital Output Gain ±18 dB
 Global Delay Offset Up to +2.5 s in 1ms steps, common
 to all processed audio.
 Variable Audio Delay Control Source
 Up to 1 s from RollTrack + GPI +
 video synchronizer
 Audio Level Slew Rate Instant, fast, medium, slow
 Validity Bit Clear or set
 Tone Frequency, Amplitude & Ident
 2-channel tone generator.
 Tone Frequency 100 Hz to 15 kHz in 100 Hz steps
 Tone Channel Ident 0.5 s interruption every 2 s

Functions Available via RollCall Only

Audio Controls

Line Up Tone Level-24 dBu to +10 dBu in 0.5 dB steps
 Headroom+4 to +24 dB in 0.5 dB steps
 (subject to a max input level of +24
 dBu)
 Set Audio Monitor Thresholds
 High and low levels, time delay
 External Input Audio Delay .Up to 1.5 s additional delay in 1ms
 steps
 Input Side Control ProcIndependent Gain, Mute, Polarity &
 Mono control over de-embedded
 and analog input channels
 Digital Input Gain±18 dB
 Analog Input Gain±34 dB (subject to Line up and
 Headroom levels)
 Channel RoutingOutput channels routed from
 analog pair 1, analog pair 2, test
 tone, SDI and audio mixers

Video Controls

Input Select Composite A / B, YC, SDI
 Composite Input Standard .Auto [PAL, NTSC, PALM, PALN,
 SECAM] / Manual [PAL, NTSC,
 NTSC-J, PALM, PALN, SECAM,
 N4.43]
 SDI Input Standard Auto / Manual [525 / 625]
 Freeze Off / On
 Luma Gain ±6 dB
 Chroma Gain ±6 dB
 Black Level ±120 mV
 NTSC Hue ±45°
 Y/C Timing +592 ns in 148 ns steps
 Picture Position ±592 ns in 148 ns steps
 Blanking Left, right, top, bottom, color
 Noise Reducer Mode & Noise Measurement
 Auto / Manual noise measurement
 Normal / Minimum delay
 Noise Threshold Auto Bias [±7] / Manual [0 to 15]

Noise Reducer StrengthLuma [0 to 31], Chroma [0 to 31]
 H Enhance.....Off / [On – low, medium, high]
 H Enhance Frequency2.25 MHz or 3.375 MHz
 V Enhance.....Off / [On – low, medium, high]
 Decoder ModeSimple, Studio, VHS/Unstable
 SECAM NotchAdaptive/Controllable
 SECAM Luma Bandwidth ...Wide/Medium/Narrow
 SECAM Bottles.....Auto/On/Off
 Color Killer.....Chroma ON / Chroma OFF / Auto
 [QAM standards: Chroma off =
 chroma mute + Y notch
 SECAM: Chroma off = chroma
 mute only]
 Genlock H Phase.....± ½ line in 1 pixel steps
 Genlock V Phase.....±262/312 lines in 1 line steps
 Genlock ModeFree-run / Lock to reference / Lock
 to input (minimum delay)
 H Delay1 line in 1 pixel steps
 V Delay.....524/624 lines in 1 line steps
 Additional Video Delay 0, 1 or 2 frames of delay
 NTSC lines 11 to 20 and 274 to 282
 Blank, pass as VBI, decode VBI
 NTSC line 22, 283 and 285 Blank, pass as data, pass as
 picture
 NTSC line 21 and 284 Blank, pass as data, pass as
 picture, pass as closed captions
 PAL lines 7 to22 & 320 to 335
 Blank, pass as VBI, decode VBI
 PAL line 23 Blank, pass as WSS, pass as
 picture
 Horizontal Ancillary Blank ...Off / On

Other Controls

Pattern Enable.....Off / On
 Pattern Select.....Black / EBU Color Bars / 100%
 Color Bars / Ramp / Multi-Burst /
 Pulse & Bar / Animated Bar
 Caption EnableOff / On
 Caption GeneratorProgrammable up to 19 characters

GPI Action Memories 1 to 8 / Pattern / Freeze /
 Audio delay
 GPI Polarity High / Low
 GPO Action..... Input loss / Standard / Video delay
 GPO Polarity..... High / Low
 User Memories Name, clear, save and recall 8 user
 memories
 Default Video Output Pass Video / Freeze / Pattern /
 Pattern and Caption
 Default Audio Output Silence
 Preset Unit..... Returns all settings to default

Reporting * also Logged

Input Status *Input present, *Input line standard,
 *Composite color standard
 Input Error..... One or more inputs have
 unselected line standard
 Reference Status *Ref present, *Ref standard
 Reference Error Standard different to selected input
 EDH..... *Presence / *Error-Minute / *Error-
 Hour
 Input Ancillary Error Bad checksums, invalid formatting
 of HANC
 Embedded Audio Status *Input audio pair present, *Input
 audio pair non-PCM
 Audio Bus Monitor *Silence, *High Level, *Low Level,
 *Overflow for processed audio
 channels
 Analog Audio Input_Monitor *Silence, *High Level, *Low Level,
 *Overflow for analog audio input
 channels

RollTrack Input

Delay Audio delay – Fixed, RollTrack +
 Fixed, Internal Sync ± Fixed

RollTrack Output

Delay Current video / audio delay
 Input State Present / line standard
 Reference State..... Present / error
 Embedded Audio Status Input audio pair present

Technical Profile (continued)

Specifications

Video Specifications

Video Internal Processing...4:2:2 with 10 bit data paths
 Frequency Response (Studio Mode)
 Y.....5.75 MHz \pm 0.1 dB
 PbPr1.5 MHz -3dB
 Frequency Response (VHS Mode)
 Y.....5 MHz +0.2 dB, -0.5 dB
 PbPr1.5MHz -3dB typ
 Composite Input Return Loss
 Better than 35 dB to 5 MHz
 Composite level/impedance 1 V pk-pk typ. Into 75 Ohm
 Serial Input Return LossBetter than 15 dB from 100 kHz to
 270 MHz
 Maximum Serial Input Cable Length
 > 200 m (PSF1/2 or equiv. cable)
 Serial Output Level800 mV \pm 5%
 Output Overshoot< 70 mV
 Output Return LossBetter than 15 dB to 270 MHz
 Output Jitter< 0.2 UI (with 10 Hz High pass filter
 selected on 601 monitor)
 Reference Return Loss.....Better than 35 dB to 5.8 MHz
 Reference Input Level.....1 Vp-p \pm 3 dB
 Sync Level.....0.3 V \pm 6 dB into 10k Ohms

Delay through the unit

Decoder Delay.....<2 lines
 Synchronizer Delay.....16 μ s (Lock to Input)
 1 frame + 16 μ s (Lock to
 Reference)
 Additional Processing Delay <100 μ s
 Noise Reducer Delay.....<1 frame (Normal)
 <3 lines (Minimum Delay)

Total Minimum Delay <7 lines
 Total Maximum Delay >4 frames (including optional video
 delay)

Audio Specifications

Input Impedance..... >30 K Ohms, balanced, line to line
 >15 K Ohms line to earth (600 Ohm
 link selectable)
 Max Input Level +24 dBu, balanced
 Frequency Response..... +0.1/-0.25 dB, 20 Hz – 20 kHz wrt
 1 kHz
 THD+N <-94 dB typical at -1 dBFS, 1 kHz,
 22 Hz - 20 kHz, 'A' weighted, unity
 gain
 Sampling 24 bits @ 48 kHz,
 Dynamic Range >100 dB wrt -1 dBFS, 20 Hz to 20
 kHz, 'A' weighted
 CMMR >50 dB typical at 60 Hz
 Cross Talk < -100 dB, 20-20 kHz, +24 dBu,
 channel to channel
 Channel Gain Mismatch..... < \pm 0.2 dB
 Max Output Level..... 0 dBFS
 Output Sampling..... 48 kHz

Power Consumption

Module Power Consumption 13 W

INPUT CONNECTIONS

SERIAL IN

The serial digital input is made to the unit via a BNC connector which terminates in 75 Ohms.

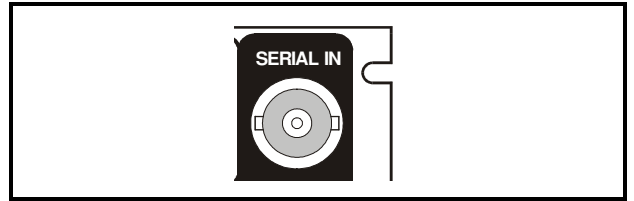

COMP IN A and B (-2 version)

These are the two composite video inputs to the module via BNC connectors. Nominal input level is 1 V p-p terminated in 75 Ohms.

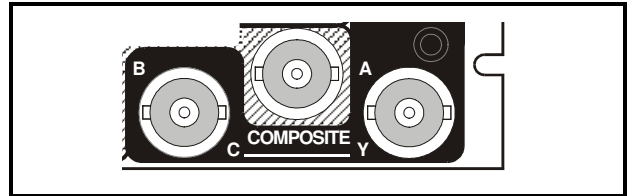

COMPOSITE A and B (-2A version)

These are the two composite video inputs to the module via BNC connectors. Nominal input level is 1 V p-p terminated in 75 Ohms.

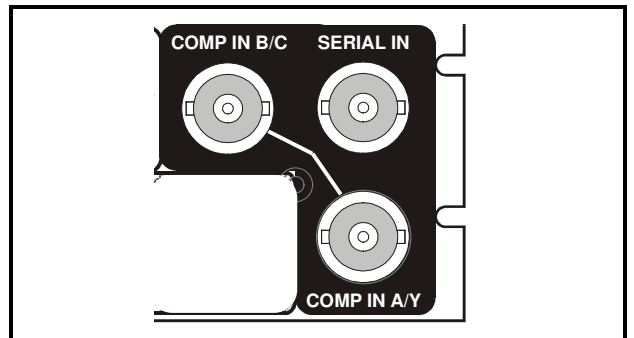

Separated Y C (-2 and -2A versions)

A Y-C (S-VHS, Hi-8 etc.) input signal may be connected to the unit via two BNC connectors marked Y and C.

Y input level is a nominal 1V p-p into 75 Ohms. C input is nominal color burst level into 75 Ohms.

ANALOG AUDIO IN

Four balanced analog inputs are made to the unit via a 25 way D Type connector.

For connection details please see pages 11 & 12.

The input Impedance is >30 k Ohms (line to line). This may be changed to 600 Ohms using the on-board link as shown below.

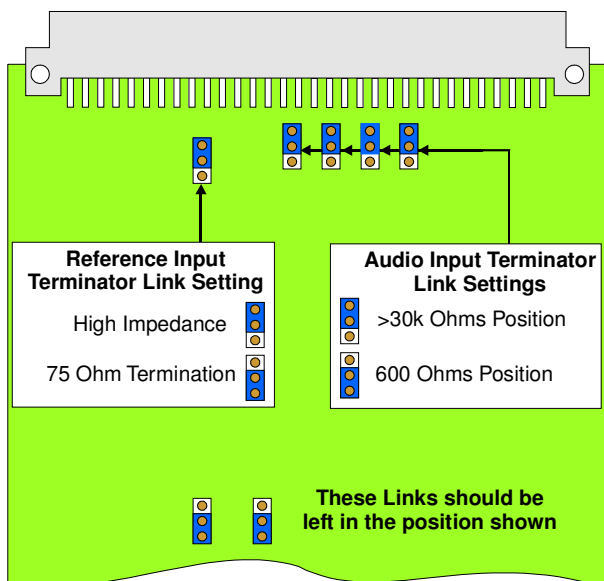
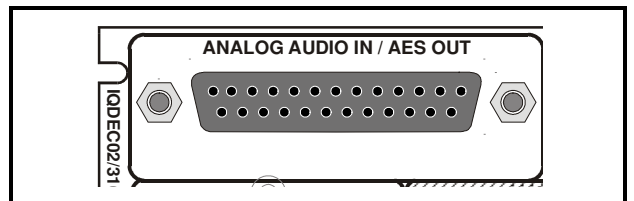
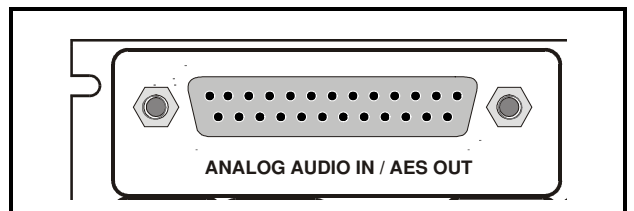

REFERENCE

The analog reference input to the unit is made via the passive loop-through BNC connectors for 75 Ohms.

The signal may be black burst or composite video at standard levels.

Note that if the loop-through facility is not used the unused BNC socket must be fitted with a 75 Ohm terminator or the Reference Input Termination link on the card set to the 75 ohm position as shown below.

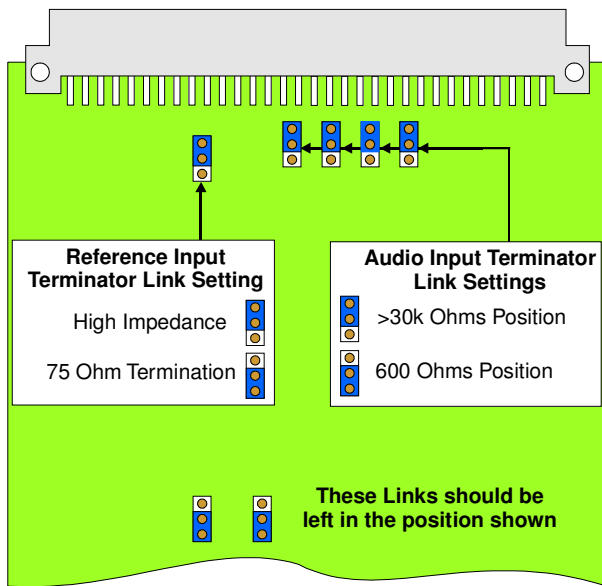
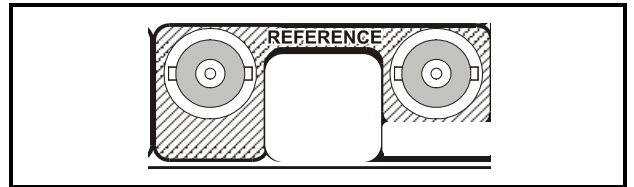
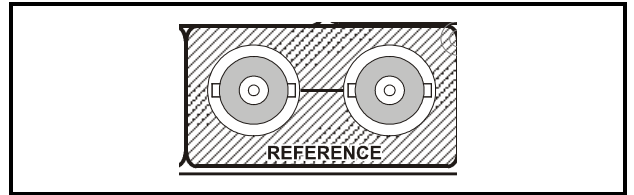

GPI (-2A only)

This connector is used for accepting GPI information (from mechanical switch contacts, relay contacts etc.) The resulting action that the unit takes may be programmed via RollCall.

It may also be configured as an output.

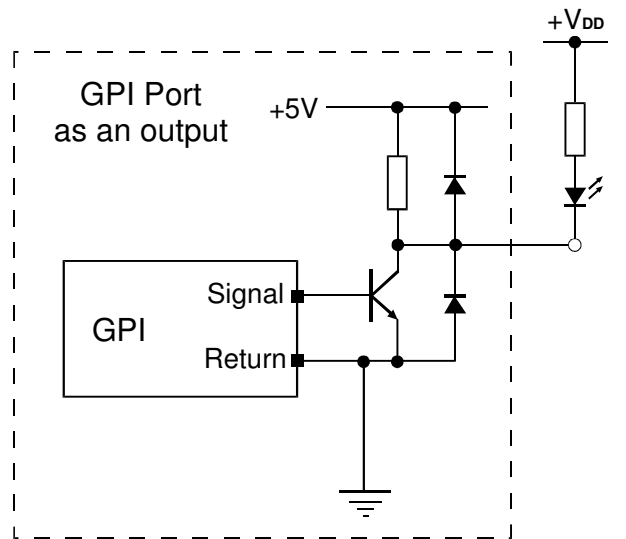
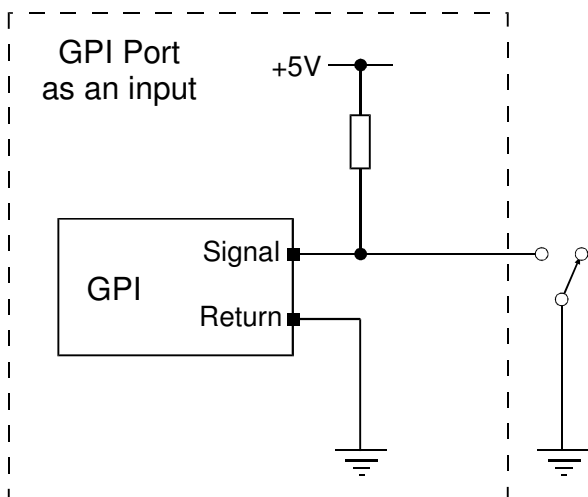
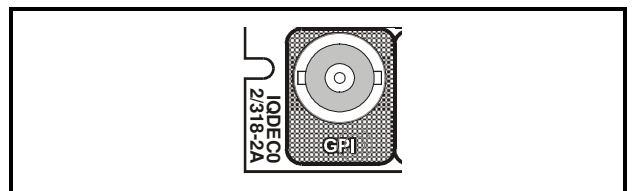

OUTPUTS

Serial Digital Video Outputs

These are the two Serial Digital outputs of the unit via BNC connectors for 75 Ohms.

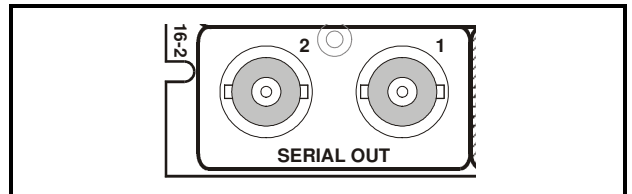
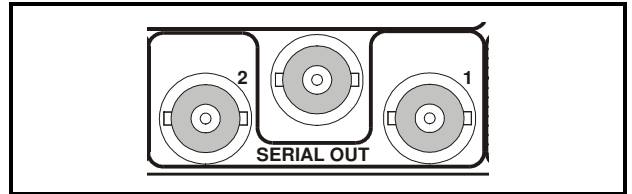

AES OUT (-2 version)

Balanced and unbalanced AES outputs are available via the 25 way D type connector.

For connection details please see pages 12 & 13.

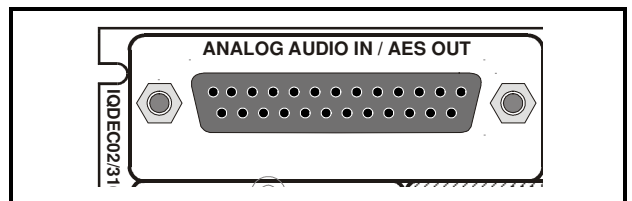

AES OUT (-2A version)

Balanced and unbalanced AES outputs are available via the 25 way D type connector; two unbalanced AES outputs are also available via BNC connectors for 75 Ohms.

For connection details please see pages 12 & 13.

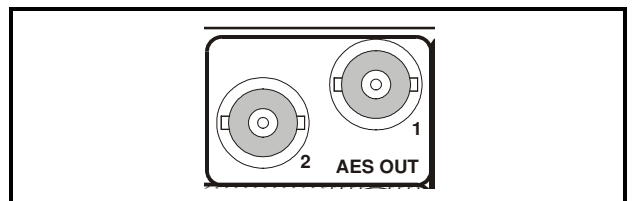
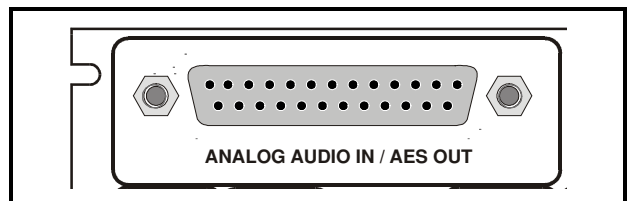

25 Way D Type Connection Details

By Pin Number

Pin No	Description	Connection
1	Chassis Ground	Ground
2	Channel 1 +	Analog Audio In 1L +
3	Channel 2 +	Analog Audio In 1R +
4	Ground (2)	Ground
5	Channel 3 +	Analog Audio In 2L +
6	Channel 4 +	Analog Audio In 2R +
7	Ground (4)	Ground
8	Channel 5 +	AES 1 Out (Unbalanced) +
9	Channel 6 +	AES 1 Out (Balanced) +
10	Ground (6)	Ground
11	Channel 7 +	AES 2 Out (Balanced) +
12	Channel 8 +	AES 2 Out (Unbalanced) +
13	Ground (8)	Ground
14	Ground (1)	Ground
15	Channel 1 –	Analog Audio In 1L –
16	Channel 2 –	Analog Audio In 1R –
17	Ground (3)	Ground
18	Channel 3 –	Analog Audio In 2L –
19	Channel 4 –	Analog Audio In 2R –
20	Ground (5)	Ground
21	Channel 5 –	AES1 Out (Unbalanced) –
22	Channel 6 –	AES 1 Out (Balanced) –
23	Ground (7)	Ground
24	Channel 7 –	AES2 Out (Balanced) –
25	Channel 8 –	AES2 Out (Unbalanced) –

By Function

Pin No	Description	Connection
1	Chassis Ground	Ground
2	Channel 1 +	Analog Audio In 1L +
15	Channel 1 –	Analog Audio In 1L –
14	Ground (1)	Ground
3	Channel 2 +	Analog Audio In 1R +
16	Channel 2 –	Analog Audio In 1R –
4	Ground (2)	Ground
5	Channel 3 +	Analog Audio In 2L +
18	Channel 3 –	Analog Audio In 2L –
17	Ground (3)	Ground
6	Channel 4 +	Analog Audio In 2R +
19	Channel 4 –	Analog Audio In 2R –
7	Ground (4)	Ground
8	Channel 5 +	AES 1 Out (Unbalanced) +
21	Channel 5 –	AES1 Out (Unbalanced) –
20	Ground (5)	Ground
9	Channel 6 +	AES 1 Out (Balanced) +
22	Channel 6 –	AES 1 Out (Balanced) –
10	Ground (6)	Ground
11	Channel 7 +	AES 2 Out (Balanced) +
24	Channel 7 –	AES2 Out (Balanced) –
23	Ground (7)	Ground
12	Channel 8 +	AES 2 Out (Unbalanced) +
25	Channel 8 –	AES2 Out (Unbalanced) –
13	Ground (8)	Ground

Example of Connection to XLR Connectors

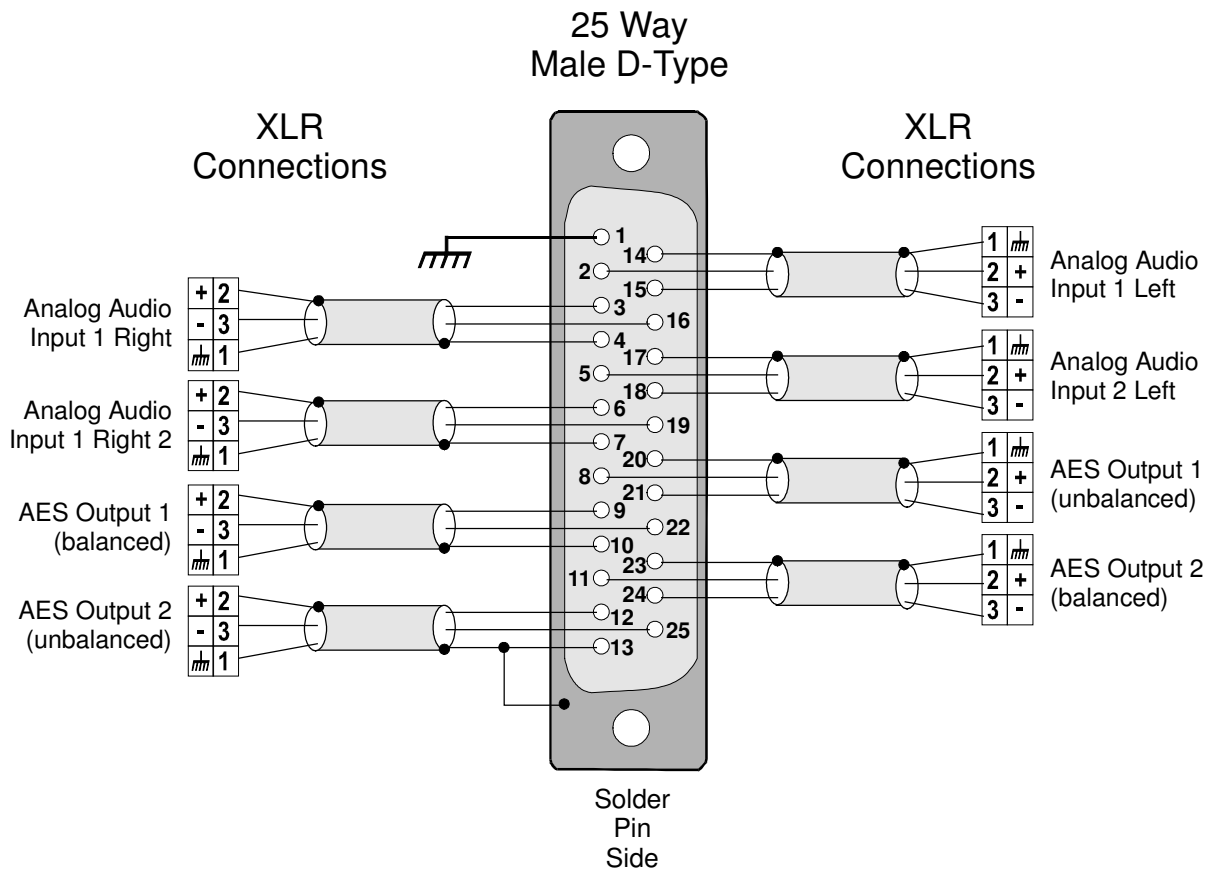
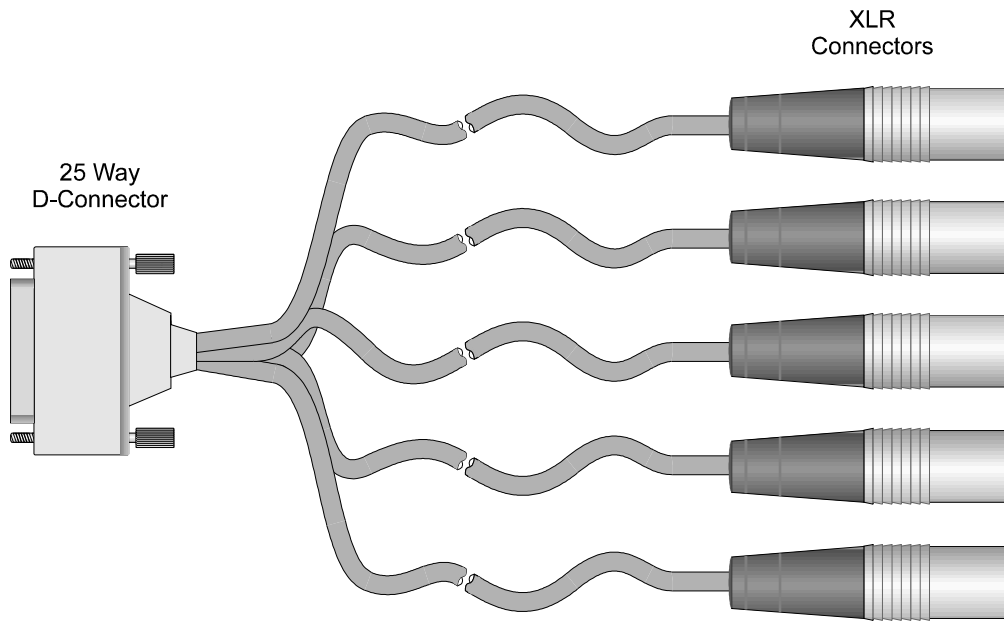

CARD EDGE INDICATORS

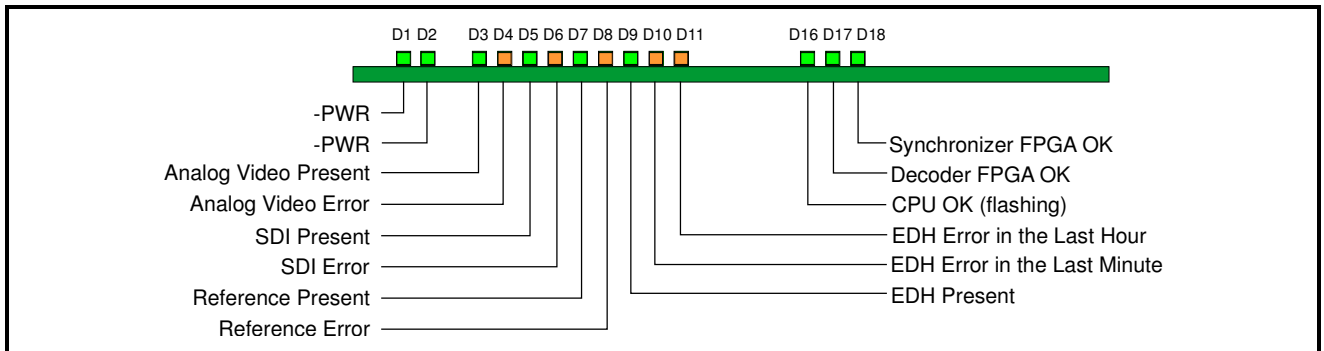

LED INDICATORS

D1: -PWR (Green)

When illuminated this indicates that the negative power supply is operating.

D2: +PWR (Green)

When illuminated this indicates that the positive power supply is operating.

D3: Analog Video Present (Green)

When illuminated this indicates that there is a valid signal at the composite input.

D4: Analog Video Error (Amber)

When illuminated this indicates that there is an invalid signal at the composite input.

D5: SDI Present (Green)

When illuminated this indicates that there is a valid signal at the SDI input.

D6: SDI Error (Amber)

When illuminated this indicates that the SDI input is not at the current operating standard.

D7: Reference Present (Green)

When illuminated this will indicate that a valid reference signal is present.

D8: Reference Error (Amber)

When illuminated this will indicate that an invalid reference signal is present.

D9: EDH Present (Green)

When illuminated this indicates that there is EDH present on the SDI signal.

D10: EDH Error in the Last Minute (Amber)

When illuminated this indicates that there has been an EDH Error in the Last minute.

D11: EDH Error in the Last Hour (Amber)

When illuminated this indicates that there has been an EDH Error in the Last Hour.

D16: CPU OK (flashing) (Green)

This LED will flash to indicate that the CPU is running.

D17: Decoder FPGA OK (Green)

This will illuminate when the Decoder FPGA has been loaded.

D18: Synchronizer FPGA OK (Green)

This will illuminate when the Decoder FPGA has been loaded.

RollCall PC Control Panel Screens

Video

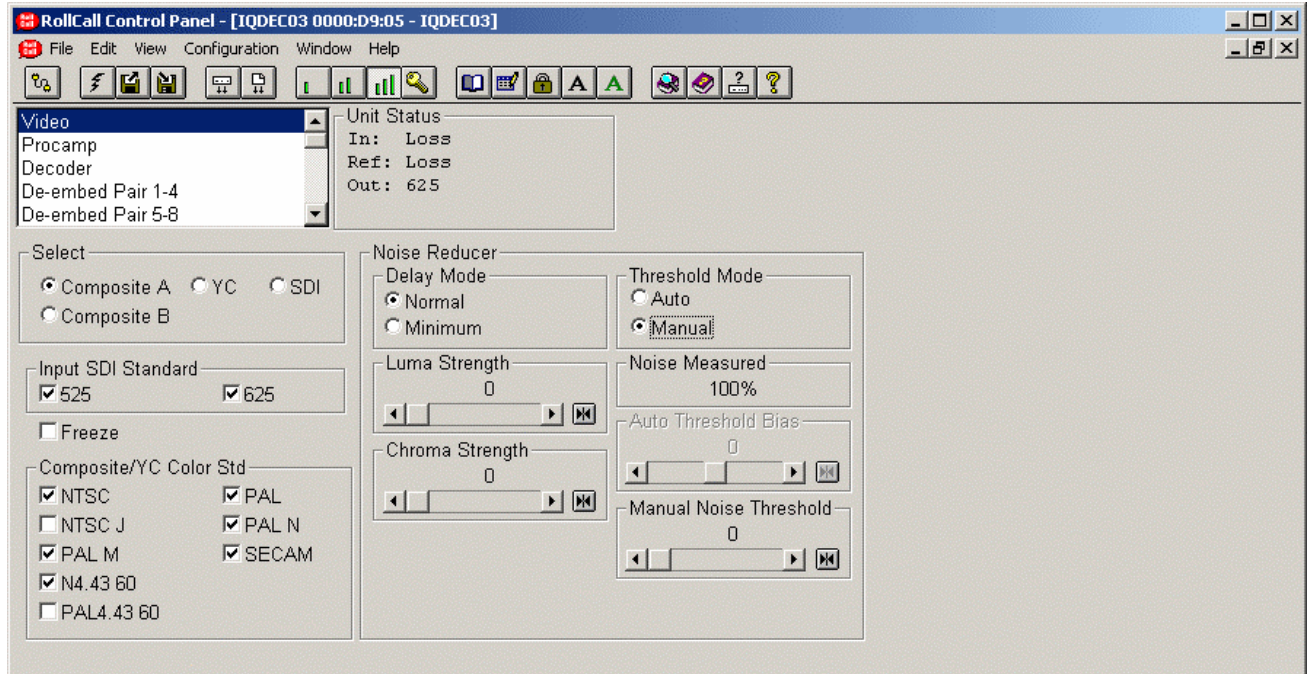

Select

This allows either the **Composite A**, **Composite B**, **YC** or **SDI** input to be selected for processing.

Note that if the unit is de-embedding audio from an SDI signal and then a composite or YC signal is selected the unit will continue to de-embed and output the audio from the SDI signal.

Input SDI Standard

This allows **input standard** for the SDI input to be selected.

If only 625 is selected the unit will be forced to only accept 625 line inputs.

If only 525 is selected the unit will be forced to only accept 525 line inputs.

If 625 and 525 are selected the unit will accept both 625 and 525 line inputs.

Composite/YC Color Standard

This allows the automatic detection of the color standard(s) for the composite/YC input.

The module will automatically detect any of the color standards that have been checked. In the screen example above the unit will automatically detect PAL, NTSC, PAL-M, PAL-N, N4.43 60 and SECAM but will not detect NTSC-J or PAL4.43 60.

Note that when selecting and deselecting SECAM the output picture and audio may suffer some disruption.

Freeze

When checked the output picture will become a frozen frame.

Video (continued)

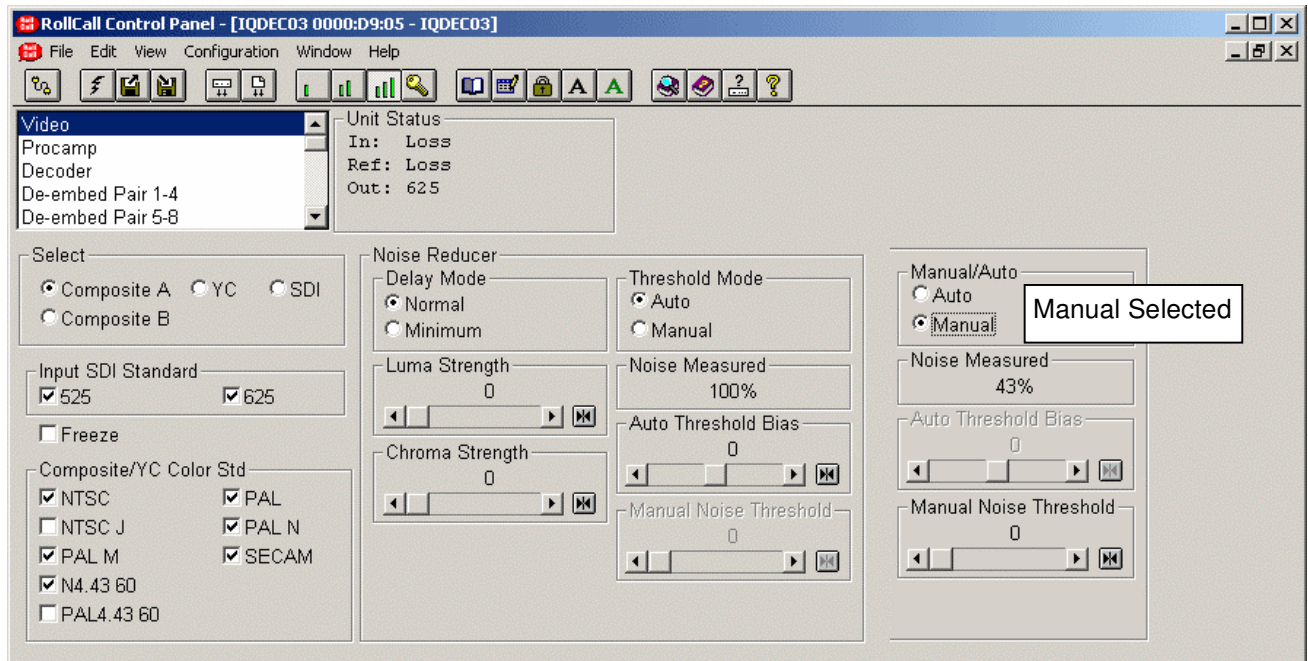

Noise Reducer

This allows settings and adjustments to be made to the noise reducer.

Delay Mode

This allows the delay of the noise reducer to be selected.

Normal

In this mode the delay will be < 1 Frame

Minimum

This mode produces the minimum input/output delay and may be used where audio delay problems may exist and cannot be compensated for. In this mode the delay will be < 3 Lines

Manual/Auto

Manual

In this mode the noise floor may be adjusted manually using the **Manual Noise Threshold** control.

Noise Measured

This provides an indication of how much noise there is in the signal. A clean signal will give low figures and a noisy signal high figures.

Auto

In this mode the noise floor is automatically measured and the threshold is adjusted dynamically set to an appropriate value for the current input noise level. The noise detection algorithm may be given a subjective bias using the **Auto Threshold Bias** control to give more or less noise reduction. Modification of the bias should not be necessary under normal circumstances.

Luma Strength

This control changes the amount of noise reduction for the luminance by limiting the maximum level of noise reduction, where 31 is maximum and 0 is minimum. Preset is to 0. The actual level of noise reduction is dynamically adjusted on a pixel-by-pixel basis with regard to the noise reduction setting for the same pixel in the previous frame.

Chroma Strength

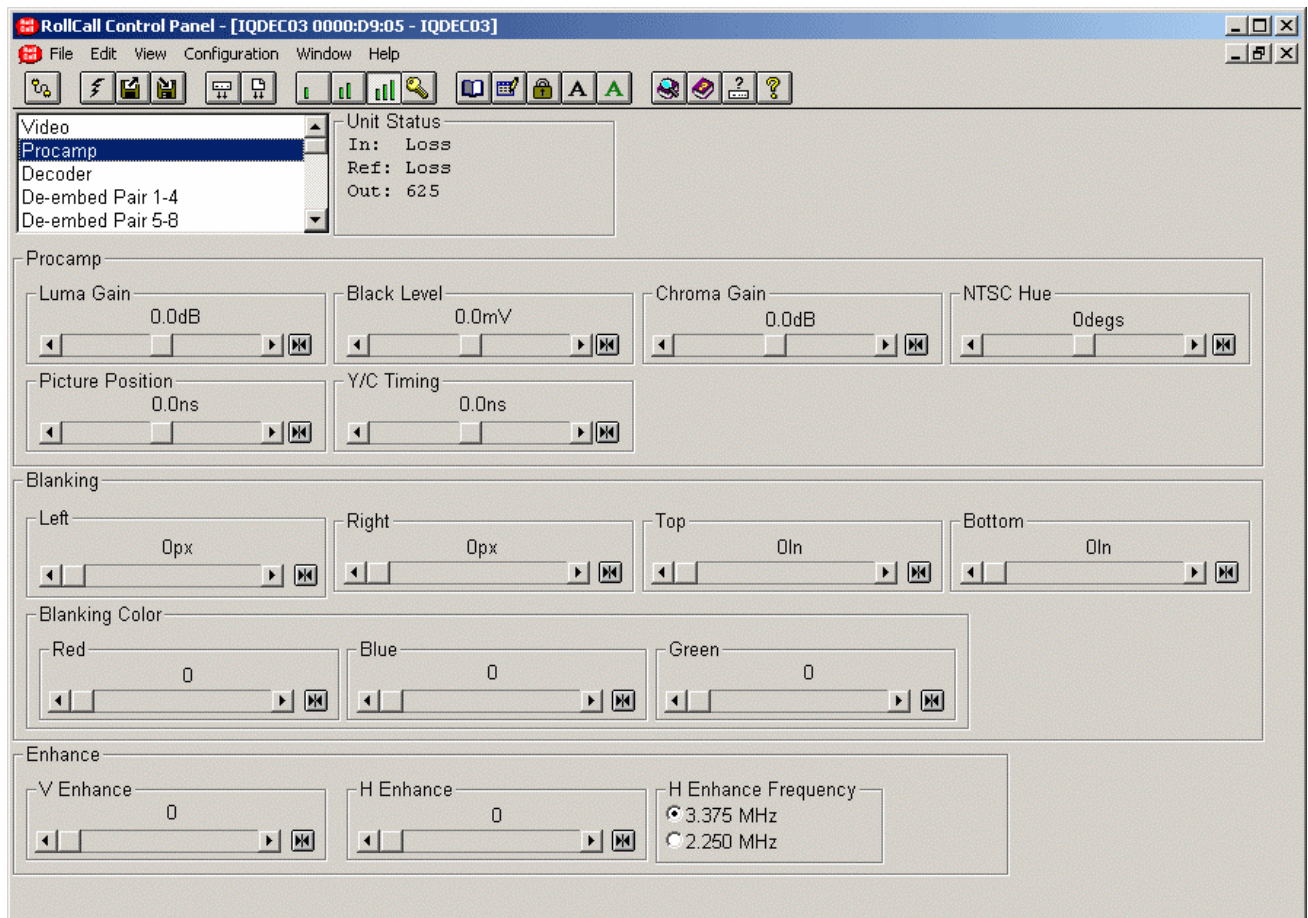

This control changes the amount of noise reduction for the chrominance by limiting the maximum level of noise reduction, where 31 is maximum and 0 is minimum. Preset is to 0. The actual level of noise reduction is dynamically adjusted on a pixel-by-pixel basis with regard to the noise reduction setting for the same pixel in the previous frame.

ProcAmp



These items allow various signal parameters to be adjusted.

Note that for this and other screens the following applies to the scroll bars:

The  and  symbols at the ends of the scroll bar allow the value to be adjusted in discrete steps.

The numerical value will be shown above the scroll bars and selecting Preset  will return the setting to the calibrated value for that item.

Luma Gain

This allows the Y (luminance) gain to be adjusted by ± 6 dB in steps of 0.1 dB. Preset value is 0.0 dB. *Note that the maximum input level is +3 dB.*

Black Level

This allows the black level to be adjusted by ± 120 mV in 0.5mV steps. Preset value is 0.

Chroma Gain

This allows the U/V (color difference) gain to be adjusted by ± 6 dB in steps of 0.1 dB. Preset value is 0.0 dB.

Note that the maximum input level is +3 dB.

NTSC Hue

This item allows the Hue of an NTSC signal to be adjusted.

The range of adjustment is ± 45 degrees. Preset is to 0 degrees.

Picture Position

This item allows the timing of the picture position relative to the normal value, to be adjusted. The timing may be adjusted by ± 592 ns in 148ns steps. Preset value is 0.

Y/C Timing

This item allows the timing of the chrominance signal relative to the luminance signal to be adjusted, (i.e. Y to Cb/Cr timing) in nanoseconds. The timing may be adjusted by ± 592 ns in 148ns steps. Preset value is 0.

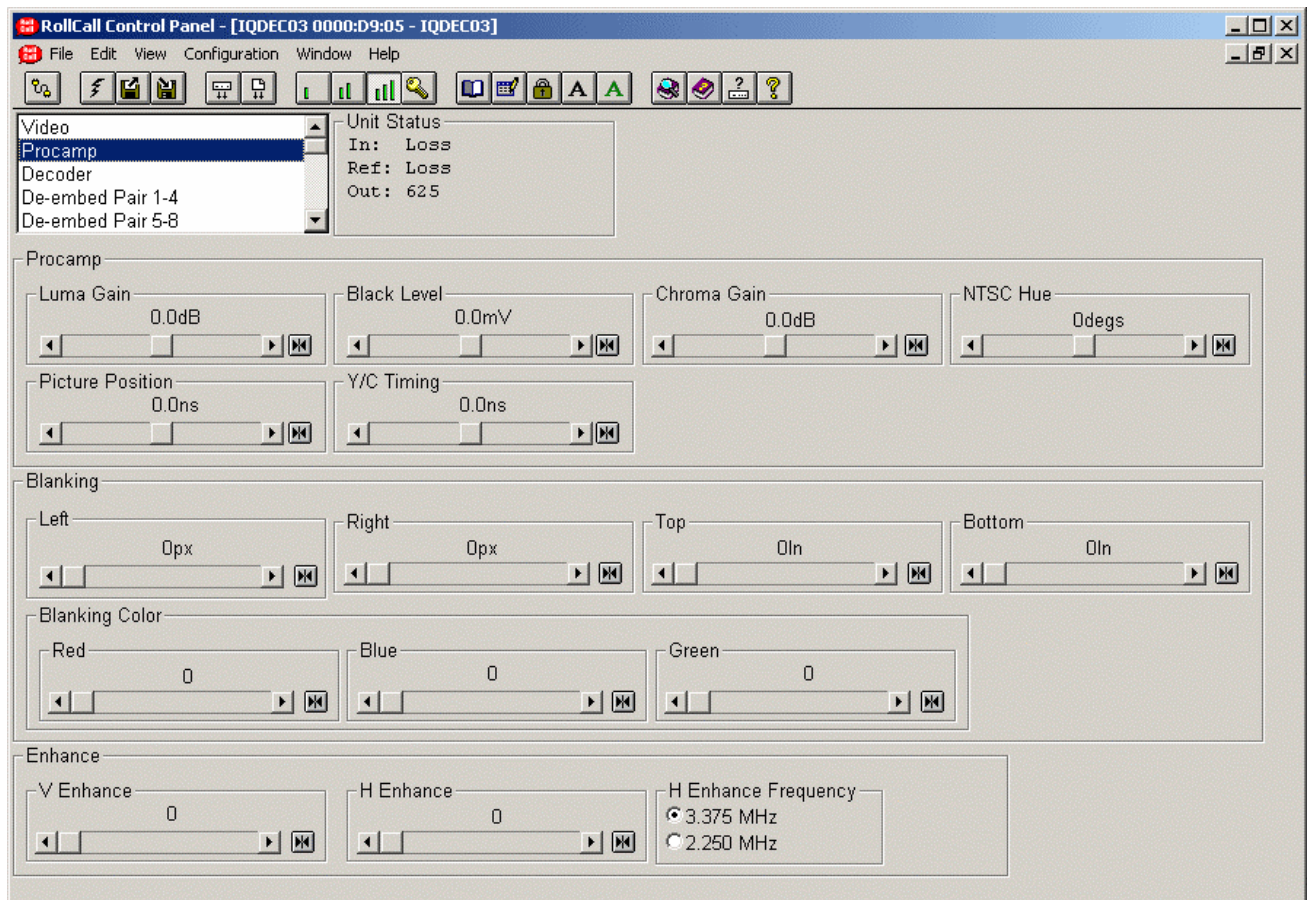
ProcAmp (continued)**Blanking**

This allows the active picture to be blanked out or cropped on each of the four sides.

Left/Right

The range of adjustment is from 0 to 200 pixels in steps of 2 pixels. Preset is to 0 pixels.

Top/Bottom

The range of adjustment is from 0 to 200 lines. Preset is to 0 lines.

The color of the blanked area may be set using the **Red**, **Blue** and **Green** controls. The range of adjustment is from 0 to 255 units. Preset is to 0, 0 units (Black).

Enhance

This allows Vertical and Horizontal enhancement to be applied to the picture.

V Enhance

This allows vertical enhancement to be applied to the processed signal.

The level of enhancement may set to 0 (Off), 1 (Low), 2 (Medium) and 3 (High). Preset is to 0.

H Enhance

This allows Horizontal enhancement to be applied to the processed signal. The non-linear process prevents enhancement of low amplitude signals typical of noise.

The level of enhancement may set to 0 (Off), 1 (Low), 2 (Medium) and 3 (High). Preset is to 0.

H Enhance Frequency

The frequency at which the horizontal enhancement is applied may be set to either 3.375 MHz or 2.250 MHz. Preset is to 3.375 MHz.

Decoder

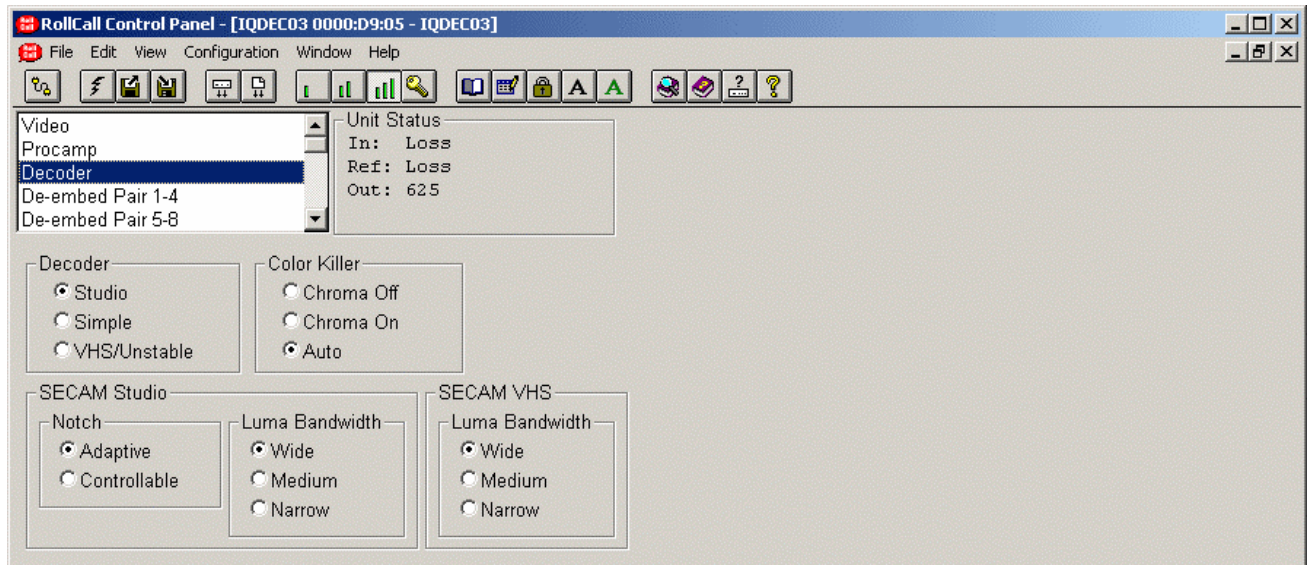

This screen allows the decoder functions to be set up.

Decoder

This allows the type of decoding to be selected.

Studio

The composite input is sampled with 12-bit resolution and decoded using adaptive line filters to ensure optimum decoding performance.

Simple

This simple decode mode incorporates a wide bandwidth subcarrier notch filter. This mode is for reference only and should not be used for normal composite material.

VHS/Unstable

In this mode the decoder will cope with sources with unstable time-bases but the decoding is of a lower quality and the frequency response is reduced.

Color Killer

This function controls the color content of the picture.

Chroma Off

When selected the color content of the picture will be removed. The luma signal is produced using a narrow bandwidth notch filter.

Chroma On

When selected the color content of the picture will be maintained regardless of the level of the color burst.

Auto

When this item is enabled the picture will become monochrome if the input color burst disappears or the level drops below a critical amplitude. The picture will return to color when the burst level reappears.

Decoder (continued)

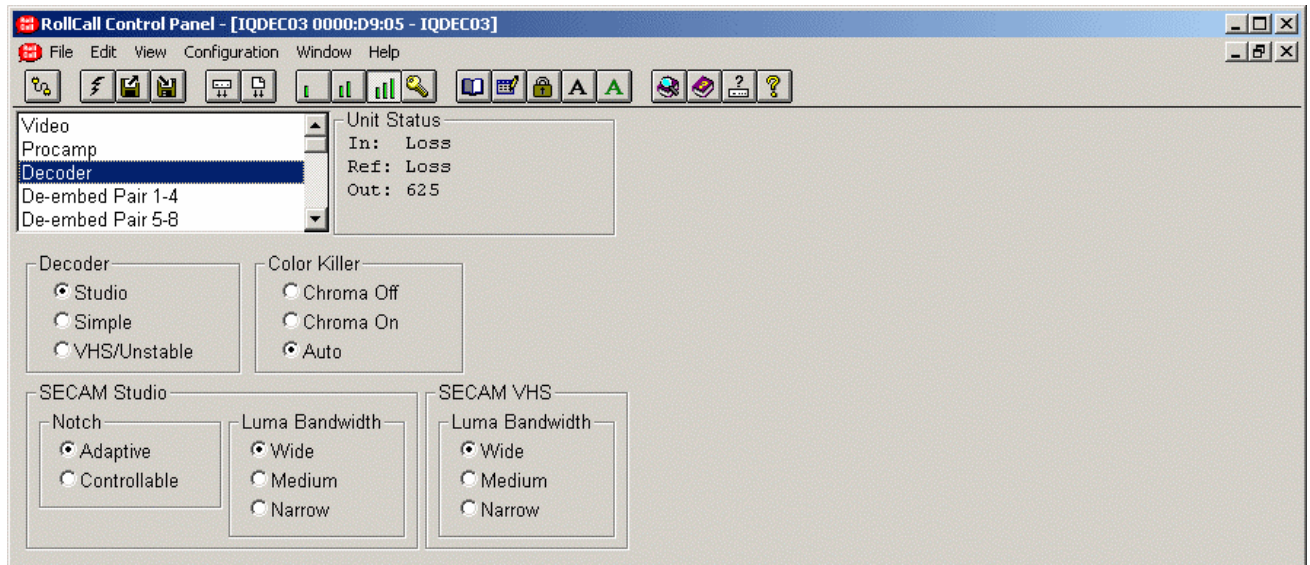

SECAM Studio

This function allows adjustments to decoding parameters for a SECAM signal of studio (stable) quality.

Notch

Either the Adaptive or the Controllable luminance notch filter may be enabled with this item.

Luma Bandwidth

This function allows the bandwidth of the decoded luminance to be adjusted.

- Wide** The signal will be processed at full bandwidth (3.4 MHz).
- Medium** The signal will be processed with a bandwidth of approximately 2.6 MHz.
- Narrow** The signal will be processed with a bandwidth of approximately 1.7 MHz.

SECAM VHS

This function allows adjustments to decoding parameters for a SECAM signal of VHS (unstable) quality.

Luma Bandwidth

This function allows the bandwidth of the decoded luminance to be adjusted.

- Wide** The signal will be processed at full bandwidth (3.4 MHz).
- Medium** The signal will be processed with a bandwidth of approximately 2.6 MHz.
- Narrow** The signal will be processed with a bandwidth of approximately 1.7 MHz.

De-embed Pair 1-4 and 5-8

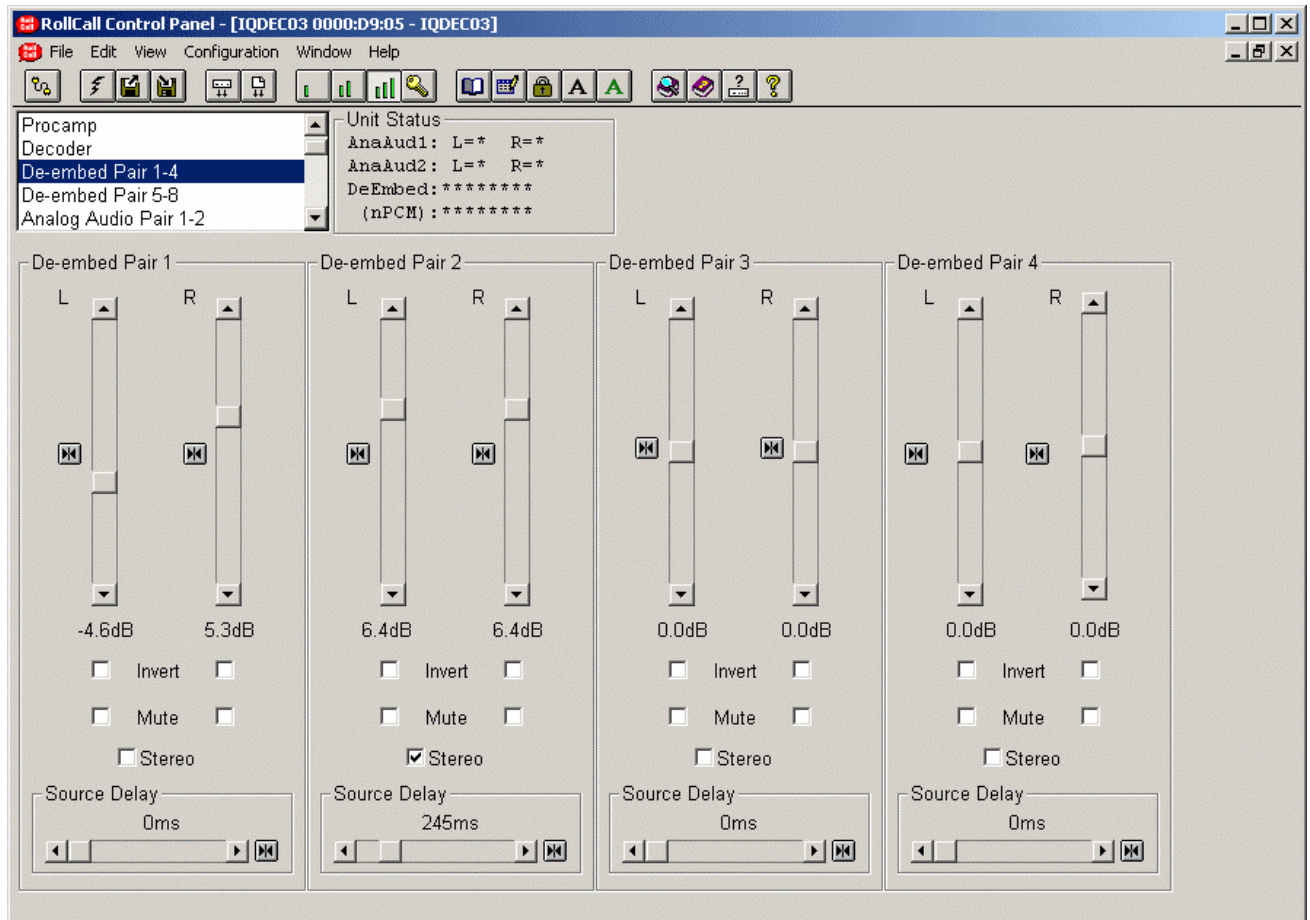

This allows control of Gain, Mute and Polarity over the de-embedded channel pairs.

L and R

These scrollbars allow the gain of the Left and Right channels to be adjusted over a range of ±18 dB in 0.1dB steps. Preset is to 0 dB.

Invert

When checked the signal polarity will be inverted.

Mute

When checked the signal will be muted.

Stereo

When checked the left and right channels will be configured as a stereo pair and any adjustments made to one channel will automatically be applied to both channels.

Source Delay

This control allows de-embedded signals to be delayed.

The range of control is from 0 to 1500 ms in 1 ms steps.

Analog Audio Pair 1-2

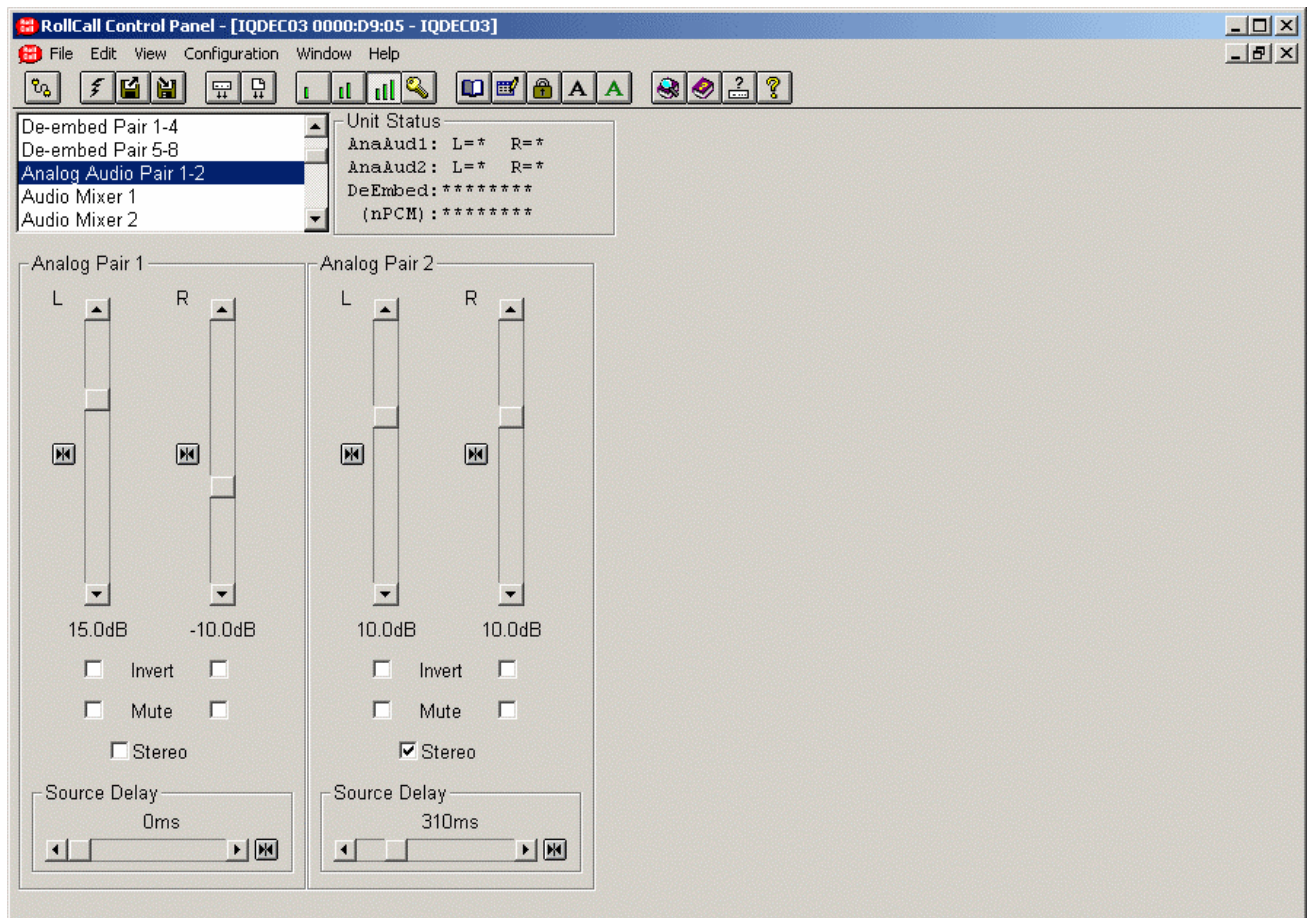

This allows control of Gain, Mute, and Polarity over the analog channel pairs and the introduction of delay.

L and R

These scrollbars allow the gain of the Left and Right channels to be adjusted over a range of ± 34 dB (depending on line-up and headroom settings) in 0.5dB steps. Preset is to 0 dB.

Invert

When checked the signal polarity will be inverted.

Mute

When checked the signal will be muted.

Stereo

When checked the left and right channels will be configured as a stereo pair and any adjustments made to one channel will automatically be applied to both channels.

Source Delay

This control allows an analog audio pair signal to be delayed.

The range of control is from 0 to 1500 ms in 1 ms steps.

Audio Mixer 1, 2, 3 and 4

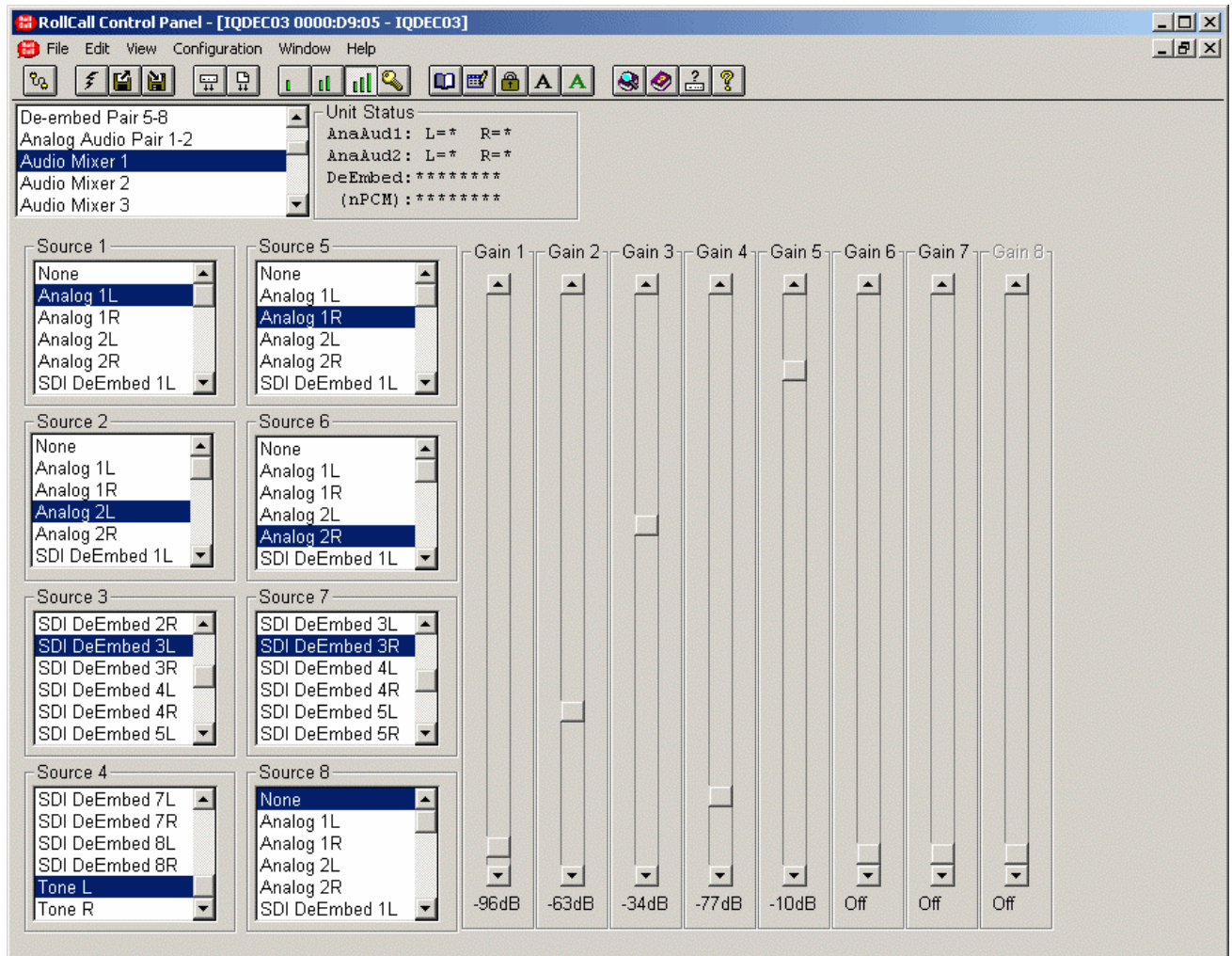

There are four separate audio mixers Mix 1, 2, 3 and 4.

Each mixer has eight inputs with individual gain controls that allow the mixing levels for each of the input signals, to be adjusted. The range of adjustment is from 0 to -96 dB and to Off. 0 to -60 dB is in steps of 1 dB, -60 dB to -96 dB is in steps of 3 dB.

The inputs can be selected from the **Source 1 to 8** lists.

Selectable Source Inputs

- None
- Analog 1L
- Analog 1R
- Analog 2L
- Analog 2R
- SDI DeEmbed 1L
- SDI DeEmbed 1R
- SDI DeEmbed 2L
- SDI DeEmbed 2R
- SDI DeEmbed 3L
- SDI DeEmbed 3R
- SDI DeEmbed 4L
- SDI DeEmbed 4R
- SDI DeEmbed 5L
- SDI DeEmbed 5R
- SDI DeEmbed 6L
- SDI DeEmbed 6R
- SDI DeEmbed 7L
- SDI DeEmbed 7R
- SDI DeEmbed 8L
- SDI DeEmbed 8R
- Tone L
- Tone R

The outputs of these mixers provide eight extra input selections for the Channel Router.

Audio Bus A and B

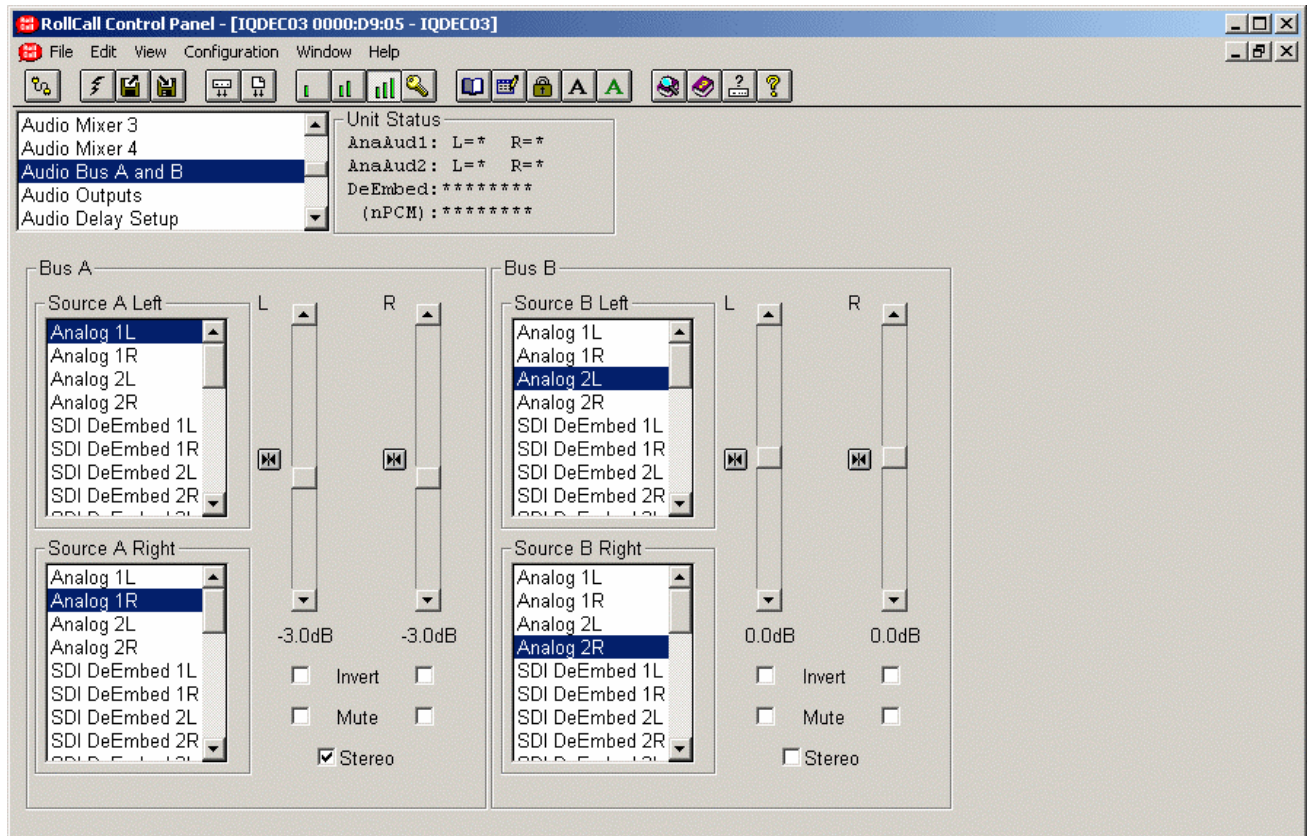

This function allows the inputs for the four audio buses of the router to be selected.

For each bus any source may be selected from the list for the left and right channels.

L and R

These scrollbars allow the gain to be adjusted over a range of ±18 dB in 0.1dB steps. Preset is to 0 dB.

Invert

When checked the signal polarity will be inverted.

Mute

When checked the signal will be muted.

Stereo

When checked the left and right channels will be configured as a stereo pair and any adjustments made to one channel will automatically be applied to both channels.

Bus A & B Source Inputs

- | | |
|----------------|----------------|
| Analog 1L | SDI DeEmbed 5R |
| Analog 1R | SDI DeEmbed 6L |
| Analog 2L | SDI DeEmbed 6R |
| Analog 2R | SDI DeEmbed 7L |
| SDI DeEmbed 1L | SDI DeEmbed 7R |
| SDI DeEmbed 1R | SDI DeEmbed 8L |
| SDI DeEmbed 2L | SDI DeEmbed 8R |
| SDI DeEmbed 2R | Tone L |
| SDI DeEmbed 3L | Tone R |
| SDI DeEmbed 3R | Mixer 1 |
| SDI DeEmbed 4L | Mixer 2 |
| SDI DeEmbed 4R | Mixer 3 |
| SDI DeEmbed 5L | Mixer 4 |

Audio Outputs

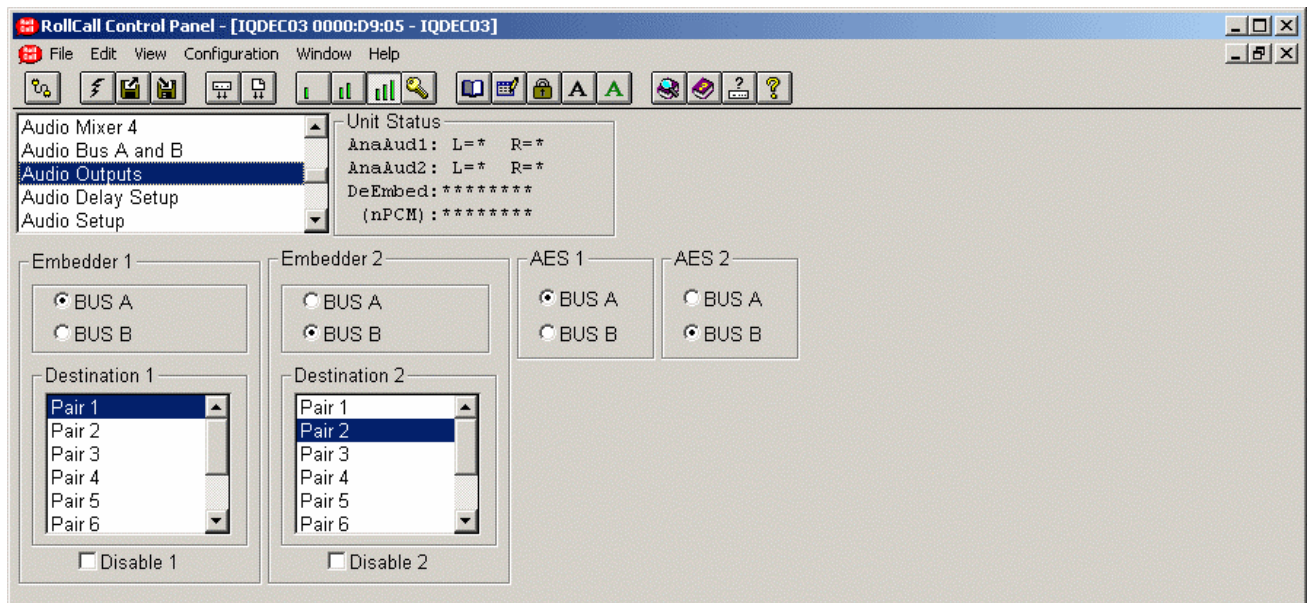

This function sets up the embedder sources and destinations. Higher number embedders have priority, so if the same destination pair is selected on two embedders, the highest embedder will be the one that is active.

Embedder 1 and 2

The source of the signal for the embedder may be from Bus A or Bus B.

Note that when the output embedders are enabled, the packet distribution is as follows:

625..... Lines 5, 6, 318, 319 have no introduced samples on them

525..... Lines 9, 10, 272, 273 have no introduced samples on them

Destination 1 and 2

The destination for the embedded signal may be selected from the list (Pair 1 to 8).

Disable 1 and 2

When checked the embedding for that destination will be turned off.

AES 1 and 2

This allows the signal source for the AES output to be selected from either from Bus A or Bus B.

Audio Delay Setup

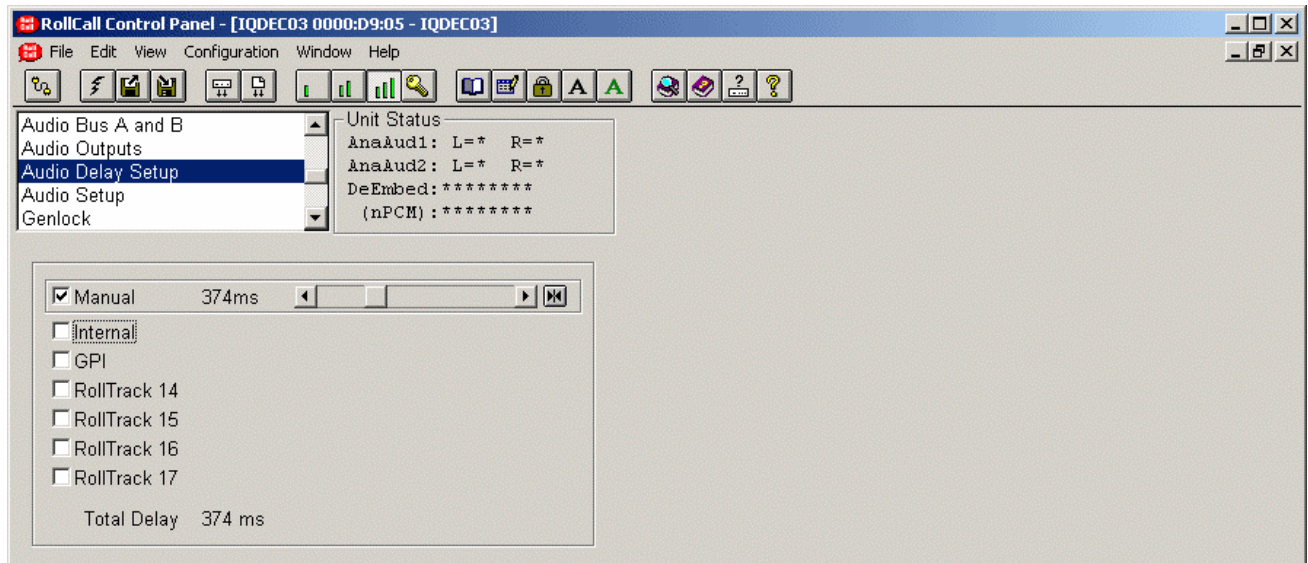

This screen allows the amount of delay to be set and type of audio delay mechanism to be selected.

Manual Delay

This will affect all processed audio signals equally.

The delay may be set to up to +1.5 s in 1ms steps.

Delay Select

This allows the type of audio delay mechanism to be selected. One or more of the types may be checked. The amount of delay applied will be the sum of the delay from the enabled delay mechanisms.

*Note that up to 1 s of delay may be applied from the sum of the **Internal** + **GPI** + **RollTrack** delay inputs.*

Internal

When checked, an audio delay equal to the video delay in the unit will be applied.

Manual

When checked an audio delay set by the **Manual Delay** control will be applied.

GPI

When checked an audio delay will be applied that is equal to the width of the pulse arriving at the GPI connector.

Note that the GPI must be configured correctly for this function to operate. Please see page 36 or details.

RollTrack 14, 15, 16 and 17

The selected source(s) of the RollTrack input signal(s) will apply an audio delay.

Total Delay

This will show the audio total delay (due to all delay mechanisms) through the unit in ms.

Audio Setup

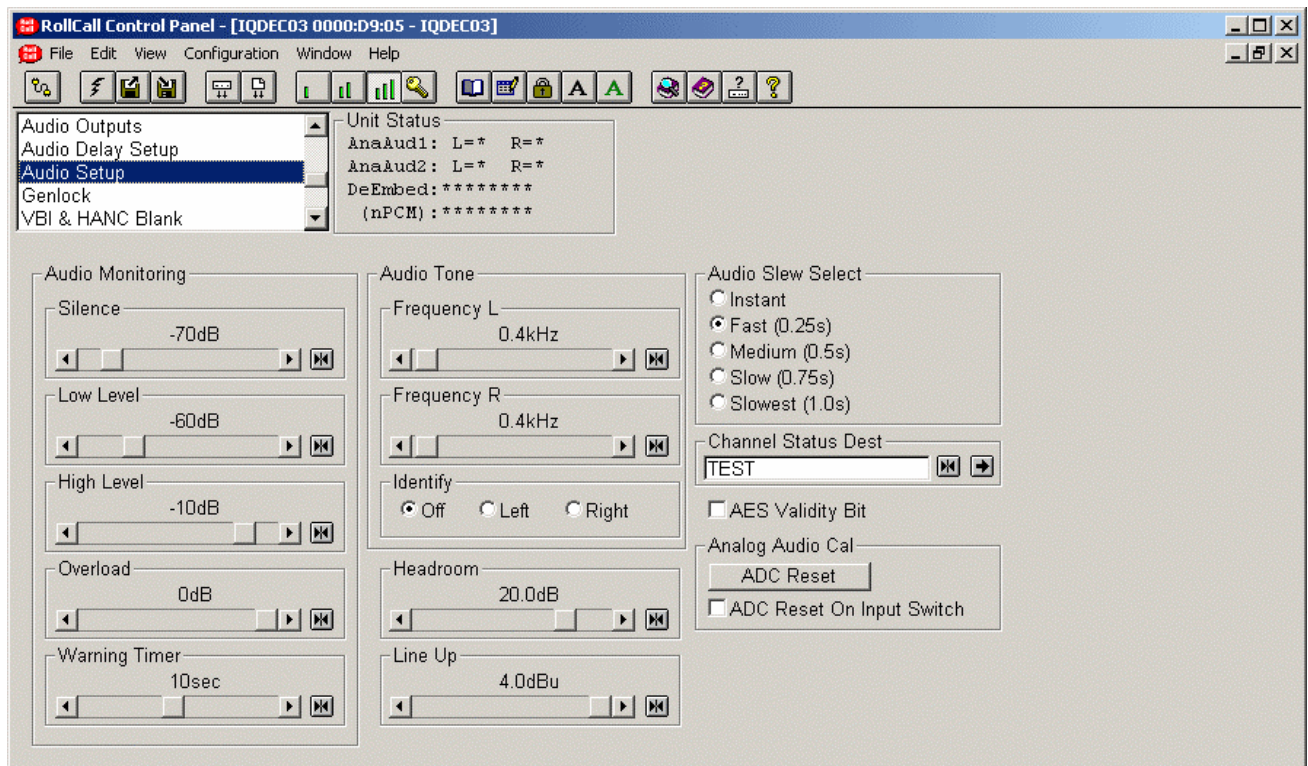

Audio Monitoring

The four audio buses are monitored and level detectors provide status information and logging data.

Silence

The level at which the signal is considered to have dropped to silence may be set with this control.

The range is from -80 dB to 0 dB in steps of 1 dB. Preset is to -70 dB.

Low Level

The level at which the signal is considered to have dropped to a Low Level may be set with this control.

The range is from -80 dB to 0 dB in steps of 1 dB. Preset is to -60 dB.

High Level

The level at which the signal is considered to have risen to a High Level may be set with this control.

The range is from -80 dB to 0 dB in steps of 1 dB. Preset is to -10 dB.

Overload

The level at which the signal is considered to have risen to an Overload condition may be set with this control.

The range is from -80 dB to 0 dB in steps of 1 dB. Preset is to 0 dB.

Warning Timer

All the above monitoring facilities will only operate after a time interval set by this control. A valid signal is reported immediately.

The range is from 1 to 20 seconds. Preset is to 10 seconds.

Audio Tone

The frequency of the Audio Test Tone may be set using this control. Left and right channels may be set independently.

Frequency L and R

The range is from 100 Hz to 15 kHz in steps of 100 Hz. Preset is to 100 Hz.

Audio Setup (continued)

Identify

When the left or right channel is selected it will be identified by the signal being muted for 0.5 second every 2.5 seconds.

Headroom

This allows the headroom to be set. The range is from 4 dB to 24dB in 1 dB steps. Preset is to 18 dB.

Note that in this product headroom is defined as:

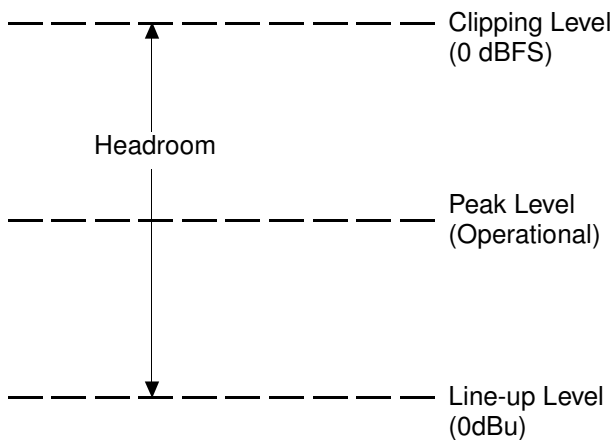

Headroom = Clipping Level – Line-up level

Definitions of Terms

Line-up Level

The line-up level is the voltage corresponding to the RMS value of a sine wave signal used to line up analog circuitry. In this product the line-up level is set in dBu which is decibels relative to 0.775V RMS. The line-up level should be set to match the analog line-up level of your system.

Headroom

The headroom is the level difference in dB between the line-up level and the clip level of the circuit. In other words it defines how much larger than line-up a signal can be before it clips. The headroom should be set to match the maximum headroom required by your system.

The chart below shows what line-up levels are available at each headroom setting and then what gain is available once the other two settings have been made.

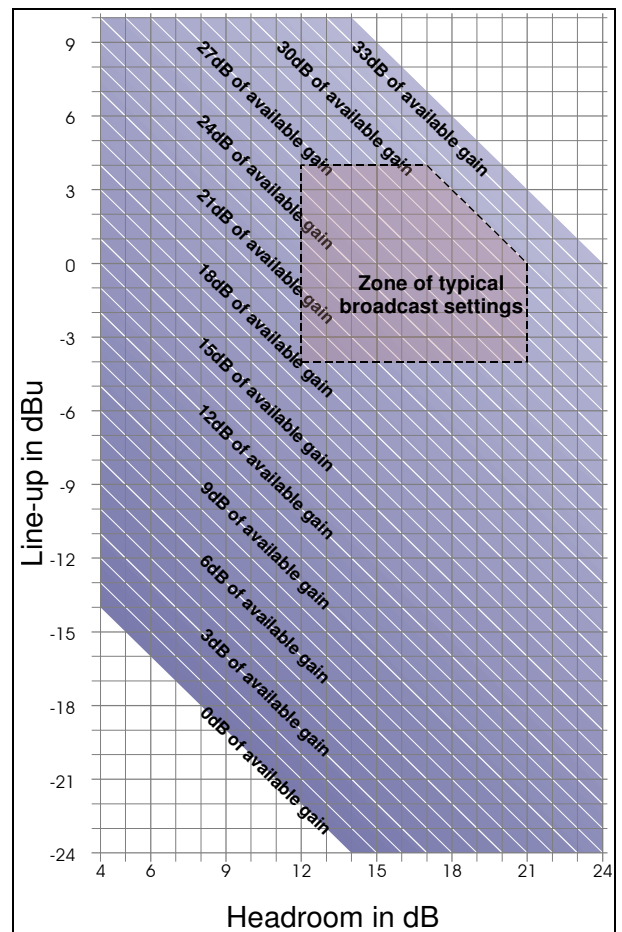

Example 1

Line-up level = +4dBu, Headroom = 18dB
 Test signals in this system are expected to be at +4dBu or 1.23V RMS. The peak signal allowed in this system must not exceed that generated by a sine wave at +22dBu (4dBu + 18dB) or 27.32V pk-pk. From the chart you can see that the available gain is 32dB.

Example 2

Line-up level = 0dBu, Headroom = 20dB
 Test signals in this system are expected to be at 0dBu or 0.775V RMS. The peak signal allowed in this system must not exceed that generated by a sine wave at +20dBu (0dBu + 20dB) or 21.92V pk-pk. From the chart you can see that the available gain is 30dB.

Audio Setup (continued)**Audio Slew Select**

This is the time taken for the audio to slew when the audio mixing and routing controls have changed.

The options are:

Instant The response is immediate

Slowest .. Change takes approximately one second

Slow Change takes 75% of Slowest time

Medium .. Change takes 50% of Slowest time

Fast Change takes 25% of Slowest time

Channel Status Dest(ination)

This will set the four character name used in the destination field of the audio channel status.

To change the text, type the new text in the text area and then select  (return).

Selecting Preset  will return the text to the default text (TEST).

Note that the Channel Status Origin data is automatically set by the module to DEC0 and cannot be changed.

AES Validity Bit

When checked the AES validity Bit will be set; when unchecked it will be cleared.

Analog Audio Cal

This function allows the audio ADC's to be re-calibrated for 0 dBfs.

ADC Reset

When selected the audio ADC's will be re-calibrated for 0 dBfs.

ADC Reset On Input Switch

When checked the audio ADC's will be re-calibrated for 0 dBfs whenever a different video input is selected.

It is recommended that this function is left unchecked as it may disturb the audio output signal.

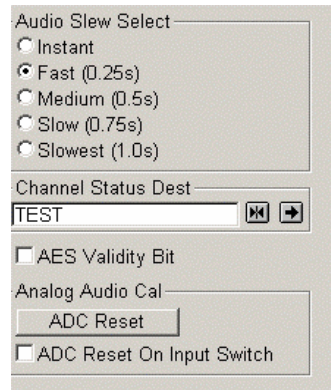

Genlock

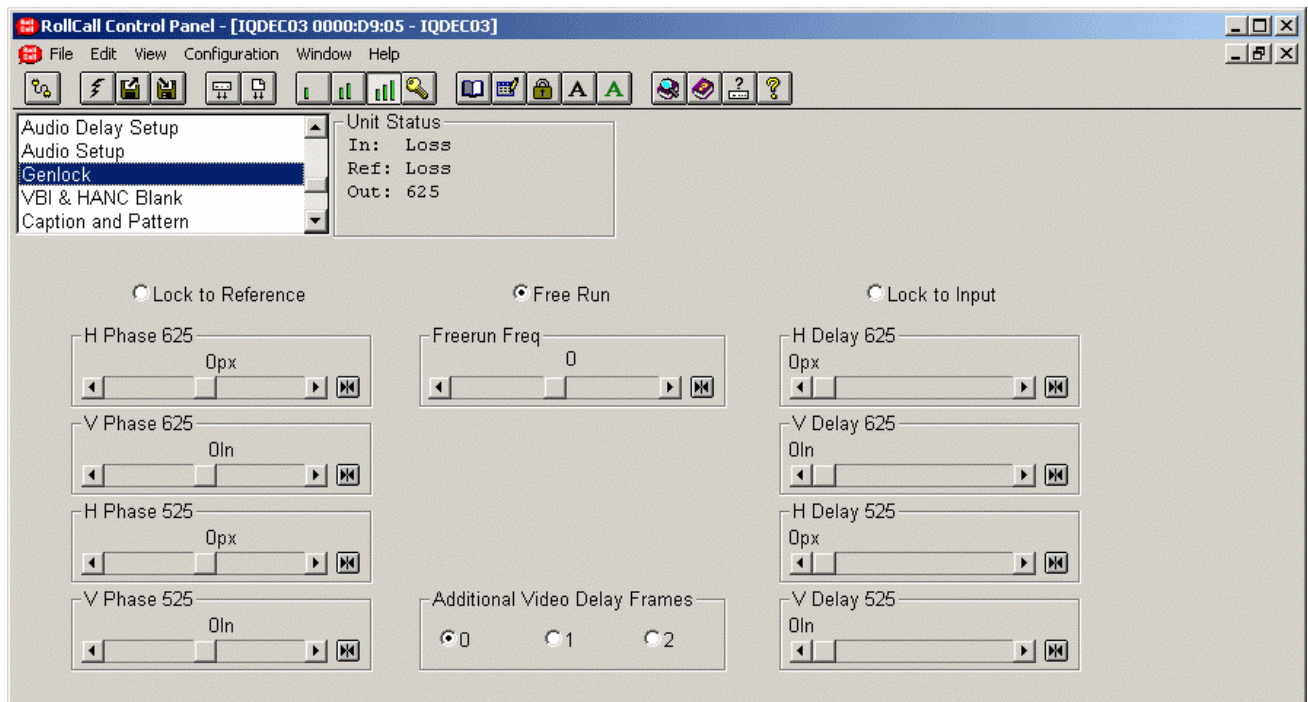

This allows the genlock and delay options to be selected.

Lock to Reference

When selected and the unit will lock to the external reference signal.

Free Run

When selected the unit will not be locked to any input signals and the unit will free run.

Lock to Input

When selected and the unit will lock to the input video signal.

Note that this selection is not available when the Decoder is set to the VHS/Unstable mode.

H(orizontal) Phase (625/525)

This item allows the horizontal timing of the output signal relative to the reference sync signal to be adjusted using the scrollbar by $\pm \frac{1}{2}$ line in 1 pixel steps.

Note that picture disturbance may occur while this setting is adjusted.

Selecting Preset returns the setting to zero. (Output coincident with reference)

V(ertical) Phase (625/525)

This item allows the vertical timing of the output signal relative to the reference sync signal to be adjusted, in TV lines. The scrollbar will adjust this value. Range is ± 262 lines (525 standard) or ± 312 lines (625 standard) in 1 line steps.

Note that picture disturbance may occur while this setting is adjusted.

Selecting Preset returns the setting to zero. (Output coincident with reference)

Freerun Freq(ueency)

This allows the freerun frequency of the internal sync generator to be adjusted in steps of arbitrary units. Preset is to 0.

Genlock (continued)

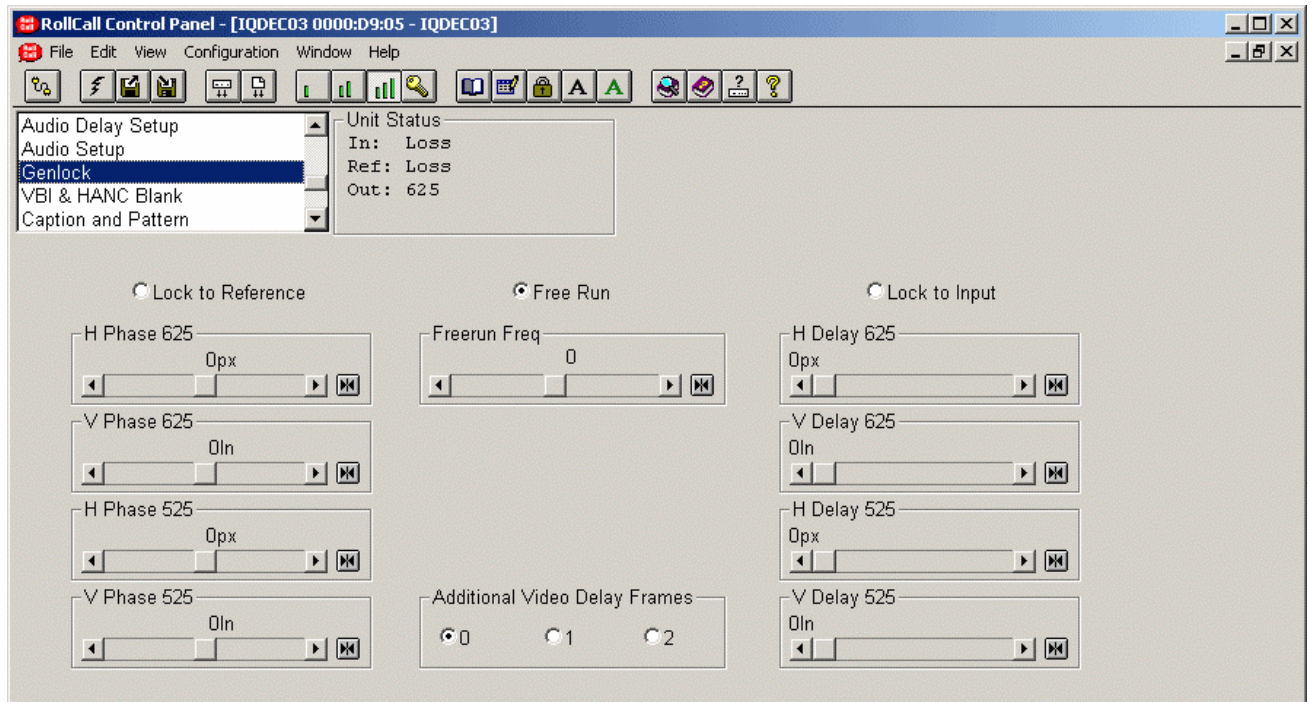

Delay (625/525)

When these controls are used the output signal will appear after the input signal with a time delay. When not used the module will operate in the synchronize mode.

*Note that the H and V delay functions are only active when the **Lock to Input** mode is selected.*

H(orizontal) Delay (625/525)

This item allows the horizontal timing of the output signal relative to the input signal to be adjusted by up to 1 line in 1 pixel steps. The scrollbar will adjust this value.

Selecting Preset returns the setting to the minimum horizontal delay.

V(ertical) Delay

This item allows the vertical timing of the output signal relative to the input signal to be adjusted, in TV lines. The scrollbar will adjust this value. Range is from 0 to 624 or 524 lines in 1 line steps.

Selecting Preset returns the setting to the minimum vertical delay.

Video Delay Frames

The number of frames that the output signal will appear after the input signal may be set with this item.

Note that this function is available in any genlock mode and will add to any other delay settings.

VBI & HANC Blank(ing)

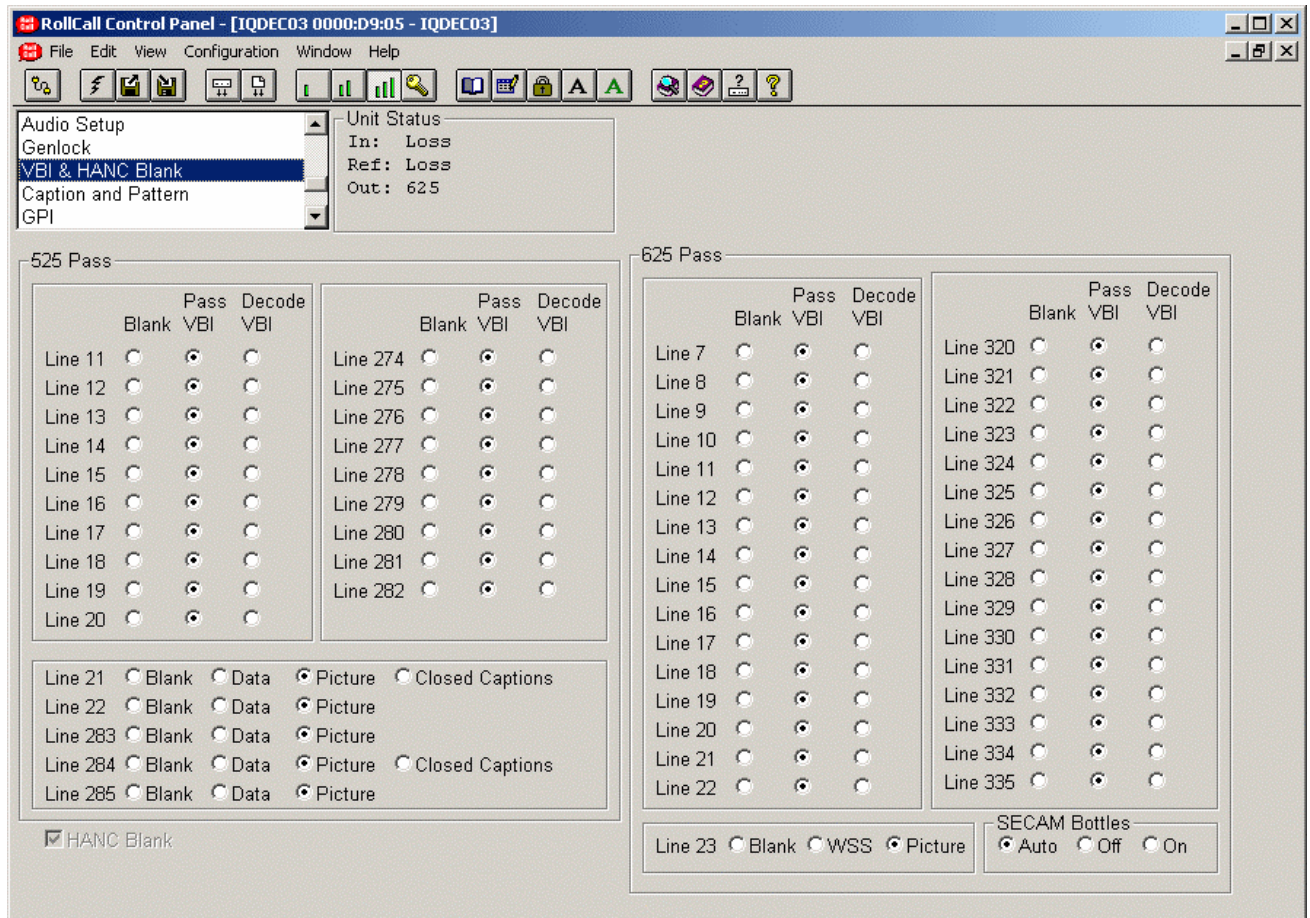

This item allows the selection of Vertical Interval lines contained in the input signal to be blanked or passed through the module as data or as a VITS.

Specific lines may be blanked, passed through as data, passed through as a picture (video), decoded or closed captions by checking the appropriate button.

Definitions:

- Blank** Line content is blanked by synchronizer
- Data** Line is processed by decoder as data, chroma is blanked, Closed Caption disabled.
- Pass as VBI** Line is decoded and chroma passed
- Picture** Line is processed by the decoder as video
- Decode VBI** The line is decoded and processed by the ProcAmp
- Closed Captions** Line is processed by decoder as data, chroma is blanked, Closed Caption enabled

Line 23

The options for this line are:

- Blank** Line content is blanked by synchronizer
- WSS** 1st half of line is processed as data, chroma blanked, 2nd half of line is processed as video
- Picture** 1st half of line is blanked by decoder, 2nd half of line is processed as video

VBI & HANC Blank(ing) continued

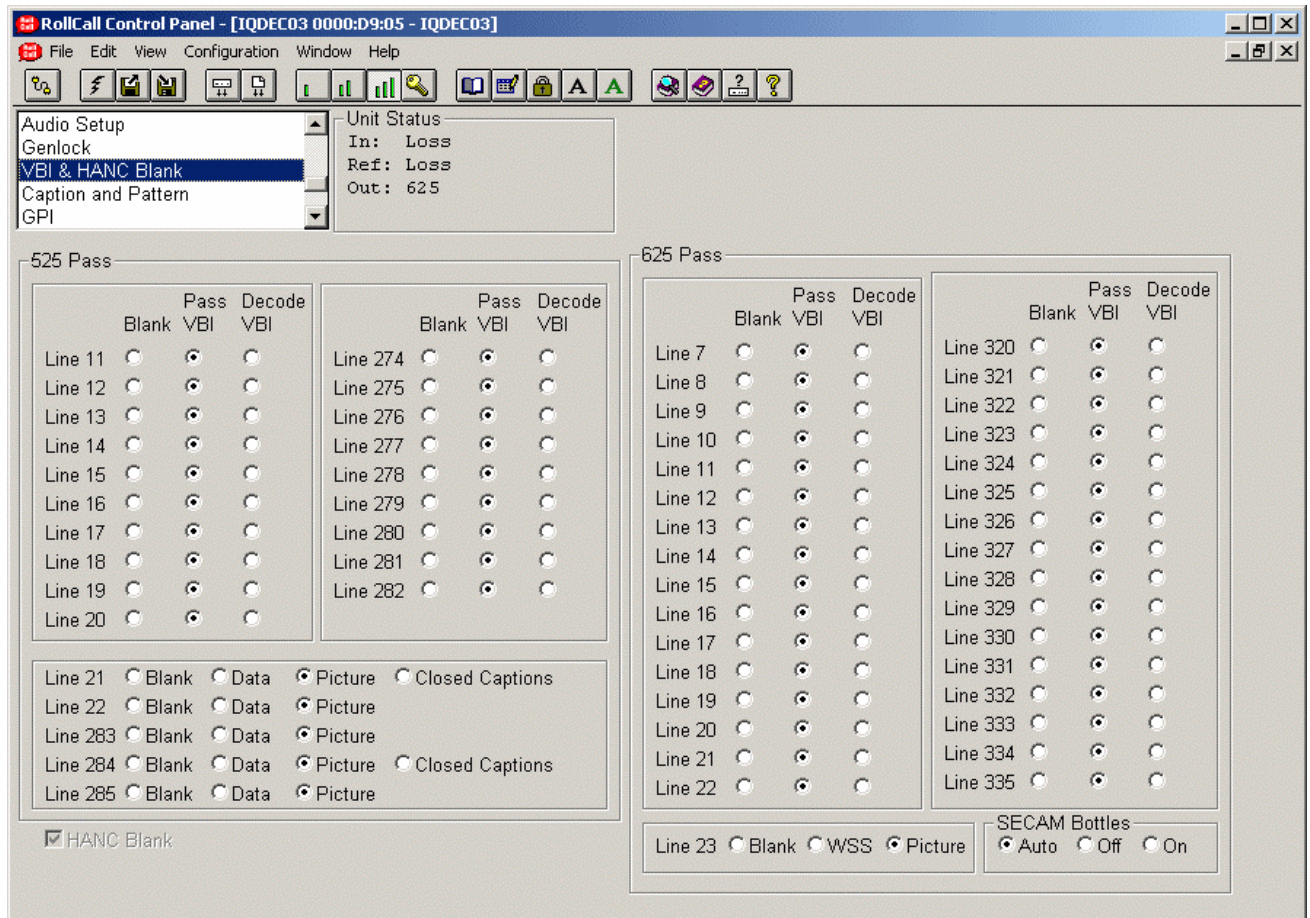

HANC Blank

When checked all horizontal data will be blanked on the input.

When unchecked HANC will be passed uncorrupted as long as the Bus audio embedders are disabled. If the synchronizer is synchronizing then frames (including the HANC) might be dropped or repeated.

Note that the HANC Blank control will always be checked (and grayed out) if a composite or YC input is selected or if the audio embedders are enabled.

Dolby-E Processing

If embedded Dolby-E audio is present in the SDI input, it will be passed through the module and be present uncorrupted in the SDI output as long as the following conditions have been met:

1. The SDI input is the currently selected input
2. On this screen **HANC Blank** is not checked
3. On the **Audio Outputs** screen (see page 25), both Embedders (1 & 2) are disabled

This means that the Dolby-E stream cannot be extracted from the input and processed (as PCM audio could be) and therefore it cannot be routed to Bus A or Bus B and appear at the AES outputs. This is simply a pass-through function which allows upstream Dolby-E extraction and processing to occur.

Caption & Pattern

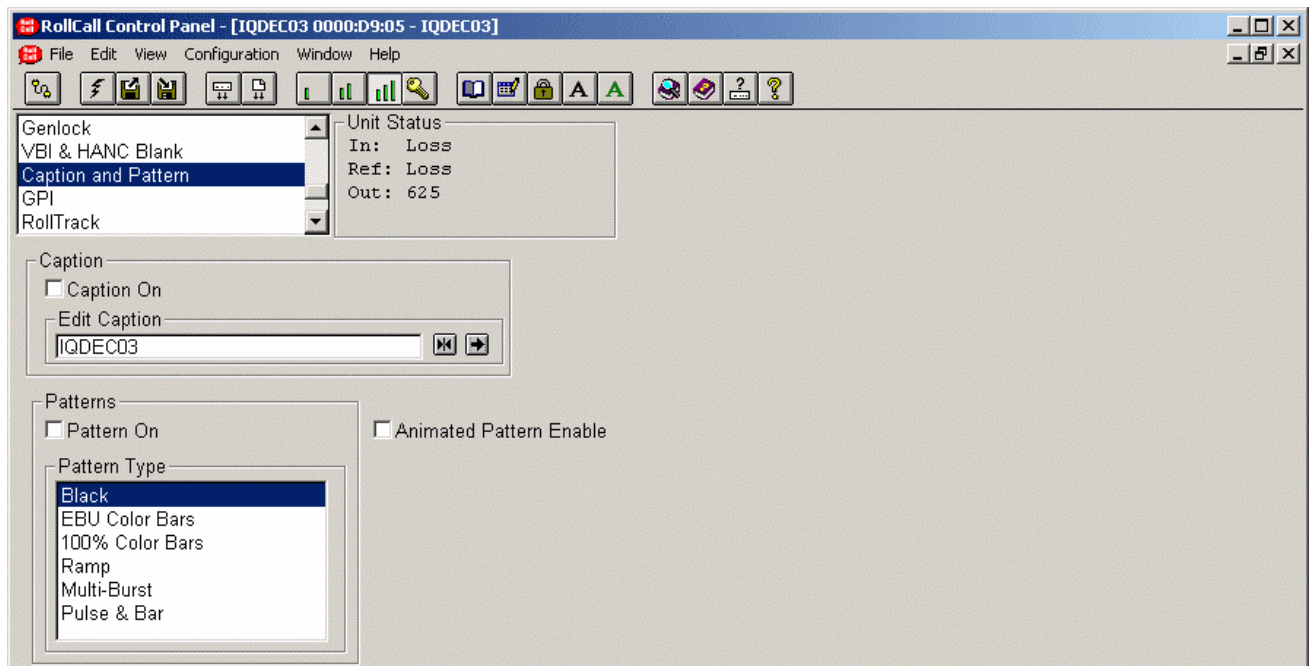

This function will allow a caption to be edited and selected and various patterns to be used as the output signal when the Pattern On function is selected.

Caption

This function allows control of the caption (white text on a black background) which may contain a maximum of 19 characters (including spaces).

The caption will appear in the lower section of the picture.

Edit caption

To change the caption, type the new text in the text area and then select  (return).

Selecting Preset  will return the text to the default text (IQDEC03).

Select Caption

- Caption Off The caption will not appear on the screen
- Caption On The caption will appear on screen



Caption Text

Caption & Pattern (continued)

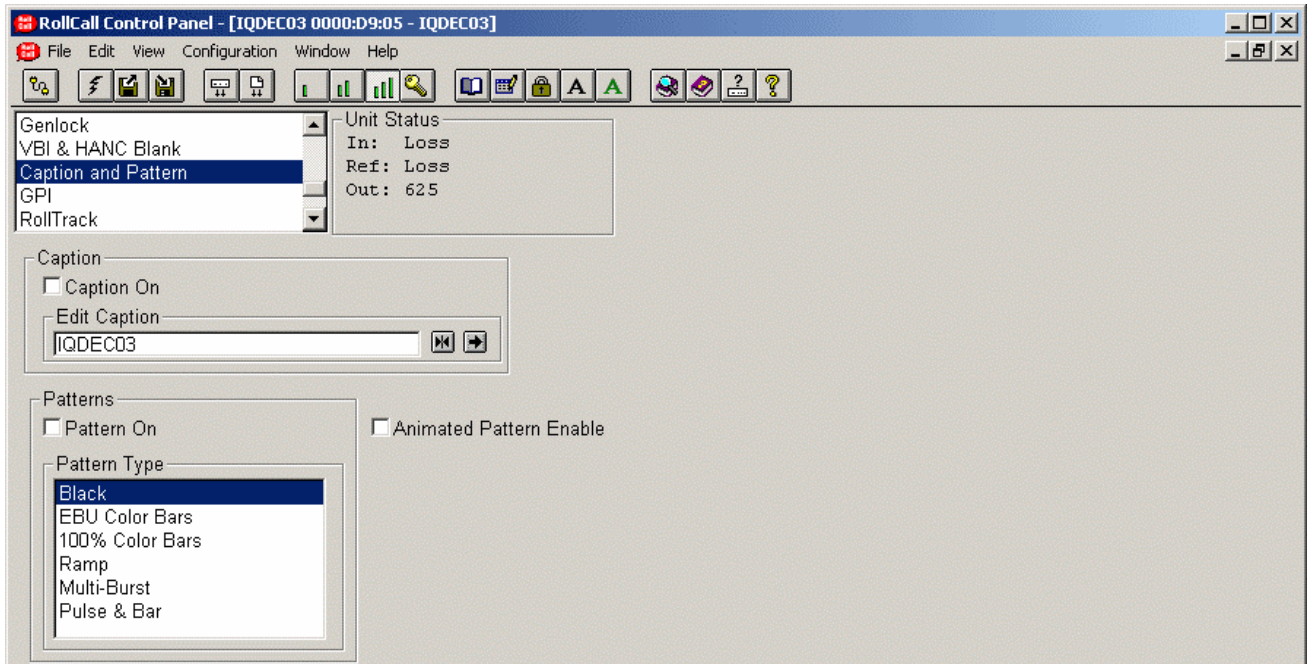

Patterns

Pattern On

When selected the output will become the pattern selected from the **Pattern Type** list.

Pattern Type

One of the patterns (including Black) may be selected from the list.

Animated Pattern

When selected, a monochrome rectangular area will appear on the output picture as shown opposite. The brightness of this rectangle will ramp from black, through gray to white and then directly to black over a period of about one second. This action will then be repeated continuously.

This pattern is useful for checking active video paths. Down stream equipment can see that video has not been frozen.

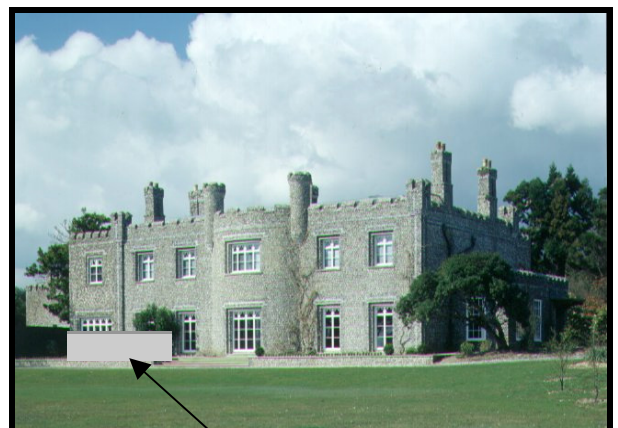

Animated Pattern

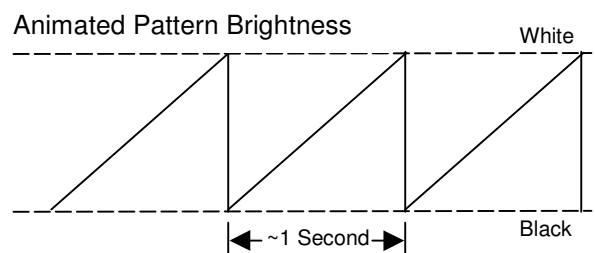

GPI

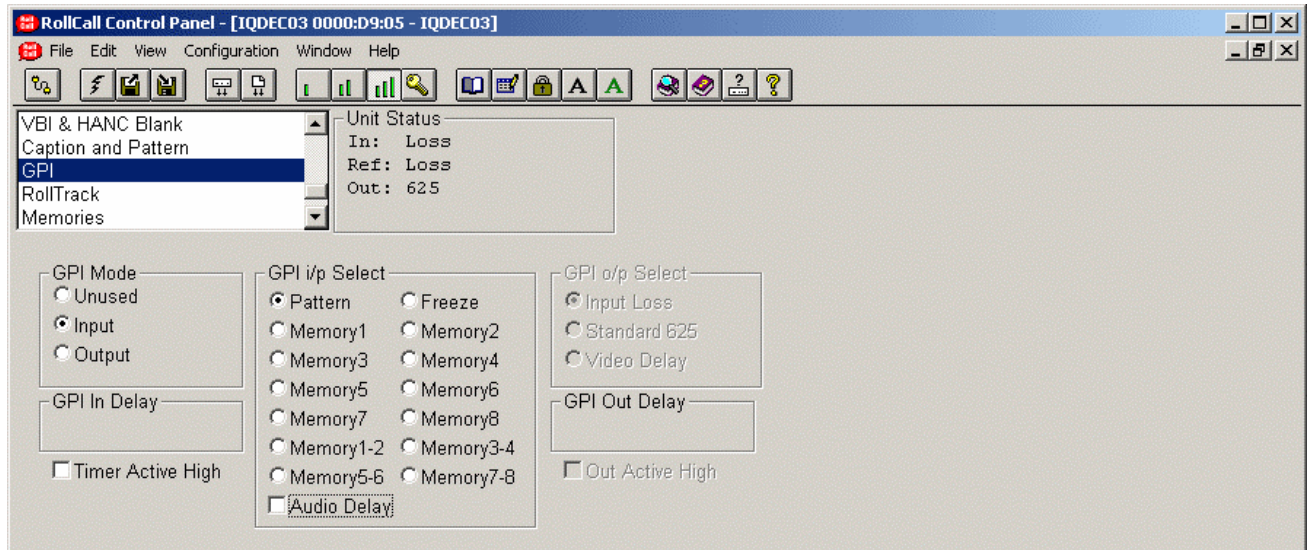

This screen allows the GPI functions to be configured and their actions defined.

GPI Mode

This allows the GPI port to be configured as an **Input**, an **Output** or **Unused**. If **Unused** is selected the **GPI i/p Select** and **GPI o/p Select** items will be grayed out.

GPI i/p Select

When configured as an input the GPI connection may be used for accepting GPI information (from mechanical switch contacts, relay contacts etc.) The resulting action that the unit takes may be selected using this item.

The GPI input functions that may be selected are as follows:

- Pattern** The unit will produce a pattern chosen from the Pattern menu when the input changes from open to closed.
- Freeze** The output picture will become a frozen frame when the input changes from open to closed.

Memory 1 to 8

The unit will use the settings in the selected memory location when the input changes from open to closed.

Mem1-2 The unit will toggle between the settings of memory locations 1 and 2. Open to Closed = Memory 1 settings
Closed to Open = Memory 2 settings

Mem 3-4 The unit will toggle between the settings of memory locations 3 and 4. Open to Closed = Memory 3 settings
Closed to Open = Memory 4 settings

Mem 5-6 The unit will toggle between the settings of memory locations 5 and 6. Open to Closed = Memory 5 settings
Closed to Open = Memory 6 settings

Mem 7-8 The unit will toggle between the settings of memory locations 7 and 8. Open to Closed = Memory 7 settings
Closed to Open = Memory 8 settings

Audio Delay The audio delay may be controlled by the width of a pulse on the GPI input. *Note that when checked the other input functions will not be available.*

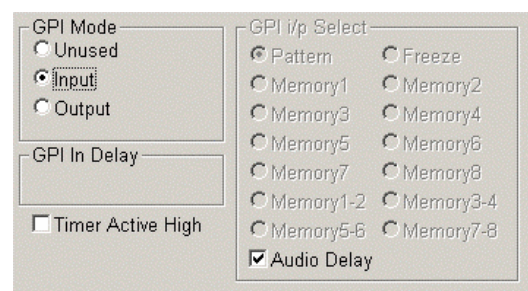

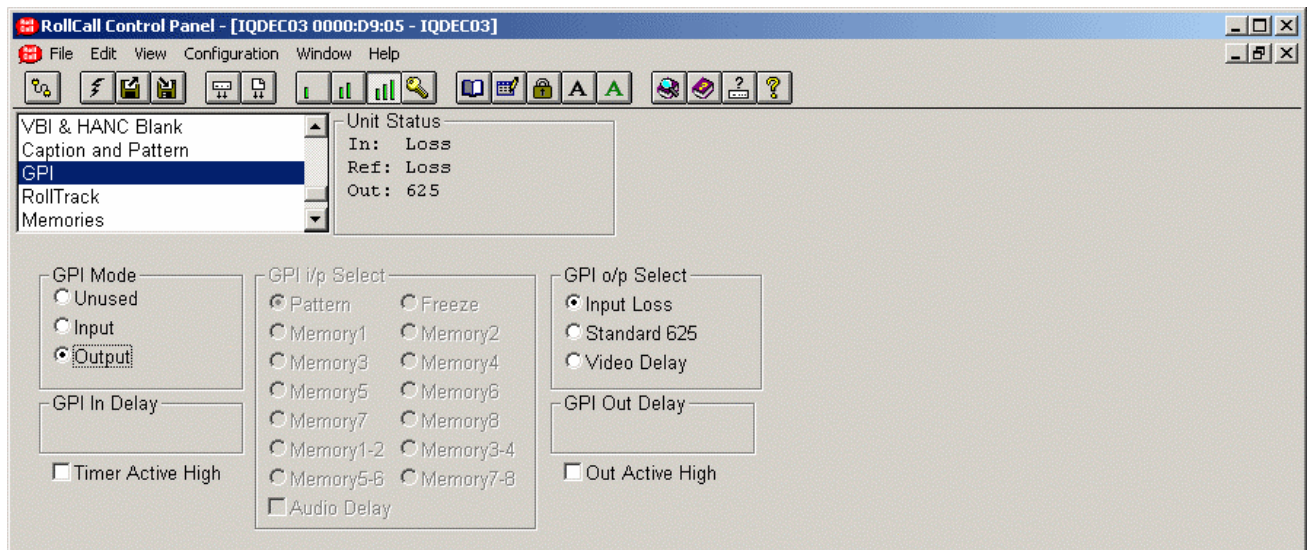
GPI (continued)**GPI o/p Select**

The GPIO may be configured to produce an output corresponding to one of the following conditions:

- Input Loss
- Standard 625
- Video Delay

The preset setting is to Input Loss.

When the condition is not true the output will float but when the condition is true the output is closed to ground via a transistor.

Note that when video delay is selected the output is a negative going TTL pulse. The width of the pulse represents the delay through the unit to the nearest millisecond.

GPI Out Delay

This will show the current video delay through the unit and hence the width of the GPI output TTL pulse.

Out Active High

This determines the sense of the GPI output signal. When checked the GPI is active high. When unchecked the GPI is active low.

Note this will also set the polarity of the TTL output signal.

RollTrack

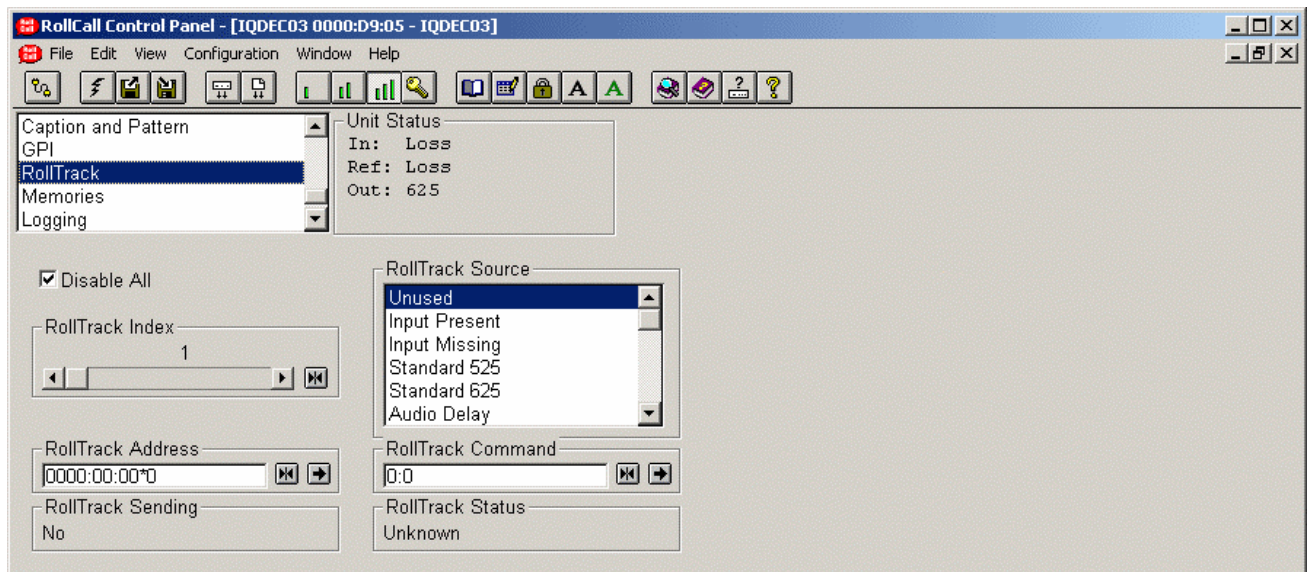

This function allows information to be sent, via the RollCall™ network, to other compatible units connected on the same network.

For example, it can enable compatible audio delay units to produce an audio delay dependent on this and other similar units. The audio delay unit will dynamically follow or track the received delay-time information. This allows processed video signals to be timed correctly with audio signals. This automatic tracking system via the RollCall™ network is called **RollTrack**.

For more detailed information, see the RollTrack section (Appendix) at the end of this manual.

RollTrack Index

This item allows up to 16 destinations to be selected.

RollTrack Source

This allows the source of information that triggers the transmission of data to be selected. Options are:

Unused	De-embed 2 Present
Input Present	De-embed 3 Lost
Input Missing	De-embed 3 Present
Standard 525	De-embed 4 Lost
Standard 625	De-embed 4 Present
Audio Delay	De-embed 5 Lost
Video Delay	De-embed 5 Present
Ref. Lost	De-embed 6 Lost
Ref. Present	De-embed 6 Present
Ref. Error	De-embed 7 Lost
De-embed 1 Lost	De-embed 7 Present
De-embed 1 Present	De-embed 8 Lost
De-embed 2 Lost	De-embed 8 Present

The destination for the information is set by the network code address as follows:

Network Address

This item allows the address of the selected destination unit to be set.

To change the address, type the new destination in the text area and then select  (return).



(Preset) returns to the default destination

The full **RollTrack** address has four sets of numbers

For example: 0000:10:01*99

The first set (0000) is the network segment code number

The second set (10) is the number identifying the (enclosure/mainframe) unit.

The third set (01) is the slot number in the unit

The fourth set (99) is a user settable number that is a unique identification number for the destination unit in a multi-unit system. This ensures that only the correct unit will respond to the command. If left at 00 an incorrectly fitted unit may respond inappropriately.

RollTrack (continued)

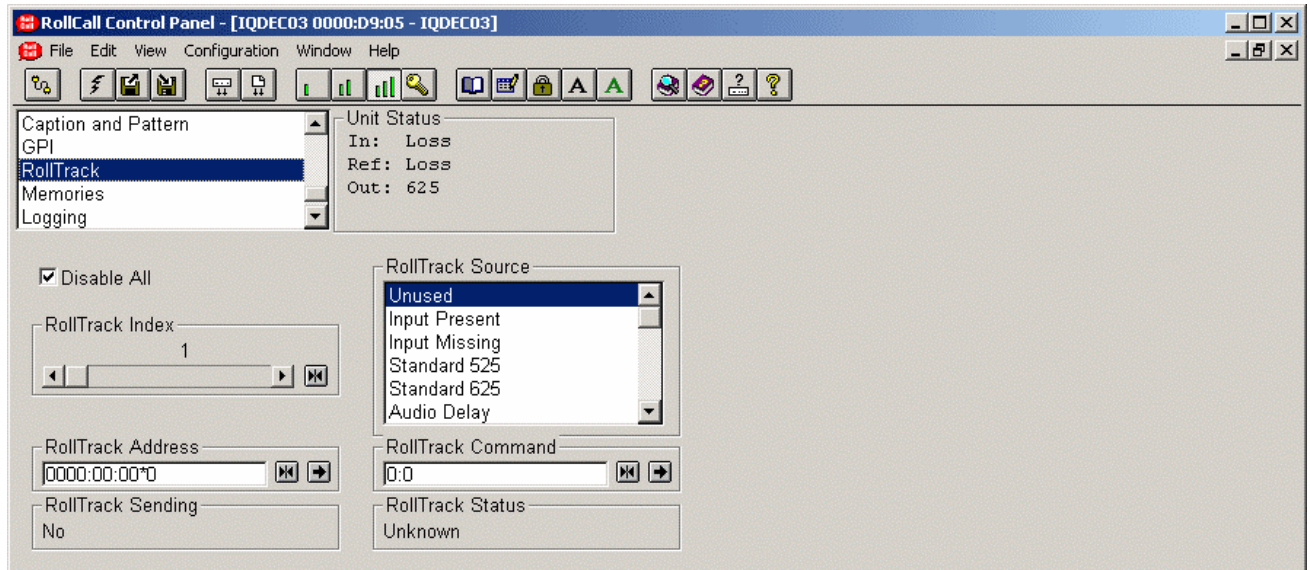

RollTrack Command

The full **RollTrack** command has two sets of numbers

For example: 84*156

The first set (84) is the **RollTrack** command number.

Note that only command numbers 14,15,16 and 17 should be used for audio delay

The second set (156) is the value sent with the **RollTrack** command number.

*Note that when video delay is selected as the **RollTrack** source the value sent with the **RollTrack** command is the video delay value not the value set.*

For details of the RollCall command values for specific units please contact your local Snell & Wilcox agent.

Disable All

When this item is checked all RollTrack items will be disabled.

RollTrack Sending

This item shows when the unit is actively sending the RollTrack command.

This may show:

- String A string value is always being sent.
- Number A number value is always being sent.
- No The message is not being sent.
- Yes The message is being sent.
- Internal Inconsistent behavior; please contact
Type Error your local Snell & Wilcox agent.

RollTrack Status

This item will show the status of the currently selected RollTrack index.

This may show:

- OK RollTrack message sent and received OK.
- Unknown Rolltrack message has been sent but it has not yet completed.
- Timeout RollTrack message sent but acknowledgement not received. This could be because the destination unit is not at the location specified.
- Error This indicates a broken RollCall state.
- Bad This indicates a broken RollCall packet.

Memories

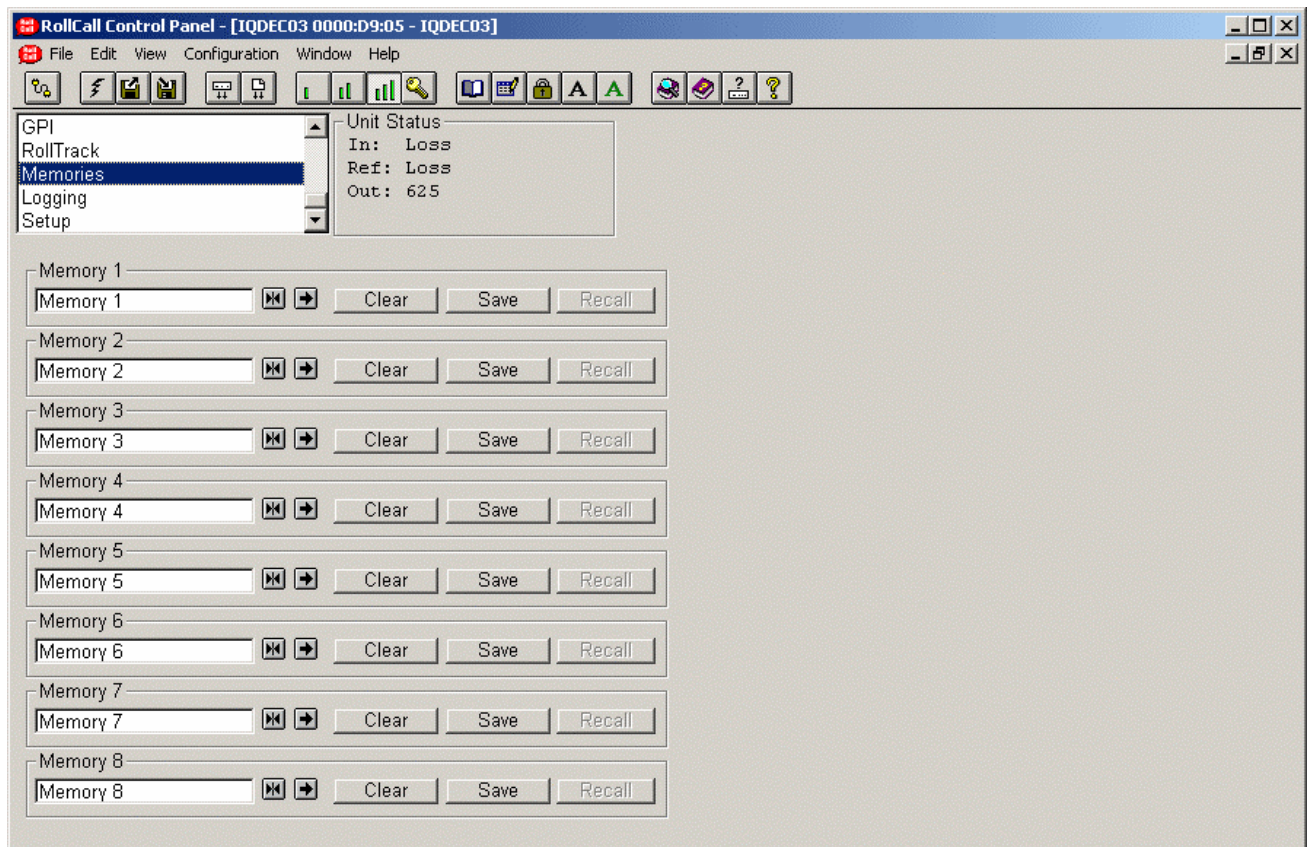

This function allows a number of particular setups of the unit to be saved and recalled. There are 8 memory locations available.

To change the memory name, type the new name in the text area and then select  (return).

Selecting Preset  will return the text to the default name.

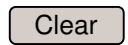

This function will clear the contents of the memory location.

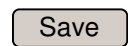

This function allows the settings of all items to be saved at the memory location.

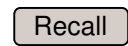

This function allows the settings saved at the memory location to be recalled. When this button appears grayed out it indicates that the memory location is empty and therefore cannot be recalled.

Logging

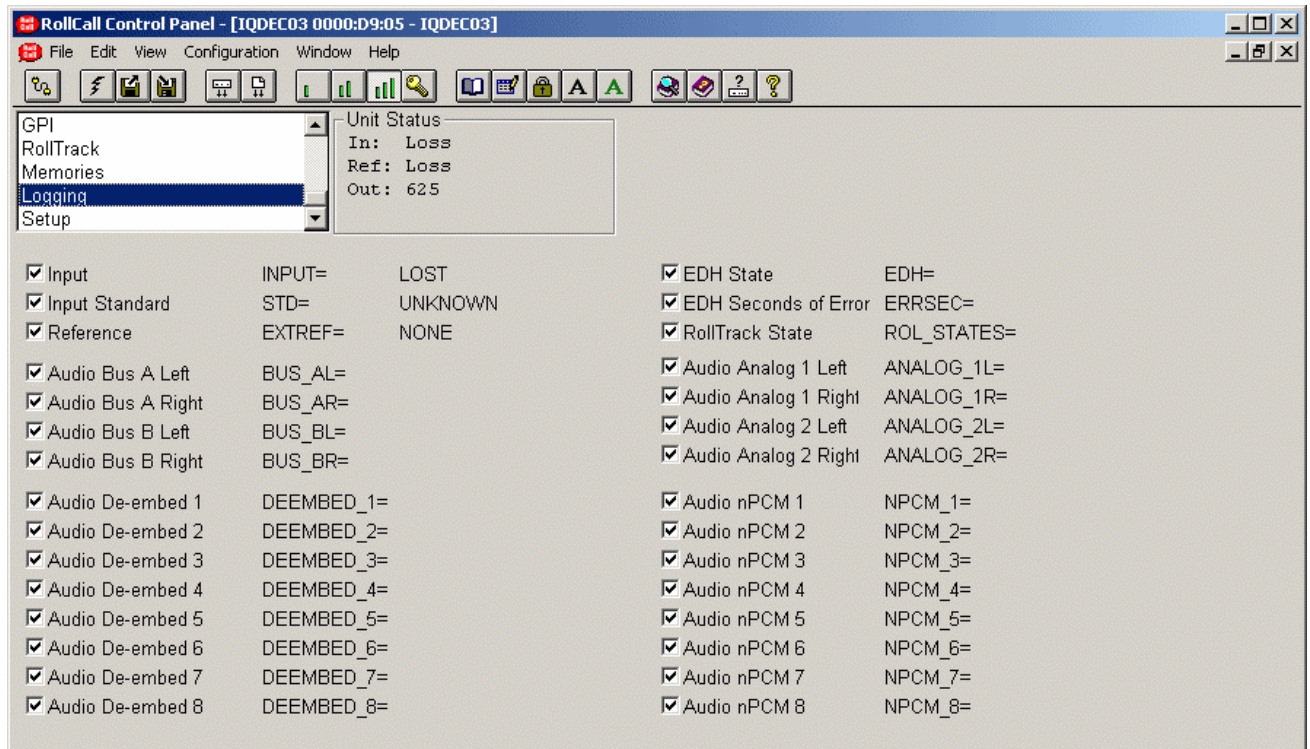

Information about various parameters can be made available to a logging device that is attached to the RollCall™ network by checking the appropriate box.

The status is shown to the right of the item.

Any of the items may be selected from the list.

ROLLCALL LOG FIELDS

(where applicable)

Log Field	Log Value	Description
INPUT=	OK ERR LOST	Valid input signal Invalid input signal Input signal lost
STD=	UNKNOWN STDERR 525 625 PAL NTSC NTSC_J PAL_M PAL_N SECAM N443_60 PAL443_60 ERROR: 525 ERROR: 625 ERROR: PAL ERROR: NTSC ERROR: NTSC_J ERROR: PAL_M ERROR: PAL_N ERROR: SECAM ERROR: N443_60 ERROR: PAL443_60	Input signal standard not recognized or no signal Not a selected input standard SDI input standard 525 SDI input standard 625 PAL composite input NTSC composite input NTSC J composite input PAL M composite input PAL N composite input SECAM composite input N4.43 60 composite input PAL4.43 60 composite input SDI input standard 525, 525 standard not valid SDI input standard 625, 625 standard not valid Composite input standard invalid, decoding as PAL Composite input standard invalid, decoding as NTSC Composite input standard invalid, decoding as NTSC J Composite input standard invalid, decoding as PAL M Composite input standard invalid, decoding as PAL N Composite input standard invalid, decoding as SECAM Composite input standard invalid, decoding as N4.43 60 Composite input standard invalid, decoding as PAL4.43 60
EXTREF=	525 625 ERROR: 525 ERROR: 625 WARNING: LOSS WARNING:525_N/A WARNING:625_N/A NONE	525 reference, input 525 or lost 625 reference, input 625 or lost 525 reference, input 625, trying to lock to reference 625 reference, input 525, trying to lock to reference Reference lost, trying to lock to reference 525 reference, input 625, not trying to lock to reference 625 reference, input 525, not trying to lock to reference Reference lost, not trying to lock to reference
EDH=	NONE FAIL OK RESET	The unit is not locked to the input signal EDH errors have been found on the input signal No EDH errors found on the input signal EDH statistics have been reset
ERRSEC=	Runtime string	The time since EDH was reset in seconds
ROL_STATES=	OK FAIL	RollTrack message sent and received OK RollTrack message not acknowledged
DEEMBED_1=	NONE OK	Nothing present on pair 1 Embedded pair 1 present on selected SDI input
DEEMBED_2=	NONE OK	Nothing present on pair 2 Embedded pair 2 present on selected SDI input
DEEMBED_3=	NONE OK	Nothing present on pair 3 Embedded pair 3 present on selected SDI input
DEEMBED_4=	NONE OK	Nothing present on pair 4 Embedded pair 4 present on selected SDI input
DEEMBED_5=	NONE OK	Nothing present on pair 5 Embedded pair 5 present on selected SDI input
DEEMBED_6=	NONE OK	Nothing present on pair 6 Embedded pair 6 present on selected SDI input
DEEMBED_7=	NONE OK	Nothing present on pair 7 Embedded pair 7 present on selected SDI input

Log Field	Log Value	Description
DEEMBED_8=	NONE OK	Nothing present on pair 8 Embedded pair 8 present on selected SDI input
NPCM_1=	NONE OK	Non-PCM not present on pair 1 of selected SDI input Non-PCM present on pair 1 of selected SDI input
NPCM_2=	NONE OK	Non-PCM not present on pair 2 of selected SDI input Non-PCM present on pair 2 of selected SDI input
NPCM_3=	NONE OK	Non-PCM not present on pair 3 of selected SDI input Non-PCM present on pair 3 of selected SDI input
NPCM_4=	NONE OK	Non-PCM not present on pair 4 of selected SDI input Non-PCM present on pair 4 of selected SDI input
NPCM_5=	NONE OK	Non-PCM not present on pair 5 of selected SDI input Non-PCM present on pair 5 of selected SDI input
NPCM_6=	NONE OK	Non-PCM not present on pair 6 of selected SDI input Non-PCM present on pair 6 of selected SDI input
NPCM_7=	NONE OK	Non-PCM not present on pair 7 of selected SDI input Non-PCM present on pair 7 of selected SDI input
NPCM_8=	NONE OK	Non-PCM not present on pair 8 of selected SDI input Non-PCM present on pair 8 of selected SDI input
ANALOG_1L	OK WARNING: SILENT WARNING: QUIET WARNING: HIGH WARNING: OVERLOAD	Analog Input 1 Left channel has valid signal selected Analog Input 1 Left channel is receiving silence Analog Input 1 Left channel is receiving low level signal Analog Input 1 Left channel is receiving high level signal Analog Input 1 Left channel is receiving overload signal
ANALOG_1R	OK WARNING: SILENT WARNING: QUIET WARNING: HIGH WARNING: OVERLOAD	Analog Input 1 Right channel has valid signal selected Analog Input 1 Right channel is receiving silence Analog Input 1 Right channel is receiving low level signal Analog Input 1 Right channel is receiving high level signal Analog Input 1 Right channel is receiving overload signal
ANALOG_2L	OK WARNING: SILENT WARNING: QUIET WARNING: HIGH WARNING: OVERLOAD	Analog Input 2 Left channel has valid signal selected Analog Input 2 Left channel is receiving silence Analog Input 2 Left channel is receiving low level signal Analog Input 2 Left channel is receiving high level signal Analog Input 2 Left channel is receiving overload signal
ANALOG_2R	OK WARNING: SILENT WARNING: QUIET WARNING: HIGH WARNING: OVERLOAD	Analog Input 2 Right channel has valid signal selected Analog Input 2 Right channel is receiving silence Analog Input 2 Right channel is receiving low level signal Analog Input 2 Right channel is receiving high level signal Analog Input 2 Right channel is receiving overload signal
BUS_AL=	OK WARNING: SILENT WARNING: QUIET WARNING: HIGH WARNING: OVERLOAD	Router BUS A Left channel has valid signal selected Router BUS A Left channel is receiving silence Router BUS A Left channel is receiving low level signal Router BUS A Left channel is receiving high level signal Router BUS A Left channel is receiving overload signal
BUS_AR=	OK WARNING: SILENT WARNING: QUIET WARNING: HIGH WARNING: OVERLOAD	Router BUS A Right channel has valid signal selected Router BUS A Right channel is receiving silence Router BUS A Right channel is receiving low level signal Router BUS A Right channel is receiving high level signal Router BUS A Right channel is receiving overload signal
BUS_BL=	OK WARNING: SILENT WARNING: QUIET WARNING: HIGH WARNING: OVERLOAD	Router BUS B Left channel has valid signal selected Router BUS B Left channel is receiving silence Router BUS B Left channel is receiving low level signal Router BUS B Left channel is receiving high level signal Router BUS B Left channel is receiving overload signal
BUS_BR=	OK WARNING: SILENT WARNING: QUIET WARNING: HIGH WARNING: OVERLOAD	Router BUS B Right channel has valid signal selected Router BUS B Right channel is receiving silence Router BUS B Right channel is receiving low level signal Router BUS B Right channel is receiving high level signal Router BUS B Right channel is receiving overload signal
SN=	Runtime string	Serial number of unit

Setup

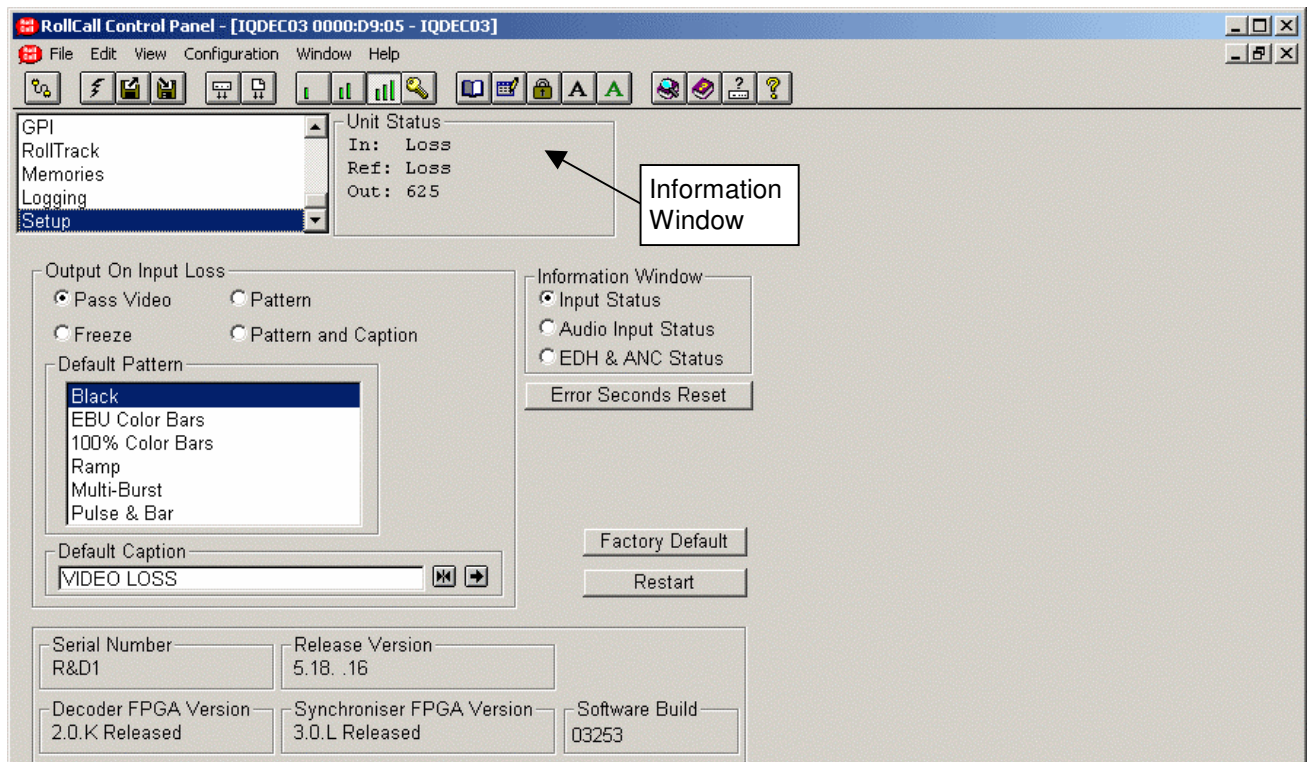

Information Window

The type of information that appears in the Information Window may be chosen with this item.

- Input Status
- EDH & ANC Status
- Audio Input Status

Input Status

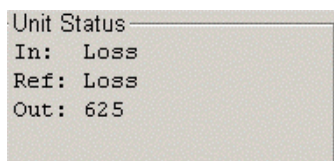

In: This shows the standard of the input and can show the color standard for composite inputs.

Ref: This will show the standard of the reference signal.

Out: This shows the standard of the output signal.

EDH & ANC Status

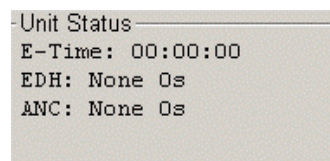

E-Time: This shows the time since EDH was reset in Hours:Minutes:Seconds.

EDH: This shows the EDH status followed by the number of seconds of error since reset

ANC: This shows the ANC status followed by the number of seconds of error since reset

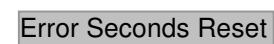

Selecting this function will reset EDH and ANC error count and the timer shown in the information window, to zero.

Setup (continued)

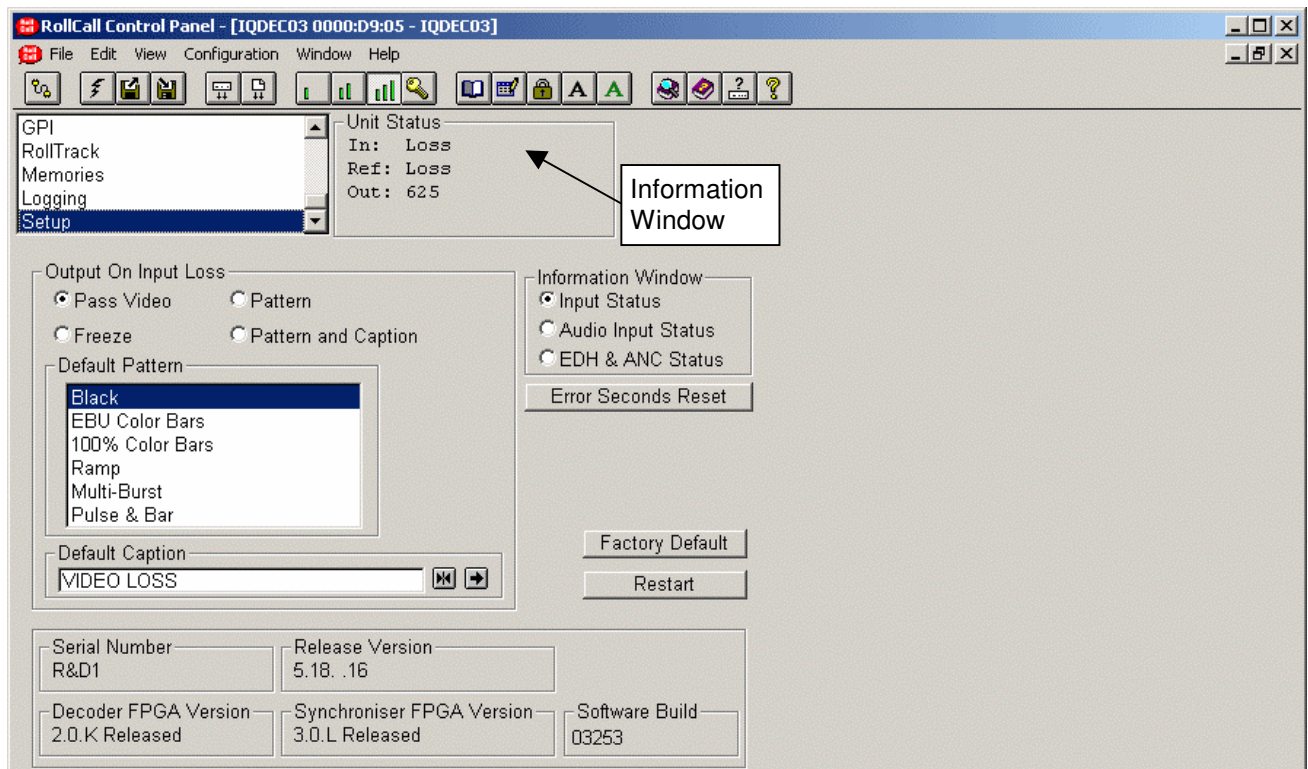

Information Window (continued)

Audio Input Status

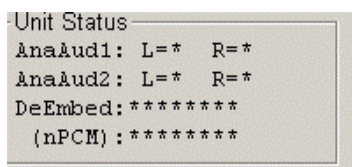

AnaAud1(2) This shows the status of the Left and Right analog audio inputs showing the results of the audio monitoring detectors. Where:

Ov = Overload detected
 OK = Levels within monitoring limits
 * = Silence, no signal detected
 Lo = Low level signal detected
 Hi = High level detected

DeEmbed: This shows the DeEmbedded audio pairs present on the input as 1, 2, 3, 4, etc.

nPCM This shows the non-PCM audio pairs present on the selected input as 1, 2, 3, 4, etc.

Note that the Dolby header in the data stream is used to detect if the audio is non-PCM.

Output on Input Loss

If the input signal fails or is of poor quality this function will determine what the output signal will become under such conditions.

Pass Video The input signal will be passed to the output.

Freeze The output will become a frozen frame picture.

Pattern The output will become the pattern chosen from the **Default Pattern** list.

Pattern and Caption The output will become the pattern chosen from the **Default Pattern** list plus the **Default Caption**.

Default Pattern

If **Pattern** is chosen in the **Default Output** item the output will become the pattern chosen from this list.

Setup (continued)

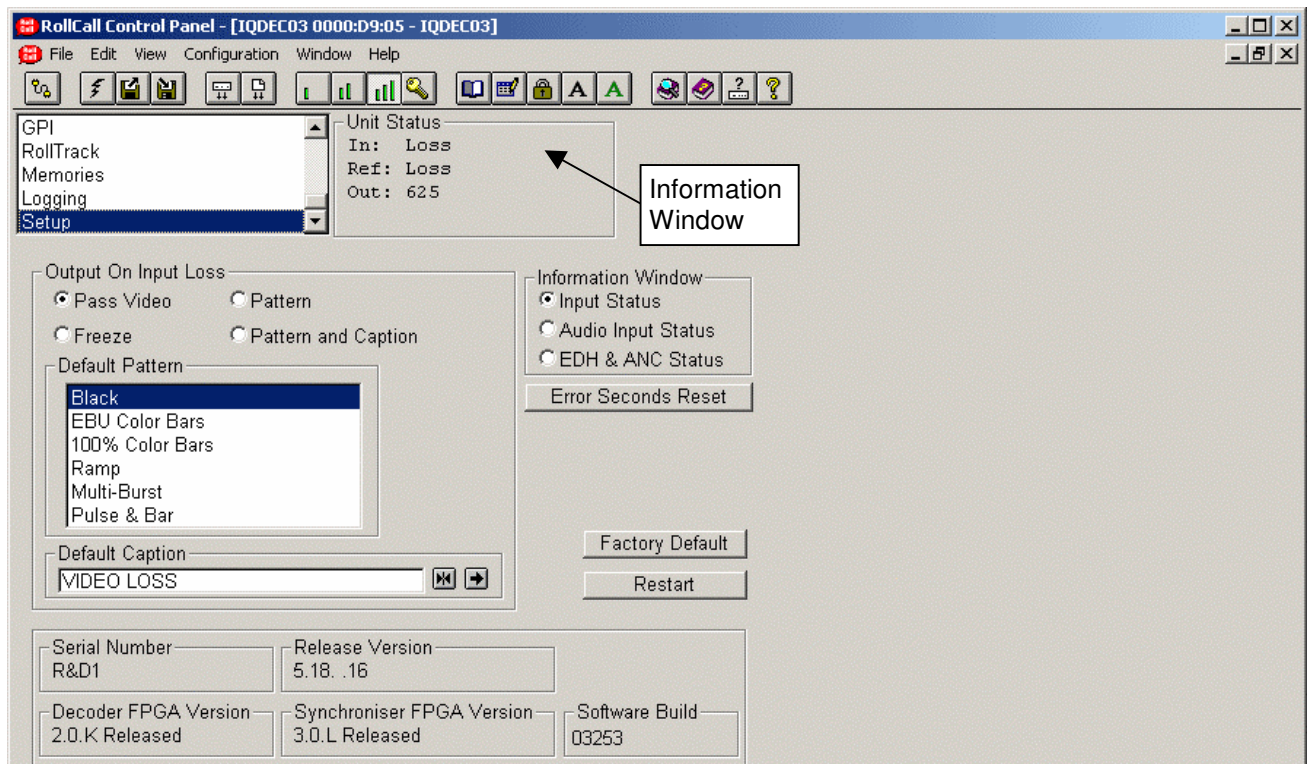
**Default Caption**

This is the caption that will appear if **Pattern and Caption** is chosen from the **Output on Input Loss** function.

To change the caption, type the new text in the text area and then select  (return).

Selecting Preset  will return the text to the default text (VIDEO LOSS).

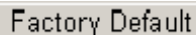

Selecting this item sets all adjustment functions that include a preset facility, to their factory default values.



This will reboot the unit simulating a power-down power-up cycle restoring power-up settings.

Serial Number

This item shows the serial number of the module

Release Version

This item shows the version of the software fitted in the module.

Software Build

This will indicate the factory build number. This number defines all parameters of the unit (software versions, build level etc.) for identification purposes.

Decoder FPGA Version

This will display the version number of the Decoder FPGA fitted to the unit.

Synchronizer FPGA Version

This will display the version number of the Synchronizer FPGA fitted to the unit.

Operation from an Active Control Panel

The card may be operated from an active control panel via the RollCall™ network.



All operational parameters and selections are made using a system of menus displayed in two LCD windows.

Operational details for the remote control panel can be found in the Modular System Operator's Manual.

Information Window

The Information window has four lines of text indicating the current state of the unit.

For details of the abbreviations used please see page 44.

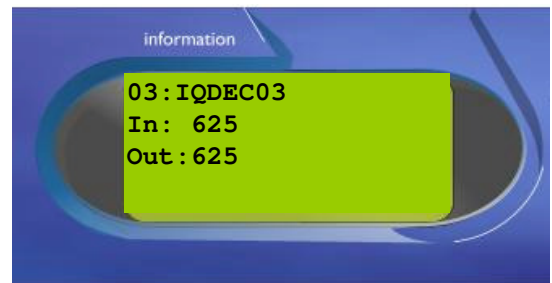

Control Window

The **Control** window displays all Selection Menus and sub-menus.

The selection is made by pressing the button adjacent to the required item.

The menu structure is detailed in the following pages.

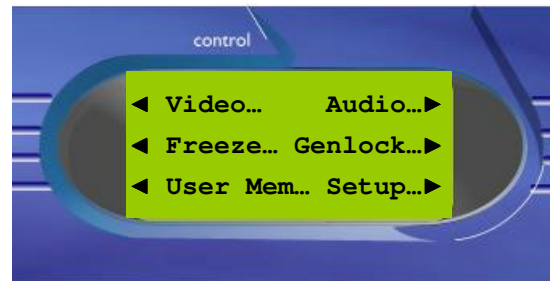

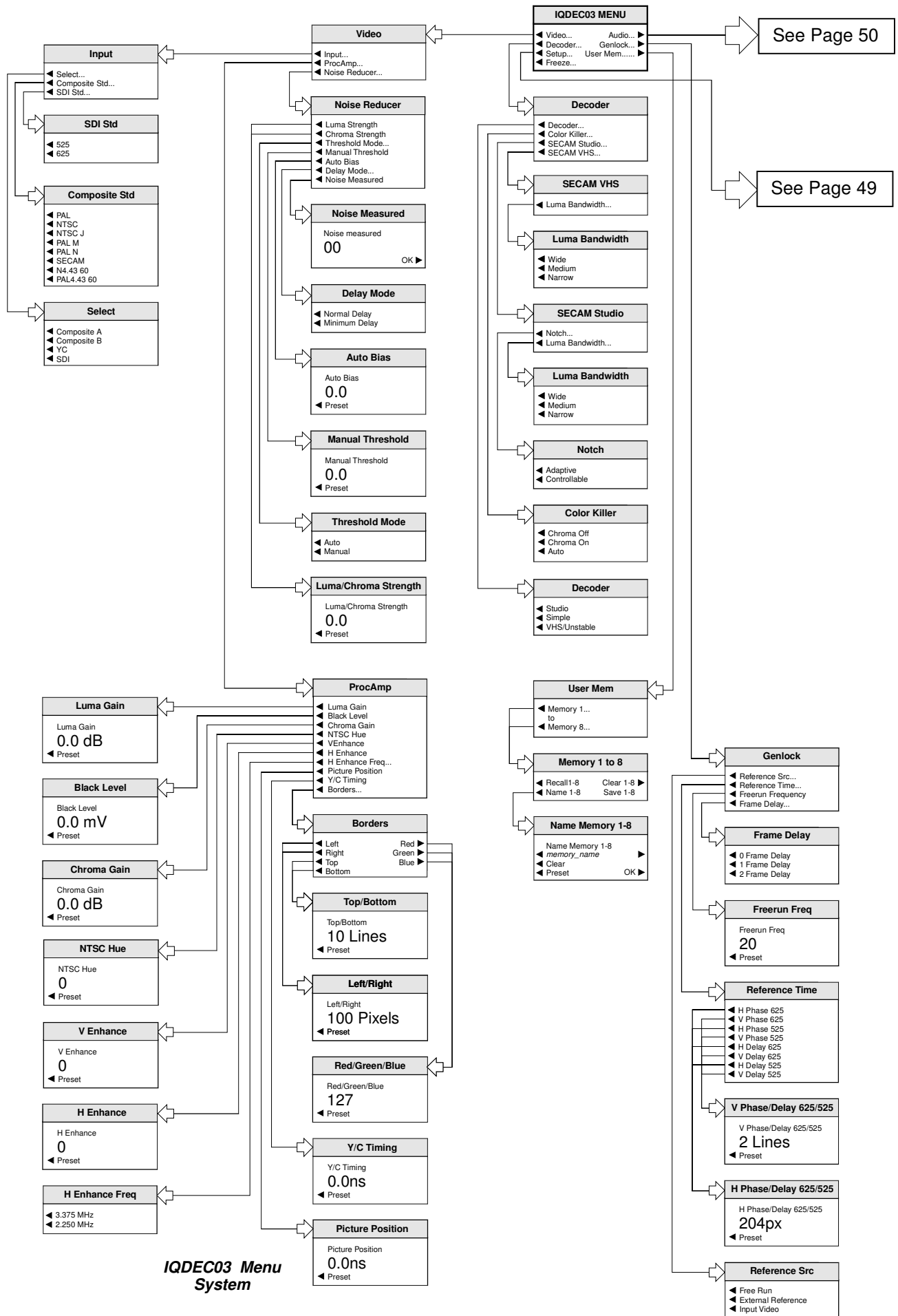

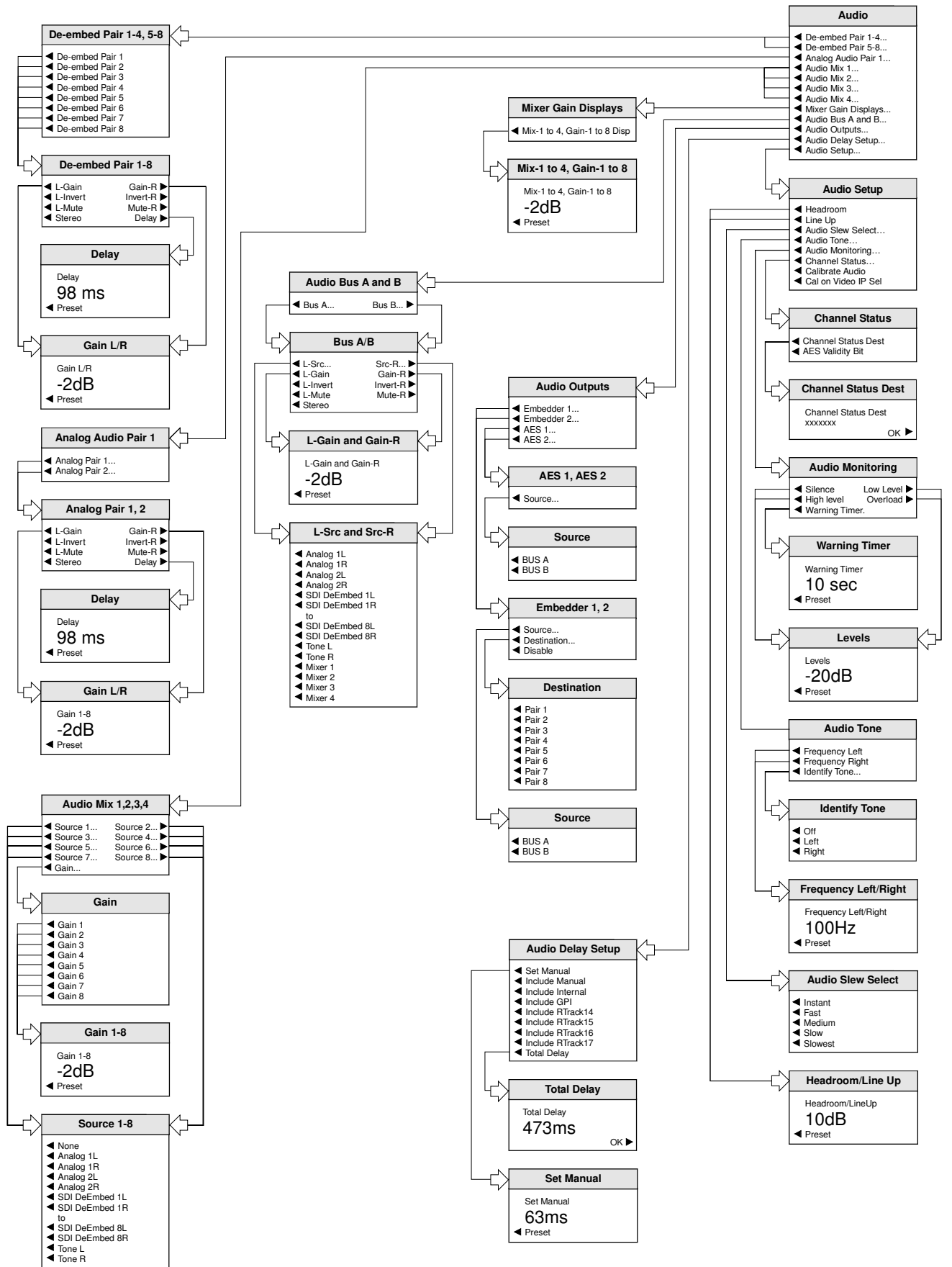

IQDEC03 Menu System

MENU DETAILS

(see IQDEC03 Menu System on previous pages)

MAIN MENU

The main or top level menu allows various sub-menus to be selected by pressing the button adjacent to the required text line.

Note that where a menu item is followed by three dots (...) this indicates that a further sub-menu may be selected.

Whenever a menu item is selected the parameters of that selection will be displayed in the Information window of the front panel. Where the selection is purely a mode selection and does not enable a sub-menu, the text will become reversed (white-on-black) indicating that the mode is active. If the mode is not available for selection the text will remain normal.

Also refer to the block diagram on page 5 for more information.

MAIN MENU

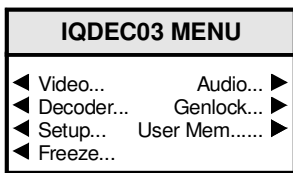

Video

This item allows the input signal to be selected and adjustments to be made.

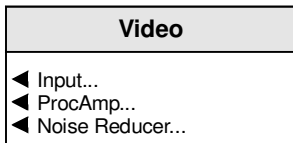

Input

This item allows the input signal and its standard to be selected.

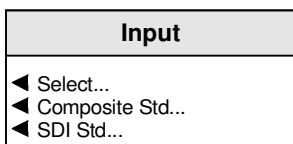

Select

This allows either the **Composite A, Composite B, YC or SDI** input to be selected for processing.

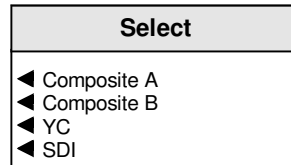

Note that if the unit is de-embedding audio from an SDI signal and then a composite or YC signal is selected the unit will continue to de-embed and output the audio from the SDI signal.

Composite Standard

This allows the automatic detection of the color standard(s) for the composite and Y/C input.

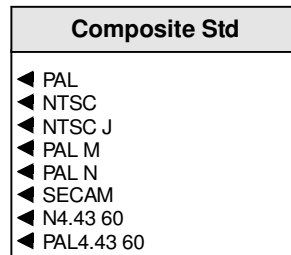

The module will automatically detect any of the color standards that have been selected.

Note that when selecting and deselecting SECAM the output picture and audio may suffer some disruption.

SDI Std

This allows **input standard** for the SDI input to be selected.

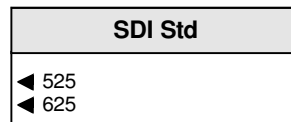

If only 625 is selected the unit will be forced to only accept 625 line inputs.

If only 525 is selected the unit will be forced to only accept 525 line inputs.

If 625 and 525 are selected the unit will accept both 625 and 525 line inputs.

ProcAmp

These items allow signal levels and timings to be adjusted.

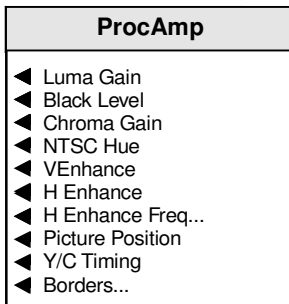

All the values below may be adjusted using the spinwheel.

Luma Gain

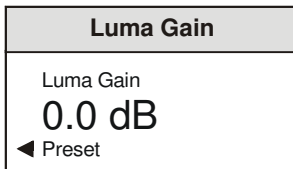

This allows the Y (luminance) gain to be adjusted by ± 6 dB in steps of 0.1 dB. Preset value is 0.0 dB. *Note that the maximum input level is +3 dB.*

Black Level

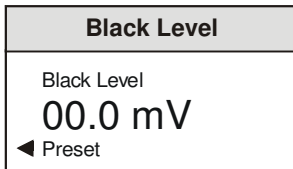

This allows the black level to be adjusted by ± 120 mV in 0.5 mV steps. Preset value is 0.

Chroma Gain

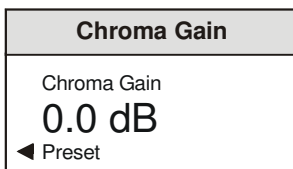

This allows the U/V (color difference) gain to be adjusted by ± 6 dB in steps of 0.1 dB. Preset value is 0.0 dB. *Note that the maximum input level is +3 dB.*

NTSC Hue

This item allows the Hue of an NTSC signal to be adjusted.



The range of adjustment is ± 45 degrees. Preset is to 0 degrees.

V Enhance

This allows vertical enhancement to be applied to the processed signal.

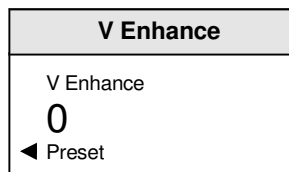

The level of enhancement may set to 0 (Off), 1 (Low), 2 (Medium) and 3 (High). Preset is to 0.

H Enhance

This allows Horizontal enhancement to be applied to the processed signal. The non-linear process prevents enhancement of low amplitude signals typical of noise.

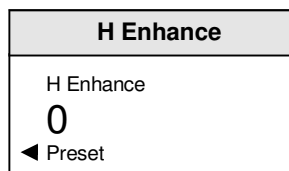

The level of enhancement may set to 0 (Off), 1 (Low), 2 (Medium) and 3 (High). Preset is to 0.

H Enhance Frequency

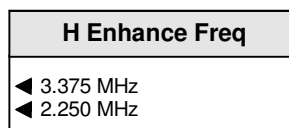

The frequency at which the horizontal enhancement is applied may be set to either 3.375 MHz or 2.250 MHz. Preset is to 3.375 MHz.

Picture Position

Picture Position	
Picture Position	
0ns	
◀ Preset	

This item allows the timing of the picture position relative to the normal value, to be adjusted. The timing may be adjusted by ± 592 ns in 148ns steps.

Y/C Timing

Y/C Timing	
Y/C Timing	
0ns	
◀ Preset	

This item allows the timing of the chrominance signal relative to the luminance signal to be adjusted, (i.e. Y to Cb/Cr timing) in nanoseconds. The timing may be adjusted by ± 592 ns in 148ns steps.

Borders

This allows the active picture to be blanked out or cropped on each of the four sides.

Borders	
◀ Left	Red ▶
◀ Right	Green ▶
◀ Top	Blue ▶
◀ Bottom	

Left/Right

Left/Right	
Left/Right	
100 Pixels	
◀ Preset	

The range of adjustment is from 0 to 200 pixels in steps of 2 pixels. Preset is to 0 pixels.

Top/Bottom

Top/Bottom	
Top/Bottom	
10 Lines	
◀ Preset	

The range of adjustment is from 0 to 200 lines. Preset is to 0 lines.

Red/Green/Blue

The color of the blanked area may be set using the **Red**, **Blue** and **Green** controls

Red/Green/Blue	
Red/Green/Blue	
127	
◀ Preset	

The range of adjustment is from 0 to 255 units. Preset is to 0, 0, 0 units (Black).

Noise Reducer

This allows settings and adjustments to be made to the noise reducer.

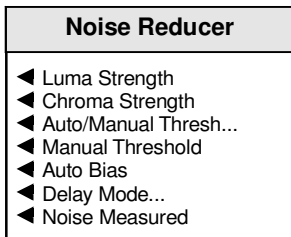

Luma Strength and Chrome Strength

These controls changes the amount of noise reduction for the luminance/chrominance by limiting the maximum level of noise reduction, where 31 is maximum and 0 is minimum. Preset is to 0.

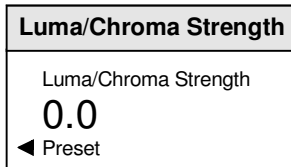

The actual level of noise reduction is dynamically adjusted on a pixel-by-pixel basis with regard to the noise reduction setting for the same pixel in the previous frame.

Auto/Manual (Noise) Threshold

The noise floor may be adjusted automatically or manually using the **Manual Threshold** control.

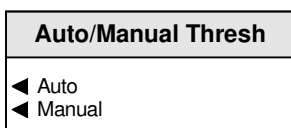

Auto

In this mode the noise floor is automatically measured and the threshold is adjusted dynamically set to an appropriate value for the current input noise level.

The noise detection algorithm may be given a subjective bias using the **Auto (Threshold) Bias** control to give more or less noise reduction.

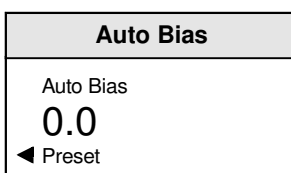

Modification of the bias should not be necessary under normal circumstances.

Manual

In this mode the noise floor may be adjusted manually using the **Manual (Noise) Threshold** control.

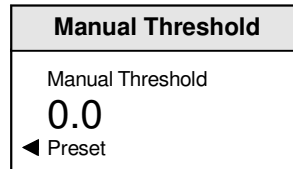

Delay Mode

This allows the delay of the noise reducer to be selected.

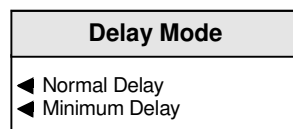

Normal

In this mode the delay will be < 1 Frame

Minimum

This mode produces the minimum input/output delay and may be used where audio delay problems may exist and cannot be compensated for. In this mode the delay will be < 3 Lines

Noise Measured

This provides an indication (as a percentage) of how much noise there is in the signal.

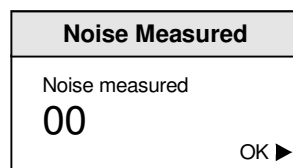

A clean signal will give low figures and a noisy signal high figures.

Decoder...

This menu allows the decoder functions to be set up.

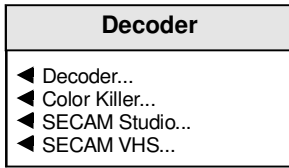

Decoder

This allows the type of decoding to be selected.

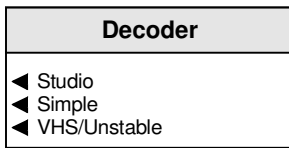

Studio

The composite input is sampled with 12-bit resolution and decoded using adaptive line filters to ensure optimum decoding performance.

Simple

This simple decode mode incorporates a wide bandwidth subcarrier notch filter. This mode is for reference only and should not be used for normal composite material.

VHS/Unstable

In this mode the decoder will cope with sources with unstable time-bases but the decoding is of a lower quality and the frequency response is reduced.

Color Killer

This function controls the color content of the picture.

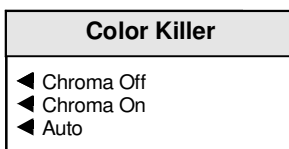

Chroma Off

When selected the color content of the picture will be removed. The luma signal is produced using a narrow bandwidth notch filter.

Chroma On

When selected the color content of the picture will be maintained regardless of the level of the color burst.

Auto

When this item is enabled the picture will become monochrome if the input color burst disappears or the level drops below a critical amplitude. The picture will return to color when the burst level reappears.

SECAM Studio

This function allows adjustments to decoding parameters for a SECAM signal of studio (stable) quality.

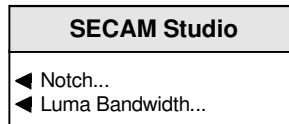

Notch

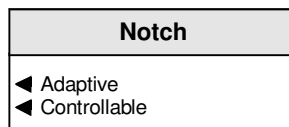

Either the Adaptive or the Controllable luminance notch filter may be enabled with this item.

Luma Bandwidth

This function allows the bandwidth of the decoded luminance to be adjusted.

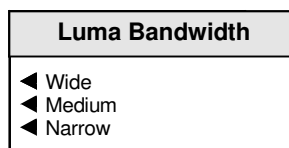

Wide The signal will be processed at full bandwidth (3.4 MHz).

Medium The signal will be processed with a bandwidth of approximately 2.6 MHz.

Narrow The signal will be processed with a bandwidth of approximately 1.7 MHz.

SECAM VHS

This function allows adjustments to decoding parameters for a SECAM signal of VHS (unstable) quality.



Luma Bandwidth

This function allows the bandwidth of the decoded luminance to be adjusted.

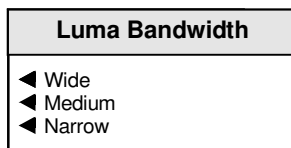

Wide The signal will be processed at full bandwidth (3.4 MHz).

Medium The signal will be processed with a bandwidth of approximately 2.6 MHz.

Narrow The signal will be processed with a bandwidth of approximately 1.7 MHz.

Freeze

When selected the output picture will become a frozen frame.

Audio

This menu allows the audio processing functions to be set up.

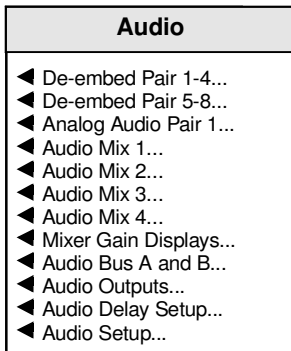

De-embed Pair 1-4 and 5-8

This allows the de-embed pair to be selected for processing.

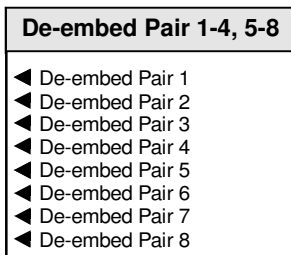

De-embed Pair 1 to 8

This menu allows the de-embedded channels signals to be adjusted and configured.

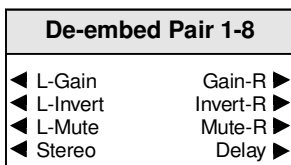

L-Gain, Gain-R

This allows the gain of the Left and Right channels to be adjusted over a range of ±18 dB in 0.1dB steps.

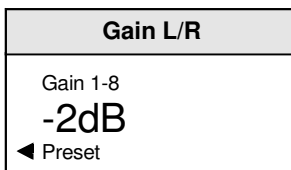

Preset is to 0 dB.

L-Invert, Invert-R...When selected the signal polarity will be inverted.

L-Mute, Mute-R.....When selected the signal will be muted.

StereoWhen selected the left and right channels will be configured as a stereo pair and any adjustments made to one channel will automatically be applied to both channels.

Delay

This control allows de-embedded signals to be delayed.

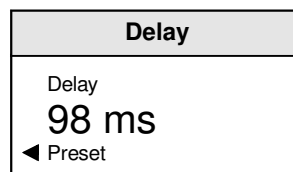

The range of control is from 0 to 1500 ms in 1 ms steps.

Analog Audio Pair 1

This allows the pair to be selected for processing.



Analog Pair 1, Pair 2

This allows control of Gain, Mute, and Polarity over the analog channel pairs and the introduction of delay.

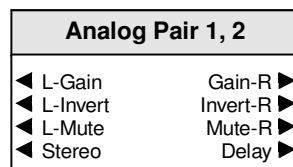

L-Gain, Gain-R

This allows the gain of the Left and Right channels to be adjusted over a range of ±18 dB in 0.1dB steps. Preset is to 0 dB.

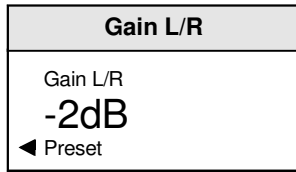

L-Invert, Invert-R...When selected the signal polarity will be inverted.

L-Mute, Mute-R.....When selected the signal will be muted.

StereoWhen selected the left and right channels will be configured as a stereo pair and any adjustments made to one channel will automatically be applied to both channels.

Delay

This control allows an analog audio pair signal to be delayed.

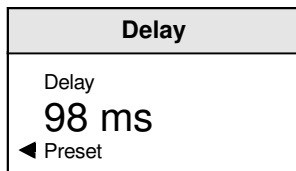

The range of control is from 0 to 1500 ms in 1 ms steps.

Audio Mix 1, 2, 3, 4

There are four separate audio mixers Mix 1, 2, 3 and 4. The outputs of these mixers provide eight extra input selections for the Channel Router.

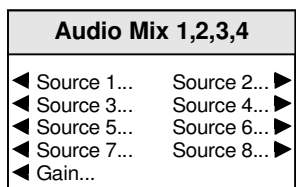

This menu allows the mixer inputs to be selected.

Source 1 to 8

This menu allows the source signals for the mixer inputs to be selected.

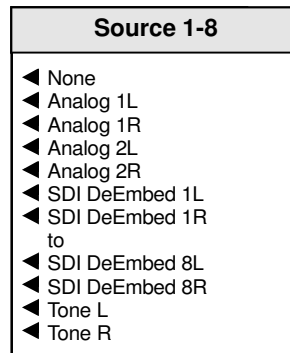

None

No signal selected.

Analog 1L, 1R, 2L and 2R

Any of the analog input channels may be selected.

SDI De-embed 1L, 1R, to 8L and 8R

Any of the de-embedded input channels may be selected.

Tone L, Tone R

An audio tone, set up via the **Audio Setup/Audio/Tone** function, may be selected as an input.

Mixer Gain Displays

Each of the four mixers have eight inputs with individual gain controls that allow the mixing levels for each of the input signals, to be adjusted.

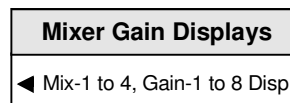

This allows the mixer channels to be selected.

Mix-1 to 4, Gain-1 to 8

This allows the gain of the selected channel to be adjusted.

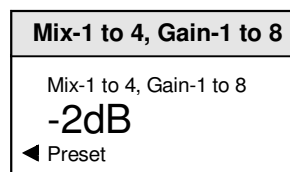

The range of adjustment is from 0 to -96 dB and to Off.

0 to -60 dB is in steps of 1 dB, -60 dB to -96 dB is in steps of 3 dB. Preset is to Off.

Audio Bus A and B

This menu allows the inputs for the two audio buses of the router to be selected and adjusted.

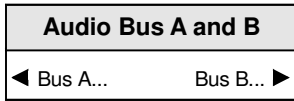

Bus A/B

This allows the bus signals to be adjusted and configured.

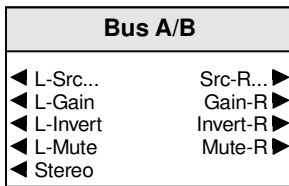

L-Src and Src-R

This menu allows the source signals for the bus inputs to be selected.

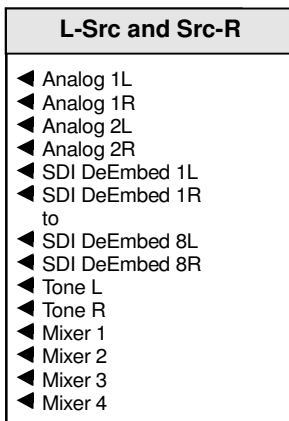

Analog 1L, 1R, 2L and 2R

Any of the analog input channels may be selected.

SDI De-embed 1L, 1R, to 8L and 8R

Any of the de-embedded input channels may be selected.

Tone L, Tone R

An audio tone, set up via the **Audio Setup/Audio/Tone** function, may be selected as an input.

Mixer 1, 2, 3, 4

Any of the mixer outputs may be selected.

L-Gain, Gain-R

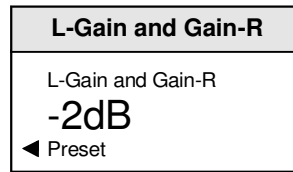

This allows the gain of the Left and Right channels to be adjusted over a range of ±18 dB in 0.1dB steps. Preset is to 0 dB.

L-Invert, Invert-R...When selected the signal polarity will be inverted.

L-Mute, Mute-R....When selected the signal will be muted.

StereoWhen selected the left and right channels will be configured as a stereo pair and any adjustments made to one channel will automatically be applied to both channels.

Audio Outputs

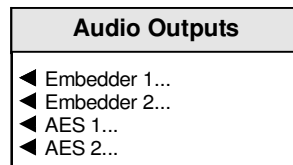

This function sets up the embedder sources and destinations. Higher number embedders have priority, so if the same destination pair is selected on two embedders, the highest embedder will be the one that is active.

Embedder 1, 2

This allows the embedder to be configured.

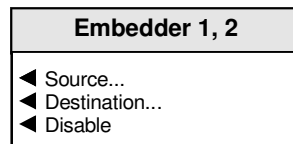

Source

This allows the bus source for embedding to be selected.

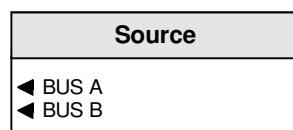

Either BUS A or Bus B may be selected.

Destination

This allows destination for the embedded signal to be selected (Pair 1 to 8).

Destination
◀ Pair 1
◀ Pair 2
◀ Pair 3
◀ Pair 4
◀ Pair 5
◀ Pair 6
◀ Pair 7
◀ Pair 8

Disable

When selected the embedding for the selected destination will be turned off.

AES 1, 2

This allows the AES outputs to be configured.

AES 1, AES 2
◀ Source...

Source

This allows the bus source for the AES output to be selected.

Source
◀ BUS A
◀ BUS B

Either BUS A or Bus B may be selected.

Audio Delay Setup

This menu allows the amount of delay to be set and type of audio delay mechanism to be selected.

Audio Delay Setup
◀ Set Manual
◀ Include Manual
◀ Include Internal
◀ Include GPI
◀ Include RTrack14
◀ Include RTrack15
◀ Include RTrack16
◀ Include RTrack17
◀ Total Delay

*Note that up to 1 s of delay may be applied from the sum of the **Internal** + **GPI** + **RollTrack** delay inputs.*

Set Manual

This sets the manual delay and will affect all processed audio signals equally.

Set Manual
Set Manual
63ms
◀ Preset

The delay may be set to up to +1.5 s in 1ms steps. Preset is to 0 ms.

Internal

When checked, an audio delay equal to the video delay in the unit will be applied.

Include Manual

When selected an audio delay set by the **Manual Delay** control will be applied.

Include GPI

When selected an audio delay will be applied that is equal to the width of the pulse arriving at the GPI connector.

Note that the GPI must be configured correctly for this function to operate. Please see page 36 or details.

Include RollTrack 14, 15, 16 and 17

The selected source(s) of the RollTrack input signal(s) will apply an audio delay.

Total Delay

Total Delay
Total Delay
473ms
OK ▶

This will show the audio total delay (due to all delay mechanisms) through the unit in ms.

Audio Setup

This allows various audio functions to be configured. For definitions of the terms please refer to page 28.

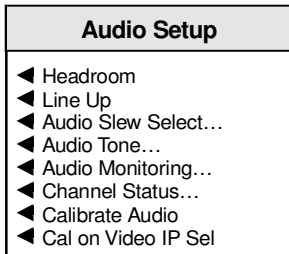

Headroom

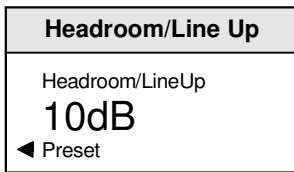

This allows the headroom to be set. The range is from 4 dB to 24dB in 1 dB steps. Preset is to 20 dB.

Note that in this product headroom is defined as:

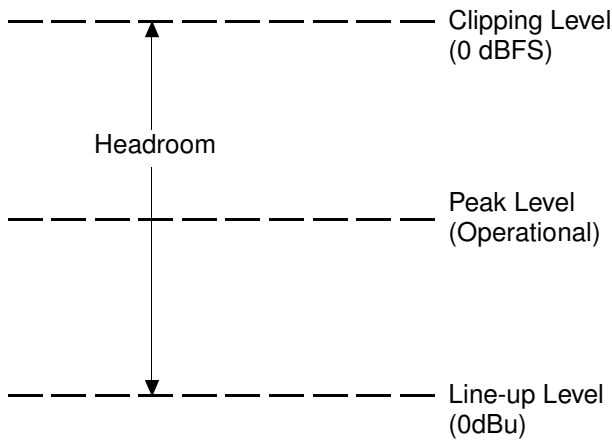

Headroom = Clipping Level – Line-up level

Line Up

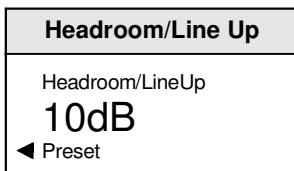

This allows the Line Up level to be set. The range is from 4 dB to 24dB in 1 dB steps. Preset is to 4dBu dB.

For more details please refer to page 28.

Audio Slew Select

This is the time taken for the audio to slew when the audio mixing and routing controls have changed.

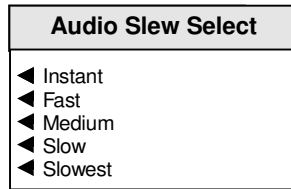

The options are:

- Instant The response is immediate
- Fast Change takes 25% of Slowest time
- Medium .. Change takes 50% of Slowest time
- Slow Change takes 75% of Slowest time
- Slowest .. Change takes approximately one second

Audio Tone

The frequency of the Audio Test Tone may be set using this control.

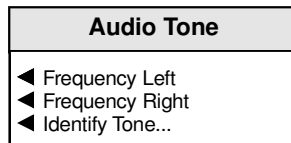

Left and right channels may be set independently.

Frequency Left and Right

This sets the frequency of the test tone.

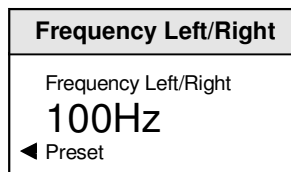

The range is from 100 Hz to 15 kHz in steps of 100 Hz. Preset is to 100 Hz.

Identify Tone

This allows the left or right channel to be identified by a special tone.

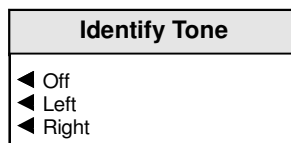

When the left or right channel is selected it will be identified by the signal being muted for 0.5 second every 2.5 seconds.

Audio Monitoring

The four audio buses are monitored and level detectors provide status information and logging data.

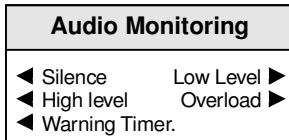

Silence

The level at which the signal is considered to have dropped to silence may be set with this control.

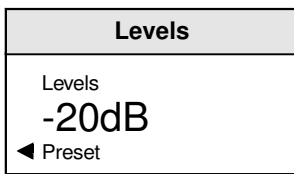

The range is from -80 dB to 0 dB in steps of 1 dB. Preset is to -70 dB.

Low Level

The level at which the signal is considered to have dropped to a Low Level may be set with this control.

The range is from -80 dB to 0 dB in steps of 1 dB. Preset is to -60 dB.

High Level

The level at which the signal is considered to have risen to a High Level may be set with this control.

The range is from -80 dB to 0 dB in steps of 1 dB. Preset is to -10 dB.

Overload

The level at which the signal is considered to have risen to an Overload condition may be set with this control.

The range is from -80 dB to 0 dB in steps of 1 dB. Preset is to 0 dB.

Warning Timer

All the above monitoring facilities will only operate after a time interval set by this control. A valid signal is reported immediately.



The range is from 1 to 20 seconds. Preset is to 10 seconds.

Channel Status

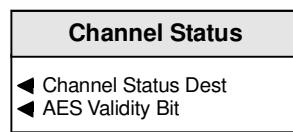

This allows the Channel Status Destination name to be displayed and the AES validity bit set.

Channel Status Dest(ination)

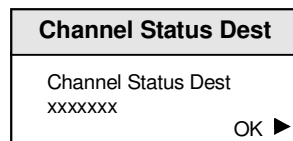

This will display the four character name used in the destination field of the audio channel status.

AES Validity Bit

When selected the AES validity Bit will be set; when deselected it will be cleared.

Calibrate Audio

When selected the audio ADC's will be re-calibrated for 0 dBfs.

Cal on Video IP Sel

When selected the audio ADC's will be re-calibrated for 0 dBfs whenever a different video input is selected.

It is recommended that this function is left unselected as it may disturb the audio output signal.

Genlock...

This allows the genlock and delay options to be selected.

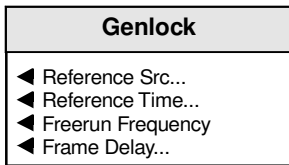

Reference Src (Source)

This allows the source of genlocking signal to be selected.

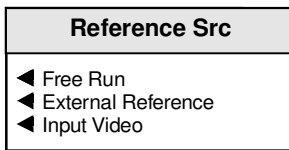

Free Run

When selected the unit will not be locked to any input signals and the unit will free run.

External Reference

When selected and the unit will lock to the external reference signal.

Input Video

When selected and the unit will lock to the input video signal.

Note that this selection is not available when the Decoder is set to the VHS/Unstable mode.

Reference Time(ing)

This item allows the timing of the output signal relative to the reference signal to be adjusted.

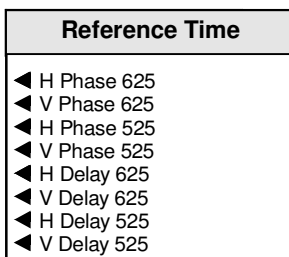

H(Horizontal) Phase 625/525

This item allows the horizontal timing of the output signal relative to the reference sync signal to be adjusted.

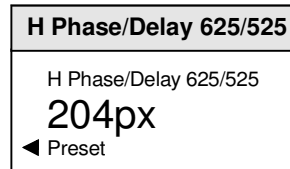

By using the spinwheel the phase may be adjusted by $\pm \frac{1}{2}$ line in 1 pixel steps.

Note that picture disturbance may occur while this setting is adjusted.

Selecting Preset returns the setting to zero. (Output coincident with reference)

V(Vertical) Phase 625/525

This item allows the vertical timing of the output signal relative to the reference sync signal to be adjusted, in TV lines.

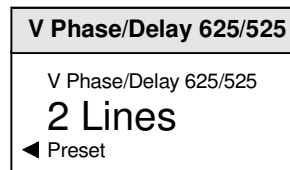

The spinwheel will adjust this value. Range is ± 262 lines (525 standard) or ± 312 lines (625 standard) in 1 line steps.

Note that picture disturbance may occur while this setting is adjusted.

Selecting Preset returns the setting to zero. (Output coincident with reference)

Freerun Frequency

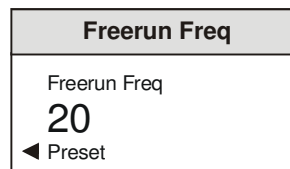

This allows the freerun frequency of the internal sync generator to be adjusted in steps of arbitrary units. Preset is to 0.

H and V Delay 525/625

When these controls are used the output signal will appear after the input signal with a time delay. When not used the module will operate in the synchronize mode.

*Note that the delay functions are only active when the **Lock to Input** mode is selected.*

H Delay 525/625

This item allows the horizontal timing of the output signal relative to the input signal to be adjusted.

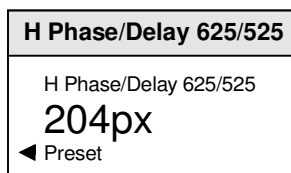

By using the spinwheel the delay may be adjusted by 1 line in 1 pixel steps.

Selecting Preset returns the setting to the minimum horizontal delay.

V(Vertical) Delay 625/525

This item allows the vertical timing of the output signal relative to the input signal to be adjusted, in TV lines.

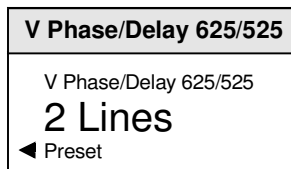

The spinwheel will adjust this value. Range is ± 262 lines (525 standard) or ± 312 lines (625 standard) in 1 line steps.

Selecting Preset returns the setting to the minimum vertical delay.

Frame Delay

0, 1, 2 Frame Delay

The number of frames that the output signal will appear after the input signal may be set with these items.

Note that this function is available in any genlock mode and will add to any other delay settings.

Setup...

This allows various functions to be setup.

Setup
◀ Pattern...
◀ Caption...
◀ VBI & HANC Blank...
◀ GPI I/O...
◀ RollTrack...
◀ Logging...
◀ Default Output..
◀ Information Window...
◀ Software Version
◀ Serial Number
◀ Build Number
◀ FPGA Sync Version
◀ FPGA Dec Version
◀ Error Seconds Reset
◀ Factory Default

Pattern

This function will allow various patterns to be used as the output signal.

Pattern
◀ Pattern Type
◀ Pattern Enable
◀ Animated Pattern

Pattern Type

This allows a pattern to be chosen as the output signal when **Pattern Enable** is selected.

Pattern Type
◀ Black
◀ EBU Color Bars
◀ 100% Color Bars
◀ Ramp
◀ Multi-burst
◀ Pulse & Bar

One of the patterns (including Black) may be selected from the list.

Pattern Enable

When selected the output will become the pattern selected from the **Pattern Type** list.

Animated Pattern

When selected, a monochrome rectangular area will appear on the output picture as shown opposite. The brightness of this rectangle will ramp from black, through gray to white and then directly to black over a period of about one second. This action will then be repeated continuously.

This pattern is useful for checking active video paths. Down stream equipment can see that video has not been frozen.



Animated Pattern

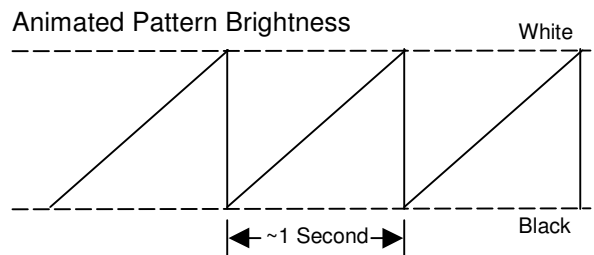

Caption

This function allows control of the caption which may contain a maximum of 19 characters (white text on a black background).

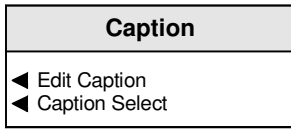

The caption will appear in the lower section of the picture.

Edit Caption

This allows a caption to be edited.

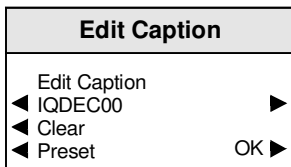

To compile/edit the text the right ▶ and left buttons adjacent to the upper text line in the menu should be used to select the character position in the text and the spinwheel used to select the character.

The **Clear** function blanks the selected character.

The **Preset** function loads the default text, for example, **IQDEC03**.

O.K. ▶ saves the memory name text and returns to the main menu.

Caption Select

This allows the caption to be turned on and off.

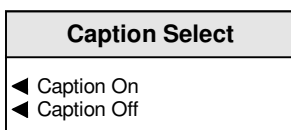

Caption On

When selected the caption will be turned on.

Caption Off

When selected the caption will be turned off.



Caption Text

VBI & HANC Blank(ing)

This menu allows the selection of Vertical Interval lines contained in the input signal to be blanked or passed through the module as data or as a VITS.

Specific lines may be blanked, passed through as data, VITS, passed through as a picture or closed captions by selecting the appropriate line.

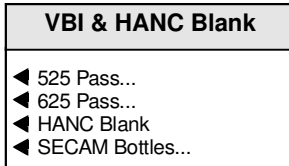

525 Pass

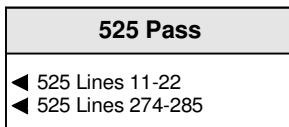

This item allows the selection of 525 standard Vertical Interval lines contained in the input signal to be blanked or passed through the module as data or as a VITS.

Specific lines may be blanked, passed through as data, passed through as a picture (video) or closed captions.

525 Lines 11-22

This allows the selection of lines in field 1.

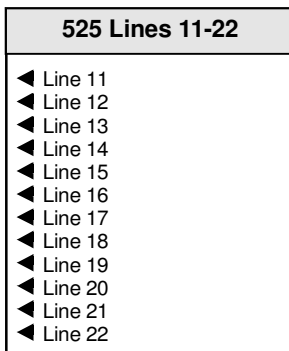

Lines 11-20

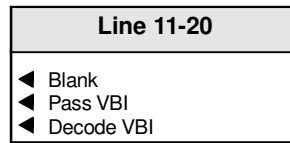

The options for these lines are:

- Blank Line content is blanked by synchronizer
- Pass as data Line is processed by decoder as data, chroma is blanked, Closed Caption disabled.
- Pass as VITS Line is decoded and chroma passed

Line 21

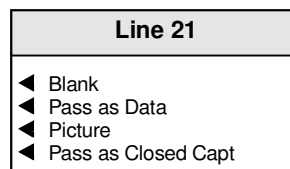

The options for this line are:

- Blank Line content is blanked by synchronizer
- Pass as data Line is processed by decoder as data, chroma is blanked, Closed Caption disabled.
- Picture Line is processed by the decoder as video
- Pass as Closed Caption Line is processed by decoder as data, chroma is blanked, Closed Caption enabled

Line 22

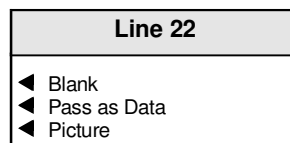

The options for this line is:

- Blank Line content is blanked by synchronizer
- Pass as data Line is processed by decoder as data, chroma is blanked, Closed Caption disabled.
- Picture Line is processed by the decoder as video

525 Lines 274-285

This allows the selection of lines in field 2.

525 Lines 274-285
◀ Line 274
◀ Line 275
◀ Line 276
◀ Line 277
◀ Line 278
◀ Line 279
◀ Line 280
◀ Line 281
◀ Line 282
◀ Line 283
◀ Line 284
◀ Line 285

Line 274-282

Line 274-282
◀ Blank
◀ Pass VBI
◀ Decode VBI

The options for these lines are:

- Blank Line content is blanked by synchronizer
- Pass as VITS Line is decoded and chroma passed
- Picture Line is processed by the decoder as video

Line 284

Line 284
◀ Blank
◀ Pass as Data
◀ Picture
◀ Pass as Closed Capt

The options for these lines are:

- Blank Line content is blanked by synchronizer
- Pass as data Line is processed by decoder as data, chroma is blanked, Closed Caption disabled.
- Picture Line is processed by the decoder as video
- Pass as Closed Caption Line is processed by decoder as data, chroma is blanked, Closed Caption enabled

Line 283 & 285

Line 283 & 285
◀ Blank
◀ Pass as Data
◀ Picture

The options for this line are:

- Blank Line content is blanked by synchronizer
- Pass as data Line is processed by decoder as data, chroma is blanked, Closed Caption disabled.
- Picture Line is processed by the decoder as video

625 Pass

625 Pass
◀ 625 Lines 7-23
◀ 625 Lines 320-335

This item allows the selection of 625 standard Vertical Interval lines contained in the input signal to be blanked or passed through the module as data or as a VITS.

Specific lines may be blanked, passed through as data, passed through as a picture (video) or closed captions.

625 Lines 7-23

This allows the selection of lines in field 1.

625 Lines 7-23
◀ Line 7...
◀ Line 8...
◀ Line 9...
◀ Line 10...
◀ Line 11...
◀ Line 12...
◀ Line 13...
◀ Line 14...
◀ Line 15...
◀ Line 16...
◀ Line 17...
◀ Line 18...
◀ Line 19...
◀ Line 20...
◀ Line 21...
◀ Line 22...
◀ Line 23...

Lines 7-22

Line 7-22
<ul style="list-style-type: none"> ◀ Blank ◀ Pass VBI ◀ Decode VBI

The options for these lines are:

Blank	Line content is blanked by synchronizer
Pass VBI	Line is decoded and chroma
Decode VBI	The line is decoded and processed by the ProcAmp

Lines 320-335

Line 320-335
<ul style="list-style-type: none"> ◀ Blank ◀ Pass VBI ◀ Decode VBI

The options for these lines are:

Blank	Line content is blanked by synchronizer
Pass VBI	Line is decoded and chroma
Decode VBI	The line is decoded and processed by the ProcAmp

Line 23

Line 23
<ul style="list-style-type: none"> ◀ Blank ◀ WSS ◀ Picture

The options for this line are:

Blank	Line content is blanked by synchronizer
WSS	1st half of line is processed as data, chroma blanked, 2nd half of line is processed as video
Picture	1st half of line is blanked by decoder, 2nd half of line is processed as video

625 Lines 320-335

This allows the selection of lines in field 2.

625 Lines 320-335
◀ Line 320...
◀ Line 321...
◀ Line 322...
◀ Line 323...
◀ Line 324...
◀ Line 325...
◀ Line 326...
◀ Line 327...
◀ Line 328...
◀ Line 329...
◀ Line 330...
◀ Line 331...
◀ Line 332...
◀ Line 333...
◀ Line 334...
◀ Line 335...

Hanc Blank

When checked all horizontal data will be blanked on the input.

When unchecked HANC will be passed uncorrupted as long as the Bus audio embedders are disabled. If the synchronizer is synchronizing then frames (including the HANC) might be dropped or repeated.

Note that the HANC Blank control will always be selected if a composite or YC input is selected or if the audio embedders are enabled.

Dolby-E Processing

If embedded Dolby-E audio is present in the SDI input, it will be passed through the module and be present uncorrupted in the SDI output as long as the following conditions have been met:

1. The SDI input is the currently selected input
2. In the **VBI & HANC Blank** menu **HANC Blank** is not selected
3. On the **Audio Outputs** screen (see page 25), both Embedders (1 & 2) are disabled

This means that the Dolby-E stream cannot be extracted from the input and processed (as PCM audio could be) and therefore it cannot be routed to Bus A or Bus B and appear at the AES outputs. This is simply a pass-through function which allows upstream Dolby-E extraction and processing to occur.

SECAM Bottles

This allows the processing of the Bottle lines to be selected.

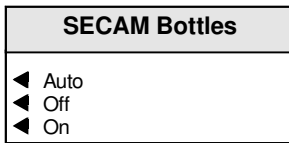

Auto

In this mode Bottles are automatically detected, a Bottle line is passed and will be correctly decoded.

Note that auto Bottle detection is not available in VHS mode.

Off

In this mode Bottle lines will not be detected.

On

In this mode a Bottle line is passed and will be correctly decoded.

GPI I/O

This function allows the GPI functions to be configured and their actions defined.

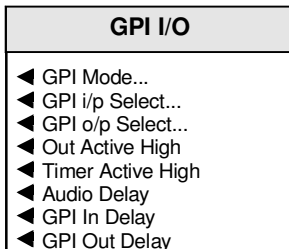

GPI Mode

This allows the GPI port to be configured.

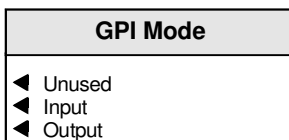

The options are:

- Unused ..The GPI port is disabled
- Input.....The port is configured as an Input
- Output....The port is configured as an Output

GPI i/p Select

When configured as an input the GPI connection may be used for accepting GPI information (from mechanical switch contacts, relay contacts etc.).

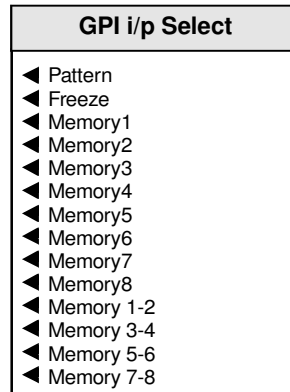

The resulting action that the unit takes may be selected using this item.

The GPI input functions that may be selected are as follows:

- Pattern** The unit will produce a pattern chosen from the Pattern menu when the input changes from open to closed.
- Freeze** The output picture will be frozen frame when the input changes from open to closed.
- Memory 1 to 8** The unit will use the settings in the selected memory location when the input changes from open to closed.
- Memory 1-2** The unit will toggle between the settings of memory locations 1 and 2.
Open to Closed = Memory 1 settings
Closed to Open = Memory 2 settings
- Memory 3-4** The unit will toggle between the settings of memory locations 3 and 4.
Open to Closed = Memory 3 settings
Closed to Open = Memory 4 settings
- Memory 5-6** The unit will toggle between the settings of memory locations 5 and 6.
Open to Closed = Memory 5 settings
Closed to Open = Memory 6 settings
- Memory 7-8** The unit will toggle between the settings of memory locations 7 and 8.
Open to Closed = Memory 7 settings
Closed to Open = Memory 8 settings

GPI o/p Select

This item allows the GPI output functions to be configured.

GPI o/p Select
<input type="checkbox"/> Input Present <input type="checkbox"/> Standard 625 <input type="checkbox"/> Video Delay

The GPO may be configured to produce an output corresponding to one of the conditions highlighted in the list.

When the condition is not true the output will float but when the condition is true the output is closed to ground via a transistor.

Note that when video delay mode is selected the output is a negative going TTL pulse. The width of the pulse represents the video delay through the unit to the nearest millisecond.

Out Active High

When selected (highlighted) the GPI output is active high; when deselected the GPI output is active low.

Note this will also set the polarity of the TTL output signal.

Timer Active High

When checked the **GPI Delay** measurement will respond to a positive going pulse; when unchecked it will respond to a negative going pulse.

Audio Delay

The audio delay may be controlled by the width of a pulse on the GPI input when this item is selected.

*Note that when selected the input functions in the **GPI i/p Select** menu will not be available.*

GPI In Delay

GPI In/Out Delay
GPI In/Out Delay 5.5ms
OK ►

If the GPI port is receiving a pulse input this will show the length of the pulse in milliseconds.

GPI Out Delay

GPI In/Out Delay
GPI In/Out Delay 5.5ms
OK ►

This will show the current video delay through the unit and hence the width of the GPI output TTL pulse.

RollTrack

This function allows information to be sent, via the RollCall™ network, to other compatible units connected on the same network.

For example, it can enable compatible audio delay units to produce an audio delay dependent on this and other similar units. The audio delay unit will dynamically follow or track the received delay-time information. This allows processed video signals to be timed correctly with audio signals. This automatic tracking system via the RollCall™ network is call **RollTrack**.

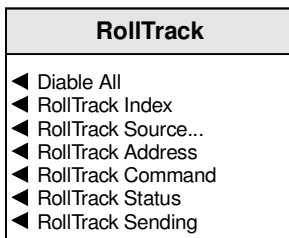

For more detailed information, see the RollTrack section (Appendix) at the end of this manual.

RollTrack Index

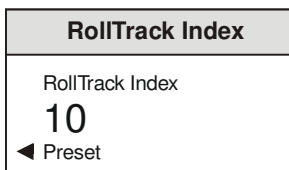

This item is used to select which RollTrack Index is set up using the RollTrack Source, RollTrack Address and RollTrack Command functions.

RollTrack Source



This allows the source of information that triggers the transmission of data to be selected. Options are:

Unused	De-embed 2 Present
Input Present	De-embed 3 Lost
Input Missing	De-embed 3 Present
Standard 525	De-embed 4 Lost
Standard 625	De-embed 4 Present
Audio Delay	De-embed 5 Lost
Video Delay	De-embed 5 Present
Ref. Lost	De-embed 6 Lost
Ref. Present	De-embed 6 Present
Ref. Error	De-embed 7 Lost
De-embed 1 Lost	De-embed 7 Present
De-embed 1 Present	De-embed 8 Lost
De-embed 2 Lost	De-embed 8 Present

The destination for the information is set by the network code address.

RollTrack Disable

When this item is selected all RollTrack items will be disabled.

RollTrack Address

This item allows the address of the selected destination unit to be set.

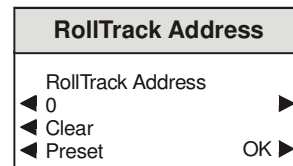

To compile/edit the text the right ► and left buttons adjacent to the upper text line in the menu should be used to select the character position in the text and the spinwheel used to select the character.

The **Clear** function blanks the selected character.

The **Preset** function loads the default address.

O.K. ► saves the address and returns to the main menu.

The full **RollTrack** address has four sets of numbers

For example: 0000:10:01*99

The first set (0000) is the network segment code number

The second set (10) is the number identifying the (enclosure/mainframe) unit.

The third set (01) is the slot number in the unit

The fourth set (99) is a user settable number that is a unique identification number for the destination unit in a multi-unit system. This ensures that only the correct unit will respond to the command. If left at 00 an incorrectly fitted unit may respond inappropriately.

RollTrack Command

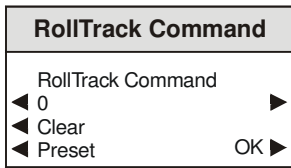

The full **RollTrack** command has two sets of numbers

For example: 84*156

The first set (84) is the **RollTrack** command number

Note that only command numbers 14, 15, 16 and 17 should be used for audio delay

The second set (156) is the value sent with the **RollTrack** command number.

*Note that when video delay or audio delay is selected as the **RollTrack** source the value sent with the **RollTrack** command is the video delay value not the value set.*

For details of the RollCall command values for specific units please contact your local Snell & Wilcox agent.

RollTrack Sending

This item shows when the unit is actively sending the RollTrack command.

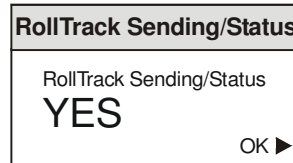

This may show:

- String A string value is always being sent.
- Number A number value is always being sent.
- No The message is not being sent.
- Yes The message is being sent.
- Internal Inconsistent behavior; please contact
Type Error your local Snell & Wilcox agent.

RollTrack Status

This item will show the status of the currently selected RollTrack index.

This may show:

- OK RollTrack message sent and received OK.
- Unknown Rolltrack message has been sent but it has not yet completed.
- Timeout RollTrack message sent but acknowledgement not received. This could be because the destination unit is not at the location specified.
- Error This indicates a broken RollCall state.
- Bad This indicates a broken RollCall packet.

Logging

Information about various parameters can be made available to a logging device that is attached to the RollCall™ network by selecting the appropriate item.

Logging
◀ Input
◀ Std
◀ Reference
◀ EDH
◀ EDH Err
◀ RollTrack
◀ De-emb 1
◀ De-emb 2
◀ De-emb 3
◀ De-emb 4
◀ De-emb 5
◀ De-emb 6
◀ De-emb 7
◀ De-emb 8
◀ nPCM 1
◀ nPCM 2
◀ nPCM 3
◀ nPCM 4
◀ nPCM 5
◀ nPCM 6
◀ nPCM 7
◀ nPCM 8
◀ ANALOG 1L
◀ ANALOG 1R
◀ ANALOG 2L
◀ ANALOG 2R
◀ BUS AL
◀ BUS AR
◀ BUS BL
◀ BUS BR

Any of the items may be selected from the list.

ROLLCALL LOG FIELDS

(where applicable)

Log Field	Log Value	Description
INPUT=	OK ERR LOST	Valid input signal Invalid input signal Input signal lost
STD=	UNKNOWN STDERR 525 625 PAL NTSC NTSC_J PAL_M PAL_N SECAM N443_60 PAL443_60 ERROR: 525 ERROR: 625 ERROR: PAL ERROR: NTSC ERROR: NTSC_J ERROR: PAL_M ERROR: PAL_N ERROR: SECAM ERROR: N443_60 ERROR: PAL443_60	Input signal standard not recognized or no signal Not a selected input standard SDI input standard 525 SDI input standard 625 PAL composite input NTSC composite input NTSC J composite input PAL M composite input PAL N composite input SECAM composite input N4.43 60 composite input PAL4.43 60 composite input SDI input standard 525, 525 standard not valid SDI input standard 625, 625 standard not valid Composite input standard invalid, decoding as PAL Composite input standard invalid, decoding as NTSC Composite input standard invalid, decoding as NTSC J Composite input standard invalid, decoding as PAL M Composite input standard invalid, decoding as PAL N Composite input standard invalid, decoding as SECAM Composite input standard invalid, decoding as N4.43 60 Composite input standard invalid, decoding as PAL4.43 60
EXTREF=	525 625 ERROR: 525 ERROR: 625 WARNING: LOSS WARNING:525_N/A WARNING:625_N/A NONE	525 reference, input 525 or lost 625 reference, input 625 or lost 525 reference, input 625, trying to lock to reference 625 reference, input 525, trying to lock to reference Reference lost, trying to lock to reference 525 reference, input 625, not trying to lock to reference 625 reference, input 525, not trying to lock to reference Reference lost, not trying to lock to reference
EDH=	NONE FAIL OK RESET	The unit is not locked to the input signal EDH errors have been found on the input signal No EDH errors found on the input signal EDH statistics have been reset
ERRSEC=	Runtime string	The time since EDH was reset in seconds
ROL_STATES=	OK FAIL	RollTrack message sent and received OK RollTrack message not acknowledged
DEEMBED_1=	NONE OK	Nothing present on pair 1 Embedded pair 1 present on selected SDI input
DEEMBED_2=	NONE OK	Nothing present on pair 2 Embedded pair 2 present on selected SDI input
DEEMBED_3=	NONE OK	Nothing present on pair 3 Embedded pair 3 present on selected SDI input
DEEMBED_4=	NONE OK	Nothing present on pair 4 Embedded pair 4 present on selected SDI input
DEEMBED_5=	NONE OK	Nothing present on pair 5 Embedded pair 5 present on selected SDI input
DEEMBED_6=	NONE OK	Nothing present on pair 6 Embedded pair 6 present on selected SDI input
DEEMBED_7=	NONE OK	Nothing present on pair 7 Embedded pair 7 present on selected SDI input

Log Field	Log Value	Description
DEEMBED_8=	NONE OK	Nothing present on pair 8 Embedded pair 8 present on selected SDI input
NPCM_1=	NONE OK	Non-PCM not present on pair 1 of selected SDI input Non-PCM present on pair 1 of selected SDI input
NPCM_2=	NONE OK	Non-PCM not present on pair 2 of selected SDI input Non-PCM present on pair 2 of selected SDI input
NPCM_3=	NONE OK	Non-PCM not present on pair 3 of selected SDI input Non-PCM present on pair 3 of selected SDI input
NPCM_4=	NONE OK	Non-PCM not present on pair 4 of selected SDI input Non-PCM present on pair 4 of selected SDI input
NPCM_5=	NONE OK	Non-PCM not present on pair 5 of selected SDI input Non-PCM present on pair 5 of selected SDI input
NPCM_6=	NONE OK	Non-PCM not present on pair 6 of selected SDI input Non-PCM present on pair 6 of selected SDI input
NPCM_7=	NONE OK	Non-PCM not present on pair 7 of selected SDI input Non-PCM present on pair 7 of selected SDI input
NPCM_8=	NONE OK	Non-PCM not present on pair 8 of selected SDI input Non-PCM present on pair 8 of selected SDI input
ANALOG_1L	OK WARNING: SILENT WARNING: QUIET WARNING: HIGH WARNING: OVERLOAD	Analog Input 1 Left channel has valid signal selected Analog Input 1 Left channel is receiving silence Analog Input 1 Left channel is receiving low level signal Analog Input 1 Left channel is receiving high level signal Analog Input 1 Left channel is receiving overload signal
ANALOG_1R	OK WARNING: SILENT WARNING: QUIET WARNING: HIGH WARNING: OVERLOAD	Analog Input 1 Right channel has valid signal selected Analog Input 1 Right channel is receiving silence Analog Input 1 Right channel is receiving low level signal Analog Input 1 Right channel is receiving high level signal Analog Input 1 Right channel is receiving overload signal
ANALOG_2L	OK WARNING: SILENT WARNING: QUIET WARNING: HIGH WARNING: OVERLOAD	Analog Input 2 Left channel has valid signal selected Analog Input 2 Left channel is receiving silence Analog Input 2 Left channel is receiving low level signal Analog Input 2 Left channel is receiving high level signal Analog Input 2 Left channel is receiving overload signal
ANALOG_2R	OK WARNING: SILENT WARNING: QUIET WARNING: HIGH WARNING: OVERLOAD	Analog Input 2 Right channel has valid signal selected Analog Input 2 Right channel is receiving silence Analog Input 2 Right channel is receiving low level signal Analog Input 2 Right channel is receiving high level signal Analog Input 2 Right channel is receiving overload signal
BUS_AL=	OK WARNING: SILENT WARNING: QUIET WARNING: HIGH WARNING: OVERLOAD	Router BUS A Left channel has valid signal selected Router BUS A Left channel is receiving silence Router BUS A Left channel is receiving low level signal Router BUS A Left channel is receiving high level signal Router BUS A Left channel is receiving overload signal
BUS_AR=	OK WARNING: SILENT WARNING: QUIET WARNING: HIGH WARNING: OVERLOAD	Router BUS A Right channel has valid signal selected Router BUS A Right channel is receiving silence Router BUS A Right channel is receiving low level signal Router BUS A Right channel is receiving high level signal Router BUS A Right channel is receiving overload signal
BUS_BL=	OK WARNING: SILENT WARNING: QUIET WARNING: HIGH WARNING: OVERLOAD	Router BUS B Left channel has valid signal selected Router BUS B Left channel is receiving silence Router BUS B Left channel is receiving low level signal Router BUS B Left channel is receiving high level signal Router BUS B Left channel is receiving overload signal
BUS_BR=	OK WARNING: SILENT WARNING: QUIET WARNING: HIGH WARNING: OVERLOAD	Router BUS B Right channel has valid signal selected Router BUS B Right channel is receiving silence Router BUS B Right channel is receiving low level signal Router BUS B Right channel is receiving high level signal Router BUS B Right channel is receiving overload signal
SN=	Runtime string	Serial number of unit

Default Output

If the input signal fails or is of poor quality this function will determine what the output signal will become under such conditions.

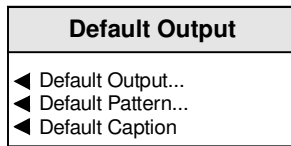

Default Output

This allows the default output mode to be selected.

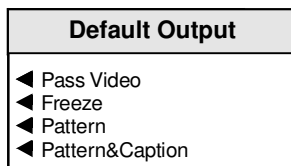

Pass Video The input signal will be passed to the output.

Freeze The output will become a frozen frame picture.

Pattern The output will become the pattern chosen from the **Default Pattern** list.

Pattern and Caption The output will become the pattern chosen from the **Default Pattern** list plus the **Default Caption**.

Default Pattern

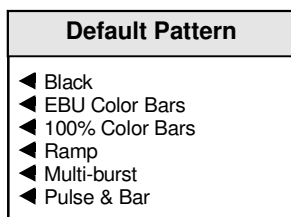

If **Pattern** is chosen in the **Default Output** menu the output will become the pattern chosen from this list.

Default Caption

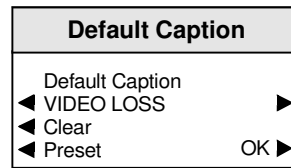

This is the caption that will appear if **Pattern and Caption** is chosen from the **Default Output** menu.

To compile/edit the text the right ▶ and left buttons adjacent to the upper text line in the menu should be used to select the character position in the text and the spinwheel used to select the character.

The **Clear** function blanks the selected character.

The **Preset** function loads the default text, for example, **VIDEO LOSS**.

O.K. ▶ saves the text and returns to the main menu.

Information Window

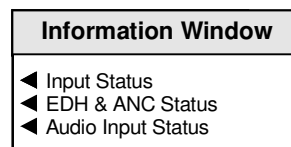

The type of information that appears in the Information Window may be chosen with this item.

Software Version

This item reveals a display showing the version of the software fitted in the module.

Software Version
Software Version x.x.x
OK ►

Select OK to return to the Setup Menu.

Serial No

This item reveals a display showing the serial number of the module.

Serial No
Serial No xxxxxxx
OK ►

Select OK to return to the Setup Menu.

Build No

This will indicate the factory build number. This number defines all parameters of the unit (software versions, build level etc.) for identification purposes.

Build No
Build No xxxxxxx
OK ►

Select OK to return to the Setup Menu.

FPGA Sync Version

This will display the version number of the Synchronizer FPGA fitted to the unit.

FPGA Sync Version
FPGA Sync Version xxxxxxx
OK ►

Select OK to return to the Setup Menu.

FPGA Dec Version

This will display the version number of the Decoder FPGA fitted to the unit.

FPGA Dec Version
FPGA Dec Version xxxxxxx
OK ►

Select OK to return to the Setup Menu.

Error Seconds Reset

Selecting this function will reset the EDH error count and the timer shown in the information window, to zero.

Factory Default

Selecting this item sets all adjustment functions that include a preset facility, to their factory default values.

Note that this is a momentary action.

Restart

This will reboot the unit simulating a power-down power-up cycle restoring power-up settings.

User Mem(ories)

Name 1-8 ►

This function allows a number of particular setups of the IQDEC03 to be saved and recalled. There are 8 memory locations available.

This item allows any of the 8 memory locations to be selected.

User Mem
◀ Memory 1... to ▶ Memory 8...

Memory 1 to 8

Memory 1 to 8
◀ Save 1-8 Recall 1-8 ▶ ◀ Clear 1-8 Name 1-8 ▶

When a memory location has been selected this item allows it to be saved, recalled, cleared or renamed.

Save 1-8

When selected the current settings will be saved at this location.

Recall 1-8 ►

When selected the settings will be recalled from this location and applied to the unit.

Clear 1-8

When selected the memory location will be cleared and returned to the default (preset) setting.

The selected memory location may be renamed with this function.

To compile/edit the text the right ► and left buttons adjacent to the upper text line in the menu should be used to select the character position in the text and the spinwheel used to select the character.

Name Memory 1-8
Name Memory 1-8 ◀ <i>memory_name</i> ▶
◀ Clear
◀ Preset OK ▶

The **Clear** function blanks the selected character.

The **Preset** function loads the default text, for example, **Memory 1**.

O.K. ► saves the memory name text and returns to the main menu.

IQDEC03 RollCall Commands

Supervisor Level

Command No.						Values	
Hex	Dec	Command Name					
000E	14	RollTrack14	min=-2147483648	max=2147483647	Step=1		
000F	15	RollTrack15	min=-2147483648	max=2147483647	Step=1		
0010	16	RollTrack16	min=-2147483648	max=2147483647	Step=1		
0011	17	RollTrack17	min=-2147483648	max=2147483647	Step=1		
03EA	1002	<Select>	0=Composite A	1=Composite B	2=YC		3=SDI
044C	1100	525	clear=0 set=1 (toggle=2)				
044D	1101	625	clear=0 set=1 (toggle=2)				
0578	1400	Left	min=0	max=200	Step=2		
0579	1401	Right	min=0	max=200	Step=2		
057A	1402	Top	min=0	max=200	Step=1		
057B	1403	Bottom	min=0	max=200	Step=1		
057C	1404	Red	min=0	max=255	Step=1		
057D	1405	Green	min=0	max=255	Step=1		
057E	1406	Blue	min=0	max=255	Step=1		
0640	1600	Luma Gain	min=-60	max=60	Step=1		Div=10
0641	1601	Black Level	min=-1200	max=1200	Step=5		Div=10
0642	1602	Chroma Gain	min=-60	max=60	Step=1		Div=10
0643	1603	V Enhance	min=0	max=3	Step=1		
0644	1604	H Enhance	min=0	max=3	Step=1		
0645	1605	<H Enhance Freq>	0=3.375 MHz	1=2.250 MHz			
0646	1606	Picture Position	min=-592	max=592	Step=148		
0647	1607	Y/C Timing	min=-592	max=592	Step=148		
07D0	2000	<Reference Src>	0=Free Run	1=External	Reference		2=Input Video
07D1	2001	H Phase 625	min=0	max=1727	Step=1		
07D2	2002	V Phase 625	min=0	max=624	Step=1		
07D3	2003	H Phase 525	min=0	max=1715	Step=1		
07D4	2004	V Phase 525	min=0	max=524	Step=1		
07D5	2005	H Delay 625	min=0	max=1727	Step=1		
07D6	2006	V Delay 625	min=0	max=624	Step=1		
07D7	2007	H Delay 525	min=0	max=1715	Step=1		
07D8	2008	V Delay 525	min=0	max=524	Step=1		
0838	2104	Freerun Frequency	min=-60	max=60	Step=1		
083A	2106	<Frame Delay>	0=0 Frame Delay	1=1 Frame Delay	2=2 Frame Delay		
0898	2200	HANC Blank	clear=0 set=1 (toggle=2)				
0899	2201	<Line 11>	0=Blank	1=Pass VBI			2=Decode VBI
089A	2202	<Line 12>	0=Blank	1=Pass VBI			2=Decode VBI
089B	2203	<Line 13>	0=Blank	1=Pass VBI			2=Decode VBI
089C	2204	<Line 14>	0=Blank	1=Pass VBI			2=Decode VBI
089D	2205	<Line 15>	0=Blank	1=Pass VBI			2=Decode VBI
089E	2206	<Line 16>	0=Blank	1=Pass VBI			2=Decode VBI
089F	2207	<Line 17>	0=Blank	1=Pass VBI			2=Decode VBI
08A0	2208	<Line 18>	0=Blank	1=Pass VBI			2=Decode VBI
08A1	2209	<Line 19>	0=Blank	1=Pass VBI			2=Decode VBI
08A2	2210	<Line 20>	0=Blank	1=Pass VBI			2=Decode VBI
08A3	2211	<Line 21>	0=Blank	1=Data			2=Picture 3=Closed Captions
08A4	2212	<Line 22>	0=Blank	1=Data			2=Picture
08A5	2213	<Line 274>	0=Blank	1=Pass VBI			2=Decode VBI
08A6	2214	<Line 275>	0=Blank	1=Pass VBI			2=Decode VBI
08A7	2215	<Line 276>	0=Blank	1=Pass VBI			2=Decode VBI
08A8	2216	<Line 277>	0=Blank	1=Pass VBI			2=Decode VBI
08A9	2217	<Line 278>	0=Blank	1=Pass VBI			2=Decode VBI
08AA	2218	<Line 279>	0=Blank	1=Pass VBI			2=Decode VBI
08AB	2219	<Line 280>	0=Blank	1=Pass VBI			2=Decode VBI
08AC	2220	<Line 281>	0=Blank	1=Pass VBI			2=Decode VBI
08AD	2221	<Line 282>	0=Blank	1=Pass VBI			2=Decode VBI
08AE	2222	<Line 283>	0=Blank	1=Data			2=Picture
08AF	2223	<Line 284>	0=Blank	1=Data			2=Picture 3=Closed Captions
08B0	2224	<Line 285>	0=Blank	1=Data			2=Picture
08B6	2230	<Line 7>	0=Blank	1=Pass VBI			2=Decode VBI
08B7	2231	<Line 8>	0=Blank	1=Pass VBI			2=Decode VBI
08B8	2232	<Line 9>	0=Blank	1=Pass VBI			2=Decode VBI
08B9	2233	<Line 10>	0=Blank	1=Pass VBI			2=Decode VBI
08BA	2234	<Line 11>	0=Blank	1=Pass VBI			2=Decode VBI
08BB	2235	<Line 12>	0=Blank	1=Pass VBI			2=Decode VBI
08BC	2236	<Line 13>	0=Blank	1=Pass VBI			2=Decode VBI
08BD	2237	<Line 14>	0=Blank	1=Pass VBI			2=Decode VBI
08BE	2238	<Line 15>	0=Blank	1=Pass VBI			2=Decode VBI
08BF	2239	<Line 16>	0=Blank	1=Pass VBI			2=Decode VBI
08C0	2240	<Line 17>	0=Blank	1=Pass VBI			2=Decode VBI
08C1	2241	<Line 18>	0=Blank	1=Pass VBI			2=Decode VBI
08C2	2242	<Line 19>	0=Blank	1=Pass VBI			2=Decode VBI
08C3	2243	<Line 20>	0=Blank	1=Pass VBI			2=Decode VBI
08C4	2244	<Line 21>	0=Blank	1=Pass VBI			2=Decode VBI
08C5	2245	<Line 22>	0=Blank	1=Pass VBI			2=Decode VBI
08C6	2246	<Line 23>	0=Blank	1=WSS			2=Picture
08C7	2247	<Line 320>	0=Blank	1=Pass VBI			2=Decode VBI
08C8	2248	<Line 321>	0=Blank	1=Pass VBI			2=Decode VBI
08C9	2249	<Line 322>	0=Blank	1=Pass VBI			2=Decode VBI
08CA	2250	<Line 323>	0=Blank	1=Pass VBI			2=Decode VBI
08CB	2251	<Line 324>	0=Blank	1=Pass VBI			2=Decode VBI
08CC	2252	<Line 325>	0=Blank	1=Pass VBI			2=Decode VBI
08CD	2253	<Line 326>	0=Blank	1=Pass VBI			2=Decode VBI
08CE	2254	<Line 327>	0=Blank	1=Pass VBI			2=Decode VBI
08CF	2255	<Line 328>	0=Blank	1=Pass VBI			2=Decode VBI
08D0	2256	<Line 329>	0=Blank	1=Pass VBI			2=Decode VBI
08D1	2257	<Line 330>	0=Blank	1=Pass VBI			2=Decode VBI
08D2	2258	<Line 331>	0=Blank	1=Pass VBI			2=Decode VBI
08D3	2259	<Line 332>	0=Blank	1=Pass VBI			2=Decode VBI
08D4	2260	<Line 333>	0=Blank	1=Pass VBI			2=Decode VBI
08D5	2261	<Line 334>	0=Blank	1=Pass VBI			2=Decode VBI
08D6	2262	<Line 335>	0=Blank	1=Pass VBI			2=Decode VBI
08DB	2267	<SECAM Bottles>	0=Auto	1=Off			2=On
0960	2400	Freeze	clear=0 set=1 (toggle=2)				
0961	2401	<Pattern Type>	0=Black	1=EBU Color Bars	2=100% Color Bars		3=Ramp
			4=Multi-Burst	5=Pulse & Bar			

0962	2402	Pattern Enable	clear=0 set=1 (toggle=2)	
0B54	2900	Caption Select	clear=0 set=1 (toggle=2)	
0B55	2901	Edit Caption	Edit String	
0BB8	3000	RollTrack Index	min=1 max=16 Step=1	
0BB9	3001	<RollTrack Source>	-1=Unused 0=Input Present 1=Input Missing 2=Standard 525 3=Standard 625 4=Audio Delay 5=Video Delay 6=Ref. Lost 7=Ref. Present 8=Ref. Error 9=De-embed 1 Lost 10=De-embed 1 Present 11=De-embed 2 Lost 12=De-embed 2 Present 13=De-embed 3 Lost 14=De-embed 3 Present 15=De-embed 4 Lost 16=De-embed 4 Present 17=De-embed 5 Lost 18=De-embed 5 Present 19=De-embed 6 Lost 20=De-embed 6 Present 21=De-embed 7 Lost 22=De-embed 7 Present 23=De-embed 8 Lost 24=De-embed 8 Present	
0BBA	3002	RollTrack Address	Edit String	
0BBB	3003	RollTrack Command	Edit String	
0BBC	3004	Disable All	clear=0 set=1 (toggle=2)	
0BBD	3005	RollTrack Status	Static Display (no control)	
0BBE	3006	RollTrack Sending	Static Display (no control)	
0C80	3200	<GPI Mode>	0=Unused 1=Input 2=Output	
0C82	3202	<GPI i/p Select>	0=Pattern 1=Freeze 2=Memory1 3=Memory2 4=Memory3 5=Memory4 6=Memory5 7=Memory6 8=Memory7 9=Memory8 10=Memory 1-2 11=Memory 3-4 12=Memory 5-6 13=Memory 7-8	
0C84	3204	<GPI o/p Select>	0=Input Present 1=Standard 625 2=Video Delay	
0C85	3205	GPI Out Delay	Static Display (no control)	
0C86	3206	Out Active High	clear=0 set=1 (toggle=2)	
0C87	3207	Timer Active High	clear=0 set=1 (toggle=2)	
0C88	3208	GPI In Delay	Static Display (no control)	
0C89	3209	Audio Delay	clear=0 set=1 (toggle=2)	
0FA0	4000	L-Gain	min=-180 max=180 Step=1	Div=10
0FA1	4001	Gain-R	min=-180 max=180 Step=1	Div=10
0FA2	4002	L-Invert	clear=0 set=1 (toggle=2)	
0FA3	4003	Invert-R	clear=0 set=1 (toggle=2)	
0FA4	4004	L-Mute	clear=0 set=1 (toggle=2)	
0FA5	4005	Mute-R	clear=0 set=1 (toggle=2)	
0FA6	4006	Stereo	clear=0 set=1 (toggle=2)	
0FA7	4007	Delay	min=0 max=1500 Step=1	
0FAA	4010	L-Gain	min=-180 max=180 Step=1	Div=10
0FAB	4011	Gain-R	min=-180 max=180 Step=1	Div=10
0FAC	4012	L-Invert	clear=0 set=1 (toggle=2)	
0FAD	4013	Invert-R	clear=0 set=1 (toggle=2)	
0FAE	4014	L-Mute	clear=0 set=1 (toggle=2)	
0FAF	4015	Mute-R	clear=0 set=1 (toggle=2)	
0FB0	4016	Stereo	clear=0 set=1 (toggle=2)	
0FB1	4017	Delay	min=0 max=1500 Step=1	
0FB4	4020	L-Gain	min=-180 max=180 Step=1	Div=10
0FB5	4021	Gain-R	min=-180 max=180 Step=1	Div=10
0FB6	4022	L-Invert	clear=0 set=1 (toggle=2)	
0FB7	4023	Invert-R	clear=0 set=1 (toggle=2)	
0FB8	4024	L-Mute	clear=0 set=1 (toggle=2)	
0FB9	4025	Mute-R	clear=0 set=1 (toggle=2)	
0FBA	4026	Stereo	clear=0 set=1 (toggle=2)	
0FBB	4027	Delay	min=0 max=1500 Step=1	
0FBE	4030	L-Gain	min=-180 max=180 Step=1	Div=10
0FBF	4031	Gain-R	min=-180 max=180 Step=1	Div=10
0FC0	4032	L-Invert	clear=0 set=1 (toggle=2)	
0FC1	4033	Invert-R	clear=0 set=1 (toggle=2)	
0FC2	4034	L-Mute	clear=0 set=1 (toggle=2)	
0FC3	4035	Mute-R	clear=0 set=1 (toggle=2)	
0FC4	4036	Stereo	clear=0 set=1 (toggle=2)	
0FC5	4037	Delay	min=0 max=1500 Step=1	
0FC8	4040	L-Gain	min=-180 max=180 Step=1	Div=10
0FC9	4041	Gain-R	min=-180 max=180 Step=1	Div=10
0FCA	4042	L-Invert	clear=0 set=1 (toggle=2)	
0FCB	4043	Invert-R	clear=0 set=1 (toggle=2)	
0FCC	4044	L-Mute	clear=0 set=1 (toggle=2)	
0FCD	4045	Mute-R	clear=0 set=1 (toggle=2)	
0FCE	4046	Stereo	clear=0 set=1 (toggle=2)	
0FCF	4047	Delay	min=0 max=1500 Step=1	
0FD2	4050	L-Gain	min=-180 max=180 Step=1	Div=10
0FD3	4051	Gain-R	min=-180 max=180 Step=1	Div=10
0FD4	4052	L-Invert	clear=0 set=1 (toggle=2)	
0FD5	4053	Invert-R	clear=0 set=1 (toggle=2)	
0FD6	4054	L-Mute	clear=0 set=1 (toggle=2)	
0FD7	4055	Mute-R	clear=0 set=1 (toggle=2)	
0FD8	4056	Stereo	clear=0 set=1 (toggle=2)	
0FD9	4057	Delay	min=0 max=1500 Step=1	
0FDC	4060	L-Gain	min=-180 max=180 Step=1	Div=10
0FDD	4061	Gain-R	min=-180 max=180 Step=1	Div=10
0FDE	4062	L-Invert	clear=0 set=1 (toggle=2)	
0FDF	4063	Invert-R	clear=0 set=1 (toggle=2)	
0FE0	4064	L-Mute	clear=0 set=1 (toggle=2)	
0FE1	4065	Mute-R	clear=0 set=1 (toggle=2)	
0FE2	4066	Stereo	clear=0 set=1 (toggle=2)	
0FE3	4067	Delay	min=0 max=1500 Step=1	
0FE6	4070	L-Gain	min=-180 max=180 Step=1	Div=10
0FE7	4071	Gain-R	min=-180 max=180 Step=1	Div=10
0FE8	4072	L-Invert	clear=0 set=1 (toggle=2)	
0FE9	4073	Invert-R	clear=0 set=1 (toggle=2)	
0FEA	4074	L-Mute	clear=0 set=1 (toggle=2)	
0FEB	4075	Mute-R	clear=0 set=1 (toggle=2)	
0FEC	4076	Stereo	clear=0 set=1 (toggle=2)	
0FED	4077	Delay	min=0 max=1500 Step=1	
1004	4100	L-Gain	min=-68 max=68 Step=1	Div=2
1005	4101	Gain-R	min=-68 max=68 Step=1	Div=2
1006	4102	L-Invert	clear=0 set=1 (toggle=2)	
1007	4103	Invert-R	clear=0 set=1 (toggle=2)	
1008	4104	L-Mute	clear=0 set=1 (toggle=2)	
1009	4105	Mute-R	clear=0 set=1 (toggle=2)	
100A	4106	Stereo	clear=0 set=1 (toggle=2)	
100B	4107	Delay	min=0 max=1500 Step=1	
100E	4110	L-Gain	min=-68 max=68 Step=1	Div=2
100F	4111	Gain-R	min=-68 max=68 Step=1	Div=2
1010	4112	L-Invert	clear=0 set=1 (toggle=2)	
1011	4113	Invert-R	clear=0 set=1 (toggle=2)	
1012	4114	L-Mute	clear=0 set=1 (toggle=2)	
1013	4115	Mute-R	clear=0 set=1 (toggle=2)	

1014	4116	Stereo	clear=0 set=1 (toggle=2)
1015	4117	Delay	min=0 max=1500 Step=1
1022	4130	Headroom	min=8 max=48 Step=1 Div=2
1023	4131	Line Up	min=-48 max=20 Step=1 Div=2
1068	4200	<L-Src >	0=Analog 1L 1=Analog 1R 2=Analog 2L 3=Analog 2R 4=SDI DeEmbed 1L 5=SDI DeEmbed 1R 6=SDI DeEmbed 2L 7=SDI DeEmbed 2R 8=SDI DeEmbed 3L 9=SDI DeEmbed 3R 10=SDI DeEmbed 4L 11=SDI DeEmbed 4R 12=SDI DeEmbed 5L 13=SDI DeEmbed 5R 14=SDI DeEmbed 6L 15=SDI DeEmbed 6R 16=SDI DeEmbed 7L 17=SDI DeEmbed 7R 18=SDI DeEmbed 8L 19=SDI DeEmbed 8R 20=Tone L 21=Tone R 22=Mixer 1 23=Mixer 2 24=Mixer 3 25=Mixer 4
1069	4201	<Src-R>	0=Analog 1L 1=Analog 1R 2=Analog 2L 3=Analog 2R 4=SDI DeEmbed 1L 5=SDI DeEmbed 1R 6=SDI DeEmbed 2L 7=SDI DeEmbed 2R 8=SDI DeEmbed 3L 9=SDI DeEmbed 3R 10=SDI DeEmbed 4L 11=SDI DeEmbed 4R 12=SDI DeEmbed 5L 13=SDI DeEmbed 5R 14=SDI DeEmbed 6L 15=SDI DeEmbed 6R 16=SDI DeEmbed 7L 17=SDI DeEmbed 7R 18=SDI DeEmbed 8L 19=SDI DeEmbed 8R 20=Tone L 21=Tone R 22=Mixer 1 23=Mixer 2 24=Mixer 3 25=Mixer 4
106A	4202	L-Gain	min=-180 max=180 Step=1 Div=10
106B	4203	Gain-R	min=-180 max=180 Step=1 Div=10
106C	4204	L-Invert	clear=0 set=1 (toggle=2)
106D	4205	Invert-R	clear=0 set=1 (toggle=2)
106E	4206	L-Mute	clear=0 set=1 (toggle=2)
106F	4207	Mute-R	clear=0 set=1 (toggle=2)
1070	4208	Stereo	clear=0 set=1 (toggle=2)
1071	4209	<L-Src>	0=Analog 1L 1=Analog 1R 2=Analog 2L 3=Analog 2R 4=SDI DeEmbed 1L 5=SDI DeEmbed 1R 6=SDI DeEmbed 2L 7=SDI DeEmbed 2R 8=SDI DeEmbed 3L 9=SDI DeEmbed 3R 10=SDI DeEmbed 4L 11=SDI DeEmbed 4R 12=SDI DeEmbed 5L 13=SDI DeEmbed 5R 14=SDI DeEmbed 6L 15=SDI DeEmbed 6R 16=SDI DeEmbed 7L 17=SDI DeEmbed 7R 18=SDI DeEmbed 8L 19=SDI DeEmbed 8R 20=Tone L 21=Tone R 22=Mixer 1 23=Mixer 2 24=Mixer 3 25=Mixer 4
1072	4210	<Src-R>	0=Analog 1L 1=Analog 1R 2=Analog 2L 3=Analog 2R 4=SDI DeEmbed 1L 5=SDI DeEmbed 1R 6=SDI DeEmbed 2L 7=SDI DeEmbed 2R 8=SDI DeEmbed 3L 9=SDI DeEmbed 3R 10=SDI DeEmbed 4L 11=SDI DeEmbed 4R 12=SDI DeEmbed 5L 13=SDI DeEmbed 5R 14=SDI DeEmbed 6L 15=SDI DeEmbed 6R 16=SDI DeEmbed 7L 17=SDI DeEmbed 7R 18=SDI DeEmbed 8L 19=SDI DeEmbed 8R 20=Tone L 21=Tone R 22=Mixer 1 23=Mixer 2 24=Mixer 3 25=Mixer 4
1073	4211	L-Gain	min=-180 max=180 Step=1 Div=10
1074	4212	Gain-R	min=-180 max=180 Step=1 Div=10
1075	4213	L-Invert	clear=0 set=1 (toggle=2)
1076	4214	Invert-R	clear=0 set=1 (toggle=2)
1077	4215	L-Mute	clear=0 set=1 (toggle=2)
1078	4216	Mute-R	clear=0 set=1 (toggle=2)
1079	4217	Stereo	clear=0 set=1 (toggle=2)
10CD	4301	<Source>	0=BUS A 1=BUS B
10CE	4302	<Destination>	0=Pair 1 1=Pair 2 2=Pair 3 3=Pair 4 4=Pair 5 5=Pair 6 6=Pair 7 7=Pair 8
10CF	4303	Disable	clear=0 set=1 (toggle=2)
10D0	4304	<Source>	0=BUS A 1=BUS B
10D1	4305	<Destination>	0=Pair 1 1=Pair 2 2=Pair 3 3=Pair 4 4=Pair 5 5=Pair 6 6=Pair 7 7=Pair 8
10D2	4306	Disable	clear=0 set=1 (toggle=2)
10D3	4307	<Source>	0=BUS A 1=BUS B
10D5	4309	<Source>	0=BUS A 1=BUS B
1130	4400	Set Manual	min=-40 max=1500 Step=1
1131	4401	Include Internal	clear=0 set=1 (toggle=2)
1132	4402	Include Manual	clear=0 set=1 (toggle=2)
1133	4403	Include GPI	clear=0 set=1 (toggle=2)
1134	4404	Include RTrack14	clear=0 set=1 (toggle=2)
1135	4405	Include RTrack15	clear=0 set=1 (toggle=2)
1136	4406	Include RTrack16	clear=0 set=1 (toggle=2)
1137	4407	Include RTrack17	clear=0 set=1 (toggle=2)
1141	4417	Total Delay	Static Display (no control)
1142	4418	Internal	Static Display (no control)
1143	4419	Manual	Static Display (no control)
1144	4420	GPI	Static Display (no control)
1145	4421	RTrack14	Static Display (no control)
1146	4422	RTrack15	Static Display (no control)
1147	4423	RTrack16	Static Display (no control)
1148	4424	RTrack17	Static Display (no control)
1194	4500	Silence	min=-80 max=0 Step=1
1195	4501	Low Level	min=-80 max=0 Step=1
1196	4502	High Level	min=-80 max=0 Step=1
1197	4503	Overload	min=-80 max=0 Step=1
1198	4504	Warning Timer	min=1 max=20 Step=1
11F9	4601	Frequency Left	min=100 max=15000 Step=100 Div=1000
11FA	4602	Frequency Right	min=100 max=15000 Step=100 Div=1000
11FB	4603	<Identify Tone>	0=Off 1=Left 2=Right
11FD	4605	<Audio Slew Select>	0=Instant 1=Fast 2=Medium 3=Slow 4=Slowest
11FE	4606	Channel Status Dest	Edit String
11FF	4607	AES Validity Bit	clear=0 set=1 (toggle=2)
1202	4610	<Channel Status>	1=Calibrate Audio
1203	4611	Cal on Video IP Sel	clear=0 set=1 (toggle=2)
125C	4700	<Source 1>	0=None 1=Analog 1L 2=Analog 1R 3=Analog 2L 4=Analog 2R 5=SDI DeEmbed 1L 6=SDI DeEmbed 1R 7=SDI DeEmbed 2L 8=SDI DeEmbed 2R 9=SDI DeEmbed 3L 10=SDI DeEmbed 3R 11=SDI DeEmbed 4L 12=SDI DeEmbed 4R 13=SDI DeEmbed 5L 14=SDI DeEmbed 5R 15=SDI DeEmbed 6L 16=SDI DeEmbed 6R 17=SDI DeEmbed 7L 18=SDI DeEmbed 7R 19=SDI DeEmbed 8L 20=SDI DeEmbed 8R 21=Tone L 22=Tone R
125D	4701	<Source 2>	0=None 1=Analog 1L 2=Analog 1R 3=Analog 2L 4=Analog 2R 5=SDI DeEmbed 1L 6=SDI DeEmbed 1R 7=SDI DeEmbed 2L 8=SDI DeEmbed 2R 9=SDI DeEmbed 3L 10=SDI DeEmbed 3R 11=SDI DeEmbed 4L 12=SDI DeEmbed 4R 13=SDI DeEmbed 5L 14=SDI DeEmbed 5R 15=SDI DeEmbed 6L 16=SDI DeEmbed 6R 17=SDI DeEmbed 7L 18=SDI DeEmbed 7R 19=SDI DeEmbed 8L 20=SDI DeEmbed 8R 21=Tone L 22=Tone R
125E	4702	<Source 3>	0=None 1=Analog 1L 2=Analog 1R 3=Analog 2L 4=Analog 2R 5=SDI DeEmbed 1L 6=SDI DeEmbed 1R 7=SDI DeEmbed 2L 8=SDI DeEmbed 2R 9=SDI DeEmbed 3L 10=SDI DeEmbed 3R 11=SDI DeEmbed 4L 12=SDI DeEmbed 4R 13=SDI DeEmbed 5L 14=SDI DeEmbed 5R 15=SDI DeEmbed 6L 16=SDI DeEmbed 6R 17=SDI DeEmbed 7L 18=SDI DeEmbed 7R 19=SDI DeEmbed 8L 20=SDI DeEmbed 8R 21=Tone L 22=Tone R

12BC	4796	<Source 7>	0=None	1=Analog 1L	2=Analog 1R	3=Analog 2L			
			4=Analog 2R	5=SDI DeEmbed 1L	6=SDI DeEmbed 1R	7=SDI DeEmbed 2L			
			8=SDI DeEmbed 2R	9=SDI DeEmbed 3L	10=SDI DeEmbed 3R	11=SDI DeEmbed 4L			
			12=SDI DeEmbed 4R	13=SDI DeEmbed 5L	14=SDI DeEmbed 5R	15=SDI DeEmbed 6L			
			16=SDI DeEmbed 6R	17=SDI DeEmbed 7L	18=SDI DeEmbed 7R	19=SDI DeEmbed 8L			
			20=SDI DeEmbed 8R	21= Tone L	22= Tone R				
12BD	4797	<Source 8>	0=None	1=Analog 1L	2=Analog 1R	3=Analog 2L			
			4=Analog 2R	5=SDI DeEmbed 1L	6=SDI DeEmbed 1R	7=SDI DeEmbed 2L			
			8=SDI DeEmbed 2R	9=SDI DeEmbed 3L	10=SDI DeEmbed 3R	11=SDI DeEmbed 4L			
			12=SDI DeEmbed 4R	13=SDI DeEmbed 5L	14=SDI DeEmbed 5R	15=SDI DeEmbed 6L			
			16=SDI DeEmbed 6R	17=SDI DeEmbed 7L	18=SDI DeEmbed 7R	19=SDI DeEmbed 8L			
			20=SDI DeEmbed 8R	21= Tone L	22= Tone R				
12C0	4800	Gain 1	min=-85	max=0	Step=1				
12C1	4801	Gain 2	min=-85	max=0	Step=1				
12C2	4802	Gain 3	min=-85	max=0	Step=1				
12C3	4803	Gain 4	min=-85	max=0	Step=1				
12C4	4804	Gain 5	min=-85	max=0	Step=1				
12C5	4805	Gain 6	min=-85	max=0	Step=1				
12C6	4806	Gain 7	min=-85	max=0	Step=1				
12C7	4807	Gain 8	min=-85	max=0	Step=1				
12CA	4810	Mix-4 Gain-1 Disp	Static Display (no control)						
12CB	4811	Mix-4 Gain-2 Disp	Static Display (no control)						
12CC	4812	Mix-4 Gain-3 Disp	Static Display (no control)						
12CD	4813	Mix-4 Gain-4 Disp	Static Display (no control)						
12CE	4814	Mix-4 Gain-5 Disp	Static Display (no control)						
12CF	4815	Mix-4 Gain-6 Disp	Static Display (no control)						
12D0	4816	Mix-4 Gain-7 Disp	Static Display (no control)						
12D1	4817	Mix-4 Gain-8 Disp	Static Display (no control)						
1326	4902	Minimum Delay	clear=0 set=1 (toggle=2)						
1327	4903	<Color Killer>	0=Chroma Off	1=Chroma On	2=Auto				
1328	4904	<Decoder>	0=Studio	1=Simple	6=VHS/Unstable				
1329	4905	<Luma Bandwidth>	0=wide	1=Medium	2=Narrow				
132A	4906	<Notch>	0=Adaptive	1=Controllable					
132B	4907	<Luma Bandwidth>	0=wide	1=Medium	2=Narrow				
132C	4908	NTSC Hue	min=-45	max=45	Step=1				
1330	4912	PAL	clear=0 set=1 (toggle=2)						
1331	4913	NTSC	clear=0 set=1 (toggle=2)						
1332	4914	NTSC J	clear=0 set=1 (toggle=2)						
1333	4915	PAL M	clear=0 set=1 (toggle=2)						
1334	4916	PAL N	clear=0 set=1 (toggle=2)						
1335	4917	SECAM	clear=0 set=1 (toggle=2)						
1336	4918	N4.43 60	clear=0 set=1 (toggle=2)						
1337	4919	PAL4.43 60	clear=0 set=1 (toggle=2)						
1388	5000	<Memory 8>	0=Recall	1=Recall	2=Recall	3=Recall			
			4=Recall	5=Recall	6=Recall	7=Recall			
			8=						
1389	5001	<Memory 8>	0=Save	1=Save	2=Save	3=Save			
			4=Save	5=Save	6=Save	7=Save			
			8=						
138A	5002	Name	Edit String						
138B	5003	Name	Edit String						
138C	5004	Name	Edit String						
138D	5005	Name	Edit String						
138E	5006	Name	Edit String						
138F	5007	Name	Edit String						
1390	5008	Name	Edit String						
1391	5009	Name	Edit String						
1392	5010	<Memory 8>	0=Clear	1=Clear	2=Clear	3=Clear			
			4=Clear	5=Clear	6=Clear	7=Clear			
			8=						
1393	5011		min=0	max=65535	Step=1				
1770	6000	Input	clear=0 set=1 (toggle=2)						
1771	6001	Std	clear=0 set=1 (toggle=2)						
1772	6002	Reference	clear=0 set=1 (toggle=2)						
1773	6003	EDH	clear=0 set=1 (toggle=2)						
1774	6004	EDH Err	clear=0 set=1 (toggle=2)						
1775	6005	RollTrack	clear=0 set=1 (toggle=2)						
1776	6006	De-emb 1	clear=0 set=1 (toggle=2)						
1777	6007	De-emb 2	clear=0 set=1 (toggle=2)						
1778	6008	De-emb 3	clear=0 set=1 (toggle=2)						
1779	6009	De-emb 4	clear=0 set=1 (toggle=2)						
177A	6010	De-emb 5	clear=0 set=1 (toggle=2)						
177B	6011	De-emb 6	clear=0 set=1 (toggle=2)						
177C	6012	De-emb 7	clear=0 set=1 (toggle=2)						
177D	6013	De-emb 8	clear=0 set=1 (toggle=2)						
177E	6014	nPCM 1	clear=0 set=1 (toggle=2)						
177F	6015	nPCM 2	clear=0 set=1 (toggle=2)						
1780	6016	nPCM 3	clear=0 set=1 (toggle=2)						
1781	6017	nPCM 4	clear=0 set=1 (toggle=2)						
1782	6018	nPCM 5	clear=0 set=1 (toggle=2)						
1783	6019	nPCM 6	clear=0 set=1 (toggle=2)						
1784	6020	nPCM 7	clear=0 set=1 (toggle=2)						
1785	6021	nPCM 8	clear=0 set=1 (toggle=2)						
1786	6022	ANALOG 1L	clear=0 set=1 (toggle=2)						
1787	6023	ANALOG 1R	clear=0 set=1 (toggle=2)						
1788	6024	ANALOG 2L	clear=0 set=1 (toggle=2)						
1789	6025	ANALOG 2R	clear=0 set=1 (toggle=2)						
178A	6026	BUS AL	clear=0 set=1 (toggle=2)						
178B	6027	BUS AR	clear=0 set=1 (toggle=2)						
178C	6028	BUS BL	clear=0 set=1 (toggle=2)						
178D	6029	BUS BR	clear=0 set=1 (toggle=2)						
1838	6200	Input	Static Display (no control)						
1839	6201	Std	Static Display (no control)						
183A	6202	Reference	Static Display (no control)						
183B	6203	EDH	Static Display (no control)						
183C	6204	EDH Err	Static Display (no control)						
183D	6205	RollTrack	Static Display (no control)						
183E	6206	De-emb 1	Static Display (no control)						
183F	6207	De-emb 2	Static Display (no control)						
1840	6208	De-emb 3	Static Display (no control)						
1841	6209	De-emb 4	Static Display (no control)						
1842	6210	De-emb 5	Static Display (no control)						
1843	6211	De-emb 6	Static Display (no control)						
1844	6212	De-emb 7	Static Display (no control)						

1845	6213	De-emb 8	Static Display (no control)
1846	6214	nPCM 1	Static Display (no control)
1847	6215	nPCM 2	Static Display (no control)
1848	6216	nPCM 3	Static Display (no control)
1849	6217	nPCM 4	Static Display (no control)
184A	6218	nPCM 5	Static Display (no control)
184B	6219	nPCM 6	Static Display (no control)
184C	6220	nPCM 7	Static Display (no control)
184D	6221	nPCM 8	Static Display (no control)
184E	6222	ANALOG 1L	Static Display (no control)
184F	6223	ANALOG 1R	Static Display (no control)
1850	6224	ANALOG 2L	Static Display (no control)
1851	6225	ANALOG 2R	Static Display (no control)
1852	6226	BUS AL	Static Display (no control)
1853	6227	BUS AR	Static Display (no control)
1854	6228	BUS BL	Static Display (no control)
1855	6229	BUS BR	Static Display (no control)
1859	7001	Software Version	Static Display (no control)
185A	7002	FPGA Sync Version	Static Display (no control)
185B	7003	FPGA Dec Version	Static Display (no control)
185D	7005	Serial Number	Static Display (no control)
1860	7008	<Information Window>	1=Factory Default
1861	7009	Build Number	Static Display (no control)
1DB0	7600	Luma Strength	min=0 max=31 Step=1
1DB1	7601	Chroma Strength	min=0 max=31 Step=1
1DB2	7602	<Threshold Mode>	0=Auto 1=Manual
1DB3	7603	Manual Threshold	min=0 max=15 Step=1
1DB4	7604	Auto Bias	min=-7 max=7 Step=1
1DB5	7605	<Delay Mode>	0=Normal Delay 1=Minimum Delay
1DB6	7606	Noise Measured	Static Display (no control)
1F40	8000	<Information Window>	1=Error Seconds Reset
1F41	8001	<Information Window>	1=Restart
1F4A	8010	<Information Window>	0=Input Status 1=EDH & ANC Status 2=Audio Input Status
1FA4	8100	<Default Output>	0=Pass Video 1=Freeze 2=Pattern 3=Pattern&Caption
2008	8200	<Default Pattern>	0=Black 1=EBU Color Bars 2=100% Color Bars 3=Ramp 4=Multi-Burst 5=Pulse & Bar
2009	8201	Default Caption	Edit String
3202	12802	Animated Pattern	clear=0 set=1 (toggle=2)

RollTrack Audio Delay Tracking

RollTrack is a feature of RollCall™ (Snell & Wilcox's proprietary remote control system), that allows devices to communicate across the RollCall network with no direct user intervention.

RollTrack Audio Delay Tracking enables Snell & Wilcox RollCall™ compatible audio delay products to track delay introduced by RollCall™ compatible video processing products.

The current products that implement RollTrack Audio Delay Tracking are:

Audio Delay Modules	Video Modules	Other Products	
IQBAAD	IQD1FSY	ALCHEMIST	MDD3000
IQBADC	IQDMSDS	CPP100	MDD550
IQBDAC	IQDAFS	CPP200	MDD560
IQBDAD	IQDMSDS	NRS500	MDD570
IQBSYN	IQDMSDP	HD5050	MDD2000
IQBADCD	IQDSYN		

The simplest configuration is a single video unit and a single audio delay in a RollCall™ system. The audio delay will have the same delay as through the video path. If the delay changes the audio delay will track.

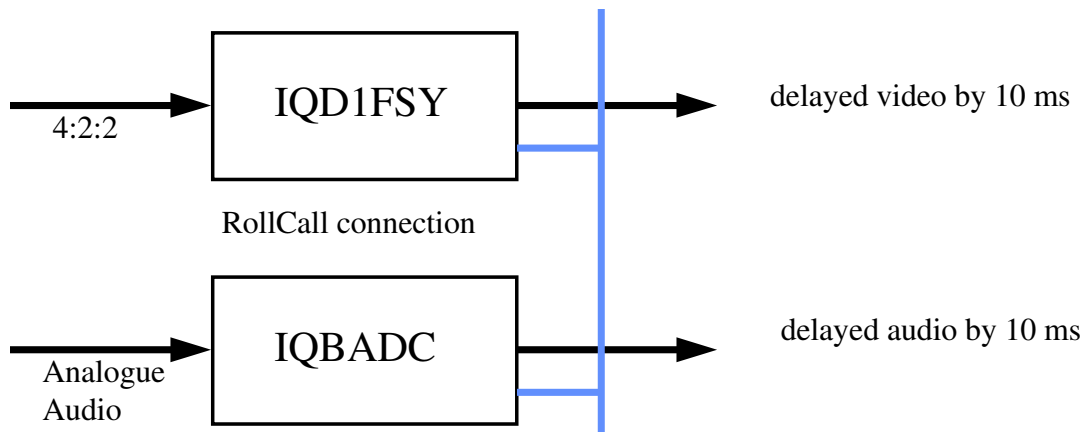

The next level of configuration is where there are multiple Frame Synchronizers (for example) each connected through RollCall™ to their own tracking Audio Delay. (It is worth stating that the synchronizers and audio delays do not have to be in the same enclosure; the addressing scheme, discussed later, allows for the units to be positioned anywhere in the RollCall™ domain.)

The maximum number of video units and audio delays in a RollCall™ system is set by the maximum limit of the number of modules in a RollCall™ network and is currently 3840 on a single network without bridges.

The unique identification of the destination unit (a decimal number) for various modules is as follows:

Module	ID
IQBADC	51
IQBDAC	52
IQBAAD	53
IQBDAD	54
IQBSYN	89
IQBADCD	107

The next level of complexity is a *vertical delay cluster* where a video unit can have up to eight audio delays tracking - of the same or different types.

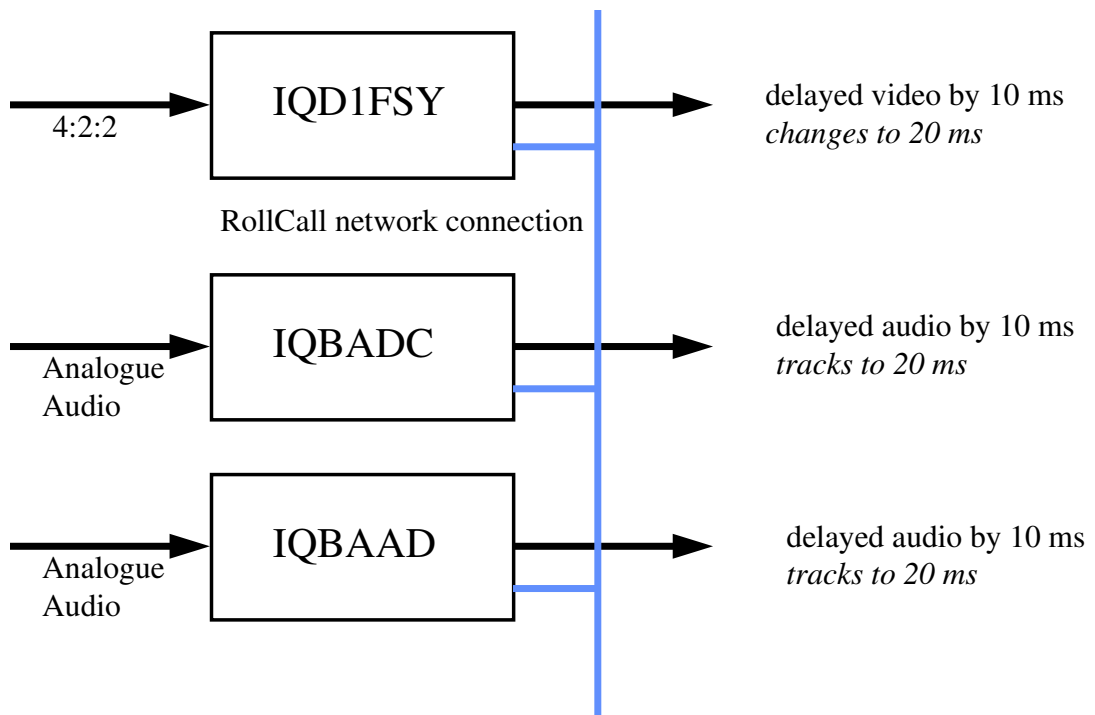

From one to eight audio delay products can be connected via RollCall™ to a single frame synchronizer, for example. If the synchronizer delay changes, then however many audio delays are connected will track the delay. The audio delays can also have a manual delay which will be added to the RollTrack delay.

The next level of complexity is a *horizontal delay cluster* where an audio delay can track up to four video units.

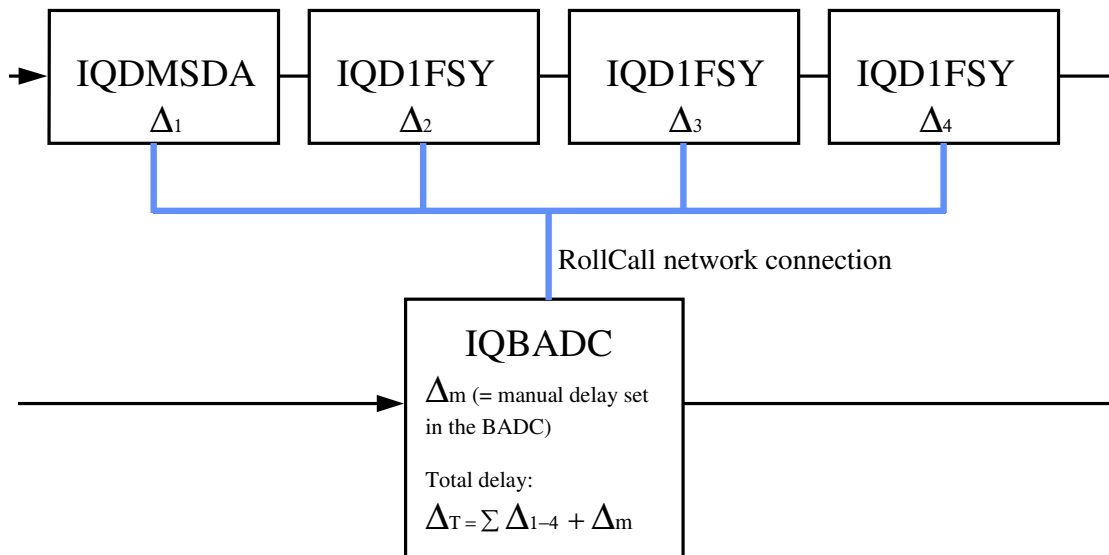

The total delay time through the audio delay is then the sum of the individual delays introduced by the video units plus the manual delay of the audio unit. The manual delay can be set to compensate for any fixed propagation delay in the video path or may be set to zero.

The next level of complexity is a *matrix delay cluster* where each audio delay (up to eight) can track up to four video units. This configuration is in effect a four by eight matrix of video units and audio delay units. The total delay time through the audio delay units is then the sum of the individual delays introduced by the video units plus the manual delay of the audio unit.

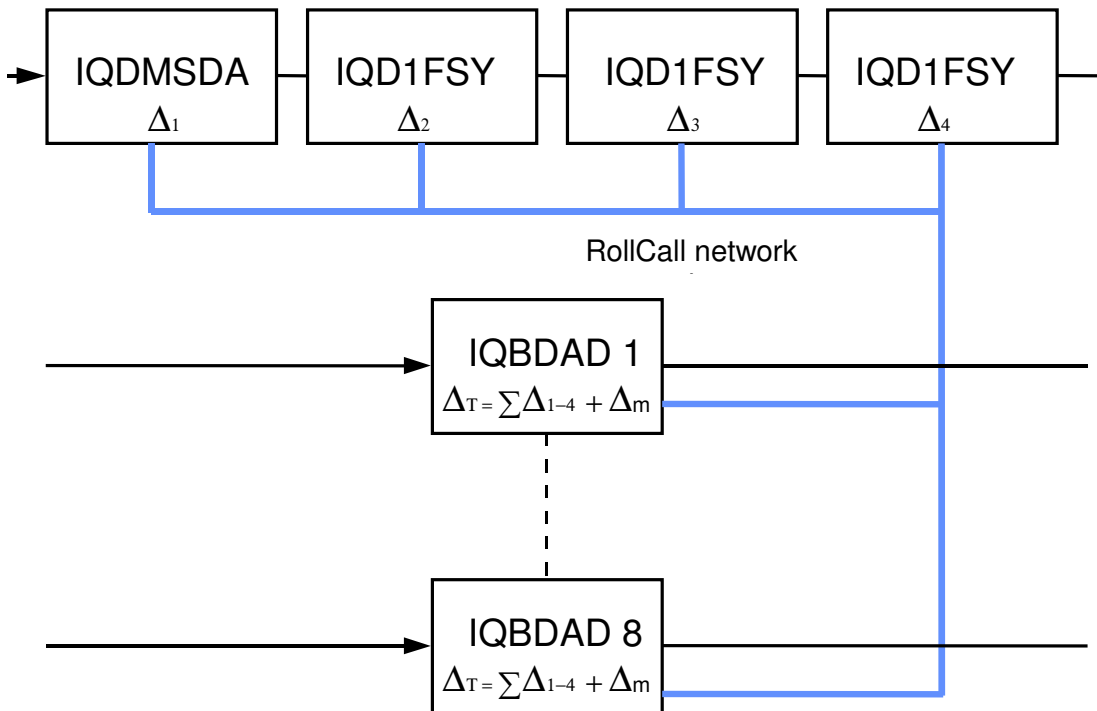

As any of the delay times change in the video path so will the audio delay time track this delay. A virtual connection is made between from, say, an IQD1FSY to an IQBDAD by:

- selecting the *Setup...* Menu of the IQD1FSY
- then selecting the *Audio_Delay...* Menu
- then choosing from *Unit_1* to *Unit_8*
- then entering the unique network address of the IQBDAD in the form *nnnn:xx:yy*z*d*
- where *nnnn* = network address and in most cases will be 0000(hex);
- xx* = IQ enclosure address (hex);
- yy* = slot address of the IQBDAD (hex)
- z* = the connection (or channel) number (decimal) - see table below.
- d* = the unique identification of the destination unit (decimal) The ID entered must match the receiving units own ID or else the command will be ignored. If the ID value is set to 00, the receiving unit does not perform an ID match and will always accept the incoming command
- then selecting the *Delay...* Menu of the IQBDAD
- then selecting *RollTrack*

Example of Network Addresses with Channel Numbers and ID Numbers

	D1FSY 1	D1FSY 2	D1FSY 3	D1FSY 4
Audio delay 1	0000:10:01*14*54	0000:10:01*15*54	0000:10:01*16*54	0000:10:01*17*54
Audio delay 2	0000:10:03*14*54	0000:10:03*15*54	0000:10:03*16*54	0000:10:03*17*54
Audio delay 3	0000:10:05*14*54	0000:10:05*15*54	0000:10:05*16*54	0000:10:05*17*54
Audio delay 4	0000:10:07*14*54	0000:10:07*15*54	0000:10:07*16*54	0000:10:07*17*54
Audio delay 5	0000:10:09*14*54	0000:10:09*15*54	0000:10:09*16*54	0000:10:09*17*54
Audio delay 6	0000:10:0B*14*54	0000:10:0B*15*54	0000:10:0B*16*54	0000:10:0B*17*54
Audio delay 7	0000:10:0D*14*54	0000:10:0D*15*54	0000:10:0D*16*54	0000:10:0D*17*54
Audio delay 8	0000:10:0F*14*54	0000:10:0F*15*54	0000:10:0F*16*54	0000:10:0F*17*54

The most complex system would be an array of matrix delay clusters

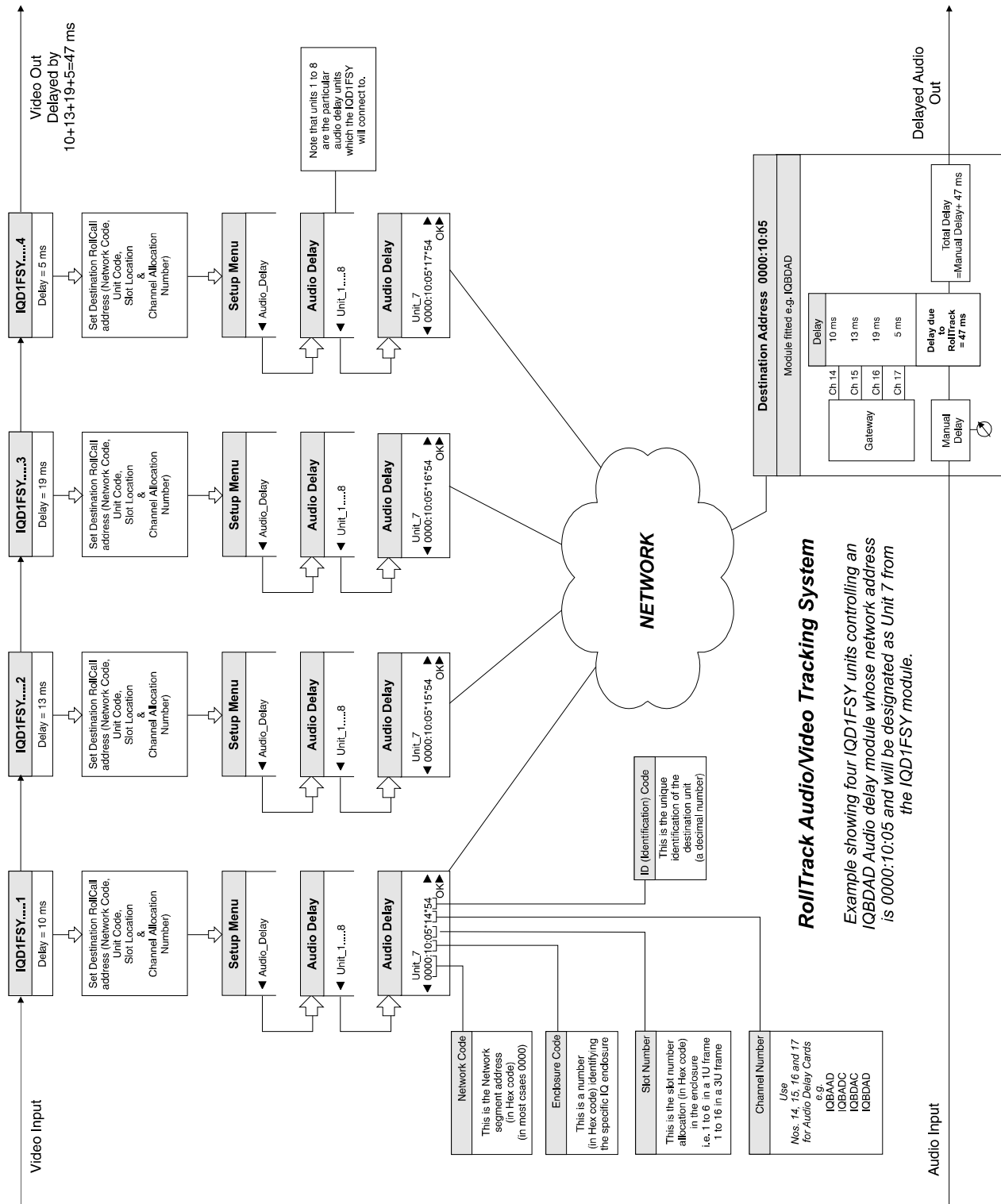

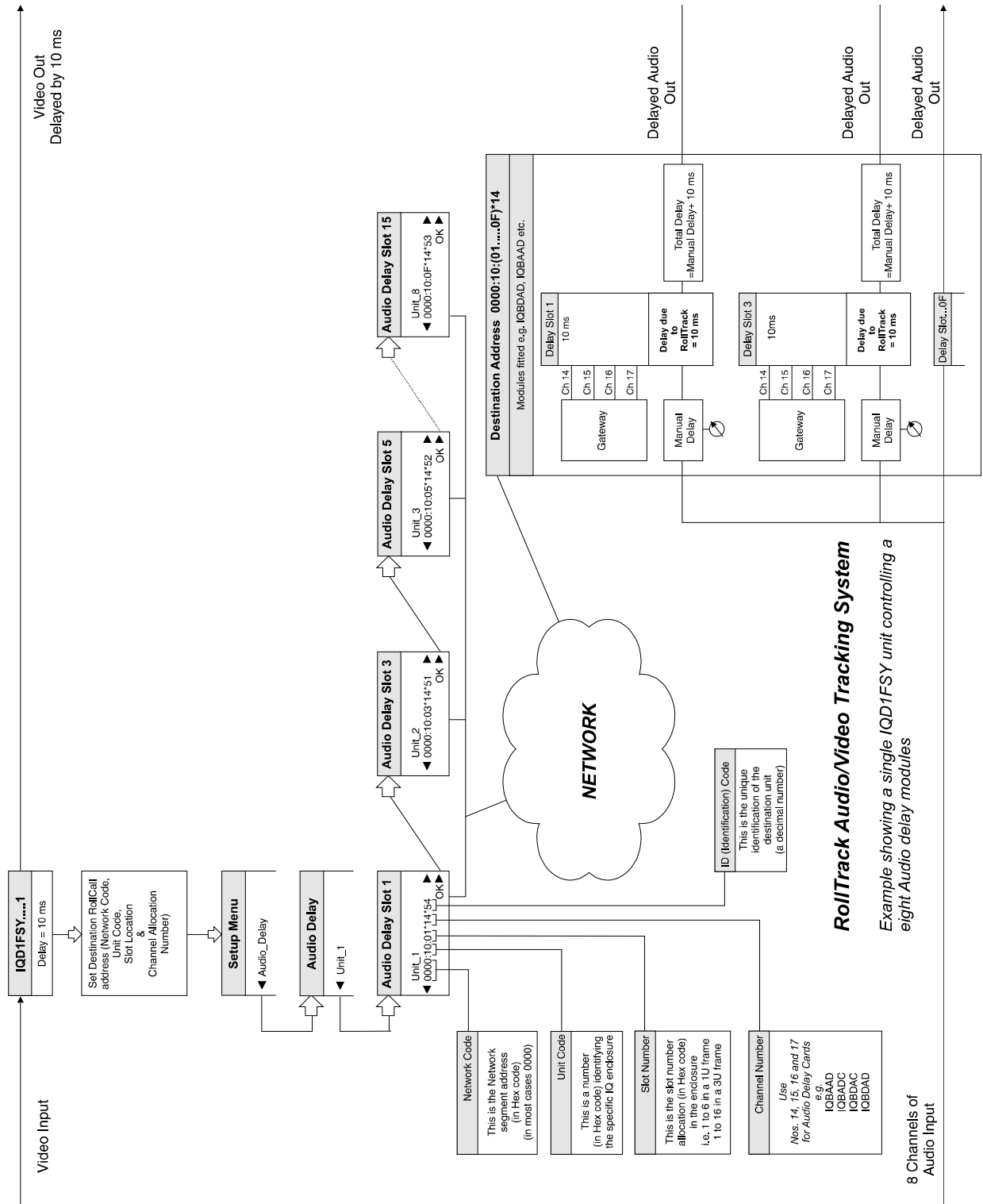

Appendix 1

The Firewall

What is the function of a firewall?

The firewall protects a digital signal output against propagation of errors or disruptions in the input signal. It ensures that the signal stream at that output is continuously valid no matter what happens at the input. If the input suffers any dropout, loss of data, or break or discontinuity in the carrier then this will not be reflected in the output. Default valid data will be used to pad the output stream such as video black, a freeze, or audio silence.

The firewall does not ensure the pictures or the audio is what you want to see or hear of course, a corrupted signal can lead to loss of original content. It will ensure that whatever valid content you have it will get through however. In short it ensures the integrity, not the content, of the digital stream.

How a firewall equipped product behaves

The essential behavior of a system containing a firewall is that:

The input to the unit containing the firewall can be removed and later replaced with another signal and during this sequence the unit following the one with the firewall will see no disturbance at its input.

Why use a firewall?

Any equipment downstream of a Snell & Wilcox product with firewall protection can expect to be fed with a continuous input stream. Dropouts in the signal, disturbances due to switching and errors in the composition of the signal will not penetrate the firewall and will therefore not corrupt operations downstream. The examples below illustrate where firewalls are of most benefit.

At the beginning of a chain

They are excellent for use at the beginning of a chain. Traditionally a damaged signal would be passed by all equipment in a chain. This meant that each unit would lose lock on the digital signal it was passing. The damage in the signal would immediately appear at the input to every device all the way through to the last point in the chain. When the signal was restored, each unit in the chain might take a few seconds to recover. The next unit would not start recovery until the previous unit had locked to the signal again. The effect could be a huge delay in restoring the signal by the end of the chain as each unit recovered one by one. A minor flaw in the input signal such as a tiny break in the carrier could lead to several seconds of disruption on the output.

To protect MPEG encoders

Many people have found to their regret that MPEG encoders do not survive a break in the integrity of their input signal. They often corrupt their output and take a long time to recover. Video synchronizers can help but they only protect the video. Loss of the audio would prove terminal even though the integrity of the video was maintained. For transmission encoders this could mean a break in the output. For recording encoders such as those in a video server this often meant the recording was lost. Placing a Snell & Wilcox firewall product in front of any such encoders will ensure that they never get disrupted in this way even though there may be a break in the incoming content.

How a firewall is tested

A variety of equipment is used to test the firewall behavior. The test consists of analyzing the data downstream of the firewall product looking for discontinuities in the signal stream. While it is intended that all products fed by a firewall equipped unit will accept the signal as uninterrupted, it is accepted that there is a wide variety of real-world performances. Therefore the reference product used to test whether the output streams are continuous is the Snell & Wilcox IQMUX01 for both AES and SDI signals.

Performance of firewall equipped products versus genlock mode

The tables below summarize the behavior of products for different genlock modes:

Synchronizer Mode			
	Referenced	Input locked	Free run
SDI Video	<i>Firewall</i>	<i>No firewall</i>	<i>Firewall</i>
AES	<i>Firewall</i>	<i>Firewall</i>	<i>Firewall</i>

When Firewall Protection is not provided

Video

The firewall protects against disruption or illegal signals at the input and not against corrupt or illegal reference provision. The user should also note that when changing genlock mode, the firewall is not maintained for the video output during the change. Examples would include changing from free-running mode to referenced mode or when the reference is adjusted or interrupted.

Embedded audio

Embedded audio firewall protection follows the video behavior. When the video is protected then the embedded audio is also protected. See all the information relating to video firewall protection.

AES Audio

AES outputs will generally always maintain a firewall with the exceptions noted below. Unlike the video signal, most reference changes do not disrupt the AES firewall.

Exceptions

AES outputs on audio products will normally maintain a firewall for PCM audio except when switching to or from AES1 as a reference.

Only PCM signals are protected by the firewall. The non-PCM direct paths for audio do not have firewall protection.

