

IQDEC04**Golden Gate Decoder, Synchronizer with Noise Reduction – 12 bit****Table of Contents**

Module Description	2	RollTrack	24
Rear Panel View	2	Memories	26
Product Comparison.....	2	Logging	27
Block Diagram.....	4	ROLLCALL LOG FIELDS	28
Features	4	Setup	29
Technical Profile	5	Operation from an Active Control Panel	31
INPUT CONNECTIONS	7	MAIN MENU	34
COMP IN (-1 version).....	7	Video.....	34
COMPOSITE A and B (-1A version)	7	Decoder.....	38
Separated Y C (-1A version)	7	Genlock.....	40
REFERENCE	8	Setup.....	42
GPI	8	Pattern.....	42
OUTPUTS.....	9	Caption	43
Serial Digital Video Outputs	9	VBI & HANC Blank(ing).....	44
CARD EDGE INDICATORS	10	GPI I/O	47
RollCall PC Control Panel Screens.....	11	RollTrack	49
Video	11	Logging.....	51
ProcAmp.....	13	ROLLCALL LOG FIELDS.....	52
Decoder	15	Default Output	53
Genlock	17	User Mem(or)ies.....	55
VBI & HANC Blank(ing).....	19	Freeze.....	55
Caption & Pattern	20	IQDEC04 RollCall Commands	56
GPI	22	RollTrack Audio Delay Tracking.....	63
		Manual Revision Record.....	68

Module Description

The IQDEC04 provides 12 bit decoding of PAL/NTSC-M/NTSC-J/PALN/N4.43/SECAM and PALM composite video using enhanced 3D Golden Gate technology. A full frame synchronizer with horizontal and vertical phasing controls

synchronizes the output to a studio reference. In addition, a powerful frame recursive noise reducer is able to automatically eliminate most background noise.

Rear Panel View

IQDEC0415-A

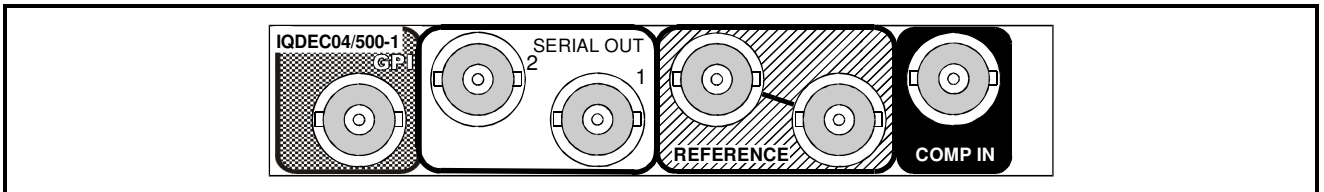

IQDEC0416-2

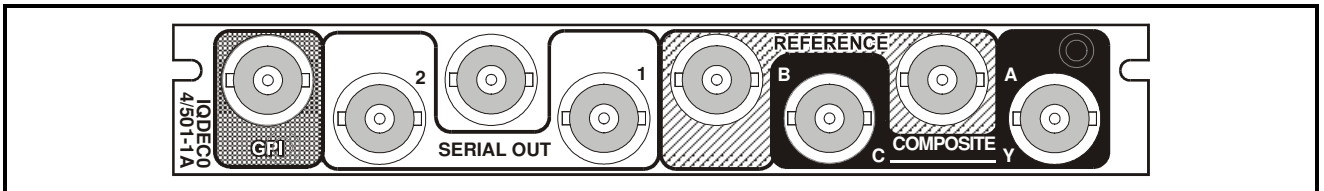

This manual covers the following products:

IQDEC0401-1A 12 bit golden gate decoder with synchronizer and noise reduction. 2 composite, 1 Y/C inputs, 2 SDI outputs

IQDEC0400-1 12 bit golden gate decoder with synchronizer and noise reduction. 1 composite input, 2 SDI outputs

Product Comparison

Product	CVBS Inputs	Y/C Inputs	SDI Outputs	GPI	Genlock	Width & Style
IQDEC0401-1A	2	1	2	1	Loop-through	Single A
IQDEC0400-1	1	No	2	1	Loop-through	Single 0

Note that there are two styles of rear panels available. They are not interchangeable between the two styles of enclosures. However, the cards may be fitted into any style of enclosure.

'A' Style Enclosure

Rear panels **with** the suffix A may only be fitted into the 'A' style enclosure shown below.

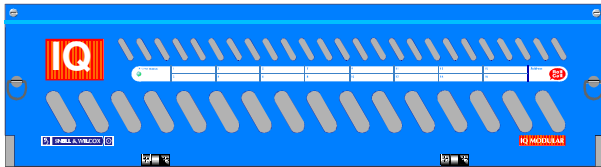

(Enclosure order codes IQH3A-E-0, IQH3A-E-P, IQH3A-0-0, IQH3A-0-P)



(Enclosure order codes IQH3A-S-0, IQH3A-S-P)

'O' Style Enclosures

Rear panels **without** the suffix A may only be fitted into the 'O' style enclosures shown below.

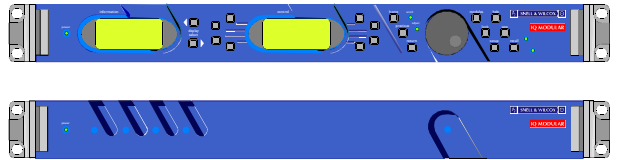

(Enclosure order codes IQH1S-RC-0, IQH1S-RC-AP, IQH1U-RC-0, IQH1U-RC-AP, Kudos Plus Products)

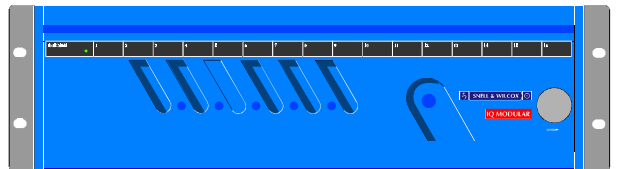

(Enclosure order codes IQH3N-0, IQH3N-P)



(Enclosure order codes IQH3U-RC-0, IQH3U-RC-P)

Block Diagram

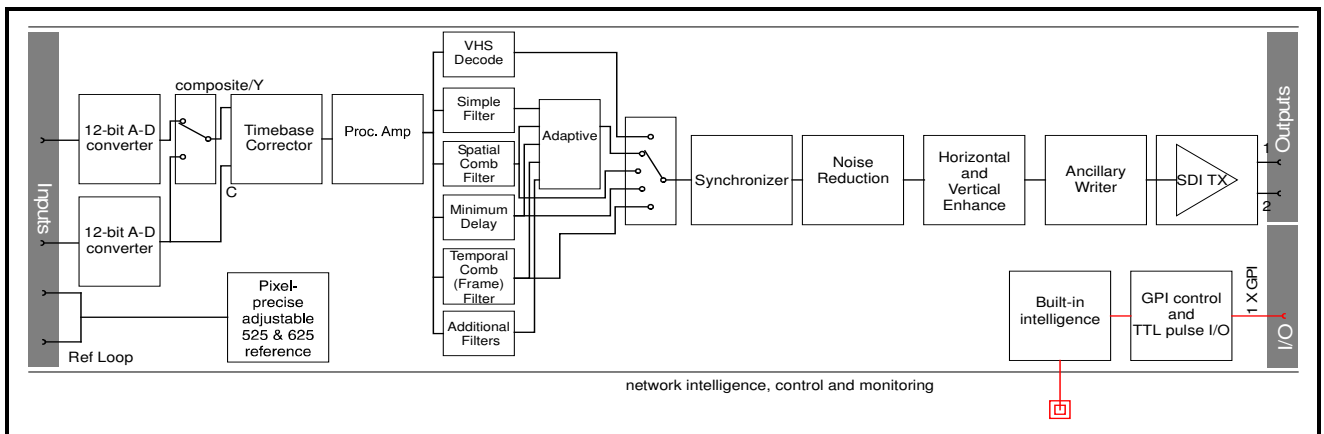

Features

- 12 bit multi-standard decoder with frame synchronizer and TBC
- 1/2 composite inputs
- 2 x SDI outputs
- Input standards – PAL, NTSC, NTSC-J, SECAM, N4.43, PALN or PALM
- Auto detection of input standards - PAL, NTSC, SECAM, PALN or PALM
- Adaptive spatio-temporal frame comb decoding
- Minimal decoder delay – normally < 2 lines (plus synchronizer delay)
- Handles VHS playback and other noisy or unstable sources
- SECAM adaptive notch and chroma median filters
- Motion adaptive recursive noise reducer with automatic noise floor measurement
- Horizontal and vertical enhancer
- Genlock SPG with phasing adjustments. (free-run and lock-to-input modes)
- Test signal generator (100% color bars, 75% color bars, multi-burst, black, animated bar)
- Adjustment of video gain, black level, chroma gain, NTSC hue, horizontal Y/C timing and picture position
- Firewall to provide a continuous video output
- Selectable default output on loss of input - Frame freeze, pattern or input pass
- Selectable VBI pass through (pass flat or blank for each VITS line)
- Full RollCall remote control
- Delay input and output via RollTrack or GPI
- 19 character caption generator
- 8 user memories

Technical Profile

Signal Inputs

Composite Video2 via BNC connectors, isolated
 Y-C1 via BNC connectors
 StandardsPAL/NTSC//NTSC-J/PAL-M
 /PAL-N/SECAM/N4.43
 Reference1 analog loop through via BNC
 connectors

Signal Outputs

Serial Digital 2 x SDI via BNC connectors
 Standards SMPTE 259M-C-1997, SMPTE
 272M-A-1994, AES3-1992

Control Interface

GPI/OClosing contact input/output via
 BNC connector

Card Edge Controls

None

Card Edge Indicators

CPU running/PowerFlashing = OK
 Analog Video PresentLost = Off, Good = On (Green)
 Analog Video ErrorGood = Off, Error = On (Yellow)
 Reference PresentLost = Off, Good = On (Green)
 Reference ErrorGood = Off, Error = On (Yellow)

Functions Available via RollCall Only

Video Controls

Input SelectComposite A / B, YC
 Composite Input Standard ..Auto [PAL, NTSC, PALM, PALN,
 SECAM] / Manual [PAL, NTSC,
 NTSC-J, PALM, PALN, SECAM,
 N4.43]
 FreezeOff / On
 Luma Gain+6 dB to -3 dB
 Chroma Gain+6 dB to -3 dB
 Black Level±120 mV
 NTSC Hue±45°
 Y/C Timing+592 ns in 148 ns steps
 Picture Position±592 ns in 148 ns steps
 BlankingLeft, right, top, bottom, color
 Noise Reducer Mode & Noise Measurement
 Auto / Manual noise measurement
 Normal / Minimum delay
 Noise ThresholdAuto Bias [±7] / Manual [0 to 15]
 Noise Reducer StrengthLuma [0 to 31], Chroma [0 to 31]
 H EnhanceOff / [On - low, medium, high]
 H Enhance Frequency2.25 MHz or 3.375 MHz
 V EnhanceOff / [On - low, medium, high]
 Decoder ModeSimple / Studio / VHS/Unstable

SECAM Notch Adaptive/Controllable
 SECAM Luma Bandwidth... Wide/Medium/Narrow
 SECAM Bottles Auto/On/Off
 Color Killer Chroma ON / Chroma OFF / Auto
 [QAM standards: Chroma off =
 chroma mute + Y notch
 SECAM: Chroma off = chroma
 mute only]
 Genlock H Phase ±32 µs in 37 ns steps
 Genlock V Phase ±262/312 lines in 1 line steps
 Genlock Mode Free-run / Lock to reference / Lock
 to input (minimum delay)
 Additional Video Delay 0, 1 or 2 frames of delay
 Pass VBI Data Pass as data
 Pass as VITS
 Blank (lines selectable 7/11 to
 22/19 and 320/274 to 335/282)
 PAL Line 23 Process As Video / Pass as WSS /
 Blank
 NTSC Line 20/283 Process as Video/Pass as
 Data/Blank
 NTSC Line 21/284 Process as Video/Pass as
 Data/Pass as Closed
 Captions/Blank
 NTSC Line 22/285 Process as Video/Pass as
 Data/Blank

Other Controls

Pattern Enable Off / On
 Pattern Select Black / EBU Color Bars / 100%
 Color Bars / Ramp / Multi-Burst /
 Pulse & Bar / Animated Bar
 Caption Enable Off / On
 Caption Generator Programmable up to 19 characters
 GPI Action Memories 1 to 8 / Pattern / Freeze
 GPI Polarity High / Low
 GPO Action Input loss / Standard / Video delay
 GPO Polarity High / Low
 User Memories Name, clear, save and recall 8 user
 memories
 Default Video Output Pass Video / Freeze / Pattern /
 Pattern and Caption
 Preset Unit Returns all settings to default

Technical Profile (continued)

Reporting * also Logged

Input Status	*Input present, *Input line standard, *Composite color standard
Input Error	One or more inputs have unselected line standard
Reference Status.....	*Ref present, *Ref standard
Reference Error.....	Standard different to selected input

Specifications

Video Specifications

Video Internal Processing...	4:2:2 with 10 bit data paths
Frequency Response (Studio Mode)	
Y.....	5.75 MHz \pm 0.1dB
PbPr	1.5 MHz -3dB
Frequency Response (VHS Mode)	
Y.....	5 MHz +0.2 dB, -0.5 dB
PbPr	1.5MHz -3dB typ
Composite Input Return Loss	Better than 35 dB to 5 MHz
Composite level/impedance	1 V pk-pk typ. Into 75 Ohm
Serial Output Level.....	800 mV \pm 5%
Output Overshoot	< 70 mV
Output Return Loss	Better than 15 dB to 270 MHz
Output Jitter.....	< 0.2 UI (with 10 Hz High pass filter selected on 601 monitor)
Reference Return Loss.....	Better than 35 dB to 5.8 MHz
Reference Input Level.....	1 Vp-p \pm 3 dB
Sync Level.....	0.3 V \pm 6 dB into 10k Ohms

Delay through the unit

Decoder Delay.....	<2 lines (Line Comb) <1 frame + 1 line (Frame Comb)
--------------------	--

RollTrack Input

Delay	Audio delay – Fixed, RollTrack + Fixed, Internal Sync \pm Fixed
-------------	--

RollTrack Output

Delay	Current video delay
Input State	Present / line standard
Reference State.....	Present / error

Synchronizer Delay.....	16 μ s (Lock to Input) 1 frame + 16 μ s (Lock to Reference)
Additional Processing Delay	<100 μ s
Noise Reducer Delay	<1 frame (Normal) <3 lines (Minimum Delay)
Total Minimum Delay	<7 lines
Total Maximum Delay	>5 frames (including optional video delay)

Power Consumption

Module Power Consumption	13 W
--------------------------	------

INPUT CONNECTIONS

COMP IN (-1 version)

This is the composite video input to the module via a BNC connector. Nominal input level is 1 V p-p terminated in 75 Ohms.

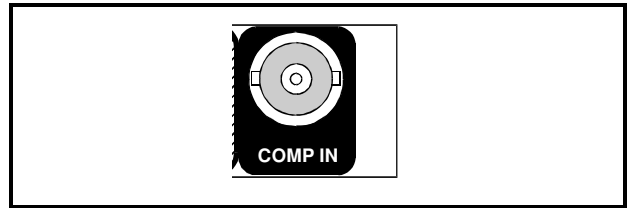
**COMPOSITE A and B (-1A version)**

These are the two composite video inputs to the module via BNC connectors. Nominal input level is 1 V p-p terminated in 75 Ohms.

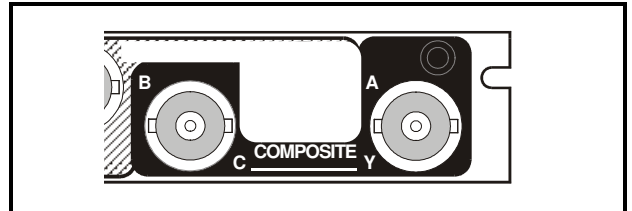
**Separated Y C (-1A version)**

A Y-C (S-VHS, Hi-8 etc.) input signal may be connected to the unit via two BNC connectors marked Y and C.

Y input level is a nominal 1V p-p into 75 Ohms.
C input is nominal color burst level into 75 Ohms.

REFERENCE

The analog reference input to the unit is made via the passive loop-through BNC connectors for 75 Ohms.

The signal may be black burst or composite video at standard levels.

Note that if the loop-through facility is not used the unused BNC socket must be fitted with a 75 Ohm terminator or the Reference Input Termination link on the card set to the 75 ohm position as shown below.

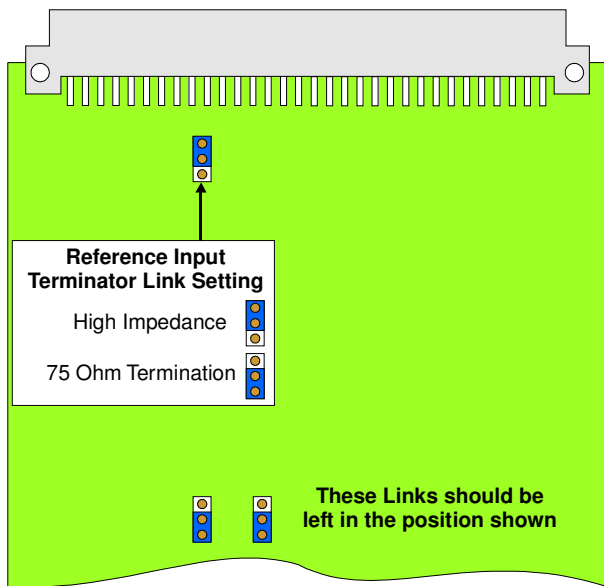
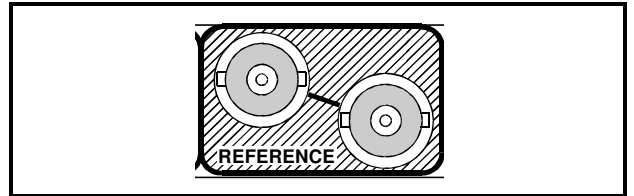
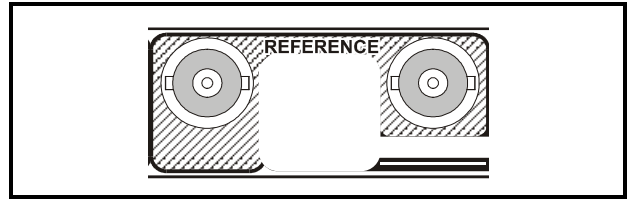

GPI

This connector is used for accepting GPI information (from mechanical switch contacts, relay contacts etc.) The resulting action that the unit takes may be programmed via RollCall.

It may also be configured as an output.

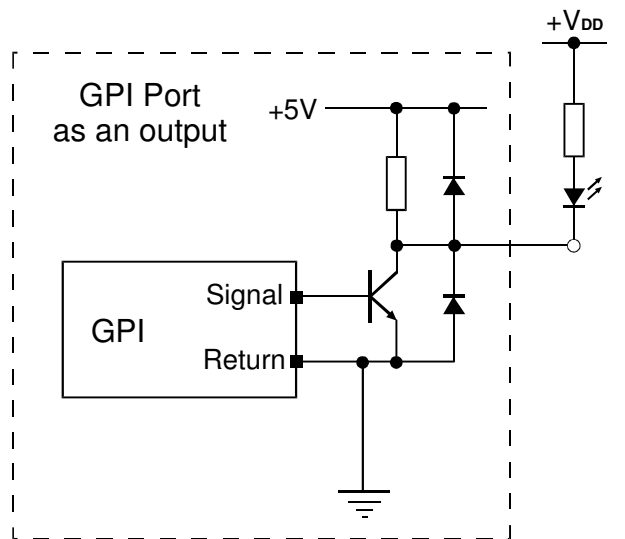
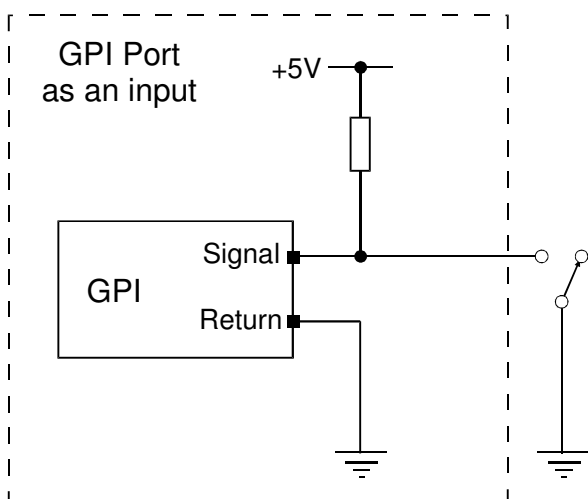

OUTPUTS

Serial Digital Video Outputs

These are the two Serial Digital outputs of the unit via BNC connectors for 75 Ohms.

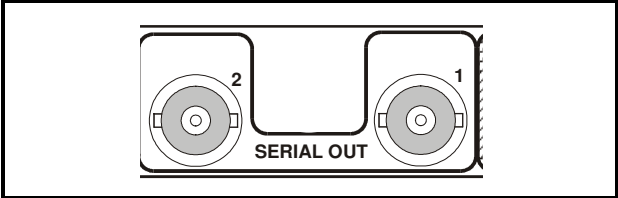
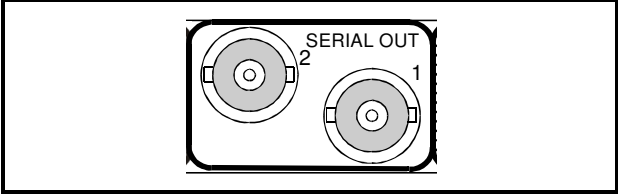

CARD EDGE INDICATORS

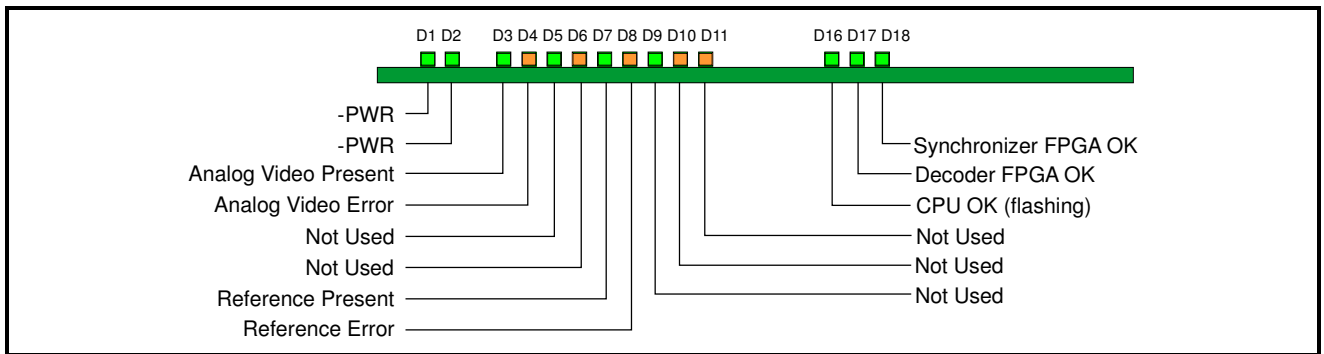

LED INDICATORS

D1: -PWR (Green)

When illuminated this indicates that the negative power supply is operating.

D2: +PWR (Green)

When illuminated this indicates that the positive power supply is operating.

D3: Analog Video Present (Green)

When illuminated this indicates that there is a valid signal at the composite input.

D4: Analog Video Error (Amber)

When illuminated this indicates that there is an invalid signal at the composite input.

D5: Not used**D6: Not used****D7: Reference Present (Green)**

When illuminated this will indicate that a valid reference signal is present.

D8: Reference Error (Amber)

When illuminated this will indicate that an invalid reference signal is present.

D9: Not used**D10: Not used****D11: Not used****D16: CPU OK (flashing) (Green)**

This LED will flash to indicate that the CPU is running.

D17: Decoder FPGA OK (Green)

This will illuminate when the Decoder FPGA has been loaded.

D18: Synchronizer FPGA OK (Green)

This will illuminate when the Decoder FPGA has been loaded.

RollCall PC Control Panel Screens

Video

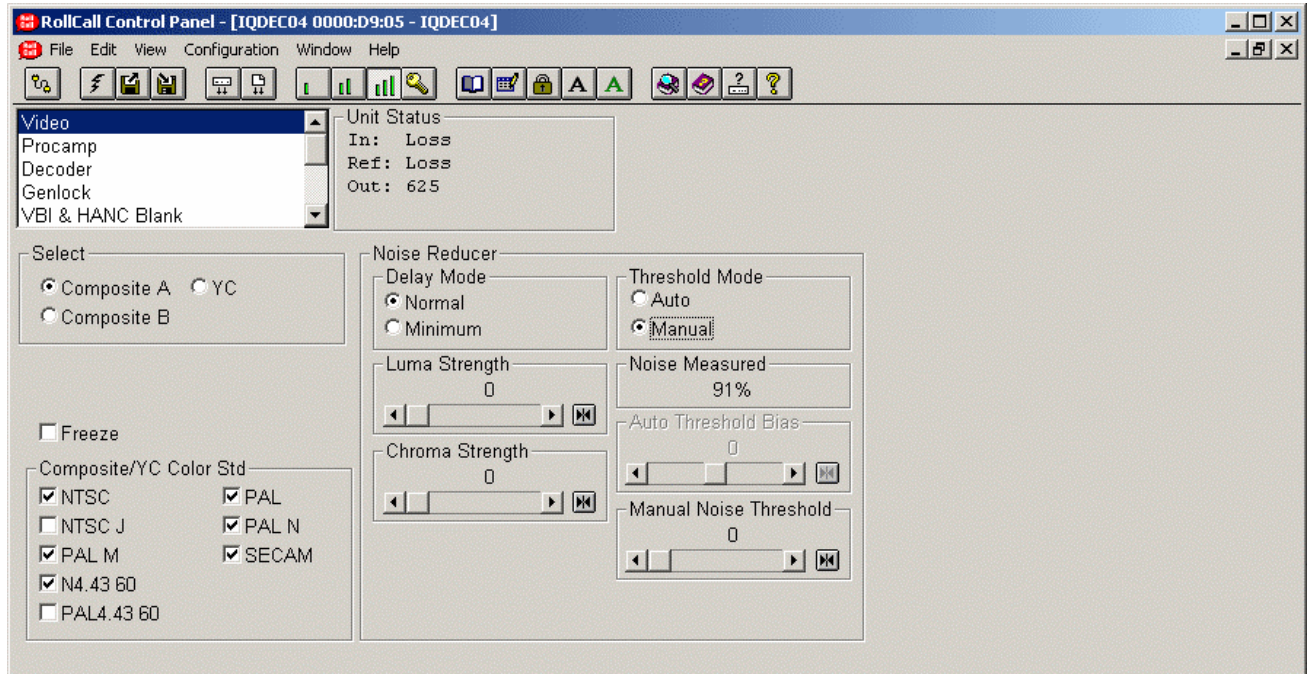

Select

This allows either the **Composite A**, **Composite B** or **YC** input to be selected for processing.

Composite/YC Color Standard

This allows the automatic detection of the color standard(s) for the composite/YC input.

The module will automatically detect any of the color standards that have been checked. In the screen example above the unit will automatically detect PAL, NTSC, PAL-M, PAL-N, N4.43 60 and SECAM but will not detect NTSC-J or PAL4.43 60.

Note that when selecting and deselecting SECAM the output picture may suffer some disruption.

Freeze

When checked the output picture will become a frozen frame.

Video (continued)

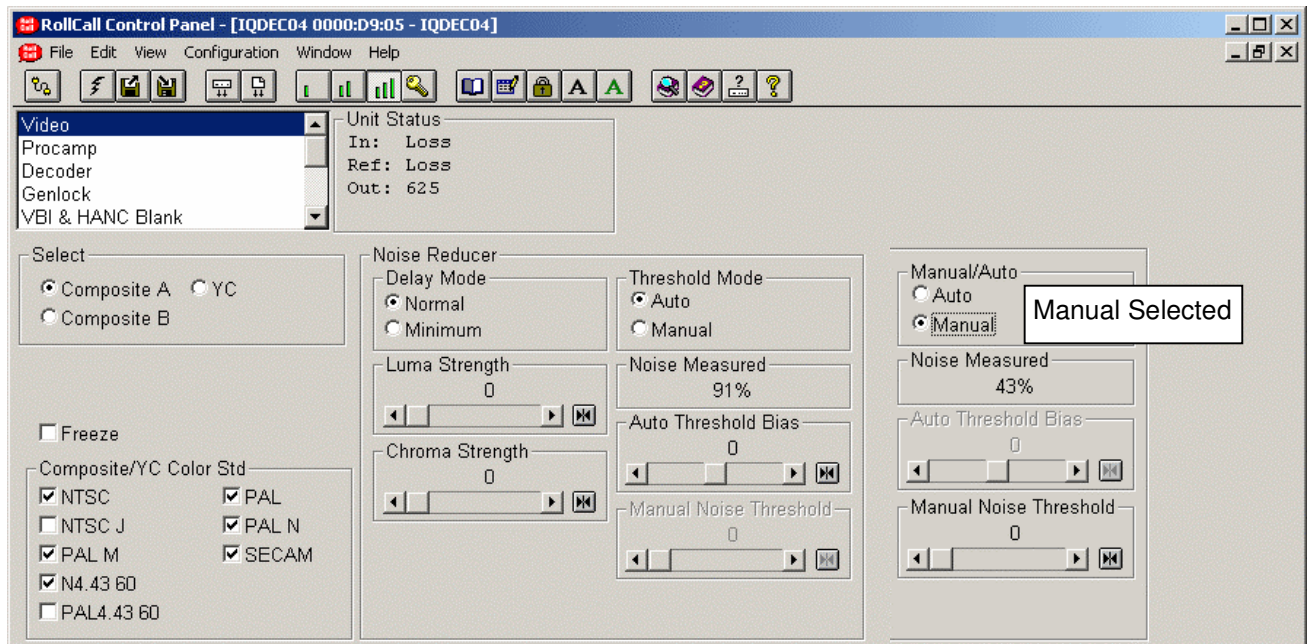

Noise Reducer

This allows settings and adjustments to be made to the noise reducer.

Delay Mode

This allows the delay of the noise reducer to be selected.

Normal

In this mode the delay will be < 1 Frame

Minimum

This mode produces the minimum input/output delay and may be used where audio delay problems may exist and cannot be compensated for. In this mode the delay will be < 3 Lines

Manual/Auto

Manual

In this mode the noise floor may be adjusted manually using the **Manual Noise Threshold** control.

Noise Measured

This provides an indication of how much noise there is in the signal. A clean signal will give low figures and a noisy signal high figures.

Auto

In this mode the noise floor is automatically measured and the threshold is adjusted dynamically set to an appropriate value for the current input noise level. The noise detection algorithm may be given a subjective bias using the **Auto Threshold Bias** control to give more or less noise reduction. Modification of the bias should not be necessary under normal circumstances.

Luma Strength

This control changes the amount of noise reduction for the luminance by limiting the maximum level of noise reduction, where 31 is maximum and 0 is minimum. Preset is to 0. The actual level of noise reduction is dynamically adjusted on a pixel-by-pixel basis with regard to the noise reduction setting for the same pixel in the previous frame.

Chroma Strength

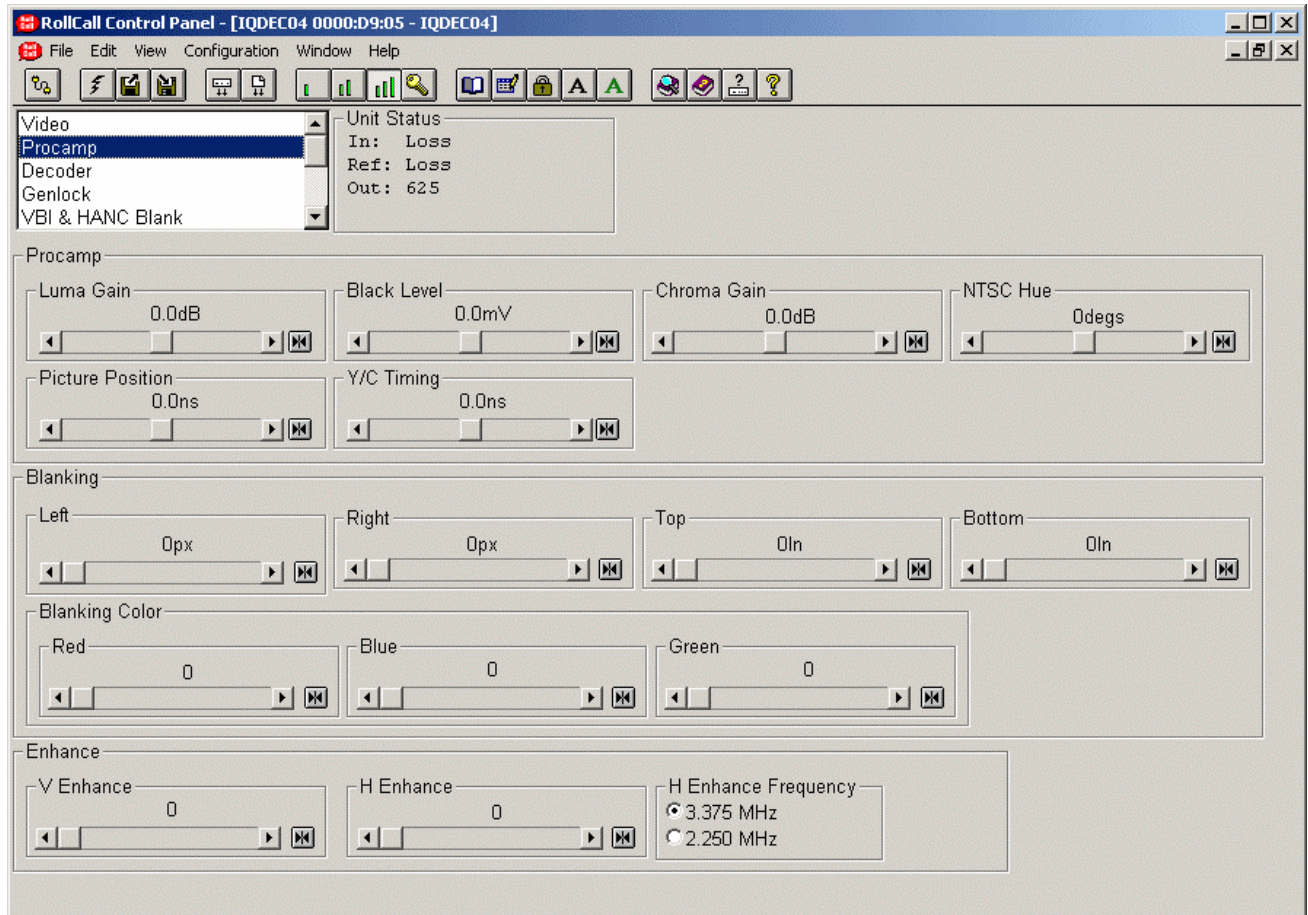

This control changes the amount of noise reduction for the chrominance by limiting the maximum level of noise reduction, where 31 is maximum and 0 is minimum. Preset is to 0. The actual level of noise reduction is dynamically adjusted on a pixel-by-pixel basis with regard to the noise reduction setting for the same pixel in the previous frame.

ProcAmp



These items allow various signal parameters to be adjusted.

Note that for this and other screens the following applies to the scroll bars:

The  and  symbols at the ends of the scroll bar allow the value to be adjusted in discrete steps.

The numerical value will be shown above the scroll bars and selecting Preset  will return the setting to the calibrated value for that item.

Luma Gain

This allows the Y (luminance) gain to be adjusted by ± 6 dB in steps of 0.1 dB. Preset value is 0.0 dB. *Note that the maximum input level is +3 dB.*

Black Level

This allows the black level to be adjusted by ± 120 mV in 0.5mV steps. Preset value is 0.

Chroma Gain

This allows the U/V (color difference) gain to be adjusted by ± 6 dB in steps of 0.1 dB. Preset value is 0.0 dB.

Note that the maximum input level is +3 dB.

NTSC Hue

This item allows the Hue of an NTSC signal to be adjusted.

The range of adjustment is ± 45 degrees. Preset is to 0 degrees.

Picture Position

This item allows the timing of the picture position relative to the normal value, to be adjusted.

The timing may be adjusted by ± 592 ns in 148ns steps. Preset value is 0.

Y/C Timing

This item allows the timing of the chrominance signal relative to the luminance signal to be adjusted, (i.e. Y to Cb/Cr timing) in nanoseconds. The timing may be adjusted by ± 592 ns in 148ns steps. Preset value is 0.

ProcAmp (continued)

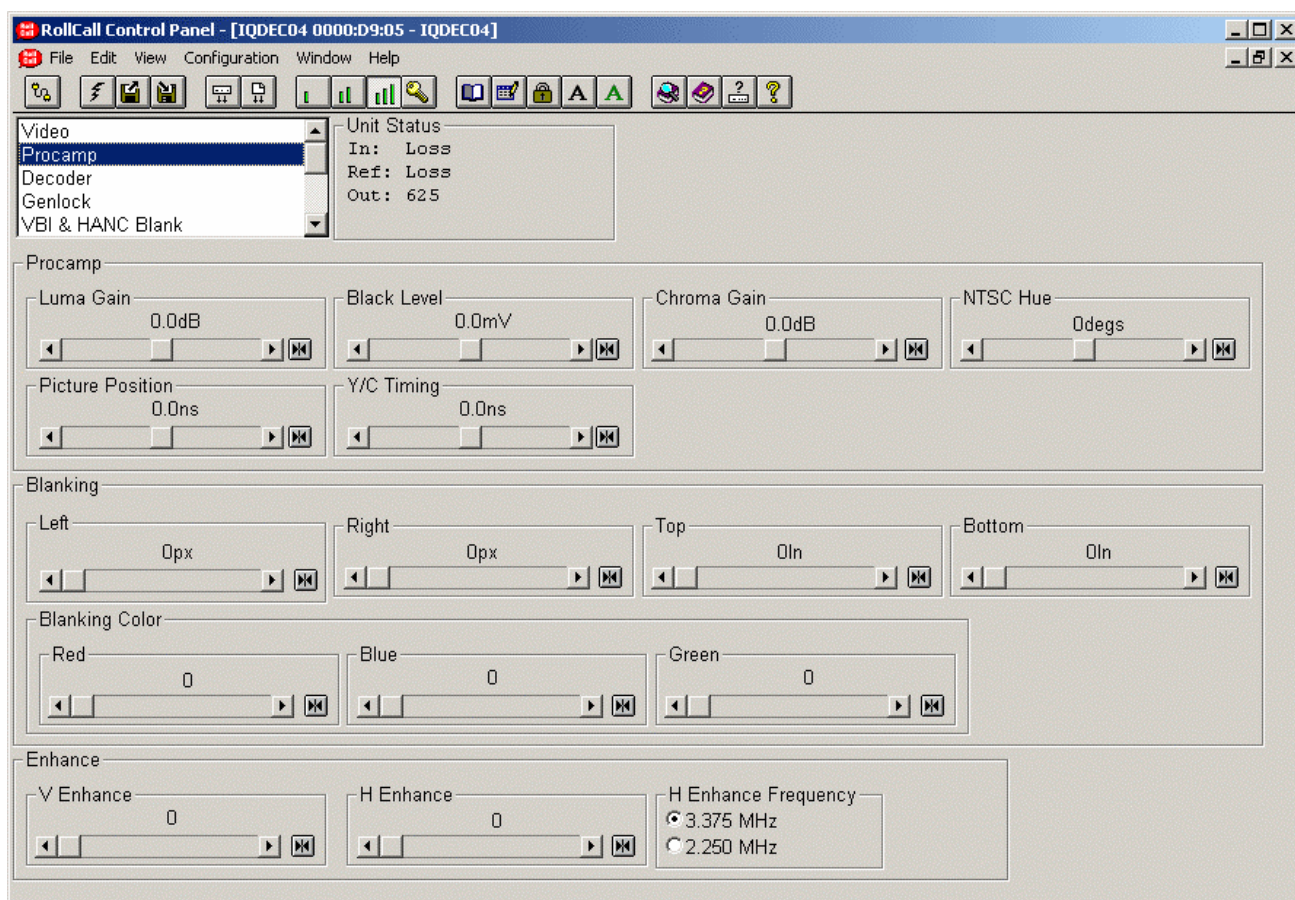
**Blanking**

This allows the active picture to be blanked out or cropped on each of the four sides.

Left/Right

The range of adjustment is from 0 to 200 pixels in steps of 2 pixels. Preset is to 0 pixels.

Top/Bottom

The range of adjustment is from 0 to 200 lines. Preset is to 0 lines.

The color of the blanked area may be set using the **Red**, **Blue** and **Green** controls. The range of adjustment is from 0 to 255 units. Preset is to 0, 0, 0 units (Black).

Enhance

This allows Vertical and Horizontal enhancement to be applied to the picture.

V Enhance

This allows vertical enhancement to be applied to the processed signal.

The level of enhancement may set to 0 (Off), 1 (Low), 2 (Medium) and 3 (High). Preset is to 0.

H Enhance

This allows Horizontal enhancement to be applied to the processed signal. The non-linear process prevents enhancement of low amplitude signals typical of noise.

The level of enhancement may set to 0 (Off), 1 (Low), 2 (Medium) and 3 (High). Preset is to 0.

H Enhance Frequency

The frequency at which the horizontal enhancement is applied may be set to either 3.375 MHz or 2.250 MHz. Preset is to 3.375 MHz.

Decoder

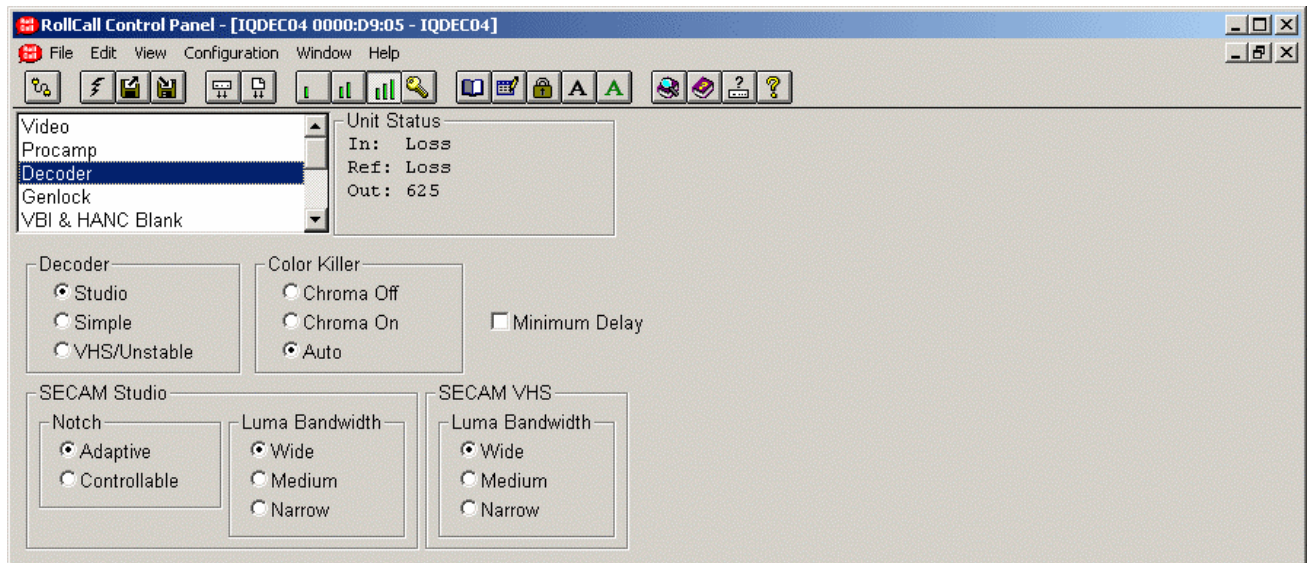

This screen allows the decoder functions to be set up.

Decoder

This allows the type of decoding to be selected.

Studio

This mode uses enhanced Golden Gate technology. The composite input is sampled with 12-bit resolution and decoded using adaptive line and frame comb filters to ensure optimum decoding performance.

Simple

This simple decode mode incorporates a wide bandwidth subcarrier notch filter. This mode is for reference only and should not be used for normal composite material.

VHS/Unstable

In this mode the decoder will cope with sources with unstable time-bases but the decoding is of a lower quality and the frequency response is reduced.

*Note that in this mode the decoder will automatically be set to **Minimum Delay** operation.*

Color Killer

This function controls the color content of the picture.

Chroma Off

When selected the color content of the picture will be removed. The luma signal is produced using a narrow bandwidth notch filter.

Chroma On

When selected the color content of the picture will be maintained regardless of the level of the color burst. Auto

When this item is enabled the picture will become monochrome if the input color burst disappears or the level drops below a critical amplitude. The picture will return to color when the burst level reappears.

Minimum Delay

This mode produces the minimum input/output delay and may be used where audio delay problems may exist and cannot be compensated for. It uses the same adaption technique as the Studio mode but has asymmetric frame stores.

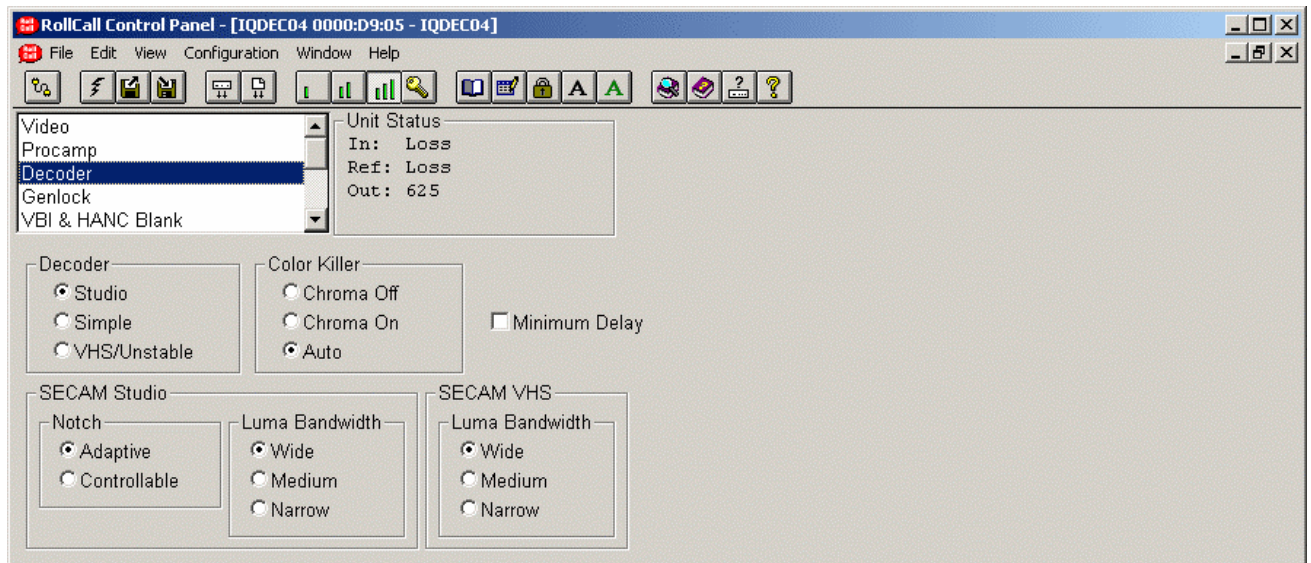
Decoder (continued)**SECAM Studio**

This function allows adjustments to decoding parameters for a SECAM signal of studio (stable) quality.

Notch

Either the Adaptive or the Controllable luminance notch filter may be enabled with this item.

Luma Bandwidth

This function allows the bandwidth of the decoded luminance to be adjusted.

Wide The signal will be processed at full bandwidth (3.4 MHz).

Medium The signal will be processed with a bandwidth of approximately 2.6 MHz.

Narrow The signal will be processed with a bandwidth of approximately 1.7 MHz.

SECAM VHS

This function allows adjustments to decoding parameters for a SECAM signal of VHS (unstable) quality.

Luma Bandwidth

This function allows the bandwidth of the decoded luminance to be adjusted.

Wide The signal will be processed at full bandwidth (3.4 MHz).

Medium The signal will be processed with a bandwidth of approximately 2.6 MHz.

Narrow The signal will be processed with a bandwidth of approximately 1.7 MHz.

Genlock

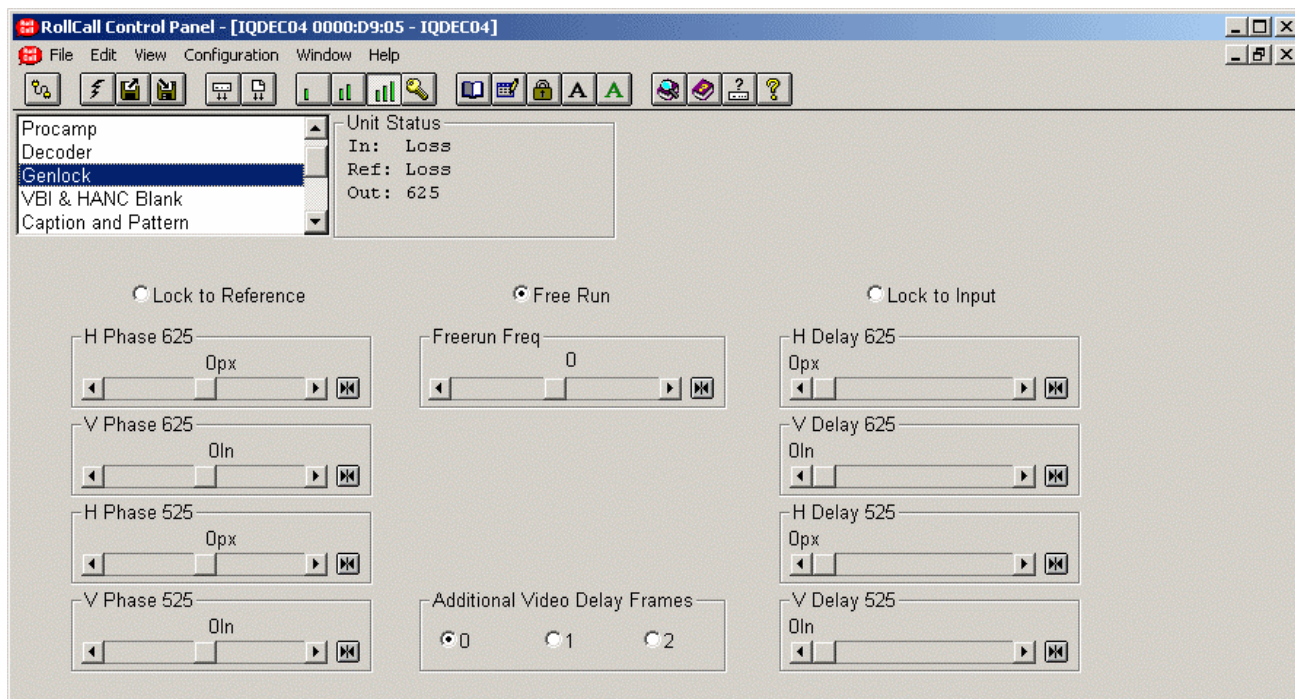

This allows the genlock and delay options to be selected.

Lock to Reference

When selected and the unit will lock to the external reference signal.

Free Run

When selected the unit will not be locked to any input signals and the unit will free run.

Lock to Input

When selected and the unit will lock to the input video signal.

Note that this selection is not available when the Decoder is set to the VHS/Unstable mode.

H(orizontal) Phase (625/525)

This item allows the horizontal timing of the output signal relative to the reference sync signal to be adjusted using the scrollbar by $\pm \frac{1}{2}$ line in 1 pixel steps.

Note that picture disturbance may occur while this setting is adjusted.

Selecting Preset returns the setting to zero. (Output coincident with reference)

V(ertical) Phase (625/525)

This item allows the vertical timing of the output signal relative to the reference sync signal to be adjusted, in TV lines. The scrollbar will adjust this value. Range is ± 262 lines (525 standard) or ± 312 lines (625 standard) in 1 line steps.

Note that picture disturbance may occur while this setting is adjusted.

Selecting Preset returns the setting to zero. (Output coincident with reference)

Freerun Freq(ueency)

This allows the freerun frequency of the internal sync generator to be adjusted in steps of arbitrary units. Preset is to 0.

Genlock (continued)

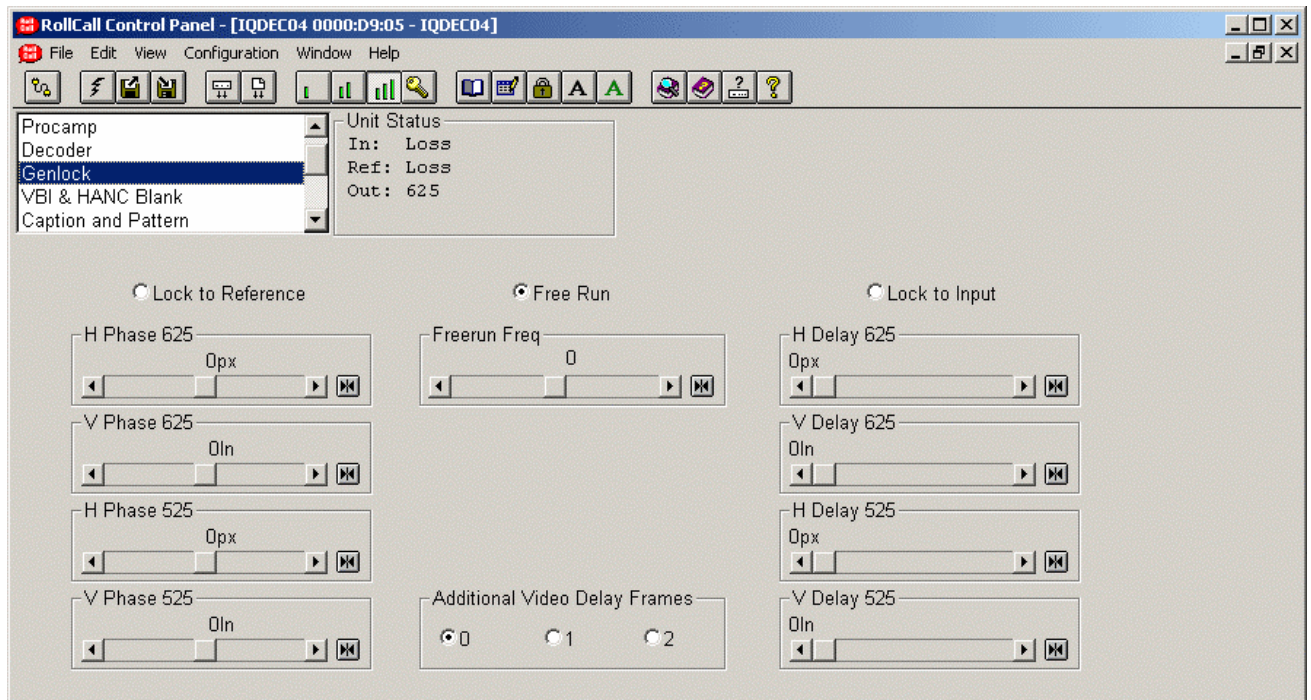
**Delay (625/525)**

When these controls are used the output signal will appear after the input signal with a time delay. When not used the module will operate in the synchronize mode.

*Note that the H and V delay functions are only active when the **Lock to Input** mode is selected.*

H(orizontal) Delay (625/525)

This item allows the horizontal timing of the output signal relative to the input signal to be adjusted by up to 1 line in 1 pixel steps. The scrollbar will adjust this value.

Selecting Preset returns the setting to the minimum horizontal delay.

V(ertical) Delay

This item allows the vertical timing of the output signal relative to the input signal to be adjusted, in TV lines. The scrollbar will adjust this value. Range is from 0 to 624 or 524 lines in 1 line steps.

Selecting Preset returns the setting to the minimum vertical delay.

Video Delay Frames

The number of frames that the output signal will appear after the input signal may be set with this item.

Note that this function is available in any genlock mode and will add to any other delay settings.

VBI & HANC Blank(ing)

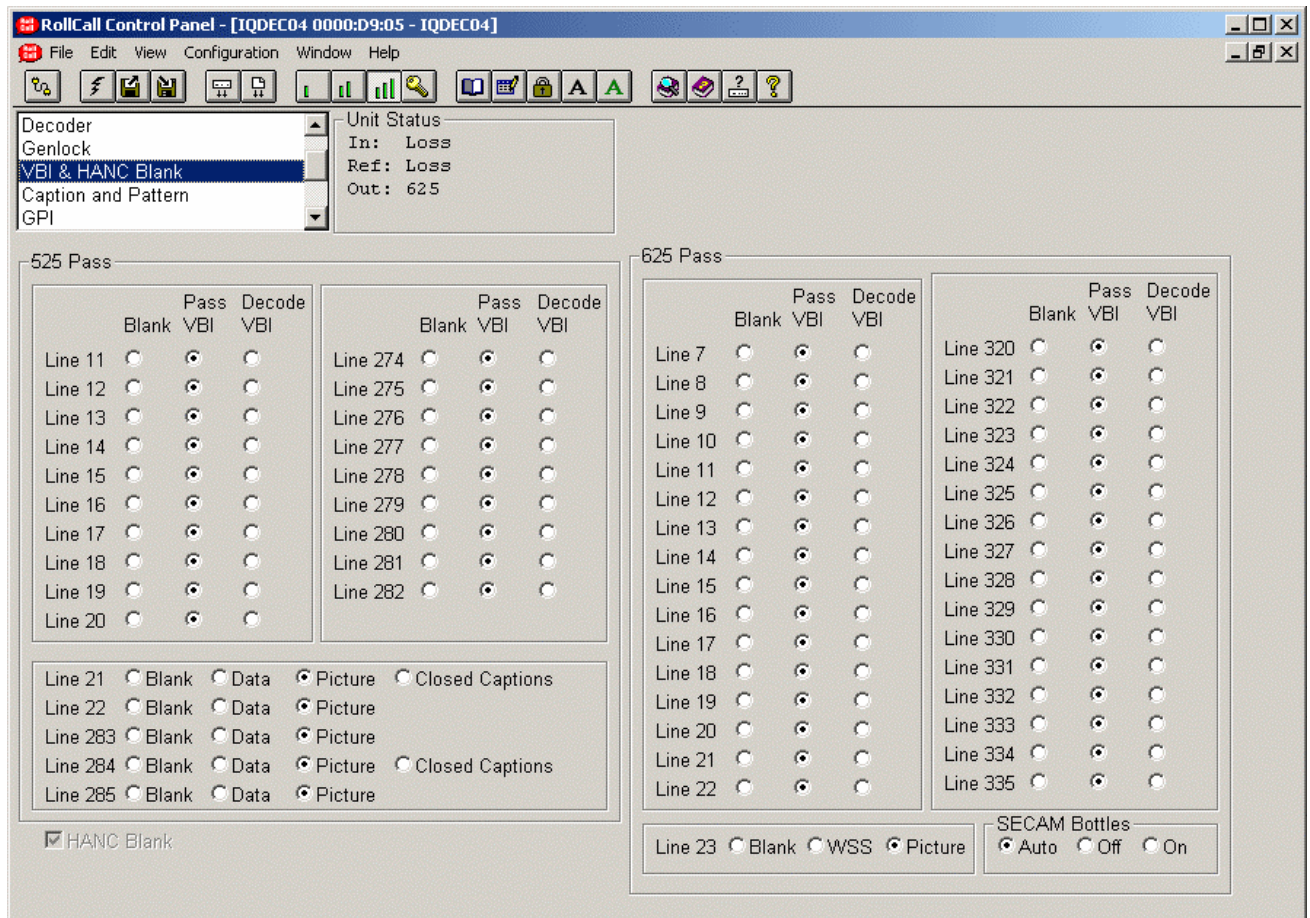

This item allows the selection of Vertical Interval lines contained in the input signal to be blanked or passed through the module as data or as a VITS.

Specific lines may be blanked, passed through as data, passed through as a picture (video), decoded or closed captions by checking the appropriate button.

Definitions:

- Blank** Line content is blanked by synchronizer
- Data** Line is processed by decoder as data, chroma is blanked, Closed Caption disabled.
- Pass as VBI** Line is decoded and chroma passed
- Picture** Line is processed by the decoder as video
- Decode VBI** The line is decoded and processed by the ProcAmp
- Closed Captions** Line is processed by decoder as data, chroma is blanked, Closed Caption enabled

Line 23

The options for this line are:

- Blank** Line content is blanked by synchronizer
- WSS** 1st half of line is processed as data, chroma blanked, 2nd half of line is processed as video
- Picture** 1st half of line is blanked by decoder, 2nd half of line is processed as video

HANC Blank

When checked all horizontal data will be blanked on the input.

When unchecked HANC will be passed uncorrupted. If the synchronizer is synchronizing then frames (including the HANC) might be dropped or repeated.

Note that the HANC Blank control will always be checked (and grayed out) if the audio embedders are enabled.

Caption & Pattern

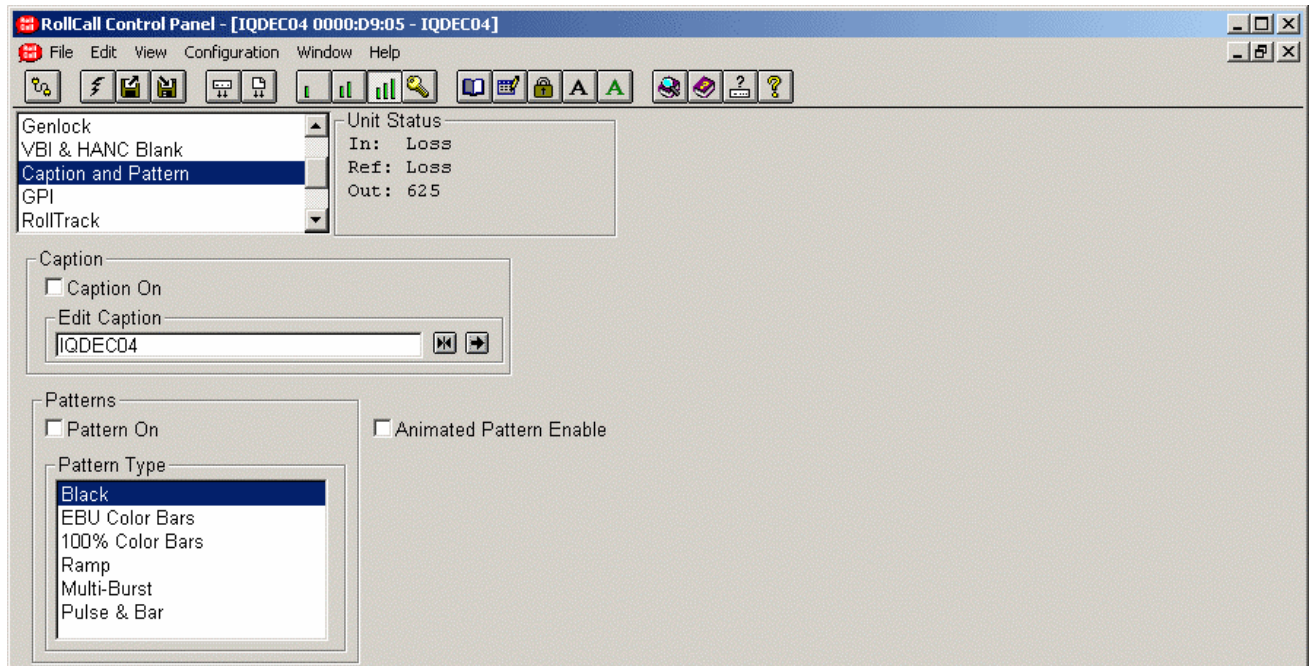

This function will allow a caption to be edited and selected and various patterns to be used as the output signal when the Pattern On function is selected.

Caption

This function allows control of the caption (white text on a black background) which may contain a maximum of 19 characters (including spaces).

The caption will appear in the lower section of the picture.

Edit caption

To change the caption, type the new text in the text area and then select  (return).

Selecting Preset  will return the text to the default text (IQDEC04).

Select Caption

- Caption Off The caption will not appear on the screen
- Caption On The caption will appear on screen



Caption Text

Caption & Pattern (continued)

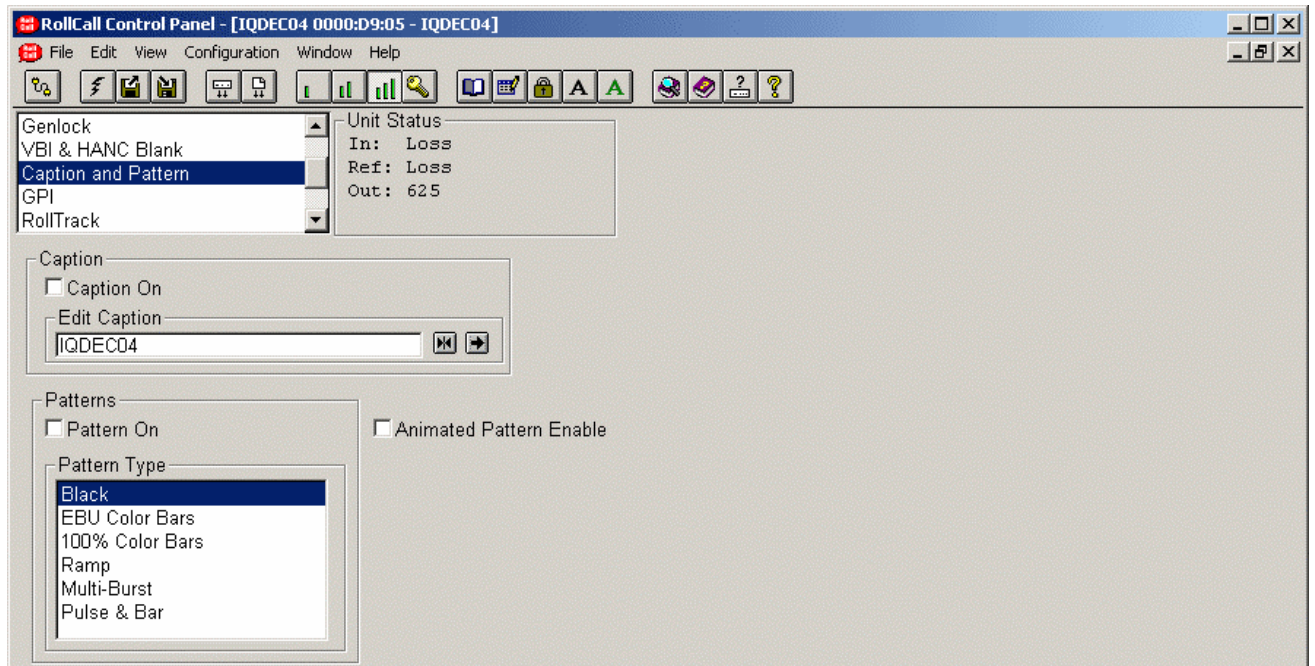

Patterns

Pattern On

When selected the output will become the pattern selected from the **Pattern Type** list.

Pattern Type

One of the patterns (including Black) may be selected from the list.

Animated Pattern

When selected, a monochrome rectangular area will appear on the output picture as shown opposite. The brightness of this rectangle will ramp from black, through gray to white and then directly to black over a period of about one second. This action will then be repeated continuously.

This pattern is useful for checking active video paths. Down stream equipment can see that video has not been frozen.

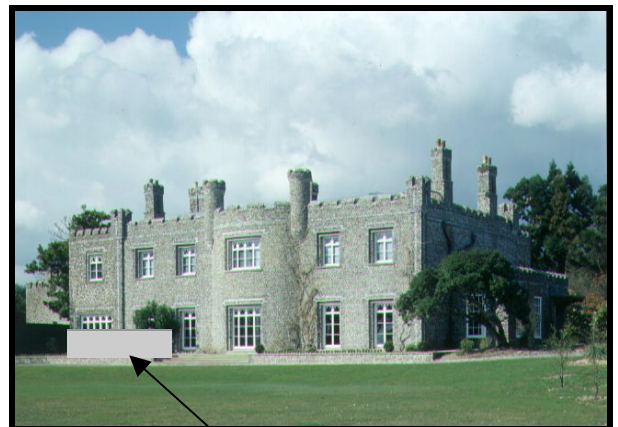

Animated Pattern

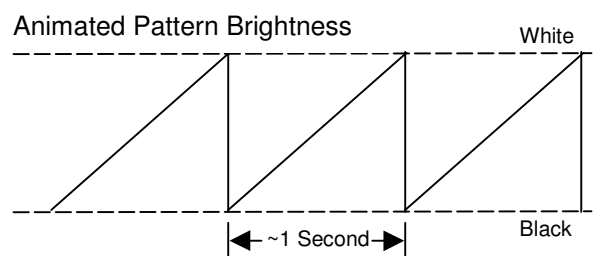

GPI

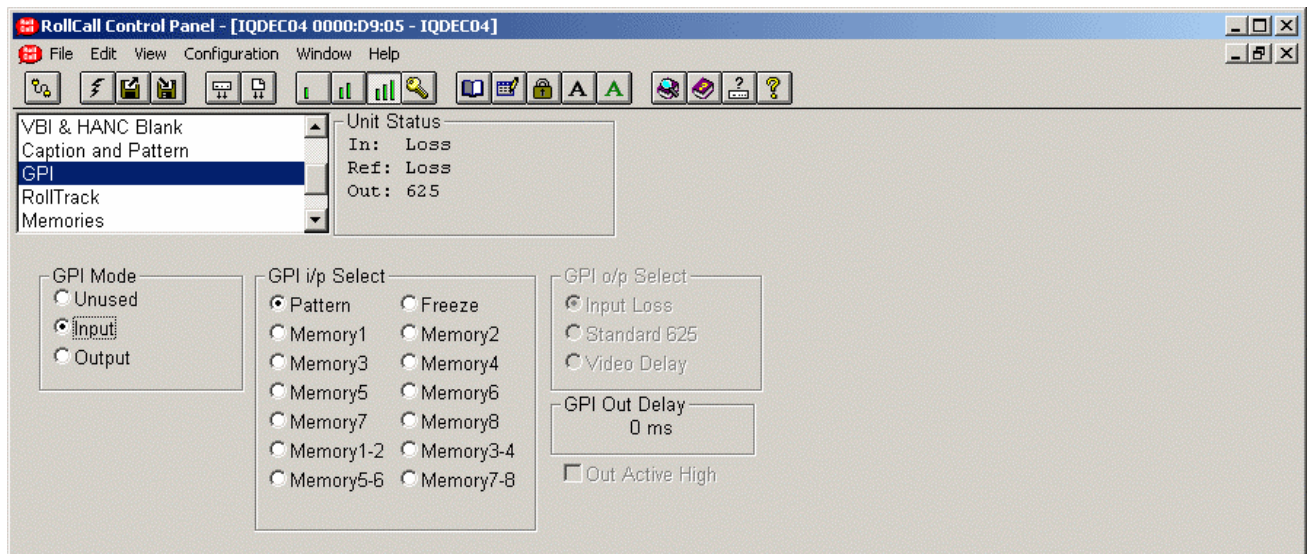

This screen allows the GPI functions to be configured and their actions defined.

GPI Mode

This allows the GPI port to be configured as an **Input**, an **Output** or **Unused**. If **Unused** is selected the **GPI i/p Select** and **GPI o/p Select** items will be grayed out.

GPI i/p Select

When configured as an input the GPI connection may be used for accepting GPI information (from mechanical switch contacts, relay contacts etc.) The resulting action that the unit takes may be selected using this item.

The GPI input functions that may be selected are as follows:

- | | |
|---------|--|
| Pattern | The unit will produce a pattern chosen from the Pattern menu when the input changes from open to closed. |
| Freeze | The output picture will become a frozen frame when the input changes from open to closed. |

Memory 1 to 8

The unit will use the settings in the selected memory location when the input changes from open to closed.

- | | |
|---------|--|
| Mem1-2 | The unit will toggle between the settings of memory locations 1 and 2.
Open to Closed = Memory 1 settings
Closed to Open = Memory 2 settings |
| Mem 3-4 | The unit will toggle between the settings of memory locations 3 and 4.
Open to Closed = Memory 3 settings
Closed to Open = Memory 4 settings |
| Mem 5-6 | The unit will toggle between the settings of memory locations 5 and 6.
Open to Closed = Memory 5 settings
Closed to Open = Memory 6 settings |
| Mem 7-8 | The unit will toggle between the settings of memory locations 7 and 8.
Open to Closed = Memory 7 settings
Closed to Open = Memory 8 settings |

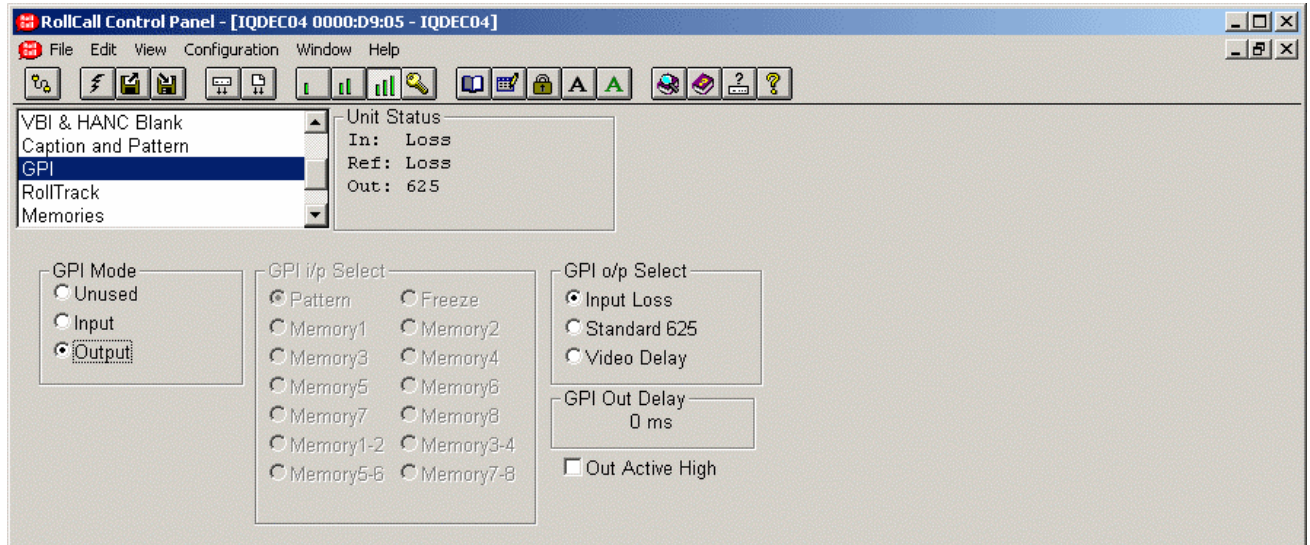
GPI (continued)**GPI o/p Select**

The GPIO may be configured to produce an output corresponding to one of the following conditions:

- Input Loss
- Standard 625
- Video Delay

The preset setting is to Input Loss.

When the condition is not true the output will float but when the condition is true the output is closed to ground via a transistor.

Note that when video delay is selected the output is a negative going TTL pulse. The width of the pulse represents the delay through the unit to the nearest millisecond.

GPI Out Delay

This will show the current video delay through the unit and hence the width of the GPI output TTL pulse.

Out Active High

This determines the sense of the GPI output signal. When checked the GPI is active high. When unchecked the GPI is active low.

Note this will also set the polarity of the TTL output signal.

RollTrack

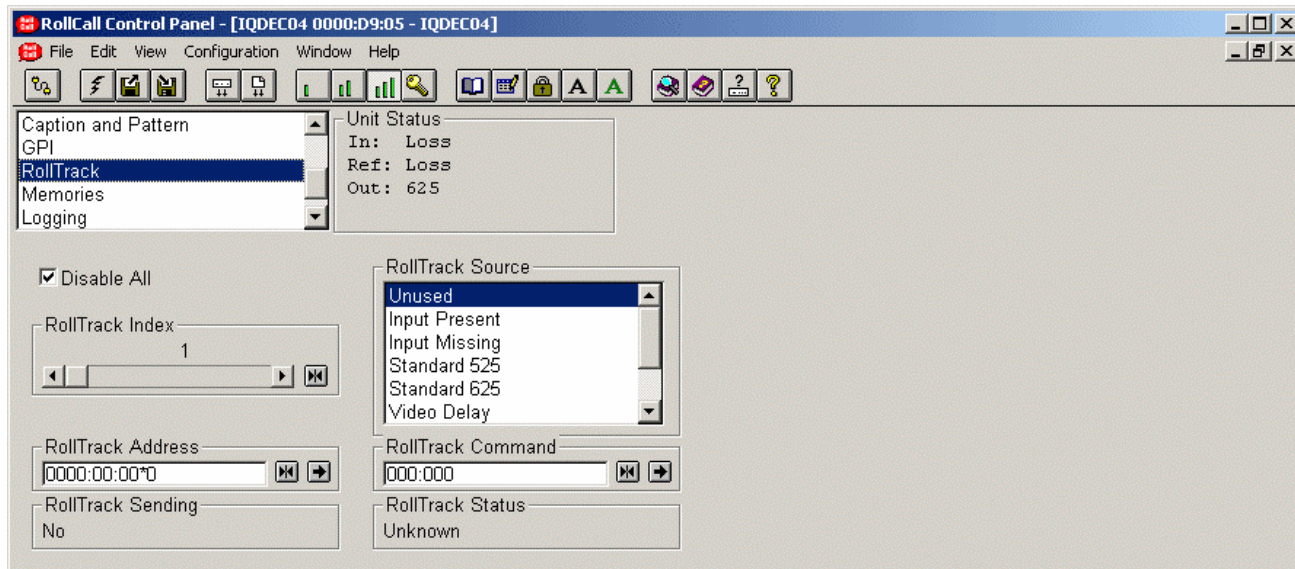

This function allows information to be sent, via the RollCall™ network, to other compatible units connected on the same network.

For example, it can enable compatible audio delay units to produce an audio delay dependent on this and other similar units. The audio delay unit will dynamically follow or track the received delay-time information. This allows processed video signals to be timed correctly with audio signals. This automatic tracking system via the RollCall™ network is call **RollTrack**.

For more detailed information, see the RollTrack section (Appendix) at the end of this manual.

RollTrack Index

This item allows up to 16 destinations to be selected.

RollTrack Source

This allows the source of information that triggers the transmission of data to be selected. Options are:

Unused
Input Present
Input Missing
Standard 525
Standard 625
Video Delay
Ref. Lost
Ref. Present
Ref. Error

The destination for the information is set by the network code address as follows:

Network Address

This item allows the address of the selected destination unit to be set.

To change the address, type the new destination in the text area and then select  (return).

 (Preset) returns to the default destination

The full **RollTrack** address has four sets of numbers

For example: 0000:10:01*99

The first set (0000) is the network segment code number

The second set (10) is the number identifying the (enclosure/mainframe) unit.

The third set (01) is the slot number in the unit

The fourth set (99) is a user settable number that is a unique identification number for the destination unit in a multi-unit system. This ensures that only the correct unit will respond to the command. If left at 00 an incorrectly fitted unit may respond inappropriately.

RollTrack (continued)

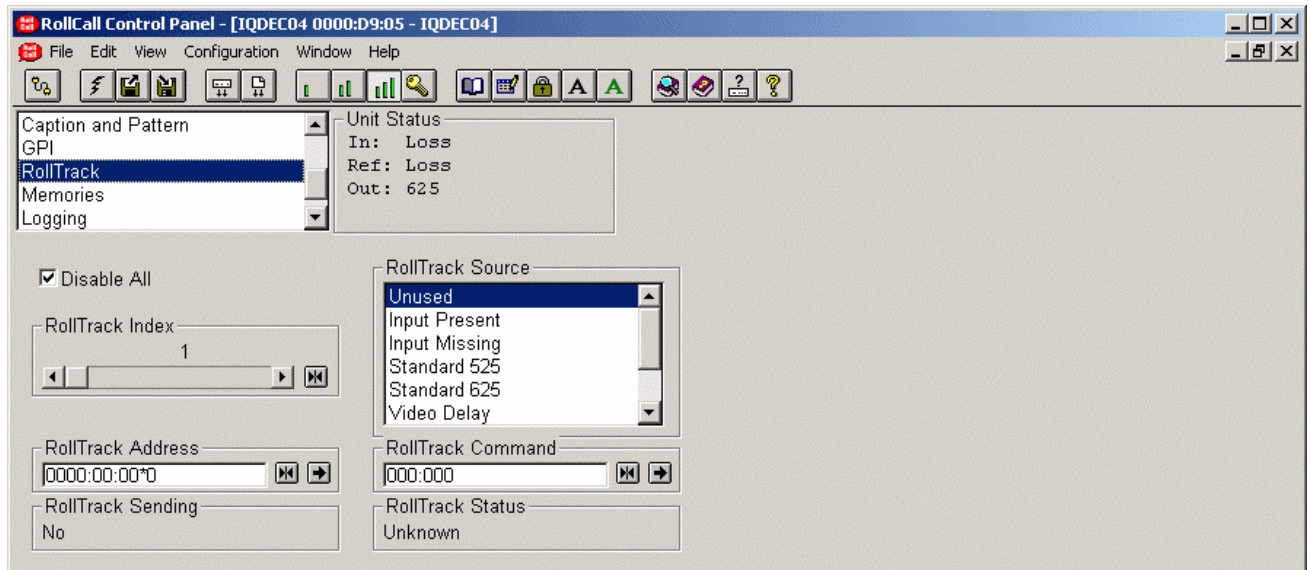

RollTrack Command

The full **RollTrack** command has two sets of numbers

For example: 84*156

The first set (84) is the **RollTrack** command number.

The second set (156) is the value sent with the **RollTrack** command number.

*Note that when video delay is selected as the **RollTrack** source the value sent with the **RollTrack** command is the video delay value not the value set.*

For details of the RollCall command values for specific units please contact your local Snell & Wilcox agent.

Disable All

When this item is checked all RollTrack items will be disabled.

RollTrack Sending

This item shows when the unit is actively sending the RollTrack command.

This may show:

- String A string value is always being sent.
- Number A number value is always being sent.
- No The message is not being sent.
- Yes The message is being sent.
- Internal Inconsistent behavior; please contact your local Snell & Wilcox agent.
- Type Error

RollTrack Status

This item will show the status of the currently selected RollTrack index.

This may show:

- OK RollTrack message sent and received OK.
- Unknown Rolltrack message has been sent but it has not yet completed.
- Timeout RollTrack message sent but acknowledgement not received. This could be because the destination unit is not at the location specified.
- Error This indicates a broken RollCall state.
- Bad This indicates a broken RollCall packet.

Memories

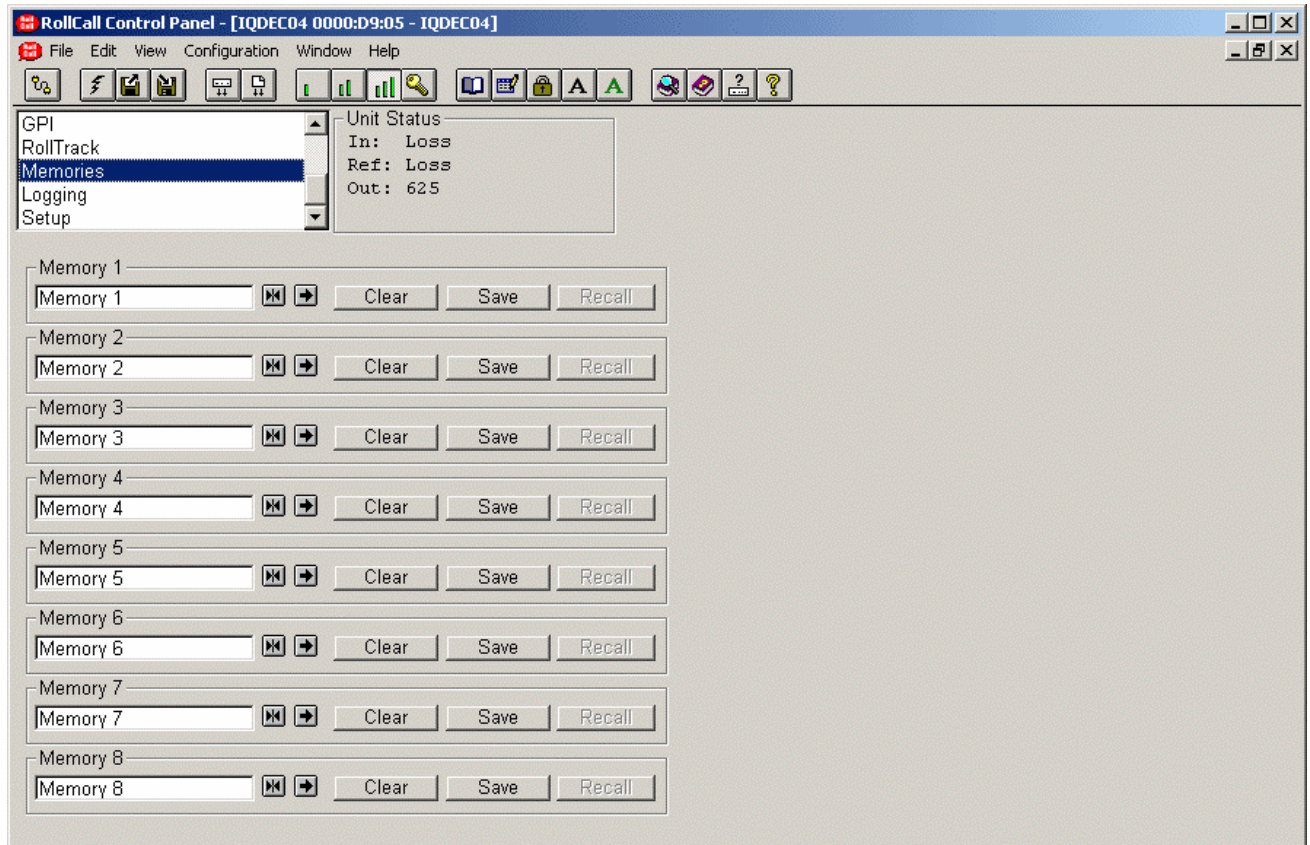

This function allows a number of particular setups of the unit to be saved and recalled. There are 8 memory locations available.

To change the memory name, type the new name in the text area and then select  (return).

Selecting Preset  will return the text to the default name.

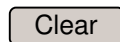

This function will clear the contents of the memory location.

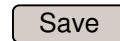

This function allows the settings of all items to be saved at the memory location.



This function allows the settings saved at the memory location to be recalled. When this button appears grayed out it indicates that the memory location is empty and therefore cannot be recalled.

Logging

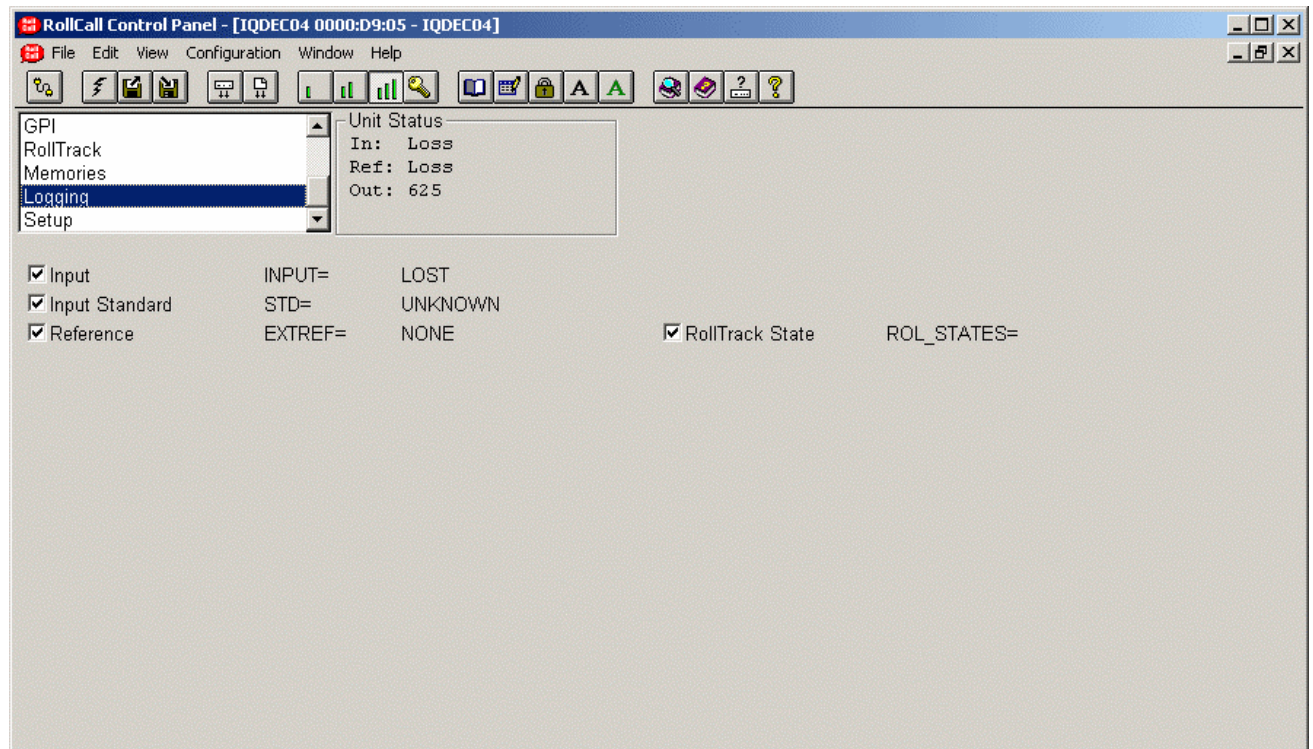

Information about various parameters can be made available to a logging device that is attached to the RollCall™ network by checking the appropriate box.

The status is shown to the right of the item.

Any of the items may be selected from the list.

ROLLCALL LOG FIELDS

(where applicable)

Log Field	Log Value	Description
INPUT=	OK ERR LOST	Valid input signal Invalid input signal Input signal lost
STD=	UNKNOWN STDERR 525 625 PAL NTSC NTSC_J PAL_M PAL_N SECAM N443_60 PAL443_60 ERROR: 525 ERROR: 625 ERROR: PAL ERROR: NTSC ERROR: NTSC_J ERROR: PAL_M ERROR: PAL_N ERROR: SECAM ERROR: N443_60 ERROR: PAL443_60	Input signal standard not recognized or no signal Not a selected input standard SDI input standard 525 SDI input standard 625 PAL composite input NTSC composite input NTSC J composite input PAL M composite input PAL N composite input SECAM composite input N4.43 60 composite input PAL4.43 60 composite input SDI input standard 525, 525 standard not valid SDI input standard 625, 625 standard not valid Composite input standard invalid, decoding as PAL Composite input standard invalid, decoding as NTSC Composite input standard invalid, decoding as NTSC J Composite input standard invalid, decoding as PAL M Composite input standard invalid, decoding as PAL N Composite input standard invalid, decoding as SECAM Composite input standard invalid, decoding as N4.43 60 Composite input standard invalid, decoding as PAL4.43 60
EXTREF=	525 625 ERROR: 525 ERROR: 625 WARNING: LOSS WARNING:525_N/A WARNING:625_N/A NONE	525 reference, input 525 or lost 625 reference, input 625 or lost 525 reference, input 625, trying to lock to reference 625 reference, input 525, trying to lock to reference Reference lost, trying to lock to reference 525 reference, input 625, not trying to lock to reference 625 reference, input 525, not trying to lock to reference Reference lost, not trying to lock to reference
ROL_STATES=	OK FAIL	RollTrack message sent and received OK RollTrack message not acknowledged
BUS_AL=	OK WARNING: SILENT WARNING: QUIET WARNING: HIGH WARNING: OVERLOAD	Router BUS A Left channel has valid signal selected Router BUS A Left channel is receiving silence Router BUS A Left channel is receiving low level signal Router BUS A Left channel is receiving high level signal Router BUS A Left channel is receiving overload signal
BUS_AR=	OK WARNING: SILENT WARNING: QUIET WARNING: HIGH WARNING: OVERLOAD	Router BUS A Right channel has valid signal selected Router BUS A Right channel is receiving silence Router BUS A Right channel is receiving low level signal Router BUS A Right channel is receiving high level signal Router BUS A Right channel is receiving overload signal
BUS_BL=	OK WARNING: SILENT WARNING: QUIET WARNING: HIGH WARNING: OVERLOAD	Router BUS B Left channel has valid signal selected Router BUS B Left channel is receiving silence Router BUS B Left channel is receiving low level signal Router BUS B Left channel is receiving high level signal Router BUS B Left channel is receiving overload signal
BUS_BR=	OK WARNING: SILENT WARNING: QUIET WARNING: HIGH WARNING: OVERLOAD	Router BUS B Right channel has valid signal selected Router BUS B Right channel is receiving silence Router BUS B Right channel is receiving low level signal Router BUS B Right channel is receiving high level signal Router BUS B Right channel is receiving overload signal
SN=	Runtime string	Serial number of unit

Setup

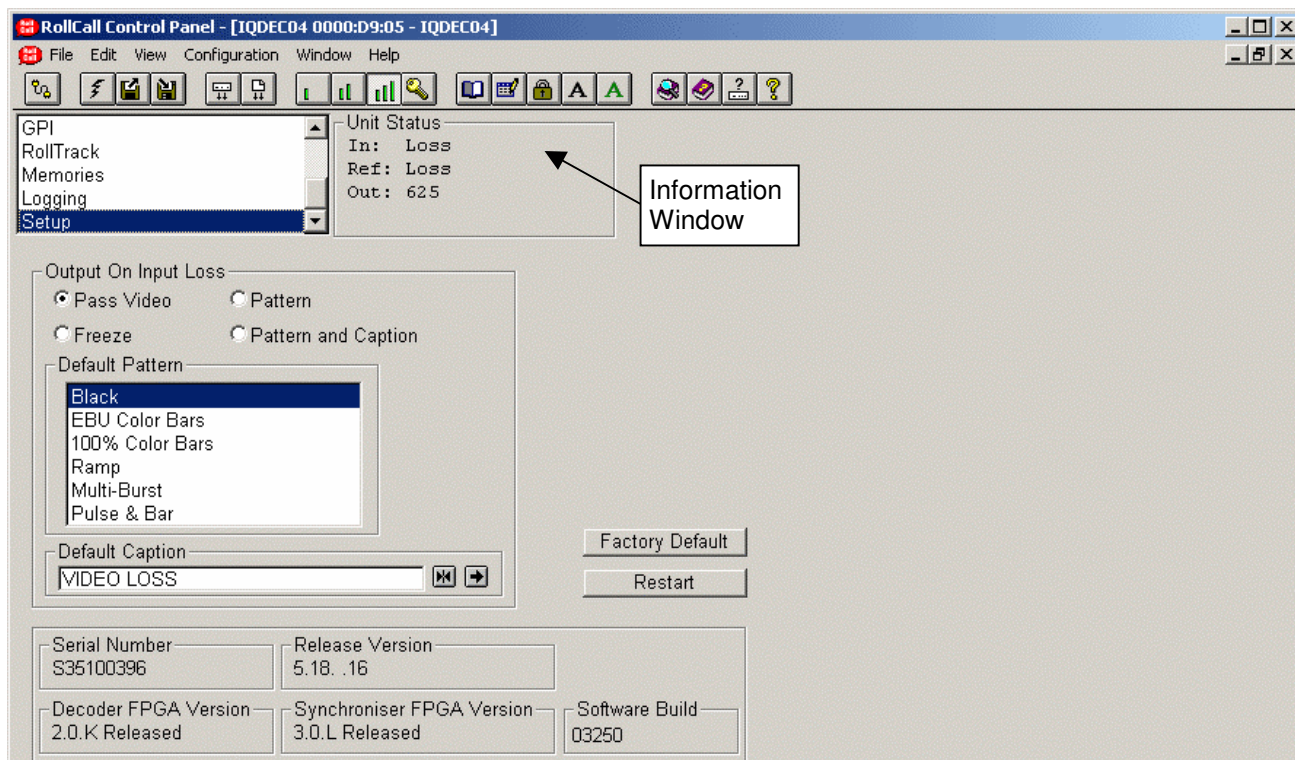

Information Window

This shows information about the status of the unit.

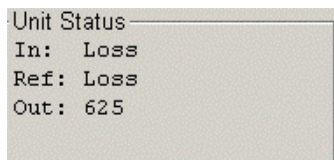

In: This shows the standard of the input and can show the color standard for composite inputs.

Ref: This will show the standard of the reference signal.

Out: This shows the standard of the output signal.

Output on Input Loss

If the input signal fails or is of poor quality this function will determine what the output signal will become under such conditions.

Pass Video The input signal will be passed to the output.

Freeze The output will become a frozen frame picture.

Pattern The output will become the pattern chosen from the **Default Pattern** list.

Pattern and Caption The output will become the pattern chosen from the **Default Pattern** list plus the **Default Caption**.

Default Pattern

If Pattern is chosen in the **Default Output** item the output will become the pattern chosen from this list.

Setup (continued)

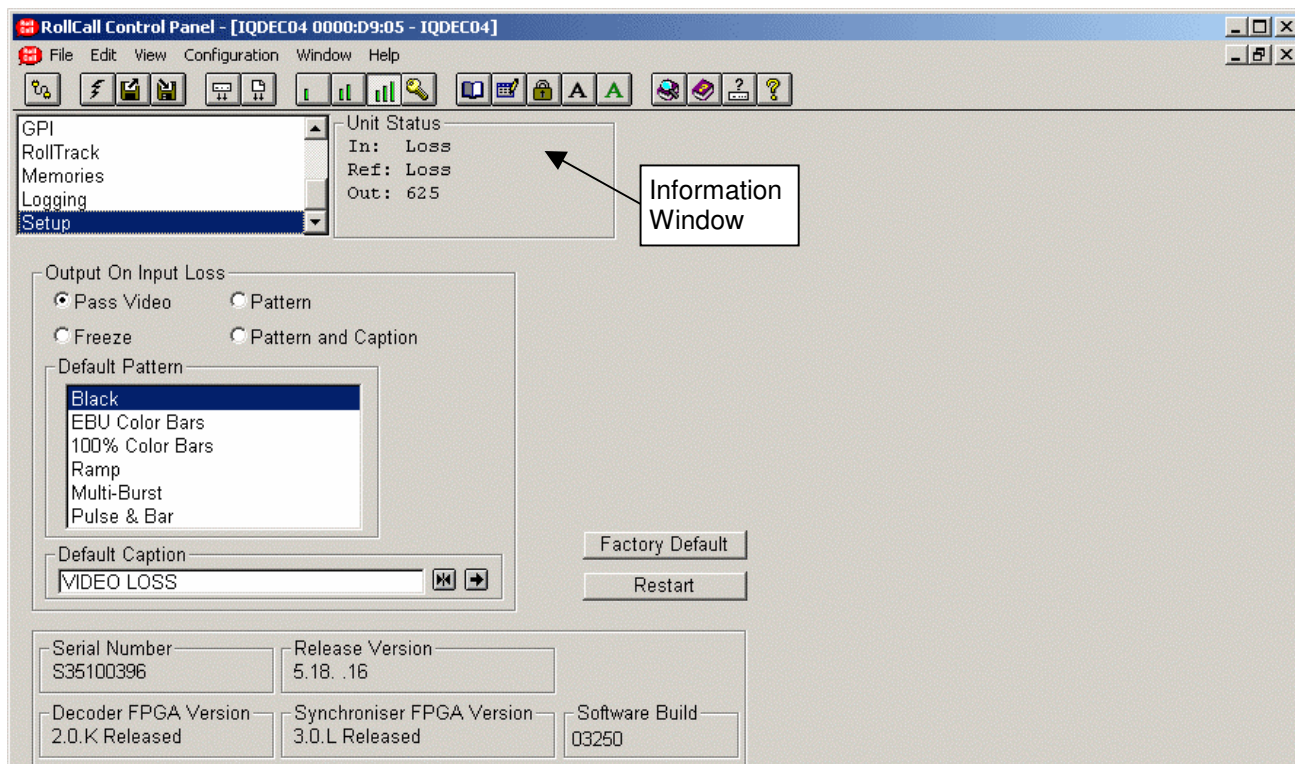
**Default Caption**

This is the caption that will appear if **Pattern and Caption** is chosen from the **Output on Input Loss** function.

To change the caption, type the new text in the text area and then select  (return).

Selecting Preset  will return the text to the default text (VIDEO LOSS).

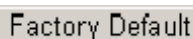

Selecting this item sets all adjustment functions that include a preset facility, to their factory default values.



This will reboot the unit simulating a power-down power-up cycle restoring power-up settings.

Serial Number

This item shows the serial number of the module

Release Version

This item shows the version of the software fitted in the module.

Software Build

This will indicate the factory build number. This number defines all parameters of the unit (software versions, build level etc.) for identification purposes.

Decoder FPGA Version

This will display the version number of the Decoder FPGA fitted to the unit.

Synchronizer FPGA Version

This will display the version number of the Synchronizer FPGA fitted to the unit.

Operation from an Active Control Panel

The card may be operated from an active control panel via the RollCall™ network.



All operational parameters and selections are made using a system of menus displayed in two LCD windows.

Operational details for the remote control panel can be found in the Modular System Operator's Manual.

Information Window

The Information window has four lines of text indicating the current state of the unit.

For details of the abbreviations used please see page 29.

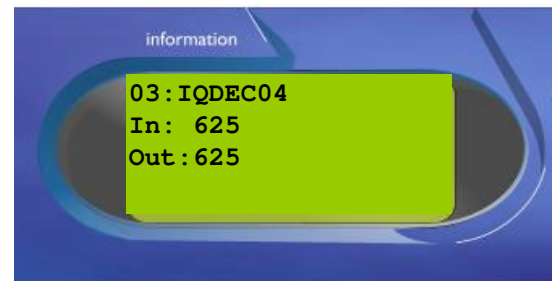

Control Window

The **Control** window displays all Selection Menus and sub-menus.

The selection is made by pressing the button adjacent to the required item.

The menu structure is detailed in the following pages.

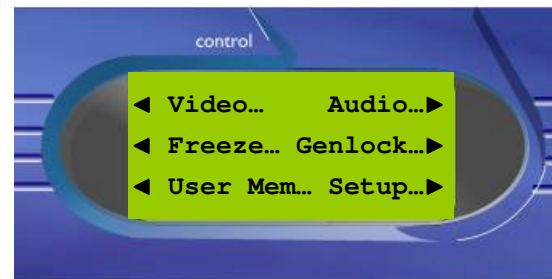

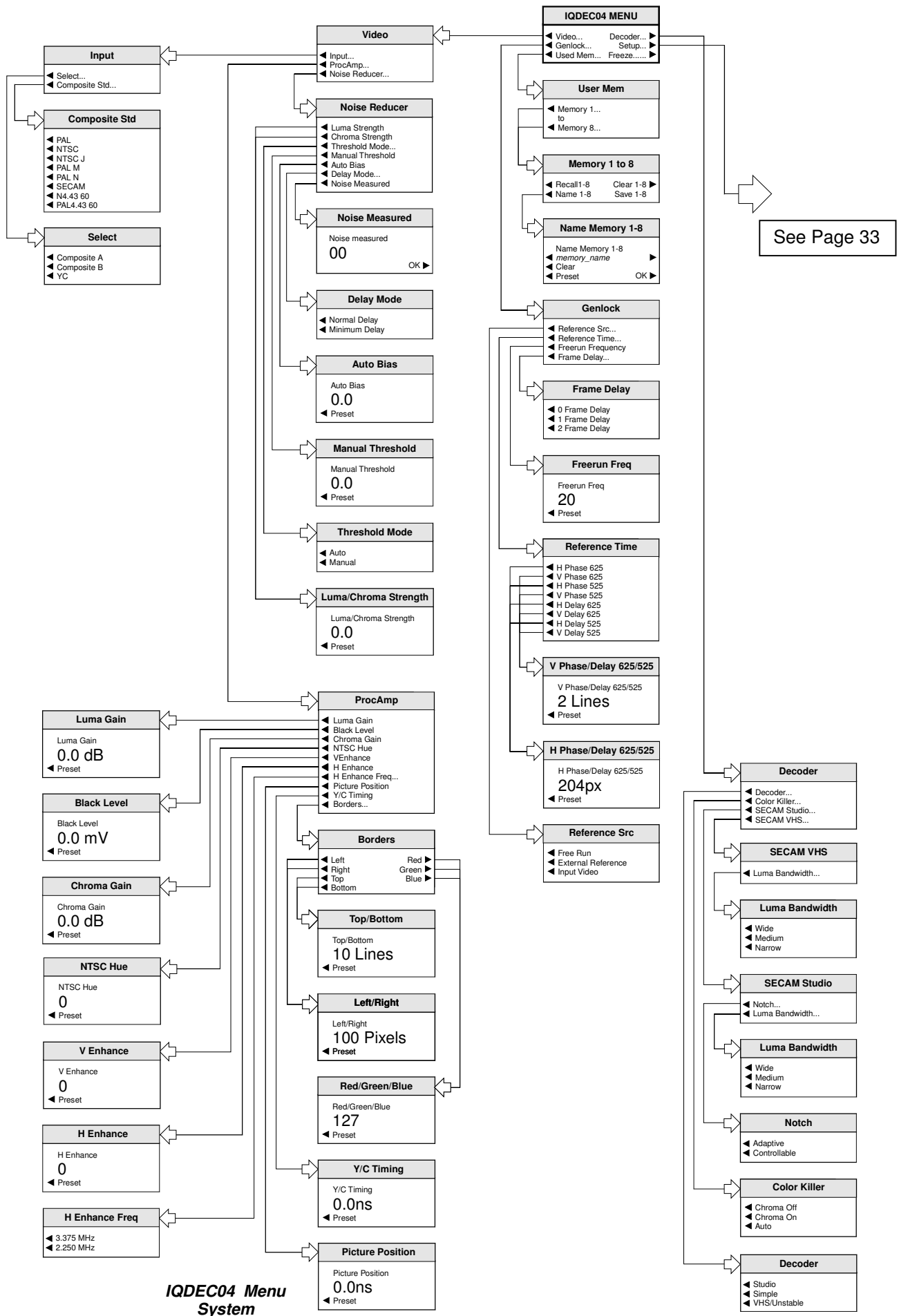

IQDEC04 Menu System

MENU DETAILS

(see IQDEC04 Menu System on previous pages)

MAIN MENU

The main or top level menu allows various sub-menus to be selected by pressing the button adjacent to the required text line.

Note that where a menu item is followed by three dots (...) this indicates that a further sub-menu may be selected.

Whenever a menu item is selected the parameters of that selection will be displayed in the Information window of the front panel. Where the selection is purely a mode selection and does not enable a sub-menu, the text will become reversed (white-on-black) indicating that the mode is active. If the mode is not available for selection the text will remain normal.

Also refer to the block diagram on page 4 for more information.

MAIN MENU

IQDEC04 MENU	
◀ Video...	Decoder... ▶
◀ Genlock...	Setup... ▶
◀ Used Mem...	Freeze..... ▶

Video

This item allows the input signal to be selected and adjustments to be made.

Video
◀ Input...
◀ ProcAmp...
◀ Noise Reducer...

Input

This item allows the input signal and its standard to be selected.

Input
◀ Select...
◀ Composite Std...

Select

This allows either the **Composite A, Composite B or YC** input to be selected for processing.

Select
◀ Composite A
◀ Composite B
◀ YC

Composite Standard

This allows the automatic detection of the color standard(s) for the composite and Y/C input.

Composite Std
◀ PAL
◀ NTSC
◀ NTSC J
◀ PAL M
◀ PAL N
◀ SECAM
◀ N4.43 60
◀ PAL4.43 60

The module will automatically detect any of the color standards that have been selected.

Note that when selecting and deselecting SECAM the output picture may suffer some disruption.

ProcAmp

These items allow signal levels and timings to be adjusted.

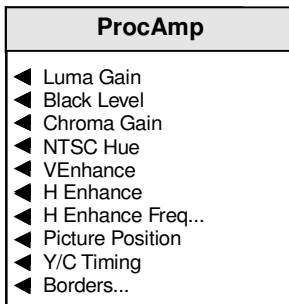

All the values below may be adjusted using the spinwheel.

Luma Gain

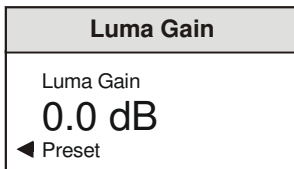

This allows the Y (luminance) gain to be adjusted by ± 6 dB in steps of 0.1 dB. Preset value is 0.0 dB. *Note that the maximum input level is +3 dB.*

Black Level

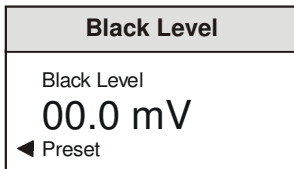

This allows the black level to be adjusted by ± 120 mV in 0.5 mV steps. Preset value is 0.

Chroma Gain

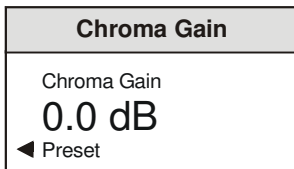

This allows the U/V (color difference) gain to be adjusted by ± 6 dB in steps of 0.1 dB. Preset value is 0.0 dB. *Note that the maximum input level is +3 dB.*

NTSC Hue

This item allows the Hue of an NTSC signal to be adjusted.

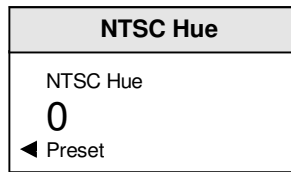

The range of adjustment is ± 45 degrees. Preset is to 0 degrees.

V Enhance

This allows vertical enhancement to be applied to the processed signal.

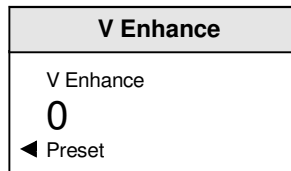

The level of enhancement may set to 0 (Off), 1 (Low), 2 (Medium) and 3 (High). Preset is to 0.

H Enhance

This allows Horizontal enhancement to be applied to the processed signal. The non-linear process prevents enhancement of low amplitude signals typical of noise.

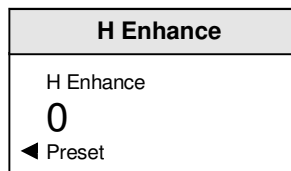

The level of enhancement may set to 0 (Off), 1 (Low), 2 (Medium) and 3 (High). Preset is to 0.

H Enhance Frequency

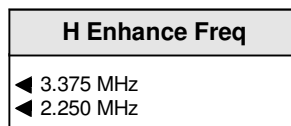

The frequency at which the horizontal enhancement is applied may be set to either 3.375 MHz or 2.250 MHz. Preset is to 3.375 MHz.

Picture Position

Picture Position	
Picture Position	
0ns	
◀ Preset	

This item allows the timing of the picture position relative to the normal value, to be adjusted. The timing may be adjusted by ± 592 ns in 148ns steps.

Y/C Timing

Y/C Timing	
Y/C Timing	
0ns	
◀ Preset	

This item allows the timing of the chrominance signal relative to the luminance signal to be adjusted, (i.e. Y to Cb/Cr timing) in nanoseconds. The timing may be adjusted by ± 592 ns in 148ns steps.

Borders

This allows the active picture to be blanked out or cropped on each of the four sides.

Borders	
◀ Left	Red ▶
◀ Right	Green ▶
◀ Top	Blue ▶
◀ Bottom	

Left/Right

Left/Right	
Left/Right	
100 Pixels	
◀ Preset	

The range of adjustment is from 0 to 200 pixels in steps of 2 pixels. Preset is to 0 pixels.

Top/Bottom

Top/Bottom	
Top/Bottom	
10 Lines	
◀ Preset	

The range of adjustment is from 0 to 200 lines. Preset is to 0 lines.

Red/Green/Blue

The color of the blanked area may be set using the **Red**, **Blue** and **Green** controls

Red/Green/Blue	
Red/Green/Blue	
127	
◀ Preset	

The range of adjustment is from 0 to 255 units. Preset is to 0, 0, 0 units (Black).

Noise Reducer

This allows settings and adjustments to be made to the noise reducer.

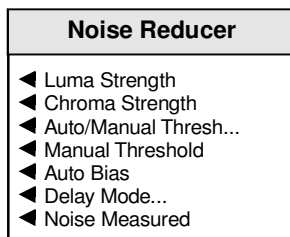

Luma Strength and Chrome Strength

These controls changes the amount of noise reduction for the luminance/chrominance by limiting the maximum level of noise reduction, where 31 is maximum and 0 is minimum. Preset is to 0.

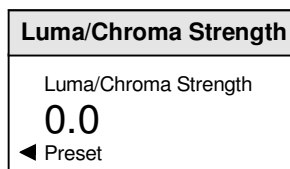

The actual level of noise reduction is dynamically adjusted on a pixel-by-pixel basis with regard to the noise reduction setting for the same pixel in the previous frame.

Auto/Manual (Noise) Threshold

The noise floor may be adjusted automatically or manually using the **Manual Threshold** control.

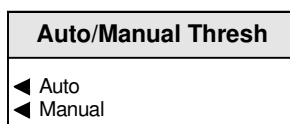

Auto

In this mode the noise floor is automatically measured and the threshold is adjusted dynamically set to an appropriate value for the current input noise level.

The noise detection algorithm may be given a subjective bias using the **Auto (Threshold) Bias** control to give more or less noise reduction.

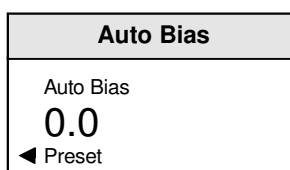

Modification of the bias should not be necessary under normal circumstances.

Manual

In this mode the noise floor may be adjusted manually using the **Manual (Noise) Threshold** control.

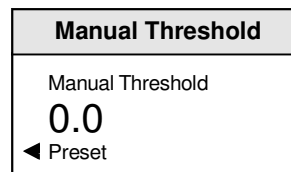

Delay Mode

This allows the delay of the noise reducer to be selected.

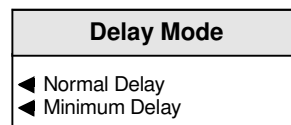

Normal

In this mode the delay will be < 1 Frame

Minimum

This mode produces the minimum input/output delay and may be used where audio delay problems may exist and cannot be compensated for. In this mode the delay will be < 3 Lines

Noise Measured

This provides an indication (as a percentage) of how much noise there is in the signal.

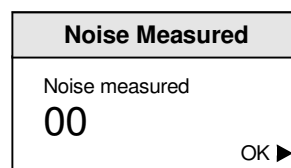

A clean signal will give low figures and a noisy signal high figures.

Decoder...

This menu allows the decoder functions to be set up.

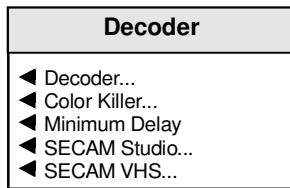

Decoder

This allows the type of decoding to be selected.

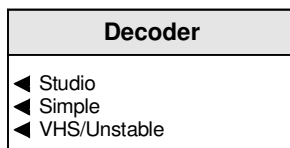

Studio

This mode uses enhanced Golden Gate technology. The composite input is sampled with 12-bit resolution and decoded using adaptive line and frame comb filters to ensure optimum decoding performance.

Simple

This simple decode mode incorporates a wide bandwidth subcarrier notch filter. This mode is for reference only and should not be used for normal composite material.

VHS/Unstable

In this mode the decoder will cope with sources with unstable time-bases but the decoding is of a lower quality and the frequency response is reduced.

*Note that in this mode the decoder will automatically be set to **Minimum Delay** operation.*

Color Killer

This function controls the color content of the picture.

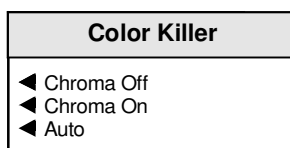

Chroma Off

When selected the color content of the picture will be removed. The luma signal is produced using a narrow bandwidth notch filter.

Chroma On

When selected the color content of the picture will be maintained regardless of the level of the color burst.

Auto

When this item is enabled the picture will become monochrome if the input color burst disappears or the level drops below a critical amplitude. The picture will return to color when the burst level reappears.

Minimum Delay

This mode produces the minimum input/output delay and may be used where audio delay problems may exist and cannot be compensated for. It uses the same adaption technique as the Studio mode but has asymmetric frame stores.

SECAM Studio

This function allows adjustments to decoding parameters for a SECAM signal of studio (stable) quality.

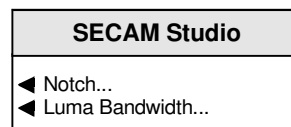

Notch

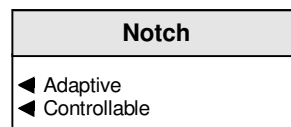

Either the Adaptive or the Controllable luminance notch filter may be enabled with this item.

Luma Bandwidth

This function allows the bandwidth of the decoded luminance to be adjusted.

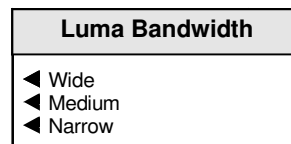

Wide The signal will be processed at full bandwidth (3.4 MHz).

Medium The signal will be processed with a bandwidth of approximately 2.6 MHz.

Narrow The signal will be processed with a bandwidth of approximately 1.7 MHz.

SECAM VHS

This function allows adjustments to decoding parameters for a SECAM signal of VHS (unstable) quality.



Luma Bandwidth

This function allows the bandwidth of the decoded luminance to be adjusted.

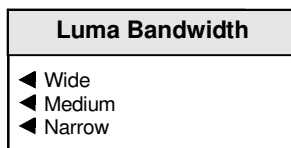

Wide The signal will be processed at full bandwidth (3.4 MHz).

Medium The signal will be processed with a bandwidth of approximately 2.6 MHz.

Narrow The signal will be processed with a bandwidth of approximately 1.7 MHz.

Genlock...

This allows the genlock and delay options to be selected.

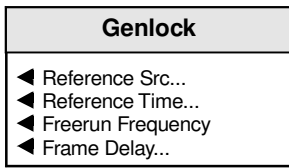

Reference Src (Source)

This allows the source of genlocking signal to be selected.

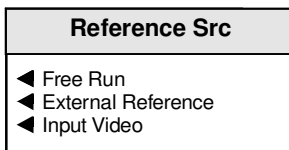

Free Run

When selected the unit will not be locked to any input signals and the unit will free run.

External Reference

When selected and the unit will lock to the external reference signal.

Input Video

When selected and the unit will lock to the input video signal.

Note that this selection is not available when the Decoder is set to the VHS/Unstable mode.

Reference Time(ing)

This item allows the timing of the output signal relative to the reference signal to be adjusted.

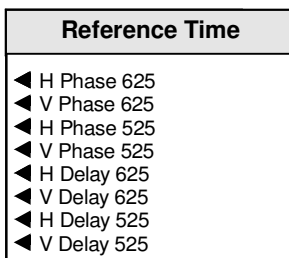

H(Horizontal) Phase 625/525

This item allows the horizontal timing of the output signal relative to the reference sync signal to be adjusted.

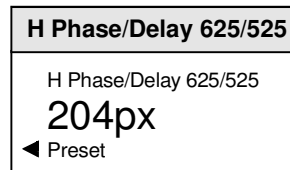

By using the spinwheel the phase may be adjusted by $\pm \frac{1}{2}$ line in 1 pixel steps.

Note that picture disturbance may occur while this setting is adjusted.

Selecting Preset returns the setting to zero. (Output coincident with reference)

V(Vertical) Phase 625/525

This item allows the vertical timing of the output signal relative to the reference sync signal to be adjusted, in TV lines.

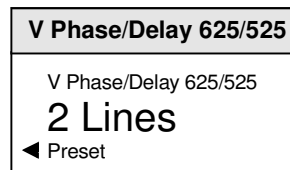

The spinwheel will adjust this value. Range is ± 262 lines (525 standard) or ± 312 lines (625 standard) in 1 line steps.

Note that picture disturbance may occur while this setting is adjusted.

Selecting Preset returns the setting to zero. (Output coincident with reference)

Freerun Frequency

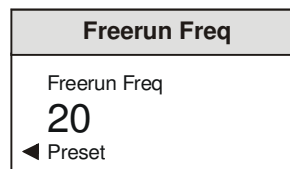

This allows the freerun frequency of the internal sync generator to be adjusted in steps of arbitrary units. Preset is to 0.

H and V Delay 525/625

When these controls are used the output signal will appear after the input signal with a time delay. When not used the module will operate in the synchronize mode.

*Note that the delay functions are only active when the **Lock to Input** mode is selected.*

H Delay 525/625

This item allows the horizontal timing of the output signal relative to the input signal to be adjusted.

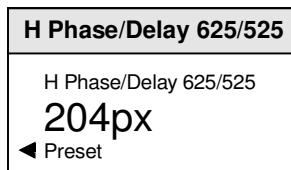

By using the spinwheel the delay may be adjusted by 1 line in 1 pixel steps.

Selecting Preset returns the setting to the minimum horizontal delay.

V(Vertical) Delay 625/525

This item allows the vertical timing of the output signal relative to the input signal to be adjusted, in TV lines.

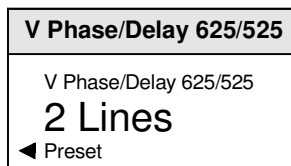

The spinwheel will adjust this value. Range is ± 262 lines (525 standard) or ± 312 lines (625 standard) in 1 line steps.

Selecting Preset returns the setting to the minimum vertical delay.

Frame Delay

0, 1, 2 Frame Delay

The number of frames that the output signal will appear after the input signal may be set with these items.

Note that this function is available in any genlock mode and will add to any other delay settings.

Setup...

This allows various functions to be setup.

Setup
◀ Pattern...
◀ Caption...
◀ VBI & HANC Blank...
◀ GPI I/O...
◀ RollTrack...
◀ Logging...
◀ Default Output..
◀ Software Version
◀ Serial Number
◀ Build Number
◀ FPGA Sync Version
◀ FPGA Dec Version
◀ Factory Default

Pattern

This function will allow various patterns to be used as the output signal.

Pattern
◀ Pattern Type
◀ Pattern Enable
◀ Animated Pattern

Pattern Type

This allows a pattern to be chosen as the output signal when **Pattern Enable** is selected.

Pattern Type
◀ Black
◀ EBU Color Bars
◀ 100% Color Bars
◀ Ramp
◀ Multi-burst
◀ Pulse & Bar

One of the patterns (including Black) may be selected from the list.

Pattern Enable

When selected the output will become the pattern selected from the **Pattern Type** list.

Animated Pattern

When selected, a monochrome rectangular area will appear on the output picture as shown opposite. The brightness of this rectangle will ramp from black, through gray to white and then directly to black over a period of about one second. This action will then be repeated continuously.

This pattern is useful for checking active video paths. Down stream equipment can see that video has not been frozen.

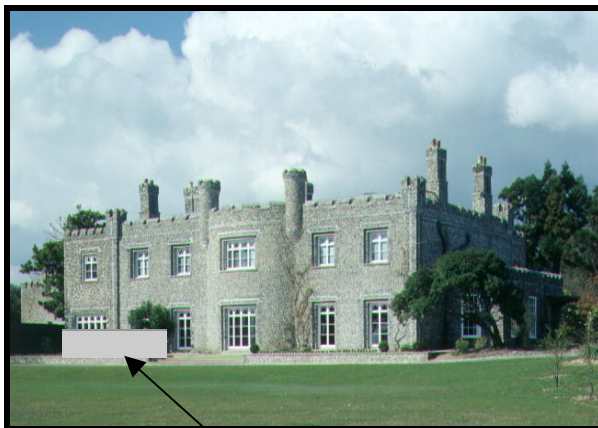

Animated Pattern

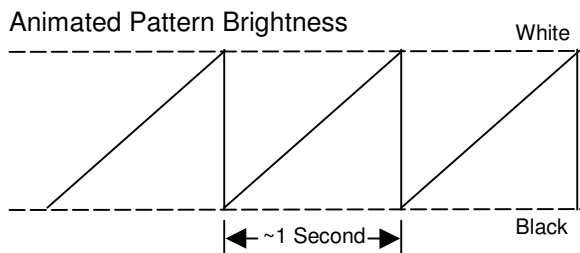

Caption

This function allows control of the caption which may contain a maximum of 19 characters (white text on a black background).

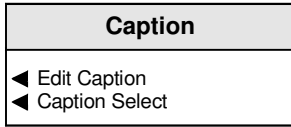

The caption will appear in the lower section of the picture.

Edit Caption

This allows a caption to be edited.

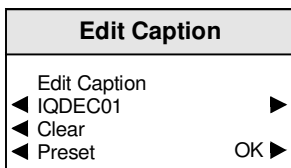

To compile/edit the text the right ► and left buttons adjacent to the upper text line in the menu should be used to select the character position in the text and the spinwheel used to select the character.

The **Clear** function blanks the selected character.

The **Preset** function loads the default text, for example, **IQDEC01**.

O.K. ► saves the memory name text and returns to the main menu.

Caption Select

This allows the caption to be turned on and off.

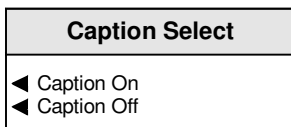

Caption On

When selected the caption will be turned on.

Caption Off

When selected the caption will be turned off.



Caption Text

VBI & HANC Blank(ing)

This menu allows the selection of Vertical Interval lines contained in the input signal to be blanked or passed through the module as data or as a VITS.

Specific lines may be blanked, passed through as data, VITS, passed through as a picture or closed captions by selecting the appropriate line.

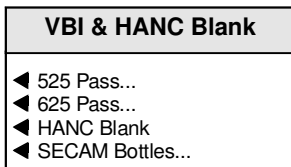

525 Pass

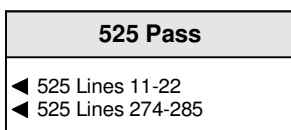

This item allows the selection of 525 standard Vertical Interval lines contained in the input signal to be blanked or passed through the module as data or as a VITS.

Specific lines may be blanked, passed through as data, passed through as a picture (video) or closed captions.

525 Lines 11-22

This allows the selection of lines in field 1.

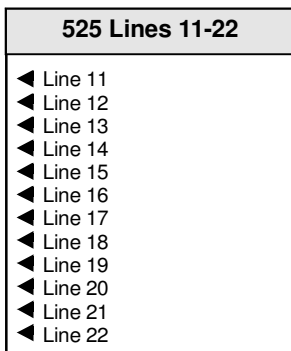

Lines 11-20

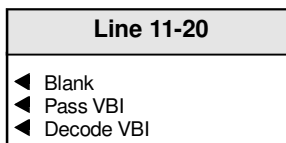

The options for these lines are:

- Blank Line content is blanked by synchronizer
- Pass as data Line is processed by decoder as data, chroma is blanked, Closed Caption disabled.
- Pass as VITS Line is decoded and chroma passed

Line 21

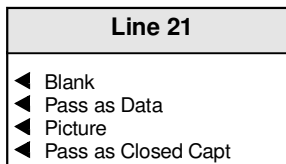

The options for this line are:

- Blank Line content is blanked by synchronizer
- Pass as data Line is processed by decoder as data, chroma is blanked, Closed Caption disabled.
- Picture Line is processed by the decoder as video
- Pass as Closed Caption Line is processed by decoder as data, chroma is blanked, Closed Caption enabled

Line 22

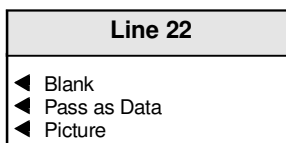

The options for this line is:

- Blank Line content is blanked by synchronizer
- Pass as data Line is processed by decoder as data, chroma is blanked, Closed Caption disabled.
- Picture Line is processed by the decoder as video

525 Lines 274-285

This allows the selection of lines in field 2.

525 Lines 274-285
◀ Line 274
◀ Line 275
◀ Line 276
◀ Line 277
◀ Line 278
◀ Line 279
◀ Line 280
◀ Line 281
◀ Line 282
◀ Line 283
◀ Line 284
◀ Line 285

Line 274-282

Line 274-282
◀ Blank
◀ Pass VBI
◀ Decode VBI

The options for these lines are:

- Blank Line content is blanked by synchronizer
- Pass as VITS Line is decoded and chroma passed
- Picture Line is processed by the decoder as video

Line 284

Line 284
◀ Blank
◀ Pass as Data
◀ Picture
◀ Pass as Closed Capt

The options for these lines are:

- Blank Line content is blanked by synchronizer
- Pass as data Line is processed by decoder as data, chroma is blanked, Closed Caption disabled.
- Picture Line is processed by the decoder as video
- Pass as Closed Caption Line is processed by decoder as data, chroma is blanked, Closed Caption enabled

Line 283 & 285

Line 283 & 285
◀ Blank
◀ Pass as Data
◀ Picture

The options for this line are:

- Blank Line content is blanked by synchronizer
- Pass as data Line is processed by decoder as data, chroma is blanked, Closed Caption disabled.
- Picture Line is processed by the decoder as video

625 Pass

625 Pass
◀ 625 Lines 7-23
◀ 625 Lines 320-335

This item allows the selection of 625 standard Vertical Interval lines contained in the input signal to be blanked or passed through the module as data or as a VITS.

Specific lines may be blanked, passed through as data, passed through as a picture (video) or closed captions.

625 Lines 7-23

This allows the selection of lines in field 1.

625 Lines 7-23
◀ Line 7...
◀ Line 8...
◀ Line 9...
◀ Line 10...
◀ Line 11...
◀ Line 12...
◀ Line 13...
◀ Line 14...
◀ Line 15...
◀ Line 16...
◀ Line 17...
◀ Line 18...
◀ Line 19...
◀ Line 20...
◀ Line 21...
◀ Line 22...
◀ Line 23...

Lines 7-22

Line 7-22
<input type="checkbox"/> Blank <input type="checkbox"/> Pass VBI <input type="checkbox"/> Decode VBI

The options for these lines are:

Blank	Line content is blanked by synchronizer
Pass VBI	Line is decoded and chroma
Decode VBI	The line is decoded and processed by the ProcAmp

Lines 320-335

Line 320-335
<input type="checkbox"/> Blank <input type="checkbox"/> Pass VBI <input type="checkbox"/> Decode VBI

The options for these lines are:

Blank	Line content is blanked by synchronizer
Pass VBI	Line is decoded and chroma
Decode VBI	The line is decoded and processed by the ProcAmp

Line 23

Line 23
<input type="checkbox"/> Blank <input type="checkbox"/> WSS <input type="checkbox"/> Picture

The options for this line are:

Blank	Line content is blanked by synchronizer
WSS	1st half of line is processed as data, chroma blanked, 2nd half of line is processed as video
Picture	1st half of line is blanked by decoder, 2nd half of line is processed as video

Hanc Blank

When checked all horizontal data will be blanked on the input.

When unchecked HANC will be passed uncorrupted. If the synchronizer is synchronizing then frames (including the HANC) might be dropped or repeated.

Note that the HANC Blank control will always be selected if the audio embedders are enabled.

625 Lines 320-335

This allows the selection of lines in field 2.

625 Lines 320-335
<input type="checkbox"/> Line 320...
<input type="checkbox"/> Line 321...
<input type="checkbox"/> Line 322...
<input type="checkbox"/> Line 323...
<input type="checkbox"/> Line 324...
<input type="checkbox"/> Line 325...
<input type="checkbox"/> Line 326...
<input type="checkbox"/> Line 327...
<input type="checkbox"/> Line 328...
<input type="checkbox"/> Line 329...
<input type="checkbox"/> Line 330...
<input type="checkbox"/> Line 331...
<input type="checkbox"/> Line 332...
<input type="checkbox"/> Line 333...
<input type="checkbox"/> Line 334...
<input type="checkbox"/> Line 335...

SECAM Bottles

This allows the processing of the Bottle lines to be selected.

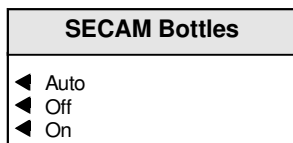

Auto

In this mode Bottles are automatically detected, a Bottle line is passed and will be correctly decoded.

Note that auto Bottle detection is not available in VHS mode.

Off

In this mode Bottle lines will not be detected.

On

In this mode a Bottle line is passed and will be correctly decoded.

GPI I/O

This function allows the GPI functions to be configured and their actions defined.

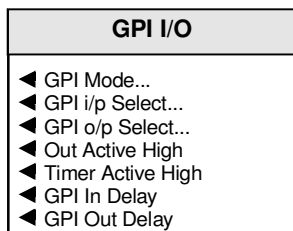

GPI Mode

This allows the GPI port to be configured.

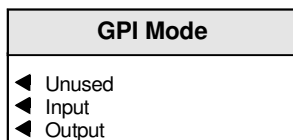

The options are:

- Unused ..The GPI port is disabled
- Input.....The port is configured as an Input
- Output....The port is configured as an Output

GPI i/p Select

When configured as an input the GPI connection may be used for accepting GPI information (from mechanical switch contacts, relay contacts etc.).

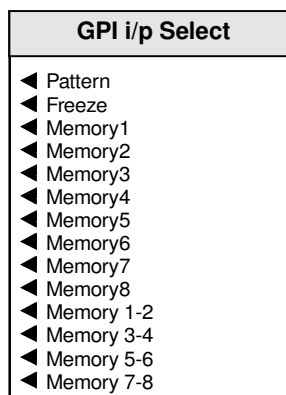

The resulting action that the unit takes may be selected using this item.

The GPI input functions that may be selected are as follows:

- Pattern** The unit will produce a pattern chosen from the Pattern menu when the input changes from open to closed.
- Freeze** The output picture will be frozen frame when the input changes from open to closed.
- Memory 1 to 8** The unit will use the settings in the selected memory location when the input changes from open to closed.
- Memory 1-2** The unit will toggle between the settings of memory locations 1 and 2.
Open to Closed = Memory 1 settings
Closed to Open = Memory 2 settings
- Memory 3-4** The unit will toggle between the settings of memory locations 3 and 4.
Open to Closed = Memory 3 settings
Closed to Open = Memory 4 settings
- Memory 5-6** The unit will toggle between the settings of memory locations 5 and 6.
Open to Closed = Memory 5 settings
Closed to Open = Memory 6 settings
- Memory 7-8** The unit will toggle between the settings of memory locations 7 and 8.
Open to Closed = Memory 7 settings
Closed to Open = Memory 8 settings

GPI o/p Select

This item allows the GPI output functions to be configured.

GPI o/p Select	
<input type="checkbox"/>	Input Present
<input type="checkbox"/>	Standard 625
<input type="checkbox"/>	Video Delay

The GPO may be configured to produce an output corresponding to one of the conditions highlighted in the list.

When the condition is not true the output will float but when the condition is true the output is closed to ground via a transistor.

Note that when video delay mode is selected the output is a negative going TTL pulse. The width of the pulse represents the video delay through the unit to the nearest millisecond.

Out Active High

When selected (highlighted) the GPI output is active high; when deselected the GPI output is active low.

Note this will also set the polarity of the TTL output signal.

Timer Active High

When checked the **GPI Delay** measurement will respond to a positive going pulse; when unchecked it will respond to a negative going pulse.

GPI In Delay

GPI In/Out Delay	
GPI In/Out Delay	
5.5ms	
	OK ►

If the GPI port is receiving a pulse input this will show the length of the pulse in milliseconds.

GPI Out Delay

GPI In/Out Delay	
GPI In/Out Delay	
5.5ms	
	OK ►

This will show the current video delay through the unit and hence the width of the GPI output TTL pulse.

RollTrack

This function allows information to be sent, via the RollCall™ network, to other compatible units connected on the same network.

For example, it can enable compatible audio delay units to produce an audio delay dependent on this and other similar units. The audio delay unit will dynamically follow or track the received delay-time information. This allows processed video signals to be timed correctly with audio signals. This automatic tracking system via the RollCall™ network is call **RollTrack**.

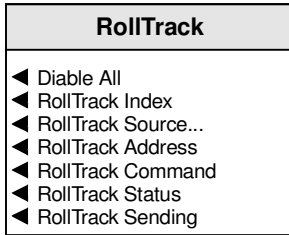

For more detailed information, see the RollTrack section (Appendix) at the end of this manual.

RollTrack Index

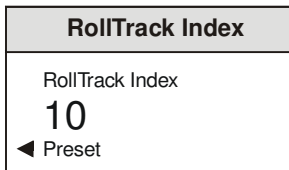

This item is used to select which RollTrack Index is set up using the RollTrack Source, RollTrack Address and RollTrack Command functions.

RollTrack Source

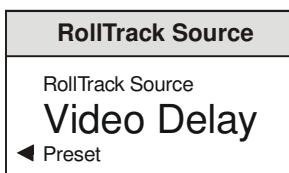

This allows the source of information that triggers the transmission of data to be selected. Options are:

Unused
Input Present
Input Missing
Standard 525
Standard 625
Video Delay
Ref. Lost
Ref. Present
Ref. Error

The destination for the information is set by the network code address.

RollTrack Disable

When this item is selected all RollTrack items will be disabled.

RollTrack Address

This item allows the address of the selected destination unit to be set.

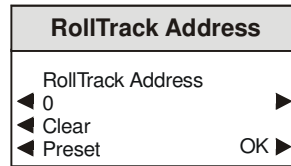

To compile/edit the text the right ► and left buttons adjacent to the upper text line in the menu should be used to select the character position in the text and the spinwheel used to select the character.

The **Clear** function blanks the selected character.

The **Preset** function loads the default address.

O.K. ► saves the address and returns to the main menu.

The full **RollTrack** address has four sets of numbers

For example: 0000:10:01*99

The first set (0000) is the network segment code number

The second set (10) is the number identifying the (enclosure/mainframe) unit.

The third set (01) is the slot number in the unit

The fourth set (99) is a user settable number that is a unique identification number for the destination unit in a multi-unit system. This ensures that only the correct unit will respond to the command. If left at 00 an incorrectly fitted unit may respond inappropriately.

RollTrack Command

RollTrack Command	
RollTrack Command	
◀ 0 ▶	
◀ Clear ▶	
◀ Preset ▶	OK ▶

The full **RollTrack** command has two sets of numbers

For example: 84*156

The first set (84) is the **RollTrack** command number

The second set (156) is the value sent with the **RollTrack** command number.

*Note that when video delay or audio delay is selected as the **RollTrack** source the value sent with the **RollTrack** command is the video delay value not the value set.*

For details of the RollCall command values for specific units please contact your local Snell & Wilcox agent.

RollTrack Sending

This item shows when the unit is actively sending the RollTrack command.

RollTrack Sending/Status
RollTrack Sending/Status YES
OK ▶

This may show:

String	A string value is always being sent.
Number	A number value is always being sent.
No	The message is not being sent.
Yes	The message is being sent.
Internal Type Error	Inconsistent behavior; please contact your local Snell & Wilcox agent.

RollTrack Status

This item will show the status of the currently selected RollTrack index.

This may show:

OK	RollTrack message sent and received OK.
Unknown	Rolltrack message has been sent but it has not yet completed.
Timeout	RollTrack message sent but acknowledgement not received. This could be because the destination unit is not at the location specified.
Error	This indicates a broken RollCall state.
Bad	This indicates a broken RollCall packet.

Logging

Information about various parameters can be made available to a logging device that is attached to the RollCall™ network by selecting the appropriate item.

Logging
◀ Input
◀ Std
◀ Reference
◀ RollTrack

Any of the items may be selected from the list.

ROLLCALL LOG FIELDS

(where applicable)

Log Field	Log Value	Description
INPUT=	OK ERR LOST	Valid input signal Invalid input signal Input signal lost
STD=	UNKNOWN STDERR 525 625 PAL NTSC NTSC_J PAL_M PAL_N SECAM N443_60 PAL443_60 ERROR: 525 ERROR: 625 ERROR: PAL ERROR: NTSC ERROR: NTSC_J ERROR: PAL_M ERROR: PAL_N ERROR: SECAM ERROR: N443_60 ERROR: PAL443_60	Input signal standard not recognized or no signal Not a selected input standard SDI input standard 525 SDI input standard 625 PAL composite input NTSC composite input NTSC J composite input PAL M composite input PAL N composite input SECAM composite input N4.43 60 composite input PAL4.43 60 composite input SDI input standard 525, 525 standard not valid SDI input standard 625, 625 standard not valid Composite input standard invalid, decoding as PAL Composite input standard invalid, decoding as NTSC Composite input standard invalid, decoding as NTSC J Composite input standard invalid, decoding as PAL M Composite input standard invalid, decoding as PAL N Composite input standard invalid, decoding as SECAM Composite input standard invalid, decoding as N4.43 60 Composite input standard invalid, decoding as PAL4.43 60
EXTREF=	525 625 ERROR: 525 ERROR: 625 WARNING: LOSS WARNING:525_N/A WARNING:625_N/A NONE	525 reference, input 525 or lost 625 reference, input 625 or lost 525 reference, input 625, trying to lock to reference 625 reference, input 525, trying to lock to reference Reference lost, trying to lock to reference 525 reference, input 625, not trying to lock to reference 625 reference, input 525, not trying to lock to reference Reference lost, not trying to lock to reference
ROL_STATES=	OK FAIL	RollTrack message sent and received OK RollTrack message not acknowledged
BUS_AL=	OK WARNING: SILENT WARNING: QUIET WARNING: HIGH WARNING: OVERLOAD	Router BUS A Left channel has valid signal selected Router BUS A Left channel is receiving silence Router BUS A Left channel is receiving low level signal Router BUS A Left channel is receiving high level signal Router BUS A Left channel is receiving overload signal
BUS_AR=	OK WARNING: SILENT WARNING: QUIET WARNING: HIGH WARNING: OVERLOAD	Router BUS A Right channel has valid signal selected Router BUS A Right channel is receiving silence Router BUS A Right channel is receiving low level signal Router BUS A Right channel is receiving high level signal Router BUS A Right channel is receiving overload signal
BUS_BL=	OK WARNING: SILENT WARNING: QUIET WARNING: HIGH WARNING: OVERLOAD	Router BUS B Left channel has valid signal selected Router BUS B Left channel is receiving silence Router BUS B Left channel is receiving low level signal Router BUS B Left channel is receiving high level signal Router BUS B Left channel is receiving overload signal
BUS_BR=	OK WARNING: SILENT WARNING: QUIET WARNING: HIGH WARNING: OVERLOAD	Router BUS B Right channel has valid signal selected Router BUS B Right channel is receiving silence Router BUS B Right channel is receiving low level signal Router BUS B Right channel is receiving high level signal Router BUS B Right channel is receiving overload signal
SN=	Runtime string	Serial number of unit

Default Output

If the input signal fails or is of poor quality this function will determine what the output signal will become under such conditions.

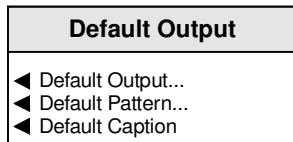

Default Output

This allows the default output mode to be selected.

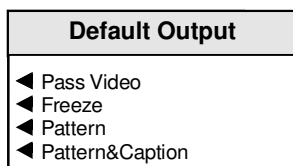

Pass Video The input signal will be passed to the output.

Freeze The output will become a frozen frame picture.

Pattern The output will become the pattern chosen from the **Default Pattern** list.

Pattern and Caption The output will become the pattern chosen from the **Default Pattern** list plus the **Default Caption**.

Default Pattern

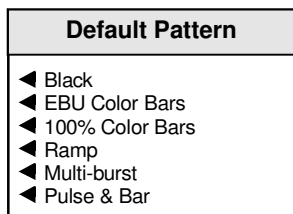

If **Pattern** is chosen in the **Default Output** menu the output will become the pattern chosen from this list.

Default Caption

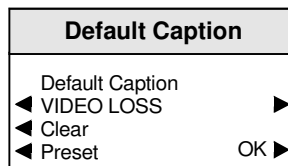

This is the caption that will appear if **Pattern and Caption** is chosen from the **Default Output** menu.

To compile/edit the text the right ► and left buttons adjacent to the upper text line in the menu should be used to select the character position in the text and the spinwheel used to select the character.

The **Clear** function blanks the selected character.

The **Preset** function loads the default text, for example, **VIDEO LOSS**.

O.K. ► saves the text and returns to the main menu.

Software Version

This item reveals a display showing the version of the software fitted in the module.

Software Version
Software Version x.x.x
OK ►

Select OK to return to the Setup Menu.

Serial No

This item reveals a display showing the serial number of the module.

Serial No
Serial No xxxxxxx
OK ►

Select OK to return to the Setup Menu.

Build No

This will indicate the factory build number. This number defines all parameters of the unit (software versions, build level etc.) for identification purposes.

Build No
Build No xxxxxxx
OK ►

Select OK to return to the Setup Menu.

FPGA Sync Version

This will display the version number of the Synchronizer FPGA fitted to the unit.

FPGA Sync Version
FPGA Sync Version xxxxxxx
OK ►

Select OK to return to the Setup Menu.

FPGA Dec Version

This will display the version number of the Decoder FPGA fitted to the unit.

FPGA Dec Version
FPGA Dec Version xxxxxxx
OK ►

Select OK to return to the Setup Menu.

Error Seconds Reset

Selecting this function will reset the EDH error count and the timer shown in the information window, to zero.

Factory Default

Selecting this item sets all adjustment functions that include a preset facility, to their factory default values.

Note that this is a momentary action.

Restart

This will reboot the unit simulating a power-down power-up cycle restoring power-up settings.

User Mem(ories)

This function allows a number of particular setups of the IQDEC04 to be saved and recalled. There are 8 memory locations available.

This item allows any of the 8 memory locations to be selected.

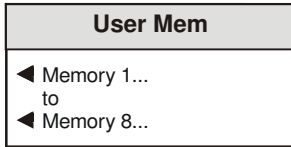

Memory 1 to 8

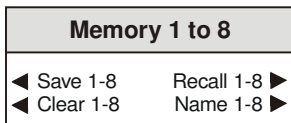

When a memory location has been selected this item allows it to be saved, recalled, cleared or renamed.

Save 1-8

When selected the current settings will be saved at this location.

Recall 1-8 ►

When selected the settings will be recalled from this location and applied to the unit.

Clear 1-8

When selected the memory location will be cleared and returned to the default (preset) setting.

Name 1-8 ►

The selected memory location may be renamed with this function.

To compile/edit the text the right ► and left buttons adjacent to the upper text line in the menu should be used to select the character position in the text and the spinwheel used to select the character.

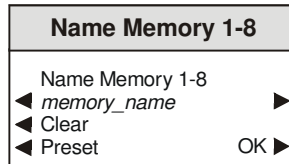

The **Clear** function blanks the selected character.

The **Preset** function loads the default text, for example, **Memory 1**.

O.K. ► saves the memory name text and returns to the main menu.

Freeze

When selected the output picture will become a frozen frame.

IQDEC04 RollCall Commands

Supervisor Level

Command No.						Values	
Hex	Dec	Command Name					
000E	14	RollTrack14	min=-2147483648	max=2147483647	Step=1		
000F	15	RollTrack15	min=-2147483648	max=2147483647	Step=1		
0010	16	RollTrack16	min=-2147483648	max=2147483647	Step=1		
0011	17	RollTrack17	min=-2147483648	max=2147483647	Step=1		
03EA	1002	<Select>	0=Composite A	1=Composite B	2=YC		3=SDI
044C	1100	525	clear=0 set=1 (toggle=2)				
044D	1101	625	clear=0 set=1 (toggle=2)				
0578	1400	Left	min=0	max=200	Step=2		
0579	1401	Right	min=0	max=200	Step=2		
057A	1402	Top	min=0	max=200	Step=1		
057B	1403	Bottom	min=0	max=200	Step=1		
057C	1404	Red	min=0	max=255	Step=1		
057D	1405	Green	min=0	max=255	Step=1		
057E	1406	Blue	min=0	max=255	Step=1		
0640	1600	Luma Gain	min=-60	max=60	Step=1		Div=10
0641	1601	Black Level	min=-1200	max=1200	Step=5		Div=10
0642	1602	Chroma Gain	min=-60	max=60	Step=1		Div=10
0643	1603	V Enhance	min=0	max=3	Step=1		
0644	1604	H Enhance	min=0	max=3	Step=1		
0645	1605	<H Enhance Freq>	0=3.375 MHZ	1=2.250 MHZ			
0646	1606	Picture Position	min=-592	max=592	Step=148		
0647	1607	Y/C Timing	min=-592	max=592	Step=148		
07D0	2000	<Reference Src>	0=Free Run	1=External	Reference		2=Input Video
07D1	2001	H Phase 625	min=0	max=1727	Step=1		
07D2	2002	V Phase 625	min=0	max=624	Step=1		
07D3	2003	H Phase 525	min=0	max=1715	Step=1		
07D4	2004	V Phase 525	min=0	max=524	Step=1		
07D5	2005	H Delay 625	min=0	max=1727	Step=1		
07D6	2006	V Delay 625	min=0	max=624	Step=1		
07D7	2007	H Delay 525	min=0	max=1715	Step=1		
07D8	2008	V Delay 525	min=0	max=524	Step=1		
0838	2104	Freerun Frequency	min=-60	max=60	Step=1		
083A	2106	<Frame Delay>	0=0 Frame Delay	1=1 Frame Delay	2=2 Frame Delay		
0898	2200	HANC Blank	clear=0 set=1 (toggle=2)				
0899	2201	<Line 11>	0=Blank	1=Pass VBI	2=Decode VBI		
089A	2202	<Line 12>	0=Blank	1=Pass VBI	2=Decode VBI		
089B	2203	<Line 13>	0=Blank	1=Pass VBI	2=Decode VBI		
089C	2204	<Line 14>	0=Blank	1=Pass VBI	2=Decode VBI		
089D	2205	<Line 15>	0=Blank	1=Pass VBI	2=Decode VBI		
089E	2206	<Line 16>	0=Blank	1=Pass VBI	2=Decode VBI		
089F	2207	<Line 17>	0=Blank	1=Pass VBI	2=Decode VBI		
08A0	2208	<Line 18>	0=Blank	1=Pass VBI	2=Decode VBI		
08A1	2209	<Line 19>	0=Blank	1=Pass VBI	2=Decode VBI		
08A2	2210	<Line 20>	0=Blank	1=Pass VBI	2=Decode VBI		
08A3	2211	<Line 21>	0=Blank	1=Data	2=Picture		3=Closed Captions
08A4	2212	<Line 22>	0=Blank	1=Data	2=Picture		
08A5	2213	<Line 274>	0=Blank	1=Pass VBI	2=Decode VBI		
08A6	2214	<Line 275>	0=Blank	1=Pass VBI	2=Decode VBI		
08A7	2215	<Line 276>	0=Blank	1=Pass VBI	2=Decode VBI		
08A8	2216	<Line 277>	0=Blank	1=Pass VBI	2=Decode VBI		
08A9	2217	<Line 278>	0=Blank	1=Pass VBI	2=Decode VBI		
08AA	2218	<Line 279>	0=Blank	1=Pass VBI	2=Decode VBI		
08AB	2219	<Line 280>	0=Blank	1=Pass VBI	2=Decode VBI		
08AC	2220	<Line 281>	0=Blank	1=Pass VBI	2=Decode VBI		
08AD	2221	<Line 282>	0=Blank	1=Pass VBI	2=Decode VBI		
08AE	2222	<Line 283>	0=Blank	1=Data	2=Picture		
08AF	2223	<Line 284>	0=Blank	1=Data	2=Picture		3=Closed Captions
08B0	2224	<Line 285>	0=Blank	1=Data	2=Picture		
08B6	2230	<Line 7>	0=Blank	1=Pass VBI	2=Decode VBI		
08B7	2231	<Line 8>	0=Blank	1=Pass VBI	2=Decode VBI		
08B8	2232	<Line 9>	0=Blank	1=Pass VBI	2=Decode VBI		
08B9	2233	<Line 10>	0=Blank	1=Pass VBI	2=Decode VBI		
08BA	2234	<Line 11>	0=Blank	1=Pass VBI	2=Decode VBI		
08BB	2235	<Line 12>	0=Blank	1=Pass VBI	2=Decode VBI		
08BC	2236	<Line 13>	0=Blank	1=Pass VBI	2=Decode VBI		
08BD	2237	<Line 14>	0=Blank	1=Pass VBI	2=Decode VBI		
08BE	2238	<Line 15>	0=Blank	1=Pass VBI	2=Decode VBI		
08BF	2239	<Line 16>	0=Blank	1=Pass VBI	2=Decode VBI		
08C0	2240	<Line 17>	0=Blank	1=Pass VBI	2=Decode VBI		
08C1	2241	<Line 18>	0=Blank	1=Pass VBI	2=Decode VBI		
08C2	2242	<Line 19>	0=Blank	1=Pass VBI	2=Decode VBI		
08C3	2243	<Line 20>	0=Blank	1=Pass VBI	2=Decode VBI		
08C4	2244	<Line 21>	0=Blank	1=Pass VBI	2=Decode VBI		
08C5	2245	<Line 22>	0=Blank	1=Pass VBI	2=Decode VBI		
08C6	2246	<Line 23>	0=Blank	1=WSS	2=Picture		
08C7	2247	<Line 320>	0=Blank	1=Pass VBI	2=Decode VBI		
08C8	2248	<Line 321>	0=Blank	1=Pass VBI	2=Decode VBI		
08C9	2249	<Line 322>	0=Blank	1=Pass VBI	2=Decode VBI		
08CA	2250	<Line 323>	0=Blank	1=Pass VBI	2=Decode VBI		
08CB	2251	<Line 324>	0=Blank	1=Pass VBI	2=Decode VBI		
08CC	2252	<Line 325>	0=Blank	1=Pass VBI	2=Decode VBI		
08CD	2253	<Line 326>	0=Blank	1=Pass VBI	2=Decode VBI		
08CE	2254	<Line 327>	0=Blank	1=Pass VBI	2=Decode VBI		
08CF	2255	<Line 328>	0=Blank	1=Pass VBI	2=Decode VBI		
08D0	2256	<Line 329>	0=Blank	1=Pass VBI	2=Decode VBI		
08D1	2257	<Line 330>	0=Blank	1=Pass VBI	2=Decode VBI		
08D2	2258	<Line 331>	0=Blank	1=Pass VBI	2=Decode VBI		
08D3	2259	<Line 332>	0=Blank	1=Pass VBI	2=Decode VBI		
08D4	2260	<Line 333>	0=Blank	1=Pass VBI	2=Decode VBI		
08D5	2261	<Line 334>	0=Blank	1=Pass VBI	2=Decode VBI		
08D6	2262	<Line 335>	0=Blank	1=Pass VBI	2=Decode VBI		
08DB	2267	<SECAM Bottles>	0=Auto	1=Off	2=On		
0960	2400	Freeze	clear=0 set=1 (toggle=2)				

0961	2401	<Pattern Type>	0=Black 4=Multi-Burst	1=EBU Color Bars 5=Pulse & Bar	2=100% Color Bars	3=Ramp
0962	2402	Pattern Enable	clear=0 set=1 (toggle=2)			
0B54	2900	Caption Select	clear=0 set=1 (toggle=2)			
0B55	2901	Edit Caption	Edit String			
0BB8	3000	RollTrack Index	min=1	max=16	Step=1	
0BB9	3001	<RollTrack Source>	-1=Unused 3=Standard 625 7=Ref. Present 11=De-embed 2 Lost 15=De-embed 4 Lost 18=De-embed 5 Present 22=De-embed 7 Present			
			0=Input Present 4=Audio Delay 8=Ref. Error 12=De-embed 2 Present 16=De-embed 4 Present 19=De-embed 6 Lost 23=De-embed 8 Lost			
			1=Input Missing 5=Video Delay 9=De-embed 1 Lost 13=De-embed 3 Lost 17=De-embed 5 Lost 20=De-embed 6 Present 24=De-embed 8 Present			
			2=Standard 525 6=Ref. Lost 10=De-embed 1 Present 14=De-embed 4 Present 21=De-embed 7 Present			
0BBA	3002	RollTrack Address	Edit String			
0BBB	3003	RollTrack Command	Edit String			
0BBC	3004	Disable All	clear=0 set=1 (toggle=2)			
0BBD	3005	RollTrack Status	Static Display (no control)			
0BBE	3006	RollTrack Sending	Static Display (no control)			
0C80	3200	<GPI Mode>	0=Unused 1=Input 2=Output			
0C82	3202	<GPI i/p Select>	0=Pattern 4=Memory3 8=Memory7 12=Memory 5-6			
			1=Freeze 5=Memory4 9=Memory8 13=Memory 7-8			
			2=Memory1 6=Memory5 10=Memory 1-2			
			3=Memory2 7=Memory6 11=Memory 3-4			
0C84	3204	<GPI o/p Select>	0=Input Present 1=Standard 625 2=Video Delay			
0C85	3205	GPI Out Delay	Static Display (no control)			
0C86	3206	Out Active High	clear=0 set=1 (toggle=2)			
0C87	3207	Timer Active High	clear=0 set=1 (toggle=2)			
0C88	3208	GPI In Delay	Static Display (no control)			
0C89	3209	Audio Delay	clear=0 set=1 (toggle=2)			
0FA0	4000	L-Gain	min=-180	max=180	Step=1	Div=10
0FA1	4001	Gain-R	min=-180	max=180	Step=1	Div=10
0FA2	4002	L-Invert	clear=0 set=1 (toggle=2)			
0FA3	4003	Invert-R	clear=0 set=1 (toggle=2)			
0FA4	4004	L-Mute	clear=0 set=1 (toggle=2)			
0FA5	4005	Mute-R	clear=0 set=1 (toggle=2)			
0FA6	4006	Stereo	clear=0 set=1 (toggle=2)			
0FA7	4007	Delay	min=0	max=1500	Step=1	
0FAA	4010	L-Gain	min=-180	max=180	Step=1	Div=10
0FAB	4011	Gain-R	min=-180	max=180	Step=1	Div=10
0FAC	4012	L-Invert	clear=0 set=1 (toggle=2)			
0FAD	4013	Invert-R	clear=0 set=1 (toggle=2)			
0FAE	4014	L-Mute	clear=0 set=1 (toggle=2)			
0FAF	4015	Mute-R	clear=0 set=1 (toggle=2)			
0FB0	4016	Stereo	clear=0 set=1 (toggle=2)			
0FB1	4017	Delay	min=0	max=1500	Step=1	
0FB4	4020	L-Gain	min=-180	max=180	Step=1	Div=10
0FB5	4021	Gain-R	min=-180	max=180	Step=1	Div=10
0FB6	4022	L-Invert	clear=0 set=1 (toggle=2)			
0FB7	4023	Invert-R	clear=0 set=1 (toggle=2)			
0FB8	4024	L-Mute	clear=0 set=1 (toggle=2)			
0FB9	4025	Mute-R	clear=0 set=1 (toggle=2)			
0FBA	4026	Stereo	clear=0 set=1 (toggle=2)			
0FBB	4027	Delay	min=0	max=1500	Step=1	
0FBE	4030	L-Gain	min=-180	max=180	Step=1	Div=10
0FBF	4031	Gain-R	min=-180	max=180	Step=1	Div=10
0FC0	4032	L-Invert	clear=0 set=1 (toggle=2)			
0FC1	4033	Invert-R	clear=0 set=1 (toggle=2)			
0FC2	4034	L-Mute	clear=0 set=1 (toggle=2)			
0FC3	4035	Mute-R	clear=0 set=1 (toggle=2)			
0FC4	4036	Stereo	clear=0 set=1 (toggle=2)			
0FC5	4037	Delay	min=0	max=1500	Step=1	
0FC8	4040	L-Gain	min=-180	max=180	Step=1	Div=10
0FC9	4041	Gain-R	min=-180	max=180	Step=1	Div=10
0FCA	4042	L-Invert	clear=0 set=1 (toggle=2)			
0FCB	4043	Invert-R	clear=0 set=1 (toggle=2)			
0FCC	4044	L-Mute	clear=0 set=1 (toggle=2)			
0FCD	4045	Mute-R	clear=0 set=1 (toggle=2)			
0FCE	4046	Stereo	clear=0 set=1 (toggle=2)			
0FCF	4047	Delay	min=0	max=1500	Step=1	
0FD2	4050	L-Gain	min=-180	max=180	Step=1	Div=10
0FD3	4051	Gain-R	min=-180	max=180	Step=1	Div=10
0FD4	4052	L-Invert	clear=0 set=1 (toggle=2)			
0FD5	4053	Invert-R	clear=0 set=1 (toggle=2)			
0FD6	4054	L-Mute	clear=0 set=1 (toggle=2)			
0FD7	4055	Mute-R	clear=0 set=1 (toggle=2)			
0FD8	4056	Stereo	clear=0 set=1 (toggle=2)			
0FD9	4057	Delay	min=0	max=1500	Step=1	
0FDC	4060	L-Gain	min=-180	max=180	Step=1	Div=10
0FDD	4061	Gain-R	min=-180	max=180	Step=1	Div=10
0FDE	4062	L-Invert	clear=0 set=1 (toggle=2)			
0FDF	4063	Invert-R	clear=0 set=1 (toggle=2)			
0FE0	4064	L-Mute	clear=0 set=1 (toggle=2)			
0FE1	4065	Mute-R	clear=0 set=1 (toggle=2)			
0FE2	4066	Stereo	clear=0 set=1 (toggle=2)			
0FE3	4067	Delay	min=0	max=1500	Step=1	
0FE6	4070	L-Gain	min=-180	max=180	Step=1	Div=10
0FE7	4071	Gain-R	min=-180	max=180	Step=1	Div=10
0FE8	4072	L-Invert	clear=0 set=1 (toggle=2)			
0FE9	4073	Invert-R	clear=0 set=1 (toggle=2)			
0FEA	4074	L-Mute	clear=0 set=1 (toggle=2)			
0FEB	4075	Mute-R	clear=0 set=1 (toggle=2)			
0FEC	4076	Stereo	clear=0 set=1 (toggle=2)			
0FED	4077	Delay	min=0	max=1500	Step=1	
1004	4100	L-Gain	min=-68	max=68	Step=1	Div=2
1005	4101	Gain-R	min=-68	max=68	Step=1	Div=2
1006	4102	L-Invert	clear=0 set=1 (toggle=2)			
1007	4103	Invert-R	clear=0 set=1 (toggle=2)			
1008	4104	L-Mute	clear=0 set=1 (toggle=2)			
1009	4105	Mute-R	clear=0 set=1 (toggle=2)			
100A	4106	Stereo	clear=0 set=1 (toggle=2)			
100B	4107	Delay	min=0	max=1500	Step=1	
100E	4110	L-Gain	min=-68	max=68	Step=1	Div=2
100F	4111	Gain-R	min=-68	max=68	Step=1	Div=2
1010	4112	L-Invert	clear=0 set=1 (toggle=2)			

1011	4113	Invert-R	clear=0 set=1 (toggle=2)
1012	4114	L-Mute	clear=0 set=1 (toggle=2)
1013	4115	Mute-R	clear=0 set=1 (toggle=2)
1014	4116	Stereo	clear=0 set=1 (toggle=2)
1015	4117	Delay	min=0 max=1500 Step=1
1022	4130	Headroom	min=8 max=48 Step=1 Div=2
1023	4131	Line Up	min=-48 max=20 Step=1 Div=2
1068	4200	<L-Src >	0=Analog 1L 1=Analog 1R 2=Analog 2L 3=Analog 2R 4=SDI DeEmbed 1L 5=SDI DeEmbed 1R 6=SDI DeEmbed 2L 7=SDI DeEmbed 2R 8=SDI DeEmbed 3L 9=SDI DeEmbed 3R 10=SDI DeEmbed 4L 11=SDI DeEmbed 4R 12=SDI DeEmbed 5L 13=SDI DeEmbed 5R 14=SDI DeEmbed 6L 15=SDI DeEmbed 6R 16=SDI DeEmbed 7L 17=SDI DeEmbed 7R 18=SDI DeEmbed 8L 19=SDI DeEmbed 8R 20=Tone L 21=Tone R 22=Mixer 1 23=Mixer 2 24=Mixer 3 25=Mixer 4
1069	4201	<Src-R>	0=Analog 1L 1=Analog 1R 2=Analog 2L 3=Analog 2R 4=SDI DeEmbed 1L 5=SDI DeEmbed 1R 6=SDI DeEmbed 2L 7=SDI DeEmbed 2R 8=SDI DeEmbed 3L 9=SDI DeEmbed 3R 10=SDI DeEmbed 4L 11=SDI DeEmbed 4R 12=SDI DeEmbed 5L 13=SDI DeEmbed 5R 14=SDI DeEmbed 6L 15=SDI DeEmbed 6R 16=SDI DeEmbed 7L 17=SDI DeEmbed 7R 18=SDI DeEmbed 8L 19=SDI DeEmbed 8R 20=Tone L 21=Tone R 22=Mixer 1 23=Mixer 2 24=Mixer 3 25=Mixer 4
106A	4202	L-Gain	min=-180 max=180 Step=1 Div=10
106B	4203	Gain-R	min=-180 max=180 Step=1 Div=10
106C	4204	L-Invert	clear=0 set=1 (toggle=2)
106D	4205	Invert-R	clear=0 set=1 (toggle=2)
106E	4206	L-Mute	clear=0 set=1 (toggle=2)
106F	4207	Mute-R	clear=0 set=1 (toggle=2)
1070	4208	Stereo	clear=0 set=1 (toggle=2)
1071	4209	<L-Src>	0=Analog 1L 1=Analog 1R 2=Analog 2L 3=Analog 2R 4=SDI DeEmbed 1L 5=SDI DeEmbed 1R 6=SDI DeEmbed 2L 7=SDI DeEmbed 2R 8=SDI DeEmbed 3L 9=SDI DeEmbed 3R 10=SDI DeEmbed 4L 11=SDI DeEmbed 4R 12=SDI DeEmbed 5L 13=SDI DeEmbed 5R 14=SDI DeEmbed 6L 15=SDI DeEmbed 6R 16=SDI DeEmbed 7L 17=SDI DeEmbed 7R 18=SDI DeEmbed 8L 19=SDI DeEmbed 8R 20=Tone L 21=Tone R 22=Mixer 1 23=Mixer 2 24=Mixer 3 25=Mixer 4
1072	4210	<Src-R>	0=Analog 1L 1=Analog 1R 2=Analog 2L 3=Analog 2R 4=SDI DeEmbed 1L 5=SDI DeEmbed 1R 6=SDI DeEmbed 2L 7=SDI DeEmbed 2R 8=SDI DeEmbed 3L 9=SDI DeEmbed 3R 10=SDI DeEmbed 4L 11=SDI DeEmbed 4R 12=SDI DeEmbed 5L 13=SDI DeEmbed 5R 14=SDI DeEmbed 6L 15=SDI DeEmbed 6R 16=SDI DeEmbed 7L 17=SDI DeEmbed 7R 18=SDI DeEmbed 8L 19=SDI DeEmbed 8R 20=Tone L 21=Tone R 22=Mixer 1 23=Mixer 2 24=Mixer 3 25=Mixer 4
1073	4211	L-Gain	min=-180 max=180 Step=1 Div=10
1074	4212	Gain-R	min=-180 max=180 Step=1 Div=10
1075	4213	L-Invert	clear=0 set=1 (toggle=2)
1076	4214	Invert-R	clear=0 set=1 (toggle=2)
1077	4215	L-Mute	clear=0 set=1 (toggle=2)
1078	4216	Mute-R	clear=0 set=1 (toggle=2)
1079	4217	Stereo	clear=0 set=1 (toggle=2)
10CD	4301	<Source>	0=BUS A 1=BUS B
10CE	4302	<Destination>	0=Pair 1 1=Pair 2 2=Pair 3 3=Pair 4 4=Pair 5 5=Pair 6 6=Pair 7 7=Pair 8
10CF	4303	Disable	clear=0 set=1 (toggle=2)
10D0	4304	<Source>	0=BUS A 1=BUS B
10D1	4305	<Destination>	0=Pair 1 1=Pair 2 2=Pair 3 3=Pair 4 4=Pair 5 5=Pair 6 6=Pair 7 7=Pair 8
10D2	4306	Disable	clear=0 set=1 (toggle=2)
10D3	4307	<Source>	0=BUS A 1=BUS B
10D5	4309	<Source>	0=BUS A 1=BUS B
1130	4400	Set Manual	min=-40 max=1500 Step=1
1131	4401	Include Internal	clear=0 set=1 (toggle=2)
1132	4402	Include Manual	clear=0 set=1 (toggle=2)
1133	4403	Include GPI	clear=0 set=1 (toggle=2)
1134	4404	Include RTrack14	clear=0 set=1 (toggle=2)
1135	4405	Include RTrack15	clear=0 set=1 (toggle=2)
1136	4406	Include RTrack16	clear=0 set=1 (toggle=2)
1137	4407	Include RTrack17	clear=0 set=1 (toggle=2)
1141	4417	Total Delay	Static Display (no control)
1142	4418	Internal	Static Display (no control)
1143	4419	Manual	Static Display (no control)
1144	4420	GPI	Static Display (no control)
1145	4421	RTrack14	Static Display (no control)
1146	4422	RTrack15	Static Display (no control)
1147	4423	RTrack16	Static Display (no control)
1148	4424	RTrack17	Static Display (no control)
1194	4500	Silence	min=-80 max=0 Step=1
1195	4501	Low Level	min=-80 max=0 Step=1
1196	4502	High Level	min=-80 max=0 Step=1
1197	4503	Overload	min=-80 max=0 Step=1
1198	4504	Warning Timer	min=1 max=20 Step=1
11F9	4601	Frequency Left	min=100 max=15000 Step=100 Div=1000
11FA	4602	Frequency Right	min=100 max=15000 Step=100 Div=1000
11FB	4603	<Identify Tone>	0=Off 1=Left 2=Right
11FD	4605	<Audio Slew Select>	0=Instant 1=Fast 2=Medium 3=Slow 4=Slowest
11FE	4606	Channel Status Dest	Edit String
11FF	4607	AES Validity Bit	clear=0 set=1 (toggle=2)
1202	4610	<Channel Status>	1=Calibrate Audio
1203	4611	Cal on Video IP Sel	clear=0 set=1 (toggle=2)
125C	4700	<Source 1>	0=None 1=Analog 1L 2=Analog 1R 3=Analog 2L 4=Analog 2R 5=SDI DeEmbed 1L 6=SDI DeEmbed 1R 7=SDI DeEmbed 2L 8=SDI DeEmbed 2R 9=SDI DeEmbed 3L 10=SDI DeEmbed 3R 11=SDI DeEmbed 4L 12=SDI DeEmbed 4R 13=SDI DeEmbed 5L 14=SDI DeEmbed 5R 15=SDI DeEmbed 6L 16=SDI DeEmbed 6R 17=SDI DeEmbed 7L 18=SDI DeEmbed 7R 19=SDI DeEmbed 8L 20=SDI DeEmbed 8R 21=Tone L 22=Tone R
125D	4701	<Source 2>	0=None 1=Analog 1L 2=Analog 1R 3=Analog 2L 4=Analog 2R 5=SDI DeEmbed 1L 6=SDI DeEmbed 1R 7=SDI DeEmbed 2L 8=SDI DeEmbed 2R 9=SDI DeEmbed 3L 10=SDI DeEmbed 3R 11=SDI DeEmbed 4L 12=SDI DeEmbed 4R 13=SDI DeEmbed 5L 14=SDI DeEmbed 5R 15=SDI DeEmbed 6L 16=SDI DeEmbed 6R 17=SDI DeEmbed 7L 18=SDI DeEmbed 7R 19=SDI DeEmbed 8L 20=SDI DeEmbed 8R 21=Tone L 22=Tone R

12BA	4794	<Source 5>	0=None 4=Analog 2R 8=SDI DeEmbed 2R 12=SDI DeEmbed 4R 16=SDI DeEmbed 6R 20=SDI DeEmbed 8R	1=Analog 1L 5=SDI DeEmbed 1L 9=SDI DeEmbed 3L 13=SDI DeEmbed 5L 17=SDI DeEmbed 7L 21=SDI DeEmbed 8R	2=Analog 1R 6=SDI DeEmbed 1R 10=SDI DeEmbed 3R 14=SDI DeEmbed 5R 18=SDI DeEmbed 7R 22=Tone R	3=Analog 2L 7=SDI DeEmbed 2L 11=SDI DeEmbed 4L 15=SDI DeEmbed 6L 19=SDI DeEmbed 8L		
12BB	4795	<Source 6>	0=None 4=Analog 2R 8=SDI DeEmbed 2R 12=SDI DeEmbed 4R 16=SDI DeEmbed 6R 20=SDI DeEmbed 8R	1=Analog 1L 5=SDI DeEmbed 1L 9=SDI DeEmbed 3L 13=SDI DeEmbed 5L 17=SDI DeEmbed 7L 21=Tone L	2=Analog 1R 6=SDI DeEmbed 1R 10=SDI DeEmbed 3R 14=SDI DeEmbed 5R 18=SDI DeEmbed 7R 22=Tone R	3=Analog 2L 7=SDI DeEmbed 2L 11=SDI DeEmbed 4L 15=SDI DeEmbed 6L 19=SDI DeEmbed 8L		
12BC	4796	<Source 7>	0=None 4=Analog 2R 8=SDI DeEmbed 2R 12=SDI DeEmbed 4R 16=SDI DeEmbed 6R 20=SDI DeEmbed 8R	1=Analog 1L 5=SDI DeEmbed 1L 9=SDI DeEmbed 3L 13=SDI DeEmbed 5L 17=SDI DeEmbed 7L 21=Tone L	2=Analog 1R 6=SDI DeEmbed 1R 10=SDI DeEmbed 3R 14=SDI DeEmbed 5R 18=SDI DeEmbed 7R 22=Tone R	3=Analog 2L 7=SDI DeEmbed 2L 11=SDI DeEmbed 4L 15=SDI DeEmbed 6L 19=SDI DeEmbed 8L		
12BD	4797	<Source 8>	0=None 4=Analog 2R 8=SDI DeEmbed 2R 12=SDI DeEmbed 4R 16=SDI DeEmbed 6R 20=SDI DeEmbed 8R	1=Analog 1L 5=SDI DeEmbed 1L 9=SDI DeEmbed 3L 13=SDI DeEmbed 5L 17=SDI DeEmbed 7L 21=Tone L	2=Analog 1R 6=SDI DeEmbed 1R 10=SDI DeEmbed 3R 14=SDI DeEmbed 5R 18=SDI DeEmbed 7R 22=Tone R	3=Analog 2L 7=SDI DeEmbed 2L 11=SDI DeEmbed 4L 15=SDI DeEmbed 6L 19=SDI DeEmbed 8L		
12C0	4800	Gain 1	min=-85	max=0	Step=1			
12C1	4801	Gain 2	min=-85	max=0	Step=1			
12C2	4802	Gain 3	min=-85	max=0	Step=1			
12C3	4803	Gain 4	min=-85	max=0	Step=1			
12C4	4804	Gain 5	min=-85	max=0	Step=1			
12C5	4805	Gain 6	min=-85	max=0	Step=1			
12C6	4806	Gain 7	min=-85	max=0	Step=1			
12C7	4807	Gain 8	min=-85	max=0	Step=1			
12CA	4810	Mix-4 Gain-1 Disp	Static Display (no control)					
12CB	4811	Mix-4 Gain-2 Disp	Static Display (no control)					
12CC	4812	Mix-4 Gain-3 Disp	Static Display (no control)					
12CD	4813	Mix-4 Gain-4 Disp	Static Display (no control)					
12CE	4814	Mix-4 Gain-5 Disp	Static Display (no control)					
12CF	4815	Mix-4 Gain-6 Disp	Static Display (no control)					
12D0	4816	Mix-4 Gain-7 Disp	Static Display (no control)					
12D1	4817	Mix-4 Gain-8 Disp	Static Display (no control)					
1326	4902	Minimum Delay	clear=0	set=1	(toggle=2)			
1327	4903	<Color Killer>	0=Chroma Off	1=Chroma On		2=Auto		
1328	4904	<Decoder>	0=Studio	1=Simple		6=VHS/Unstable		
1329	4905	<Luma Bandwidth>	0=wide	1=Medium		2=Narrow		
132A	4906	<Notch>	0=Adaptive	1=Controllable				
132B	4907	<Luma Bandwidth>	0=wide	1=Medium		2=Narrow		
132C	4908	NTSC Hue	min=-45	max=45	Step=1			
1330	4912	PAL	clear=0	set=1	(toggle=2)			
1331	4913	NTSC	clear=0	set=1	(toggle=2)			
1332	4914	NTSC J	clear=0	set=1	(toggle=2)			
1333	4915	PAL M	clear=0	set=1	(toggle=2)			
1334	4916	PAL N	clear=0	set=1	(toggle=2)			
1335	4917	SECAM	clear=0	set=1	(toggle=2)			
1336	4918	N4.43 60	clear=0	set=1	(toggle=2)			
1337	4919	PAL4.43 60	clear=0	set=1	(toggle=2)			
1388	5000	<Memory 8>	0=Recall	1=Recall		2=Recall	3=Recall	
			4=Recall	5=Recall		6=Recall	7=Recall	
			8=					
1389	5001	<Memory 8>	0=Save	1=Save		2=Save	3=Save	
			4=Save	5=Save		6=Save	7=Save	
			8=					
138A	5002	Name	Edit String					
138B	5003	Name	Edit String					
138C	5004	Name	Edit String					
138D	5005	Name	Edit String					
138E	5006	Name	Edit String					
138F	5007	Name	Edit String					
1390	5008	Name	Edit String					
1391	5009	Name	Edit String					
1392	5010	<Memory 8>	0=Clear	1=Clear		2=Clear	3=Clear	
			4=Clear	5=Clear		6=Clear	7=Clear	
			8=					
1393	5011		min=0	max=65535	Step=1			
1770	6000	Input	clear=0	set=1	(toggle=2)			
1771	6001	Std	clear=0	set=1	(toggle=2)			
1772	6002	Reference	clear=0	set=1	(toggle=2)			
1773	6003	EDH	clear=0	set=1	(toggle=2)			
1774	6004	EDH Err	clear=0	set=1	(toggle=2)			
1775	6005	RollTrack	clear=0	set=1	(toggle=2)			
1776	6006	De-emb 1	clear=0	set=1	(toggle=2)			
1777	6007	De-emb 2	clear=0	set=1	(toggle=2)			
1778	6008	De-emb 3	clear=0	set=1	(toggle=2)			
1779	6009	De-emb 4	clear=0	set=1	(toggle=2)			
177A	6010	De-emb 5	clear=0	set=1	(toggle=2)			
177B	6011	De-emb 6	clear=0	set=1	(toggle=2)			
177C	6012	De-emb 7	clear=0	set=1	(toggle=2)			
177D	6013	De-emb 8	clear=0	set=1	(toggle=2)			
177E	6014	nPCM 1	clear=0	set=1	(toggle=2)			
177F	6015	nPCM 2	clear=0	set=1	(toggle=2)			
1780	6016	nPCM 3	clear=0	set=1	(toggle=2)			
1781	6017	nPCM 4	clear=0	set=1	(toggle=2)			
1782	6018	nPCM 5	clear=0	set=1	(toggle=2)			
1783	6019	nPCM 6	clear=0	set=1	(toggle=2)			
1784	6020	nPCM 7	clear=0	set=1	(toggle=2)			
1785	6021	nPCM 8	clear=0	set=1	(toggle=2)			
1786	6022	ANALOG 1L	clear=0	set=1	(toggle=2)			
1787	6023	ANALOG 1R	clear=0	set=1	(toggle=2)			
1788	6024	ANALOG 2L	clear=0	set=1	(toggle=2)			
1789	6025	ANALOG 2R	clear=0	set=1	(toggle=2)			
178A	6026	BUS AL	clear=0	set=1	(toggle=2)			
178B	6027	BUS AR	clear=0	set=1	(toggle=2)			
178C	6028	BUS BL	clear=0	set=1	(toggle=2)			
178D	6029	BUS BR	clear=0	set=1	(toggle=2)			
1838	6200	Input	Static Display (no control)					

```

1839 6201 Std Static Display (no control)
183A 6202 Reference Static Display (no control)
183B 6203 EDH Static Display (no control)
183C 6204 EDH Err Static Display (no control)
183D 6205 RollTrack Static Display (no control)
183E 6206 De-emb 1 Static Display (no control)
183F 6207 De-emb 2 Static Display (no control)
1840 6208 De-emb 3 Static Display (no control)
1841 6209 De-emb 4 Static Display (no control)
1842 6210 De-emb 5 Static Display (no control)
1843 6211 De-emb 6 Static Display (no control)

1844 6212 De-emb 7 Static Display (no control)
1845 6213 De-emb 8 Static Display (no control)
1846 6214 nPCM 1 Static Display (no control)
1847 6215 nPCM 2 Static Display (no control)
1848 6216 nPCM 3 Static Display (no control)
1849 6217 nPCM 4 Static Display (no control)
184A 6218 nPCM 5 Static Display (no control)
184B 6219 nPCM 6 Static Display (no control)
184C 6220 nPCM 7 Static Display (no control)
184D 6221 nPCM 8 Static Display (no control)
184E 6222 ANALOG 1L Static Display (no control)
184F 6223 ANALOG 1R Static Display (no control)
1850 6224 ANALOG 2L Static Display (no control)
1851 6225 ANALOG 2R Static Display (no control)
1852 6226 BUS AL Static Display (no control)
1853 6227 BUS AR Static Display (no control)
1854 6228 BUS BL Static Display (no control)
1855 6229 BUS BR Static Display (no control)
1859 7001 Software Version Static Display (no control)
185A 7002 FPGA Sync Version Static Display (no control)
185B 7003 FPGA Dec Version Static Display (no control)
185D 7005 Serial Number Static Display (no control)
1860 7008 <Information Window> 1=Factory Default
1861 7009 Build Number Static Display (no control)
1DB0 7600 Luma Strength min=0 max=31 Step=1
1DB1 7601 Chroma Strength min=0 max=31 Step=1
1DB2 7602 <Threshold Mode> 0=Auto 1=Manual
1DB3 7603 Manual Threshold min=0 max=15 Step=1
1DB4 7604 Auto Bias min=-7 max=7 Step=1
1DB5 7605 <Delay Mode> 0=Normal Delay 1=Minimum Delay
1DB6 7606 Noise Measured Static Display (no control)
1F40 8000 <Information Window> 1=Error Seconds Reset
1F41 8001 <Information Window> 1=Restart
1F4A 8010 <Information Window> 0=Input Status 1=EDH & ANC Status 2=Audio Input Status
1FA4 8100 <Default Output> 0=Pass Video 1=Freeze 2=Pattern 3=Pattern&Caption
2008 8200 <Default Pattern> 0=Black 1=EBU Color Bars 2=100% Color Bars 3=Ramp
4=Multi-Burst 5=Pulse & Bar

2009 8201 Default Caption Edit String
3202 12802 Animated Pattern clear=0 set=1 (toggle=2)

```

RollTrack Audio Delay Tracking

RollTrack is a feature of RollCall™ (Snell & Wilcox’s proprietary remote control system), that allows devices to communicate across the RollCall network with no direct user intervention.

RollTrack Audio Delay Tracking enables Snell & Wilcox RollCall™ compatible audio delay products to track delay introduced by RollCall™ compatible video processing products.

The current products that implement RollTrack Audio Delay Tracking are:

Audio Delay Modules	Video Modules	Other Products	
IQBAAD	IQD1FSY	ALCHEMIST	MDD3000
IQBADC	IQDMSDS	CPP100	MDD550
IQBDAC	IQDAFS	CPP200	MDD560
IQBDAD	IQDMSDS	NRS500	MDD570
IQBSYN	IQDMSDP	HD5050	MDD2000
IQBADCD	IQDSYN		

The simplest configuration is a single video unit and a single audio delay in a RollCall™ system. The audio delay will have the same delay as through the video path. If the delay changes the audio delay will track.

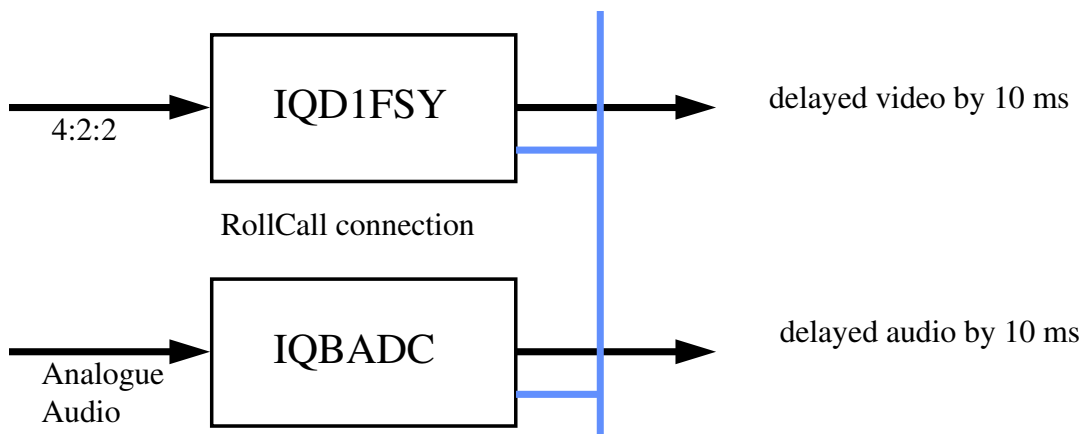

The next level of configuration is where there are multiple Frame Synchronizers (for example) each connected through RollCall™ to their own tracking Audio Delay. (It is worth stating that the synchronizers and audio delays do not have to be in the same enclosure; the addressing scheme, discussed later, allows for the units to be positioned anywhere in the RollCall™ domain.)

The maximum number of video units and audio delays in a RollCall™ system is set by the maximum limit of the number of modules in a RollCall™ network and is currently 3840 on a single network without bridges.

The unique identification of the destination unit (a decimal number) for various modules is as follows:

Module	ID
IQBADC	51
IQBDAC	52
IQBAAD	53
IQBDAD	54
IQBSYN	89
IQBADCD	107

The next level of complexity is a *vertical delay cluster* where a video unit can have up to eight audio delays tracking - of the same or different types.

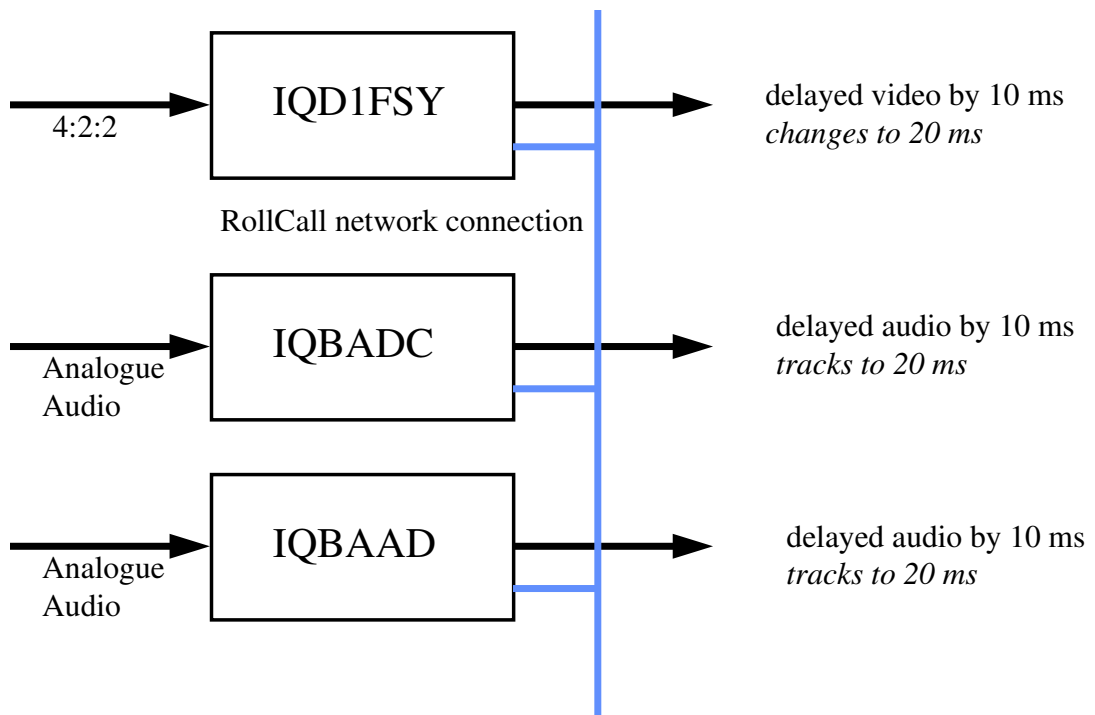

From one to eight audio delay products can be connected via RollCall™ to a single frame synchronizer, for example. If the synchronizer delay changes, then however many audio delays are connected will track the delay. The audio delays can also have a manual delay which will be added to the RollTrack delay.

The next level of complexity is a *horizontal delay cluster* where an audio delay can track up to four video units.

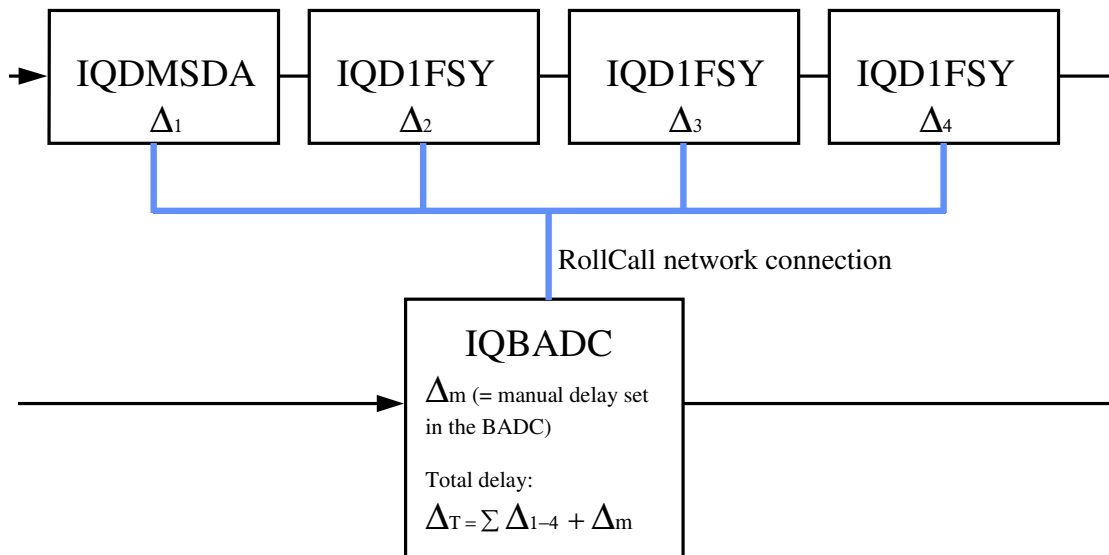

The total delay time through the audio delay is then the sum of the individual delays introduced by the video units plus the manual delay of the audio unit. The manual delay can be set to compensate for any fixed propagation delay in the video path or may be set to zero.

The next level of complexity is a *matrix delay cluster* where each audio delay (up to eight) can track up to four video units. This configuration is in effect a four by eight matrix of video units and audio delay units. The total delay time through the audio delay units is then the sum of the individual delays introduced by the video units plus the manual delay of the audio unit.

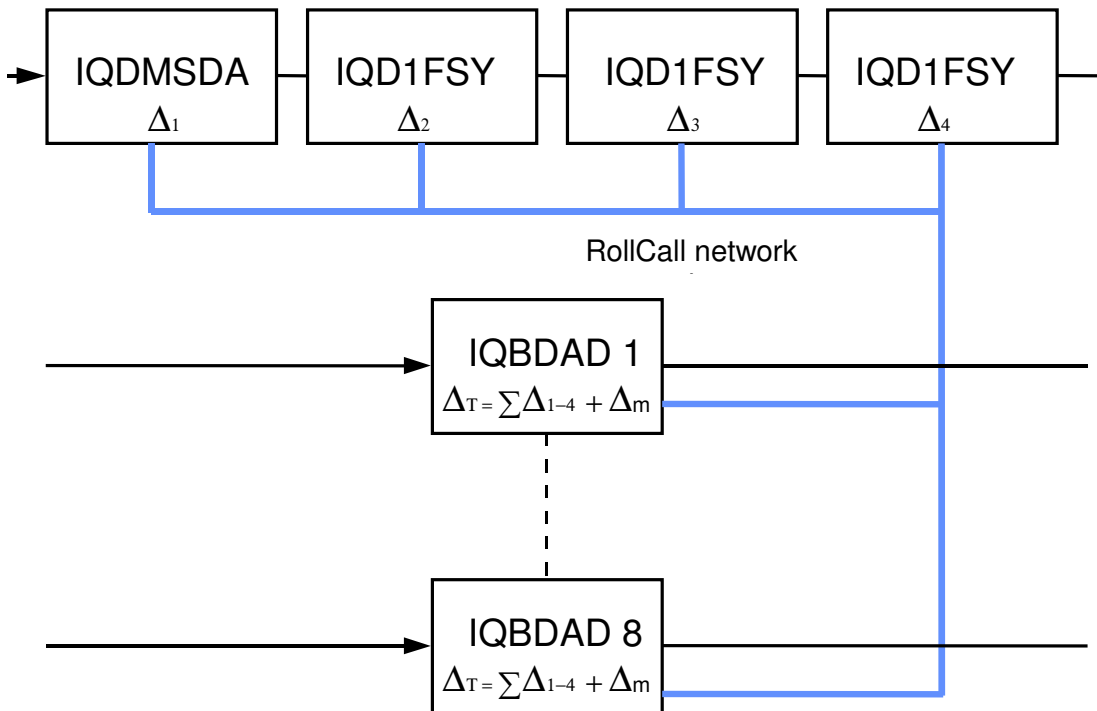

As any of the delay times change in the video path so will the audio delay time track this delay. A virtual connection is made between from, say, an IQD1FSY to an IQBDAD by:

- selecting the *Setup...* Menu of the IQD1FSY
- then selecting the *Audio_Delay...* Menu
- then choosing from *Unit_1* to *Unit_8*
- then entering the unique network address of the IQBDAD in the form $nnnn:xx:yy*z*d$
- where $nnnn$ = network address and in most cases will be 0000(hex);
- xx = IQ enclosure address (hex);
- yy = slot address of the IQBDAD (hex)
- z = the connection (or channel) number (decimal) - see table below.
- d = the unique identification of the destination unit (decimal) The ID entered must match the receiving units own ID or else the command will be ignored. If the ID value is set to 00, the receiving unit does not perform an ID match and will always accept the incoming command
- then selecting the *Delay...* Menu of the IQBDAD
- then selecting *RollTrack*

Example of Network Addresses with Channel Numbers and ID Numbers

	D1FSY 1	D1FSY 2	D1FSY 3	D1FSY 4
Audio delay 1	0000:10:01*14*54	0000:10:01*15*54	0000:10:01*16*54	0000:10:01*17*54
Audio delay 2	0000:10:03*14*54	0000:10:03*15*54	0000:10:03*16*54	0000:10:03*17*54
Audio delay 3	0000:10:05*14*54	0000:10:05*15*54	0000:10:05*16*54	0000:10:05*17*54
Audio delay 4	0000:10:07*14*54	0000:10:07*15*54	0000:10:07*16*54	0000:10:07*17*54
Audio delay 5	0000:10:09*14*54	0000:10:09*15*54	0000:10:09*16*54	0000:10:09*17*54
Audio delay 6	0000:10:0B*14*54	0000:10:0B*15*54	0000:10:0B*16*54	0000:10:0B*17*54
Audio delay 7	0000:10:0D*14*54	0000:10:0D*15*54	0000:10:0D*16*54	0000:10:0D*17*54
Audio delay 8	0000:10:0F*14*54	0000:10:0F*15*54	0000:10:0F*16*54	0000:10:0F*17*54

The most complex system would be an array of matrix delay clusters

