



Snell  
Advanced  
Media

---

# Installation and User Manual

## **IQH1A**

IQ 1U Modular Enclosure

## About this Manual

### Products Covered

This manual provides information for the installation and operation of the SAM IQH1A 1U modular enclosure fitted with the RCIF3U2C Gateway Card.

### Software Version

This unit is fitted with software version 5.19.19.

### Manufacturer's Notice

Copyright protection claimed includes all forms and matters of copyrightable material and information now allowed by statutory or judicial law or hereinafter granted, including without limitation, material generated from the software programs which are displayed on the screen such as icons, screen display looks, etc.

The software described in this manual is furnished under a license agreement and may not be reproduced or copied in any manner without prior agreement with SAM, or their authorized agents. Information in this manual and software are subject to change without notice and does not represent a commitment on the part of SAM.

Reproduction or disassembly of embedded computer programs or algorithms prohibited.

SAM operates a policy of continuous improvement and development. SAM reserves the right to make changes and improvements to any of the products described in this document without prior notice.

No responsibility is taken by the manufacturer or supplier for any non-compliance to EMC standards due to incorrect installation.

All rights reserved. No part of this publication can be transmitted or reproduced in any form or by any means, electronic or mechanical, including photocopy, recording or any information storage and retrieval system, without permission being granted, in writing, by the publishers or their authorized agents.

### Trademarks

Microsoft® is a registered trademark of Microsoft® Corporation in the United States and other countries.

Windows® is a registered trademark of Microsoft® Corporation in the United States and other countries.

RollCall™ is a trademark of SAM.

# Safety Notices

## Explanation of Safety Symbols GB

This symbol refers the user to important information contained in the accompanying literature. Refer to manual.

This symbol indicates that hazardous voltages are present inside. No user serviceable parts inside. This unit should only be serviced by trained personnel.

### Safety Warnings

**CAUTION**

RISK OF ELECTRIC SHOCK  
DO NOT REMOVE COVERS  
NO USER SERVICEABLE PARTS  
REFER SERVICING TO QUALIFIED PERSONNEL ONLY

**CAUTION:** These servicing instructions are for use by qualified personnel only.

To reduce risk of electric shock do not perform any servicing other than that contained in the Operating Instructions unless you are qualified to do so. Refer all servicing to qualified service personnel.

- To reduce the risk of electric shock, do not expose this appliance to rain or moisture.
- Always ensure that the unit is properly earthed and power connections correctly made.
- This equipment must be supplied from a power system providing a **PROTECTIVE EARTH** connection and having a neutral connection which can be reliably identified.
- The power outlet supplying power to the unit should be close to the unit and easily accessible

### Power connection in countries other than the USA

The equipment is normally shipped with a power cable with a standard IEC moulded free socket on one end and a standard IEC moulded plug on the other. If you are required to remove the moulded mains supply plug, dispose of the plug immediately in a safe manner.

The colour code for the lead is as follows:

GREEN/YELLOW lead connected to E (Protective Earth Conductor)  
 BLUE lead connected to N (Neutral Conductor)  
 BROWN lead connected to L (Live Conductor)



Caution If the unit has two mains supply inputs ensure that both power cords are plugged into mains outlets operating from the same phase.

## Erklärung der Sicherheitssymbole D

Dieses Symbol weist den Benutzer auf wichtige Informationen hin, die in der begleitenden Dokumentation enthalten sind.

Dieses Symbol zeigt an, dass gefährliche Spannung vorhanden ist. Es befinden sich keine vom Benutzer zu wartende Teile im Geräteinneren. Dieses Gerät sollte nur von geschultem Personal gewartet werden

### Sicherheits-Warnhinweise

**ACHTUNG**

Gefahr von Elektroschocks.  
Abdeckungen nicht entfernen  
Keine vom Benutzer zu wartende Teile  
Wenden Sie sich ausschließlich an qualifiziertes Personal

Die angeführten Service-/Reparatur-Anweisungen sind ausschließlich von qualifiziertem Service-Personal auszuführen. Um das Risiko eines Iektroschocks zu reduzieren, führen Sie ausschließlich die im Benutzerhandbuch beschriebenen Anweisungen aus, es sei denn, Sie haben die entsprechende Qualifikation. Wenden Sie sich in allen Service-Fragen an qualifiziertes Personal.

- Um das Risiko eines Elektroschocks zu reduzieren, setzen Sie das Gerät weder Regen noch Feuchtigkeit aus.
- Stellen Sie immer sicher, dass das Gerät ordnungsgemäß geerdet und verkabelt ist.
- Dieses Equipment muss an eine Netzsteckdose mit Schutzleiter angeschlossen werden und einen zuverlässig identifizierbaren Nulleiter haben.
- Die Netzsteckdose sollte nahe beim Gerät und einfach zugänglich sein.

### Netzanschluss in anderen Ländern als der USA

Das Equipment wird im Normalfall mit einem Netzkabel mit Standard IEC Anschlussbuchse und einem Standard IEC Anschlussstecker geliefert. Sollten Sie den angeschweißten Stecker auswechseln müssen, entsorgen Sie diesen bitte umgehend. Die farbliche Belegung des Netzkabels ist wie folgt:

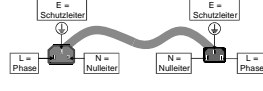

GRÜN GELB E = Schutzleiter  
 BLAU N = Nulleiter  
 BRAUN L = P = Phase

Achtung: Wenn das Gerät zwei Anschlussbuchsen hat, stellen Sie bitte sicher, dass beide Netzkabel mit der selben Phase in die Netzsteckdose gesteckt werden.

## Légende : F

Ce symbole indique qu'il faut prêter attention et se référer au manuel.

Ce symbole indique qu'il peut y avoir des tensions électriques à l'intérieur de l'appareil. Ne pas intervenir sans l'agrément du service qualifié.

### Précaution d'emploi :

**ATTENTION**

RISQUE DE CHOC ELECTRIQUE  
NE PAS RETIRER LE COUVERCLE  
NE PAS INTERVENIR SANS L'AGREMENT DU SERVICE QUALIFIE

**Attention:** Les procédures de maintenance ne concernent que le service agréé. Afin de réduire le risque de choc électrique, il est recommandé de se limiter aux procédures d'utilisation, à moins d'en être qualifié. Pour toute maintenance, contacter le service compétent.

- Pour réduire le risque de choc électrique, ne pas exposer l'appareil dans un milieu humide.
- Toujours s'assurer que l'unité est correctement alimentée, en particuliers à la liaison à la terre.
- La source électrique de cet équipement doit posséder une connexion à la terre, ainsi qu'une liaison « neutre » identifiable.
- La prise électrique qui alimente l'appareil doit être proche de celle-ci et accessible.

### Câble secteur de pays autres que les Etats-Unis

L'équipement est livré avec un câble secteur au standard IEC, moulé mâle/femelle. Si vous souhaitez changer la prise mâle de votre cordon, voici les codes couleurs des fils :

Le fil VERT/JAUNE est connecté à T (Terre)  
 Le fil BLEU est connecté à N (Neutre)  
 Le fil MARRON est connecté à P (Phase)



Attention si l'appareil a 2 alimentations, s'assurer que les cordons soient branchés sur la même phase.

## Explicación de los Símbolos de Seguridad ESP

Éste símbolo refiere al usuario información importante contenida en la literatura incluida. Referirse al manual.

Éste símbolo indica que voltajes peligrosos están presentes en el interior. No hay elementos accesibles al usuario dentro. Esta unidad sólo debería ser tratada por personal cualificado.

### Advertencias de Seguridad

**ADVERTENCIA**

RIESGO DE CHOQUE ELECTRICO  
NO QUITAR LAS PROTECCIONES  
ELEMENTOS NO ACCESIBLES AL USUARIO.  
SERVICIO SOLAMENTE A PERSONAL CUALIFICADO

Las instrucciones de servicio cuando sean dadas, son sólo para uso de personal cualificado. Para reducir el riesgo de choque eléctrico no llevar a cabo ninguna operación de servicio aparte de las contenidas en las instrucciones de operación, a menos que se esté cualificado para realizarlas. Referir todo el trabajo de servicio a personal cualificado.

- Para reducir el riesgo de choque eléctrico, no exponer este equipo a la lluvia o humedad.
- Siempre asegurarse de que la unidad está propiamente conectada a tierra y que las conexiones de alimentación están hechas correctamente.
- Este equipo debe ser alimentado desde un sistema de alimentación con conexión a TIERRA y teniendo una conexión neutra fácilmente identificable.
- La toma de alimentación para la unidad debe ser cercana y fácilmente accesible.

### Conexión de alimentación en otros países que no sean USA

El equipo es normalmente entregado con un cable de alimentación con un enchufe hembra estándar IEC en un extremo y con una clavija estándar IEC en el otro. Si se requiere eliminar la clavija para sustituirla por otra, disponer dicha clavija de una forma segura. El código de color a emplear es como sigue:



VERDE/ AMARILLO conectado a E (Conductor de protección a Tierra -Earth en el original-)  
 AZUL conectado a N (Conductor Neutro -Neutro en el original-)  
 MARRÓN conectado a L (Conductor Fase -Live en el original-)

Advertencia Si la unidad tuviera dos tomas de alimentación, asegurarse de que ambos cables de alimentación están conectados a la misma fase.

**Simboli di sicurezza:**

Questo simbolo indica l'informazione importante contenuta nei manuali appartenenti all'apparecchiatura. Consultare il manuale.

Questo simbolo indica che all'interno dell'apparato sono presenti tensioni pericolose. Non cercare di smontare l'unità. Per qualsiasi tipo di intervento rivolgersi al personale qualificato.

**Attenzione:**

Le istruzioni relative alla manutenzione sono ad uso esclusivo del personale qualificato. È proibito all'utente eseguire qualsiasi operazione non esplicitamente consentita nelle istruzioni. Per qualsiasi informazione rivolgersi al personale qualificato.

- Per prevenire il pericolo di scosse elettriche è necessario non esporre mai l'apparecchiatura alla pioggia o a qualsiasi tipo di umidità.
- Assicurarsi sempre, che l'unità sia propriamente messa a terra e che le connessioni elettriche siano eseguite correttamente.
- Questo dispositivo deve essere collegato ad un impianto elettrico dotato di un sistema di messa a terra efficace.
- La presa di corrente deve essere vicina all'apparecchio e facilmente accessibile.

**Connessione elettrica nei paesi diversi dagli Stati Uniti**

L'apparecchiatura normalmente è spedita con cavo pressofuso con la presa e spina standard IEC. Nel caso della rimozione della spina elettrica, gettarla via immediatamente osservando tutte le precauzioni del caso. La leggenda dei cavi è la seguente:

VERDE/GIALLO cavo connesso ad "E" (terra)  
BLU cavo connesso ad "N" (neutro)  
MARRONE cavo connesso ad "L" (fase)



Attenzione! Nel caso in cui l'apparecchio abbia due prese di corrente, assicurarsi che i cavi non siano collegati a fasi diverse della rete elettrica.

**Forklaring på sikkerhedssymboler**

Dette symbol gør brugeren opmærksom på vigtig information i den medfølgende manual.

Dette symbol indikerer farlig spænding inden i apparatet. Ingen bruger servicebare dele i apparatet på brugerniveau. Dette apparat må kun serviceres af faglærte personer..

**Sikkerhedsadvarsler**

Serviceinstruktioner er kun til brug for faglærte servicefolk. For at reducere risikoen for elektrisk stød må bruger kun udføre anvisninger i betjeningsmanualen. Al service skal udføres af faglærte personer.

- For at reducere risikoen for elektrisk stød må apparatet ikke udsættes for regn eller fugt.
- Sørg altid for at apparatet er korrekt tilsluttet og jordat.
- Dette apparat skal forbindes til en nettilslutning, der yder BESKYTTENDE JORD (⊕) og 0 forbindelse skal være tydeligt markeret.
- Stikkontakten, som forsyner apparatet, skal være tæt på apparatet og let tilgængelig.

**Nettilslutning i andre lande end USA**

Udstyret leveres normalt med et strømkabel med et standard IEC støbt løst hanstik i den ene ende og et standard IEC støbt hanstik i den anden ende. Hvis et af de støbte stik på strømkablet er defekt, skal det straks kasseres på forsvarlig vis. Farvekoden for lederen er som følger:

GRØN/GUL leder forbundet til J (Jord)  
BLÅ leder forbundet til 0  
BRUN leder forbundet til F(Fase)



Forsigtig Hvis enheden har to lysnetindgange, skal der sørges for at begge ledninger tilsluttes lysnetudgange fra den samme fase.

**Förklaring av Säkerhetssymboler**

Denna symbol hänvisar användaren till viktig information som återfinns i litteraturen som medföljer. Se manualen.

Denna symbol indikerar att livsfarlig spänning finns på insidan. Det finns inga servicevänliga delar inne i apparaten. Denna apparat få endast repareras av utbildad personal.

**Säkerhetsvarningar**

Serviceinstruktioner som anges avser endast kvalificerad och utbildad servicepersonal. För att minska risken för elektrisk stöt, utför ingen annan service än den som återfinns i medföljande driftinstruktionerna, om du ej är behörig. Överlåt all service till kvalificerad personal.

- För att reducera risken för elektrisk stöt, utsätt inte apparaten för regn eller fukt.
- Se alltid till att apparaten är ordentligt jordad samt att strömtillförseln är korrekt utförd.
- Denna apparat måste bli försörjd från ett strömsystem som är försedd med jordanslutning (⊕) samt ha en neutral anslutning som lätt identifierbar.
- Väggtuttaget som strömförsörjer apparaten bör finnas i närheten samt vara lättillgänglig.

**Strömkontakter i länder utanför USA**

Apparaten utrustas normalt med en strömkabel med standard IEC gjuten honkontakt på ena änden samt en standard IEC gjuten hankontakt på den andra änden. Om man måste avlägsna den gjutna hankontakten, avyttra denna kontakt omedelbart på ett säkert sätt. Färgkoden för ledningen är följande:

GRÖN/GUL ledning ansluten till E (Skyddsjordad ledare)

BLÅ ledning ansluten till N (Neutral ledare)  
BRUN ledning ansluten till L (Fas ledare)



Varning! Om enheten har två huvudsakliga elförsörjningar, säkerställ att båda strömkablarna som är inkopplade i enheten arbetar från samma fas.

**Turvamerkkien selitys**

Tämä merkki tarkoittaa, että laitteen mukana toimitettu kirjallinen materiaali sisältää tärkeitä tietoja. Lue käyttöohje.

Tämä merkki ilmoittaa, että laitteen sisällä on vaarallisen voimakas jännite. Sisäpuolella ei ole mitään osia, joita käyttäjä voisi itse huoltaa. Huollon saa suorittaa vain alan ammattilainen.

**Turvaohjeita**

Huolto-ohjeet on tarkoitettu ainoastaan alan ammattilaisille. Älä suorita laitteelle muita toimenpiteitä, kuin mitä käyttöohjeissa on neuvottu, ellei ole asiantuntija. Voit saada sähköiskun. Jätä kaikki huoltotoimet ammattilaiselle.

- Sähköiskujen välttämiseksi suojaa laite sateelta ja kosteudelta.
- Varmistu, että laite on asianmukaisesti maadoitettu ja että sähkökytkennät on tehty oikein.
- Laitteelle tehoa syöttävässä järjestelmässä tulee olla SUOJAMAALIITÄNTÄ (⊕) ja nolllaliitännän on oltava luotettavasti tunnistettavissa.
- Sähköpistorasian tulee olla laitteen lähellä ja helposti tavoitettavissa.

**Sähkökytkentä**

Laitteen vakiovarusteena on sähköjohto, jonka toisessa päässä on muottiin valettu, IEC-standardin mukainen liitäntärasia ja toisessa päässä muottiin valettu, IEC-standardin mukainen pistoliitin. Jos pistoliitin tarvitsee poistaa, se tulee hävittää heti turvallisella tavalla. Johtimet kytketään seuraavasti:

KELTA-VIHREÄ suojamaajohdin E-napaan  
SININEN nolllajohdin N-napaan  
RUSKEA vaihejohdin L-napaan



Huom! Jos laitteessa on kaksi verkkojännitteen tuloliitäntää, niiden johdot on liitettävä verkkopistorasioihin, joissa on sama vaiheistus.

### Símbolos de Segurança P

O símbolo triangular adverte para a necessidade de consultar o manual antes de utilizar o equipamento ou efectuar qualquer ajuste.

Este símbolo indica a presença de voltagens perigosas no interior do equipamento. As peças ou partes existentes no interior do equipamento não necessitam de intervenção, manutenção ou manuseamento por parte do utilizador. Reparações ou outras intervenções devem ser efectuadas apenas por técnicos devidamente habilitados.

### Avisos de Segurança

**PERIGO**

RISCO DE CHOQUE ELÉCTRICO!  
NÃO RETIRAR AS PROTECÇÕES  
PARTES QUE NÃO REQUEREM  
INTERVENÇÃO DO UTILIZADOR!  
CONTACTAR UM TÉCNICO  
DEVIDAMENTE HABILITADO!

As instruções de manutenção fornecidas são para utilização de técnicos qualificados. Para reduzir o risco de choque eléctrico, não devem ser realizadas intervenções no equipamento não especificadas no manual de instalações a menos que seja efectuadas por técnicos habilitados.

- Para reduzir o risco de choque eléctrico, não expor este equipamento à chuva ou humidade.
- Assegurar que a unidade está sempre devidamente ligada à terra e que as ligações à alimentação estão correctas.
- O sistema de alimentação do equipamento deve, por razões de segurança, possuir ligação a terra de protecção (⊕) e ligação ao NEUTRO devidamente identificada.
- A tomada de energia à qual a unidade está ligada deve situar-se na sua proximidade e facilmente acessível.

### Ligação da alimentação noutros países que não os EUA

O equipamento é, normalmente, enviado com cabo de alimentação com ficha IEC fêmea standard num extremo e uma ficha IEC macho standard no extremo oposto. Se for necessário substituir ou alterar alguma destas fichas, deverá removê-la e eliminá-la imediatamente de maneira segura. O código de cor para os condutores é o seguinte:

Condutor VERDE/AMARELO ligado a E (Terra)  
Condutor AZUL ligado a N (Neutro)  
Condutor CASTANHO ligado a L (Vivo).

Atenção: Se a unidade tem duas fontes de alimentação assegurar que os dois cabos de alimentação estão ligados a tomadas pertencentes à mesma fase.

### Επεξήγηση των Συμβόλων Ασφαλείας G

Αυτό το σύμβολο παραπέμπει το χρήστη σε σημαντικές πληροφορίες που συμπεριλαμβάνονται στο συνοδευτικό εγχειρίδιο.

Αυτό το σύμβολο υποδεικνύει ότι στο εσωτερικό υφίστανται επικίνδυνες ηλεκτρικές τάσεις. Στο εσωτερικό δεν υπάρχουν επισκευάσιμα μέρη. Αυτή η μονάδα πρέπει να επισκευάζεται μόνο από ειδικά εκπαιδευμένο προσωπικό.

### Προειδοποίηση Ασφαλείας

**CAUTION**

RISK OF ELECTRIC SHOCK  
DO NOT REMOVE COVERS  
NO USER SERVICEABLE PARTS  
REFER SERVICES TO QUALIFIED  
PERSONNEL ONLY

Οδηγίες επισκευής, όπου παρέχονται, αναφέρονται αποκλειστικά και μόνο σε εξειδικευμένο προσωπικό. Για να μειωθεί ο κίνδυνος ηλεκτροπληξίας, μην εκτελείτε επισκευές παρά μόνο τις συμπεριλαμβανόμενες στο εγχειρίδιο των οδηγιών, εκτός και αν έχετε τα απαραίτητα προσόντα για να το κάνετε. Όλες οι επισκευές να εκτελούνται από ειδικά εκπαιδευμένο προσωπικό.

- Για να μειώσετε τον κίνδυνο ηλεκτροπληξίας, μην εκθέτετε τη συσκευή σε βροχή ή υγρασία.
- Πάντα να εξασφαλίζετε τη σωστή γείωση της συσκευής και τη σωστή σύνδεση των συνδέσμων τροφοδοσίας.
- Ο εξοπλισμός πρέπει να τροφοδοτείται από ένα σύστημα τροφοδοσίας που να εξασφαλίζει ΠΡΟΣΤΑΤΕΥΤΙΚΗ ΓΕΙΩΣΗ (⊕) και να έχει καθορισμένες θέσεις ουδέτερου και φάσης.
- Ο εξοπλισμός που τροφοδοτεί τη συσκευή θα πρέπει να βρίσκεται κοντά στη συσκευή και να είναι εύκολα προσβάσιμος.

### Σύνδεση τροφοδοσίας σε χώρες εκτός των ΗΠΑ

Ο εξοπλισμός συνοδεύεται συνήθως από ένα καλώδιο τροφοδοσίας με ένα σταθερό βύσμα τροφοδοσίας τύπου πυραμίδας στη μια άκρη του και μια σταθερή υποδοχή τροφοδοσίας τύπου πυραμίδας στην άλλη άκρη του. Εάν χρειαστεί να αφαιρέσετε το σταθερό βύσμα τροφοδοσίας μην το επαναχρησιμοποιείτε, θεωρείται άχρηστο. Ο χρωματικός οδηγός για το καλώδιο τροφοδοσίας είναι ο παρακάτω:

ΠΡΑΣΙΝΟ/ΚΙΤΡΙΝΟ καλώδιο συνδέεται στο E (Προστατευτικός Αγωγός Γείωσης)  
ΜΠΛΕ καλώδιο συνδέεται στο N (Ουδέτερο Αγωγό)  
ΚΑΦΕ καλώδιο συνδέεται στο L (Αγωγό Φάσης)

ΠΡΟΣΟΧΗ! Αν η μονάδα έχει δύο τροφοδοτικά βεβαιωθείτε ότι και τα δύο καλώδια τροφοδοσίας είναι συνδεδεμένα σε εξόδους τροφοδοσίας που βρίσκονται στην ίδια φάση.

## Products Employing Lithium Batteries



This equipment contains a lithium battery. **There is a danger of explosion if this is replaced incorrectly.** Replace only with the same or equivalent type. Dispose of used batteries according to the instructions of the manufacturer. Batteries should only be replaced by trained service technicians.

## Power Cable Supplied for the USA

The equipment is shipped with a power cord with a standard IEC molded free socket on one end and a standard 3-pin plug on the other. If you are required to remove the molded mains supply plug, dispose of the plug immediately in a safe manner.

The color code for the cord is as follows:

- GREEN lead connected to E (Protective Earth Conductor)
- BLACK lead connected to L (Live Conductor)
- WHITE lead connected to N (Neutral Conductor)



Note:

The IQH1A-S-P-BNK product is supplied without mains power cables.

## For Products With More Than One Power Supply Inlet



To reduce the risk of electric shock plug each power supply cord into separate branch circuits employing separate service grounds.

Note:

The IQH1A-S-P-BNK product is supplied without mains power cables.

## Rack Mounting the Enclosure



This product must not be rack mounted using only the front rack ears.

When rack-mounting the product, one of the following methods of installation must be used:

- place the unit on a suitably specified, and installed rack shelf and secure the product to the rack via the front rack ears or,
- fit the unit using the rear rack mount kit available from SAM by quoting the order code FGACK RACK-MNT-KIT.

## Replacing the Gateway Card

If the Gateway Card IQRCIF is replaced ensure that the part number of the card is RCIF3U2C to enable the chassis monitoring facility. If it is replaced by an earlier Gateway Card, e.g. RCIF3U2B this will still offer full control of installed modules but will not enable the PSU and chassis monitoring.

## Safety Standards

The IQH1A IQ 1U Modular Enclosure conforms to the following standards:

### EN60950-1: 2001

Safety of Information Technology Equipment.

### UL Listed

Professional Video Equipment File No. E193966.



## EMC Standards

This unit conforms to the following standards:

### EN 55103-1: 1996 (Environment E4)

Electromagnetic Compatibility, Product family standard for audio, video, audio-visual and entertainment lighting control apparatus for professional use. Part 1. Emission.

### EN 55103-2: 1996 (Environment E2)

Electromagnetic Compatibility, Product family standard for audio, video, audio-visual and entertainment lighting control apparatus for professional use. Part 2. Immunity

Federal Communications Commission Rules Part 15, Class A:1998.

## EMC Environment

The product(s) described in this manual conform to the EMC requirements for, and are intended for use in the commercial and light industrial environment (Including, for example, theatres) E2.

## EMC Performance Information

Please refer to the *Technical Specification* section of the product operation manual.

## **EMC Performance of Cables and Connectors**

SAM products are designed to meet or exceed the requirements of the appropriate European EMC standards. In order to achieve this performance in real installations it is essential to use cables and connectors with good EMC characteristics.

All signal connections (including remote control connections) shall be made with screened cables terminated in connectors having a metal shell. The cable screen shall have a large-area contact with the metal shell.

### **Coaxial Cables**

Coaxial cables connections (particularly serial digital video connections) shall be made with high-quality double-screened coaxial cables such as Belden 1694 or BBC type PSF1/2M.

### **D-Type Connectors**

D-type connectors shall have metal shells making good RF contact with the cable screen. Connectors having "dimples" which improve the contact between the plug and socket shells are recommended.

## Product Support

### Providing Information to SAM

If you experience any technical or operational difficulties with a SAM product please do not hesitate to contact us to request assistance.

There is a lot of information you can give us that will enable us to diagnose your problem swiftly. Please read the following guidelines, as these suggestions will help us to help you.

#### Basic Information

- **For Units:** Please provide the exact product Model, unit Serial Number and Software Version information.
- **For Cards or Modules:** Please provide the Sub-Assembly Number, Card Serial Number and the Software Version information.

#### Basic Application

- **Inputs:** Please provide full details of the Input Signals being used including any references, etc., and where they are being generated.
- **Outputs:** Please provide full details of the Output Signals required and how they are being monitored.
- **System:** Please provide a brief description of the system in which your SAM equipment is currently being used.

#### Basic Tests

- **Preset Unit:** Please use the Preset Unit function to return the settings back to the factory default settings.
- **RollCall:** Is your unit currently connected to a RollCall capable PC? This software is obtainable for free and provides a very user friendly GUI for virtually all SAM equipment - perfect for complex products, large systems or those with passive front panels.
- **Card Edge Info:** What is the status of the card edge LEDs or display? These can often provide information such as power status and input detection conditions.
- **Internal TPG:** Many SAM products have an internal test pattern/tone generator. Please activate this to assist you with your problem analysis.

#### Your Contact Details

In addition to the above, please do not forget to provide us with your contact details to enable us to get in touch with you swiftly:

- name(s)
- telephone & fax numbers
- e-mail addresses
- business address

### Customer Support Contacts

#### Customer Support

For details of our Regional Customer Support Offices, please visit the SAM website and navigate to Support/Customer Support Contacts.

[www.s-a-m.com/support/contact-support/](http://www.s-a-m.com/support/contact-support/)

Customers with a support contract should call their personalized number, which can be found in their contract, and be ready to provide their contract number and details.



# Contents

<b>About this Manual</b> .....	2
Products Covered .....	2
Software Version .....	2
Manufacturer's Notice .....	2
Trademarks .....	2
<b>Safety Notices</b> .....	3
Products Employing Lithium Batteries .....	5
Power Cable Supplied for the USA .....	5
For Products With More Than One Power Supply Inlet .....	6
Rack Mounting the Enclosure .....	6
Replacing the Gateway Card .....	6
Safety Standards .....	6
EMC Standards .....	6
EMC Environment .....	6
EMC Performance Information .....	6
EMC Performance of Cables and Connectors .....	7
Coaxial Cables .....	7
D-Type Connectors .....	7
<b>Product Support</b> .....	8
Providing Information to SAM .....	8
Customer Support Contacts .....	8
<b>1 Introduction</b> .....	12
1.1 Unit Description .....	12
1.2 Order Codes .....	12
1.3 Front Panel View .....	12
1.4 Rear Panel View .....	12
1.5 Features .....	13
<b>2 Technical Specification</b> .....	14
<b>3 Installation</b> .....	15
3.1 Unpacking the Unit .....	15
3.2 Environment .....	15
3.3 Power Connections .....	16
3.4 Supply Voltage .....	16
3.5 Front Panel Indicator .....	17
3.6 Rear Panel Connections .....	18
3.6.1 Ethernet .....	18
3.6.2 Remote .....	18
3.6.3 RollNet .....	19
3.7 Opening the Front Panel .....	19
3.8 Power Standby LEDs .....	20
3.9 Front (Gateway Card) Controls and LEDs .....	21
3.9.1 Front Panel Connector .....	21
3.9.2 Mini 10-way Connector .....	21
3.9.3 HEX Switches .....	21
3.9.4 LEDs .....	21
3.10 Power Supply and Module Slot Locations .....	22
3.11 Installing and Removing Power Supply Units .....	23
3.11.1 Installing a Power Supply Unit .....	23
3.11.2 Removing a Power Supply Unit .....	23

3.12 Installing and Removing Modules . . . . .	24
3.12.1 Installing a New Module . . . . .	24
3.12.2 Removing a Module . . . . .	24
3.12.3 Replacing a Module in a Live Environment . . . . .	24
3.13 Replacing the Cooling Fan Assembly . . . . .	25
3.14 Replacing a Fan Unit in a Live Environment . . . . .	26
3.15 Control Panels . . . . .	26
3.15.1 RollCall Communications System . . . . .	26
3.15.2 Ethernet Connection . . . . .	29
3.15.3 Simple Network Management Protocol (SNMP) . . . . .	31
3.15.4 IP Bridging . . . . .	32
<b>4 Operation . . . . .</b>	<b>34</b>
4.1 Unit Status . . . . .	34
4.1.1 Line 1 . . . . .	34
4.1.2 Line 2 . . . . .	34
4.1.3 Line 3 . . . . .	35
4.2 Setup . . . . .	36
4.2.1 Unit Name . . . . .	36
4.2.2 Serial Number . . . . .	36
4.2.3 Hardware Version . . . . .	37
4.2.4 Enclosure . . . . .	37
4.2.5 Software Version . . . . .	37
4.2.6 Build Number . . . . .	37
4.2.7 Loader Version . . . . .	37
4.2.8 Java Applet Version . . . . .	37
4.2.9 Menu Caches (Module) . . . . .	37
4.2.10 Start Time . . . . .	37
4.2.11 Misc Information 1/2 . . . . .	37
4.2.12 Http Server . . . . .	37
4.2.13 Module Upgrades . . . . .	38
4.2.14 Power Usage . . . . .	38
4.2.15 Setup . . . . .	38
4.2.16 Serial Port Setup . . . . .	38
4.2.17 Long File packets . . . . .	39
4.3 Ethernet . . . . .	40
4.3.1 Unit IP Address / Subnet mask / Default gateway address . . . . .	40
4.3.2 TAKE IP address changes! . . . . .	41
4.3.3 Link Status . . . . .	41
4.3.4 IP Routing Setup Status . . . . .	41
4.3.5 Link Speed . . . . .	41
4.3.6 MAC address . . . . .	41
4.3.7 Hyperion TCP Port . . . . .	41
4.3.8 Check client IP . . . . .	41
4.3.9 Client IP Ranges . . . . .	41
4.4 RollCall IP . . . . .	42
4.4.1 Enable Stats . . . . .	42
4.4.2 Reset Counts . . . . .	42
4.4.3 IP Share Port . . . . .	42
4.4.4 Pass WAN Packets . . . . .	43
4.4.5 RollCall IP Connections . . . . .	43
4.4.6 RollCall IP History . . . . .	43
4.4.7 RollCall IP Bridging . . . . .	44

4.5 Log Server . . . . .	46
4.5.1 LogServer . . . . .	46
4.5.2 Logging Disabled . . . . .	46
4.5.3 Named LogServer . . . . .	46
4.5.4 Any LogServer . . . . .	46
4.5.5 Using . . . . .	46
4.5.6 Accept logserver via RollNet . . . . .	46
4.5.7 Accept logserver via IP . . . . .	46
4.5.8 Accept logserver via Serial . . . . .	47
4.5.9 Accept logserver via Bridge . . . . .	47
4.5.10 Last Time source . . . . .	47
4.5.11 Only Accept Time from Logserver . . . . .	47
4.6 Slots (1-4) . . . . .	48
4.6.1 Name . . . . .	48
4.6.2 Type . . . . .	49
4.6.3 Non RollCall . . . . .	49
4.6.4 Information Field(s) . . . . .	50
4.6.5 Power Usage . . . . .	50
4.6.6 Examples of Slot Use . . . . .	51
4.7 Control (1-4) . . . . .	52
4.7.1 Update Packet Stats . . . . .	52
4.7.2 Clear Packet Counts . . . . .	52
4.7.3 Slots 1 to 4 . . . . .	53
4.7.4 Show Session . . . . .	53
4.8 Gateway Control . . . . .	54
4.8.1 Control . . . . .	54
4.8.2 Blind Control . . . . .	55
4.8.3 Statistics Control . . . . .	55
4.9 SNMP (Simple Network Management Protocol) . . . . .	56
4.9.1 Enable SNMP . . . . .	56
4.9.2 Enable Legacy SNMP . . . . .	57
4.9.3 Read community . . . . .	57
4.9.4 MIB2 sysContact . . . . .	57
4.9.5 MIB2 sysLocation . . . . .	57
4.9.6 Write community . . . . .	57
4.9.7 MIB2 sysName . . . . .	57
4.9.8 Read Write Port . . . . .	57
4.9.9 Resend All Traps . . . . .	57
4.9.10 Traps . . . . .	57
4.9.11 Slot Trap Enable . . . . .	58
4.9.12 SNMP Control . . . . .	58
4.10 Logging 1 . . . . .	59
4.11 Logging 2 . . . . .	62
4.12 Statistics . . . . .	65
4.12.1 Statistics . . . . .	65
<b>5 RollCall Control Panel Applet . . . . .</b>	<b>67</b>
5.1 Pre-requisites for Running the Applet . . . . .	67
5.2 Opening the RollCall Control Panel Applet . . . . .	67

# 1 Introduction

## 1.1 Unit Description

IQH1A IQ 1U Modular Enclosures offer industry leading, high-density delivery of HD and SD modular solutions. The 1U rack unit accepts up to four 'A' style modules, and is available in single and dual redundant PSU versions. RollCall control and monitoring is included as standard using a Gateway control card. Full SNMP control and monitoring functionality is also available over Ethernet.

## 1.2 Order Codes

The following product order codes are covered by this manual:

### Enclosures

- IQH1A-S-0** Enclosure with Single PSU and Ethernet/SNMP Compatible RollCall Gateway Card. 4 module slots.
- IQH1A-S-P** Enclosure with Dual Redundant PSU and Ethernet/SNMP Compatible RollCall Gateway Card. 4 module slots.
- IQH1A-S-P-BNK** Enclosure with Dual Redundant PSU and Ethernet/SNMP Compatible RollCall Gateway Card. 4 module slots. Supplied with plain white (unbranded) front panel and without mains power cables.

### Accessories

- IQH1APSUB** Single PSU as cold spare or upgrade to Dual PSU configuration.
- IQH1A-S-GATEW** Ethernet/SNMP compatible RollCall Gateway Card for IQH1A enclosures
- IQH1A-FAN** Dual Fan unit for use as cold spare or replacement.

**Important:** Although IQ modules are interchangeable between enclosures, their rear panels are enclosure specific. Code 'A or B' order codes may be used when installing modules in the IQH3B enclosure. Code 'A' order codes must be used when installing modules in the IQH1A or IQH3A enclosures.

## 1.3 Front Panel View

The IQH1A enclosure front panel is shown below.



An older style IQH1A enclosure front panel is shown below.



## 1.4 Rear Panel View

The IQH1A enclosure rear panel (with modules fitted) is shown below.



## 1.5 Features

The IQH1A IQ 1U Modular Enclosure provides the following features:

- 4 single or 2 double width modules (or any combination)
- Capable of accepting all types of IQ Modules including HD-SDI, SD-SDI, AES and analog audio, analog video and fiber optics
- Dual Redundant power supplies (hot swappable) for high system availability
- Optimum use of rack space – frames do not require any additional ventilation spacing
- Plug-in RollCall enabled via gateway card with TCP/IP, RollNet, SNMP and RS-232/422 connectivity
- In service replaceable cooling fans
- Chassis monitoring, including Inlet temperature, fan condition and module status
- Full CE and UL compliance

## 2 Technical Specification

<b>Inputs, Outputs and Controls</b>	
<b>Inputs/Outputs</b>	
RollCall Remote Control	BNC connector
RS-422/485/232 Remote Control	9-pin, D-type connector
RollCall/SNMP over TCP/IP	10/100 baseT Ethernet
<b>Preset Controls</b>	
Unit address code set switches	2 Hex switches 0 to F
Communications mode switch	Select RS-232, RS-485 or RS-422 interface
<b>Additional Controls via RollCall Remote Control System</b>	
Full Control via RollCall Control Panel PC Application.	
<b>Specifications</b>	
<b>Modules</b>	
Module Complement	2 double width or 4 single width (or combinations of both) fitted horizontally
Module Card Dimensions	100 mm wide, 340 mm long
Module Rear Connector	SD - 64-way HD/SD - 55-way Z pack + 6/9 coax inserts
Module Rear Panel Dimensions	129 mm high (-A versions), 40.4 mm (double width), 20 mm (single width) high
<b>Power</b>	
Input Voltage Range	100-250 V 50/60 Hz
Input Connector	IEC320 Fused T3 15AH
Input Current	2.5 A
Power Consumption	86.25 W maximum ( $\pm 7.5$ V supplies)
Outputs	+7.5 V and -7.5 V $\pm 10\%$ Fan Supply 11 V $\pm 1$ V 0.7 A typical
<i>Note that all modules have built-in power supply fuses</i>	
<b>CE Performance Information</b>	
Environment	Commercial and light industrial E2 immunity, controlled EMC E4 emissions
Peak Mains Inrush Current following a 5 second mains interruption	16 A
<b>Mechanical</b>	
Temperature Range	0 to 40° C operating, -30 to +75° storage. Cooling fan is fitted
Humidity Range	10 to 85% (non condensing)
Case Type	1U rack mounting aluminum case
Dimensions	W: 483 mm (445 mm behind rack location bracket) D: 470 mm H: 44.4 mm
Depth behind rack ears excluding space for leads	450 mm
Weight	Approximately 6.45 kg without modules. Approximately 8.25 kg fully populated

## 3 Installation

### 3.1 Unpacking the Unit

The unit is supplied in a dedicated packing carton provided by the manufacturer and should not be accepted if delivered in inferior or unauthorized materials.

The contents of the carton are:

- IQH1A 3U enclosure
- 1 or 2 power supplies
- 2 power cables
- 9-way male-to-female serial extension cable (for initial Gateway setup purposes only)
- 1 BNC Y-piece connector

Unpack the carton carefully and check for any shortages or damage. Report any shortages or damage to SAM immediately.



When the unit is supplied fitted with two power supplies, ensure that both power supplies are installed correctly and are powered up.

### 3.2 Environment

Although constructed to meet the normal environmental requirements, it is important that there is a free flow of air at the front and rear to dissipate the heat produced during operation. Installations should be designed to allow for this.

When rack mounting the equipment, support other than the rack mount ears must be provided.



The ventilation holes of the fan housing must not be obstructed or damaged to the fan and the equipment may result.

### 3.3 Power Connections

The enclosure provides two power supply inputs, one for each of the Dual PSUs fitted.



Before connecting power to the unit please refer to the safety warnings at the front of this manual.

These are the IEC320 mains power connectors suitable for a standard IEC type power cable and contains a T3.15AH fuse.

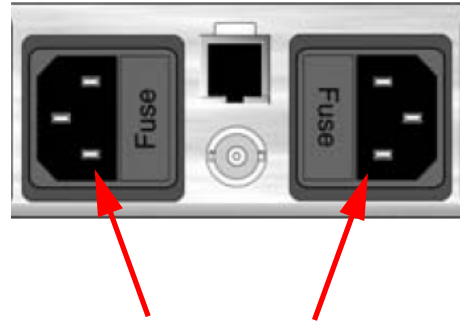

Power Supply Connections

### 3.4 Supply Voltage

The unit automatically senses the nominal supply voltage and sets itself up accordingly. No voltage adjustment procedure is required.

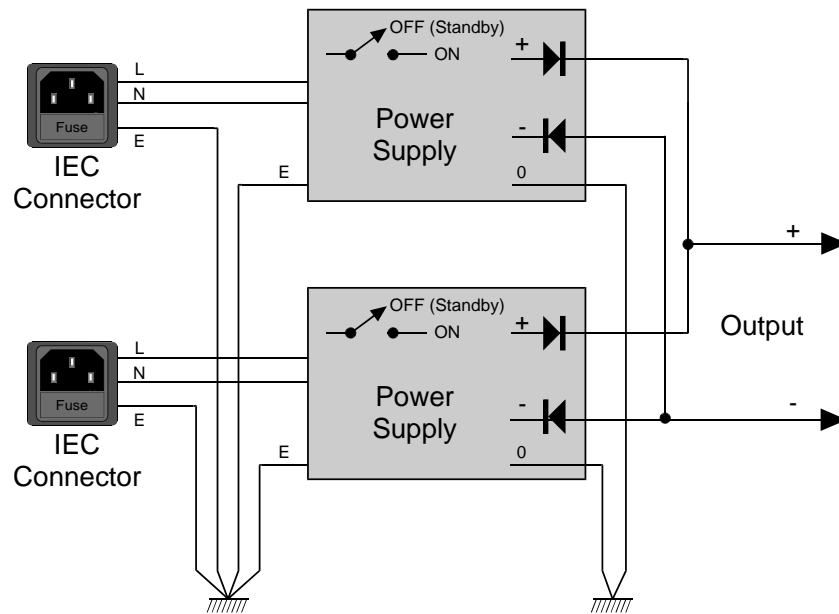

Each IEC connector supplies an independent feed of power to each of the two power supply modules as shown in the diagram above.

The IQH1A IQ 1U Modular Enclosure can support dual power supplies for redundancy; however, this is an option, therefore a second PSU may not be fitted.



### 3.5 Front Panel Indicator

On the front-panel, there is a bi-colored (red and green) LED that indicates the unit's status.



LED Indicator

LED State	Meaning
Green	Power ON OK – no faults detected
Steady flashing Red/Green/Red/Green/...	<i>Where Am I?</i> function activated
Red Flashing	Faults detected: PSU - Voltage exceeding limits/out of range, PSU Missing/Power cable missing. FAN - Stopped, Short circuit, Running at maximum. TEMP - Sensor fault, Temperature beyond normal limits. MOD COMMS - Excessive Backplane errors.
Steady flashing Red/Off/Red/Off/...	Steady error condition such as PSU or fan failed
Intermittent flashing Red from Green	Momentary error such as network error caused by faulty cabling

More information about error condition details can be determined by checking via RollCall or SNMP.

### 3.6 Rear Panel Connections

Rear Panel connectors are routed from the Gateway Card, fitted into a dedicated slot in the 1U enclosure.

#### 3.6.1 Ethernet

This RJ45 connector socket allows the unit to be connected to a LAN.



This connector is not intended for direct connection to a telecommunications network.

#### 3.6.2 Remote

The 9-way, D-type connector on the front panel allows the unit to be connected to the RollCall 485 network communications system.

This connector may also be used as a RS-422 or as a RS-232 RollCall communication port.

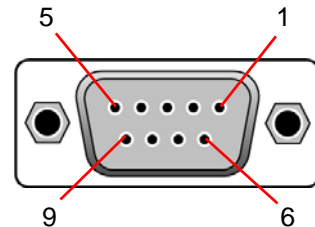

**Note:** RS-485 power connections should only be used when connecting an un-powered device, e.g. an active front panel, to a power source such as a RollCall Gateway. (Pin 5 V+ is non-preferred, as this is RS-232 signal ground).

When connecting two powered devices, the power connections should not be used.

RS-485 interconnections should be pin-to-pin and only be used for SAM RollNet applications.

**Important:** The supplied 9-way serial extension cable is only used for the initial setup of the Gateway controls by qualified installation personnel. It must not be connected during the operational use of the unit.

#### 9-Way D-Type Connections

Pin No.	Function RS-485	Function RS-422	Function RS-232
1	GND	GND	NC
2	Data A (+)	TX+	TX
3	NC*	RX+	RX
4	GND	GND	NC
5	GND	GND	GND
6	GND	GND	NC
7	Data B (-)	TX-	Short to pin 8
8	NC*	RX-	Short to pin 7
9	NC	NC	NC

\* pins are physically connected in hardware but not functional in this mode.

### 3.6.3 RollNet

The BNC connector enables the unit to be connected to the RollCall network communications system.

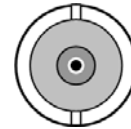

The RollCall system should be connected using a 75 Ohm 'T' or 'Y' piece, in a similar manner to an 'Ethernet' system. Both extremities of the system must be terminated in 75 Ohms.

**Note:** In a RollCall segment, all units must have different unit address codes.

The coaxial link is bi-directional and therefore must not be passed through signal switching networks. Also, to allow hum and noise cancellation, the screen of the coaxial connection must not be earthed.

### 3.7 Opening the Front Panel

To open the front panel:

1. Pull the panel forward and downward using the handle that runs along the top edge of the panel.

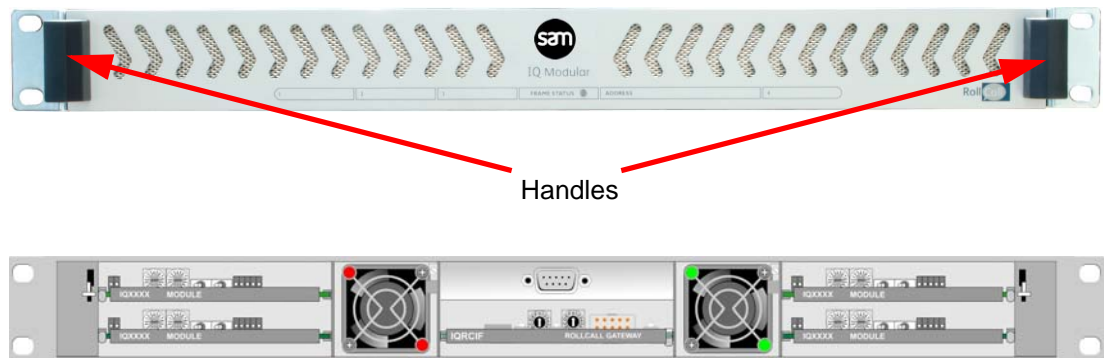

### 3.8 Power Standby LEDs

On each PSU there is a pair of LEDs. The upper left LED in each pair monitors the +7.5 V supply and the lower right-hand LED monitors the -7.5 V supply.

These bi-color LEDs are:

- Green: OK
- Red: Fail

**Note:** The LEDs will be red if the PSU is unpowered or on standby, provided that the other PSU is functioning.

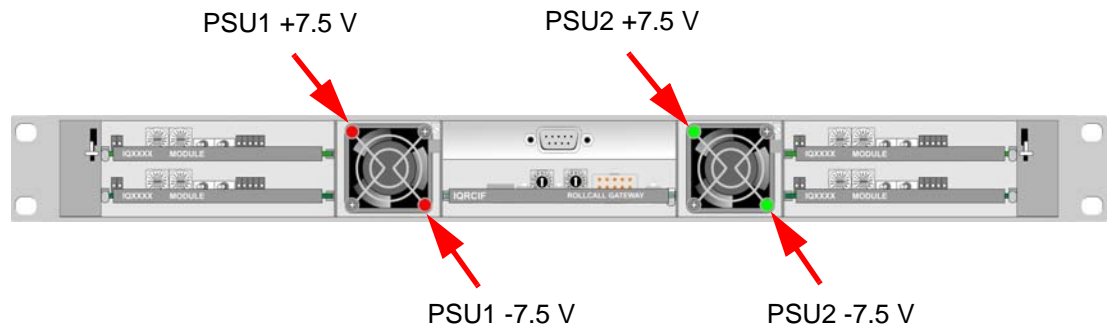

### 3.9 Front (Gateway Card) Controls and LEDs

Front Panel connectors, controls and LEDs are provided by the Gateway Card, fitted into a dedicated slot in the 3U enclosure.

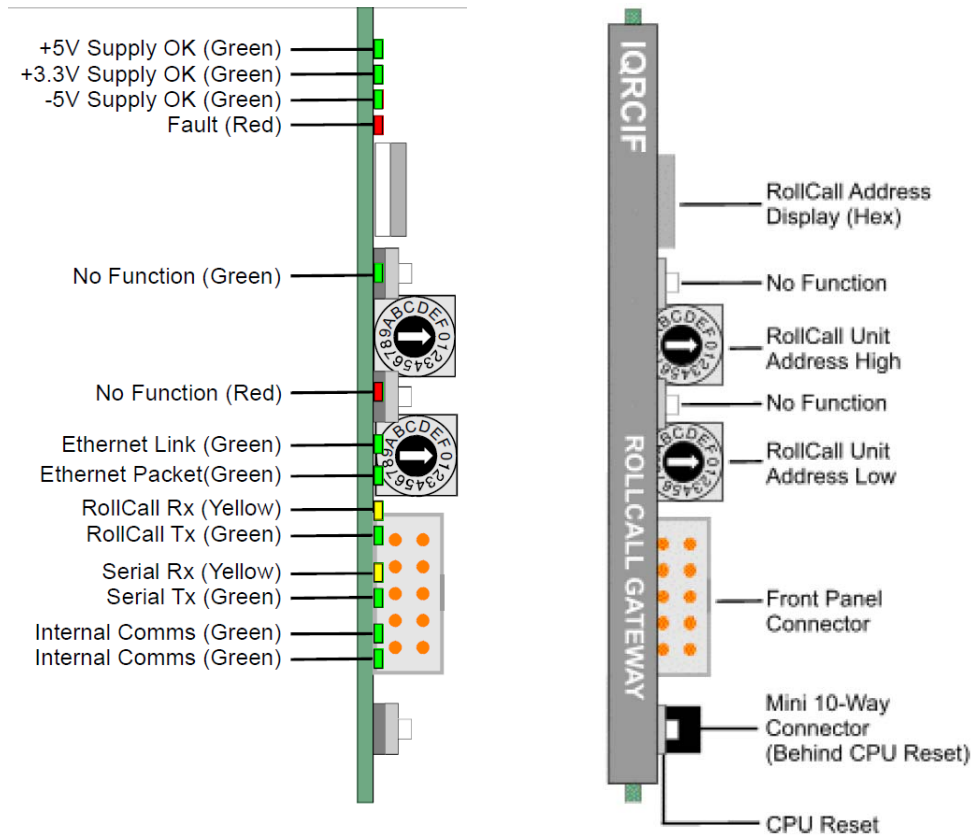

#### 3.9.1 Front Panel Connector

This connector connects to the front panel AND provides the drive power to the LED on the front panel.

#### 3.9.2 Mini 10-way Connector

This connector offers RollCall serial RS-232/422 connectivity, allowing easier configuration for 3U boxes where rear access is limited. Use part No. SAAN RCSCGW1X to connect to this.

#### 3.9.3 HEX Switches

Both of these switches are used to define the Unit Address code for the equipment.

Position '0' on the upper switch will disable the RollCall function on the unit; all other positions on these switches may be used to set the Unit Address code in Hex. (Upper switch 1 to f, lower switch 0 to f). This code will be appear on the 2-digit, 7-segment display.

If a code is already in use the RollCall receive and transmit LED's will flash alternately at a 1-second rate.

**Note:** In a RollCall local network, all units must have different unit address codes.

The two digit RollCall address display has a secondary mode of operation. Momentarily press either of the two "No Function" buttons and the IP address followed by the netmask address will slowly be displayed one number at a time on the 7-segment LED display.

#### 3.9.4 LEDs

LEDs are provided along the front edge of the Gateway Card, shown in the diagram above.

### 3.10 Power Supply and Module Slot Locations

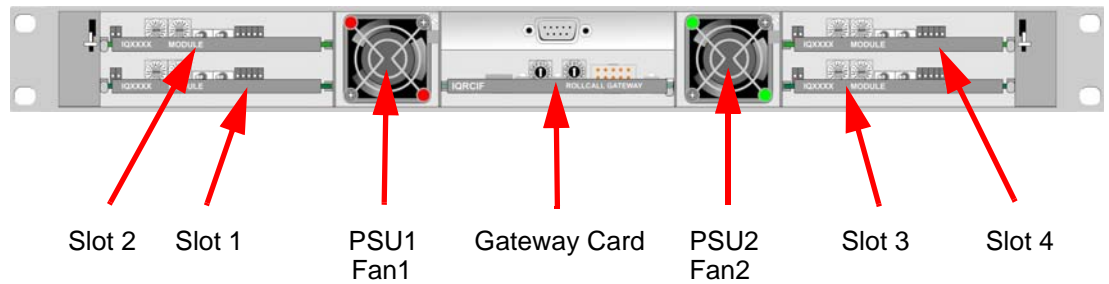

The IQH1A IQ 1U Modular Enclosure is designed to accept one or two power supplies with independent IEC320 mains inlets.

Individually, each PSU module is capable of powering the frame containing any combination of IQ-1A modules subject to the configuration rules described in section 3.12.1 on page 24. When two units are installed the operation of the whole frame becomes protected against single-instance power failures. The manufacturer specifies a maximum of 50 mating cycles.

Monitoring circuitry built in to each PSU reports power or PSU fan failures via two bi-color LEDs on the front of each power supply.

The bi-color LEDs on the PSU front panels are green if the PSU is supplying power to the rack and the PSU fans are running, and turn red if either fails.

The LEDs are also red if the mains power to the unit has failed or if the unit is switched to standby, provided that the other PSU is functioning.

Within the power supplies, the positive and negative rails are independently regulated and have no minimum load current requirements.

The DC outputs of the power supplies have series Schottky diodes that allow direct connection of multiple units on one power bus.

Additional components adjust the regulation so that the power supplies will attempt to share the load current requirements. The balance of current sharing between supplies is subject to variation of the basic regulation of the PSUs. With two PSUs the unit with the higher output voltage will contribute more current to the load.

### 3.11 Installing and Removing Power Supply Units



Ensure that the power supply is switched OFF and the mains power connection at the rear of the unit is removed before attempting these operations.

The IQH1A IQ 1U Modular Enclosure is provided with one PSU as standard. There is an option for installing a second PSU to allow dual redundant operation. This may be a factory fitted option or can be done as an upgrade.

#### 3.11.1 Installing a Power Supply Unit

To install a power supply unit:

1. Open the front panel, as described in section 3.7 on page 19.
2. Ensuring correct PSU orientation, carefully slide the PSU into the enclosure and push home firmly.
3. Tighten the securing screw.

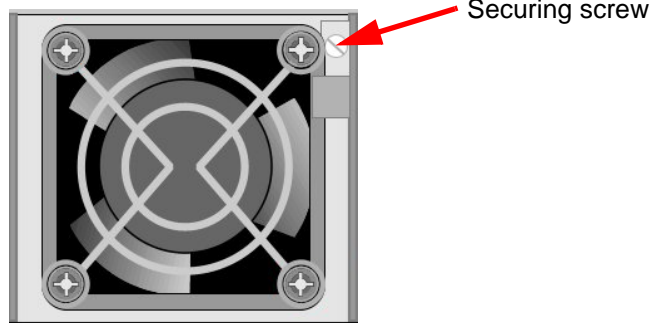

4. Close the front panel.

#### 3.11.2 Removing a Power Supply Unit

To remove a power supply unit:

1. Open the front panel, as described in section 3.7 on page 19.
2. Unscrew the securing screw until the finger tab is released.
3. Pull the finger tab firmly to release the PSU, and carefully slide the PSU out of the enclosure.

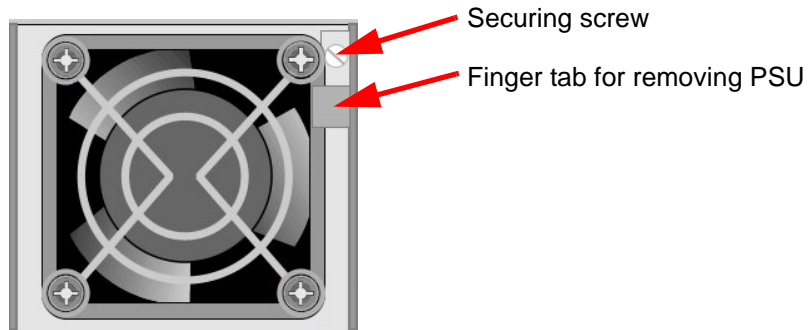

4. Close the front panel.

## 3.12 Installing and Removing Modules



The enclosure must have a full compliment of rear panels. Any vacant slots must have a blank rear panel fitted.

### 3.12.1 Installing a New Module



Ensure that the power supply is switched OFF and the mains power connection at the rear of the unit is removed before this operation is performed.

Before installing a new module consult section 4.2.14 on page 38 and ensure there is adequate power available for the module to be added.

#### To install a new module:

1. Open the front panel.
2. Choose an empty slot position for the module.
3. At the rear of the enclosure, remove the screws securing the blanking plate associated with the chosen slot position. Store the blanking plate in a safe place for future use.
4. Ensuring correct orientation, fit the rear connecting panel (supplied with the new module) to the rear of the enclosure in the vacant aperture. Secure with the fixing screws provided.
5. At the front of the enclosure, ensure correct orientation and carefully slide in the new module until it fully mates with the rear connector panel.
6. Close the front panel.

### 3.12.2 Removing a Module



Ensure that the power supply is switched OFF and the mains power connection at the rear of the unit is removed before this operation is performed.

#### To remove a module:

1. Open the front panel.
2. Carefully slide out the desired module.

If a different type of module is to be installed in this position proceed as in Installing a New Module item 1 and items 4 to 11.

#### If the slot is to be left vacant, proceed as follows:

1. Close and secure the front panel.
2. At the rear of the enclosure, fit the blanking plate in the associated position using two screws.

### 3.12.3 Replacing a Module in a Live Environment

SAM recommends that the power supply is switched off and the mains connections are removed before performing the previous operations. However, in a live environment, this may not be possible and you can remove and install modules without switching the power off.

#### Important:

It cannot be guaranteed that there will be no disturbance to the operation of other modules in the enclosure when you replace a module without first powering down the enclosure.



### 3.13 Replacing the Cooling Fan Assembly

The cooling fan assembly is located on the rear panel of the 3U enclosure and may be easily replaced without removing the rack from its mounting position or removing any cable connections.

**To replace the fan assembly:**

1. Switch off the unit's power supplies and remove the IEC power cables.
2. Remove the two 70 mm x 4 mm posi-pan retaining screws.

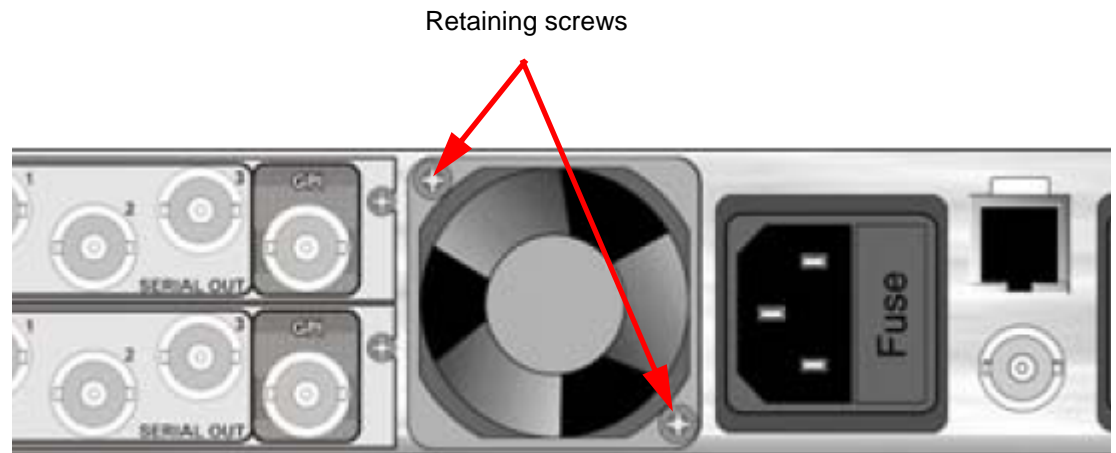

3. Withdraw the fan assembly from the unit.
4. Slide the new fan assembly into the unit, ensuring that the power connector is mated securely.
5. Refit the retaining screws. It is recommended that the screws are not fully tightened initially. Instead, they should be alternately tightened in small increments so that the assembly goes in straight.
6. You can now refit the power cables and switch the power supply units on.

### 3.14 Replacing a Fan Unit in a Live Environment

**Important:**

**This fan unit should only be serviced by trained personnel.**

The Fan unit can be replaced in a live environment carefully following the steps below.

**Caution is advised - Do Not** put your hands or fingers inside the enclosure whilst replacing the fan unit.

1. Remove the two 70 mm x 4 mm posi-pan retaining screws.
2. Carefully withdraw the fan unit assembly from the box.
3. Slide the new fan unit assembly into the box, ensuring that the power connector is mated securely.
4. Refit the retaining screws. It is recommended that the screws are not fully tightened initially. Instead, they should be alternately tightened in small increments so that the assembly goes in straight.

### 3.15 Control Panels

A mainframe and the modules that it contains may be controlled by the following methods:

- Control panels connected via the RollCall communications network.
- Computers connected via the RollCall communications network.
- SNMP managers connected via IP.
- Any combination of the above.

#### 3.15.1 RollCall Communications System

RollCall remote control gives a uniquely powerful and flexible system that can be as simple as a single rack unit with control panel, or a powerful multi-master, multi-slave configuration with PC control and monitoring for full station automation.

The RollCall command protocol obtains control information from the IQ module being addressed. This unique feature ensures that module updates or additions will not require control system software upgrades - simply plug in and switch on.

When the unit (or module) is powered-up the module will normally assume the same set-up conditions that existed at the last power-down. This information is provided by non-volatile memory on the module. Some modules incorporate methods that allow other set-up conditions to exist on power-up; please consult the information specific to each module for details.

##### 3.15.1.1 RollCall Network System Details

The IQ Modular system has a flexible and powerful remote control system. The units in the system are joined via a high-speed network. Each box enclosure is a node on the network. A single local area network can have a maximum of 255 nodes with any combination of control panels and modular rack boxes. With the 3U box holding up to 16 cards, the system can accommodate 4080 (255 x 16) cards. Each box is physically addressed via switches on the Remote Control Interface.

Network bridges can be used to connect each network to up to 15 others nested up to 4 levels allowing tens of thousands of networks and millions of units to be joined together.

The IQH1A enclosure has various interface connections to the RollCall network:

- RollNet 75 Ohm coaxial BNC running at 2.5 Mbps. The IQH1A enclosure represents a 2 unit load.
- RollNet RS-485 9-way, D-type connector running at 2.5 Mbps.

- RollNet RS-485 10 way DIN connector running at 2.5 Mbps.
- RS-422 or RS-232 port running at up to 115.2 kbps asynchronous.
- RJ45 Ethernet running at 10/100 Mbps

The RS-422, RS-232 and RS-485 interfaces share the same D connector. Selection of the interface mode is made by two banks of DIP switches (SW1 & SW7) located at the rear of the Gateway card. SW1 is a bank of eight switches (SW1 1-8) and SW7 is a bank of four switches (SW7 1-4). The Gateway must be removed from the frame to alter the switch settings.

To select RS-232 mode SW1 1-7 should be open and SW7 1-4 should be closed (SW1 8 is irrelevant).

To select RS-422 mode SW1 1-8 should be closed and SW7 1-4 should be open.

To select RS-485 mode SW1 1-7 should be closed, SW1 8 and SW7 1-4 should be open.

Mode	SW1 1-7	SW1 8	SW7 1-4
RS-232	OPEN	----	CLOSED
RS-422	CLOSED	CLOSED	OPEN
RS-485	CLOSED	OPEN	OPEN

Gateways ship with a default setting of RS-232.

### 3.15.1.2 RollNet 75 Ohm Coaxial Interface

This interface allows connections of units to a single section of 75 Ohm video cable. Each unit is physically joined via a T or Y-piece connector. Each end of the section is terminated by a 75 Ohm resistor at each end of the cable. The data rate on this interface is 2.5 Mbps. Each section of cable can be up to 400 m.

#### Example configuration:

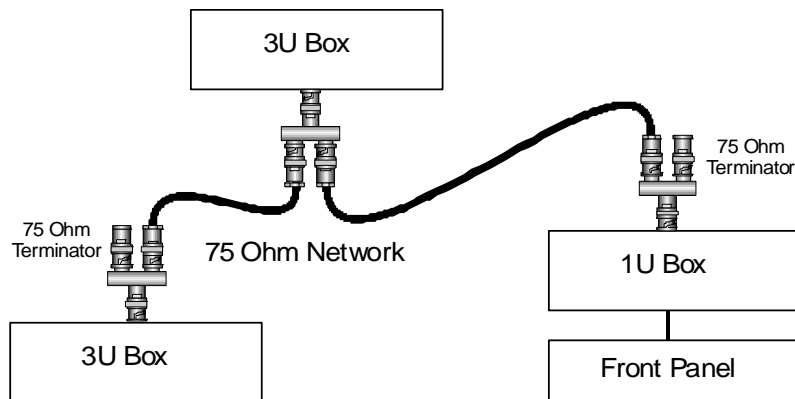

### 3.15.1.3 RollNet RS-485 Differential Interface

Sections of the coaxial network can be joined using the RS-485 bus. The RS-485 connections are limited to shorter distances but are multi-drop allowing a rich combination of network configurations. The combined total number of units across the coaxial network and the RS-485 bus is still 255 nodes and the total network length can be up to 1500m.

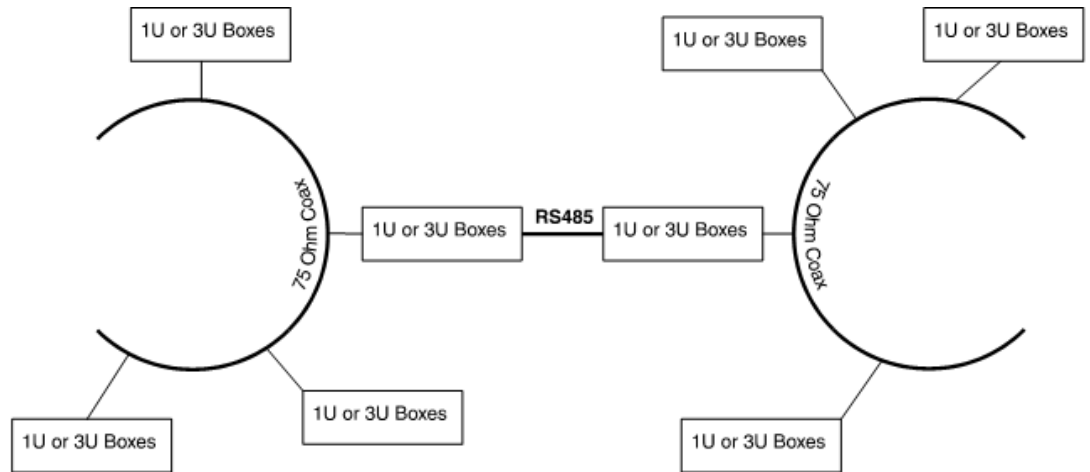

The maximum number of hub transitions between any number of nodes on a single local area network is 4.

### 3.15.1.4 RollNet RS-485 10-way DIN connector

RollNet RS-485 is also available on a 10 way DIN connector on the Gateway front edge. This can be used to connect an active front panel to the Gateway for configuration purposes.

This connector normally drives the LED on the 3U frame front panel.

### 3.15.1.5 RS-422 or RS-232 Asynchronous Interface

This interface allows a PC running RollCall control software to be connected to the RollCall network without a RollNet interface card. The PC is connected via an RS-232 or RS-422 serial port (often known as a COM port).

RS-422 allows longer cable runs and offers better immunity to electrical noise, but usually requires an RS-422 to RS-232 converter to connect to a PC (Some specialist control PCs support RS-422 directly). RS-232 allows direct connection to a standard PC serial (COM port), but only supports shorter cable runs of up to 4 meters.

#### Example configuration:

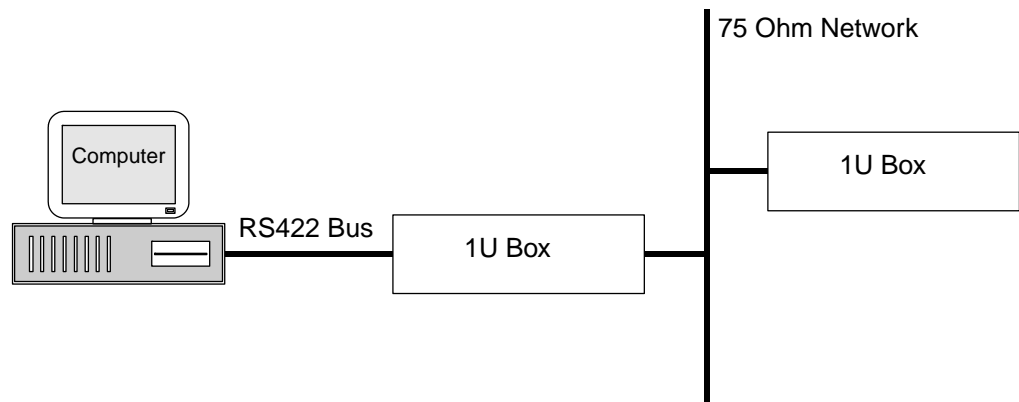

A serial device attached to a single IQ rack has access to all devices on the RollCall network.

The serial port can also be used for third party connections into the system. This allows PCs or any other serial device access to any of the units within the system. Please consult SAM for details of the port binary protocol.

In addition to the rear serial port, the RCIF3U2C also has a front serial connector. The front and rear connectors may be used simultaneously.

The serial port supports speeds up to 115.2 kbps. The RollCall PC software is limited to 57.6 kbps.

### 3.15.2 Ethernet Connection

This interface allows the 3U enclosure to be connected to a 10/100base T Ethernet network. PC's can then connect to the 3U box via TCP/IP.

An Ethernet device connected to a single IQ rack has access to all devices on the RollCall network. This interface can be used to connect a PC running the RollCall software.

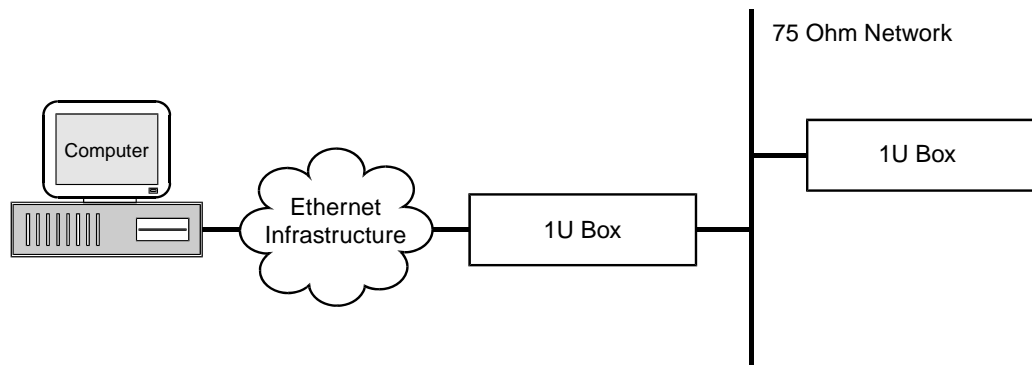

A PC can control multiple RollCall networks by connecting via RollProxy.

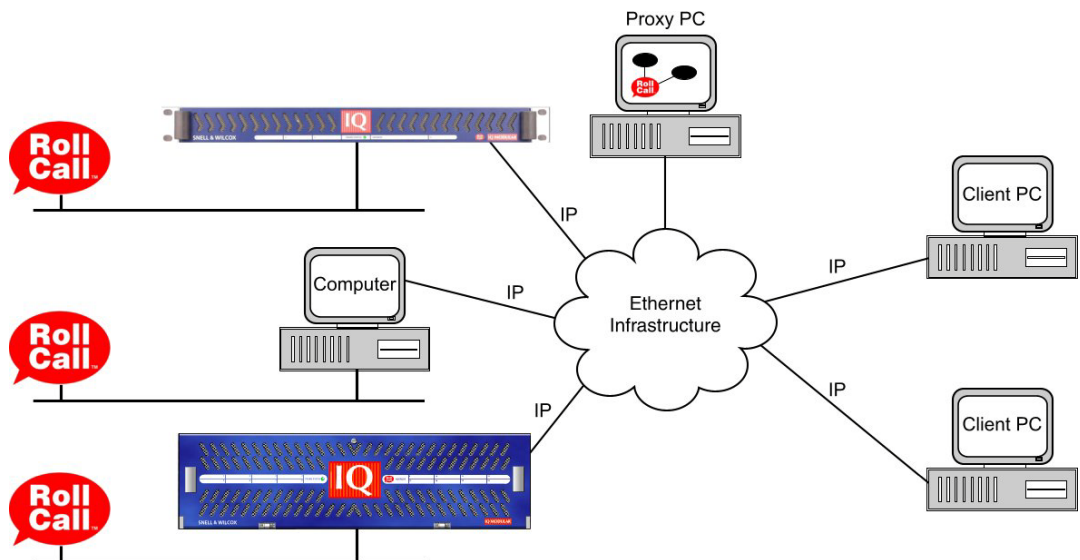

### 3.15.2.1 Configuring IP Parameters

You must configure the Gateways IP parameters before you can connect to the Gateway using IP over Ethernet. To do this you must establish a connection to the Gateway using a different communications interface.

In each case you need a PC with the RollCall control software installed. You can connect the PC to the Gateway in one of three ways:

- RollNet
- Serial
- IP Crossover Cable

#### RollNet

If the PC is connected to an existing RollNet network, you can set the Gateway to an unused unit address, add it to the RollNet network and connect to it via RollNet.

#### Serial

You can connect any PC with an RS-232 serial (COM) port to the Gateway. By default the Gateway ships configured for RS-232 at 38400 baud. Connect the PC COM to the 9-way D-type labeled "Remote" on the rear of the 3U enclosure. In the Commtrol window on the PC, go to File | Configure Comms.

Select Serial Port, select the correct COM port and set the Baud rate to 38400. You should now be able to connect to the Gateway.

#### IP Crossover Cable

You can connect the any PC with a 10Base-T or 100Base-T RJ45 Ethernet port to the Gateway using an RJ45 crossover cable. This looks like a standard RJ45 patch cable, but is wired differently. Connect the crossover cable to the RJ45 ports on the PC and on the rear of the 3U enclosure. Configure the PC to use the following IP parameters:

IP address: 192.168.151.2

Subnet mask: 255.255.0.0

Default IP Gateway: blank

#### Detailed Configuration Steps

1. On PC change the TCP/IP LAN Properties to 192.168.151.2 (.1 is the IP address of the gateway) Take note of default TCP/IP to restore afterwards.
2. Set control panel connection "Build network" to 192.168.151.1.
3. Open the RollCall control panel and template for gateway, go to Ethernet page.
4. Set all Ethernet parameters (address. subnet/gateway), then hit "Take IP Address Changes".
5. Reconfigure the PC's TCP/IP LAN configuration to it's original properties.
6. Connection to the gateway's IP may be tested only if PC and gateway have valid routing to allow this. If so, reset the "Build Network" in control panel to point to the gateway's new IP address.

### 3.15.3 Simple Network Management Protocol (SNMP)

The Gateway can run an SNMP agent which allows direct control of both its own controls and those of modules within the chassis. Unlike a RollCall IP connection, an SNMP connection is for this 3U box only. If you wish to control other 3U boxes then each must be connected via Ethernet and controlled by SNMP individually.

SNMP also provides logging information. Log messages, similar to those sent to a RollCall logserver, can be sent to up to 8 separate destinations (SNMP trap destinations).

By default, the SNMP agent is disabled. A set of MIB modules have been created that map controls for each card type and provide other mappings. These are required in the SNMP manager operation.

At a minimum, to control the gateway, you need the following MIBs:

SNELL-WILCOX-SMI.MIB

SNELL-WILCOX-TC.MIB

SNELL-WILCOX-PRODUCT-REG.MIB (Id for each card type)

SNELL-WILCOX-UNIT.MIB

SNELL-WILCOX-GATEWAY-LOGGING.MIB (card and gateway logging tables)

SNELL-IQH3A-CMD-MIB.MIB (gateway controls)

SNELL-WILCOX-MODULAR-GATEWAY.MIB (required if legacy SNMP support is enabled)

This is a hierarchical MIB structure and must be compiled in order if your SNMP manager does not support conditional compilation.

To control modules within a chassis you would also need the MIB for that card type:

SNELL-cardIdName-CMD-MIB.MIB

where cardIdName could be IQCBRG for a Bridge card or IQDMSDA, or other card names etc.

MIBs are available from the SAM website:

Legacy MIBs (required):

[ftp://ftp.snellwilcox.com/RollCall/SNMP\\_MIBs/Legacy\\_IQ\\_Modular\\_MIBs/](ftp://ftp.snellwilcox.com/RollCall/SNMP_MIBs/Legacy_IQ_Modular_MIBs/)

Modular (as required):

[ftp://ftp.snellwilcox.com/RollCall/SNMP\\_MIBs/IQ\\_Modular\\_MIBs/](ftp://ftp.snellwilcox.com/RollCall/SNMP_MIBs/IQ_Modular_MIBs/)

The SNMP logging solution provides a current log of all log headers and fields for all cards within a chassis and a separate table for the gateway logs. Details of the log header and field values are available at the bottom of each MIB for each individual card type.

**Note:**

Enabling SNMP makes certain older modules inaccessible at non-Supervisor levels, and thus prevents certain module-specific PC tools from working correctly. The work-around is to temporarily disable the SNMP agent whilst using these tools. Alternately switch off control of the individual module. This is available on the **SNMP** page of the control template.

### 3.15.4 IP Bridging

The Gateway supports RollCall bridging over IP. This allows two IQ Gateways to be connected via IP so that they pass RollCall messages between networks.

**To establish a RollCall bridge:**

- The Gateways must be visible to each other via IP
- Both Gateways must be set to RollNet addresses in the range 0x01-0x0F
- At least one Gateway must be configured via the Bridge IP Addr control to connect to other's IP address
- The bridge must be initiated by one Gateway via the Connect or Auto Connect controls

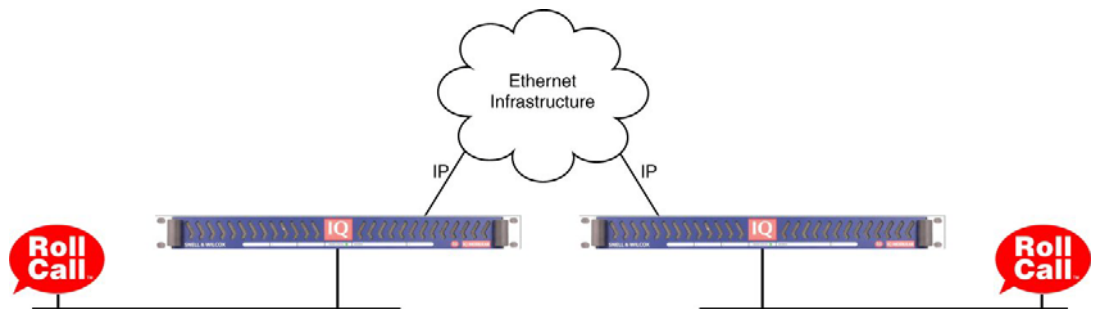



### 3.15.4.1 Configuring IP Bridging

An IP bridge requires two Gateways, both connected to the IP infrastructure and set to RollCall addresses in the range 0x01-0x0F. An example configuration might be:

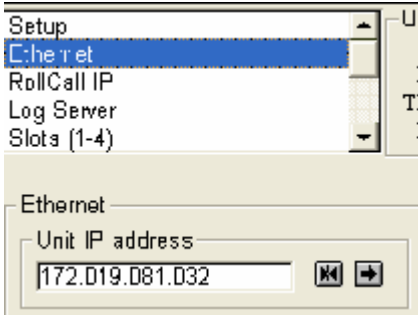
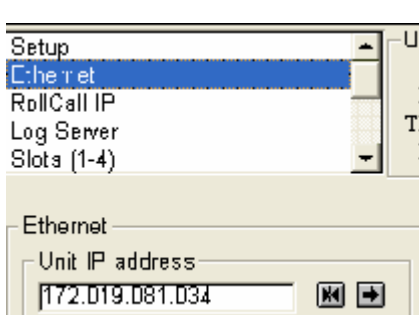
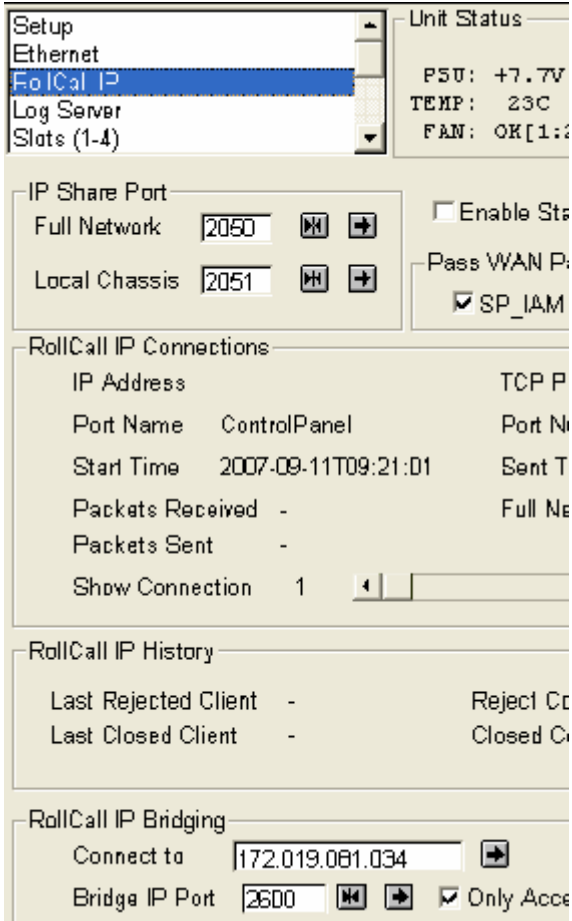
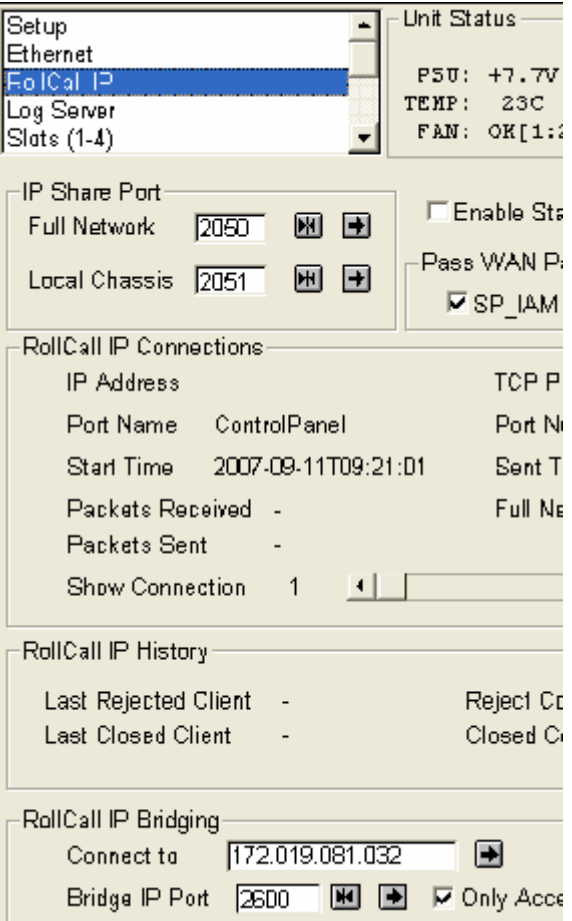
Gateway 1	Gateway 2
<p>Ethernet -&gt; Unit IP Address</p> 	<p>Ethernet -&gt; Unit IP Address</p> 
<p>RollCall IP -&gt; Connect to</p> 	<p>RollCall IP -&gt; Connect to</p> 

It is recommended that “Only Accept This Address” is checked at both ends to prevent other Gateways from establishing bridge connections, and that “Connect Automatically” is checked at both ends, so the bridge is re-connected if it should be disconnected for any reason.

## 4 Operation

This section of the manual assumes that the IQH1A IQ 1U Modular Enclosure has been installed in accordance with the instructions given in the Installation Manual. It describes the operation of the unit by means of the RollCall Control Panel software.

To fully conform with EMC and Safety standards, modules must be correctly installed in the mainframe. Prior to connection of power the user should check the following items:

- The rear of the mainframe must have a full complement of rear panels. Any vacant slots must have a blank rear panel fitted.
- All mainframe covers and rear panels must be fitted and screwed down using all available fixing holes.
- The mainframe front panel must be in the closed position, with the turnbuckles and screws fastened.

### 4.1 Unit Status

This area of the template displays abbreviated information about the current status of the unit.

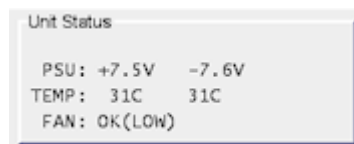

#### 4.1.1 Line 1

This will normally show the output voltage of the power supplies for example:

PSU: +7.6V -7.8V

If a PSU error is detected or a voltage measurement is out of range then the text will toggle to one of the items in the list below:

Message	Description
PSU: +7.5V_RAIL	Positive voltage rail out of expected range (<6.8 V or >8.0 V).
PSU: -7.5V_RAIL	Negative voltage rail out of expected range (<6.8 V or >8.0 V).
PSU: LEFT_MISSING	Left PSU expected but not present.
PSU: LEFT_FAILED	Left PSU failed or no power present.
PSU:RIGHT_MISSING	Right PSU expected but not present.
PSU:RIGHT_FAILED	Right PSU failed or no power present.

#### 4.1.2 Line 2

This will show the Inlet and Outlet temperatures (in Celsius) of the enclosure.

Normally this would show for example:

TEMP: 28C 27C

Where the first value is the inlet temperature and the second value is the outlet temperature.

This display does not toggle. If any errors occur these are specific to the outlet sensor only.

Message	Description
TEMP: 28C FAILED	Outlet sensor failure.
TEMP: 28C DISABL	Outlet sensor configured as disabled.

### 4.1.3 Line 3

This line will show the status of the enclosure cooling fan which is located at the rear of the unit.

It displays the status and the programmed speed (devised according to the current ambient temperature) and would normally show:

Message	Description
FAN: OK(LOW)	Fan is running OK. Low speed mode.
FAN: OK(MEDIUM)	Fan is running OK. Medium speed mode
FAN: OK(HIGH)	Fan is running OK. High speed mode.

Error conditions would be shown as below:

Message	Description
FAN: WARN(MAX)	Fan is running at maximum speed
FAN: FAIL STOP 1	Fan 1 has ceased running.
FAN: FAIL STOP 2	Fan 2 has ceased running.
FAN: FAIL STOP 1 & 2!	Fans 1 and 2 have ceased running.
FAN: FAIL(SHORT)	Fan short circuit detected.

## 4.2 Setup

The **Setup** screen enables various system functions to be configured.

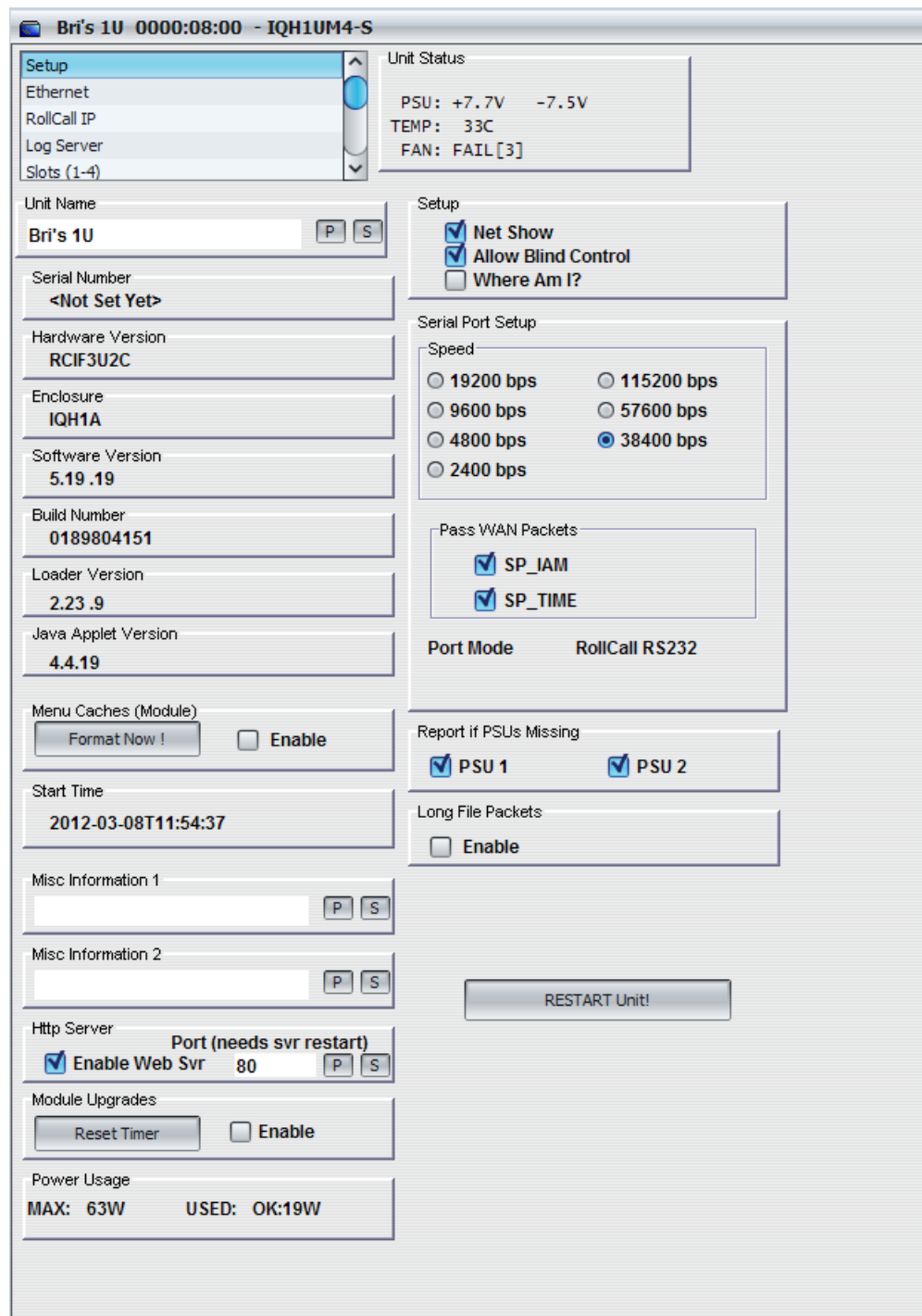

### 4.2.1 Unit Name

This field enables the unit to be given a meaningful name. To enter/modify the name of the unit, type directly into the editable text field and click the Save (**S**) button. To return to the default name, click the Preset (**P**) button.

### 4.2.2 Serial Number

This displays the serial number of the unit.

### 4.2.3 Hardware Version

This displays the version number of the hardware used in the Gateway Card.

### 4.2.4 Enclosure

This displays the IQ Modular enclosure type that the Gateway is fitted in.

### 4.2.5 Software Version

This displays the software version installed.

### 4.2.6 Build Number

This displays the software build number of the unit.

### 4.2.7 Loader Version

This displays the version of the Gateway software loader. The loader operates at start up only, validating all Gateway files before the main application runs]

### 4.2.8 Java Applet Version

This shows the existence and the version of the Java Control Applet.

### 4.2.9 Menu Caches (Module)

The Gateway caches module menu sets locally to improve menu upload speeds. In rare circumstances this may cause problems. If problems with module menu uploads are encountered the menu caches can be cleared or caching disabled.

- **Format Now!:** This deletes the existing module menu caches. The caches will be recreated when the next menu client connects.
- **Enable:** Place a check mark in this box to enable the menu cache function.

### 4.2.10 Start Time

This displays the start time for the unit.

### 4.2.11 Misc Information 1/2

These information fields may be edited to specify any information desired. For example, these could be used to add further information on the Gateway Card (rack position / building/ group). 2 fields are available allowing a maximum of 2 \* 19 characters displayed. If these fields have edited values then a corresponding log field gets raised.

Log field: INFORMATION1= and INFORMATION2=.

A global control for these logging fields applies in Logging(2).

### 4.2.12 Http Server

To enable increased security of control, either the http server may be disabled, to prevent access to the Java Applet control panel or Homepage, or the port number for Http access may be changed.

A check mark in the **Enable Web Svr** box will enable the web server control function. By default, this option is enabled. Click to remove the check mark and disable this function. To enter/modify the port number, type a new number in the editable field and click the Save (**S**) button. To return to the default port number, click the Preset (**P**) button.

After changing the port number, you must restart the web server by disabling then enabling the **Enable Web Svr** checkbox.

### 4.2.13 Module Upgrades

These controls temporarily suppress backplane logging and thumbnailing. They are only used by RollMechanic and the Control Panel, and do not need to be changed by the user.

- **Reset Timer:** This resets the timer, used when upgrading a module.
- **Enable:** Place a check mark in this box to enable the upgrade function.

### 4.2.14 Power Usage

This displays the maximum (**MAX:**) allowable power available for modules.

- IQH3A: 141 Watts
- IQH1A: 63 Watts
- IQH3B: 165 Load Units

For example, MAX: 165LU

This field also displays the current power usage (**USED:**); the current total of all fitted modules' power ratings. Values are preceded by **OK** (if within the maximum) or **WARN** (if the maximum is currently exceeded).

For example, USED: OK:71LU or USED: WARN:167LU

Usage values per slot are available for viewing on the "Slots" pages.

### 4.2.15 Setup

This group enables control of setup functions.

- **Net Show:** This function allows a unit to be 'hidden' from the network system. When netshow is active the unit broadcasts its presence.

**Note:** If the unit address is changed Netshow will automatically be turned on.

- **Allow Blind Control:** If the Gateway is to be controlled by Blind Control then Allow Blind Control must be enabled. If Blind Control is not used then Allow Blind Control may be disabled, giving protection against incorrectly set-up RollTrack sources.

**Note:** If upgrading the Gateway software, Blind Control must be enabled.

- **Where Am I?:** This allows the 3U enclosure to be physically located in a large system. When this function is selected the LED indicator on the front panel of the enclosure will flash red and green.

### 4.2.16 Serial Port Setup

#### 4.2.16.1 Speed

This group allows the serial port to be configured.

The baud rate is set between 2400 and 115200 baud. The default speed for all RollCall serial connections is 38,400 bps.

**Note:** The RollCall PC software only supports speeds up to 57600 baud.

#### 4.2.16.2 Pass WAN Packets

- **SP\_IAM:** This controls whether the Gateway passes wide area I\_AM packets from the serial port to the RollCall Network. Normally this is enabled to allow PCs attached to

the serial port to be located by other units, but it may be disabled if you wish to control the flow of I\_AM packets through a system.

**Note:** Pass I\_AM (Bridge) overrides both Pass I\_AM (Serial) and Pass I\_AM (IP). So if Pass I\_AM (Bridge) is set I AM messages will be passed over the bridge, irrespective of how the other controls are set.

- **SP\_TIME:** This controls whether the Gateway passes wide area TIME packets from the serial port to the RollCall Network. Normally this is enabled to allow PCs attached to the serial port to be time servers, but it may be disabled if you wish to control the flow of TIME packets through a system.

**Note:** The Gateway will always use the received time stamp, whether it passes it on or not (but see also Time from Logger).

#### 4.2.16.3 Port Mode

This item shows the current operating mode of the serial port (RS-422, RS-232 or RS-485).

#### 4.2.16.4 Report if PSUs Missing

When these boxes are checked it will allow a missing PSU report to be displayed in the Unit Status area and logged.

If two power supply units are fitted, (dual redundancy supply configuration) the Left PSU and the Right PSU items should be selected.

If for some reason one of the power supplies is removed a warning will be displayed, indicating which power supply is missing.

If only one power supply is fitted, only the corresponding check box should be selected and the other cleared.

**Note:** If a PSU is fitted but fails or is turned off then a warning message will always be generated.

#### 4.2.17 Long File packets

Checkbox to allow long file packet transfer on gateway. File packets changed between 227 bytes and 408. Leave disabled (short) unless advised by SAM engineering.

### 4.3 Ethernet

The **Ethernet** screen enables networking functions to be configured.

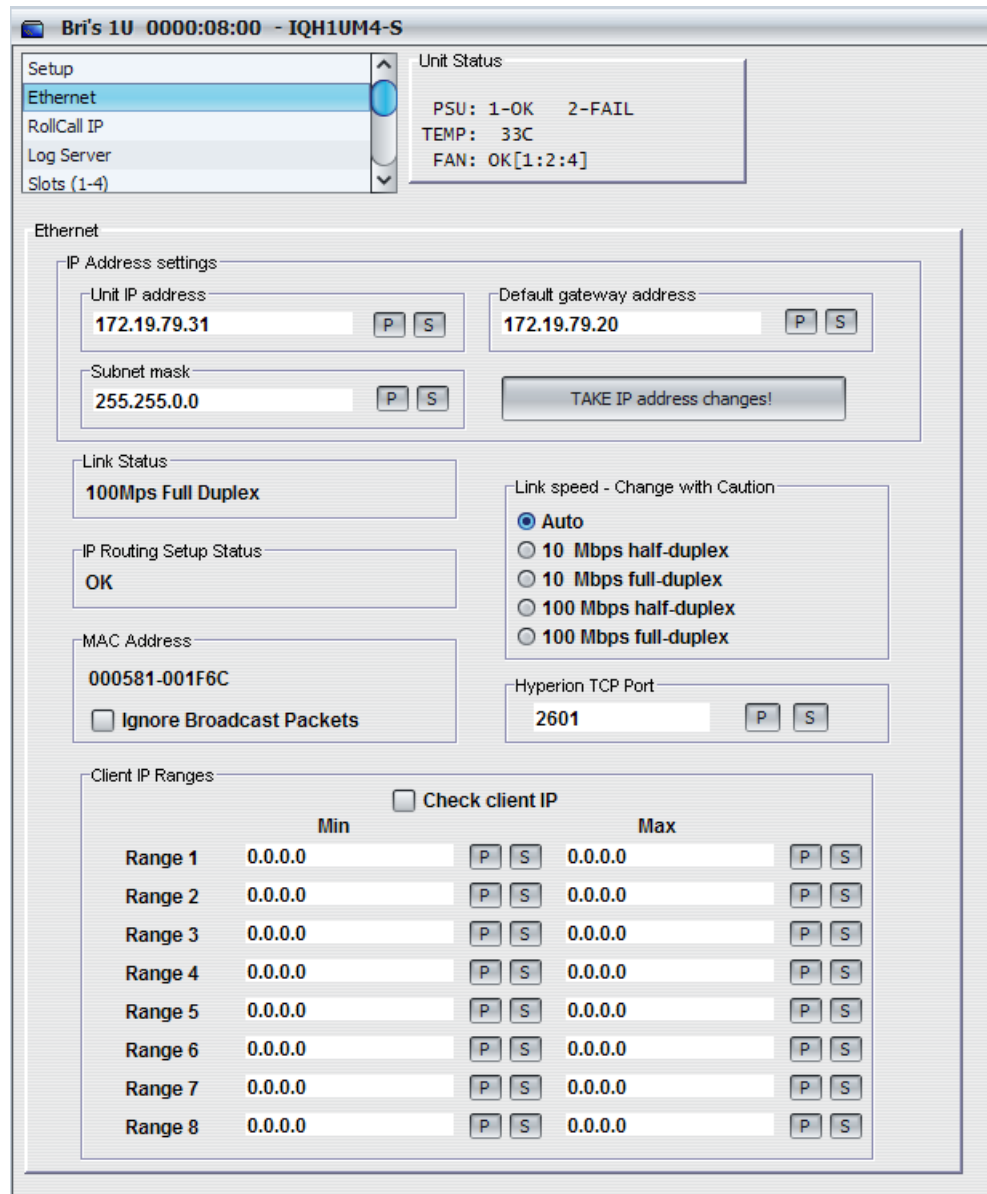

**Note:** Altering any of these settings while connected to the Gateway via IP may result in the connection being lost. If the new values are incorrect it may not be possible to reestablish the connection via IP and a connection via RollNet or the serial port will have to be made to correct the settings.

The network administrator should be able to give the correct setting for these controls.

#### 4.3.1 Unit IP Address / Subnet mask / Default gateway address

The IQ Gateway ships with the following default settings:

- IP address: 192.168.151.1
- Subnet mask: 255.255.0.0
- Default IP Gateway: 0.0.0.0.



### 4.3.2 TAKE IP address changes!

After making changes to any of the IP Address settings (Unit IP address, Subnet mask, or Default gateway address), click Take IP address changes to apply the new IP address values.

### 4.3.3 Link Status

This shows the current status of the Ethernet link. It will either report 'No Link' or the current link speed.

### 4.3.4 IP Routing Setup Status

This will display the status of the IP routing. It could show:

- **FAIL:** IP Address, Subnet Mask and Default Gateway IP Address are not compatible with each other.
- **OK:** IP Address, Subnet Mask and Default gateway are compatible.

### 4.3.5 Link Speed

The link type and speed may be selected from these items. Auto is the default setting.

The alternative manual settings may be used if the switch does not support auto selection.

### 4.3.6 MAC address

This item will show the MAC address, which is a globally unique number identifying an Ethernet unit.

**Important:**

- Note 000581 is the Snell OUI number.
- **Ignore Broadcast Packets** should only be checked if it is possible to resolve IP address to MAC addresses without using the ARP protocol. Please refer to RollCall System Integrators Manual.

### 4.3.7 Hyperion TCP Port

The Gateway will accept Hyperion Thumbnail connections on this port number. The default is 2601.

Thumbnailing is a Hyperion monitoring feature, allowing the viewing of thumbnail image streams, sourced from modules within the enclosure, to a remote PC.

### 4.3.8 Check client IP

When selected only clients from any of the address ranges listed below would be allowed to control this unit.

### 4.3.9 Client IP Ranges

This item allows the permitted Client IP address to be entered.

The Gateway can be configured with one or more IP client ranges. Each range is specified by a minimum and maximum pair of IP addresses. If Check client IP is set then only connections from clients with IP addresses in one of these ranges will be accepted. To specify single IP address, set a minimum and maximum pair to the same address. Ranges where Min or Max is set at 0.0.0.0 are ignored.

**Note:**

If Check client IP is checked and no IP ranges are set, no IP connections will be accepted.

Altering these items only affect new connections; it will not disconnect existing IP connections. This is to prevent errors breaking the connection being used to make the changes.

### 4.4 RollCall IP

The **RollCall IP** screen reports various statistics about IP share connections and allows configuration of the IP bridge function.

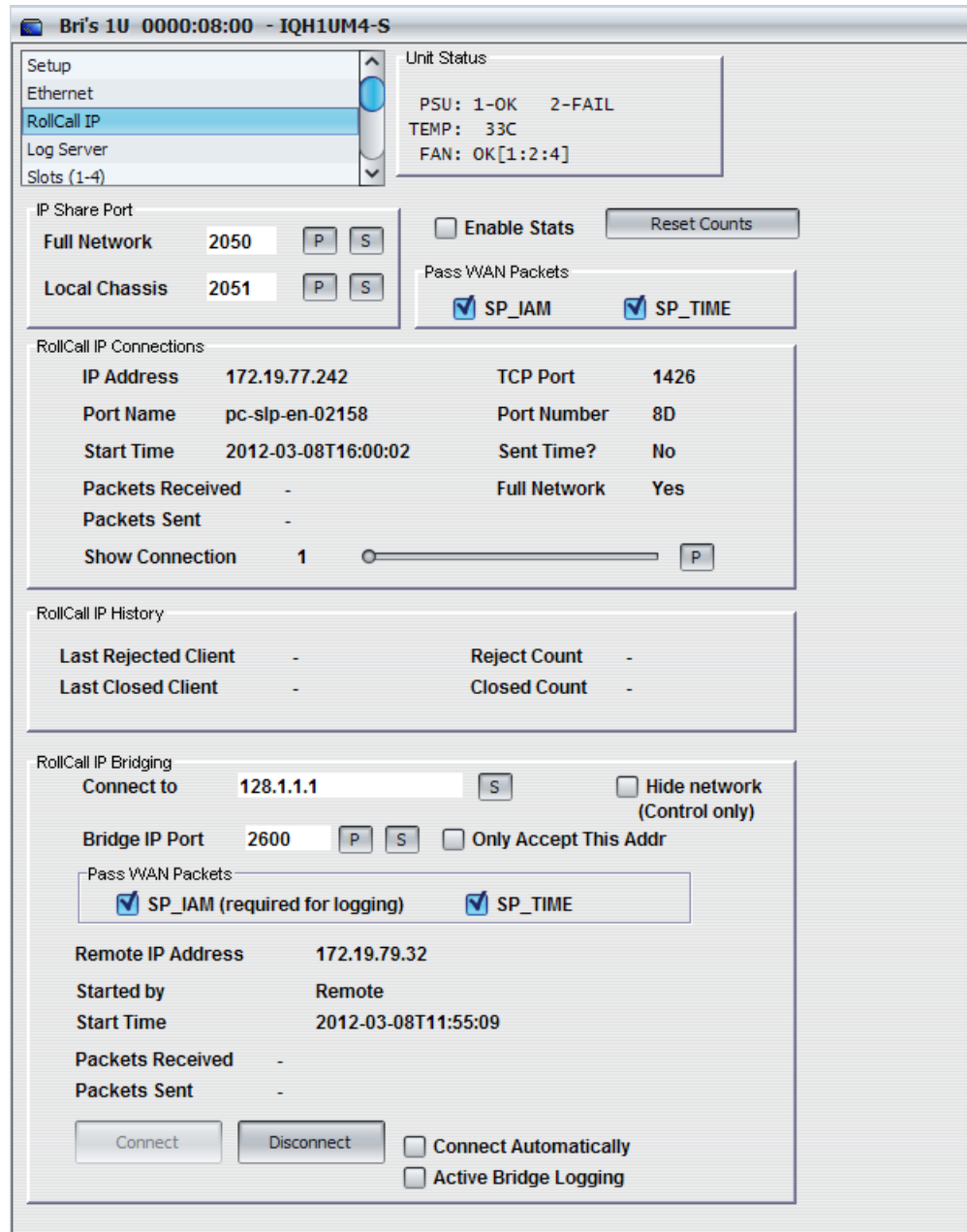

#### 4.4.1 Enable Stats

If the **Enable Stats** box is checked then the various packet counters will be constantly updated.

While Update Packet Stats is disabled these will display a dash (-).

#### 4.4.2 Reset Counts

When the **Reset Counts** button is clicked, all of the packet counters are reset to zero.

#### 4.4.3 IP Share Port

- **Full Network:** The Gateway will accept IP Share connections on this IP port number. The default is 2050. To enter/modify the full network port number, enter the new

number in the editable field and click the Save (S) button. To restore the default value, click the Preset (P) button.

- **Local Chassis:** This port offers a restricted MAP service, only showing itself. It is used primarily in complex RollProxy configurations. To enter/modify the local chassis port number, enter the new number in the editable field and click the Save (S) button. To restore the default value, click the Preset (P) button.

#### 4.4.4 Pass WAN Packets

- **SP\_IAM:** If this check box is checked then the Gateway will pass wide area I AM messages received on IP share links to the RollNet network, and over the IP bridge (if connected).

**Note:**

Pass I\_AM (Bridge) overrides both Pass I\_AM (Serial) and Pass I\_AM (IP). So if Pass I\_AM (Bridge) is set I AM messages will be passed over the bridge, irrespective of how the other controls are set.

- **SP\_TIME:** If this check box is checked then the Gateway will pass wide area TIME messages received on IP share links to the RollNet network, and over the IP bridge (if connected).

**Note:**

The Gateway will always use the received time stamp, whether it passes it on or not (but see also Time from Logger).

#### 4.4.5 RollCall IP Connections

This shows information about IP connections to the Gateway from IP Share or IP Proxy. The information displayed refers to a single connection. Which connection is displayed is controlled by the Show Connection control.

- **IP Address:** This shows the IP address of the remote unit on this IP connection.
- **TCP Port:** This shows the incoming TCP port number of the RollCall IP share connection.
- **Port Name:** This shows the name under which this IP connection appears.
- **Port Number:** This shows which RollCall port on the Gateway this IP connection corresponds to.
- **Start Time:** This shows the time at which this IP connection was started.
- **Sent Time?:** This shows if the remote unit on this IP connection has ever sent us a TIME packet.
- **Packets Receive:** This shows how many packets have been received on this IP connection
- **Packets Sent:** This shows how many packets have been transmitted on this IP connection.
- **Full Network:** This shows which IP port a connection has come in from. Yes indicates that the connection is on the Full Network port, no indicates that the connection is on the Local chassis port.
- **Show Connection:** This controls which IP connection the Gateway shows statistics for.

#### 4.4.6 RollCall IP History

The Gateway may reject IP connections if they do not match the client address set or if the limit on IP connections has been reached.

- **Last Rejected Client:** This shows the IP address of the last client that the Gateway rejected.
- **Reject Count:** This shows the number of attempted IP connections that this Gateway has rejected.
- **Last Closed Client:** IP address of the last client (bridge or other) to close their connection to gateway.
- **Closed Count:** This shows how many IP connections have been closed. The count includes connections that have been closed by the Gateway and by the remote client.

### 4.4.7 RollCall IP Bridging

This menu controls the IP half bridge function of the Gateway.

- **Connect to:** This controls the IP address of the remote half of the IP bridge. This is the address that the Gateway will connect to when it establishes a bridge. The Gateway will accept bridge connections from other IP address unless the Only this Addr checkbox is set.
- **Hide network (Control only):** This control allows the remote network to be hidden from browsers. All other network traffic is allowed through the bridge.

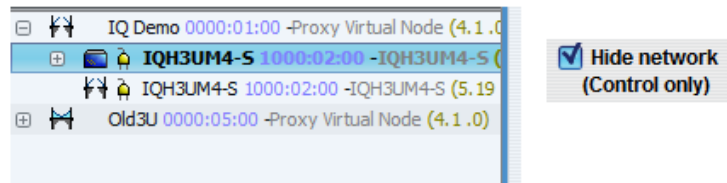
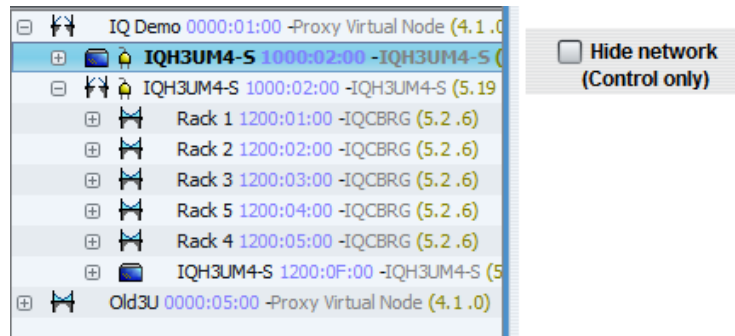

This feature is useful where 2 separate networks are linked with an IP-Bridge (for control purposes, e.g. Rollpod), but the networks are connected to client PC's using IP-Proxy.

- **Bridge IP Port:** This controls the IP port used for bridge connections. It controls both the port that the Gateway will accept connections on, and the port the Gateway will attempt to connect to if it tries to establish a bridge.
- **Only Accept this Addr:** If this checkbox is set then the Gateway will only accept incoming bridge connections from the address specified by Connect to.
- **Pass WAN packets:**
  - **SP\_IAM:** If this checkbox is checked then the Gateway will pass wide area I AM messages received over the IP bridge to the RollNet network.

**Note:** Pass I\_AM (Bridge) overrides both Pass I\_AM (Serial) and Pass I\_AM (IP). So if Pass I\_AM (Bridge) is set I AM messages will be passed over the bridge, irrespective of how the other controls are set.

- **SP\_TIME:** If this checkbox is checked then the Gateway will pass wide area TIME messages received over the IP bridge to the RollNet network.

**Note:** The Gateway will always use the received time stamp, whether it passes it on or not (but see also Time from Logger).

- **Remote IP Address:** This shows the IP address of the remote end of the IP bridge (when connected).
- **Started By:** This shows who initiated the bridge connection. If this unit established the connection it will show 'local' if the remote unit established the connection it will show 'remote'.
- **Start Time:** This shows the time at which the bridge connection was established.
- **Packets Received:** This shows the number of packets received over the IP bridge.
- **Packets Sent:** This shows the number of packets transmitted over the IP bridge.
- **Connect:** This will cause the Gateway to attempt to connect the IP bridge. The Gateway will connect to the IP address and port specified by Bridge IP Addr and Bridge IP Port .
- **Disconnect:** This will cause the Gateway to disconnect the IP bridge. If either end of the IP bridge is set to auto-connect the bridge, then the bridge will be immediately re-established.
- **Connect Automatically:** If this is checked the Gateway will automatically try to establish a bridge connection at system start-up, if the connection fails, or is manually disconnected.
- **Active Bridge Logging:** When enabled, this function changes logging state of log field IP\_BRIDGE\_STATUS to OK or FAIL instead of INFO.

IP_BRIDGE_STATUS	Active Logging	Inactive Logging
Connected	OK:Active	INFO:Active
Disconnected	FAIL:Inactive	INFO:Inactive

## 4.5 Log Server

This **Log Server** screen enables the characteristics of the logging server to be specified.

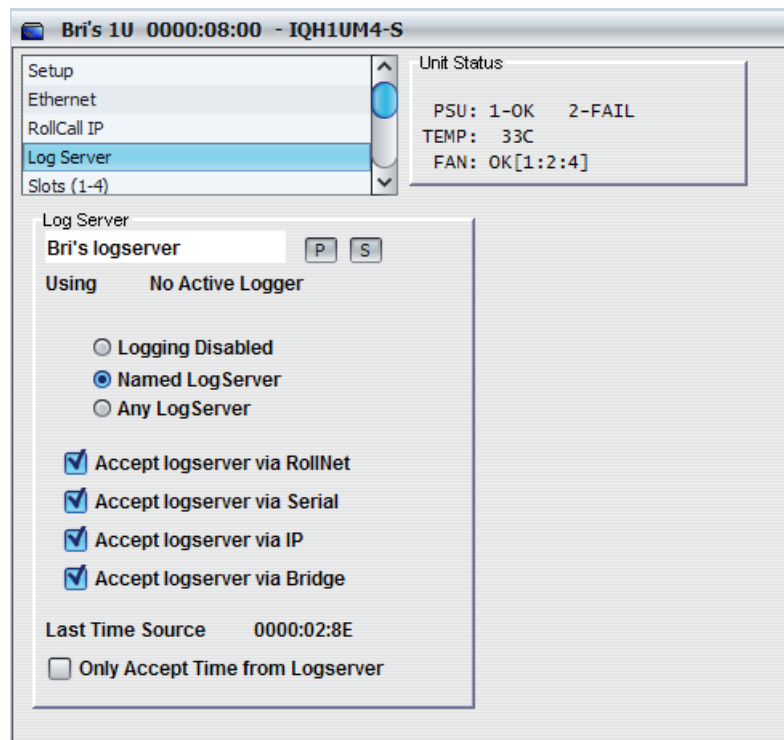

### 4.5.1 LogServer

The Logging Server to be used may be named by editing the text string in the text window. To enter/modify the name of the logging server, enter the new name in the editable text field and click the Save (**S**) button. To restore the default value, click the Preset (**P**) button.

### 4.5.2 Logging Disabled

If this item is checked the Logging function will be disabled.

### 4.5.3 Named LogServer

If this item is checked Logging information will only be sent to the server named in the name window. Note: matching of the name is case sensitive.

### 4.5.4 Any LogServer

If this item is checked Logging information will be sent to any Logger on the system.

It is suggested that if there is only one server on the system, this option should be chosen

### 4.5.5 Using

This displays the name and RollCall address of the current Log Server. If the Gateway does not have a logserver this will show "No Active Logger"

### 4.5.6 Accept logserver via RollNet

If this is selected, the Gateway will accept servers packets via the RollNet port.

### 4.5.7 Accept logserver via IP

If this is selected, the Gateway will accept servers packets via the IP port.

#### **4.5.8 Accept logserver via Serial**

If this is selected, the Gateway will accept servers packets via the serial port.

#### **4.5.9 Accept logserver via Bridge**

If this is selected, the Gateway will accept servers packets via the bridge.

#### **4.5.10 Last Time source**

This shows the address from which the last time packet was received. This can be useful in configuring complex networks.

#### **4.5.11 Only Accept Time from Logserver**

If this is selected the Gateway will only use time packets from the current logserver. This can be useful in configuring complex networks.

### 4.6 Slots (1-4)

The **Slots** screens allow each slot to be named and interrogated.

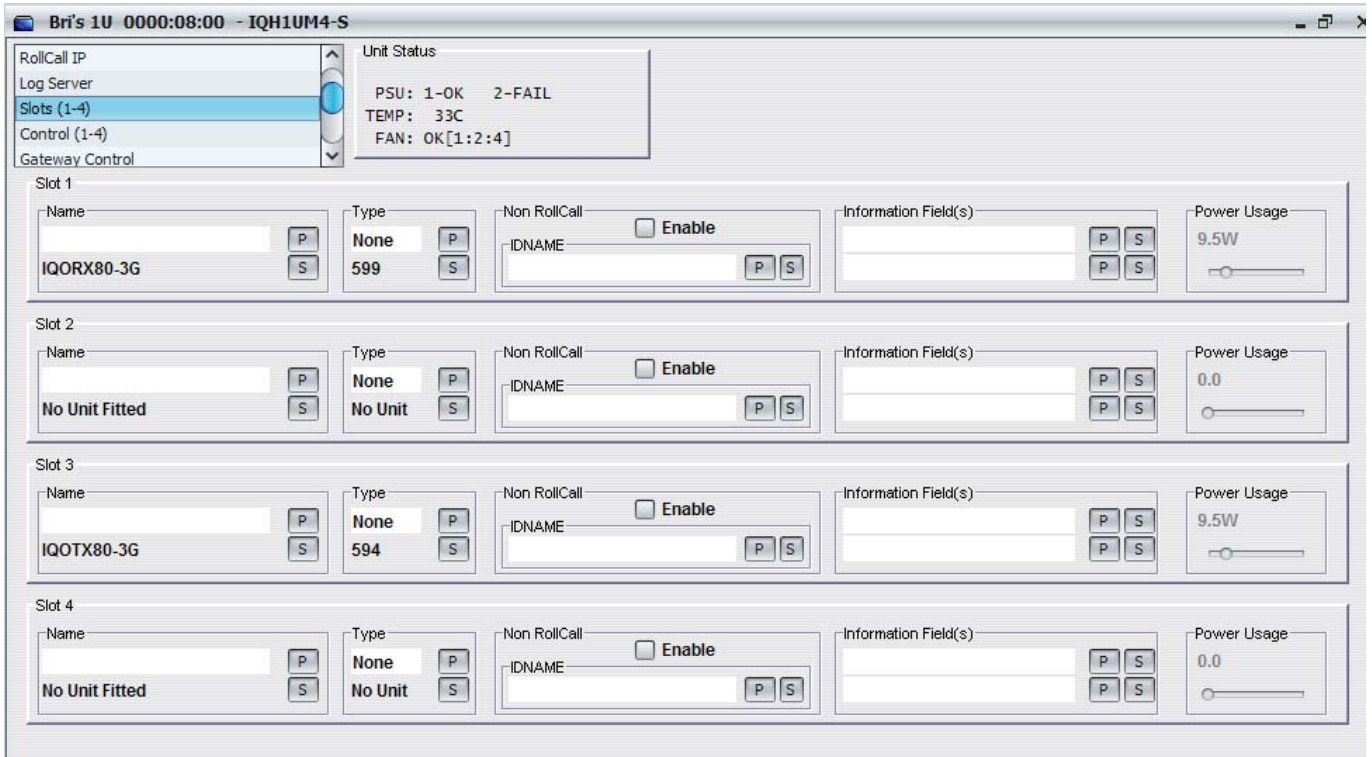

#### 4.6.1 Name

The Name section displays the name and type of module fitted in the enclosure slot. See 4.6.6 Examples of Slot Use on page 51.

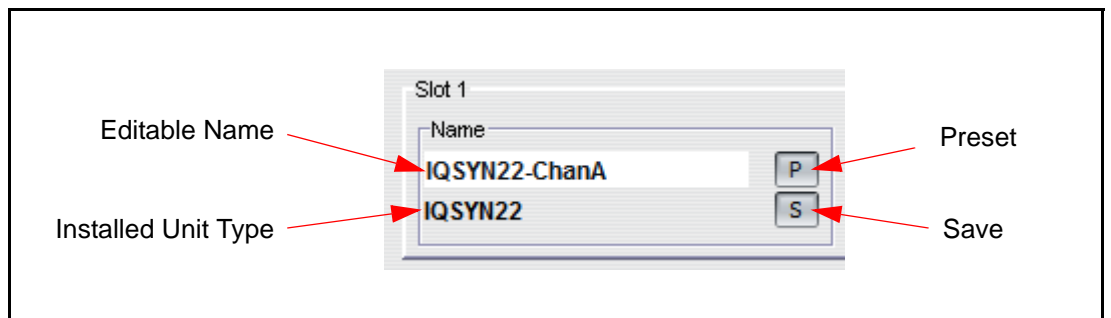

The following controls are provided:

- **Editable Name:** This enables a slot to be given a user name, e.g. **IQSYN22-ChanA**, and so long as the correct card stays in that slot this name will be used, as defined by matching Installed Unit ID and Bound Type ID.

However, if the card is replaced with an incorrect type, e.g. a serial interface, the card will appear by its type generic name e.g. IQCSPI. Although the values in this edit box remains the same. When this entry is edited, the current Installed Unit ID gets copied to the Bound Type ID.

To enter/modify the unit name, type a new name in the editable field and click the Save (S) button. To return to the default name, click the Preset (P) button.

- **Installed Unit Type:** This shows the type of the module fitted in the slot, e.g. **IQSYN22**. If no module is fitted in the slot, **No Unit Fitted** is displayed. If an incompatible module is fitted into a slot, **NOT RollCall 3!** is displayed.



### 4.6.2 Type

This displays the unique identifier of the module fitted in the slot. See 4.6.6 Examples of Slot Use on page 51

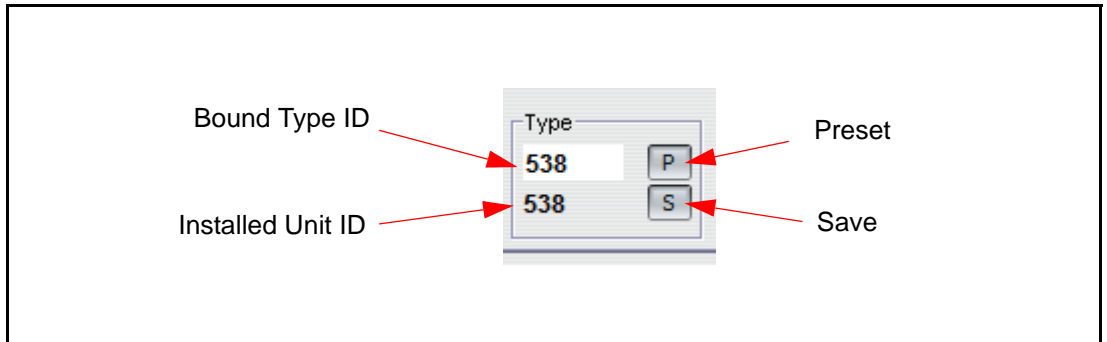

The following controls are provided:

- **Bound Type ID:** This allows the slot to be associated with a particular type of module (e.g. a encoder type 284). If a module matching this type ID is fitted, the Gateway will use the user given name. If an incorrect card type is installed in the slot the RollCall ID will not be correct and the actual card type will be displayed in the module browser. The names and types may be setup before the installation of the modules. Edit the Bound Type ID after editing the Editable Name.

To enter/modify the Bound Type ID, type a new number in the editable field and click the Save (S) button. To return to the default number, click the Preset (P) button.

- **Installed Unit ID:** This displays the identifier of the module fitted in the slot position.

### 4.6.3 Non RollCall

This allows a non-RollCall card inhabiting slot to be identified. See 4.6.6 Examples of Slot Use on page 51

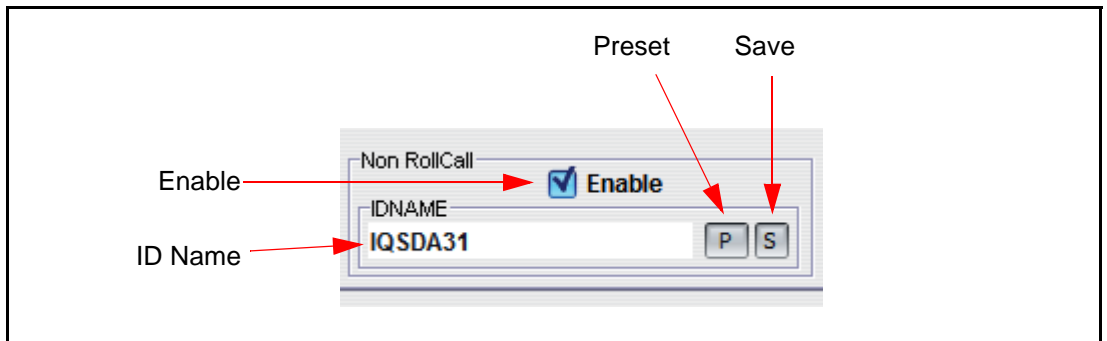

Passive units can be given a name, indicating to RollMap that a card exists.

- **Enable:** Select this option to indicate that a non-RollCall card is in the slot. When this option is selected, the installed unit type of the passive card appears as NOT RollCall 3!, and the installed unit ID appears as 65535.

**Note:** If there is a RollCall-responsive card in the slot, selecting this option has no effect.

- **IDNAME:** This field allows an IDNAME log field to be associated with logs from a non-RollCall card. To enter/modify the Non RollCall ID name, type a new name in the editable field and click the Save (S) button. To return to the default name, click the Preset (P) button.

**Note:** Non-RollCall cards send a MSG=NON ROLLCALLMODULE log to indicate their presence.

### 4.6.4 Information Field(s)

Information fields that may be edited by user to specify any information desired. See 4.6.6 *Examples of Slot Use on page 51*

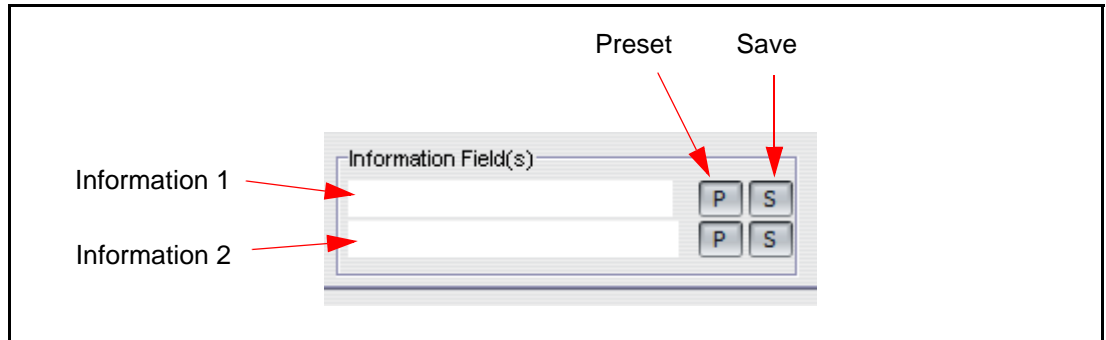

For example, these could be used to name signal paths associated per card. 2 fields are available allowing a maximum of 2 \* 19 characters displayed.

If these fields have edited values then a corresponding log field is raised per slot.

Log field: INFORMATION1= and INFORMATION2=.

**Note:** A global control for these logging fields applies in Logging(2).  
 These fields are always logged whether a unit is present or not.

### 4.6.5 Power Usage

This displays the power usage of the unit fitted in the slot. See 4.6.6 *Examples of Slot Use on page 51*

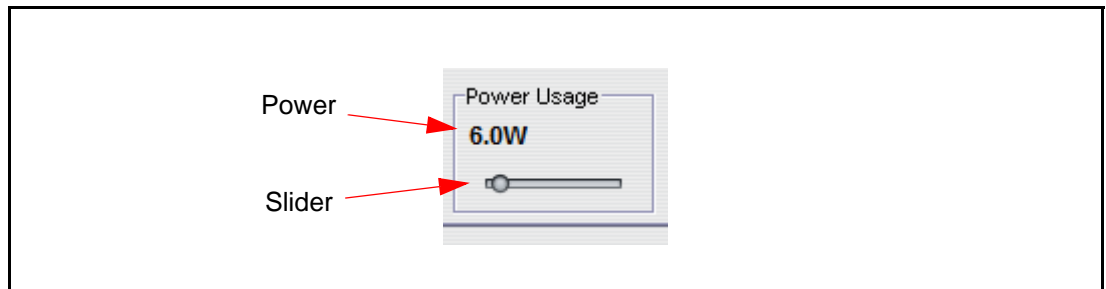

When a card powers up in a slot, its rated power is automatically updated in the Power Usage control.

If a module's ID is not recognized the power usage will indicate ???. If this occurs please contact SAM customer service to obtain the correct power usage value.

Some IQ Modular cards do not appear in the port listing (eg SDA31/33). In this case the **Non Rollcall** Enable checkbox should be enabled, and the type added in the **IDNAME** field.

An "A" type chassis will report power usage in Watts (W). A "B" type chassis will report as Load Units (LU).

The power usage reported may be updated if the unit logs a POWER\_USAGE log field.

## 4.6.6 Examples of Slot Use

### 4.6.6.1 Intentionally Empty Slot

If a slot is intentionally left empty, the Installed Unit Name field will show **No Unit Fitted** and the Installed Unit ID field will show **No Unit**.

The Editable Name field will be empty and the Bound Type ID widow will display **None**.

In the absence of other modules, the Gateway does not log Module Status for this slot position.

### 4.6.6.2 Correct Module Fitted

If a module is fitted that matches the Bound Type, the Editable Name is used in the network browser.

In the absence of other modules, the Gateway will log Module Status as **OK**, and display Module Status = OK on the **Logging** screen. The Gateway also logs MSG=UNIT PRESENT for the slot position.

### 4.6.6.3 Module Absent - Unit Bound

If a slot is intended to have a particular module fitted (as set by the Bound Unit function) but no module is fitted, the Installed Unit Name field will display **No Unit Fitted** and the Installed Unit ID field will display **No Unit**. However, the Editable Name field will show the intended name and the Bound Type ID field will display the intended ID.

In the absence of other modules the Gateway will log Module Status as 1 Module Missing, and show Module Status = 1 Module Missing on the **Logging** screen. The gateway also logs MSG=UNIT LOST for the slot position.

### 4.6.6.4 Module Fitted - No Bound Unit

If a module is fitted in a slot but no Bound Type is assigned to this slot, the generic type name for the module type will be displayed and the slot will appear in the network browser by its slot number and generic type.

In the absence of other modules the Gateway will log Module Status as 1 Extra Module and show Module Status = 1 Extra Module on the **Logging** screen. The Gateway also logs MSG=UNIT PRESENT for the slot position.

### 4.6.6.5 Incorrect Module Fitted

If a module is fitted that does not match the Bound Type, the Editable Name will not be used and the generic type and slot number will appear in the network browser.

In the absence of other modules, the Gateway will log Module Status as 1 Wrong Module, and show Module Status = 1 Wrong Module on the **Logging** screen. The gateway also logs MSG=UNIT PRESENT for the slot position.

### 4.6.6.6 Non-RollCall Module Fitted

If a card that is passive to RollCall is fitted in a slot, select the Non RollCall Enable check box. The Gateway will simulate a RollCall compatible card in the relevant slot, and raise awareness to RollLog and RollMap. In the IDNAME field, enter a name for the unit so that it can be recognized.

For the module, the Gateway will log MSG=NON ROLLCALLMODULE, and IDNAME=<user defined>.

### 4.7 Control (1-4)

The **Control** screens display information about the controllers for each slot.

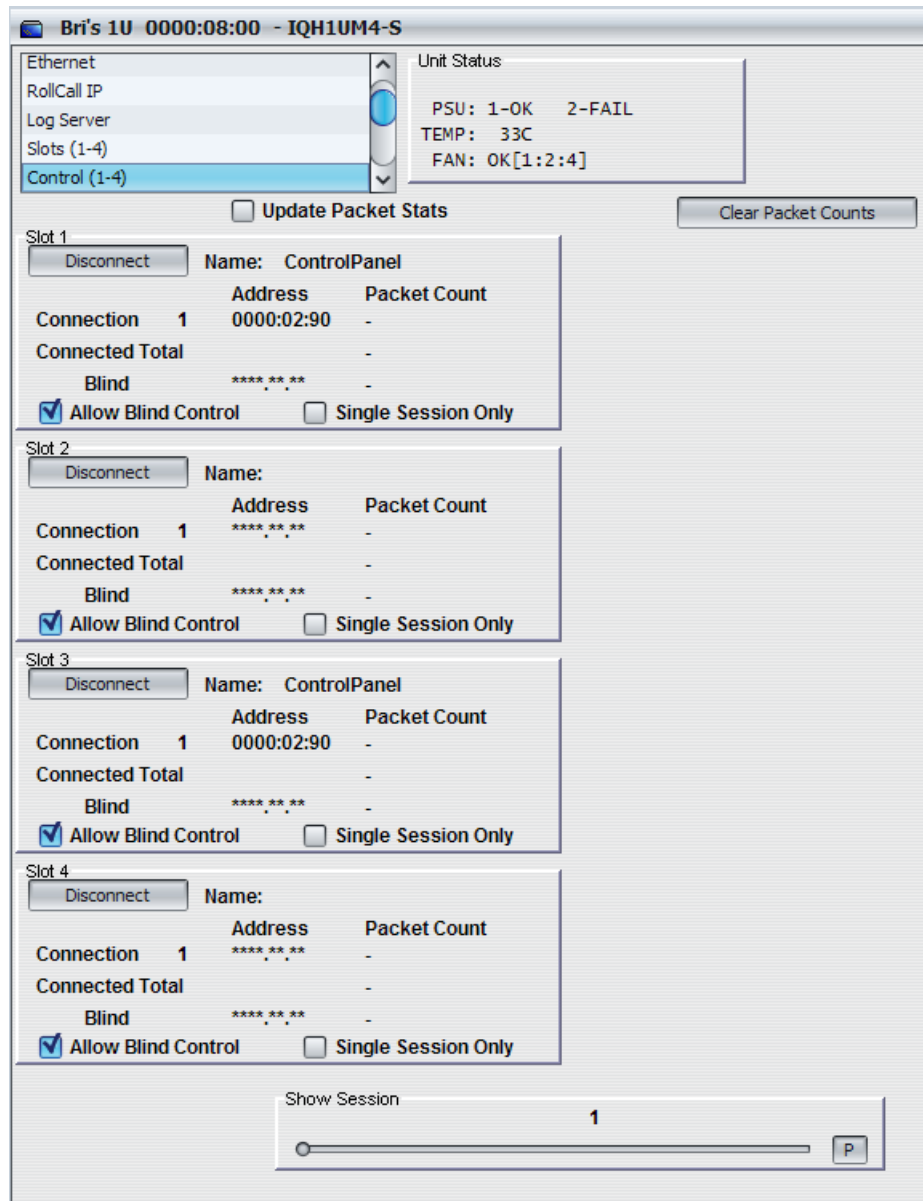

#### 4.7.1 Update Packet Stats

When the modules receive commands from control clients the number of commands are counted. If the **Update Packet Stats** box is checked, the number of control packets from the currently selected connected controller and from all connected controllers is shown to the right of the controller address. The number of blind control packets is shown to the right of the blind controller address.

If the **Update Packet Stats** box is unchecked, the packet counts will be replaced with dashes (-).

**Note:** The packets are still counted while Update Packet Stats is disabled. When enabled, the Gateway will display current totals; they will not restart from zero.

#### 4.7.2 Clear Packet Counts

When the **Clear Packet Counts** button is clicked, all packet counters will be reset to zero.

### 4.7.3 Slots 1 to 4

These sections display information about control clients.

Active Front Panels and RollCall PC programs use a RollCall connection to control a module.

RollTrack does not use a connection, it uses Blind control. Blind Control is the ability to control a unit without a connection.

**Note:**

When SNMP is enabled generally the first session displayed is the current SNMP session to that module

- **Disconnect:** The Disconnect button will disconnect the currently displayed connected controller.
- **Name:** This shows the RollCall controller client name / per session. If SNMP is enabled, one of the session names corresponds to the name of the Gateway unit.
- **Connection:** This displays the address of the connected controllers. The Show Session control can be used to scroll through the connected controllers. If SNMP is enabled, then the Gateway itself will be shown as one of the controllers, usually the first controller. Packet counts from this controller, and from all connected controllers, are displayed to the right.
- **Blind:** This will display the address of last controller to send the module a blind control packet. Packet counts from blind controllers is shown to the right.
- **Allow Blind Control:** If the module is to be controlled by Blind Control (RollTrack and some third party remote control systems), the Allow Blind Control box must be checked. If Blind Control is not used, Allow Blind Control may be disabled, giving protection against incorrectly set-up RollTrack sources.
- **Single Session Only:** When this box is checked, only one connected controller is allowed to control the module at any one time.

### 4.7.4 Show Session

This controls which client is displayed by the other Control menu items. Click and drag the slider to increase or decrease the number of clients displayed.

## 4.8 Gateway Control

This **Gateway Control** screen provides information about control clients connected to the gateway unit itself (not to modules inside the enclosure). Note if SNMP is enabled, one of the sessions is looped back to itself.

**Control**

Name	Address	Packet Count	Connected Total
ControlPanel	0000:02:8D	-	-

Blind control

Address	Packet Count
****.**.*	-

Statistics control

Update Packet Stats

### 4.8.1 Control

- **Name:** This shows the RollCall controller client name / per session. Note if SNMP is enabled, one of the session names corresponds to the name of the gateway unit.
- **Address:** Remote address of Controller client
- **Packet Count:** The number of control packets on session to remote client
- **Connected Total:** The total number of control packets on all sessions. This includes previously closed client session counts. This value is cleared by clicking the **Clear Packet Count** button.
- **Show Session:** Drag the slider to browse different sessions. All sessions are indexed from 1, with no gaps in between. Click the Preset (**P**) button to return to the default value.
- **Disconnect Session:** When this button is clicked, the current displayed session is disconnected.

### 4.8.2 Blind Control

Displays information on the last blind controller to the gateway.

- **Allow Blind Control:** If this box is enabled, blind control packets are accepted at the gateway.
- **Address:** Last known blind controller address. This value is cleared by clicking the **Clear Packet Count** button.
- **Packet Count:** The number of blind control packets since last cleared / reset.

### 4.8.3 Statistics Control

- **Update Packet Stats:** If ticked, packet counts updated each second on displayed session and blind controllers.
- **Clear Packet Counts:** Clears and resets connected and blind packet counts, resets last blind controller address.

### 4.9 SNMP (Simple Network Management Protocol)

The **SNMP** screen enables configuration of the SNMP agent that operates within the Gateway card.

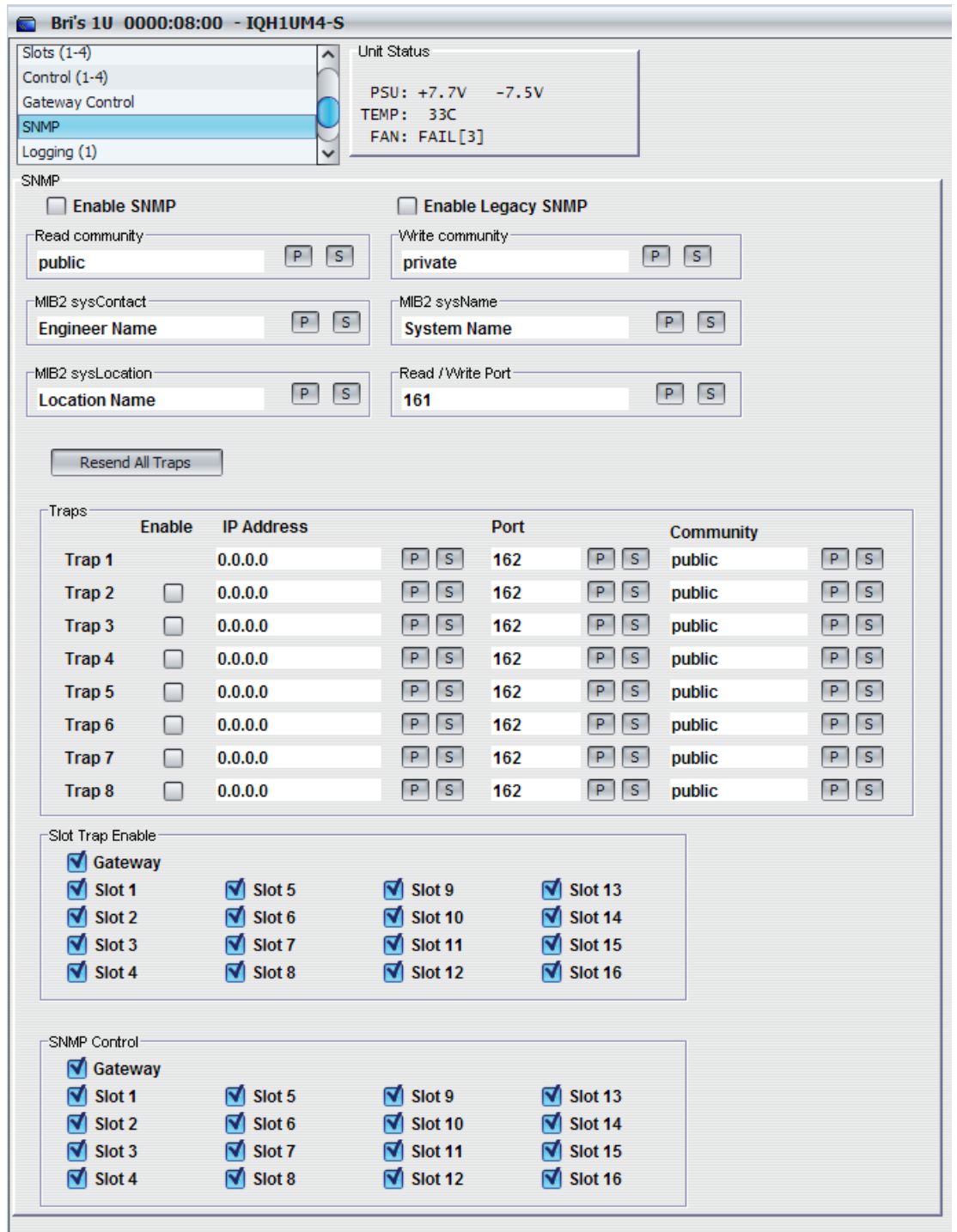

**Note:** In order for the SNMP to operate, the Ethernet must have a physical connection available.

#### 4.9.1 Enable SNMP

This enables or disables the SNMP functions of the Gateway.

**Note:** Enabling SNMP makes certain older modules inaccessible at non-Supervisor levels, and thus prevents certain module-specific PC tools from working correctly. The work-around is to temporarily disable the SNMP agent whilst using these tools.



### 4.9.2 Enable Legacy SNMP

This enables the legacy SNMP function. This is provided for customers whose system relies on the SNMP implemented on earlier Gateway versions (V2.14..6). If you are an existing SNMP user, and want the Gateway to provide the same interface as previous versions, enable this checkbox.

Enabling this does not prevent operation of the full SNMP agent.

### 4.9.3 Read community

Configures the SNMP read community value. Default value "public".

### 4.9.4 MIB2 sysContact

Customer given name of person responsible for equipment.

### 4.9.5 MIB2 sysLocation

Customer given physical or logical location of system.

### 4.9.6 Write community

Configures the SNMP write community value. Default value "private".

### 4.9.7 MIB2 sysName

Name of system if applicable.

### 4.9.8 Read Write Port

TCP/IP port number (range:1-65535) used in all SET and GET SNMP operations. Default is 161. The SNMP manager should match this value to operate correctly.

**Note:** Changing this value restarts the SNMP agent.

### 4.9.9 Resend All Traps

Resends all current traps/notifications for all occupied slots and Gateway card. If legacy operation is enabled, the associated traps are also sent.

### 4.9.10 Traps

The Gateway supports up to eight trap destinations. Each entry must be unique, unless IP trap address is set to 0.0.0.0. For each trap the user can configure:

- **IP address:** The IP address, format nnn.nnn.nnn.nnn, to which notifications (traps) are sent. This address should correspond to the IP address of the PC monitoring notifications.
- **Port:** The connection port address used to send notifications. The target machine (IP address) should be configured to "listen" for notifications on this port. The SNMP default is 162, but other port numbers may be used.
- **Community:** Trap Community string. This string is included within the SNMP trap message.
- **Enable:** Enable this Trap destination. Trap dest 1 is always enabled when SNMP is enabled, so it has no enable control.

#### **4.9.11 Slot Trap Enable**

With SNMP enabled, these controls allow filtering of trap messages from individual slot positions, or even the Gateway. Trap sending is only available when control is enabled for the slot. See *SNMP Control* below.

#### **4.9.12 SNMP Control**

These checkboxes allow filtering of SNMP control to only the desired slots / gateway. If traps are required on a slot, control must also be enabled.

### 4.10 Logging 1

The **Logging 1** screen shows the information made available via RollCall logging, and allows the user to specify which fields will be logged.

Each log field is shown on a separate line. Each has an enable checkbox, a descriptive name, the log field header and the current value.

The only exceptions are Serial Number and Software Version, which are always logged and therefore have no enable checkbox.

When the checkbox is checked, that field will be logged to the logserver.

Description	Log Header	Current Value
Serial Number	SN=	<Not Set Yet>
Software Version	VERSION=	5.19 .19
<input checked="" type="checkbox"/> Build Number	BUILD_NUMBER=	0189804151
<input checked="" type="checkbox"/> OS Version	OS_VERSION=	V115 Release
<input checked="" type="checkbox"/> Hardware Version	HARDWARE_VERSION=	RCIF3U2C
<input checked="" type="checkbox"/> Loader Version	LOADER_VERSION=	2.23 .9
<input checked="" type="checkbox"/> IP Address	IPADDRESS=	172.19.79.31
<input checked="" type="checkbox"/> Module Summary Status	MODULE_STATUS=	WARN:2 EXTRA MODULE
<input checked="" type="checkbox"/> No. Of Gateway Ctrl Sessions	SESSIONS=	1
<input checked="" type="checkbox"/> Gateway Last Modified	LAST_MODIFIED=	2012-03-08T13:11:16
<input checked="" type="checkbox"/> Faults	FAULT=	OK:None
<input checked="" type="checkbox"/> PSU 1 Name	PSU_1_NAME=	PSU 1
<input checked="" type="checkbox"/> PSU 1 State	PSU_1_STATE=	OK
<input checked="" type="checkbox"/> PSU 2 Name	PSU_2_NAME=	PSU 2
<input checked="" type="checkbox"/> PSU 2 State	PSU_2_STATE=	FAIL
<input checked="" type="checkbox"/> Recon State	RECON_STATE=	OK
<input checked="" type="checkbox"/> Lan Port 1 Name	LAN_PORT_1_NAME=	FastEthernet0/1
<input checked="" type="checkbox"/> Lan Port 1 State	LAN_PORT_1_STATE=	Active
<input checked="" type="checkbox"/> Lan Port 1 Speed	LAN_PORT_1_SPEED=	100 Mbit/s Full Dup
<input checked="" type="checkbox"/> Lan Port 1 Last Change	LAN_PORT_1_LAST_CHANGE=	000:00:00:00
<input checked="" type="checkbox"/> Lan Port 1 Errors	LAN_PORT_1_ERRORS=	0 in total
<input checked="" type="checkbox"/> Lan Port 1 InTraffic	LAN_PORT_1_TRAFFIC_IN=	2.6 KBytes/sec
<input checked="" type="checkbox"/> Lan Port 1 OutTraffic	LAN_PORT_1_TRAFFIC_OUT=	0.0 KBytes/sec
<input checked="" type="checkbox"/> Ip Event	IP_EVENT=	172.19.79.32 DISCON
<input checked="" type="checkbox"/> Uptime	UPTIME=	000:04:12:00
<input checked="" type="checkbox"/> Restarted At	RESTARTED_AT=	2012-03-08T11:54:37

Field Name	Field Name Description	Valid Field Values	Usage Description
SN	Serial Number	Serial Number	Format is standard S&W serial number consisting of character 'S' followed by eight digits, e.g. "S12345678"
VERSION	Software Version	Software Version Number	Eg. 5.18.18
BUILD_NUMBER	Build Number	Text	For K_OS-based units, this is typically a ten-digit string, e.g. "0123456789". Future units may use a different format.
OS_VERSION	OS Version	OS Name & Version	Format: "<OS String> <Version String>", e.g. "KOS V115"
HARDWARE_VERSION	Hardware Version	Version Number	Format: "<PCB name>/<mod strike>", eg "RCIF3U2Y/2"
LOADER_VERSION=	Loader Version	Version Number	For example, 2.17 .7.
IPADDRESS	IP Address	WARN: None WARN: Invalid Address  Numeric IP Address	No IP Address Specified  Invalid address, subnet or gateway value specified.  IP Address of unit in Ipv4 dotted decimal notation: xxx.xxx.xxx.xxx
MODULE_STATUS=	Module Status	OK 1 EXTRA MODULE n EXTRA MODULES 1 MODULE MISSING n MODULES MISSING 1 WRONG TYPE n WRONG TYPES	where 2 <= n <= 16  Status of module type/per slot configuration matching or Modules mismatched / missing
SESSIONS	Control Sessions	Number	0...n – No. of connected CONTROL sessions
LAST_MODIFIED	Last Modified	UTC Timestamp	The time a control was last modified on a unit. Format: as per ISO 8601 for Co-ordinated Universal Time (UTC), i.e. YYYY-MM-DDTHH:MM:SSZ,  where the trailing 'Z' indicates UTC rather than local time.
FAULT	Internal fault status of unit	NONE FAIL: <fault description>	This field is used to report internal hardware or software faults detected by a unit (as distinct from external error conditions, e.g. loss of input).
PSU_1_NAME PSU_2_NAME	Name of PSU	Text	Function name such as  Left PSU, Right PSU  Top PSU, Bottom PSU  PSU 1, PSU 2 etc.  These are set by the product and are not user settable.
PSU_1_STATE PSU_2_STATE	PSU State	OK FAIL FAIL: Not Fitted  Not Used	PSU is present and operating correctly  PSU presence is detected but not operating  PSU is not fitted and the RollCall control for the product has specified that the PSU is fitted  PSU is not fitted and the RollCall control for the product has specified that the PSU is NOT fitted
RECON_STATE=		OK Warn Fail	0 RollNet reconnections in last 10 seconds  1 Rollnet reconnection in last 10 seconds  >1 RollNet reconnection in last 10 seconds

Field Name	Field Name Description	Valid Field Values	Usage Description
LAN_PORT_n_NAME	Ethernet port name as defined by the OS	Typical example format is: FastEthernet0/24	Where FastEthernet is the port type, other reported types are GigabitEthernet  0 is the interface binding and 24 is the physical port number  On devices with only one physical 10/100 Ethernet connection the reported string would be:  FastEthernet0/1
LAN_PORT_n_SPEED	Ethernet connection speed	10 Mbit/s Full Duplex 10 Mbit/s Half Duplex 100 Mbit/s Full Duplex 100 Mbit/s Half Duplex 1 Gbit/s Full Duplex No Link	LAN speed in megabits per second, and duplex mode. Use No Link when Ethernet cable unconnected or not init.
LAN_PORT_n_LAST_CHANGE	Time from start since last Port Change	Number DDD:HH:MM:SS	Time change when IP interface parameters altered (ie IP subnet)  Uptime in specified format updated every minute, NOTE: field value is zero buffered 001:08:10:00 (is 1 day, 8 hours, 10 minutes, 0 seconds)  Derived from MIB-II ifLastChange
LAN_PORT_n_ERRORS	Total number errors	XXX in total	Summation of MIB-II values ifInDiscards+ifInErrors+ifInUnknownProtos+ifOutDiscards+ifOutErrors.  Updated periodically (60 sec interval)
LAN_PORT_n_TRAFFIC_IN	Traffic In / min	NNN.n Kbytes/sec	MIB-II ifInOctets. e.g. "LAN_PORT_5_TRAFFIC_IN=12.3 KBytes/sec"  Format ("%0.1f")
LAN_PORT_n_TRAFFIC_OUT	Traffic Out / min	NNN.n Kbytes/sec	MIB-II ifOutOctets. e.g. "LAN_PORT_5_TRAFFIC_OUT=12.3 KBytes/sec"  Format ("%0.1f")
IP_EVENT	Text	xxx.xxx.xxx.xxx CONNECT FROM xxx.xxx.xxx.xxx DISCONNECT FROM xxx.xxx.xxx.xxx BRIDGE CONNECT TO xxx.xxx.xxx.xxx BRIDGE CONNECT FROM	Free text for miscellaneous IP event messages such as  xxx.xxx.xxx.xxx CONNECT FROM. Note IP address is not zero buffered.  This column is informational and not to be used for defined error states
LAN_PORT_n_STATE	Ethernet connection state	Active WARN: Inactive	Does the Ethernet have electrical connectivity
UPTIME	Uptime in seconds	Number DDD:HH:MM:SS	Uptime in specified format updated every minute, NOTE: field value is zero buffered 001:08:10:00 (is 1 day, 8 hours, 10 minutes, 0 seconds)
RESTARTED_AT	Last Restarted (UTC)	UTC Timestamp	UTC Time of last reboot, formatted as per ISO8601 as above.

### 4.11 Logging 2

The **Logging 2** screen shows the information made available via RollCall logging, and allows the user to specify which fields will be logged.

Each log field is shown on a separate line. Each has an enable checkbox, a descriptive name, the log field header and the current value.

When the checkbox is checked, that field will be logged to the logserver.

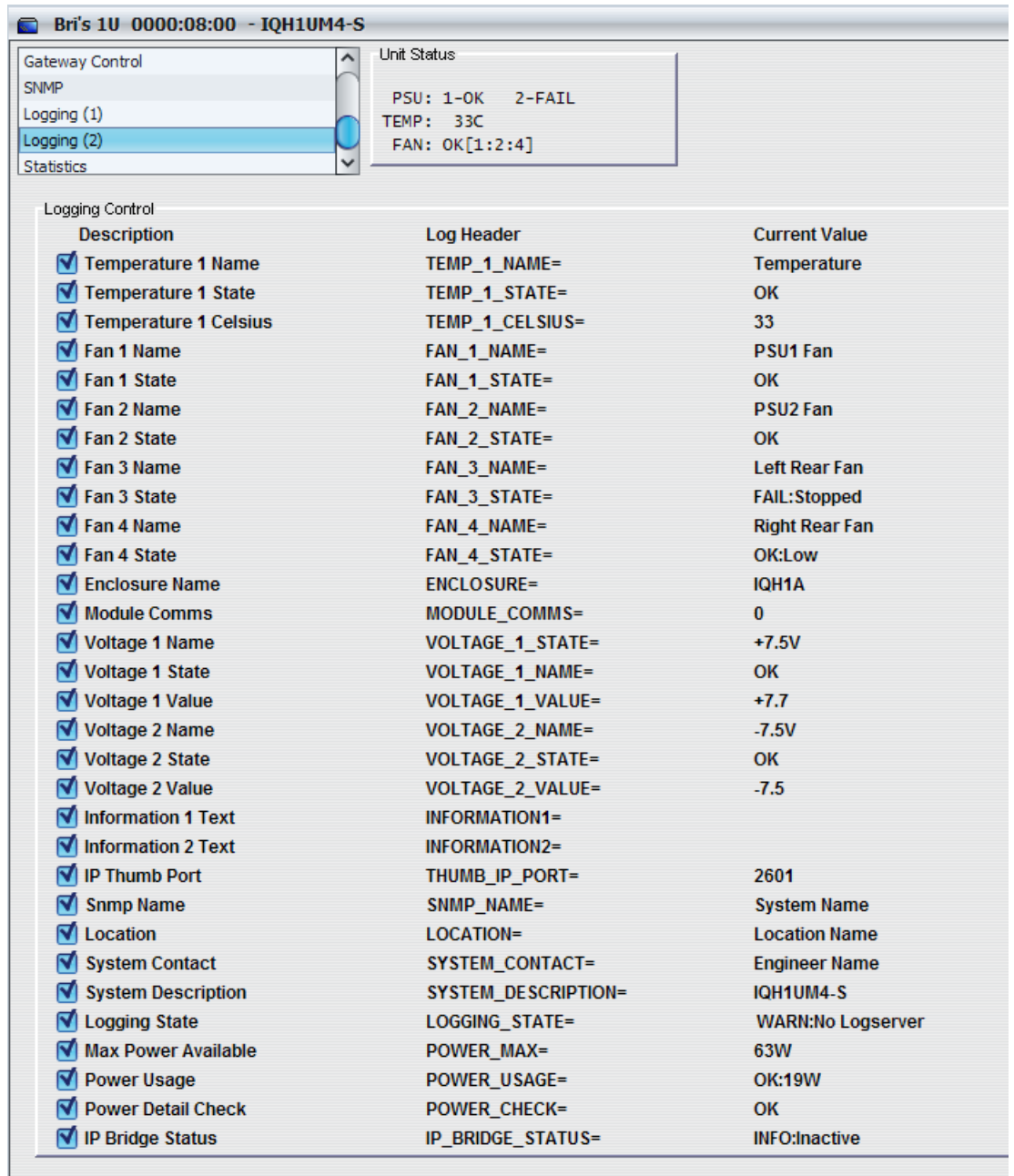

Field Name	Field Name Description	Valid Field Values	Usage Description
TEMP_1_NAME TEMP_2_NAME	Name of temp sensor	TEXT	Function name such as Temperature In, Temperature Out  Internal Temperature, PSU 1 Temperature, etc.  These are set by the product and are not user settable.
TEMP_1_STATE TEMP_2_STATE	Temperature status	OK  WARN: Low  WARN: High  FAIL : Low FAIL: High FAIL:Not Available FAIL:Sensor Fault  Disabled	Temp is within operating range  Temp below normal operating range, but not critical  Temp above normal operating range, but not critical  Temp below normal operating range, Critical  Temp above normal operating range, Critical Sensor non-detected Sensor malfunction  Temperature detection has been manually disabled  Each product must specify its own operating ranges and safety thresholds, however suggestion is that WARN thresholds exist 5 degrees C away from defined product FAIL thresholds. e.g. : Product Specification is 0-40 Degrees C, so WARN will be <= 5 and >=35.
TEMP_1_CELSIUS TEMP_2_CELSIUS	Temperature in °C	Number	Temperature in Celsius  Temperature will be blank if the temperature sensor is not enabled.
FAN_1_NAME FAN_2_NAME FAN_3_NAME FAN_4_NAME	Name of Fan	Text	This is set by the product and are not user settable.
FAN_1_STATE FAN_2_STATE FAN_3_STATE FAN_4_STATE	Fan State	OK:Low OK:Medium OK:High WARN:Max FAIL:Stopped FAIL:ShortCircuit	Fan is running OK. Low speed mode  Fan is running OK. Medium speed mode  Fan is running OK High speed mode  Fan is running at maximum speed  Fan has ceased running, Critical Fan has become short circuit, Critical
ENCLOSURE	Enclosure Name	IQH1A, IQH3A or IQH3B	Displays the name of the IQ Modular Enclosure.
MODULE_COMMS	State of module comms bus	Number of bus errors per 20 seconds	Running average of bus errors, 0 would indicate good comms. For IQ Modules, this bus is I2c.
VOLTAGE_1_NAME VOLTAGE_2_NAME	Voltage rail name	Text	For IQ these are +7.5V & -7.5V rails.
VOLTAGE_1_STATE VOLTAGE_2_STATE	Is the voltage rail within spec?	OK  FAIL: High  FAIL: Low	Voltage rail is within spec  Absolute value of voltage rail is above normal operating threshold  Absolute value of voltage rail is below normal operating threshold  This definition means that if the -7V rail is at -9V, it would be shown as FAIL:High  Definition of out of spec is on a per product basis. The user manual for the product must reflect the out of spec ranges.
VOLTAGE_1_VALUE VOLTAGE__VALUE	The value of the voltage rail	Text	+nn.nnV  -nn.nnV
INFORMATION1	1st Information field	Text	User definable text.

Field Name	Field Name Description	Valid Field Values	Usage Description
INFORMATION2	2nd Information field	Text	User definable text.
THUMB_IP_PORT	Thumb IP Port value	NUMBER	Reports the IP Port number used for Hyperion Thumbnail monitoring. Ensure enabled if Hyperion monitoring uses the auto discovery feature.
SNMP_NAME=	SNMP Name	Text	Reports the SNMP system name as specified in the MIB2 sysName field on the SNMP page.
LOCATION=	Location	Text	Reports the SNMP physical or logical system location as specified in the MIB2 sysLocation field on the SNMP page.
SYSTEM_CONTACT=	System Contact	Text	Reports the SNMP system contact as specified in the MIB2 sysContact field on the SNMP page.
SYSTEM_DESCRIPTION=	System Description	Text	Reports a description of the gateway type, for example IQH3UM4-S.
LOGGING_STATE=	Logging State	OK WARN:No Logserver WARN: Address Change FAIL:Name Change	This log field indicates whether logging is functioning properly. <b>Note:</b> When Gateways are set to log, there should only be one LogServer. It is not recommended to log to more than one LogServer. It is possible to see more than one LogServer over multiple network addresses, but again, this is not recommended.
POWER_MAX=	Max Power Available	141W - Power for IQH3A 63W - IQH1A 165LU - IQH3B, (Load Units)	Maximum power according to enclosure type.
POWER_USAGE=	Power Usage	OK:nnnW or OK:mmmLU e.g. OK:74W / OK:72LU WARN:nnnW or WARN:mmmLU e.g. WARN:144W / WARN:167LU	Current power usage of all cards fitted. This will indicate WARN if value exceeds POWER_MAX
POWER_CHECK=	Power Detail Check	OK WARN:REFER MANUAL	Reports if cards have a known power rating, or not. If any card is not recognized it will port WARN:REFER MANUAL, else OK.
IP_BRIDGE_STATUS=	IP Bridge Status	OK:Active (Connected) FAIL:Inactive (Disconnected) INFO:Active (Connected) INFO:Inactive (Disconnected)	When enabled, changes logging state of log field IP_BRIDGE_STATUS to OK or FAIL instead of INFO.



## 4.12 Statistics

The Statistics screen displays any errors that may occur within a system.

In the event of a problem, these error messages may be quoted to SAM customer support to assist debugging.

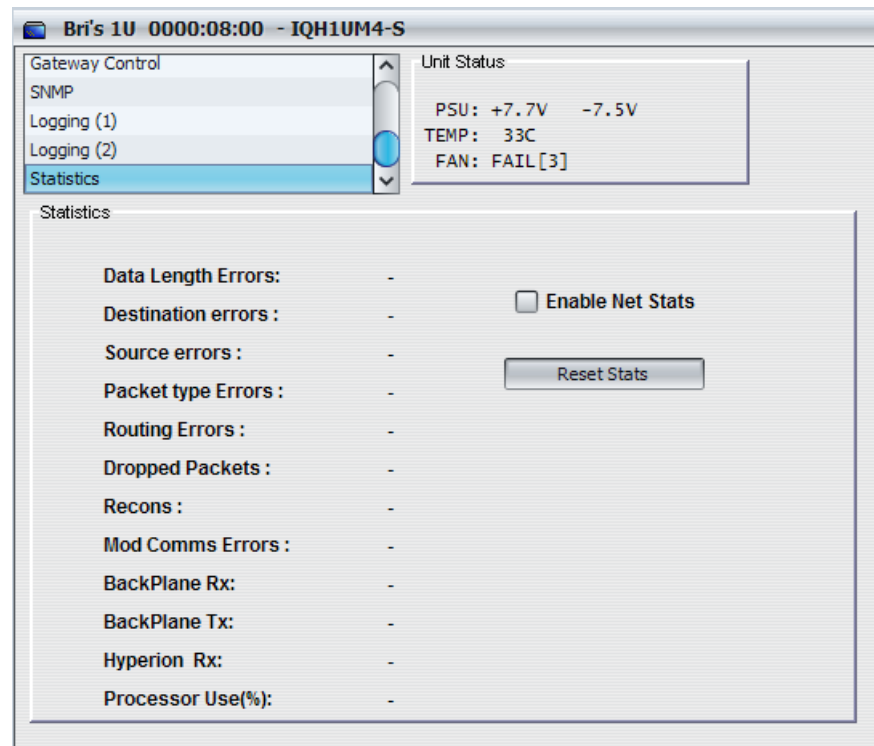

### 4.12.1 Statistics

The following items are displayed:

- **Data Length Errors:** This counts packets that are an incorrect length.
- **Destination Errors:** This counts packets that have an incorrect destination identifier.
- **Source Errors:** This counts packets that have an incorrect source identifier.
- **Packet Type Errors:** This counts packets that have an incorrect packet type.
- **Routing Errors:** This counts packets that cannot be routed to the indicated destination.
- **Dropped Packets:** This counts packets that cannot be delivered.
- **Recons:** This counts network reconfigurations. Network reconfigurations are normal events when units join or leave the network. They may also occur occasionally due to electrical interference. Constant reconfigurations indicate a physical fault. Possible faults include.
  - Faulty T piece or cable
  - Missing termination(s)
  - Incorrect value of termination(s)
  - Clash of a RollCall Address
  - Network cable length exceeded\*

- Number of unit loads per segment exceeded\*

\*Please refer to RollCall System Integrators Manual.

- **Module Comms Errors:** This counts errors on the I2C bus.
- **BackPlane Rx:** This counts the bytes/second of RollCall traffic received down the Backplane. This count cannot be reset.
- **BackPlane Tx:** This counts the bytes/second of RollCall traffic transmitted down the Backplane. This count cannot be reset.
- **Hyperion Rx:** This counts the bytes/second of received hyperion traffic (thumbnails). This count cannot be reset.
- **Processor Use(%):** This reports the processor use. The percentage is updated every second. This count cannot be reset.
- **Enable Net Stats:** This box must be checked to enable the error counts to be updated. If this checkbox is not enabled all statistics will be displayed as '-'.
- **Reset Stats:** Click this button to reset all statistics to zero.

## 5 RollCall Control Panel Applet

The RollCall Control Panel Applet is a Java applet which runs in a compliant web browser. This allows easy access and control of all RollCall controllable products and can be used as a replacement for the standard RollCall Control Panel.

For details of templates, menus, caching, savesets, etc., please refer to *Section 4 Operation*.

### 5.1 Pre-requisites for Running the Applet

The following pre-requisites are required before the running the RollCall Control Panel Applet:

- Windows XP, Windows 2000, Windows 7 or Windows 10 OS.
- The Oracle JRE 1.7 or higher must be installed (JRE = Java Runtime Environment).
- A web browser must be installed.

The Control Applet has been successfully tested with the following web browsers:

- Internet Explorer
- Firefox

### 5.2 Opening the RollCall Control Panel Applet

An overview of how to open the RollCall Control Panel Applet is given below. For more information about the RollCall Control Panel Applet, refer to the *RollCall\_Control\_Panel\_Operation.PDF* manual.

To open the RollCall Control Panel Applet:

1. Open a new Web Browser window and enter the IP address of the gateway (e.g. <http://172.19.39.30>). An **IQ Modular Chassis Configuration** home page will be displayed.

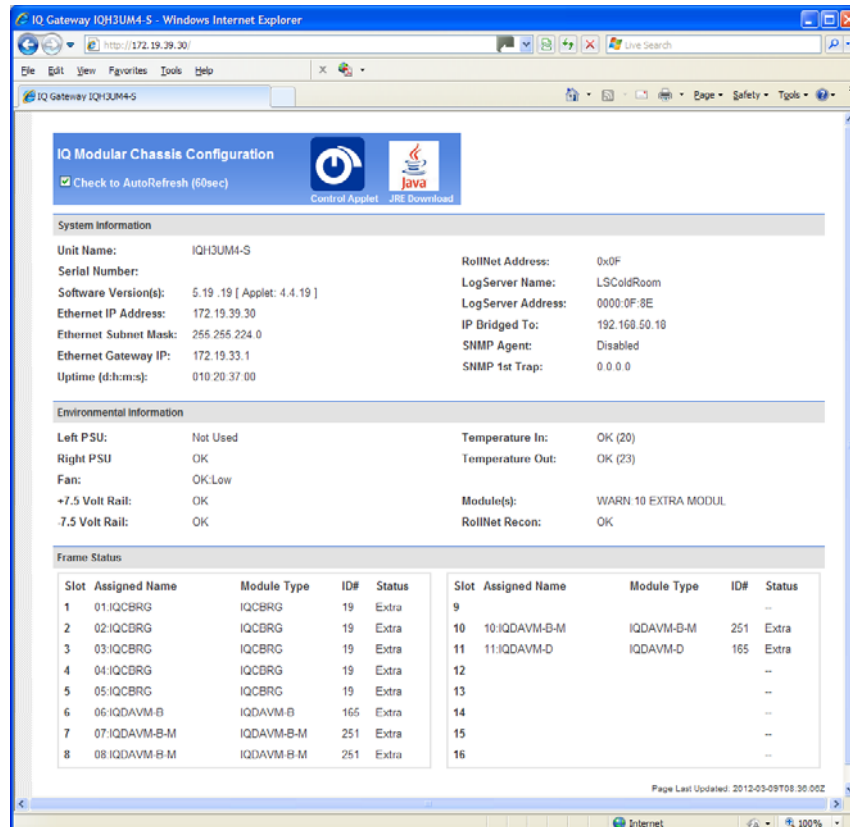

- Click the **Control Applet** icon at the top of the home page.

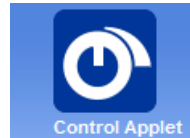

- A **Java** screen and a **Warning - Safety** dialog will be displayed.

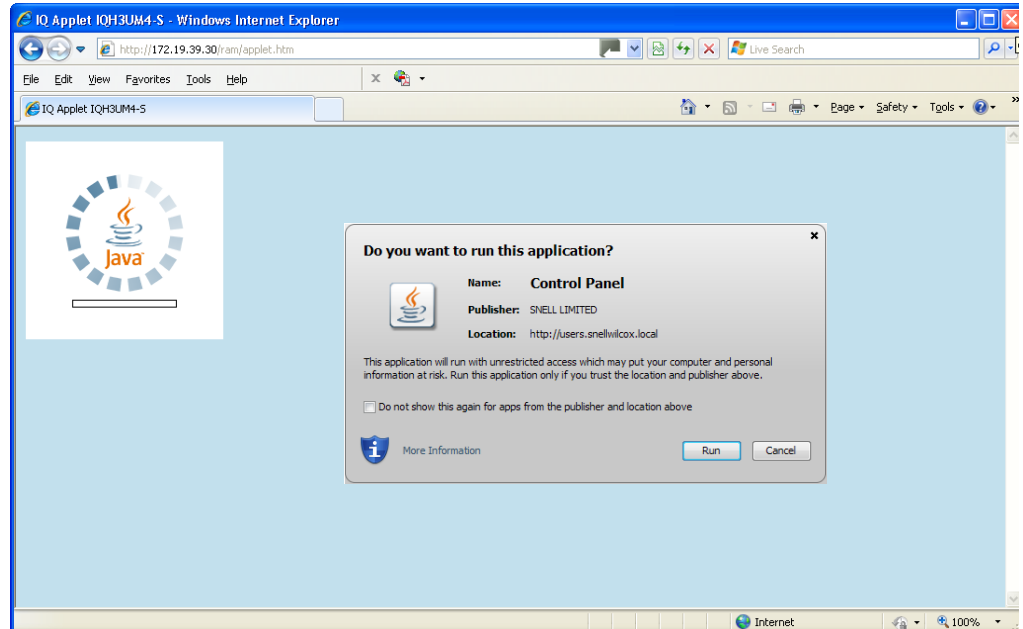

- In the **Warning - Security** dialog, place a check mark in the **Always trust Content from this publisher** check box, and click the **Run** button.
- The RollCall Control Panel applet will be downloaded. This will take a few moments to display. The list of available chassis, units and modules is displayed in the Network Browser Area on the left-hand side.

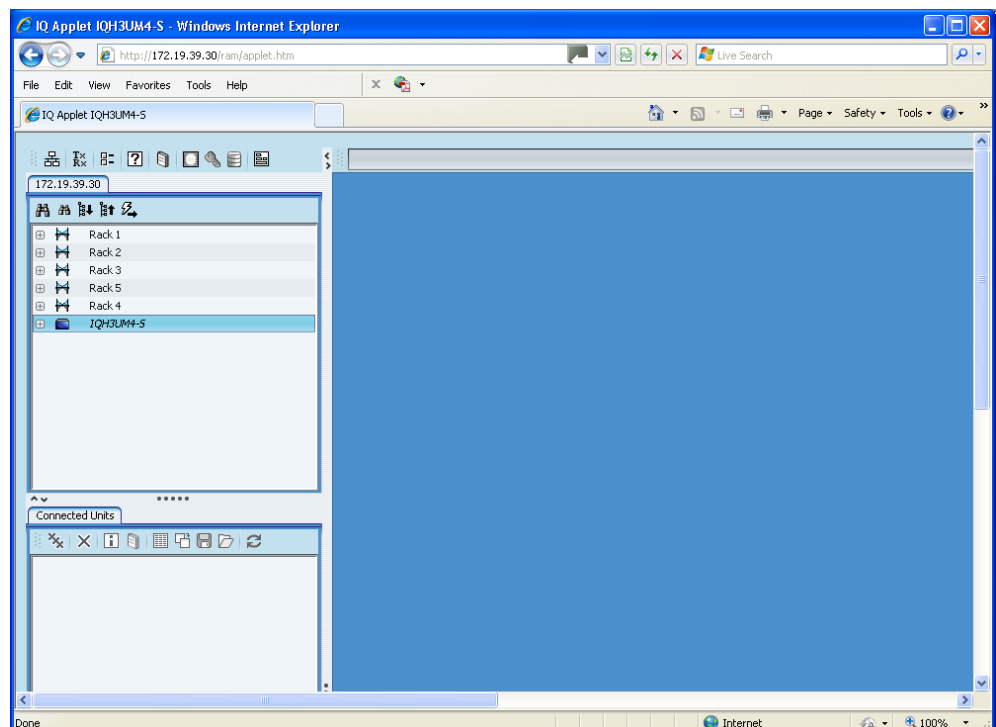

- 6. Right-click on the relevant chassis to select it and display a context menu, then select the **Connect** option to download the RollCall template screens.

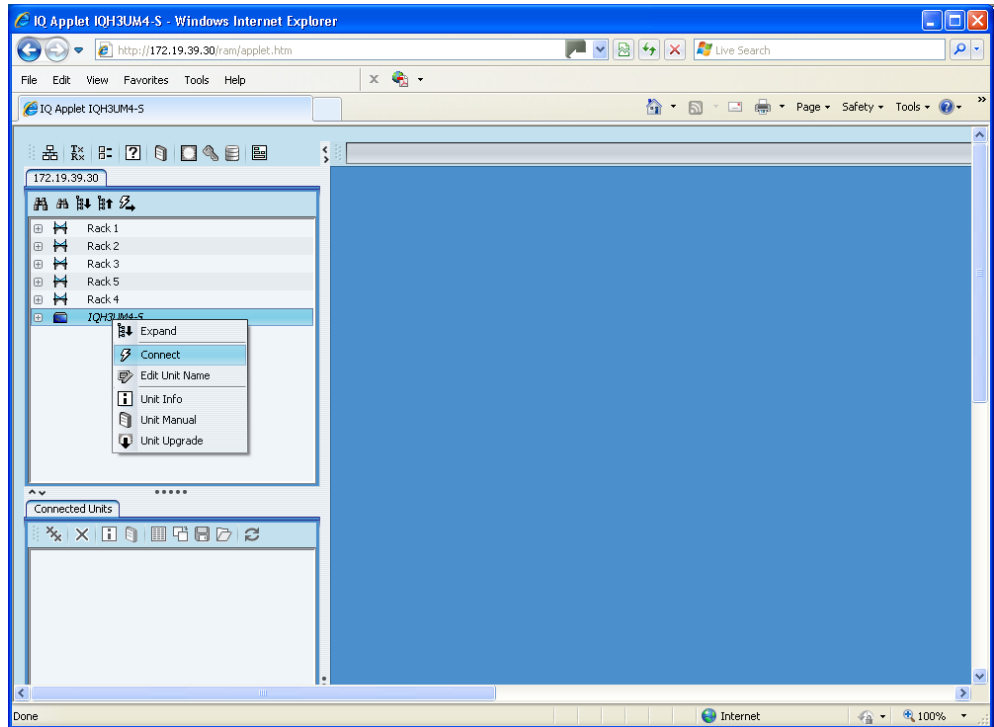

- 7. After a few moments, the screens for the selected chassis are downloaded to the RollCall Control Panel window and the top-level **Setup** screen is displayed in the Template Display Area on the right-hand side.

