

IQMUX01/03/11/13

4/8 Channel Digital Audio Multiplexer



Table of Contents

Module Description	2	Audio Setup	26
Rear Panel Views	2	Video Delay	28
Block Diagram.....	6	VBI & HANC Blank(ing)	29
Features.....	6	Caption & Pattern	30
Technical Profile	8	GPI.....	31
INPUTS.....	10	RollTrack	33
Serial Digital Video Inputs	10	Memories	35
AES Inputs	11	Logging 1, 2, 3 and 4.....	36
Reference	12	ROLLCALL LOG FIELDS	37
GPI I/O.....	12	Setup	39
OUTPUTS.....	13	Operation from an Active Control Panel	41
Serial Digital Video Outputs	13	MAIN MENU	45
25 Way D Type Connection Details	14	Video	45
CARD EDGE INDICATORS.....	16	Freeze	46
RollCall PC Control Panel Screens.....	17	User Mem(ories).....	47
Video	17	Audio	48
ProcAmp.....	18	Video Delay	54
De-embed Pair 1-4 and 5-8.....	19	Setup.....	55
AES Input	20	ROLLCALL LOG FIELDS	65
AES Input Delay	21	IQMUX01 RollCall Commands.....	69
Audio Mix 1, 2, 3 and 4.....	22	RollTrack Audio Delay Tracking	Error! Bookmark not defined.
Audio Bus A and B/Audio Bus C and D	23	Appendix 2 HANC & Embedding	84
Audio Embed.....	24	Manual Revision Record.....	86
Audio Delay Setup.....	25		

Module Description

The IQMUX01 and IQMUX11 are 4 x AES/EBU stream multiplexers with advanced embedded audio handling. Ideal as a general digital ingest module where any digital audio source signal can be catered for, even combinations of embedded and external digital audio. All audio manipulation is at the channel-level suiting discreet surround and multi-lingual use. Its audio firewall capability ensures errors or interruptions in the input signal are not passed through to the output. In addition to its tracking audio delay, it also has a bulk audio delay feature. To complete the delay flexibility, it has a built-in video delay that can be used to adjust to match external audio processing delays, such as that from a Dolby E encoder. A dual SDI input allows the unit to take signals from either of two paths. This can be used for handling main and

redundant feeds, or it can be used with a composite decoder such as the IQDEC00 to provide analog and digital alternative inputs. The second input also allows split operation, with video taken from one input and embedded audio from the other.

As a further function, this module can be used to provide separate audio and video routing in an embedded SDI environment. In this way, two levels of an SDI router feed separately the video and audio to a single destination. In this case however, the normal mode of operation can be supplemented by a small AES router allowing a few destinations at a time to have a mix capability between multiple audio sources.

Rear Panel Views

IQMUX0315-1A, IQMUX1315-1A

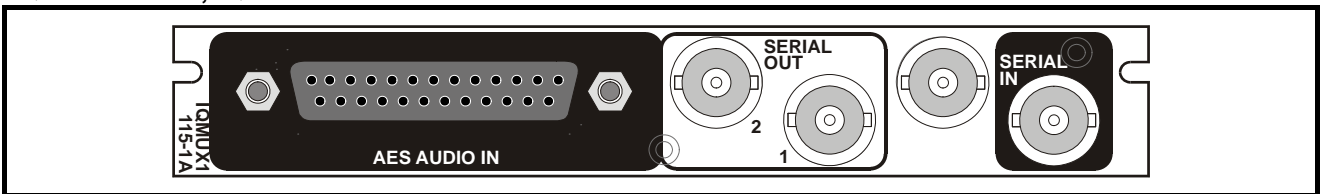

IQMUX0001-1A

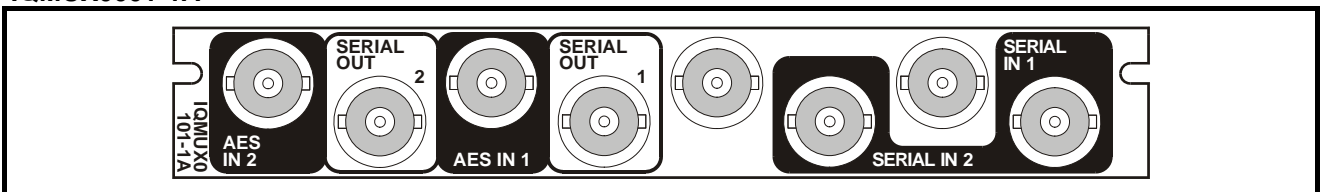

IQMUX0103-2A

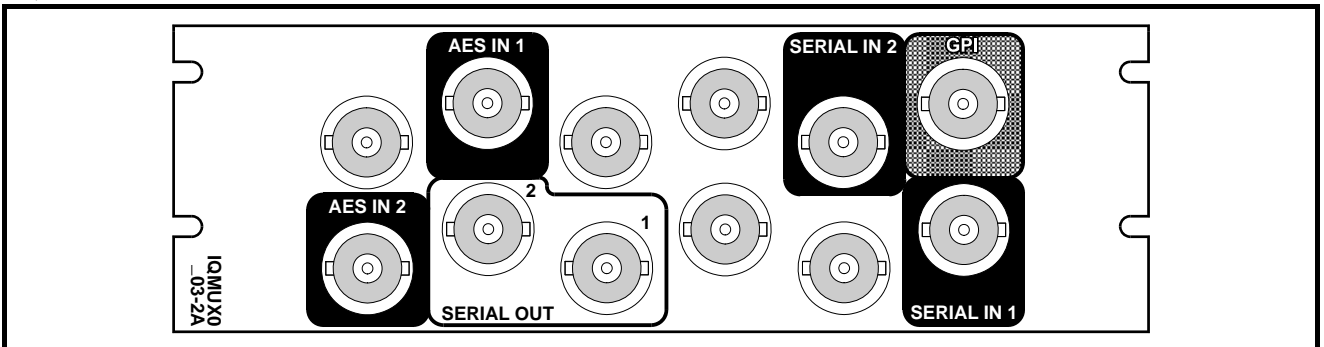

IQMUX1106-2A

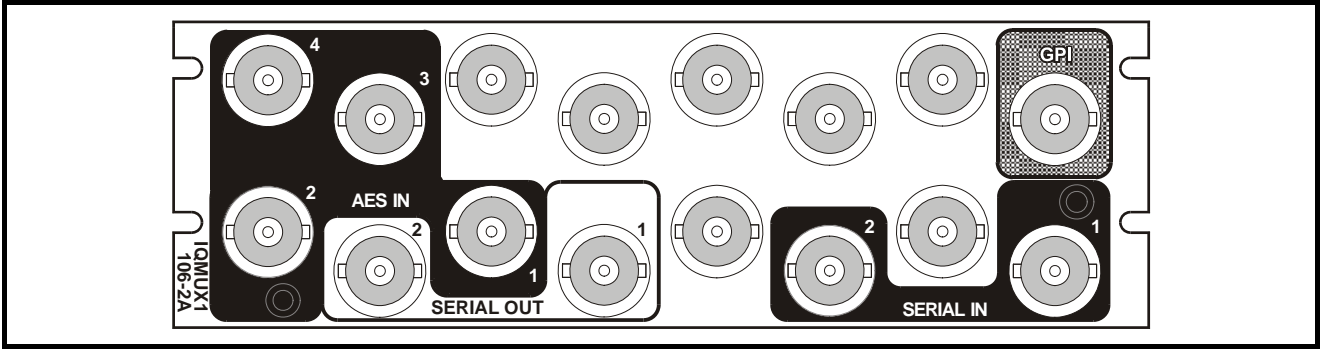

IQMUX0317-2A, IQMUX1317-2A

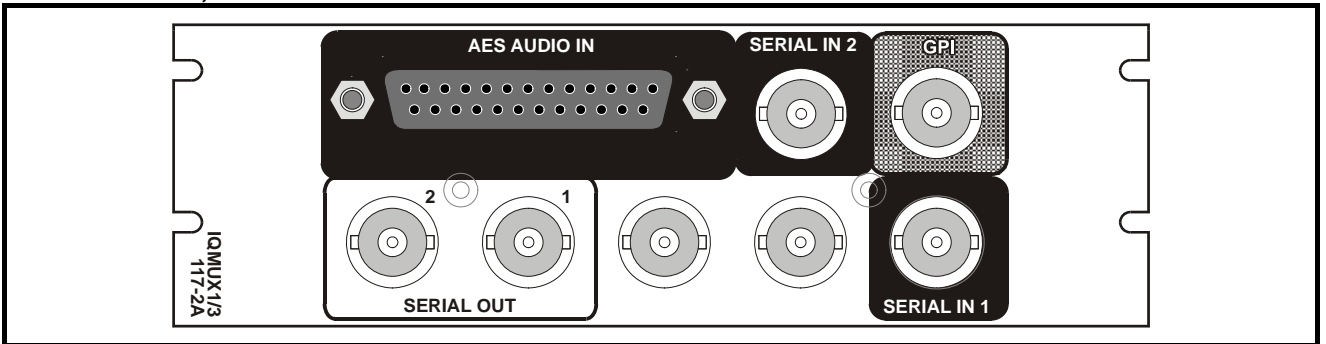

IQMUX0316-2, IQMUX1316-2

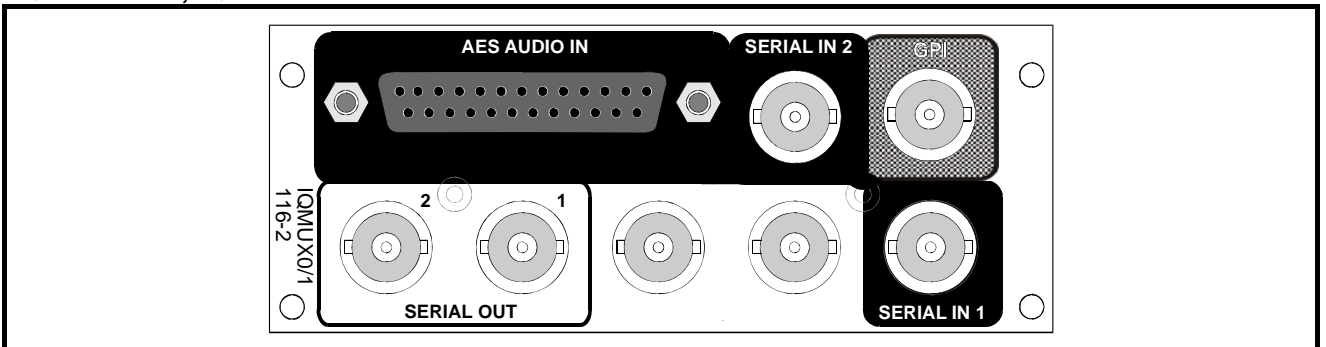

IQMUX0102-2

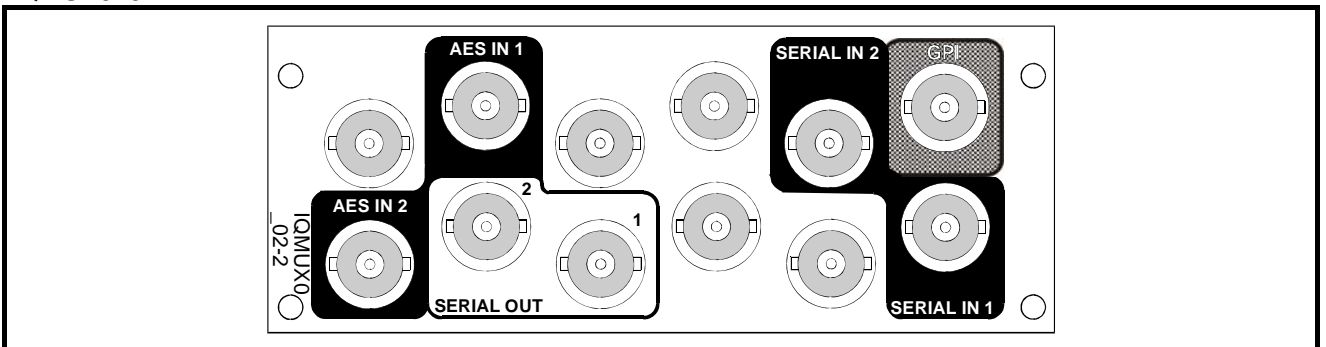

This manual covers the following products:

Order codes for IQH3A enclosures

IQMUX0315-1A SDI and 4 channel AES multiplexer with extended video delay. Balanced AES connection. 1 SDI input, 2 AES inputs, 2 SDI outputs

IQMUX1315-1A SDI and 8 channel AES multiplexer with extended video delay. Balanced AES connection. 1 SDI input, 4 AES inputs, 2 SDI outputs

IQMUX0101-1A SDI and 4 channel AES multiplexer with extended video delay. Unbalanced AES connection. 2 SDI inputs, 2 AES inputs, 2 SDI outputs

IQMUX0103-2A SDI and 4 channel AES multiplexer with extended video delay. Unbalanced AES connection. 2 SDI inputs, 2 AES inputs, 2 SDI outputs, 1 GPI

IQMUX1106-2A SDI and 8 channel AES multiplexer with extended video delay. Unbalanced AES connection. 2 SDI inputs, 4 AES inputs, 2 SDI outputs, 1 GPI

IQMUX0317-2A SDI and 4 channel AES multiplexer with extended video delay. Balanced AES connection. 2 SDI inputs, 2 AES inputs, 2 SDI outputs, 1 GPI

IQMUX1317-2A SDI and 8 channel AES multiplexer with extended video delay. Balanced AES connection. 2 SDI inputs, 4 AES inputs, 2 SDI outputs, 1 GPI

Order codes for other enclosures

IQMUX0316-2 SDI and 4 channel AES multiplexer with extended video delay. Balanced AES connection. 2 SDI inputs, 2 AES inputs, 2 SDI outputs, 1 GPI

IQMUX1316-2 SDI and 8 channel AES multiplexer with extended video delay. Balanced AES connection. 2 SDI inputs, 4 AES inputs, 2 SDI outputs, 1 GPI

IQMUX0102-2 SDI and 4 channel AES multiplexer with extended video delay. Unbalanced AES connection. 2 SDI inputs, 2 AES inputs, 2 SDI outputs, 1 GPI

Product Comparison

Product	SDI Inputs	AES Inputs		SDI Outputs	GPI	Width & Style
		Number	Type			
IQMUX0101-1A	2	2	U/B	2		Single A
IQMUX0315-1A	1	2	BAL	2		Single A
IQMUX1315-1A	1	4	BAL	2		Single A
IQMUX0103-2A	2	2	U/B	2	1	Double A
IQMUX1106-2A	2	4	U/B	2	1	Double A
IQMUX0317-2A	2	2	BAL	2	1	Double A
IQMUX1317-2A	2	4	BAL	2	1	Double A
IQMUX0317-2A	2	2	BAL	2	1	Double A
IQMUX0102-2	2	2	U/B	2	1	Double O
IQMUX0316-2	2	2	BAL	2	1	Double O
IQMUX1316-2	2	4	BAL	2	1	Double O

Note that there are two styles of rear panels available. They are not interchangeable between the two styles of enclosures. However, the cards may be fitted into any style of enclosure.

'A' Style Enclosure

Rear panels **with** the suffix A may only be fitted into the 'A' style enclosure shown below.

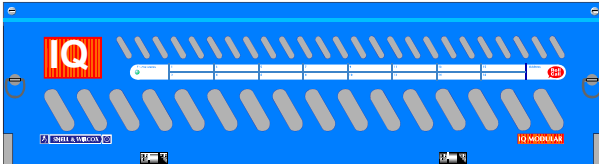

(Enclosure order codes IQH3A-E-0, IQH3A-E-P, IQH3A-0-0, IQH3A-0-P)



(Enclosure order codes IQH3A-S-0, IQH3A-S-P)

'0' Style Enclosures

Rear panels **without** the suffix A may only be fitted into the '0' style enclosures shown below.

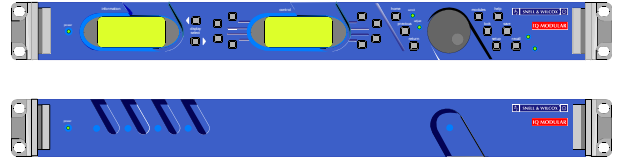

(Enclosure order codes IQH1S-RC-0, IQH1S-RC-AP, IQH1U-RC-0, IQH1U-RC-AP, Kudos Plus Products)

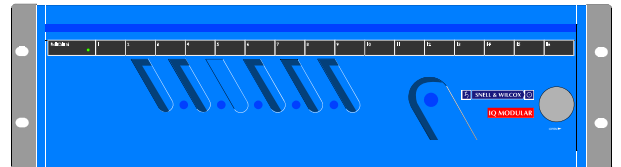

(Enclosure order codes IQH3N-0, IQH3N-P)



(Enclosure order codes IQH3U-RC-0, IQH3U-RC-P)

Block Diagram

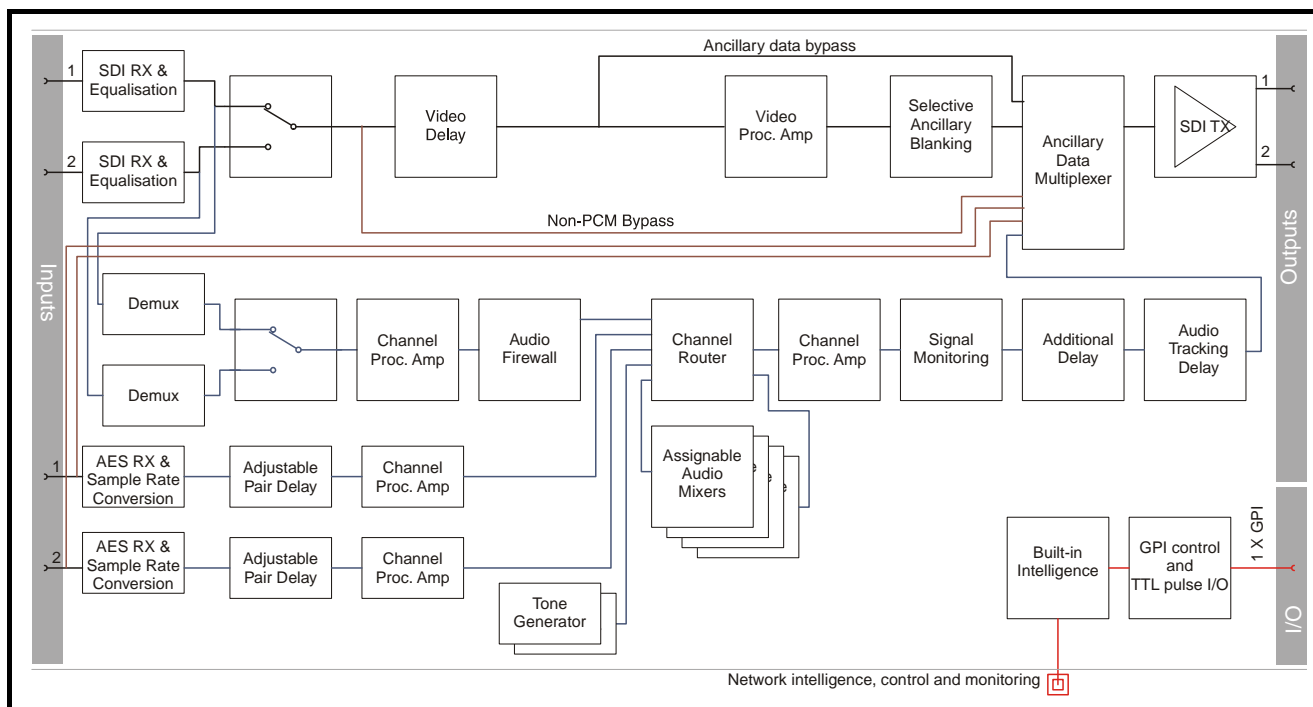

Features

- Handles 2/4 AES streams or any eight embedded input channels to total eight output channels
- Handles up to 24 bit embedded audio present on the incoming SDI stream or AES inputs, and embeds/de-embeds to 20 bits
- Combine AES and embedded source channels
- Channel-level (Sub-frame) routing
- 4 off 4 channel assignable audio mixers
- Flexible audio delay including per pair fixed delay, common fixed delay and tracking delay
- Firewall for processed PCM audio to provide a continuous output
- Variable audio delay of up to 0.5s which seamlessly tracks the video delay or external RollTrack / GPI inputs
- Video proc-amp (gain, saturation, black level)

Resolution of Audio Processing

Input Audio Format	Output Audio Format	
	SDI embedded	SDI embedded Pass-through
AES non-PCM 20	20-bit	Not applicable
AES non-PCM 24	Not supported (1)	Not applicable
AES PCM 20	20-bit	Not applicable
AES PCM 24	20-bit (2)	Not applicable
SDI embedded non-PCM 20	20-bit	20-bit
SDI embedded non-PCM 24	Not supported (1)	24-bit
SDI embedded PCM 20	20-bit	20-bit
SDI embedded PCM 24	20-bit (2)	24-bit

Notes:

1. Processing input formats that are *not supported* may produce corrupted output signals.
2. For some signals the output resolution may be less than the input resolution.

Technical Profile

Signal Inputs

Digital Video	2 x SDI (BNC) (1 x SDI – single width versions)
Unbalanced digital audio.....	2/4 x AES/EBU, AC3, Dolby E (BNC)
Balanced digital audio	2/4 x AES/EBU, AC3, Dolby E (25 Way D-Type)
Standards.....	SMPTE 259M-C-1997, SMPTE 272M-A-1994, AES3-1992

Card Edge Controls

NONE

Card Edge Indicators

SDI Input Loss	Loss = Off, Good = Green
SDI Input Error	Yellow = Unused input not at current operating standard
AES Input Present	1 x LED per pair
CPU running / Power	One green LED, flashing = OK

RollCall Functions

Audio Controls

Audio extraction select.....	SDI input 1/2/Follow Video Control
Set headroom	4 to 24 dB in 1 dB steps
Set audio detector thresholds	High and low levels, time delay
External input audio delay...	Up to 1.5 s additional delay in 1 ms steps
Input side control proc. - audio gain and polarity	Independent Gain, Mute, Polarity control over de-embedded and input channels. +18 dB to -18 dB in 0.1 dB steps.
Channel routing	Output channels routed from AES pairs 1 to 4, test tone and silence, SDI 8 embedded channels from any group
Output side control proc. - gain and polarity	Independent Gain, Mute, & Polarity control over embedded output channels. +18 dB to -18 dB in 0.1 dB steps.
Global delay offset	up to +1.5 s in 1 ms steps, common to all processed audio.
Variable audio delay control source	Up to 0.5 s from RollTrack + GPI

Signal Outputs

Digital Video	SDI x 2
Standards.....	SMPTE 259M-C-1997, SMPTE 272M-A-1994

Control Interface

GPI	1x Closing contact I/O interface (BNC)
-----------	--

Tone frequency, amplitude & Ident

2-channel tone generator. 100 Hz to 10 kHz in 100 Hz steps.

Tone Setup:

Frequency	100 Hz to 10 kHz in 100 Hz steps
Channel Ident.....	0.5 s interruption every 2 s

Video Controls

Select primary input	1/2
Black Level.....	± 100 mV in 0.8 mV steps
Y/C Timing	± 592 ns in 148 ns steps
Picture position	± 592 ns in 148 ns steps
Luminance Gain	± 6 dB
Chrominance Gain	± 6 dB
Video Horizontal Delay.....	+1 Line in 37 ns steps
Video Vertical Delay.....	+1 Frame in 1 line steps
Video Delay Frames.....	0 to +2 frames

Other Controls

Pass vertical data.....	On/Off (lines selectable 7/11 to 23/22 & 320/274 to 335/284)
Preset Unit	Returns all settings to default
Pattern Select.....	100%/75% Bars, Multiburst, Black, Animated Bars
User Memories.....	Name, clear, save and read 8 user memories
Default Video Output.....	pattern / freeze/ run through
Default Audio Output.....	Silence
Caption Output	On/Off (default and pattern output only)
Caption Generator.....	Programmable up to 19 characters
GPI/O set-up	May be attached to any memory function/polarity

Reporting (* also Logged)

EDH (for selected input).....*Presence, *Error-Time, *Error-Seconds
 No SDI*No input present
 Input ancillary errorANC error, ANC error-seconds
 Input error.....Unused input not at current operating standard
 Report Embedded Audio Data
 Report audio data pairs on input and output SDI
 Audio Silence, High Level, Low Level, Overflow
 For processed audio channels only

RollTrack Input

DelayAudio delay – Fixed, RollTrack + fixed

RollTrack Output

DelayCurrent video/audio delay
 Input stateSelected Input: Input Present, Input Missing, Standard 525, Standard 625
 Input 1: Input Present, Input Missing, Standard 525, Standard 625
 Input 2: Input Present, Input Missing, Standard 525, Standard 625
 GPI 1 Low, High, Inactive
 Embedded Audio state.....De-embed 1-8 Lost/Present
 External AES Audio state....1-2 Lost/present

Specifications

Video Internal Processing ...4:2:2 with 10 bit data paths
 Serial Input Return LossBetter than 15 dB to 270 MHz
 Maximum Input Cable length
 > 200 m (PSF1/2 or equiv. cable)
 Serial Output Level800 mV \pm 5%
 Output Overshoot.....< 70 mV
 Output Return LossBetter than 15 dB to 270 MHz
 Output Jitter.....< 0.2 UI (with 10 Hz High pass filter selected on 601 monitor)
 Minimum Delay6 μ s
 Delay (Delay Mode)6 μ s - 3 Frames + 5.5 μ s
 THD+N< -117 dB @ 700 Hz (24 bits) AES to AES

Digital Audio Input (Balanced)

Connector/Format25 W D
 Sample Frequency25 – 96 kHz (48 kHz for Reference)

Input Cable Length.....>150 m of AES3 cable
 Impedance110 Ohms

Digital Audio Input (Unbalanced)

Connector/FormatBNC
 Sample Frequency25 – 96 kHz (48 kHz for Reference)
 Input Cable Length.....>500 m of RG59 cable
 Impedance75 Ohms
 Output Sampling48 kHz frame locked to 48 kHz AES/EBU Reference in AES lock mode

Power Consumption

Module Power Consumption 7.5 W max

INPUTS

Serial Digital Video Inputs

Serial digital inputs are made to the unit via BNC connectors which terminate in 75 Ohms.

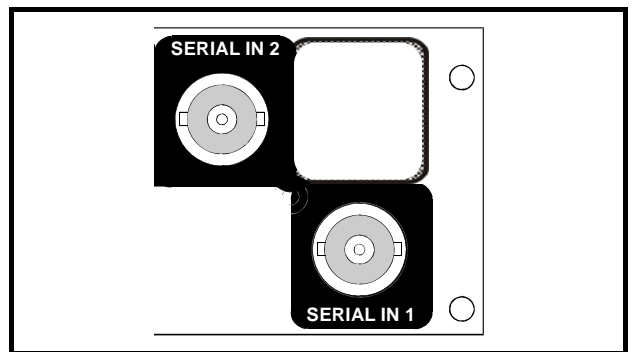
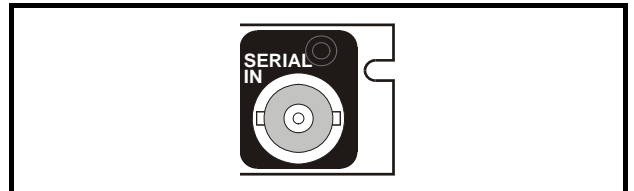
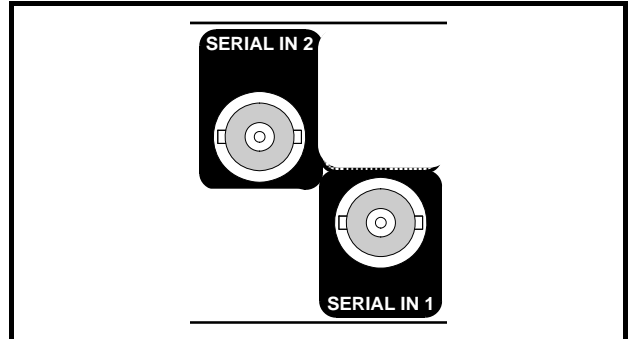
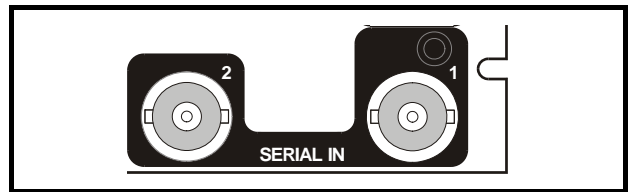

AES Inputs

Unbalanced AES inputs are made to the unit via BNC connectors which terminate in 75 Ohms.

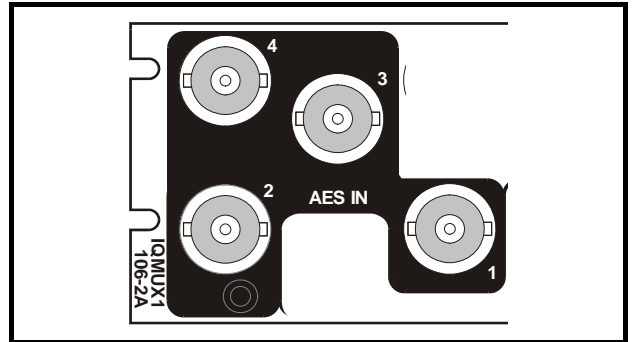
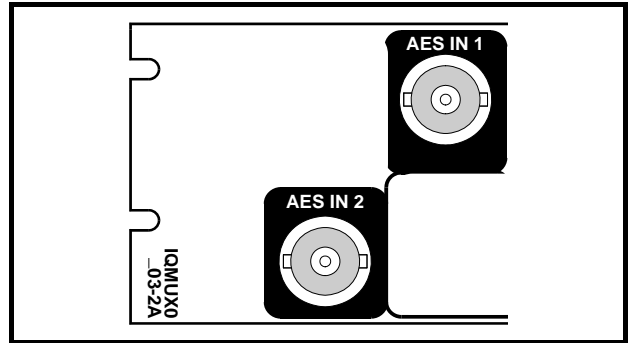

Balanced AES inputs are made to the unit via a 25 way D Type connector.

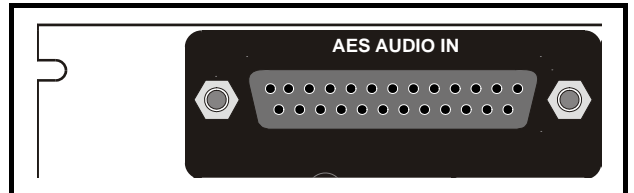
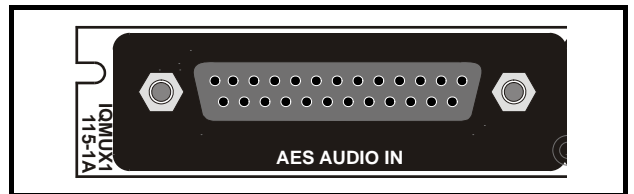

Reference

These connectors have no function on these modules.

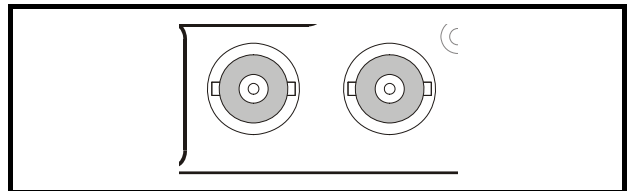
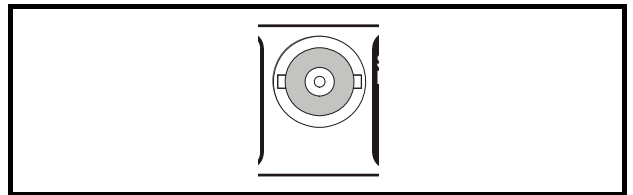
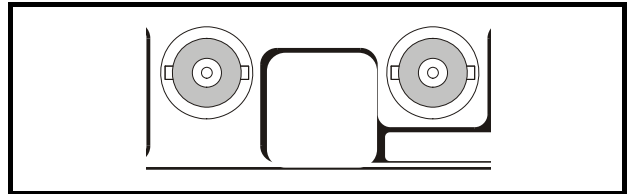
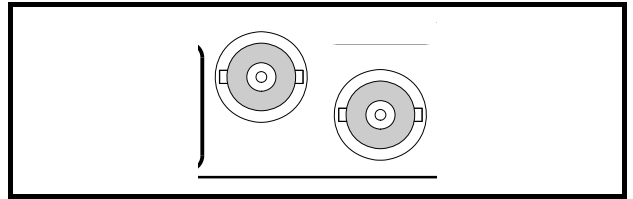

GPI I/O

(Not on IQMUX0101-1A, IQMUX0315-1A, IQMUX1315-1A)

This connector is used for accepting GPI information (from mechanical switch contacts, relay contacts etc.) The resulting action that the unit takes may be programmed via RollCall.

It may also be configured as an output.

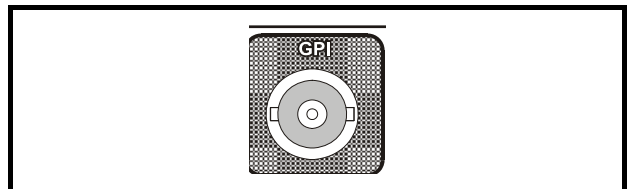

OUTPUTS

Serial Digital Video Outputs

These are the Serial Digital outputs of the unit via BNC connectors for 75 Ohms.

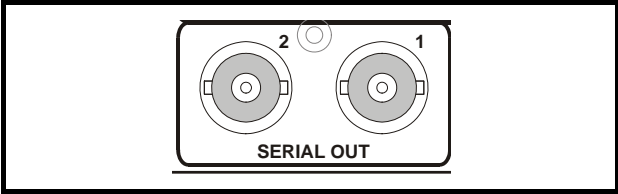
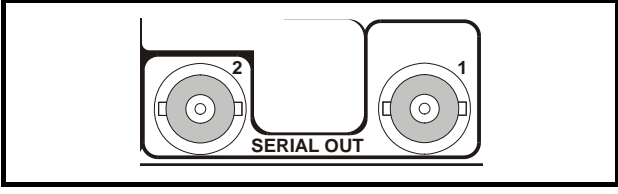
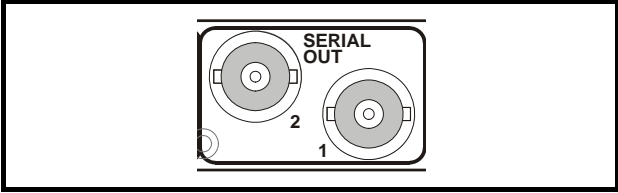
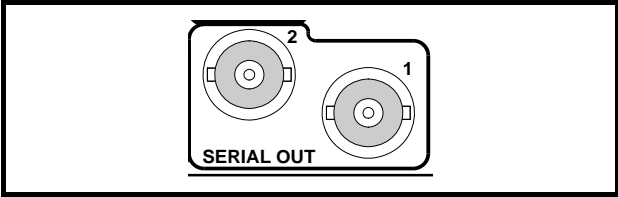

25 Way D Type Connection Details

25 Way D Connector Pin Number	AES Inputs	Standard Pin Assignment
1		CHASSIS
14	AES IN 1 Ground	GND1
2	AES IN 1 +	1+
15	AES IN 1 -	1-
3	AES IN 2 +	2+
16	AES IN 2 -	2-
4	AES IN 2 Ground	GND2
17	AES IN 3 Ground	GND3
5	AES IN 3 +	3+
18	AES IN 3 -	3-
6	AES IN 4 +	4+
19	AES IN 4 -	4-
7	AES IN 4 Ground	GND4
20		GND5
8		5+
21		5-
9		6+
22		6-
10		GND6
23		GND7
11		7+
24		7-
12		8+
25		8-
13		GND8

Example of Connection Details to XLR Connectors

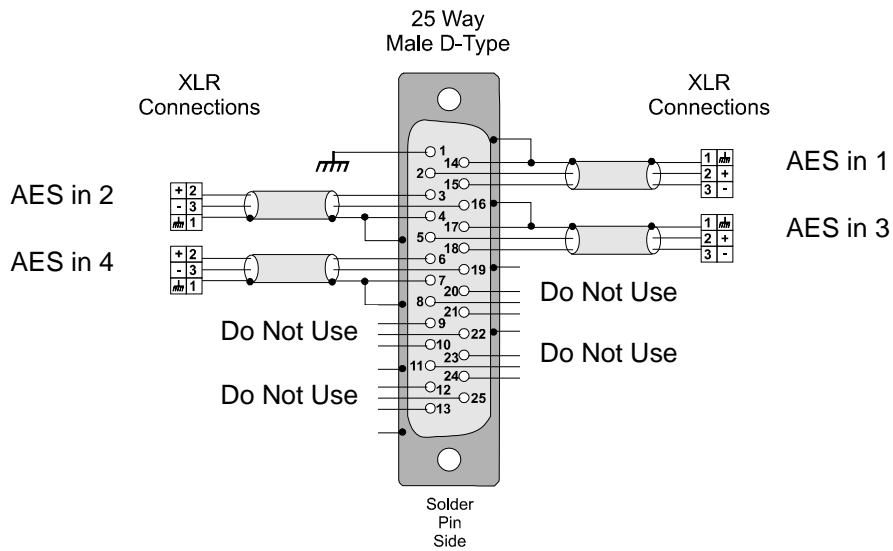
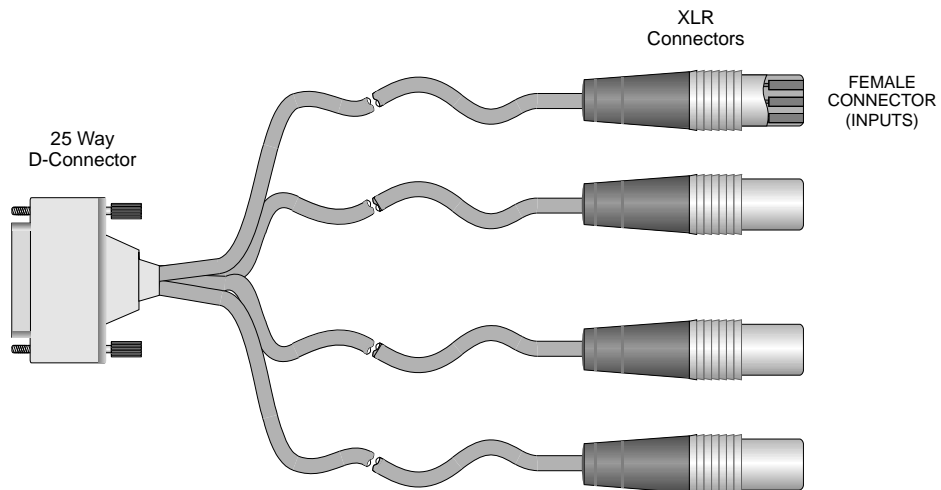

CARD EDGE INDICATORS

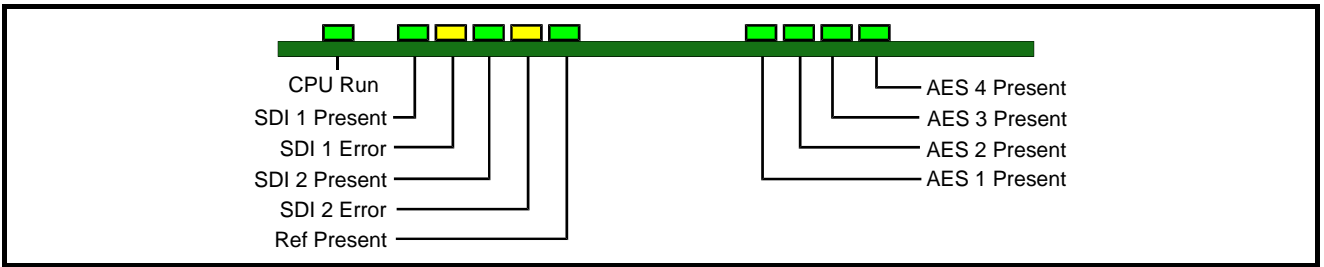

Note that only the LED's associated with the particular version of the product will be active.

CPU Run (Green)

This LED will flash to indicate that the CPU is running.

SDI 1 Present (Green)

When illuminated this indicates that there is a valid signal at SDI 1 input.

SDI 1 Error (Yellow)

When illuminated this indicates that SDI 1 input is not at the current operating standard.

SDI 2 Present (Green)

When illuminated this indicates that there is a valid signal at SDI 2 input.

SDI 2 Error (Yellow)

When illuminated this indicates that SDI 2 input is not at the current operating standard.

Ref Present (Green)

This has no function on this unit.

AES 1, 2, 3 and 4 Present (Green)

When illuminated this will indicate that associated AES input pair is present.

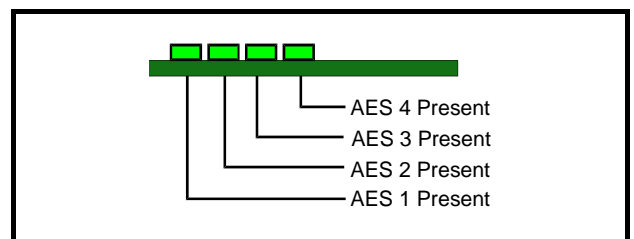
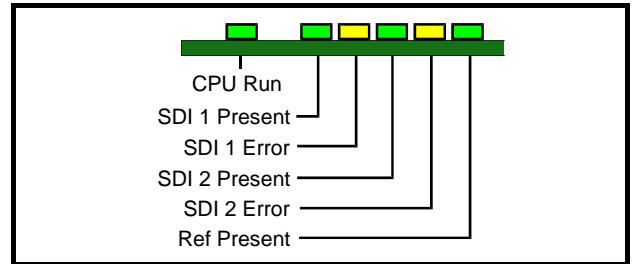

RollCall PC Control Panel Screens

Video

Input Select

This allows either **Input 1** or **Input 2** to be selected for processing.

Note that as the IQMUX0315-1A and IQMUX1315-1A have only one input, Input 1 should always be selected. If Input 2 is selected the unit will report an input loss.

Input Standard

This allows **input standard** to be selected.

If only 625 is selected the unit will be forced to only accept 625 line inputs.

If only 525 is selected the unit will be forced to only accept 525 line inputs.

If 625 and 525 are selected the unit will accept both 625 and 525 line inputs.

Note that normally the unit will lock to the selected SDI input; if this is lost or is not present, the unit will automatically lock to the AES signal on AES Input 1, if available.

DeEmbed Select

Either **Input 1 SDI** or **Input 2 SDI** may be selected for DeEmbedding. If **Follow Video** is checked the signal selected via the **Input Select** item will be DeEmbedded.

Non-PCM groups can be transparently passed but if a non-PCM group is selected for mixing or routing it will be automatically muted.

If a Dolby header is detected in the data stream it will be processed as a non-PCM signal.

Freeze

When checked the output picture will become a frozen frame.

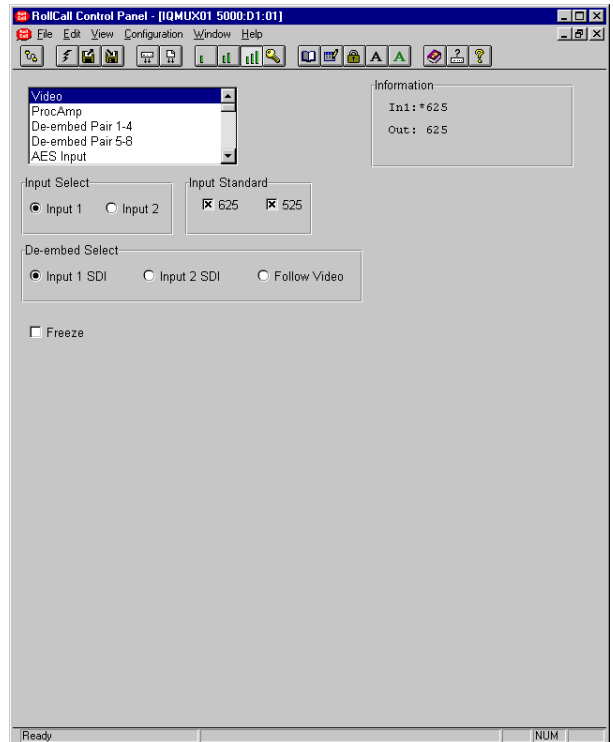





ProcAmp

These items allow signal levels and timings to be adjusted.

Separate adjustments may be made for the two input channels **Input 1 SDI** and **Input 2 SDI**.

Note that for this and other screens the following applies to the scroll bars:

The   and   symbols at the ends of the scroll bar allow the value to be adjusted in discrete steps.

The numerical value will be shown next to the scroll bars and selecting Preset  will return the setting to the calibrated value for that item.

Input 1 SDI and Input 2 SDI Controls

These items allow the gain, black level and timing of both signals to be adjusted.

ProcAmp Enable

When checked the ProcAmp will become enabled for that channel and the settings will be applied to the signal.

When unchecked the settings will revert to the preset values.

Luma Gain

This allows the Y (luminance) gain to be adjusted by ± 6 dB in steps of 0.1 dB. Preset value is 0.0 dB.

Black Level

This allows the black level to be adjusted by ± 100 mV in 0.8 mV steps. Preset value is 0.

C Gain

This allows the Cb/Cr (color difference) gain to be adjusted by ± 6 dB in steps of 0.1 dB. Preset value is 0.0 dB.

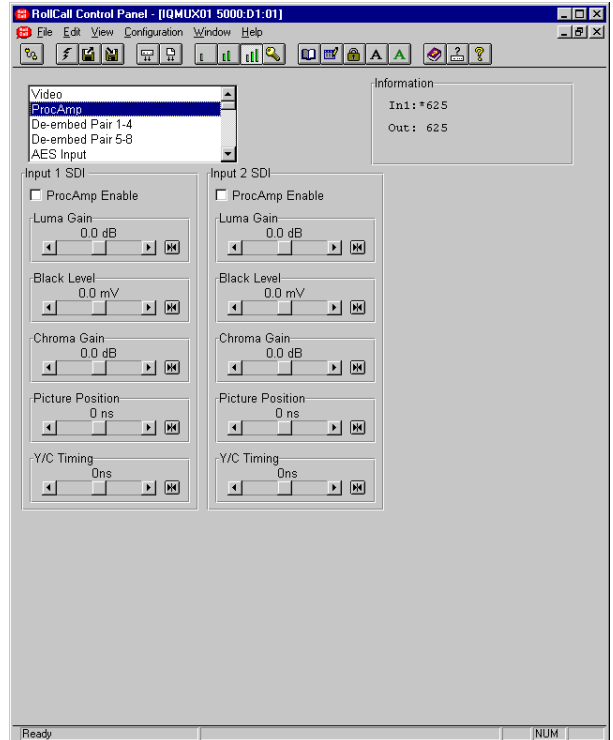

Picture Position

This item allows the timing of the picture position relative to the normal value, to be adjusted. The timing may be adjusted by ± 592 ns in 148 ns steps.

Y/C Timing

This item allows the timing of the chrominance signal relative to the luminance signal to be adjusted, (i.e. Y to Cb/Cr timing) in nanoseconds. The timing may be adjusted by ± 592 ns in 148 ns steps.

De-embed Pair 1-4 and 5-8

This allows control of Gain, Mute, and Polarity over the de-embedded channel pairs.

L and R

These scrollbars allow the gain of the Left and Right channels to be adjusted over a range of ± 18 dB in 0.1dB steps. Preset is to 0 dB.

Invert

When checked the signal polarity will be inverted.

Mute

When checked the signal will be muted.

Stereo

When checked the left and right channels will be configured as a stereo pair and any adjustments made to one channel will automatically be applied to both channels.

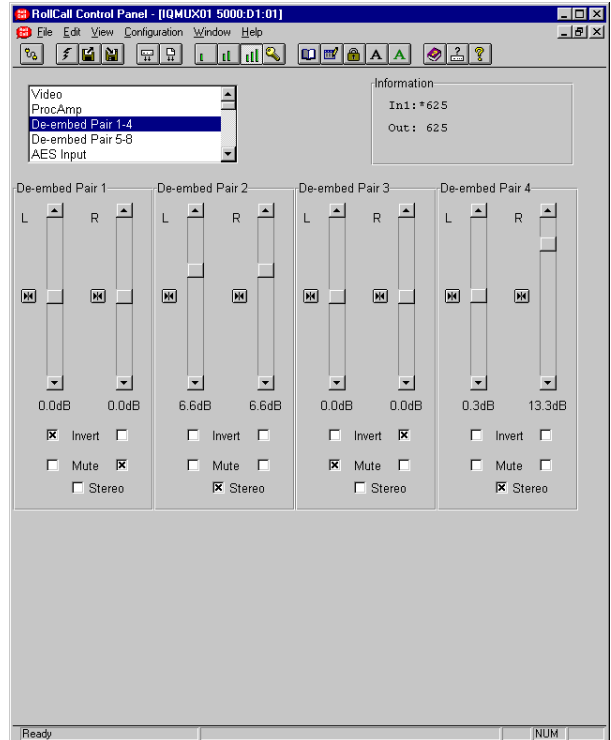

AES Input

This allows control of Gain, Mute, and Polarity over the AES channels.

L and R

These scrollbars allow the gain of the Left and Right channels to be adjusted over a range of ± 18 dB in 0.1dB steps. Preset is to 0 dB.

Invert

When checked the signal polarity will be inverted.

Mute

When checked the signal will be muted.

Stereo

When checked the left and right channels will be configured as a stereo pair and any adjustments made to one channel will automatically be applied to both channels.

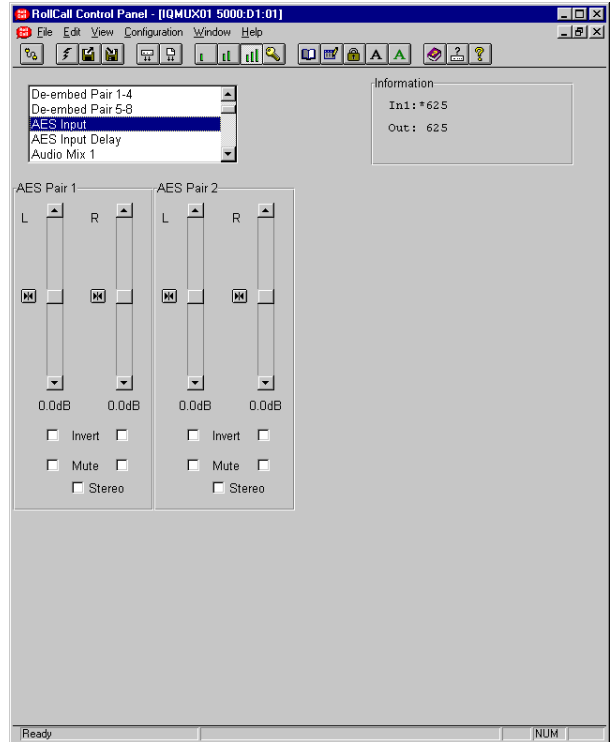

AES Input Delay

This allows the AES inputs to be delayed.

AES Input 1 Delay and AES Input 2 Delay

These scrollbars allow the delay to be adjusted be from 0 to 1500 ms in steps of 1 ms. Preset is to 0 ms.

*Note that this delay will not be included in the RollTrack audio delay or in the Total Delay measurement displayed on the **Audio Delay Setup** screen.*

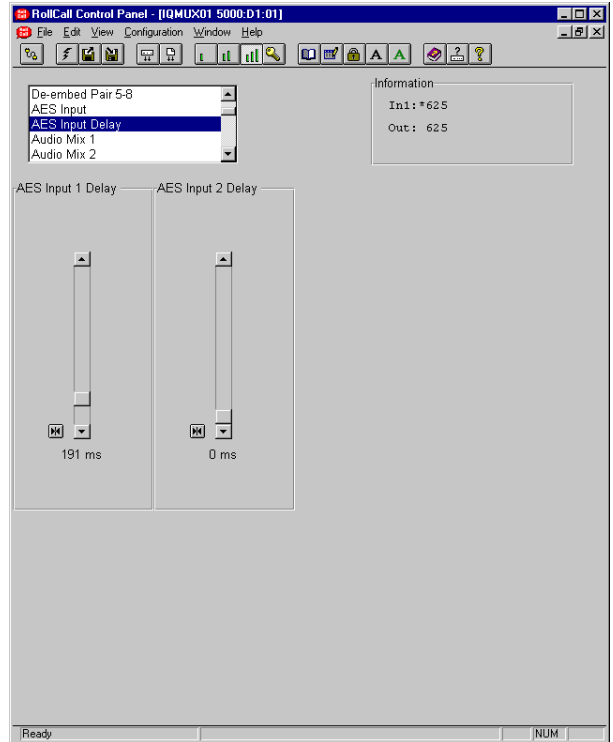

Audio Mix 1, 2, 3 and 4

There are four separate audio mixers Mix 1, 2, 3 and 4.

Each mixer has four inputs with individual gain controls that allow the mixing levels for each of the input signals, to be adjusted. The range of adjustment is from 0 to -90 dB and to Off. 0 to -60 dB is in steps of 1 dB, -60 dB to -90 dB is in steps of 3 dB.

The inputs can be selected from the list in the Source 1, 2, 3 and 4 items.

The outputs of these mixers provide four extra input selections for the Channel Router.

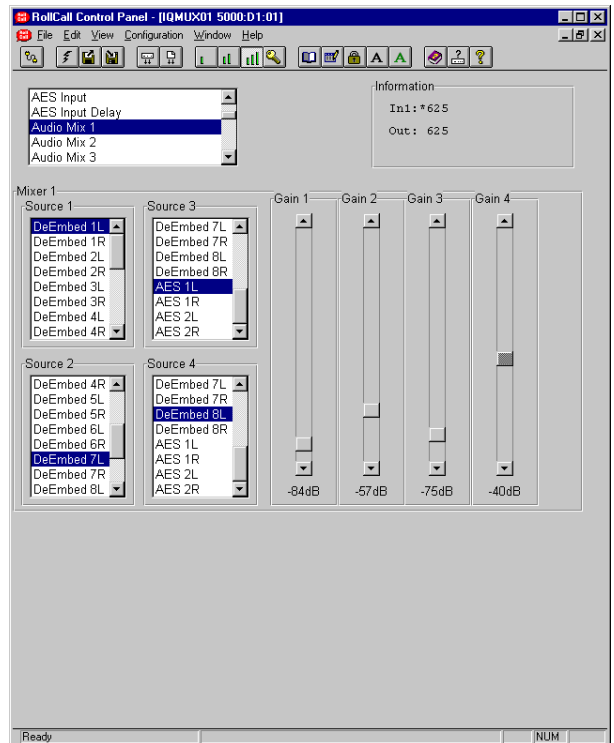

Audio Bus A and B/Audio Bus C and D

This function allows the inputs for the four audio buses of the router to be selected.

For each bus any source may be selected from the list for the left and right channels.

L and R

These scrollbars allow the gain to be adjusted over a range of ± 18 dB in 0.1dB steps. Preset is to 0 dB.

Invert

When checked the signal polarity will be inverted.

Mute

When checked the signal will be muted.

Stereo

When checked the left and right channels will be configured as a stereo pair and any adjustments made to one channel will automatically be applied to both channels.

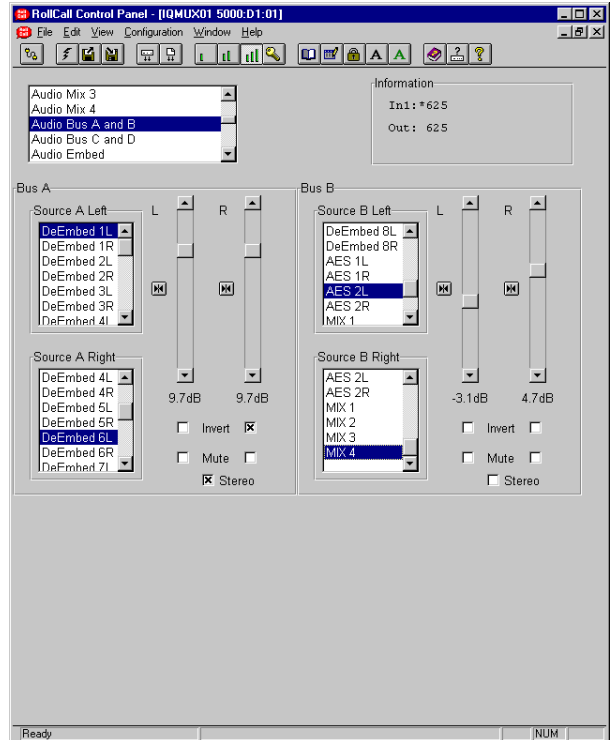

Audio Embed

This function sets up the embedder sources and destinations. Higher number embedders have priority, so if the same destination pair is selected on two embedders, the highest embedder will be the one that is active.

Embedder 1, 2, 3, and 4

The source of the signal for the embedder may be selected from the list.

Destination 1, 2, 3, and 4

The destination for the embedded signal may be selected from the list.

Disable 1, 2, 3 and 4

When checked the embedding will be turned off.

For details of the Audio Embedding Packet Distribution please refer to Appendix 2 on page 84.

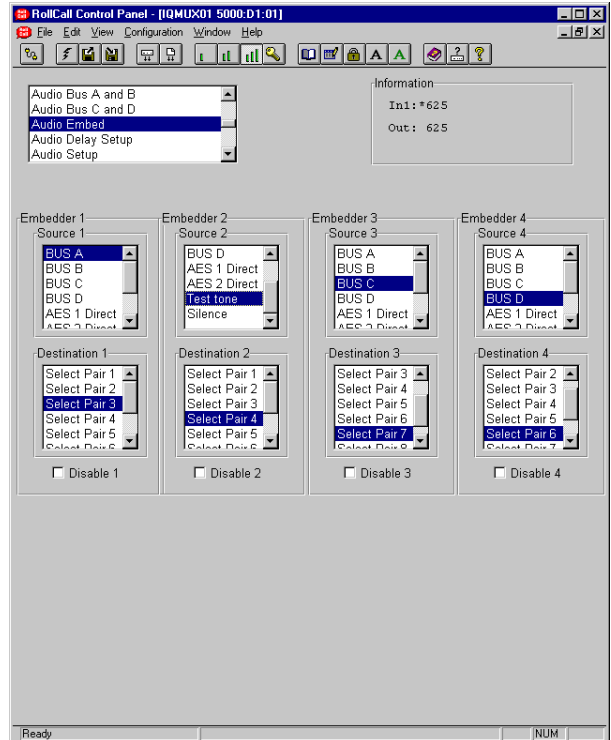

Audio Delay Setup

This screen allows the amount of delay to be set and type of audio delay mechanism to be selected.

Manual Delay

This will affect all processed audio signals equally.

The delay may be set to up to +1.5 s in 1ms steps.

Delay Select

This allows the type of audio delay mechanism to be selected. One or more of the types may be checked. The amount of delay applied will be the sum of the delay from the enabled delay mechanisms.

*Note that up to 0.5 s of delay may be applied from the sum of the **Internal** + **GPI** + **RollTrack** delay inputs.*

Internal

When checked, an audio delay equal to the video delay in the unit will be applied.

Manual

When checked an audio delay set by the **Manual Delay** control will be applied.

GPI

When checked an audio delay will be applied that is equal to the width of the pulse arriving at the GPI connector.

Note that an audio delay pulse of more than 500 ms, applied to the GPI Input will be treated as invalid. This will result in the GPI delay returning to zero.

Note that the GPI must be configured correctly for this function to operate. Please see page 31 for details.

RollTrack 14, 15, 16 and 17

Then selected source(s) of the RollTrack input signal(s) will apply an audio delay.

Total Delay

This will show the audio total delay (due to all selected delay mechanisms) through the unit in ms.

*Note that this delay figure does not include the individual pair delay times for **AES input 1** and **AES input 2** as their values may differ.*

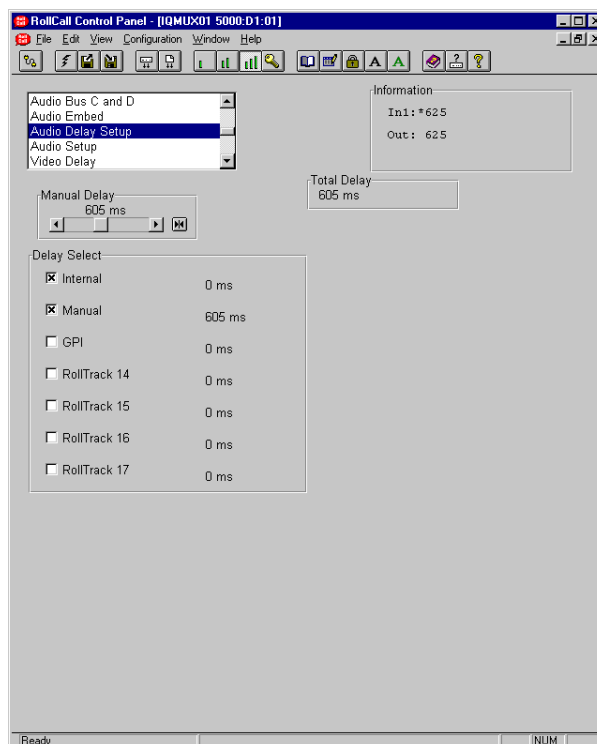

Audio Setup

Audio Monitoring

The four audio buses are monitored and level detectors provide status information and logging data.

Silence

The level at which the signal is considered to have dropped to silence may be set with this control.

The range is from -80 dB to 0 dB in steps of 1 dB. Preset is to -70 dB.

Low Level

The level at which the signal is considered to have dropped to a Low Level may be set with this control.

The range is from -80 dB to 0 dB in steps of 1 dB. Preset is to -60 dB.

High Level

The level at which the signal is considered to have risen to a High Level may be set with this control.

The range is from -80 dB to 0 dB in steps of 1 dB. Preset is to -10 dB.

Overload

The level at which the signal is considered to have risen to an Overload condition may be set with this control.

The range is from -80 dB to 0 dB in steps of 1 dB. Preset is to 0 dB.

Warning Timer

All the above monitoring facilities will only operate after a time interval set by this control. A valid signal is reported immediately.

The range is from 1 to 20 seconds. Preset is to 10 seconds.

Audio Tone

The frequency of the Audio Test Tone may be set using this control. Left and right channels may be set independently.

Frequency L and R

The range is from 100 Hz to 15 kHz in steps of 100 Hz. Preset is to 400 Hz.

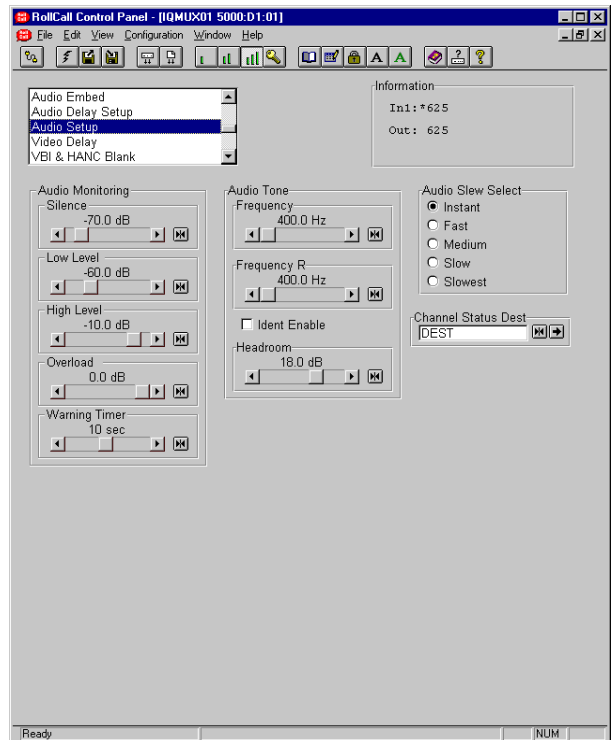

Audio Setup (continued)

Ident Enable

When enabled the right channel will be identified by the signal being muted for 0.5 second every 2.5 seconds.

Headroom

This allows the headroom to be set. The range is from 4 dB to 24dB in 1 dB steps. Preset is to 18 dB.

Note that in this product headroom is defined as:

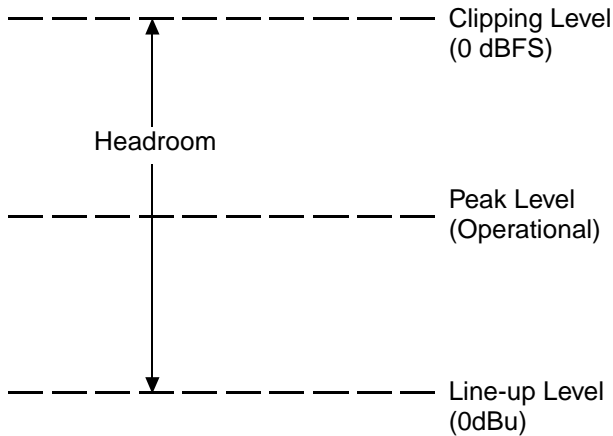

Headroom = Clipping Level – Line-up level

Audio Slew Select

This is the time taken for the audio to slew when the audio mixing and routing controls have changed.

The options are:

- Instant....The response is immediate
- Slowest..Change takes approximately one second
- Slow ..Change takes 75% of Slowest time
- Medium..Change takes 50% of Slowest time
- Fast.....Change takes 25% of Slowest time

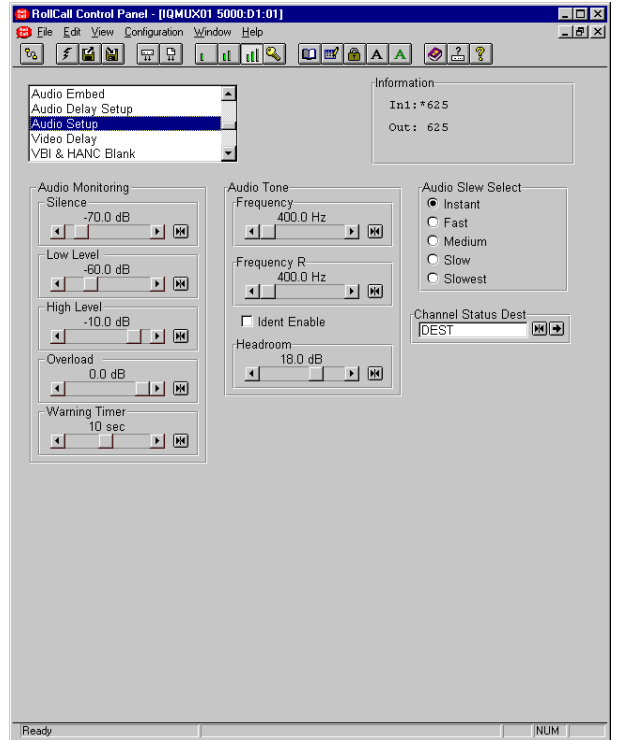

Channel Status Dest(ination)

This will set the four character name used in the destination field of the audio channel status.

To change the text, type the new text in the text area and then select (return).

Selecting Preset will return the text to the default text (DEST).

Note that the Channel Status Origin data is automatically set by the module to MUX1 and cannot be changed.

Video Delay

H(orizontal) Delay (625/525)

This item allows the horizontal timing of the output signal relative to the input signal to be adjusted by up to 1 line in 37 ns steps. The scrollbar will adjust this value.

Selecting Preset returns the setting to the minimum horizontal delay.

V(ertical) Delay (625/525)

This item allows the vertical timing of the output signal relative to the input signal to be adjusted, in TV lines. The scrollbar will adjust this value. Range is from 0 to 624 or 524 lines in 1 line steps.

Selecting Preset returns the setting to the minimum vertical delay.

Video Delay Frames

The number of frames that the output signal will appear after the input signal may be set with this item.

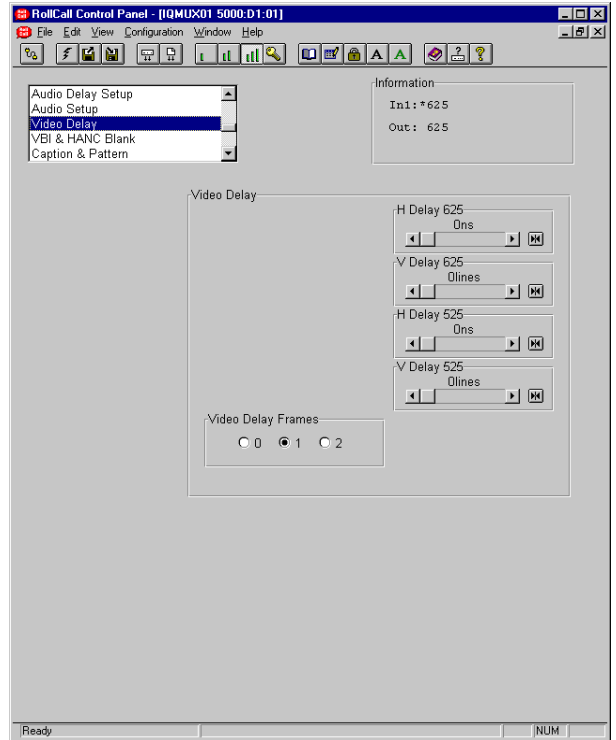

VBI & HANC Blank(ing)

This item allows the Vertical Interval data (all or specific lines) contained in the input signal to be blanked or passed through the module.

It allows the selection of which vertical interval lines to pass through to the output and which lines to blank.

525 Pass

This section allows lines 11 to 22 and lines 274 to 284 of 525 line signals to be selected and passed through to the output by checking the appropriate box.

625 Pass

This section allows lines 7 to 23 and lines 320 to 335 of 625 line signals to be selected and passed through to the output by checking the appropriate box.

All

This section allows all vertical interval lines to be selected and either passed to or blanked from the output signal.

Pass 525

Selecting this item will select all vertical interval lines in the 525 line list and allow them to passed through to the output.

Pass 625

Selecting this item will select all vertical interval lines in the 625 line list and allow them to passed through to the output.

Blank 525

Selecting this item will select all vertical interval lines in the 525 line list and blank them from the output.

Blank 625

Selecting this item will select all vertical interval lines in the 625 line list and blank them from the output.

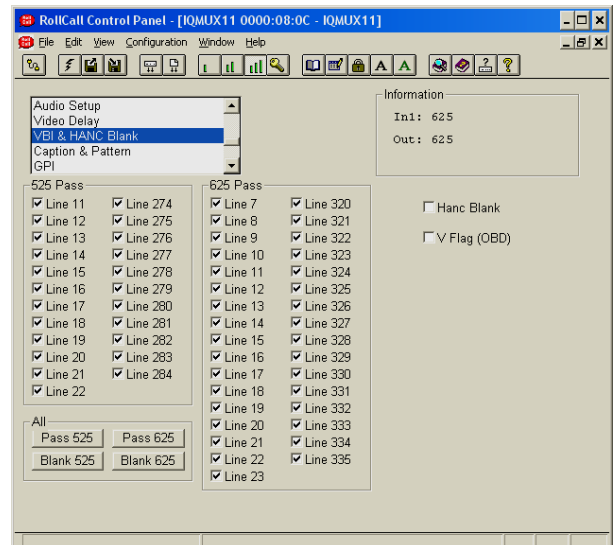

Hanc Blank

When checked all horizontal data will be blanked, on the input. When unselected, passthrough operations will not alter audio packets for groups that the IQMUX01 has not selected for embedding. In order to allow minimum synchronization delay the created packets are output first and then the passthrough groups are placed after the created streams have been embedded. This means that passthrough is achieved without altering the input packet distribution. Passthrough operation has to take note of marked for deletion packets and these are removed where possible to ensure that one does not run out of useable ancillary space.

For details of the HANC Data Handling please refer to Appendix 2 on page 84.

V Flag (OBD)

This control allows the V(ertical) Flag to be changed from line 10 (OVD, Optional Video Data) to line 20 (OBD, Optional Blanking Data).

Unchecked selects OVD and checked selects OBD. The default is OVD selected.

Note that this function is only active for 525 line signals.

Caption & Pattern

This function will allow a caption to be edited and selected and various patterns to be used as the output signal when the Pattern On function is selected.

Caption

This function allows control of the caption (white text on a black background) which may contain a maximum of 19 characters (including spaces).

The caption will appear in the lower section of the picture.

Edit caption

To change the caption, type the new text in the text area and then select  (return).

Selecting Preset  will return the text to the default text (IQMUX01).

Select Caption

- Caption Off The caption will not appear on the screen
- Caption On The caption will appear on screen

Pattern

- Pattern On

When selected the output will become the pattern selected from the **Pattern Select** list.

Pattern Select

One of the patterns (including Black) may be selected from the list.

Animated Pattern

When selected, a monochrome rectangular area will appear on the output picture as shown opposite. The brightness of this rectangle will ramp from black, through gray to white and then directly to black over a period of about one second. This action will then be repeated continuously.

This pattern is useful for checking active video paths. Down stream equipment can see that video has not been frozen.

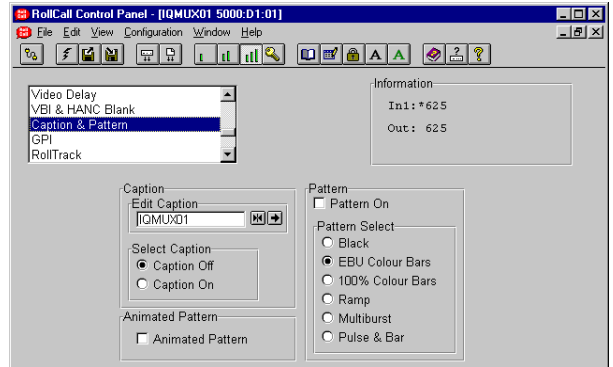

Caption Text



Animated Pattern

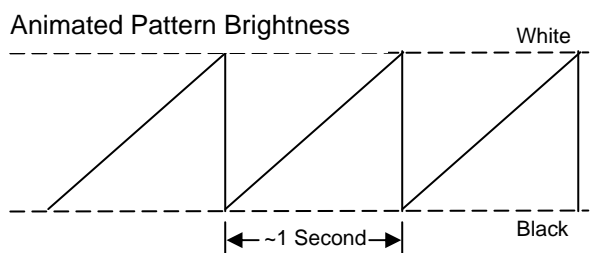

GPI

This screen allows the GPI functions to be configured and their actions defined.

Disable Inputs

When selected all GPI input functions will be disabled.

Input Functions

When configured as an input the GPI connection may be used for accepting GPI information (from mechanical switch contacts, relay contacts etc.) The resulting action that the unit takes may be selected using this item.

The GPI input functions that may be selected are as follows:

- | | |
|---------------|--|
| Unused | The unit will perform no function. This is also the Preset Setting. |
| Pattern | The unit will produce a pattern chosen from the Pattern menu when the input changes from open to closed. |
| Memory 1 to 8 | The unit will use the settings in the selected memory location when the input changes from open to closed. |
| Mem1-2 | The unit will toggle between the settings of memory locations 1 and 2.
Open to Closed = Memory 1 settings
Closed to Open = Memory 2 settings |
| Mem 3-4 | The unit will toggle between the settings of memory locations 3 and 4.
Open to Closed = Memory 3 settings
Closed to Open = Memory 4 settings |
| Mem 5-6 | The unit will toggle between the settings of memory locations 5 and 6.
Open to Closed = Memory 5 settings
Closed to Open = Memory 6 settings |
| Mem 7-8 | The unit will toggle between the settings of memory locations 7 and 8.
Open to Closed = Memory 7 settings
Closed to Open = Memory 8 settings |

GPI In Status

This will display the current status of the selected GPI input.

This may show either High or Low. When low, the associated function will be triggered.

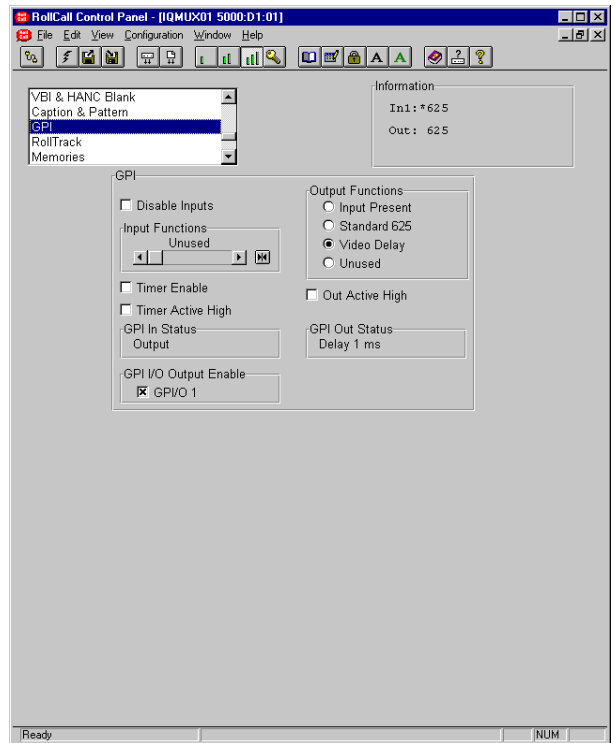

GPI (continued)

Output Functions

The GPO may be configured to produce an output corresponding to one of the following conditions:

- Input Present
- Standard 625
- Video Delay
- Unused

The preset setting for the output is to Unused.

When the condition is not true the output will float but when the condition is true the output is closed to ground via a transistor.

Note that when video delay mode is selected the output is a negative going TTL pulse. The width of the pulse represents the video delay through the unit to the nearest millisecond.

GPI Out Status

This will display the current status of the GPI output. This may show either Unused, High, low or video delay in milliseconds.

Timer Enable

When checked the GPI will be monitored. The width of the pulse represents the delay that can be used to control audio delays in this unit.

Note that an audio delay pulse of more than 500 ms, applied to the GPI Input will be treated as invalid. This will result in the GPI delay returning to zero.

Timer Active High

When checked the GPI will measure the positive going pulse. When unchecked the negative pulse is measured.

Out Active High

This determines the sense of the asserted GPI output signal. When checked the GPI is active the output sense is high. When unchecked the GPI is active low.

GPI I/O Output Enable

When checked the GPI is configured as an output. When unchecked the GPI is configured as input.

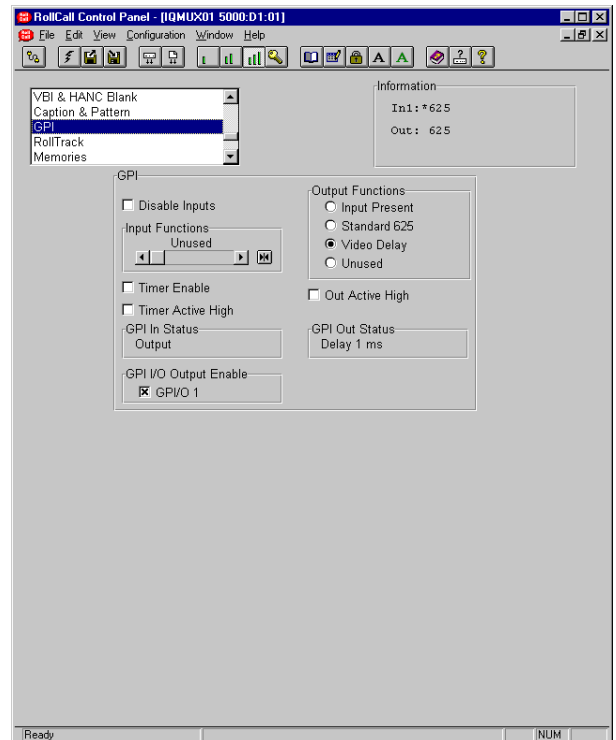

RollTrack

This function allows information to be sent, via the RollCall™ network, to other compatible units connected on the same network.

For example, it can enable compatible audio delay units to produce an audio delay dependent on this and other similar units. The audio delay unit will dynamically follow or track the received delay-time information. This allows processed video signals to be timed correctly with audio signals. This automatic tracking system via the RollCall™ network is called **RollTrack**.

For more detailed information, see the *RollTrack* section (Appendix) at the end of this manual.

RollTrack Index

This item allows up to 70 destinations to be selected.

RollTrack Source

This allows the source of information that triggers the transmission of data to be selected. Options are:

Unused (off)	De-embed 1 Lost
Input Present	De-embed 1 PCM
Input Missing	De-embed 1 NPCM
Standard 525	to
Standard 625	De-embed 8 Lost
Input 1 Present	De-embed 8 PCM
Input 1 Missing	De-embed 8 NPCM
Standard 1 525	AES 1 Lost
Standard 1 625	AES 1 PCM
Input 2 Present	AES 1 NPCM
Input 2 Missing	to
Standard 2 525	AES 4 Lost
Standard 2 625	AES 4 PCM
Audio Delay	AES 4 NPCM
Video Delay	GPI 1 Low
	GPI 1 High
	GPI 1 Inactive

Note that the GPI RollTrack functions should not be used when **GPI Timer Enable** is selected.

The destination for the information is set by the network code address as follows:

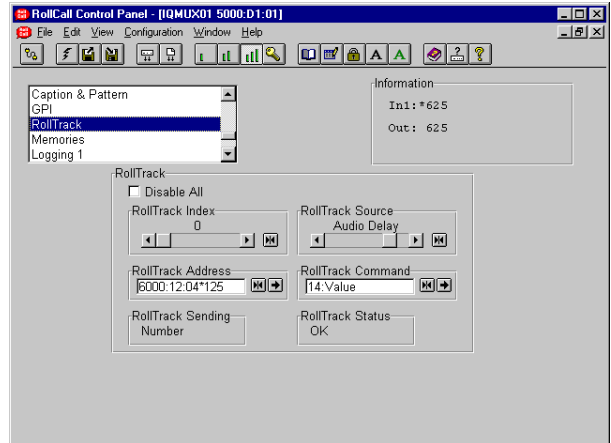

Network Address

This item allows the address of the selected destination unit to be set.

To change the address, type the new destination in the text area and then select  (return)



(Preset) returns to the default destination

The full **RollTrack** address has four sets of numbers

For example: 0000:10:01*362

The first set (0000) is the network segment code number

The second set (10) is the number identifying the (enclosure/mainframe) unit.

The third set (01) is the slot number in the unit

The Fourth Set (362)

Each RollCall unit has a unique identification embedded in the units' software. In this example 362 represents an IQDMX00, 412 would represent an IQDEC00, 161 a Mach 1 etc. Inserting this number in the RollTrack address ensures that only the correct type of unit (in this example an IQDMX00) will respond to the RollTrack command; any other unit will ignore the command.

If this number were set to 00 **any type** of unit at this location would respond to the RollTrack command, possibly causing unpredictable results.

The unit ID of a module on the RollCall network may be found under *RollCall Control Panel/RollCall Listing/Unit Information* or via the *RollCall Control Panel Help/About Current Unit* function.

RollTrack (continued)

RollTrack Command

The full **RollTrack** command has two sets of numbers

For example: 84*156

The first set (84) is the **RollTrack** command number

Note that only command numbers 14, 15, 16 and 17 should be used for audio delay

The second set (156) is the value sent with the **RollTrack** command number

For details of the RollCall command values for specific units please contact your local Snell & Wilcox agent.

Disable All

When this item is checked all RollTrack items will be disabled.

RollTrack Sending

This item shows when the unit is actively sending the RollTrack command.

This may show:

String	A string value is always being sent.
Number	A number value is always being sent.
No	The message is not being sent.
Yes	The message is being sent.
Internal Type Error	Inconsistent behavior; please contact your local Snell & Wilcox agent.

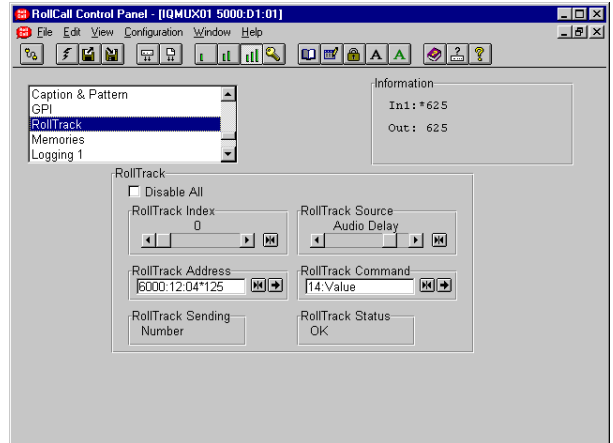

RollTrack Status

This item will show the status of the currently selected RollTrack index.

This may show:

OK	RollTrack message sent and received OK.
Unknown	Rolltrack message has been sent but it has not yet completed.
Timeout	RollTrack message sent but acknowledgement not received. This could be because the destination unit is not at the location specified.
Error	This indicates a broken RollCall state.
Bad	This indicates a broken RollCall packet.

Memories

This function allows a number of particular setups of the unit to be saved and recalled. There are 8 memory locations available.

To change the memory name, type the new name in the text area and then select  (return).

Selecting Preset  will return the text to the default name.

Clear

This item allows the memory location to be cleared and returned to the default (preset) setting. This empties the memory location and the Recall button will then appear grayed out.

Save

This function allows the settings of all items to be saved at the memory location.

Recall

This function allows the settings saved at the memory location to be recalled. When this button appears grayed out it indicates that the memory location is empty and therefore cannot be recalled. This will occur when the memory is cleared.

Note that all the above functions are a momentary action.

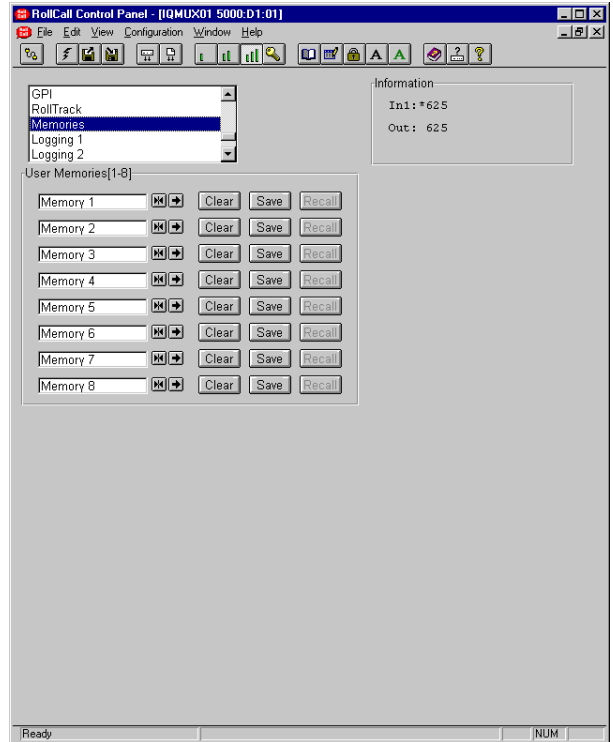

Logging 1, 2, 3 and 4

Information about various parameters can be made available to a logging device that is attached to the RollCall™ network by checking the appropriate box.

The status is shown to the right of the item.

Any of the items may be selected from the list.

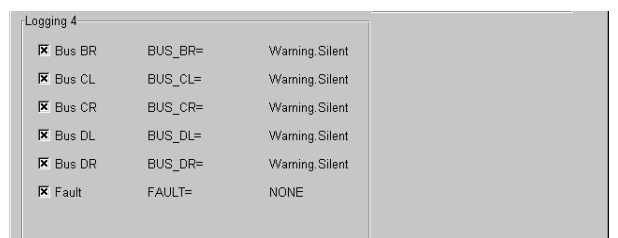
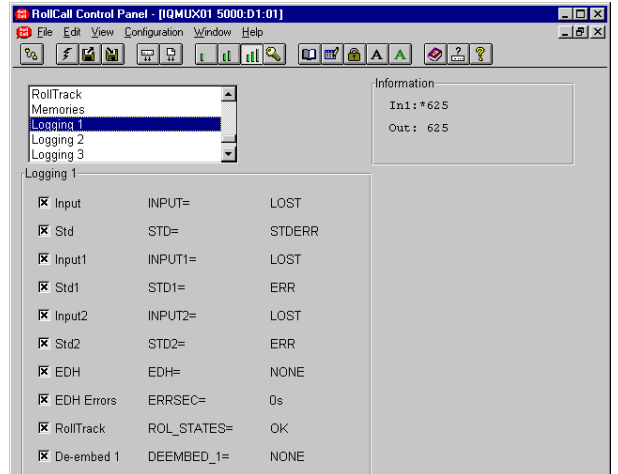

ROLLCALL LOG FIELDS

(where applicable)

**Note that these log values are either for future use or may be logged during a transitional state whilst acquiring or loosing an input signal. It is very unlikely that these states and the associated log values will become permanent.*

Log Field	Log Value	Description
INPUT=	OK ERR* LOST	Valid input signal Invalid input signal Input signal lost
STD=	UNKNOWN* STDERR 525 625	Input signal standard not recognized or no signal Not a selected input standard Input standard 525 Input standard 625
INPUT1=	OK ERR* LOST	Valid input signal Invalid input signal Input signal lost
STD1=	ERR 525 625	Not a selected input standard Input standard 525 Input standard 625
INPUT2=	OK ERR* LOST	Valid input signal Invalid input signal Input signal lost
STD2=	ERR 525 625	Not a selected input standard Input standard 525 Input standard 625
EDH=	NONE FAIL OK RESET	The unit is not locked to the input signal EDH errors have been found on the input signal No EDH errors found on the input signal EDH statistics have been reset
ERRSEC=	Runtime string	The time since EDH was reset in seconds
ROL_STATES=	OK FAIL	RollTrack message sent and received OK RollTrack message not acknowledged
DEEMBED_1=	NONE OK	Nothing present on pair 1 Embedded pair 1 present on selected SDI input
DEEMBED_2=	NONE OK	Nothing present on pair 2 Embedded pair 2 present on selected SDI input
DEEMBED_3=	NONE OK	Nothing present on pair 3 Embedded pair 3 present on selected SDI input
DEEMBED_4=	NONE OK	Nothing present on pair 4 Embedded pair 4 present on selected SDI input
DEEMBED_5=	NONE OK	Nothing present on pair 5 Embedded pair 5 present on selected SDI input
DEEMBED_6=	NONE OK	Nothing present on pair 6 Embedded pair 6 present on selected SDI input
DEEMBED_7=	NONE OK	Nothing present on pair 7 Embedded pair 7 present on selected SDI input
DEEMBED_8=	NONE OK	Nothing present on pair 8 Embedded pair 8 present on selected SDI input
NPCM_1=	NONE OK	Non-PCM not present on pair 1 of selected SDI input Non-PCM present on pair 1 of selected SDI input
NPCM_2=	NONE OK	Non-PCM not present on pair 2 of selected SDI input Non-PCM present on pair 2 of selected SDI input
NPCM_3=	NONE	Non-PCM not present on pair 3 of selected SDI input

Log Field	Log Value	Description
	OK	Non-PCM present on pair 3 of selected SDI input
NPCM_4=	NONE OK	Non-PCM not present on pair 4 of selected SDI input Non-PCM present on pair 4 of selected SDI input
NPCM_5=	NONE OK	Non-PCM not present on pair 5 of selected SDI input Non-PCM present on pair 5 of selected SDI input
NPCM_6=	NONE OK	Non-PCM not present on pair 6 of selected SDI input Non-PCM present on pair 6 of selected SDI input
NPCM_7=	NONE OK	Non-PCM not present on pair 7 of selected SDI input Non-PCM present on pair 7 of selected SDI input
NPCM_8=	NONE OK	Non-PCM not present on pair 8 of selected SDI input Non-PCM present on pair 8 of selected SDI input
AES_1=	NONPCM OK LOST	Non-PCM signal present on AES input 1 Valid signal present on AES input 1 Signal not present at AES input 1
AES_2=	NONPCM OK LOST	Non-PCM signal present on AES input 2 Valid signal present on AES input 2 Signal not present at AES input 2
AES_3=	NONPCM OK LOST	Non-PCM signal present on AES input 3 Valid signal present on AES input 3 Signal not present at AES input 3
AES_4=	NONPCM OK LOST	Non-PCM signal present on AES input 4 Valid signal present on AES input 4 Signal not present at AES input 4
BUS_AL=	OK WARNING	Router BUS A Left channel has valid signal selected Router BUS A Left channel is receiving silence, low level, high level or overload signal
BUS_AR=	OK WARNING	Router BUS A Right channel has valid signal selected Router BUS A Right channel is receiving silence, low level, high level or overload signal
BUS_BL=	OK WARNING	Router BUS B Left channel has valid signal selected Router BUS B Left channel is receiving silence, low level, high level or overload signal
BUS_BR=	OK WARNING	Router BUS B Right channel has valid signal selected Router BUS B Right channel is receiving silence, low level, high level or overload signal
BUS_CL=	OK WARNING	Router BUS C Left channel has valid signal selected Router BUS C Left channel is receiving silence, low level, high level or overload signal
BUS_CR=	OK WARNING	Router BUS C Right channel has valid signal selected Router BUS C Right channel is receiving silence, low level, high level or overload signal
BUS_DL=	OK WARNING	Router BUS D Left channel has valid signal selected Router BUS D Left channel is receiving silence, low level, high level or overload signal
BUS_DR=	OK WARNING	Router BUS D Right channel has valid signal selected Router BUS D Right channel is receiving silence, low level, high level or overload signal
FAULT=	NONE FAIL	No Internal errors detected Internal error detected
SN=	Runtime string	Serial number of unit

Setup

Information Window

The type of information that appears in the Information Window may be chosen with this item.

Input Status
EDH & ANC Status
Audio Input Status

Input Status

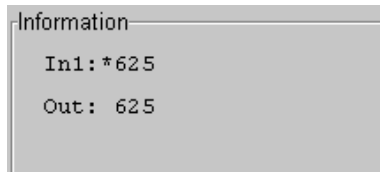

In1: or In2: This shows the status of the input, the line standard and which input has been selected.

Out: This shows the status of the output.

EDH & ANC Status

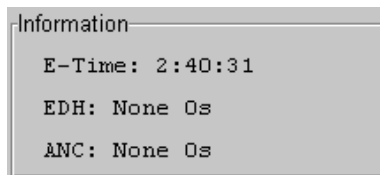

E-Time: This shows the time since EDH was reset in Hours:Minutes:Seconds.

EDH: This shows the number of EDH errors that have occurred since the last EDH reset followed by the time in seconds since the last EDH error.

ANC: This shows the number of ANC errors that have occurred since the last ANC reset followed by the time in seconds since the last ANC error.

Error Seconds Reset

Selecting this function will reset EDH and ANC error count and the timer shown in the information window, to zero. If inputs are switched over an automatic reset occurs.

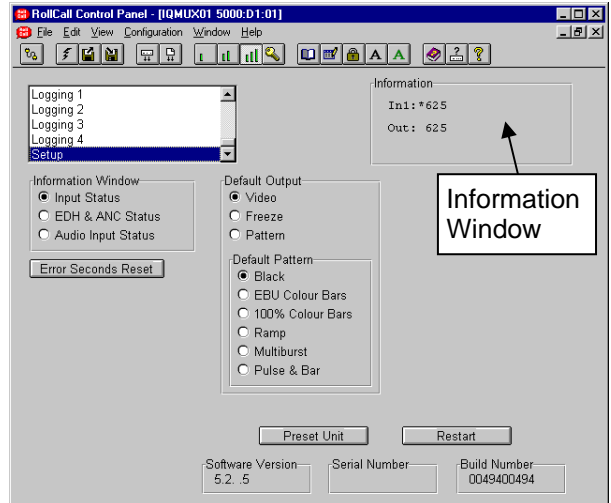

Audio Input Status

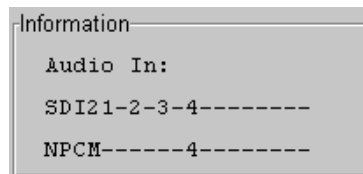

Audio In: This shows the status of the selected audio input

SDI1(2) This shows the audio pairs present on the selected input as 1, 2, 3, 4, etc.

NPCM This shows the non-PCM audio pairs present on the selected input as 1, 2, 3, 4, etc. This example shows that pair 4 is non-PCM. *Note that the Dolby header in the data stream is used to detect if the audio is non-PCM.*

Setup (continued)

Default Output

If the input signal fails or is of poor quality this function will determine what the output signal will become under such conditions.

Default Pattern

If Pattern is chosen in the **Default Output** item the output will become the pattern chosen from this list.

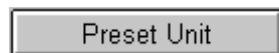

Selecting this item sets all adjustment functions that include a preset facility, to their preset values.

Note that this is a momentary action.

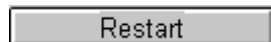

This will reboot the unit simulating a power-down power-up cycle restoring power-up settings.

Software version

This item shows the version of the software fitted in the module.

Serial Number

This item shows the serial number of the module

Build Number

This will indicate the factory build number. This number defines all parameters of the unit (software versions, build level etc.) for identification purposes.

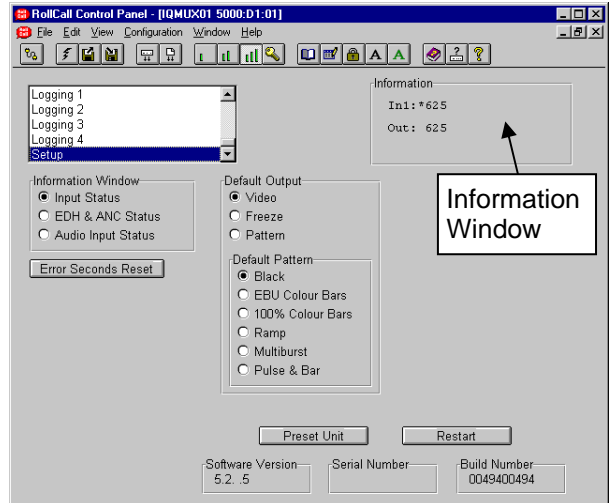

Operation from an Active Control Panel

The card may be operated from an active control panel via the RollCall™ network.



All operational parameters and selections are made using a system of menus displayed in two LCD windows.

Operational details for the remote control panel can be found in the Modular System Operator's Manual.

Information Window

The Information window has four lines of text indicating the current state of the unit.

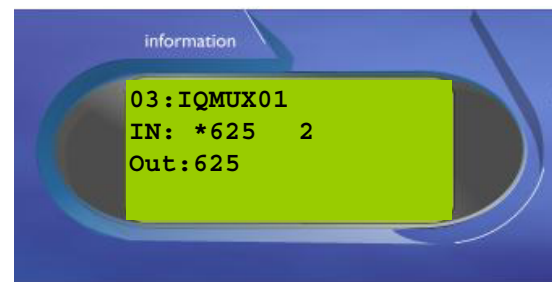

For details of the abbreviations used please see page 39.

Control Window

The **Control** window displays all Selection Menus and sub-menus.

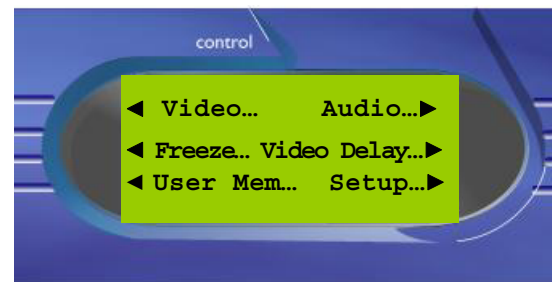

The selection is made by pressing the button adjacent to the required item.

The menu structure is detailed in the following pages.

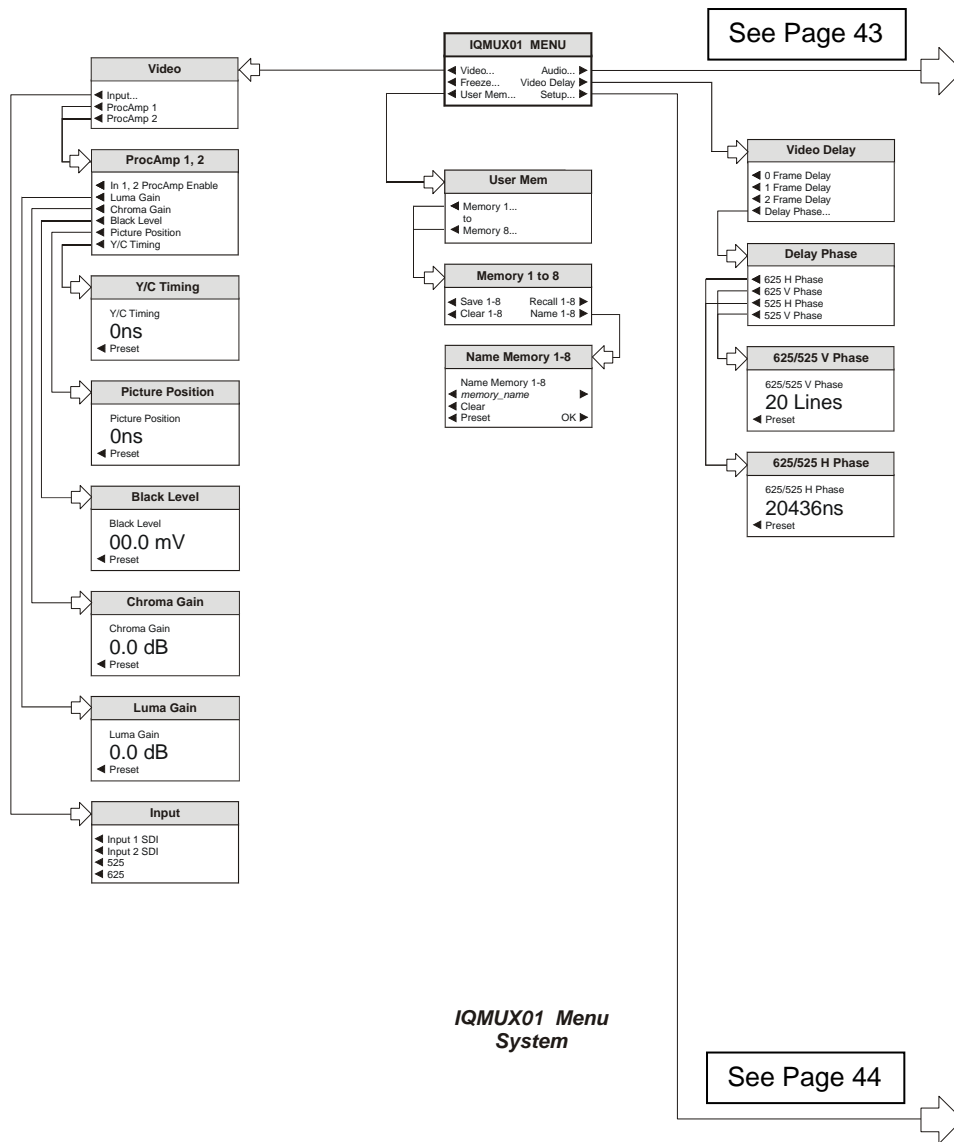

IQMUX01 Menu System

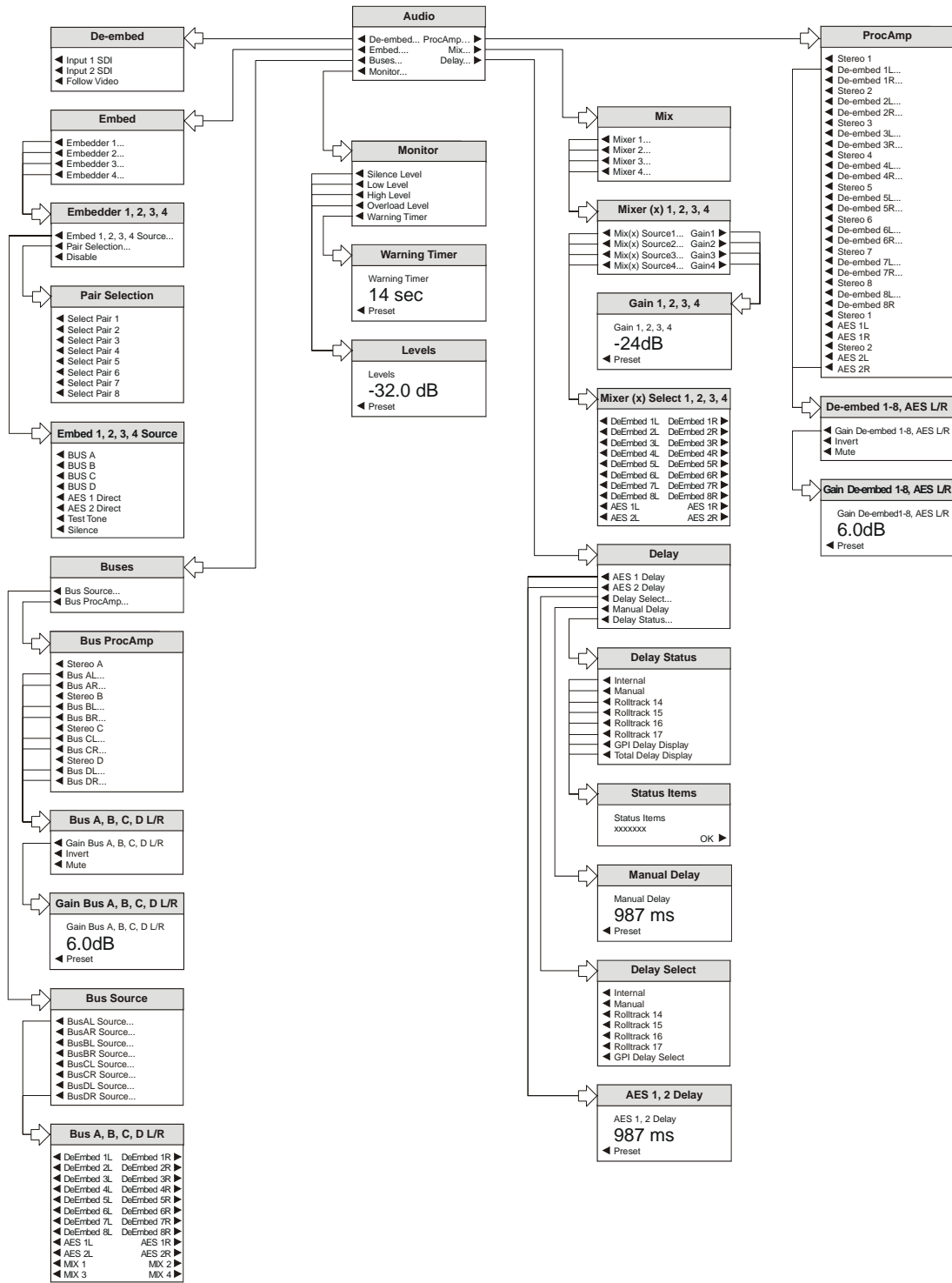

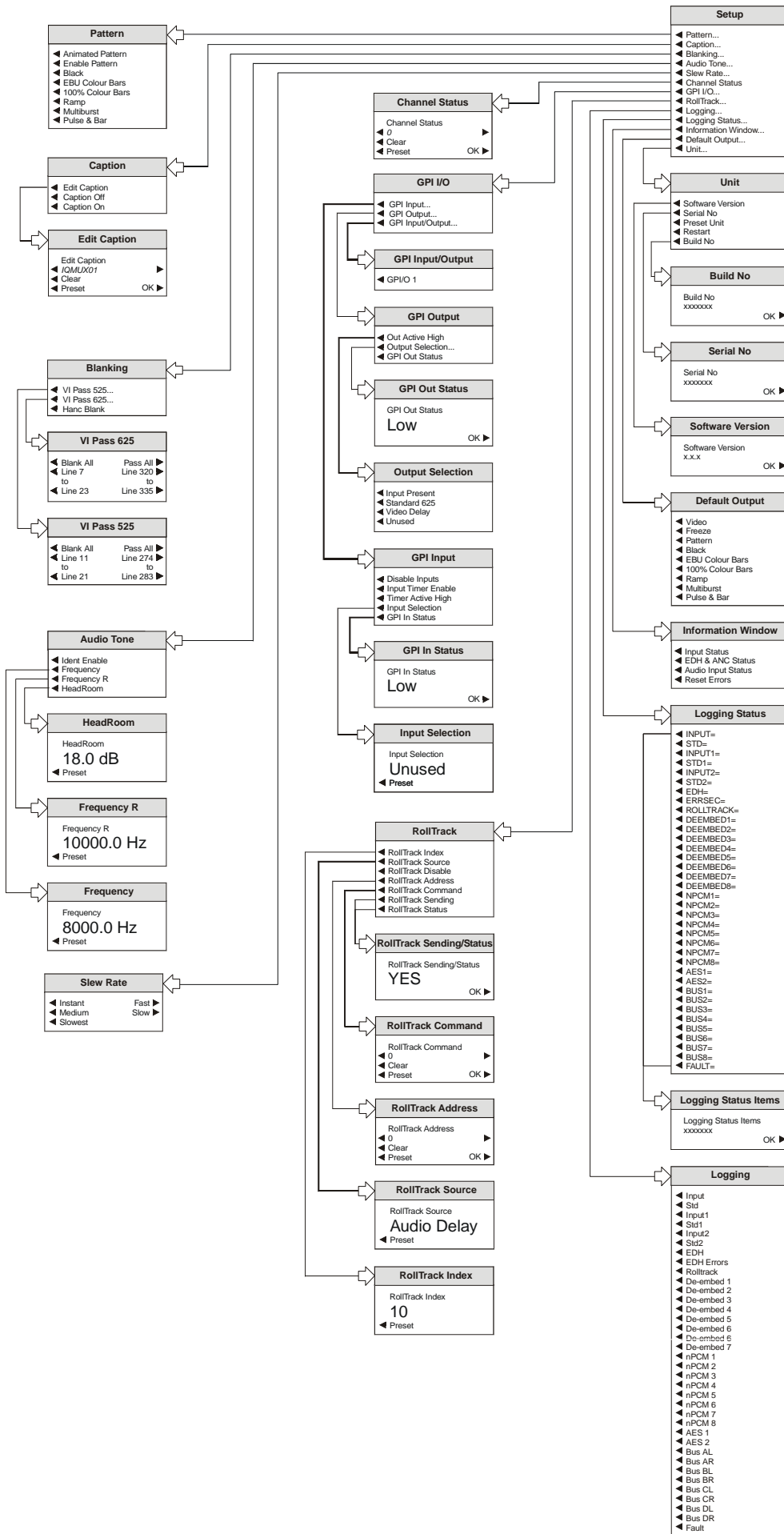

MENU DETAILS

(see IQMUX01 Menu System on previous pages)

MAIN MENU

The main or top level menu allows various sub-menus to be selected by pressing the button adjacent to the required text line.

Note that where a menu item is followed by three dots (...) this indicates that a further sub-menu may be selected.

Whenever a menu item is selected the parameters of that selection will be displayed in the Information window of the front panel. Where the selection is purely a mode selection and does not enable a sub-menu, the text will become reversed (white-on-black) indicating that the mode is active. If the mode is not available for selection the text will remain normal.

Also refer to the block diagram on page 6 for more information.

MAIN MENU

IQMUX01 MENU	
◀ Video...	Audio... ▶
◀ Freeze...	Video Delay ▶
◀ User Mem...	Setup... ▶

Video

This item allows the input signal to be selected and adjustments to be made.

Video
◀ Input...
◀ ProcAmp 1
◀ ProcAmp 1

◀ Input

This item allows the input signal and its standard to be selected.

Input
◀ Input 1 SDI
◀ Input 2 SDI
◀ 525
◀ 625

◀ Input 1 SDI, Input 2 SDI

This item allows the input signal to be selected; either Input 1 SDI, Input 2 SDI or may be selected.

Note that as the IQMUX0100-1 has only one input, Input 1 SDI should always be selected. If Input 2 SDI is selected the unit will report an input loss.

◀ 525, 625

This allows input standard to be selected.

If only 625 is selected the unit will be forced to only accept 625 line inputs.

If only 525 is selected the unit will be forced to only accept 525 line inputs.

If 625 and 525 are selected the unit will accept both 625 and 525 line inputs.

Note that normally the unit will lock to the selected SDI input; if this is lost or is not present, the unit will automatically lock to the AES signal on AES Input 1, if available.

◀ ProcAmp 1, ProcAmp 2

These items allow signal levels and timings for each of the input channels to be adjusted.

ProcAmp 1, 2
<ul style="list-style-type: none"> ◀ In 1, 2 ProcAmp Enable ◀ Luma Gain ◀ Chroma Gain ◀ Black Level ◀ Picture Position ◀ Y/C Timing

◀ In 1, 2, ProcAmp Enable

When selected the ProcAmp will become enabled for that channel and the settings will be applied to the signal.

When unselected the settings will revert to the preset values.

All the values below may be adjusted using the spinwheel.

◀ Luma Gain

Luma Gain
Luma Gain 0.0 dB ◀ Preset

This allows the Y (luminance) gain to be adjusted by ± 6 dB in steps of 0.1 dB. Preset value is 0.0 dB.

◀ Chroma Gain

Chroma Gain
Chroma Gain 0.0 dB ◀ Preset

This allows the Cb/Cr (color difference) gain to be adjusted by ± 6 dB in steps of 0.1 dB. Preset value is 0.0 dB.

◀ Black Level

Black Level
Black Level 00.0 mV ◀ Preset

This allows the black level to be adjusted by ± 100 mV in 0.8 mV steps. Preset value is 0.

◀ Picture Position

Picture Position
Picture Position 0ns ◀ Preset

This item allows the timing of the picture position relative to the normal value, to be adjusted.

The timing may be adjusted by ± 592 ns in 148 ns steps.

◀ Y/C Timing

Y/C Timing
Y/C Timing 0ns ◀ Preset

This item allows the timing of the chrominance signal relative to the luminance signal to be adjusted, (i.e. Y to Cb/Cr timing) in nanoseconds.

The timing may be adjusted by ± 592 ns in 148 ns steps.

Freeze

When selected the output picture will become a frozen frame.

User Mem(ories)

This function allows a number of particular setups of the IQMUX01 to be saved and recalled. There are 8 memory locations available.

This item allows any of the 8 memory locations to be selected.

User Mem
◀ Memory 1... to ▶ Memory 8...

◀ Memory 1 to 8

Memory 1 to 8
◀ Save 1-8 Recall 1-8 ▶ ▶ Clear 1-8 Name 1-8 ▶

When a memory location has been selected this item allows it to be saved, recalled, cleared or renamed.

◀ Save 1-8

When selected the current settings will be saved at this location.

Recall 1-8 ▶

When selected the settings will be recalled from this location and applied to the unit.

▶ Clear 1-8

When selected the memory location will be cleared and returned to the default (preset) setting.

Name 1-8 ▶

The selected memory location may be renamed with this function.

To compile/edit the text the right ▶ and left ◀ buttons adjacent to the upper text line in the menu should be used to select the character position in the text and the spinwheel used to select the character.

Name Memory 1-8
Name Memory 1-8
◀ <i>memory_name</i> ▶
▶ Clear
▶ Preset OK ▶

The ◀ **Clear** function blanks the selected character.

The ◀ **Preset** function loads the default text, for example, **Memory 1**.

O.K. ▶ saves the memory name text and returns to the main menu.

Audio

This menu allows the audio processing functions to be set up.

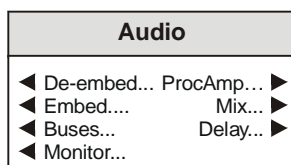

◀ De-embed

This allows the audio signal to be selected for processing.

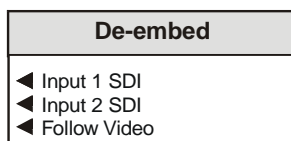

◀ Input 1 SDI, Input 2 SDI

This allows audio derived from either Input 1 SDI or Input 2 SDI to be selected for processing.

◀ Follow Video

When selected the audio will be derived from the video input signal that has been selected for processing.

Non-PCM groups can be transparently passed but if a non-PCM group is selected for mixing or routing it will be automatically muted.

If a Dolby header is detected in the data stream it will be processed as a non-PCM signal.

◀ Embed

There are four embedders. This function sets up the embedder sources and destinations to be selected for each of these embedders.

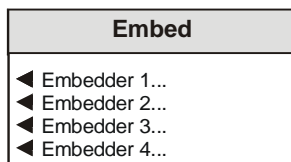

This allows each of the embedders to be selected.

For details of the Audio Embedding Packet Distribution please refer to Appendix 2 on page 84.

◀ Embedder 1, 2, 3 and 4

This allows the embedder functions to be selected.

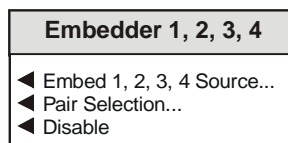

◀ Embed 1, 2, 3, and 4 Source

This allows the source for the embedder to be selected.

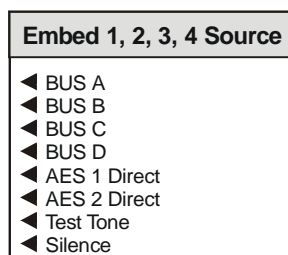

◀ BUS A, B, C and D and AES Direct 1, 2

The source may be derived from one of the three busses or two AES inputs.

◀ Test Tone

The source will be a test tone derived from the **Setup/Audio Tone** menu.

◀ Silence

The source will be silence.

◀ Pair Selection

The destination for the embedded signal may be selected from the list.

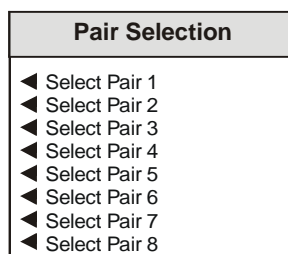

◀ Disable

When selected the embedder will be turned off, (for this embedder).

◀ **Buses**

This function allows the inputs for the four audio buses of the router to be selected and adjusted.

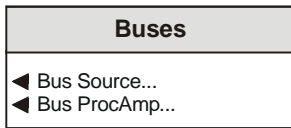

For each bus any source may be for the left and right channels.

◀ **Bus Source**

This allows the bus source to be selected.

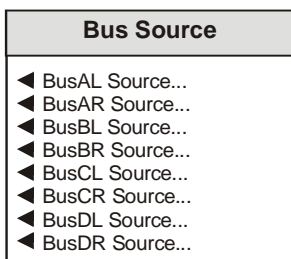

◀ **Bus (A-D) L/R Source**

This allows the audio source for the left and right channels of the bus to be selected.

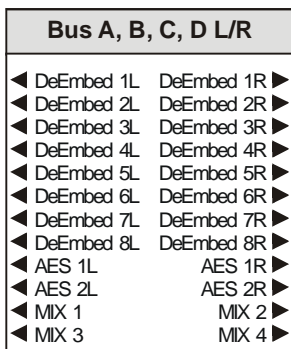

◀ **DeEmbed (1-8) L/R**

The audio source for the left and right channels of the bus may be selected from the De-Embedded signals or the output of one four mixers.

◀ **Bus ProcAmp**

This allows the bus signals to be configured and adjusted.

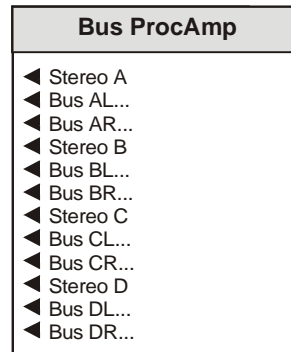

◀ **Stereo (A, B, C, D)**

When selected the left and right channels will be configured as a stereo pair and any adjustments made to one channel will automatically be applied to both channels.

◀ **Bus (A, B, C, D) Left/Right**

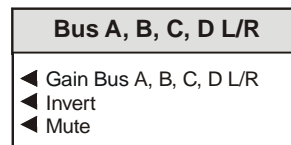

This allows the bus signals to be adjusted and configured.

◀ **Gain Bus (A, B, C, D) Left/Right**

This allows the gain of the selected bus signal channel to be adjusted.

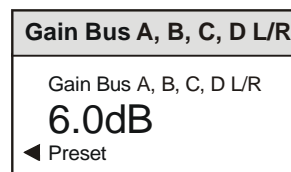

The gain may be adjusted over a range of ±18 dB in 0.1 dB steps. Preset is to 0 dB.

◀ **Invert**

When selected the signal polarity of the selected bus signal will be inverted.

◀ **Mute**

When selected the selected bus signal will be muted.

◀ Monitor

The four audio buses are monitored and level detectors provide status information and logging data.

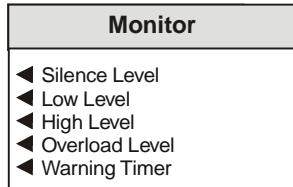

Levels

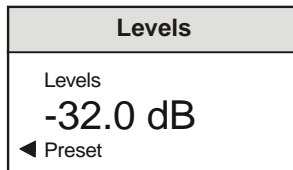

These levels may be adjusted by rotating the spinwheel.

◀ Silence Level

The level at which the signal is considered to have dropped to silence may be set with this control.

The range is from -80 dB to 0 dB in steps of 1 dB. Preset is to -70 dB.

◀ Low Level

The level at which the signal is considered to have dropped to a Low Level may be set with this control.

The range is from -80 dB to 0 dB in steps of 1 dB. Preset is to -60 dB.

◀ High Level

The level at which the signal is considered to have risen to a High Level may be set with this control.

The range is from -80 dB to 0 dB in steps of 1 dB. Preset is to -10 dB.

◀ Overload

The level at which the signal is considered to have risen to an Overload condition may be set with this control.

The range is from -80 dB to 0 dB in steps of 1 dB. Preset is to 0 dB.

◀ Warning Timer

All the above monitoring facilities will only operate after a time interval set by this control. When OK it will operate immediately.



The range is from 1 to 20 seconds. Preset is to 10 seconds.

ProcAmp ►

This allows the control of Gain, Mute, and Polarity of de-embedded channels.

ProcAmp
◀ Stereo 1
◀ De-embed 1L...
◀ De-embed 1R...
◀ Stereo 2
◀ De-embed 2L...
◀ De-embed 2R...
◀ Stereo 3
◀ De-embed 3L...
◀ De-embed 3R...
◀ Stereo 4
◀ De-embed 4L...
◀ De-embed 4R...
◀ Stereo 5
◀ De-embed 5L...
◀ De-embed 5R...
◀ Stereo 6
◀ De-embed 6L...
◀ De-embed 6R...
◀ Stereo 7
◀ De-embed 7L...
◀ De-embed 7R...
◀ Stereo 8
◀ De-embed 8L...
◀ De-embed 8R
◀ Stereo 1
◀ AES 1L
◀ AES 1R
◀ Stereo 2
◀ AES 2L
◀ AES 2R

◀ Stereo (1, 2, 3, 4, 5, 6, 7, 8)

When selected the left and right channels will be configured as a stereo pair and any adjustments made to one channel will automatically be applied to both channels.

◀ De-embed 1-8, AES L/R

This allows the bus signals to be adjusted and configured.

De-embed 1-8, AES L/R
◀ Gain De-embed 1-8, AES L/R
◀ Invert
◀ Mute

◀ Gain De-embed (1-8, AES) Left/Right

This allows the gain of the selected de-embedded signal to be adjusted.

Gain De-embed 1-8, AES L/R
Gain De-embed1-8, AES L/R
6.0dB
◀ Preset

The gain may be adjusted over a range of ± 18 dB in 0.1 dB steps. Preset is to 0 dB.

◀ Invert

When selected the signal polarity of the selected bus signal will be inverted.

◀ Mute

When selected the selected bus signal will be muted.

Mix ►

There are four separate audio mixers Mix 1, 2, 3 and 4. The outputs of these mixers provide four extra input selections for the Channel Router.

This menu allows each of the mixers to be selected and configured.

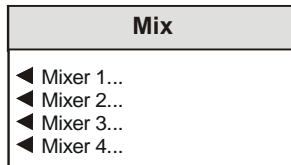
**◀ Mixer 1, 2, 3 and 4**

Each mixer has four inputs and this item allows the mixer input to be selected and the gain of that channel adjusted.

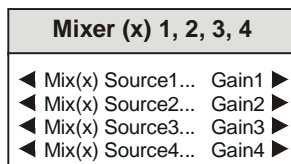
**◀ Mixer 1, 2, 3 and 4 Source 1-4 (inputs)**

This allows the signal source for the selected input of the selected mixer, to be chosen.

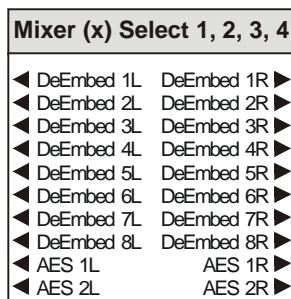
**Gain 1-4 ►**

These are the individual gain controls that allow the mixing levels for each of the input signals, to be adjusted.

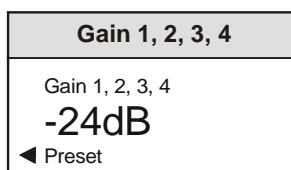

The range of adjustment is from 0 to -90 dB and to Off.

0 to -60 dB is in steps of 1 dB; -60 dB to -90 dB is in steps of 3 dB.

Delay ►

This menu allows the amount of delay to be set and type of audio delay mechanism to be selected.

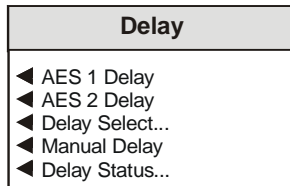
**◀ AES 1, 2 Delay**

This allows the AES inputs to be delayed.

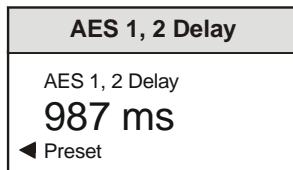

The delay may be adjusted be from 0 to 1500 ms in steps of 1 ms. Preset is to 0 ms.

*Note that this delay will not be included in the RollTrack audio delay or in the Total Delay measurement displayed in the **Delay Status** sub-menu.*

◀ Delay Select

This allows the type of audio delay mechanism to be selected. One or more of the types may be checked. The amount of delay applied will be the sum of the delay from the enabled delay mechanisms.

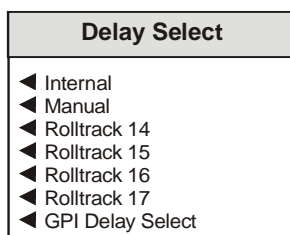

*Note that up to 0.5 s of delay may be applied from the sum of the **Internal + GPI + RollTrack** delay inputs.*

◀ Internal

When selected, an audio delay equal to the video delay in the unit will be applied.

◀ Manual

When selected an audio delay set by the **Manual Delay** control will be applied, immediately.

◀ Manual Delay

This will affect all processed audio signals equally.

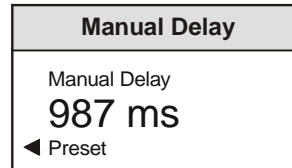

The delay may be adjusted by up to +1500 ms in steps of 1 ms. Preset is to 0 ms.

◀ RollTrack 14, 15, 16 and 17

The selected source(s) of the RollTrack input signal(s) will apply an audio delay, smoothly compensating.

Also see page 61.

◀ GPI Delay Select

When selected an audio delay will be applied that is equal to the width of the pulse arriving at the GPI connector.

Note that an audio delay pulse of more than 500 ms, applied to the GPI Input will be treated as invalid. This will result in the GPI delay returning to zero.

Note that the GPI must be configured correctly for this function to operate. Please see page 59 for details.

◀ Delay Status

The status (and amount) of delay produced by each of the delay methods may be chosen from this menu.

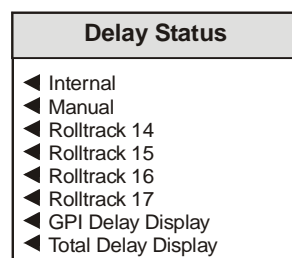
**◀ Status Items**

The status (and amount) of delay of the chosen item will be displayed in this window.

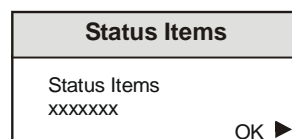

Video Delay

This allows the output signal to be delayed relative to the input signal.

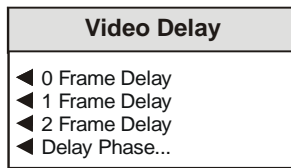

◀ 0, 1, 2 Frame Delay

The number of frames that the output signal will appear after the input signal may be set with these items.

◀ Delay Phase

When these controls are used the output signal will appear after the input signal with a time delay.

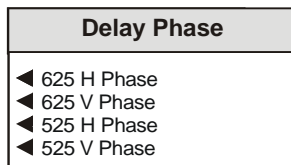

◀ 625/525 H(Horizontal) Phase

This item allows the horizontal timing of the output signal relative to the input signal to be adjusted by up to 1 line in 37 ns steps. The spinwheel will adjust this value.

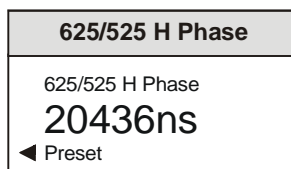

Selecting Preset returns the setting to the minimum horizontal delay.

◀ 625/525 V(Vertical) Phase

This item allows the vertical timing of the output signal relative to the input signal to be adjusted, in TV lines. The spinwheel will adjust this value. Range is from 0 to 624 or 524 lines in 1 line steps.

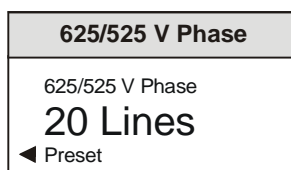

Selecting Preset returns the setting to the minimum vertical delay.

Setup...

◀ Pattern

This function will allow various patterns to be used as the output signal.

Pattern
◀ Animated Pattern
◀ Enable Pattern
◀ Black
◀ EBU Colour Bars
◀ 100% Colour Bars
◀ Ramp
◀ Multiburst
◀ Pulse & Bar

◀ Animated Pattern

When selected, a monochrome rectangular area will appear on the output picture as shown opposite. The brightness of this rectangle will ramp from black, through gray to white and then directly to black over a period of about one second. This action will then be repeated continuously.

This pattern is useful for checking active video paths. Down stream equipment can see that video has not been frozen.

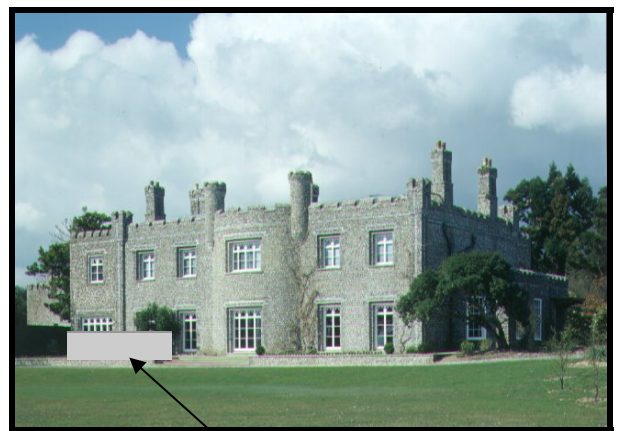

Animated Pattern

◀ Enable Pattern

When selected the output will become the pattern highlighted in the Pattern list.

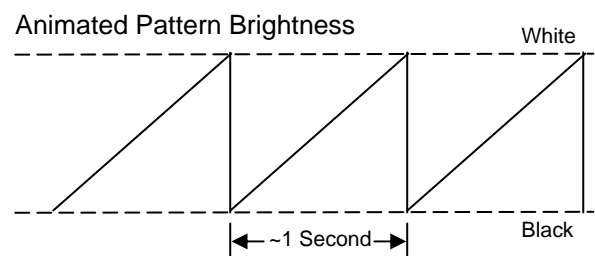

◀ Caption

This function allows control of the caption which may contain a maximum of 19 characters (white text on a black background).

The caption will appear in the lower section of the picture.

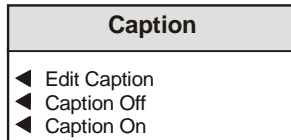

Caption Text

◀ Edit Caption

This allows a caption to be edited.

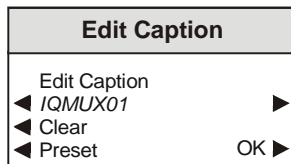

To compile/edit the text the right ▶ and left ◀ buttons adjacent to the upper text line in the menu should be used to select the character position in the text and the spinwheel used to select the character.

The ◀ **Clear** function blanks the selected character.

The ◀ **Preset** function loads the default text, for example, **IQMUX01**.

O.K. ▶ saves the memory name text and returns to the main menu.

◀ Caption Off

When selected the caption will be turned off.

◀ Caption On

When selected the caption will be turned on.

◀ Blanking

This item allows the Vertical Interval data (all or specific lines) contained in the input signal to be blanked or passed through the module.

Blanking	
◀ VI Pass 525...	
◀ VI Pass 625...	
◀ Hanc Blank	
◀ V Flag (OBD)	

◀ VI Pass 525

This item allows lines 11 to 22 and lines 274 to 284 of 525 line signals to be selected and either passed (highlighted) to the output or blanked from the output.

VI Pass 525	
◀ Blank All	Pass All ▶
◀ Line 11	Line 274 ▶
to	to
◀ Line 22	Line 284 ▶

◀ Blank All

Selecting this item will select all vertical interval lines in the 525 line list and blank them from the output.

Pass All ▶

Selecting this item will select all vertical interval lines in the 525 line list and allow them to passed through to the output.

VI Pass 625	
◀ Blank All	Pass All ▶
◀ Line 7	Line 320 ▶
to	to
◀ Line 23	Line 335 ▶

◀ VI Pass 625

This section allows lines 7 to 23 and lines 320 to 335 of 625 line signals to be selected and either passed (highlighted) to the output or blanked from the output.

◀ Blank All

Selecting this item will select all vertical interval lines in the 625 line list and blank them from the output.

Pass All ▶

Selecting this item will select all vertical interval lines in the 625 line list and allow them to passed through to the output.

◀ Hanc Blank

When checked all horizontal data will be blanked, on the input. When unselected, passthrough operations will not alter audio packets for groups that the IQMUX01 has not selected for embedding. In order to allow minimum synchronization delay the created packets are output first and then the passthrough groups are placed after the created streams have been embedded. This means that passthrough is achieved without altering the input packet distribution. Passthrough operation has to take note of marked for deletion packets and these are removed where possible to ensure that one does not run out of useable ancillary space.

For details of the HANC Data Handling please refer to Appendix 2 on page 84.

◀ V Flag (OBD)

This control allows the V(ertical) Flag to be changed from line 10 (OVD, Optional Video Data) to line 20 (OBD, Optional Blanking Data).

Un-highlighted selects OVD and highlighted selects OBD. The default is OVD selected.

Note that this function is only active for 525 line signals.

◀ **Audio Tone**

The frequency of the Audio Test Tone may be set using this control. Left and right channels may be set to frequencys.

Audio Tone
◀ Ident Enable
◀ Frequency
◀ Frequency R
◀ HeadRoom

◀ **Ident Enable**

When selected the right channel will be identified by the signal being muted for 0.5 second every 2.5 seconds.

◀ **Frequency**

This adjusts the frequency of the test tone for the left channel only.

Frequency
Frequency
8000.0 Hz
◀ Preset

The range is from 100 Hz to 15 kHz in steps of 100 Hz. Preset is to 400 Hz.

◀ **Frequency R**

This adjusts the frequency of the test tone for the right channel only.

Frequency R
Frequency R
10000.0 Hz
◀ Preset

The range is from 100 Hz to 15 kHz in steps of 100 Hz. Preset is to 400 Hz.

◀ **Headroom**

This allows the headroom to be set.

HeadRoom
HeadRoom
18.0 dB
◀ Preset

The range is from 4 dB to 24dB in 1 dB steps. Preset is to 18 dB.

Note that in this product headroom is defined as:

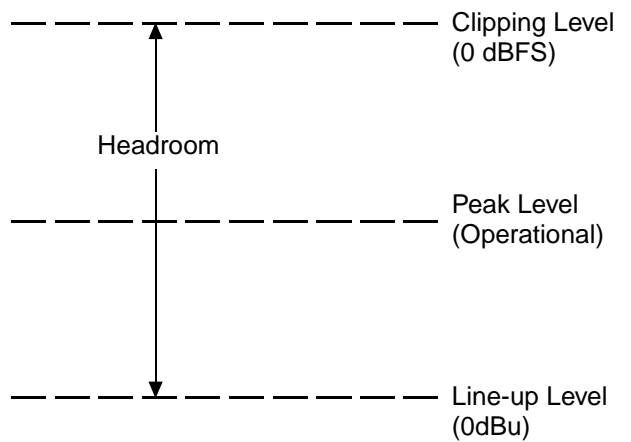

Headroom = Clipping Level – Line-up level

◀ **Slew Rate**

This is the time taken for the audio to slew when the audio mixing and routing controls have changed.

Slew Rate
◀ Instant Fast ▶
◀ Medium Slow ▶
◀ Slowest

The options are:

Instant ... The response is immediate

Slowest . Change takes approximately one second

Slow Change takes 75% of Slowest time

Medium . Change takes 50% of Slowest time

Fast Change takes 25% of Slowest time

◀ **Channel Status**

Channel Status
Channel Status
◀ 0 ▶
◀ Clear ▶
◀ Preset OK ▶

This will set the four character name used in the destination field of the audio channel status.

Note that the Channel Status Origin data is automatically set by the module to MUX1 and cannot be changed.

◀ **GPI/O**

This function allows the GPI functions to be configured and their actions defined.

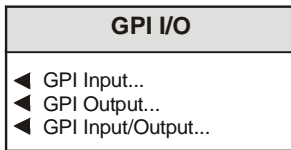

◀ **GPI Input**

This item allows the GPI input functions to be configured.

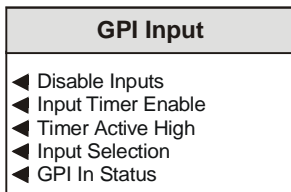

◀ **Disable Inputs**

When selected all GPI input functions will be disabled.

◀ **Timer Enable**

When checked the GPI will be monitored. The width of the pulse represents the delay that can be used to control audio delays in this unit.

Note that an audio delay pulse of more than 500 ms, applied to the GPI Input will be treated as invalid. This will result in the GPI delay returning to zero.

◀ **Timer Active High**

When checked the GPI will measure the positive going pulse. When unchecked the negative pulse is measured.

◀ **Out Active High**

Determines the sense of the asserted GPI output signal. When checked GPI is active the output sense is high. When unchecked the GPI is active low.

◀ **Input Selection**

When configured as an input the GPI connection may be used for accepting GPI information (from mechanical switch contacts, relay contacts etc.)

The resulting action that the unit takes may be selected using this item.

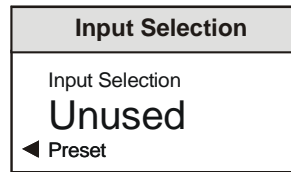

The GPI input functions that may be selected are as follows:

- Unused** The unit will perform no function. This is also the Preset Setting.
- Pattern** The unit will produce a pattern chosen from the Pattern menu when the input changes from open to closed.
- Memory 1 to 8** The unit will use the settings in the selected memory location when the input changes from open to closed.
- Mem1-2** The unit will toggle between the settings of memory locations 1 and 2. Open to Closed = Memory 1 settings Closed to Open = Memory 2 settings
- Mem 3-4** The unit will toggle between the settings of memory locations 3 and 4. Open to Closed = Memory 3 settings Closed to Open = Memory 4 settings
- Mem 5-6** The unit will toggle between the settings of memory locations 5 and 6. Open to Closed = Memory 5 settings Closed to Open = Memory 6 settings
- Mem 7-8** The unit will toggle between the settings of memory locations 7 and 8. Open to Closed = Memory 7 settings Closed to Open = Memory 8 settings

◀ **GPI In Status**

This will display the current status of the selected GPI input.

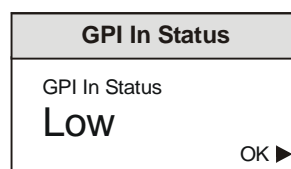

This may show either High or Low. When low, the associated function will be triggered. On a transition, the associated function will be triggered.

◀ GPI Output

This item allows the GPI output functions to be configured.

GPI Output
<ul style="list-style-type: none"> ◀ Out Active High ◀ Output Selection... ◀ GPI Out Status

◀ Out Active High

This determines the sense of the asserted GPI output signal.

When selected the GPI is active the output sense is high. When unchecked the GPI is active low.

◀ Output Selection

The GPO may be configured to produce an output corresponding to one of the conditions highlighted in the list.

Output Selection
<ul style="list-style-type: none"> ◀ Input Present ◀ Standard 625 ◀ Video Delay ◀ Unused

The preset setting for the output is Unused.

When the condition is not true the output will float but when the condition is true the output is closed to ground via a transistor.

Note that when video delay mode is selected the output is a negative going TTL pulse. The width of the pulse represents the video delay through the unit to the nearest millisecond.

◀ GPI Out Status

This will display the current status of the GPI output.

GPI Out Status
GPI Out Status LOW OK ►

This may show either Unused, High, low or video delay in milliseconds.

◀ GPI I Input/Output

This allows the GPI port to be configured as an input or an output.

GPI Input/Output
◀ GPI/O 1

When selected the GPI is configured as an output. When unselected the GPI is configured as an input.

◀ RollTrack

This function allows information to be sent, via the RollCall™ network, to other compatible units connected on the same network.

For example, it can enable compatible audio delay units to produce an audio delay dependent on this and other similar units. The audio delay unit will dynamically follow or track the received delay-time information. This allows processed video signals to be timed correctly with audio signals. This automatic tracking system via the RollCall™ network is call **RollTrack**.

RollTrack
<ul style="list-style-type: none"> ◀ RollTrack Index ◀ RollTrack Source ◀ RollTrack Disable ◀ RollTrack Address ◀ RollTrack Command ◀ RollTrack Sending ◀ RollTrack Status

For more detailed information, see the RollTrack section (Appendix) at the end of this manual.

◀ RollTrack Index

RollTrack Index
RollTrack Index 10 ◀ Preset

This item is used to select which RollTrack Index is set up using the RollTrack Source, RollTrack Address and RollTrack Command functions. It allows up to 70 destinations to be selected.

◀ RollTrack Source

RollTrack Source
RollTrack Source Audio Delay ◀ Preset

This allows the source of information that triggers the transmission of data to be selected. Options are:

Unused (off)	De-embed 1 Lost
Input Present	De-embed 1 PCM
Input Missing	De-embed 1 NPCM
Standard 525	to
Standard 625	De-embed 8 Lost
Input 1 Present	De-embed 8 PCM
Input 1 Missing	De-embed 8 NPCM
Standard 1 525	AES 1 Lost
Standard 1 625	AES 1 PCM
Input 2 Present	AES 1 NPCM
Input 2 Missing	to
Standard 2 525	AES 4 Lost
Standard 2 625	AES 4 PCM
Audio Delay	AES 4 NPCM
Video Delay	GPI 1 Low
	GPI 1 High
	GPI 1 Inactive

Note that the GPI RollTrack functions should not be used when **GPI Timer Enable** is selected.

The destination for the information is set by the network code address.

◀ RollTrack Disable

When this item is selected all RollTrack items will be disabled.

◀ RollTrack Address

This item allows the address of the selected destination unit to be set.

RollTrack Address	
RollTrack Address	
◀ 0 ▶	
◀ Clear ▶	
◀ Preset ▶	OK ▶

To compile/edit the text the right ▶ and left ◀ buttons adjacent to the upper text line in the menu should be used to select the character position in the text and the spinwheel used to select the character.

The ◀ **Clear** function blanks the selected character.

The ◀ **Preset** function loads the default address.

O.K. ▶ saves the address and returns to the main menu.

The full **RollTrack** address has four sets of numbers

For example: 0000:10:01*362

The first set (0000) is the network segment code number

The second set (10) is the number identifying the (enclosure/mainframe) unit.

The third set (01) is the slot number in the unit

The Fourth Set (362)

Each RollCall unit has a unique identification embedded in the units' software. In this example 362 represents an IQDMX00, 412 would represent an IQDEC00, 161 a Mach 1 etc. Inserting this number in the RollTrack address ensures that only the correct type of unit (in this example an IQDMX00) will respond to the RollTrack command; any other unit will ignore the command.

If this number were set to 00 **any type** of unit at this location would respond to the RollTrack command, possibly causing unpredictable results.

The unit ID of a module on the RollCall network may be found under *RollCall Control Panel/RollCall Listing/Unit Information* or via the *RollCall Control Panel Help/About Current Unit* function.

◀ RollTrack Command

RollTrack Command	
RollTrack Command	
◀ 0 ▶	
◀ Clear ▶	
◀ Preset ▶	OK ▶

The full **RollTrack** command has two sets of numbers

For example: 84*156

The first set (84) is the **RollTrack** command number

Note that only command numbers 14, 15, 16 and 17 should be used for audio delay

The second set (156) is the value sent with the **RollTrack** command number.

For details of the RollCall command values for specific units please contact your local Snell & Wilcox agent.

◀ RollTrack Sending

This item shows when the unit is actively sending the RollTrack command.

RollTrack Sending/Status	
RollTrack Sending/Status	
YES	OK ▶

This may show:

String	A string value is always being sent.
Number	A number value is always being sent.
No	The message is not being sent.
Yes	The message is being sent.
Internal Type Error	Inconsistent behavior; please contact your local Snell & Wilcox agent.

◀ RollTrack Status

This item will show the status of the currently selected RollTrack index.

This may show:

OK	RollTrack message sent and received OK.
Unknown	Rolltrack message has been sent but it has not yet completed.
Timeout	RollTrack message sent but acknowledgement not received. This could be because the destination unit is not at the location specified.
Error	This indicates a broken RollCall state.
Bad	This indicates a broken RollCall packet.

◀ Logging

Information about up to 25 parameters can be made available to a logging device that is attached to the RollCall™ network by selecting the appropriate item.

Logging
◀ Input
◀ Std
◀ Input1
◀ Std1
◀ Input2
◀ Std2
◀ EDH
◀ EDH Errors
◀ Rolltrack
◀ De-embed 1
◀ De-embed 2
◀ De-embed 3
◀ De-embed 4
◀ De-embed 5
◀ De-embed 6
◀ De-embed 6
◀ De-embed 7
◀ nPCM 1
◀ nPCM 2
◀ nPCM 3
◀ nPCM 4
◀ nPCM 5
◀ nPCM 6
◀ nPCM 7
◀ nPCM 8
◀ AES 1
◀ AES 2
◀ Bus AL
◀ Bus AR
◀ Bus BL
◀ Bus BR
◀ Bus CL
◀ Bus CR
◀ Bus DL
◀ Bus DR
◀ Fault

Any of the items may be selected from the list.

◀ Logging Status

Logging Status
◀ INPUT=
◀ STD=
◀ INPUT1=
◀ STD1=
◀ INPUT2=
◀ STD2=
◀ EDH=
◀ ERRSEC=
◀ ROLLTRACK=
◀ DEEMBED1=
◀ DEEMBED2=
◀ DEEMBED3=
◀ DEEMBED4=
◀ DEEMBED5=
◀ DEEMBED6=
◀ DEEMBED7=
◀ DEEMBED8=
◀ NPCM1=
◀ NPCM2=
◀ NPCM3=
◀ NPCM4=
◀ NPCM5=
◀ NPCM6=
◀ NPCM7=
◀ NPCM8=
◀ AES1=
◀ AES2=
◀ BUS1=
◀ BUS2=
◀ BUS3=
◀ BUS4=
◀ BUS5=
◀ BUS6=
◀ BUS7=
◀ BUS8=
◀ FAULT=

This will show the status of the selected item.

Logging Status Items
Logging Status Items xxxxxxx
OK ▶

ROLLCALL LOG FIELDS

**Note that these log values are either for future use or may be logged during a transitional state whilst acquiring or loosing an input signal. It is very unlikely that these states and the associated log values will become permanent.*

Log Field	Log Value	Description
INPUT=	OK ERR* LOST	Valid input signal Invalid input signal Input signal lost
STD=	UNKNOWN* STDERR 525 625	Input signal standard not recognized or no signal Not a selected input standard Input standard 525 Input standard 625
INPUT1=	OK ERR* LOST	Valid input signal Invalid input signal Input signal lost
STD1=	ERR 525 625	Not a selected input standard Input standard 525 Input standard 625
INPUT2=	OK ERR* LOST	Valid input signal Invalid input signal Input signal lost
STD2=	ERR 525 625	Not a selected input standard Input standard 525 Input standard 625
EDH=	NONE FAIL OK RESET	The unit is not locked to the input signal EDH errors have been found on the input signal No EDH errors found on the input signal EDH statistics have been reset
ERRSEC=	Runtime string	The time since EDH was reset in seconds
ROL_STATES=	OK FAIL	RollTrack message sent and received OK RollTrack message not acknowledged
DEEMBED_1=	NONE OK	Nothing present on pair 1 Embedded pair 1 present on selected SDI input
DEEMBED_2=	NONE OK	Nothing present on pair 2 Embedded pair 2 present on selected SDI input
DEEMBED_3=	NONE OK	Nothing present on pair 3 Embedded pair 3 present on selected SDI input
DEEMBED_4=	NONE OK	Nothing present on pair 4 Embedded pair 4 present on selected SDI input
DEEMBED_5=	NONE OK	Nothing present on pair 5 Embedded pair 5 present on selected SDI input
DEEMBED_6=	NONE OK	Nothing present on pair 6 Embedded pair 6 present on selected SDI input
DEEMBED_7=	NONE OK	Nothing present on pair 7 Embedded pair 7 present on selected SDI input
DEEMBED_8=	NONE OK	Nothing present on pair 8 Embedded pair 8 present on selected SDI input
NPCM_1=	NONE OK	Non-PCM not present on pair 1 of selected SDI input Non-PCM present on pair 1 of selected SDI input
NPCM_2=	NONE OK	Non-PCM not present on pair 2 of selected SDI input Non-PCM present on pair 2 of selected SDI input
NPCM_3=	NONE OK	Non-PCM not present on pair 3 of selected SDI input Non-PCM present on pair 3 of selected SDI input

Log Field	Log Value	Description
NPCM_4=	NONE OK	Non-PCM not present on pair 4 of selected SDI input Non-PCM present on pair 4 of selected SDI input
NPCM_5=	NONE OK	Non-PCM not present on pair 5 of selected SDI input Non-PCM present on pair 5 of selected SDI input
NPCM_6=	NONE OK	Non-PCM not present on pair 6 of selected SDI input Non-PCM present on pair 6 of selected SDI input
NPCM_7=	NONE OK	Non-PCM not present on pair 7 of selected SDI input Non-PCM present on pair 7 of selected SDI input
NPCM_8=	NONE OK	Non-PCM not present on pair 8 of selected SDI input Non-PCM present on pair 8 of selected SDI input
AES_1=	NONPCM OK LOST	Non-PCM signal present on AES input 1 Valid signal present on AES input 1 Signal not present at AES input 1
AES_2=	NONPCM OK LOST	Non-PCM signal present on AES input 2 Valid signal present on AES input 2 Signal not present at AES input 2
AES_3=	NONPCM OK LOST	Non-PCM signal present on AES input 3 Valid signal present on AES input 3 Signal not present at AES input 3
AES_4=	NONPCM OK LOST	Non-PCM signal present on AES input 4 Valid signal present on AES input 4 Signal not present at AES input 4
BUS_AL=	OK WARNING	Router BUS A Left channel has valid signal selected Router BUS A Left channel is receiving silence, low level, high level or overload signal
BUS_AR=	OK WARNING	Router BUS A Right channel has valid signal selected Router BUS A Right channel is receiving silence, low level, high level or overload signal
BUS_BL=	OK WARNING	Router BUS B Left channel has valid signal selected Router BUS B Left channel is receiving silence, low level, high level or overload signal
BUS_BR=	OK WARNING	Router BUS B Right channel has valid signal selected Router BUS B Right channel is receiving silence, low level, high level or overload signal
BUS_CL=	OK WARNING	Router BUS C Left channel has valid signal selected Router BUS C Left channel is receiving silence, low level, high level or overload signal
BUS_CR=	OK WARNING	Router BUS C Right channel has valid signal selected Router BUS C Right channel is receiving silence, low level, high level or overload signal
BUS_DL=	OK WARNING	Router BUS D Left channel has valid signal selected Router BUS D Left channel is receiving silence, low level, high level or overload signal
BUS_DR=	OK WARNING	Router BUS D Right channel has valid signal selected Router BUS D Right channel is receiving silence, low level, high level or overload signal
FAULT=	NONE FAIL	No Internal errors detected Internal error detected
SN=	Runtime string	Serial number of unit

◀ Information Window

Information Window
<ul style="list-style-type: none"> ◀ Input Status ◀ EDH & ANC Status ◀ Audio Input Status ◀ Reset Errors

The type of information that appears in the Information Window may be chosen with this item.

◀ Reset Errors

Selecting this function will reset the EDH error count and the timer shown in the information window, to zero.

◀ Default Output

If the input signal fails or is of poor quality this function will determine what the output signal will become under such conditions.

Default Output
<ul style="list-style-type: none"> ◀ Video ◀ Freeze ◀ Pattern ◀ Black ◀ EBU Colour Bars ◀ 100% Colour Bars ◀ Ramp ◀ Multiburst ◀ Pulse & Bar

◀ Pattern

If Pattern is chosen in the **Default Output** menu the output will become the pattern chosen from the list.

◀ Unit

This provides various items of information about the unit.

Unit
<ul style="list-style-type: none"> ◀ Software Version ◀ Serial No ◀ Preset Unit ◀ Restart ◀ Build No

◀ Software Version

This item reveals a display showing the version of the software fitted in the module.

Software Version
Software Version x.x.x OK ▶

Select OK to return to the Unit Menu.

◀ Serial No

This item reveals a display showing the serial number of the module.

Serial No
Serial No xxxxxxx OK ▶

Select OK to return to the Unit Menu.

◀ Preset Unit

Selecting this item sets all adjustment functions that include a preset facility, to their preset values.

Note that this is a momentary action.

◀ Restart

This will reboot the unit simulating a power-down power-up cycle restoring power-up settings.

◀ Build No

This will indicate the factory build number. This number defines all parameters of the unit (software versions, build level etc.) for identification purposes.

Build No
Build No xxxxxxx OK ▶

Select OK to return to the Unit Menu.

IQMUX01 RollCall Commands

Supervisor Level

Command No.		Command Name	Values		
Hex	Dec				
0001	1	Serial No	Static Display (no control)		
0002	2	Software Version	Static Display (no control)		
0003	3	<RETURN>	1=Preset Unit		
0004	4	<RETURN>	1=Restart		
0005	5	Build No	Static Display (no control)		
000E	14	Rolltrack 14	Static Display (no control)		
000F	15	Rolltrack 15	Static Display (no control)		
0010	16	Rolltrack 16	Static Display (no control)		
0011	17	Rolltrack 17	Static Display (no control)		
040B	1035	Enable Pattern	clear=0 set=1 (toggle=2)		
040C	1036	<RETURN>	0=Black	1=EBU Colour Bars	2=100%
			Colour Bars	3=Ramp	
			4=Multiburst	5=Pulse & Bar	
040D	1037	<RETURN>	0=Caption Off	1=Caption On	
040E	1038	<RETURN>	0=Black	1=EBU Colour Bars	2=100%
			Colour Bars	3=Ramp	
			4=Multiburst	5=Pulse & Bar	
0411	1041	Edit Caption	Edit String		
0424	1060	Input	clear=0 set=1 (toggle=2)		
0425	1061	Std	clear=0 set=1 (toggle=2)		
0428	1064	EDH	clear=0 set=1 (toggle=2)		
042D	1069	Fault	clear=0 set=1 (toggle=2)		
042E	1070	EDH Errors	clear=0 set=1 (toggle=2)		
0446	1094	Input1	clear=0 set=1 (toggle=2)		
0447	1095	Input2	clear=0 set=1 (toggle=2)		
0449	1097	Std1	clear=0 set=1 (toggle=2)		
044A	1098	Std2	clear=0 set=1 (toggle=2)		
0452	1106	RollTrack	clear=0 set=1 (toggle=2)		
0454	1108	AES 1	clear=0 set=1 (toggle=2)		
0455	1109	AES 2	clear=0 set=1 (toggle=2)		
0458	1112	Bus AL	clear=0 set=1 (toggle=2)		
0459	1113	Bus AR	clear=0 set=1 (toggle=2)		
045A	1114	Bus BL	clear=0 set=1 (toggle=2)		
045B	1115	Bus BR	clear=0 set=1 (toggle=2)		
045C	1116	Bus CL	clear=0 set=1 (toggle=2)		
045D	1117	Bus CR	clear=0 set=1 (toggle=2)		
045E	1118	Bus DL	clear=0 set=1 (toggle=2)		
045F	1119	Bus DR	clear=0 set=1 (toggle=2)		
0460	1120	De-embed 1	clear=0 set=1 (toggle=2)		
0461	1121	De-embed 2	clear=0 set=1 (toggle=2)		
0462	1122	De-embed 3	clear=0 set=1 (toggle=2)		
0463	1123	De-embed 4	clear=0 set=1 (toggle=2)		
0464	1124	De-embed 5	clear=0 set=1 (toggle=2)		
0465	1125	De-embed 6	clear=0 set=1 (toggle=2)		
0466	1126	De-embed 7	clear=0 set=1 (toggle=2)		
0467	1127	De-embed 8	clear=0 set=1 (toggle=2)		
0468	1128	nPCM 1	clear=0 set=1 (toggle=2)		
0469	1129	nPCM 2	clear=0 set=1 (toggle=2)		
046A	1130	nPCM 3	clear=0 set=1 (toggle=2)		
046B	1131	nPCM 4	clear=0 set=1 (toggle=2)		
046C	1132	nPCM 5	clear=0 set=1 (toggle=2)		
046D	1133	nPCM 6	clear=0 set=1 (toggle=2)		
046E	1134	nPCM 7	clear=0 set=1 (toggle=2)		
046F	1135	nPCM 8	clear=0 set=1 (toggle=2)		
04B2	1202	<RETURN>	1=Video	2=Freeze	3=Pattern
04B8	1208	Freeze	clear=0 set=1 (toggle=2)		
04BB	1211	Line 11	clear=0 set=1 (toggle=2)		
04BC	1212	Line 12	clear=0 set=1 (toggle=2)		
04BD	1213	Line 13	clear=0 set=1 (toggle=2)		
04BE	1214	Line 14	clear=0 set=1 (toggle=2)		
04BF	1215	Line 15	clear=0 set=1 (toggle=2)		
04C0	1216	Line 16	clear=0 set=1 (toggle=2)		
04C1	1217	Line 17	clear=0 set=1 (toggle=2)		
04C2	1218	Line 18	clear=0 set=1 (toggle=2)		
04C3	1219	Line 19	clear=0 set=1 (toggle=2)		
04C4	1220	Line 20	clear=0 set=1 (toggle=2)		
04C5	1221	Line 21	clear=0 set=1 (toggle=2)		
04CF	1231	Line 274	clear=0 set=1 (toggle=2)		
04D0	1232	Line 275	clear=0 set=1 (toggle=2)		
04D1	1233	Line 276	clear=0 set=1 (toggle=2)		
04D2	1234	Line 277	clear=0 set=1 (toggle=2)		
04D3	1235	Line 278	clear=0 set=1 (toggle=2)		

04D4	1236	Line 279	clear=0 set=1 (toggle=2)
04D5	1237	Line 280	clear=0 set=1 (toggle=2)
04D6	1238	Line 281	clear=0 set=1 (toggle=2)
04D7	1239	Line 282	clear=0 set=1 (toggle=2)
04D8	1240	Line 283	clear=0 set=1 (toggle=2)
04E3	1251	Line 7	clear=0 set=1 (toggle=2)
04E4	1252	Line 8	clear=0 set=1 (toggle=2)
04E5	1253	Line 9	clear=0 set=1 (toggle=2)
04E6	1254	Line 10	clear=0 set=1 (toggle=2)
04E7	1255	Line 11	clear=0 set=1 (toggle=2)
04E8	1256	Line 12	clear=0 set=1 (toggle=2)
04E9	1257	Line 13	clear=0 set=1 (toggle=2)
04EA	1258	Line 14	clear=0 set=1 (toggle=2)
04EB	1259	Line 15	clear=0 set=1 (toggle=2)
04EC	1260	Line 16	clear=0 set=1 (toggle=2)
04ED	1261	Line 17	clear=0 set=1 (toggle=2)
04EE	1262	Line 18	clear=0 set=1 (toggle=2)
04EF	1263	Line 19	clear=0 set=1 (toggle=2)
04F0	1264	Line 20	clear=0 set=1 (toggle=2)
04F1	1265	Line 21	clear=0 set=1 (toggle=2)
04F2	1266	Line 22	clear=0 set=1 (toggle=2)
04F3	1267	Line 23	clear=0 set=1 (toggle=2)
04F8	1272	Line 320	clear=0 set=1 (toggle=2)
04F9	1273	Line 321	clear=0 set=1 (toggle=2)
04FA	1274	Line 322	clear=0 set=1 (toggle=2)
04FB	1275	Line 323	clear=0 set=1 (toggle=2)
04FC	1276	Line 324	clear=0 set=1 (toggle=2)
04FD	1277	Line 325	clear=0 set=1 (toggle=2)
04FE	1278	Line 326	clear=0 set=1 (toggle=2)
04FF	1279	Line 327	clear=0 set=1 (toggle=2)
0500	1280	Line 328	clear=0 set=1 (toggle=2)
0501	1281	Line 329	clear=0 set=1 (toggle=2)
0502	1282	Line 330	clear=0 set=1 (toggle=2)
0503	1283	Line 331	clear=0 set=1 (toggle=2)
0504	1284	Line 332	clear=0 set=1 (toggle=2)
0505	1285	Line 333	clear=0 set=1 (toggle=2)
0506	1286	Line 334	clear=0 set=1 (toggle=2)
0507	1287	Line 335	clear=0 set=1 (toggle=2)
050F	1295	<VI Pass 625>	1=Pass All
0510	1296	<VI Pass 625>	1=Blank All
0511	1297	<VI Pass 525>	1=Pass All
0512	1298	<VI Pass 525>	1=Blank All
057D	1405	525	clear=0 set=1 (toggle=2)
057E	1406	625	clear=0 set=1 (toggle=2)
05D7	1495	RollTrack Index	min=0 max=15 Step=1
05D8	1496	RollTrack Source	min=-1 max=5 Step=1
05D9	1497	RollTrack Address	Edit String
05DA	1498	RollTrack Command	Edit String
05E7	1511	RollTrack Status	Static Display (no control)
05E9	1513	RollTrack Disable	clear=0 set=1 (toggle=2)
05EA	1514	RollTrack Sending	Static Display (no control)
0640	1600	<Memory 1>	1=Save 1
0641	1601	<Memory 1>	1=Recall 1
0642	1602	<Memory 1>	1=Clear 1
0643	1603	Name 1	Edit String
0644	1604	<Memory 2>	1=Save 2
0645	1605	<Memory 2>	1=Recall 2
0646	1606	<Memory 2>	1=Clear 2
0647	1607	Name 2	Edit String
0648	1608	<Memory 3>	1=Save 3
0649	1609	<Memory 3>	1=Recall 3
064A	1610	<Memory 3>	1=Clear 3
064B	1611	Name 3	Edit String
064C	1612	<Memory 4>	1=Save 4
064D	1613	<Memory 4>	1=Recall 4
064E	1614	<Memory 4>	1=Clear 4
064F	1615	Name 4	Edit String
0650	1616	<Memory 5>	1=Save 5
0651	1617	<Memory 5>	1=Recall 5
0652	1618	<Memory 5>	1=Clear 5
0653	1619	Name 5	Edit String
0654	1620	<Memory 6>	1=Save 6
0655	1621	<Memory 6>	1=Recall 6
0656	1622	<Memory 6>	1=Clear 6
0657	1623	Name 6	Edit String
0658	1624	<Memory 7>	1=Save 7
0659	1625	<Memory 7>	1=Recall 7
065A	1626	<Memory 7>	1=Clear 7
065B	1627	Name 7	Edit String
065C	1628	<Memory 8>	1=Save 8

065D	1629	<Memory 8>	1=Recall 8			
065E	1630	<Memory 8>	1=Clear 8			
065F	1631	Name 8	Edit String			
077B	1915	<RETURN>	0=Input Status	1=EDH & ANC Status		
			2=Audio Input Status			
07DB	2011	Input Selection	min=-1	max=12	Step=1	
07DD	2013	<Output Selection>	0=Input Present	1=Standard 625	2=Video	
			Delay	3=Unused		
07DE	2014	GPI/O 1	clear=0	set=1 (toggle=2)		
0800	2048	GPI In Status	Static Display (no control)			
0801	2049	GPI Out Status	Static Display (no control)			
08CB	2251	<RETURN>	0=Input 1 SDI	1=Input 2 SDI		
09B7	2487	Frequency	min=100	max=15000	Step=100	
09B8	2488	Frequency R	min=100	max=15000	Step=100	
09B9	2489	Ident Enable	clear=0	set=1 (toggle=2)		
09D5	2517	Low Level	min=-96	max=0	Step=1	
09D6	2518	Warning Timer	min=1	max=20	Step=1	
09E3	2531	<Pair Selection>	0=Select Pair 1	1=Select Pair 2	2=Select	
			Pair 3	3=Select Pair 4		
			4=Select Pair 5	5=Select Pair 6	6=Select	
			Pair 7	7=Select Pair 8		
09E4	2532	<Pair Selection>	0=Select Pair 1	1=Select Pair 2	2=Select	
			Pair 3	3=Select Pair 4		
			4=Select Pair 5	5=Select Pair 6	6=Select	
			Pair 7	7=Select Pair 8		
09E5	2533	<Pair Selection>	0=Select Pair 1	1=Select Pair 2	2=Select	
			Pair 3	3=Select Pair 4		
			4=Select Pair 5	5=Select Pair 6	6=Select	
			Pair 7	7=Select Pair 8		
09E6	2534	<Pair Selection>	0=Select Pair 1	1=Select Pair 2	2=Select	
			Pair 3	3=Select Pair 4		
			4=Select Pair 5	5=Select Pair 6	6=Select	
			Pair 7	7=Select Pair 8		
09ED	2541	Disable	clear=0	set=1 (toggle=2)		
09EE	2542	Disable	clear=0	set=1 (toggle=2)		
09EF	2543	Disable	clear=0	set=1 (toggle=2)		
09F0	2544	Disable	clear=0	set=1 (toggle=2)		
0A07	2567	Internal	clear=0	set=1 (toggle=2)		
0A08	2568	Manual	clear=0	set=1 (toggle=2)		
0A09	2569	Rolltrack 14	clear=0	set=1 (toggle=2)		
0A0A	2570	Rolltrack 15	clear=0	set=1 (toggle=2)		
0A0B	2571	Rolltrack 16	clear=0	set=1 (toggle=2)		
0A0C	2572	Rolltrack 17	clear=0	set=1 (toggle=2)		
0A0D	2573	Manual Delay	min=-40	max=1500	Step=1	
0A0D	2573	Manual	Static Display (no control)			
0A0E	2574	Internal	Static Display (no control)			
0A2D	2605	Disable Inputs	clear=0	set=1 (toggle=2)		
0A92	2706	Chroma Gain	min=-60	max=60	Step=1	Div=10
			Units=dB			
0A93	2707	Luma Gain	min=-60	max=60	Step=1	Div=10
			Units=dB			
0A94	2708	Black Level	min=-1000	max=1000	Step=8	Div=10
			Units=mV			
0A95	2709	Picture Position	min=-592	max=592	Step=148	
0A96	2710	Chroma Gain	min=-60	max=60	Step=1	Div=10
			Units=dB			
0A97	2711	Luma Gain	min=-60	max=60	Step=1	Div=10
			Units=dB			
0A98	2712	Black Level	min=-1000	max=1000	Step=8	Div=10
			Units=mV			
0A99	2713	Picture Position	min=-592	max=592	Step=148	
0B30	2864	In1 ProcAmp Enable	clear=0	set=1 (toggle=2)		
0B31	2865	In2 ProcAmp Enable	clear=0	set=1 (toggle=2)		
0B36	2870	RollTrack Index	min=0	max=15	Step=1	
0B37	2871	RollTrack Source	min=-1	max=5	Step=1	
0B38	2872	RollTrack Address	Edit String			
0B39	2873	RollTrack Command	Edit String			
0B3B	2875	Input Selection	min=-1	max=12	Step=1	
0B3D	2877	<Output Selection>	0=Input Present	1=Standard 625	2=Video	
			Delay	3=Unused		
0B6B	2923	<RETURN>	0=Input 1 SDI	1=Input 2 SDI	2=Follow	
			Video			
0B6C	2924	Y/C Timing	min=-592	max=592	Step=148	
0B6D	2925	Y/C Timing	min=-592	max=592	Step=148	
0B70	2928	AES 1 Delay	min=0	max=1500	Step=1	
0B71	2929	AES 2 Delay	min=0	max=1500	Step=1	
0B7C	2940	Animated Pattern	clear=0	set=1 (toggle=2)		
0B7D	2941	<Embed 1 Source>	0=BUS A	1=BUS B	2=BUS C	
			3=BUS D			

0B7E 2942 <Embed 2 Source>

4=AES 1 Direct 5=AES 2 Direct 6=Test
tone 7=Silence
0=BUS A 1=BUS B 2=BUS C
3=BUS D
4=AES 1 Direct 5=AES 2 Direct 6=Test
tone 7=Silence

0B7F	2943	<Embed 3 Source>	0=BUS A	1=BUS B	2=BUS C	
			3=BUS D			
			4=AES 1 Direct	5=AES 2 Direct	6=Test	
			tone	7=Silence		
0B80	2944	<Embed 4 Source>	0=BUS A	1=BUS B	2=BUS C	
			3=BUS D			
			4=AES 1 Direct	5=AES 2 Direct	6=Test	
			tone	7=Silence		
0B9B	2971	Hanc Blank	clear=0	set=1 (toggle=2)		
0B9C	2972	<Slew Rate>	0=Instant	1=Fast	2=Medium	
			3=Slow			
			4=Slowest			
0B9D	2973	<RETURN>	0=0 Frame Delay	1=1 Frame Delay	2=2	
			Frame Delay			
0B9E	2974	625 H Phase	min=0	max=63962899	Step=37037	Div=1000
0B9F	2975	625 V Phase	min=0	max=624	Step=1	
0BA0	2976	525 H Phase	min=0	max=63518455	Step=37037	Div=1000
0BA1	2977	525 V Phase	min=0	max=524	Step=1	
0BA2	2978	<RETURN>				
			1=Reset Errors			
0BA3	2979	Total Delay Display	Static Display	(no control)		
0BA4	2980	INPUT=	Static Display	(no control)		
0BA5	2981	STD=	Static Display	(no control)		
0BA6	2982	INPUT1=	Static Display	(no control)		
0BA7	2983	STD1=	Static Display	(no control)		
0BA8	2984	INPUT2=	Static Display	(no control)		
0BA9	2985	STD2=	Static Display	(no control)		
0BAB	2987	EDH=	Static Display	(no control)		
0BAC	2988	ERRSEC=	Static Display	(no control)		
0BAD	2989	ROLLTRACK=	Static Display	(no control)		
0BAE	2990	FAULT=	Static Display	(no control)		
0BB2	2994	AES1=	Static Display	(no control)		
0BB3	2995	AES2=	Static Display	(no control)		
0BB6	2998	BUSAL=	Static Display	(no control)		
0BB7	2999	BUSAR=	Static Display	(no control)		
0BB8	3000	BUSBL=	Static Display	(no control)		
0BB9	3001	BUSBR=	Static Display	(no control)		
0BBA	3002	BUSCL=	Static Display	(no control)		
0BBB	3003	BUSCR=	Static Display	(no control)		
0BBC	3004	BUSDL=	Static Display	(no control)		
0BBD	3005	BUSDR=	Static Display	(no control)		
0BC6	3014	DEEMBED1=	Static Display	(no control)		
0BC7	3015	DEEMBED2=	Static Display	(no control)		
0BC8	3016	DEEMBED3=	Static Display	(no control)		
0BC9	3017	DEEMBED4=	Static Display	(no control)		
0BCA	3018	DEEMBED5=	Static Display	(no control)		
0BCB	3019	DEEMBED6=	Static Display	(no control)		
0BCC	3020	DEEMBED7=	Static Display	(no control)		
0BCD	3021	DEEMBED8=	Static Display	(no control)		
0BCE	3022	NPCM1=	Static Display	(no control)		
0BCF	3023	NPCM2=	Static Display	(no control)		
0BD0	3024	NPCM3=	Static Display	(no control)		
0BD1	3025	NPCM4=	Static Display	(no control)		
0BD2	3026	NPCM5=	Static Display	(no control)		
0BD3	3027	NPCM6=	Static Display	(no control)		
0BD4	3028	NPCM7=	Static Display	(no control)		
0BD5	3029	NPCM8=	Static Display	(no control)		
0BEB	3051	GPI Delay Select	clear=0	set=1 (toggle=2)		
0BEC	3052	GPI Delay Display	Static Display	(no control)		
0BED	3053	InputTimer Enable	clear=0	set=1 (toggle=2)		
0BEE	3054	TimerActive High	clear=0	set=1 (toggle=2)		
0BEF	3055	HeadRoom	min=4	max=24	Step=1	
0BF0	3056	Silence Level	min=-96	max=0	Step=1	
0BF1	3057	High Level	min=-96	max=0	Step=1	
0BF2	3058	Overload Level	min=-96	max=0	Step=1	
0BF4	3060	Channel Status	Edit String			
0C08	3080	Gain Bus AL	min=-180	max=180	Step=1	Div=10
0C09	3081	Gain Bus AR	min=-180	max=180	Step=1	Div=10
0C0A	3082	Gain Bus BL	min=-180	max=180	Step=1	Div=10
0C0B	3083	Gain Bus BR	min=-180	max=180	Step=1	Div=10
0C0C	3084	Gain Bus CL	min=-180	max=180	Step=1	Div=10
0C0D	3085	Gain Bus CR	min=-180	max=180	Step=1	Div=10
0C0E	3086	Gain Bus DL	min=-180	max=180	Step=1	Div=10
0C0F	3087	Gain Bus DR	min=-180	max=180	Step=1	Div=10
0C10	3088	Gain De-embed 1L	min=-180	max=180	Step=1	Div=10
0C11	3089	Gain De-embed 1R	min=-180	max=180	Step=1	Div=10
0C12	3090	Gain De-embed 2L	min=-180	max=180	Step=1	Div=10
0C13	3091	Gain De-embed 2R	min=-180	max=180	Step=1	Div=10
0C14	3092	Gain De-embed 3L	min=-180	max=180	Step=1	Div=10
0C15	3093	Gain De-embed 3R	min=-180	max=180	Step=1	Div=10
0C16	3094	Gain De-embed 4L	min=-180	max=180	Step=1	Div=10

0C17	3095	Gain De-embed 4R	min=-180	max=180	Step=1	Div=10
0C18	3096	Gain De-embed 5L	min=-180	max=180	Step=1	Div=10
0C19	3097	Gain De-embed 5R	min=-180	max=180	Step=1	Div=10
0C1A	3098	Gain De-embed 6L	min=-180	max=180	Step=1	Div=10
0C1B	3099	Gain De-embed 6R	min=-180	max=180	Step=1	Div=10
0C1C	3100	Gain De-embed 7L	min=-180	max=180	Step=1	Div=10
0C1D	3101	Gain De-embed 7R	min=-180	max=180	Step=1	Div=10
0C1E	3102	Gain De-embed 8L	min=-180	max=180	Step=1	Div=10
0C1F	3103	Gain De-embed 8R	min=-180	max=180	Step=1	Div=10
0C20	3104	Gain AES 1L	min=-180	max=180	Step=1	Div=10
0C21	3105	Gain AES 1R	min=-180	max=180	Step=1	Div=10
0C22	3106	Gain AES 2L	min=-180	max=180	Step=1	Div=10
0C23	3107	Gain AES 2R	min=-180	max=180	Step=1	Div=10
0C58	3160	Invert	clear=0	set=1 (toggle=2)		
0C59	3161	Invert	clear=0	set=1 (toggle=2)		
0C5A	3162	Invert	clear=0	set=1 (toggle=2)		
0C5B	3163	Invert	clear=0	set=1 (toggle=2)		
0C5C	3164	Invert	clear=0	set=1 (toggle=2)		
0C5D	3165	Invert	clear=0	set=1 (toggle=2)		
0C5E	3166	Invert	clear=0	set=1 (toggle=2)		
0C5F	3167	Invert	clear=0	set=1 (toggle=2)		
0C60	3168	Invert	clear=0	set=1 (toggle=2)		
0C61	3169	Invert	clear=0	set=1 (toggle=2)		
0C62	3170	Invert	clear=0	set=1 (toggle=2)		
0C63	3171	Invert	clear=0	set=1 (toggle=2)		
0C64	3172	Invert	clear=0	set=1 (toggle=2)		
0C65	3173	Invert	clear=0	set=1 (toggle=2)		
0C66	3174	Invert	clear=0	set=1 (toggle=2)		
0C67	3175	Invert	clear=0	set=1 (toggle=2)		
0C68	3176	Invert	clear=0	set=1 (toggle=2)		
0C69	3177	Invert	clear=0	set=1 (toggle=2)		
0C6A	3178	Invert	clear=0	set=1 (toggle=2)		
0C6B	3179	Invert	clear=0	set=1 (toggle=2)		
0C6C	3180	Invert	clear=0	set=1 (toggle=2)		
0C6D	3181	Invert	clear=0	set=1 (toggle=2)		
0C6E	3182	Invert	clear=0	set=1 (toggle=2)		
0C6F	3183	Invert	clear=0	set=1 (toggle=2)		
0C70	3184	Invert	clear=0	set=1 (toggle=2)		
0C71	3185	Invert	clear=0	set=1 (toggle=2)		
0C72	3186	Invert	clear=0	set=1 (toggle=2)		
0C73	3187	Invert	clear=0	set=1 (toggle=2)		
0CA8	3240	Mute	clear=0	set=1 (toggle=2)		
0CA9	3241	Mute	clear=0	set=1 (toggle=2)		
0CAA	3242	Mute	clear=0	set=1 (toggle=2)		
0CAB	3243	Mute	clear=0	set=1 (toggle=2)		
0CAC	3244	Mute	clear=0	set=1 (toggle=2)		
0CAD	3245	Mute	clear=0	set=1 (toggle=2)		
0CAE	3246	Mute	clear=0	set=1 (toggle=2)		
0CAF	3247	Mute	clear=0	set=1 (toggle=2)		
0CB0	3248	Mute	clear=0	set=1 (toggle=2)		
0CB1	3249	Mute	clear=0	set=1 (toggle=2)		
0CB2	3250	Mute	clear=0	set=1 (toggle=2)		
0CB3	3251	Mute	clear=0	set=1 (toggle=2)		
0CB4	3252	Mute	clear=0	set=1 (toggle=2)		
0CB5	3253	Mute	clear=0	set=1 (toggle=2)		
0CB6	3254	Mute	clear=0	set=1 (toggle=2)		
0CB7	3255	Mute	clear=0	set=1 (toggle=2)		
0CB8	3256	Mute	clear=0	set=1 (toggle=2)		
0CB9	3257	Mute	clear=0	set=1 (toggle=2)		
0CBA	3258	Mute	clear=0	set=1 (toggle=2)		
0CBB	3259	Mute	clear=0	set=1 (toggle=2)		
0CBC	3260	Mute	clear=0	set=1 (toggle=2)		
0CBD	3261	Mute	clear=0	set=1 (toggle=2)		
0CBE	3262	Mute	clear=0	set=1 (toggle=2)		
0CBF	3263	Mute	clear=0	set=1 (toggle=2)		
0CC0	3264	Mute	clear=0	set=1 (toggle=2)		
0CC1	3265	Mute	clear=0	set=1 (toggle=2)		
0CC2	3266	Mute	clear=0	set=1 (toggle=2)		
0CC3	3267	Mute	clear=0	set=1 (toggle=2)		
0CF8	3320	Stereo A	clear=0	set=1 (toggle=2)		
0CF9	3321	Stereo B	clear=0	set=1 (toggle=2)		
0CFA	3322	Stereo C	clear=0	set=1 (toggle=2)		
0CFB	3323	Stereo D	clear=0	set=1 (toggle=2)		
0CFC	3324	Stereo 1	clear=0	set=1 (toggle=2)		
0CFD	3325	Stereo 2	clear=0	set=1 (toggle=2)		
0CFE	3326	Stereo 3	clear=0	set=1 (toggle=2)		
0CFF	3327	Stereo 4	clear=0	set=1 (toggle=2)		
0D00	3328	Stereo 5	clear=0	set=1 (toggle=2)		
0D01	3329	Stereo 6	clear=0	set=1 (toggle=2)		
0D02	3330	Stereo 7	clear=0	set=1 (toggle=2)		

```

0D03  3331  Stereo  8          clear=0 set=1 (toggle=2)
0D04  3332  Stereo  1          clear=0 set=1 (toggle=2)
0D05  3333  Stereo  2          clear=0 set=1 (toggle=2)
0D20  3360  Gain1   8          min=-71 max=0 Step=1
0D21  3361  Gain2   8          min=-71 max=0 Step=1
0D22  3362  Gain3   8          min=-71 max=0 Step=1
0D23  3363  Gain4   8          min=-71 max=0 Step=1
0D24  3364  Gain1   8          min=-71 max=0 Step=1
0D25  3365  Gain2   8          min=-71 max=0 Step=1
0D26  3366  Gain3   8          min=-71 max=0 Step=1
0D27  3367  Gain4   8          min=-71 max=0 Step=1
0D28  3368  Gain1   8          min=-71 max=0 Step=1
0D29  3369  Gain2   8          min=-71 max=0 Step=1
0D2A  3370  Gain3   8          min=-71 max=0 Step=1
0D2B  3371  Gain4   8          min=-71 max=0 Step=1
0D2C  3372  Gain1   8          min=-71 max=0 Step=1
0D2D  3373  Gain2   8          min=-71 max=0 Step=1
0D2E  3374  Gain3   8          min=-71 max=0 Step=1
0D2F  3375  Gain4   8          min=-71 max=0 Step=1
0D70  3440  <RETURN>
          0=DeEmbed 1L    1=DeEmbed 1R    2=DeEmbed 2L
          3=DeEmbed 2R
          4=DeEmbed 3L    5=DeEmbed 3R    6=DeEmbed 4L
          7=DeEmbed 4R
          8=DeEmbed 5L    9=DeEmbed 5R   10=DeEmbed 6L
          11=DeEmbed 6R
          12=DeEmbed 7L   13=DeEmbed 7R   14=DeEmbed 8L
          15=DeEmbed 8R
          16=AES 1L      17=AES 1R      18=AES 2L
          19=AES 2R
0D71  3441  <RETURN>
          0=DeEmbed 1L    1=DeEmbed 1R    2=DeEmbed 2L
          3=DeEmbed 2R
          4=DeEmbed 3L    5=DeEmbed 3R    6=DeEmbed 4L
          7=DeEmbed 4R
          8=DeEmbed 5L    9=DeEmbed 5R   10=DeEmbed 6L
          11=DeEmbed 6R
          12=DeEmbed 7L   13=DeEmbed 7R   14=DeEmbed 8L
          15=DeEmbed 8R
          16=AES 1L      17=AES 1R      18=AES 2L
          19=AES 2R
0D72  3442  <RETURN>
          0=DeEmbed 1L    1=DeEmbed 1R    2=DeEmbed 2L
          3=DeEmbed 2R
          4=DeEmbed 3L    5=DeEmbed 3R    6=DeEmbed 4L
          7=DeEmbed 4R
          8=DeEmbed 5L    9=DeEmbed 5R   10=DeEmbed 6L
          11=DeEmbed 6R
          12=DeEmbed 7L   13=DeEmbed 7R   14=DeEmbed 8L
          15=DeEmbed 8R
          16=AES 1L      17=AES 1R      18=AES 2L
          19=AES 2R
0D73  3443  <RETURN>
          0=DeEmbed 1L    1=DeEmbed 1R    2=DeEmbed 2L
          3=DeEmbed 2R
          4=DeEmbed 3L    5=DeEmbed 3R    6=DeEmbed 4L
          7=DeEmbed 4R
          8=DeEmbed 5L    9=DeEmbed 5R   10=DeEmbed 6L
          11=DeEmbed 6R
          12=DeEmbed 7L   13=DeEmbed 7R   14=DeEmbed 8L
          15=DeEmbed 8R
          16=AES 1L      17=AES 1R      18=AES 2L
          19=AES 2R
0D74  3444  <RETURN>
          0=DeEmbed 1L    1=DeEmbed 1R    2=DeEmbed 2L
          3=DeEmbed 2R
          4=DeEmbed 3L    5=DeEmbed 3R    6=DeEmbed 4L
          7=DeEmbed 4R
          8=DeEmbed 5L    9=DeEmbed 5R   10=DeEmbed 6L
          11=DeEmbed 6R
          12=DeEmbed 7L   13=DeEmbed 7R   14=DeEmbed 8L
          15=DeEmbed 8R
          16=AES 1L      17=AES 1R      18=AES 2L
          19=AES 2R
0D75  3445  <RETURN>
          0=DeEmbed 1L    1=DeEmbed 1R    2=DeEmbed 2L
          3=DeEmbed 2R
          4=DeEmbed 3L    5=DeEmbed 3R    6=DeEmbed 4L
          7=DeEmbed 4R
          8=DeEmbed 5L    9=DeEmbed 5R   10=DeEmbed 6L
          11=DeEmbed 6R
          12=DeEmbed 7L   13=DeEmbed 7R   14=DeEmbed 8L
          15=DeEmbed 8R
          16=AES 1L      17=AES 1R      18=AES 2L
          19=AES 2R

```

0D76	3446	<RETURN>	0=DeEmbed 1L	1=DeEmbed 1R	2=DeEmbed 2L
			3=DeEmbed 2R		
			4=DeEmbed 3L	5=DeEmbed 3R	6=DeEmbed 4L
			7=DeEmbed 4R		
			8=DeEmbed 5L	9=DeEmbed 5R	10=DeEmbed 6L
			11=DeEmbed 6R		
			12=DeEmbed 7L	13=DeEmbed 7R	14=DeEmbed 8L
			15=DeEmbed 8R		
			16=AES 1L	17=AES 1R	18=AES 2L
			19=AES 2R		
0D77	3447	<RETURN>	0=DeEmbed 1L	1=DeEmbed 1R	2=DeEmbed 2L
			3=DeEmbed 2R		
			4=DeEmbed 3L	5=DeEmbed 3R	6=DeEmbed 4L
			7=DeEmbed 4R		
			8=DeEmbed 5L	9=DeEmbed 5R	10=DeEmbed 6L
			11=DeEmbed 6R		
			12=DeEmbed 7L	13=DeEmbed 7R	14=DeEmbed 8L
			15=DeEmbed 8R		
			16=AES 1L	17=AES 1R	18=AES 2L
			19=AES 2R		
0D78	3448	<RETURN>	0=DeEmbed 1L	1=DeEmbed 1R	2=DeEmbed 2L
			3=DeEmbed 2R		
			4=DeEmbed 3L	5=DeEmbed 3R	6=DeEmbed 4L
			7=DeEmbed 4R		
			8=DeEmbed 5L	9=DeEmbed 5R	10=DeEmbed 6L
			11=DeEmbed 6R		
			12=DeEmbed 7L	13=DeEmbed 7R	14=DeEmbed 8L
			15=DeEmbed 8R		
			16=AES 1L	17=AES 1R	18=AES 2L
			19=AES 2R		
0D79	3449	<RETURN>	0=DeEmbed 1L	1=DeEmbed 1R	2=DeEmbed 2L
			3=DeEmbed 2R		
			4=DeEmbed 3L	5=DeEmbed 3R	6=DeEmbed 4L
			7=DeEmbed 4R		
			8=DeEmbed 5L	9=DeEmbed 5R	10=DeEmbed 6L
			11=DeEmbed 6R		
			12=DeEmbed 7L	13=DeEmbed 7R	14=DeEmbed 8L
			15=DeEmbed 8R		
			16=AES 1L	17=AES 1R	18=AES 2L
			19=AES 2R		
0D7A	3450	<RETURN>	0=DeEmbed 1L	1=DeEmbed 1R	2=DeEmbed 2L
			3=DeEmbed 2R		
			4=DeEmbed 3L	5=DeEmbed 3R	6=DeEmbed 4L
			7=DeEmbed 4R		
			8=DeEmbed 5L	9=DeEmbed 5R	10=DeEmbed 6L
			11=DeEmbed 6R		
			12=DeEmbed 7L	13=DeEmbed 7R	14=DeEmbed 8L
			15=DeEmbed 8R		
			16=AES 1L	17=AES 1R	18=AES 2L
			19=AES 2R		
0D7B	3451	<RETURN>	0=DeEmbed 1L	1=DeEmbed 1R	2=DeEmbed 2L
			3=DeEmbed 2R		
			4=DeEmbed 3L	5=DeEmbed 3R	6=DeEmbed 4L
			7=DeEmbed 4R		
			8=DeEmbed 5L	9=DeEmbed 5R	10=DeEmbed 6L
			11=DeEmbed 6R		
			12=DeEmbed 7L	13=DeEmbed 7R	14=DeEmbed 8L
			15=DeEmbed 8R		
			16=AES 1L	17=AES 1R	18=AES 2L
			19=AES 2R		
0D7C	3452	<RETURN>	0=DeEmbed 1L	1=DeEmbed 1R	2=DeEmbed 2L
			3=DeEmbed 2R		
			4=DeEmbed 3L	5=DeEmbed 3R	6=DeEmbed 4L
			7=DeEmbed 4R		
			8=DeEmbed 5L	9=DeEmbed 5R	10=DeEmbed 6L
			11=DeEmbed 6R		
			12=DeEmbed 7L	13=DeEmbed 7R	14=DeEmbed 8L
			15=DeEmbed 8R		
			16=AES 1L	17=AES 1R	18=AES 2L
			19=AES 2R		
0D7D	3453	<RETURN>	0=DeEmbed 1L	1=DeEmbed 1R	2=DeEmbed 2L
			3=DeEmbed 2R		
			4=DeEmbed 3L	5=DeEmbed 3R	6=DeEmbed 4L
			7=DeEmbed 4R		
			8=DeEmbed 5L	9=DeEmbed 5R	10=DeEmbed 6L
			11=DeEmbed 6R		
			12=DeEmbed 7L	13=DeEmbed 7R	14=DeEmbed 8L
			15=DeEmbed 8R		
			16=AES 1L	17=AES 1R	18=AES 2L
			19=AES 2R		

0D7E	3454	<RETURN>	0=DeEmbed 1L 3=DeEmbed 2R 4=DeEmbed 3L 7=DeEmbed 4R 8=DeEmbed 5L 11=DeEmbed 6R 12=DeEmbed 7L 15=DeEmbed 8R 16=AES 1L 19=AES 2R	1=DeEmbed 1R 5=DeEmbed 3R 9=DeEmbed 5R 13=DeEmbed 7R 17=AES 1R	2=DeEmbed 2L 6=DeEmbed 4L 10=DeEmbed 6L 14=DeEmbed 8L 18=AES 2L
0D7F	3455	<RETURN>	0=DeEmbed 1L 3=DeEmbed 2R 4=DeEmbed 3L 7=DeEmbed 4R 8=DeEmbed 5L 11=DeEmbed 6R 12=DeEmbed 7L 15=DeEmbed 8R 16=AES 1L 19=AES 2R	1=DeEmbed 1R 5=DeEmbed 3R 9=DeEmbed 5R 13=DeEmbed 7R 17=AES 1R	2=DeEmbed 2L 6=DeEmbed 4L 10=DeEmbed 6L 14=DeEmbed 8L 18=AES 2L
ODC0	3520	<RETURN>	0=DeEmbed 1L 3=DeEmbed 2R 4=DeEmbed 3L 7=DeEmbed 4R 8=DeEmbed 5L 11=DeEmbed 6R 12=DeEmbed 7L 15=DeEmbed 8R 16=AES 1L 19=AES 2R 20=MIX 1 23=MIX 4	1=DeEmbed 1R 5=DeEmbed 3R 9=DeEmbed 5R 13=DeEmbed 7R 17=AES 1R 21=MIX 2	2=DeEmbed 2L 6=DeEmbed 4L 10=DeEmbed 6L 14=DeEmbed 8L 18=AES 2L 22=MIX 3
ODC1	3521	<RETURN>	0=DeEmbed 1L 3=DeEmbed 2R 4=DeEmbed 3L 7=DeEmbed 4R 8=DeEmbed 5L 11=DeEmbed 6R 12=DeEmbed 7L 15=DeEmbed 8R 16=AES 1L 19=AES 2R 20=MIX 1 23=MIX 4	1=DeEmbed 1R 5=DeEmbed 3R 9=DeEmbed 5R 13=DeEmbed 7R 17=AES 1R 21=MIX 2	2=DeEmbed 2L 6=DeEmbed 4L 10=DeEmbed 6L 14=DeEmbed 8L 18=AES 2L 22=MIX 3
ODC2	3522	<RETURN>	0=DeEmbed 1L 3=DeEmbed 2R 4=DeEmbed 3L 7=DeEmbed 4R 8=DeEmbed 5L 11=DeEmbed 6R 12=DeEmbed 7L 15=DeEmbed 8R 16=AES 1L 19=AES 2R 20=MIX 1 23=MIX 4	1=DeEmbed 1R 5=DeEmbed 3R 9=DeEmbed 5R 13=DeEmbed 7R 17=AES 1R 21=MIX 2	2=DeEmbed 2L 6=DeEmbed 4L 10=DeEmbed 6L 14=DeEmbed 8L 18=AES 2L 22=MIX 3
ODC3	3523	<RETURN>	0=DeEmbed 1L 3=DeEmbed 2R 4=DeEmbed 3L 7=DeEmbed 4R 8=DeEmbed 5L 11=DeEmbed 6R 12=DeEmbed 7L 15=DeEmbed 8R 16=AES 1L 19=AES 2R 20=MIX 1 23=MIX 4	1=DeEmbed 1R 5=DeEmbed 3R 9=DeEmbed 5R 13=DeEmbed 7R 17=AES 1R 21=MIX 2	2=DeEmbed 2L 6=DeEmbed 4L 10=DeEmbed 6L 14=DeEmbed 8L 18=AES 2L 22=MIX 3
ODC4	3524	<RETURN>	0=DeEmbed 1L 3=DeEmbed 2R 4=DeEmbed 3L 7=DeEmbed 4R 8=DeEmbed 5L 11=DeEmbed 6R 12=DeEmbed 7L 15=DeEmbed 8R 16=AES 1L 19=AES 2R 20=MIX 1 23=MIX 4	1=DeEmbed 1R 5=DeEmbed 3R 9=DeEmbed 5R 13=DeEmbed 7R 17=AES 1R 21=MIX 2	2=DeEmbed 2L 6=DeEmbed 4L 10=DeEmbed 6L 14=DeEmbed 8L 18=AES 2L 22=MIX 3

0DC5	3525	<RETURN>	0=DeEmbed 1L	1=DeEmbed 1R	2=DeEmbed 2L
			3=DeEmbed 2R		
			4=DeEmbed 3L	5=DeEmbed 3R	6=DeEmbed 4L
			7=DeEmbed 4R		
			8=DeEmbed 5L	9=DeEmbed 5R	10=DeEmbed 6L
			11=DeEmbed 6R		
			12=DeEmbed 7L	13=DeEmbed 7R	14=DeEmbed 8L
			15=DeEmbed 8R		
			16=AES 1L	17=AES 1R	18=AES 2L
			19=AES 2R		
			20=MIX 1	21=MIX 2	22=MIX 3
			23=MIX 4		
0DC6	3526	<RETURN>	0=DeEmbed 1L	1=DeEmbed 1R	2=DeEmbed 2L
			3=DeEmbed 2R		
			4=DeEmbed 3L	5=DeEmbed 3R	6=DeEmbed 4L
			7=DeEmbed 4R		
			8=DeEmbed 5L	9=DeEmbed 5R	10=DeEmbed 6L
			11=DeEmbed 6R		
			12=DeEmbed 7L	13=DeEmbed 7R	14=DeEmbed 8L
			15=DeEmbed 8R		
			16=AES 1L	17=AES 1R	18=AES 2L
			19=AES 2R		
			20=MIX 1	21=MIX 2	22=MIX 3
			23=MIX 4		
0DC7	3527	<RETURN>	0=DeEmbed 1L	1=DeEmbed 1R	2=DeEmbed 2L
			3=DeEmbed 2R		
			4=DeEmbed 3L	5=DeEmbed 3R	6=DeEmbed 4L
			7=DeEmbed 4R		
			8=DeEmbed 5L	9=DeEmbed 5R	10=DeEmbed 6L
			11=DeEmbed 6R		
			12=DeEmbed 7L	13=DeEmbed 7R	14=DeEmbed 8L
			15=DeEmbed 8R		
			16=AES 1L	17=AES 1R	18=AES 2L
			19=AES 2R		
			20=MIX 1	21=MIX 2	22=MIX 3
			23=MIX 4		
0DD4	3540	Out Active High	clear=0 set=1 (toggle=2)		
0E06	3590	VFLAG Optional Blanking Data	1=Optional Blanking Data	0=Optional Video Data	

RollTrack Audio Delay Tracking

RollTrack is a feature of RollCall™ (Snell & Wilcox's proprietary remote control system), that allows devices to communicate across the RollCall network with no direct user intervention.

RollTrack Audio Delay Tracking enables Snell & Wilcox RollCall™ compatible audio delay products to track delay introduced by RollCall™ compatible video processing products.

The current products that implement RollTrack Audio Delay Tracking are:

Audio Delay Modules	Video Modules	Other Products	
IQBAAD	IQD1FSY	ALCHEMIST	MDD3000
IQBADC	IQDMSDS	CPP100	MDD550
IQBDAC	IQDAFS	CPP200	MDD560
IQBDAD	IQDMSDS	NRS500	MDD570
IQBSYN	IQDMSDP	HD5050	MDD2000
IQBADCD	IQDSYN		

The simplest configuration is a single video unit and a single audio delay in a RollCall™ system. The audio delay will have the same delay as through the video path. If the delay changes the audio delay will track.

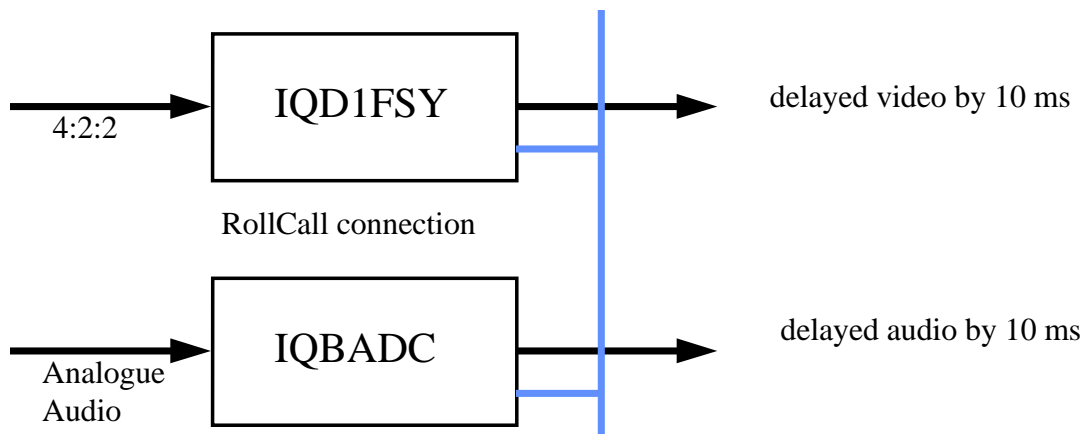

The next level of configuration is where there are multiple Frame Synchronizers (for example) each connected through RollCall™ to their own tracking Audio Delay. (It is worth stating that the synchronizers and audio delays do not have to be in the same enclosure; the addressing scheme, discussed later, allows for the units to be positioned anywhere in the RollCall™ domain.)

The maximum number of video units and audio delays in a RollCall™ system is set by the maximum limit of the number of modules in a RollCall™ network and is currently 3840 on a single network without bridges.

The unique identification of the destination unit (a decimal number) for various modules is as follows:

Module	ID
IQBADC	51
IQBDAC	52
IQBAAD	53
IQBDAD	54
IQBSYN	89
IQBADCD	107

The next level of complexity is a *vertical delay cluster* where a video unit can have up to eight audio delays tracking - of the same or different types.

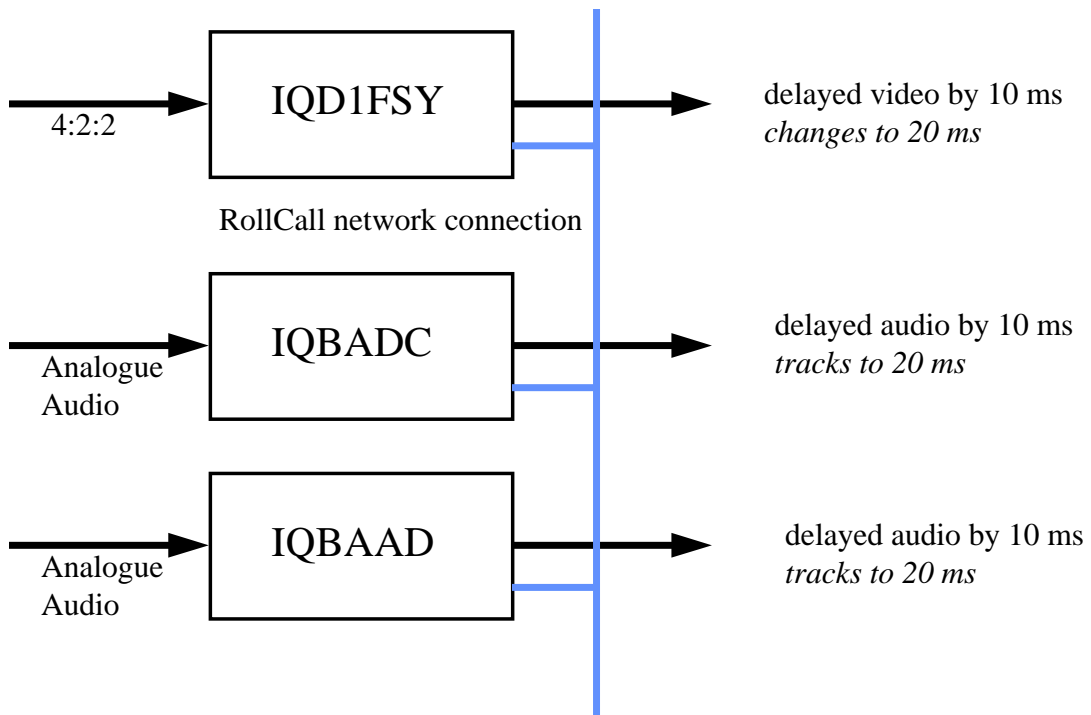

From one to eight audio delay products can be connected via RollCall™ to a single frame synchronizer, for example. If the synchronizer delay changes, then however many audio delays are connected will track the delay. The audio delays can also have a manual delay which will be added to the RollTrack delay.

The next level of complexity is a *horizontal delay cluster* where an audio delay can track up to four video units.

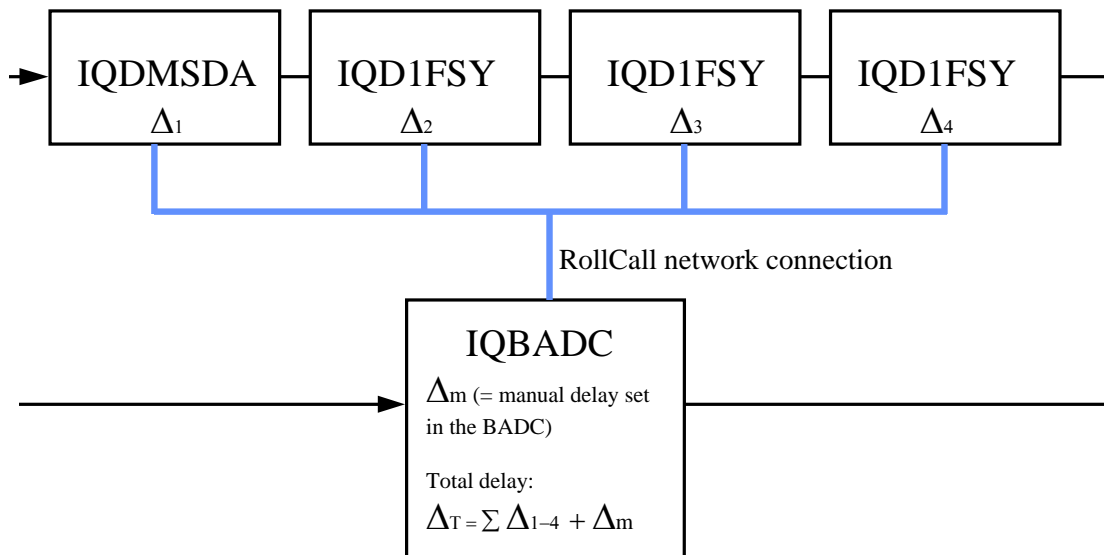

The total delay time through the audio delay is then the sum of the individual delays introduced by the video units plus the manual delay of the audio unit. The manual delay can be set to compensate for any fixed propagation delay in the video path or may be set to zero.

The next level of complexity is a *matrix delay cluster* where each audio delay (up to eight) can track up to four video units. This configuration is in effect a four by eight matrix of video units and audio delay units. The total delay time through the audio delay units is then the sum of the individual delays introduced by the video units plus the manual delay of the audio unit.

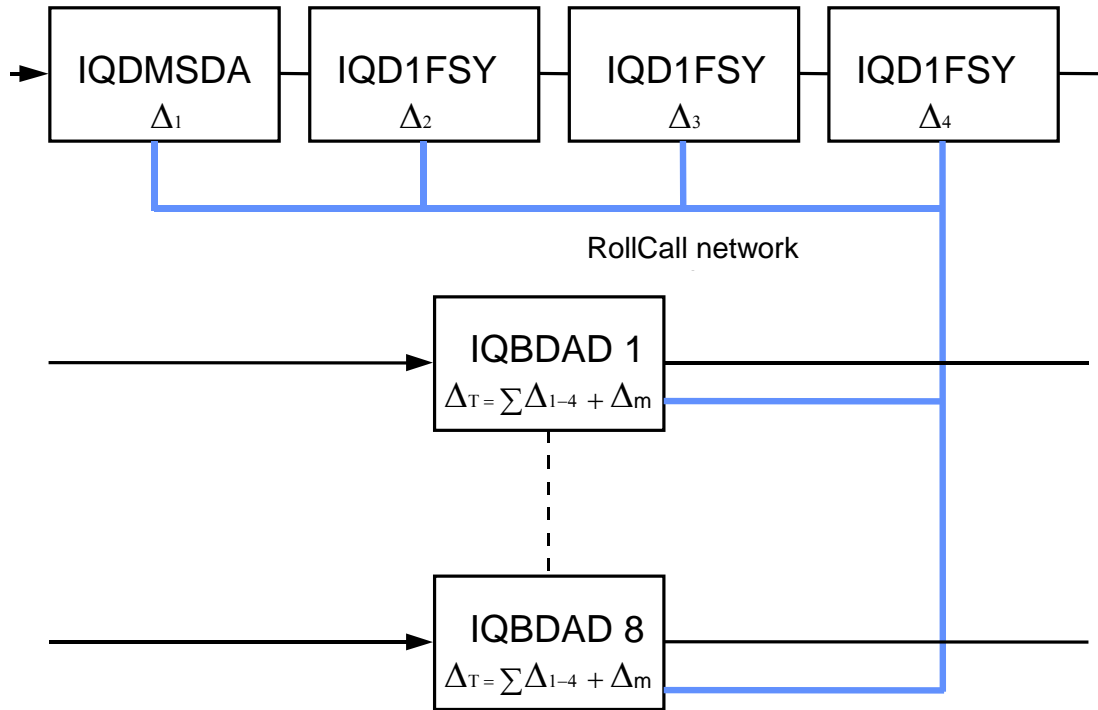

As any of the delay times change in the video path so will the audio delay time track this delay. A virtual connection is made between from, say, an IQD1FSY to an IQBDAD by:

- selecting the *Setup...* Menu of the IQD1FSY
- then selecting the *Audio_Delay...* Menu
- then choosing from *Unit_1* to *Unit_8*
- then entering the unique network address of the IQBDAD in the form *nnnn:xx:yy*z*d*
- where *nnnn* = network address and in most cases will be 0000(hex);
- xx* = IQ enclosure address (hex);
- yy* = slot address of the IQBDAD (hex)
- z* = the connection (or channel) number (decimal) - see table below.
- d* = the unique identification of the destination unit (decimal) The ID entered must match

the

receiving units own ID or else the command will be ignored. If the ID value is set to 00, the receiving unit does not perform an ID match and will always accept the incoming command

- then selecting the *Delay...* Menu of the IQBDAD
- then selecting *RollTrack*

Example of Network Addresses with Channel Numbers and ID Numbers

	D1FSY 1	D1FSY 2	D1FSY 3	D1FSY 4
Audio delay 1	0000:10:01*14*54	0000:10:01*15*54	0000:10:01*16*54	0000:10:01*17*54
Audio delay 2	0000:10:03*14*54	0000:10:03*15*54	0000:10:03*16*54	0000:10:03*17*54
Audio delay 3	0000:10:05*14*54	0000:10:05*15*54	0000:10:05*16*54	0000:10:05*17*54
Audio delay 4	0000:10:07*14*54	0000:10:07*15*54	0000:10:07*16*54	0000:10:07*17*54
Audio delay 5	0000:10:09*14*54	0000:10:09*15*54	0000:10:09*16*54	0000:10:09*17*54
Audio delay 6	0000:10:0B*14*54	0000:10:0B*15*54	0000:10:0B*16*54	0000:10:0B*17*54
Audio delay 7	0000:10:0D*14*54	0000:10:0D*15*54	0000:10:0D*16*54	0000:10:0D*17*54
Audio delay 8	0000:10:0F*14*54	0000:10:0F*15*54	0000:10:0F*16*54	0000:10:0F*17*54

The most complex system would be an array of matrix delay clusters

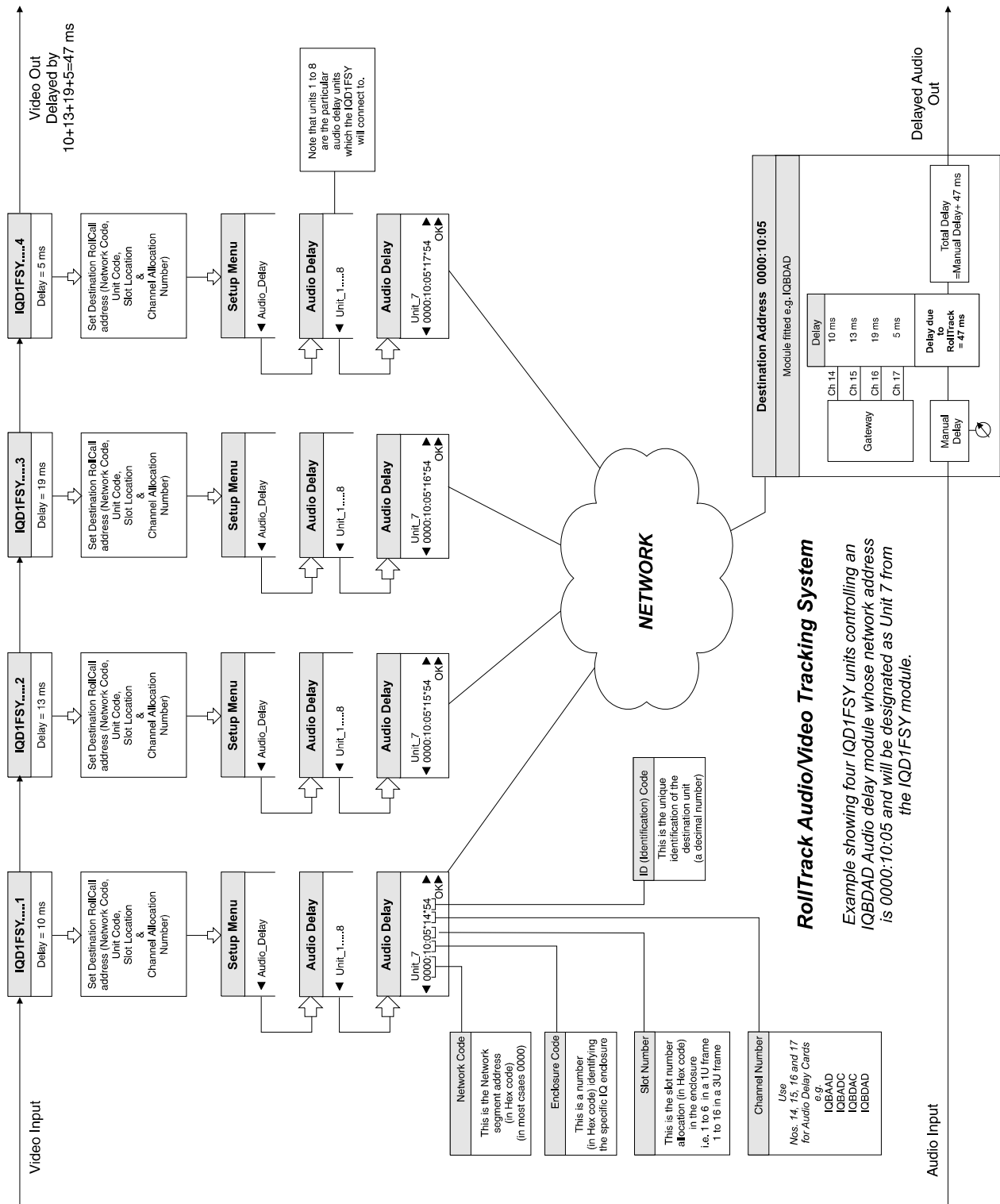

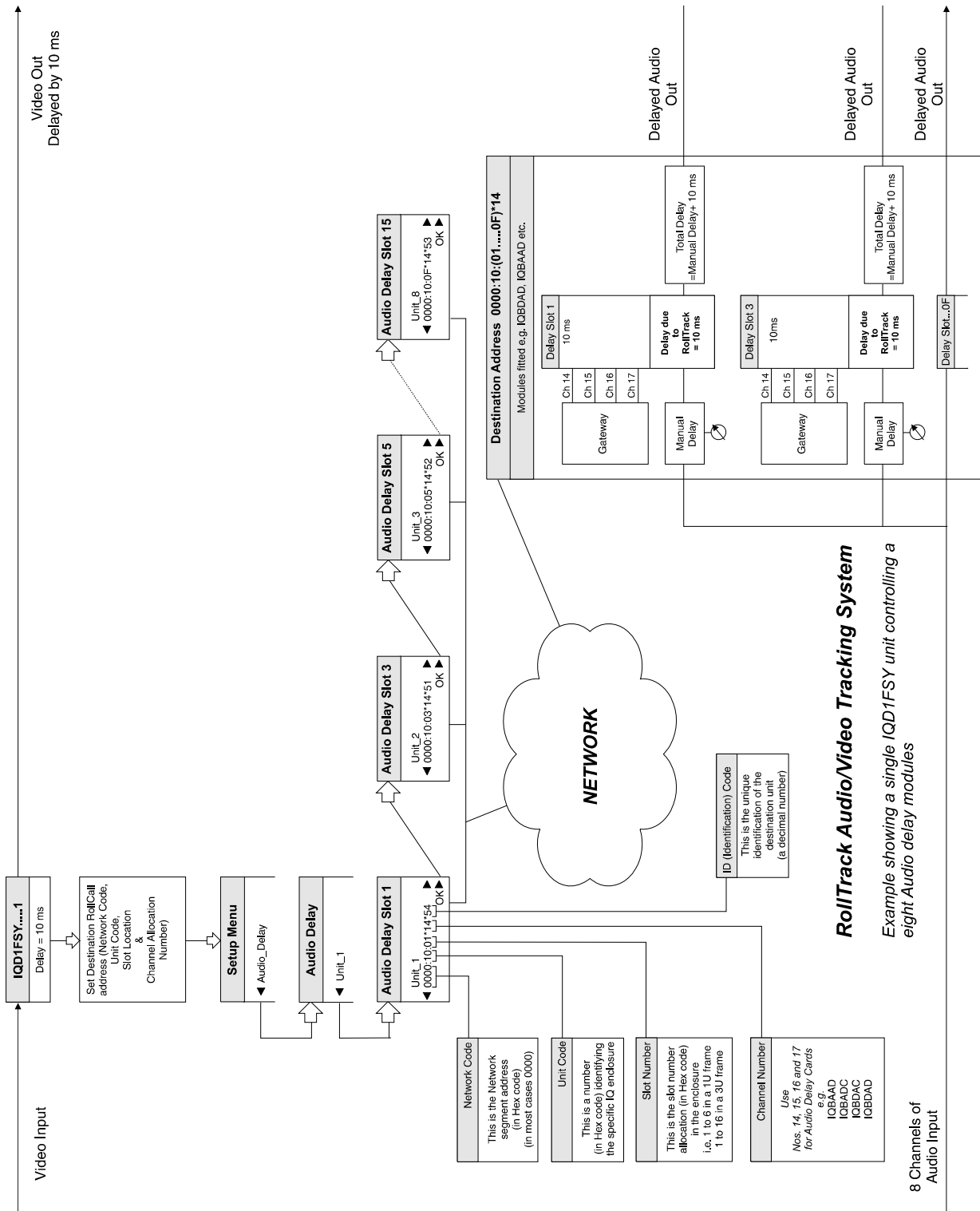

Appendix 2

HANC & Embedding

HANC Data Handling and Embedding Functionality

Audio Embedding Packet Distribution

625

Lines 5, 7, 318, 320
Have no introduced samples on them

Lines 4, 6, 9,10, 11,13, 26, 39, 52, 65, 78, 91, 104, 117, 130, 143, 156, 169, 182, 195, 208, 221, 234, 247, 260, 273, 286, 299, 317, 319, 322, 323, 324, 325, 338, 351, 364, 377, 390, 403, 416, 429, 442, 455, 468, 481, 494, 507, 520, 533, 546, 559, 572, 585, 598, 611, 624
Have four introduced samples on them
All other lines have three samples

525

Lines 9, 11, 272, 274
Have no introduced samples on them.

Lines 3, 10, 33, 48, 78, 83, 108, 123, 138, 153, 168, 183, 198, 213, 228, 243, 258, 265, 273, 288, 303, 318, 333, 348, 363, 378, 393, 408, 423, 408, 438, 453, 468, 483, 498, 513
Line 18 has either 3 sample for frames 2 and 4 or 4 samples for frames 1, 3 or 5
All other lines have three samples.

Firewall See Appendix 1

Hanc Blanking Control.

When “Hanc Blank” is enabled the HANC space is cleared of all incoming packets. In this case the non-PCM and non-audio data is removed. If pass HANC control is disabled then the incoming non-audio packets are inserted following the packets created by this unit. Bypassing will leave all non-audio packets intact. Any audio group that is to be embedded; will remove any packet from the incoming stream from the same group.

HANC Overflow Condition

The card assumes that the incoming HANC is SMTE291 compliant. If there is data embedded in the HANC space that is non-compliant then it would be outside of the unit’s handling capability.

Alternate HANC Packet Specification

Only audio packet types are validated and with the exception of packets that are of the “Marked for deletion” type, all packets are passed as they are.

“Marked for deletion packets” are removed if they can be while maintaining continuity. Checksum calculation is done on generated packets but not on passed through packets.

If an audio packet has gone through the bypass process then the packet is not changed. If the audio has been processed and embedded then packet parity is calculated for the generated packets.

If pre-existing embedded audio is not valid due to not having enough samples then in bypass mode the same data is passed to the output. If this type of broken input is extracted then the unit will try to sample rate convert (SRC) to the correct 48kHz sample rate. The SRC’d drops or holds will be more or less audible depending on how broken the incoming audio packets are.

Recognize Audio Data Packet Identifiers

Recognize:(DID)

2FF	1FD	1FB	2F9	Audio Group
1FE	2FC	2FA	1F8	Extended Audio
1EF	2EE	2ED	1EC	Control Packet

