



User Manual

**IQOTR40, IQOTR41, IQOTR42,
IQOTR43, IQOTR44, IQOTR45
IQOTR99**

**3G/HD/SD-SDI Multi-Channel Fiber
Transceiver**

Contents

Module Description	3
Block Diagram.....	3
Rear Panel View	3
Order Codes	4
Feature Summary	5
Technical Profile	6
Inputs and Outputs	6
Controls	6
Specifications	7
Connections.....	9
SDI Inputs.....	9
Fiber Inputs	9
SDI Outputs.....	10
Fiber Outputs.....	10
Card Edge Controls	11
Controlling the IQOTRXX from the RollCall Control Panel	12
Unit Status.....	12
System-Setup Screen	13
SDI-Inputs 1-4 Screen.....	14
Fiber-Inputs 1-4 Screen.....	16
Output-Fiber Screen.....	18
System-Memory 1-16 Screen.....	19
Logging.....	20
RollCall Log Fields.....	25
System-RollTrack Screen.....	27

This information applies to the transceiver modules in the Optical Converter Platform range. In the case of the IQOTR99, some of the RollCall screens will be missing if the SFPs for the channels associated with those screens are not fitted and, in some cases, although the screen will be present, the group boxes or controls associated with particular channels will be missing or disabled.

The different versions of the standard product simply have different wavelength fiber transmitters fitted.

Module Description

The IQOTR40-45 range converts four single mode fiber optic signals to four 3G/HD/SD-SDI outputs and four 3G/HD/SD-SDI signals to four single mode fiber optic outputs. The unit is available in single or dual width versions with either DIN1.0/2.3, HDBNC or BNC connectors. The IQOTR99 is a special version of the product with a partial fit of channels and/or with non-standard combinations of transmitter wavelengths.

Block Diagram

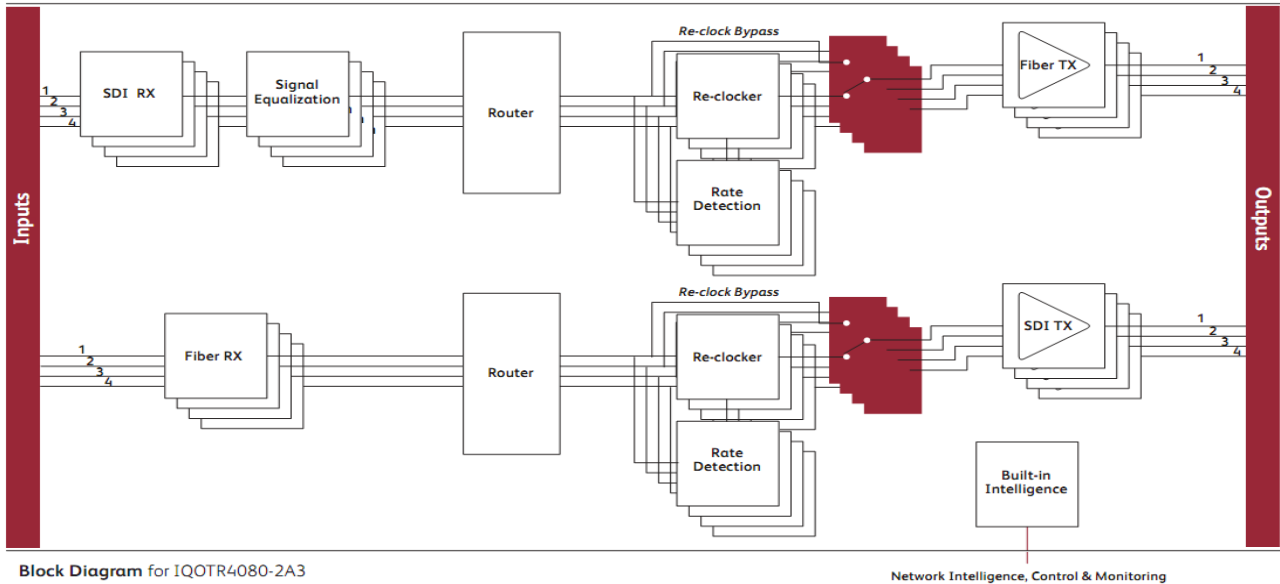

Rear Panel View

Single width Fibre and DIN1.0/2.3 (IQOTR4_78-1A3)

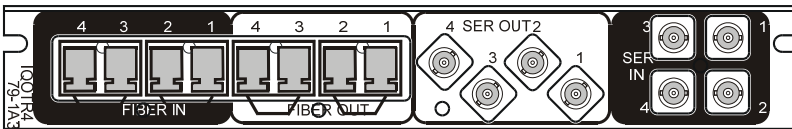

Single width Fibre and HD BNC (IQOTR4_79-1A3)

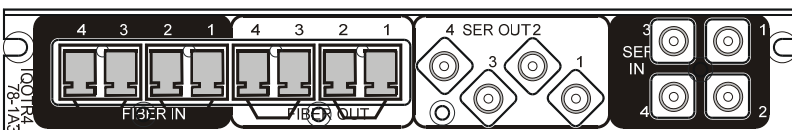

Double width Fibre and BNC (IQOTR4_80-2A3)

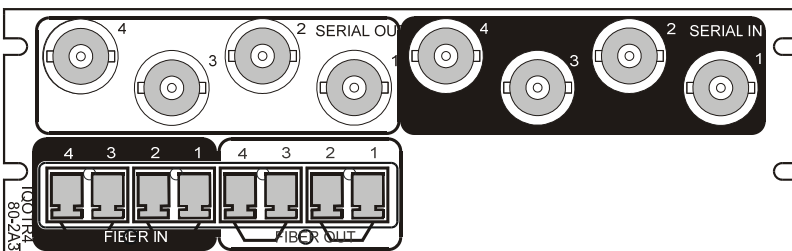

Order Codes

Versions of the module cards available are:

SFP fit options for different wavelength operation.

	CH1/2	CH3/4
IQOTR40	Dual 1310nm	Dual 1310nm
IQOTR41	Dual 1550nm	Dual 1550nm
IQOTR42	1270/1290nm	1310/1330nm
IQOTR43	1350/1370nm	1390/1410nm
IQOTR44	1470/1490nm	1510/1530nm
IQOTR45	1550/1570nm	1590/1610nm

<i>IQOTR4078-1A3</i>	3G/HD/SD-SDI multi-channel fiber transceiver. 4 x 3G/HD/SD-SDI inputs (DIN 1.0/2.3), 4 x 1310nm optical outputs.
<i>IQOTR4079-1A3</i>	3G/HD/SD-SDI multi-channel fiber transceiver. 4 x 3G/HD/SD-SDI inputs (HD-BNC), 4 x 1310nm optical outputs.
<i>IQOTR4080-2A3</i>	3G/HD/SD-SDI multi-channel fiber transceiver. 4 x 3G/HD/SD-SDI inputs (BNC), 4 x 1310nm optical outputs.
<i>IQOTR4178-1A3</i>	As IQOTR4078-1A3 but fitted with 1550nm optical transmitters
<i>IQOTR4179-1A3</i>	As IQOTR4079-1A3 but fitted with 1550nm optical transmitters
<i>IQOTR4180-2A3</i>	As IQOTR4080-2A3 but fitted with 1550nm optical transmitters
<i>IQOTR4278-1A3</i>	As IQOTR4078-1A3 but fitted with 1270-1330nm CWDM optical transmitters
<i>IQOTR4279-1A3</i>	As IQOTR4079-1A3 but fitted with 1270-1330nm CWDM optical transmitters
<i>IQOTR4280-2A3</i>	As IQOTR4080-2A3 but fitted with 1270-1330nm CWDM optical transmitters
<i>IQOTR4378-1A3</i>	As IQOTR4078-1A3 but fitted with 1350-1410nm CWDM optical transmitters
<i>IQOTR4379-1A3</i>	As IQOTR4079-1A3 but fitted with 1350-1410nm CWDM optical transmitters
<i>IQOTR4380-2A3</i>	As IQOTR4080-2A3 but fitted with 1350-1410nm CWDM optical transmitters
<i>IQOTR4478-1A3</i>	As IQOTR4078-1A3 but fitted with 1470-1530nm CWDM optical transmitters
<i>IQOTR4479-1A3</i>	As IQOTR4079-1A3 but fitted with 1470-1530nm CWDM optical transmitters
<i>IQOTR4480-2A3</i>	As IQOTR4080-2A3 but fitted with 1470-1530nm CWDM optical transmitters
<i>IQOTR4578-1A3</i>	As IQOTR4078-1A3 but fitted with 1550-1610nm CWDM optical transmitters
<i>IQOTR4579-1A3</i>	As IQOTR4079-1A3 but fitted with 1550-1610nm CWDM optical transmitters
<i>IQOTR4580-2A3</i>	As IQOTR4080-2A3 but fitted with 1550-1610nm CWDM optical transmitters

Note: All these versions are also available for the new IQ 3U B enclosure. Please append order code with A3 (A enclosure) or B3 (B enclosure) as appropriate.

Feature Summary

- 4 channels of fiber outputs single mode fiber optic transmitter for 3G/HD/SDSDI and DVB ASI signals.
- 4 channels of electrical SDI inputs for 3G/HD/SDSDI and DVB ASI signals.
- 4 channels single mode fiber optic receiver for 3G/HD/SDSDI and DVB ASI signals.
- 4 channels of electrical SDI outputs for 3G/HD/SDSDI and DVB ASI signals.
- Output wavelengths of 1310 nm, 1550 nm or CWDM combinations.
- Input wavelengths of 1260 nm to 1610 nm.
- Reclocking for 3 Gbps, 1.5 Gbps HD-SDI and 270 Mbps SDI signals, or asynchronous operation for other frequencies.
- Input channel routing – electrical SDI inputs 1 to 4 can be routed to fiber output channels 1 to 4, and fiber inputs 1 to 4 can be routed to electrical SDI output channels 1 to 4.
- Input selection logic – two configurations can be preset with routing. Configurations can be selected on input signal status.
- RollCall monitoring allows all signal paths to be managed
- High density DIN1.0/2.3 and HDBNC options provide compact space saving single slot solution.
- The SFP receivers and transmitters are hot-pluggable – i.e. they may be removed and inserted without removing power from the module.

Technical Profile

Inputs and Outputs

Signal Inputs (Tx)

Electrical	3 Gbps HD-SDI, 1.485 Gbps HD-SDI or 270 Mbps SD-SDI (asynchronous operation available at other frequencies)
Connector / format	BNC / 75 Ohm, DIN1.0/2.3, HDBNC panel jack
Conforms to	SMPTE 424M (HD level A) SMPTE 292M (HD) SMPTE 259M-C (SD)
Inputs	4
Input cable length	Up to 100m Belden 1694A @ 3Gbps Up to 150m Belden 1694A @ 1.5 Gbps Up to 250m Belden 1694A @ 270 Mbps

Signal Inputs (Rx)

Optical	3 Gbps HD-SDI, 1.485 Gbps HD-SDI or 270 Mbps SD-SDI (asynchronous operation available at other frequencies)
Connector / format	LC single mode SFP
Conforms to:	SMPTE 297-2006
Inputs	4

Signal Outputs (Tx)

Optical	3 Gbps HD-SDI, 1.485 Gbps HD-SDI or 270 Mbps SD-SDI (asynchronous operation available at other frequencies)
Connector / format	LC single mode SFP
Conforms to	SMPTE 297-2006
Outputs	1 to 4 per Channel

Signal Outputs (Rx)

Electrical	3 Gbps HD-SDI, 1.485 Gbps HD-SDI or 270 Mbps SD-SDI (asynchronous operation available at other frequencies)
Connector / format	BNC / 75 ohm, DIN1.0/2.3, HDBNC panel jack
Conforms to	SMPTE 424M (HD level A) SMPTE 292M (HD) SMPTE 259M-C (SD)
Outputs	1 to 4 per Channel

Controls

Indicators

Power	OK (Green)
CPU	OK (Green flashing)
Good	Hardware OK (Green)
Warning	SFP fit not as sold (Yellow), SFP warning active (Yellow flashing), OK (Off)
Error	Hardware error (Red), SFP alarm active (Red flashing), OK (Off)
Input 1-8	SD-OK (Yellow), HD-OK (Green), 3G-OK (Blue), other-OK (White flashing), Bypass (Rate colour flashing), Loss (Red)

RollCall Functions

Input 1-8 rate select	3G, HD, SD, other
Reclock bypass	On/Off
Fiber O/P select	SDI Input 1-4
Electrical O/P select	Fiber Input 5-8
Input status	Present, Loss, Unknown, Unrouted, Data Rate
Output Mute	On/Off
Laser disable	On/Off
Logging	Input 1-8 Type Input 1-8 Bit Rate Input 1-8 Present Input 1-8 Loss Output 1-4 laser bias Output 1-4 laser power Output 1-4 laser wavelength Input 5-8 laser power Output Configuration
RollTrack controls	On/Off, Index, Source, Address, Command, Status, Sending
RollTrack outputs	Unused Input 1-8 Present Input 1-8 Rate Unknown Input 1-8 Loss Input 1-8 3G Input 1-8 HD Input 1-8 SD Output 1-4 laser bias OK Output 1-4 laser bias High Output 1-4 laser bias Low Input 5-8 Power OK Input 5-8 Power High Input 5-8 Power Low Output Configuration

Specifications

Electrical	3 Gbps SDI, SMPTE 424M, 1.5 Gbps HD-SDI, SMPTE 292M 270 Mbps SDI, SMPTE 259MC / DVB-ASI
Connector / format	BNC/ 75 Ohm panel jack on standard Snell connector panel
Return loss	>-15 dB (270 Mbps, 1.5 Gbps) >-10 dB (3 Gbps)
Output jitter	SD-SDI 0.2 UI (10 Hz) / 0.2 UI (1 kHz) 3G/HD-SDI 1.0 UI (10 Hz) / 0.2UI (100 kHz)
Module power	10.5 W max
Receiver wavelength	1260 – 1610 nm
Optical power	0 dBm to -18 dBm
Input range	

(Depends on SFP fitted)

1310 nm Tx

Wavelength	1310 nm
Spectral width (FWHM)	1.5 nm (typ RMS)
Output power	-2 dBm (typ), 0 dBm max
Extinction ratio	>7.5:1 (typ)
Transmission distance	10 km max under worst conditions, up to 30 km max

1550 nm Tx

Wavelength	1550 nm
Spectral width (FWHM)	1 nm (max)
Output power	4 dBm max
Extinction ratio	>7.5:1 (typ)
Transmission distance	Up to 50 Km max

CWDM wavelength Tx

Wavelength	1270 nm – 1410 nm and 1470 nm –1610 nm
Spectral width (FWHM)	1 nm (max)
Output power	2.5 dBm (typ), 5 dBm max
Extinction ratio	>9:1 (typ)
Transmission distance	Up to 50 km max

Connections

SDI Inputs

IQOTR4_78-1A3 and IQOTX8_79-1A3

SDI inputs to the unit are made via 8 DIN 1.0/2/3 or HD BNC (75ohm) panel jack connectors.

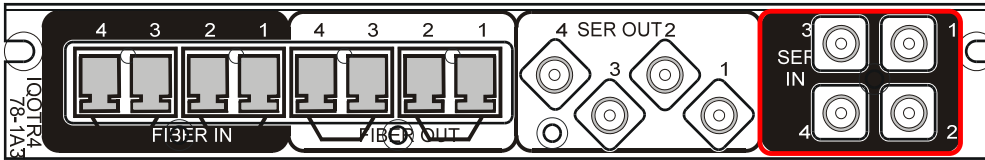

IQOTR4_80-2A3

SDI inputs to the unit are made via BNC / 75ohm panel jack connectors.

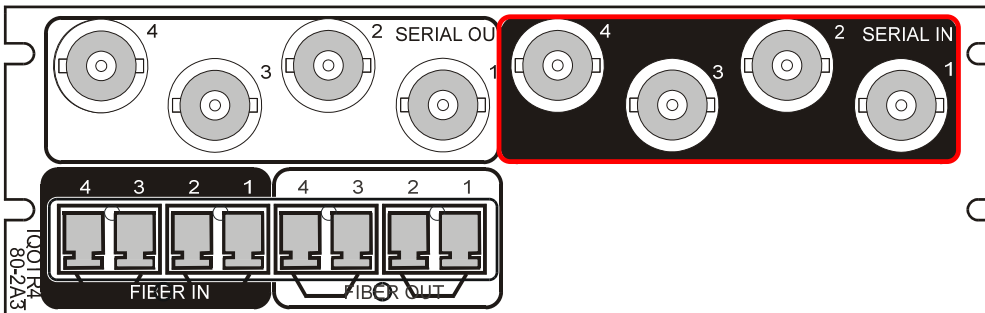

Fiber Inputs

IQOTR4_78-1A3 and IQOTX8_79-1A3

Fiber inputs from the unit are made via 4 LC connectors.

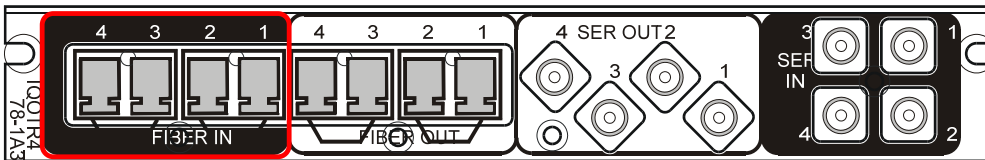

IQOTR4_80-2A3

Fiber inputs from the unit are made via 4 LC connectors.

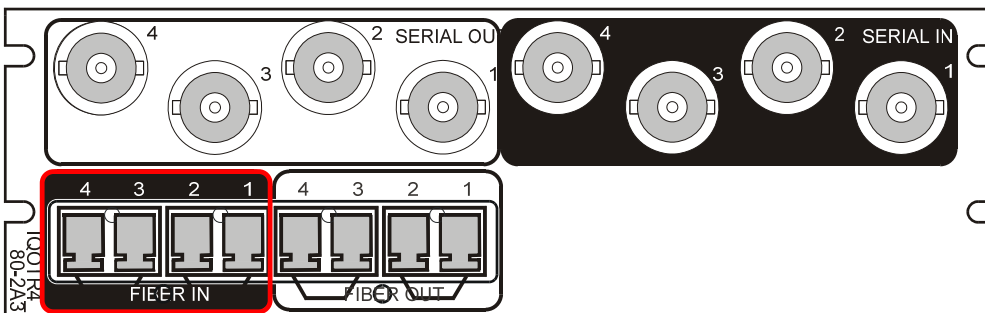

SDI Outputs

IQOTR4_78-1A3 and IQOTX8_79-1A3

SDI outputs to the unit are made via 8 DIN 1.0/2/3 or HD BNC (75ohm) panel jack connectors.

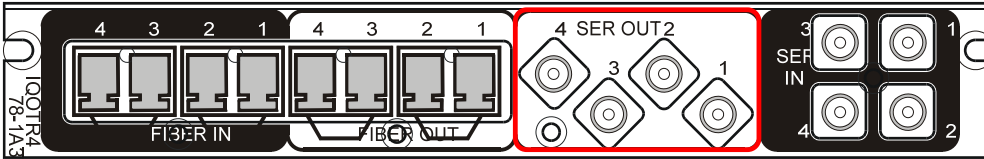

IQOTR4_80-2A3

SDI outputs to the unit are made via BNC / 75ohm panel jack connectors.

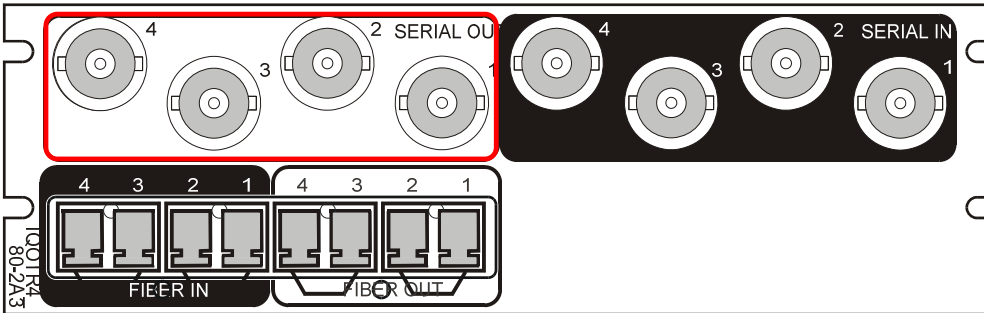

Fiber Outputs

IQOTR4_78-1A3 and IQOTX8_79-1A3

Fiber outputs from the unit are made via 4 LC connectors.

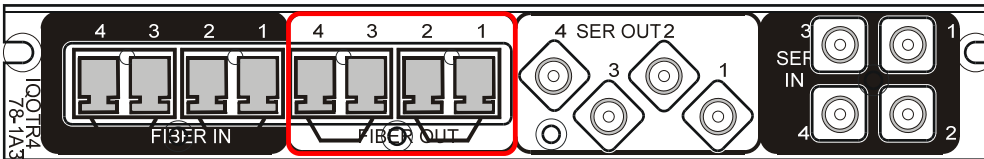

IQOTR4_80-2A3

Fiber outputs from the unit are made via 4 LC connectors.

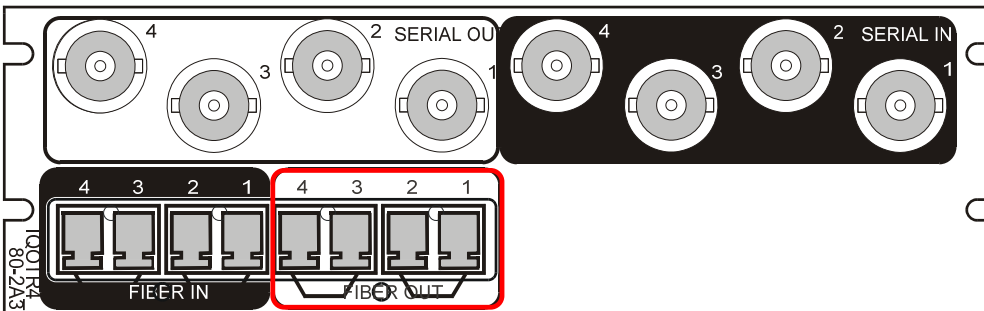

Card Edge Controls

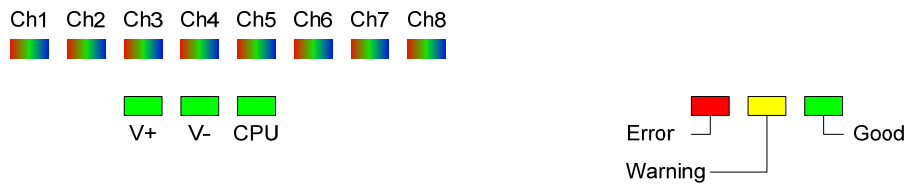

V+ and V- When illuminated these LED's indicate that the positive and negative supplies are present.

CPU This led will flash to indicate that the CPU is running.

Input Channel Status (Ch1 to Ch8)

- Off** Channel is not applicable to this product.
- Yellow** SD - re-clocker locked at 270 MHz, flashes when in RC-bypass
- Green** HD - re-clocker locked at 1.485/1.4835 GHz, flashes when in RC-bypass
- Blue** 3G - re-clocker locked at 2.97/2.967 GHz, flashes when in RC-bypass
- White (flashing)** Unknown rate detected, forcing RC-bypass. Input might actually be un-routed with all rates selected in the dialog.
- Red** No signal present.
- Red (flashing)** Input detected, but rate is in error. This is as a result of the rate selection logic on the RollCall dialogue, or the channel is un-routed and not all rates are selected.

Error (Red) When illuminated indicates that SFPs are fitted incorrectly or missing (see SFP Fit Errors and Warnings).

When flashing indicates that an SFP status alarm has been activated (e.g. temperature or supply voltage) other than the Rx Power Alarm.

Warning (Yellow) Illuminates to indicate that the order in which the SFPs are fitted has changed from the original documented fit (see SFP Fit Errors and Warnings).

Flashes to indicate that an SFP status warning has been activated (e.g. temperature or supply voltage) other than the Rx Power Warning.

Good (Green) Illuminates to indicate all SFPs are fitted and functioning correctly.

Controlling the IQOTRXX from the RollCall Control Panel

Unit Status

Information about the status of the unit is displayed in the Unit Status section on each RollCall Control Panel screen. The default is the Summary.

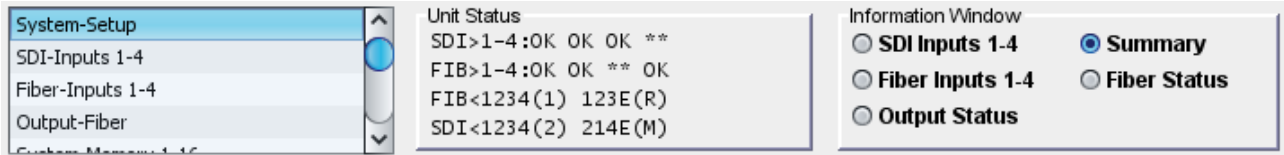

The radio buttons in the Information Window are used to select what is displayed in Unit Status.

- Summary** – shows a cryptic view of the channel input status, the output routing and the mode selection. On the top two lines it shows signals present on SDI inputs 1, 2 and 3 and on Fiber inputs 1, 2 and 4. On the bottom two lines it shows the selected Config with Routing and Mode for the SDI → Fiber and Fiber → SDI channels. Blank status means the fiber receiver isn't fitted for that channel or a transmitter is fitted by mistake.

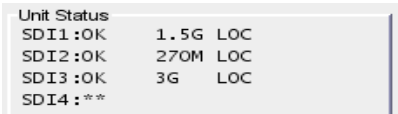
- SDI Inputs 1-4** – shows a more detailed view of SDI channel input status; includes status field, bit rate and whether locked or bypassing the reclocker. **U** in the first field indicates the input is not routed to an output and therefore its bit rate cannot be measured. **Err** indicates that a signal has been detected but its bit rate is not one of those selected for that input.

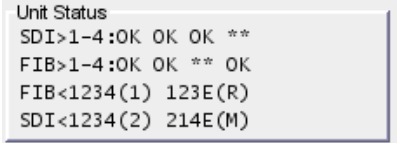
- Fiber Inputs 1-4** – as SDI Inputs 1-4 but for the fiber channels.

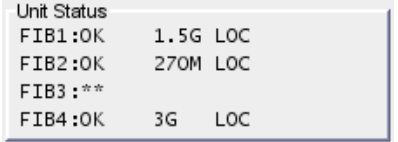
- Output Status** – shows the status for the Fiber and SDI outputs. On the top two lines it shows that SDI I/Ps 1, 2 and 3 are routed to Fiber O/Ps 1, 2 and 3, Fiber O/P 4 shows **E** which means it is muted (laser off) due to an input error, Config **1** is selected and the Mode is **Rules**. The bottom two lines show that Fiber I/Ps 2, 1 and 4 are routed to SDI O/Ps 1, 2 and 3, SDI O/P 4 shows **E**, muted due to input error, Config **2** is selected and the mode is **Manual**. **M** instead of **E** in the routing status indicates muted using the channel's Mute or Laser Off control. An **X** means a Fiber Transmitter is missing or a Fiber Receiver is fitted by mistake. A 'space' in this position means that the product does not require a Fiber Transmitter to be fitted for that channel (applies to IQOTR99).

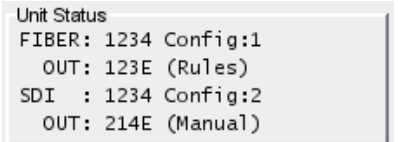
- Fiber Status** – shows the status of the SFP fiber transmitters and receivers. **LOW** or **HIGH** means low or high Power; with transmitters this could be an early indication of a fault, though, with receivers, **LOW** is the normal state if there is no input signal. Transmitters have an additional status to indicate the laser is turned **OFF**. **NONE** indicates that a Fiber Transmitter is missing or a Receiver fitted by mistake. 'Blank' status indicates that the product does require a Fiber Transmitter to be fitted for that channel (applies to IQOTR99) or a Fiber Receiver is missing or a Transmitter is fitted by mistake.

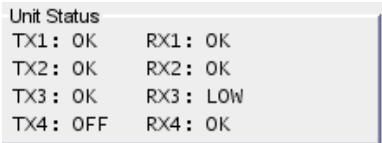

System-Setup Screen

The **Setup** screen displays basic information about the unit. Use the functions on the screen to restart the unit, return all settings to their factory defaults, and to change the names of the inputs.

The screenshot shows the System-Setup screen with the following sections:

- System-Setup** (selected in the left menu)
- Unit Status**: SDI>1-4:OK OK OK **, FIB>1-4:OK OK **, FIB<1234(1) 123E(R), SDI<1234(2) 214E(M)
- Information Window**:
 - SDI Inputs 1-4
 - Summary**
 - Fiber Inputs 1-4
 - Fiber Status
 - Output Status
- Product**:
 - Product: IQOTR40-3G
 - Software Version: 5.0.5
 - Serial No.: S12345678
 - Build: 0003304836
 - KOS: V115
 - Firmware: 00.001.01 01.000.02
 - PCB: RKADM1Y
 - Licensed Options: SDHD;3G
 - Rear ID: 5:GK9DIN
 - Defaults: Defaults Settings, Factory Defaults
 - IO Mod 1 ID: 2:RKIOM8V4F
 - IO Mod 2 ID: 0:None fitted
 - Restart button
 - Proc Mod ID: SAACS RKPRMLED1Y
- SFP Details** table:

	ID	W/L	Vendor	Part No.	Status
CH 1	81	1310nm	OPTOWAY	SPS-9110VW-2TG	OK
CH 2	81	1310nm	OPTOWAY	SPS-9110VW-2TG	OK
CH 3	81	1310nm	GENNUM	GO2928-3131CM	OK
CH 4	81	1310nm	GENNUM	GO2928-3131CM	OK
CH 5	82		OPTOWAY	SPS-9110VW-2RG	OK
CH 6	82		OPTOWAY	SPS-9110VW-2RG	OK
CH 7	82		OPTOWAY	SPS-9110VW-2RG	OK
CH 8	82		OPTOWAY	SPS-9110VW-2RG	OK
- Input Name** fields (Input 1-8): CHANNEL 1 through CHANNEL 8, each with P and S buttons.

Product: The top left part of the screen shows the various versions, options, identifiers, etc., associated with the product's hardware, firmware and software and also provides a means of setting controls to defaults or restarting the unit. Note that the Firmware release is in two parts, the left-hand being for the Administration module FPGA and the right-hand part being for the I/O module FPGA.

To restart the unit, simulating a power-up/power-down cycle, click **Restart**.

To reset all of the unit's settings to their factory defaults, click **Factory Defaults**.

- *NOTE: this also clears all of the saved memory settings.*

To reset all of the unit's settings to their factory defaults, leaving user memories intact, click **Default Settings**.

SFP Details: The top right part of the screen shows the details of the SFP transmitters and receivers fitted. The Status column indicates whether the SFPs fitted are correct for the particular product. The difference between the TR40, 41, 42, 43, 44, 45 products is purely the wavelengths of the transmitters fitted. *NOTE:* SFP details are read only at start up so the unit must be restarted if an SFP is changed.

Input 1-8 Name: The bottom half of the screen has entry fields for 8 **Input Names**. These are the input names displayed in logging. To change a name, type the name in the text field and click **S**. To return the name to its factory default, click **P**. Note that **Fiber Inputs 1-4** are **Inputs 5-8** in this context.

SDI-Inputs 1-4 Screen

The SDI-Inputs screen enables the:

- Inputs and outputs to be configured.
- The configuration mode to be used selected.
- The rules governing configuration use to be specified.

The screenshot shows the 'SDI-Inputs 1-4' configuration screen. At the top left, a navigation menu lists 'System-Setup', 'SDI-Inputs 1-4', 'Fiber-Inputs 1-4', 'Output-Fiber', and 'System-Monitors'. The 'SDI-Inputs 1-4' option is selected. To the right, the 'Unit Status' window shows: SDI>1-4:OK OK OK **, FIB>1-4:OK OK ** OK, FIB<1234(1) 123E(R), and SDI<1234(2) 214E(M). The 'Information Window' has radio buttons for 'SDI Inputs 1-4' (selected), 'Fiber Inputs 1-4', and 'Output Status', with a 'Summary' button.

Four SDI input configuration panels are shown:

- SDI Input 1:** SERIAL IN 1, CHANNEL 1. Options: SD/DVB-ASI (270 Mb), HD (1.5 Gb), 3G (3Gb), Others, Reclock Bypass. I/P State: OK, I/P Rate: 1.5Gb/s.
- SDI Input 2:** SERIAL IN 2, CHANNEL 2. Options: SD/DVB-ASI (270 Mb), HD (1.5 Gb), 3G (3Gb), Others, Reclock Bypass. I/P State: OK, I/P Rate: 270Mb/s.
- SDI Input 3:** SERIAL IN 3, CHANNEL 3. Options: SD/DVB-ASI (270 Mb), HD (1.5 Gb), 3G (3Gb), Others, Reclock Bypass. I/P State: OK, I/P Rate: 3.0Gb/s.
- SDI Input 4:** SERIAL IN 4, CHANNEL 4. Options: SD/DVB-ASI (270 Mb), HD (1.5 Gb), 3G (3Gb), Others, Reclock Bypass. I/P State: FAIL:Lost, I/P Rate: UNKNOWN.

Mode selection: Config 1, Config 2, Use Rules.

Rules: Config 1 On Primary Input OK, Config 2 On Primary Input Error, Config 1 On Secondary Input Error.

Primary Input Delay for Rules: OK Timer 0.5 sec, Err Timer 0.5 sec.

Secondary Input Delay For Rules: Err Timer 0.5 sec.

Primary & Secondary Inputs:

	SDI I/P 1	2	3	4
Primary Input	<input checked="" type="radio"/>	<input type="radio"/>	<input type="radio"/>	<input type="radio"/>
Secondary Input	<input type="radio"/>	<input checked="" type="radio"/>	<input type="radio"/>	<input type="radio"/>

Fiber Outputs configuration:

Config 1:

Selected	1	2	3	4
SDI I/P 1	<input checked="" type="radio"/>	<input type="radio"/>	<input type="radio"/>	<input type="radio"/>
SDI I/P 2	<input type="radio"/>	<input checked="" type="radio"/>	<input type="radio"/>	<input type="radio"/>
SDI I/P 3	<input type="radio"/>	<input type="radio"/>	<input checked="" type="radio"/>	<input type="radio"/>
SDI I/P 4	<input type="radio"/>	<input type="radio"/>	<input type="radio"/>	<input checked="" type="radio"/>
Laser Off On Inp Err	<input checked="" type="checkbox"/>	<input checked="" type="checkbox"/>	<input checked="" type="checkbox"/>	<input checked="" type="checkbox"/>
Laser Off	<input type="checkbox"/>	<input type="checkbox"/>	<input type="checkbox"/>	<input type="checkbox"/>

Config 2:

Fiber Outputs	1	2	3	4
SDI I/P 1	<input type="radio"/>	<input checked="" type="radio"/>	<input type="radio"/>	<input type="radio"/>
SDI I/P 2	<input checked="" type="radio"/>	<input type="radio"/>	<input type="radio"/>	<input type="radio"/>
SDI I/P 3	<input type="radio"/>	<input type="radio"/>	<input checked="" type="radio"/>	<input type="radio"/>
SDI I/P 4	<input type="radio"/>	<input type="radio"/>	<input type="radio"/>	<input checked="" type="radio"/>
Laser Off On Inp Err	<input checked="" type="checkbox"/>	<input checked="" type="checkbox"/>	<input checked="" type="checkbox"/>	<input checked="" type="checkbox"/>
Laser Off	<input type="checkbox"/>	<input type="checkbox"/>	<input type="checkbox"/>	<input type="checkbox"/>

Swap Config 1 <>2 button.

SDI Inputs 1-4

- **SD/DVB-ASI (270 Mb):**
- **HD (1.5Gb):**
- **3G (3 Gb):**
- **Others:** Check one or more of these checkboxes to determine which types of signal are deemed to be valid for a particular input. If a signal is present on the input but not selected as valid, its status will be **Error**. **Others** is for signals of type other than the above. Also, because the reclockers are on the *outputs*, if an input is detected as present but not routed to an output, its bit rate will be unknown and its status would be **Error** unless this box was checked.
- **Reclock Bypass:** Check this to bypass the reclocker, which is on the output signal.
- The **Channel Ident**, **I/P Name**, **I/P State** and **I/P Rate** are shown for each channel.

Config 1 and Config 2

Use the radio buttons to specify the **SDI** input for each of the four **Fiber** outputs.

Select **Laser Off On Inp Err** to apply a mute to the output if there is no valid signal on its input as defined by the checkboxes; includes signal lost. Select **Laser Off** to manually apply a mute to the output.

Swap Config 1 <> 2

Click **Swap Config** to swap the Config 1 setup with the Config 2 setup.

Mode

These controls specify which configuration is to be used, or whether the configuration choice should be made by the rules configured in the **Rules** section.

Primary & Secondary Inputs

Use the radio buttons to select which input channels are used in the **Rules** section.

Rules

These controls specify which configuration is to be used if the **Use Rules** option is selected in the Mode section. The option enables the configuration to be switched automatically if an input fails or changes to an inappropriate rate.

- **Config 1 On Primary Input OK:** this selection will use Config 1 if the Primary Input is receiving a valid input signal.
- **Config 2 On Primary Input Err:** this selection will switch to Config 2 if the Primary Input 1 is not receiving a valid input signal.
- **Config 1 On Secondary Input Err:** this selection will switch to Config 1 if the Secondary Input is not receiving a valid input signal.

Primary Input Delay for Rules

- **OK Timer:** this specifies the time that the Primary Input must be receiving a valid signal in order to be considered 'OK' by any rules.
- **Err Timer:** this specifies the time that Primary Input must be receiving an invalid (or lost) signal in order to be considered in error by any rules.

Secondary Input Delay for Rules

- **Err Timer:** this specifies the time that the Secondary Input must be receiving an invalid (or lost) signal in order to be considered in error by any rules.

NOTE: Because the reclockers that measure the rate of the signals are on the *outputs* rather than the *inputs* of the routing cross-points, an input must be routed in order for its rate to be determined. Therefore, depending on which Rules are selected, the Primary and/or the Secondary input channels have to be routed in one or both of the two configurations in order for the rule to work...

- **Config 1 On Primary Input OK:** Because this is a rule for switching from Config 2 back to Config 1, the Primary must be routed in Config 2.
- **Config 2 On Primary Input Err:** Because this is a rule for switching from Config 1 to Config 2, the Primary must be routed in Config 1.
- **Config 1 On Secondary Input Err:** Because this is a rule for switching back from Config 2 back to Config 1, the Secondary must be routed in Config 2. Also, to prevent the configuration switching backwards and forwards between configurations, it must also be routed in Config 1.

Fiber-Inputs 1-4 Screen

The Fiber-Inputs screen enables the:

- Inputs and outputs to be configured.
- The configuration mode to be used selected.
- The rules governing configuration use to be specified.

Fiber Inputs 1-4

- **SD/DVB-ASI (270 Mb):**
- **HD (1.5Gb):**
- **3G (3 Gb):**
- **Others:** Check one or more of these checkboxes to determine which types of signal are deemed to be valid for a particular input. If a signal is present on the input but not selected as valid, its status will be **Error**. **Others** is for signals of type other than the above. Also, because the reclockers are on the *outputs*, if an input is detected as present but not routed to an output, its bit rate will be unknown and its status would be **Error** unless
- **Reclock Bypass:** Check this to bypass the reclocker, which is on the output signal.
- The **Channel Ident**, **I/P Name**, receiver **SFP Status** (relating to product SPF fit), **I/P State**, **I/P Rate**, **Rx Power** (value and alarm status) are shown for each channel.

Config 1 and Config 2

Use the radio buttons to specify the **Fiber** input for each of the four **SDI** outputs.

Select **Mute On Inp Err** to apply a mute to the output if there is no valid signal on its input as defined by the checkboxes; includes signal lost. Select **Mute** to manually apply a mute to the output.

Swap Config 1 <> 2

Click **Swap Config** to swap the Config 1 setup with the Config 2 setup.

Mode

These controls specify which configuration is to be used, or whether the configuration choice should be made by the rules configured in the Rules section.

Primary & Secondary Inputs

Use the radio buttons to select which input channels are used in the Rules section.

Rules

These controls specify which configuration is to be used if the **Use Rules** option is selected in the Mode section. The option enables the configuration to be switched automatically if an input fails or changes to an inappropriate rate.

- **Config 1 On Primary Input OK:** this selection will use Config 1 if the Primary Input is receiving a valid input signal.
- **Config 2 On Primary Input Err:** this selection will switch to Config 2 if the Primary Input 1 is not receiving a valid input signal.
- **Config 1 On Secondary Input Err:** this selection will switch to Config 1 if the Secondary Input is not receiving a valid input signal.

Primary Input Delay for Rules

- **OK Timer:** this specifies the time that the Primary Input must be receiving a valid signal in order to be considered 'OK' by any rules.
- **Err Timer:** this specifies the time that Primary Input must be receiving an invalid (or lost) signal in order to be considered in error by any rules.

Secondary Input Delay for Rules

- **Err Timer:** this specifies the time that the Secondary Input must be receiving an invalid (or lost) signal in order to be considered in error by any rules.

NOTE: Because the reclockers that measure the rate of the signals are on the *outputs* rather than the *inputs* of the routing cross-points, an input must be routed in order for its rate to be determined. Therefore, depending on which Rules are selected, the Primary and/or the Secondary input channels have to be routed in one or both of the two configurations in order for the rule to work...

- **Config 1 On Primary Input OK:** Because this is a rule for switching from Config 2 back to Config 1, the Primary must be routed in Config 2.
- **Config 2 On Primary Input Err:** Because this is a rule for switching from Config 1 to Config 2, the Primary must be routed in Config 1.
- **Config 1 On Secondary Input Err:** Because this is a rule for switching back from Config 2 back to Config 1, the Secondary must be routed in Config 2. Also, to prevent the configuration switching backwards and forwards between configurations, it must also be routed in Config 1.

Output-Fiber Screen

The Output-Fiber screen shows status associated with the fiber transmitters.

The screenshot displays the 'Output-Fiber' configuration screen. On the left is a navigation menu with 'Output-Fiber' selected. The main area is divided into three sections: 'Unit Status', 'Information Window', and a grid of transmitter status panels.

Unit Status:
SDI>1-4 :OK OK OK **
FIB>1-4 :OK OK ** OK
FIB<1234 (1) 123E(R)
SDI<1234 (2) 214E(M)

Information Window:
 SDI Inputs 1-4
 Summary
 Fiber Inputs 1-4
 Fiber Status
 Output Status

Fiber Optic Tx 1			
Tx Wavelength:	1310nm	SFP Status:	OK
Laser Bias:	29.1mA	Tx Power:	-2.4dBm
Laser Bias State:	OK	Tx Power State:	OK

Fiber Optic Tx 2			
Tx Wavelength:	1310nm	SFP Status:	OK
Laser Bias:	28.1mA	Tx Power:	-2.9dBm
Laser Bias State:	OK	Tx Power State:	OK

Fiber Optic Tx 3			
Tx Wavelength:	1310nm	SFP Status:	OK
Laser Bias:	20.1mA	Tx Power:	-1.9dBm
Laser Bias State:	OK	Tx Power State:	OK

Fiber Optic Tx 4			
Tx Wavelength:	1310nm	SFP Status:	OK
Laser Bias:	-	Tx Power:	-
Laser Bias State:	OK:OFF	Tx Power State:	OK:OFF

Fiber Optic Tx 1-4

Shows the fiber transmitter status for each channel. **SFP Status** relates to the product SPF fit.

System-Memory 1-16 Screen

Use the Memory function to save up to 16 setups to be recalled later. Default memory names can be changed to provide more meaningful descriptions.

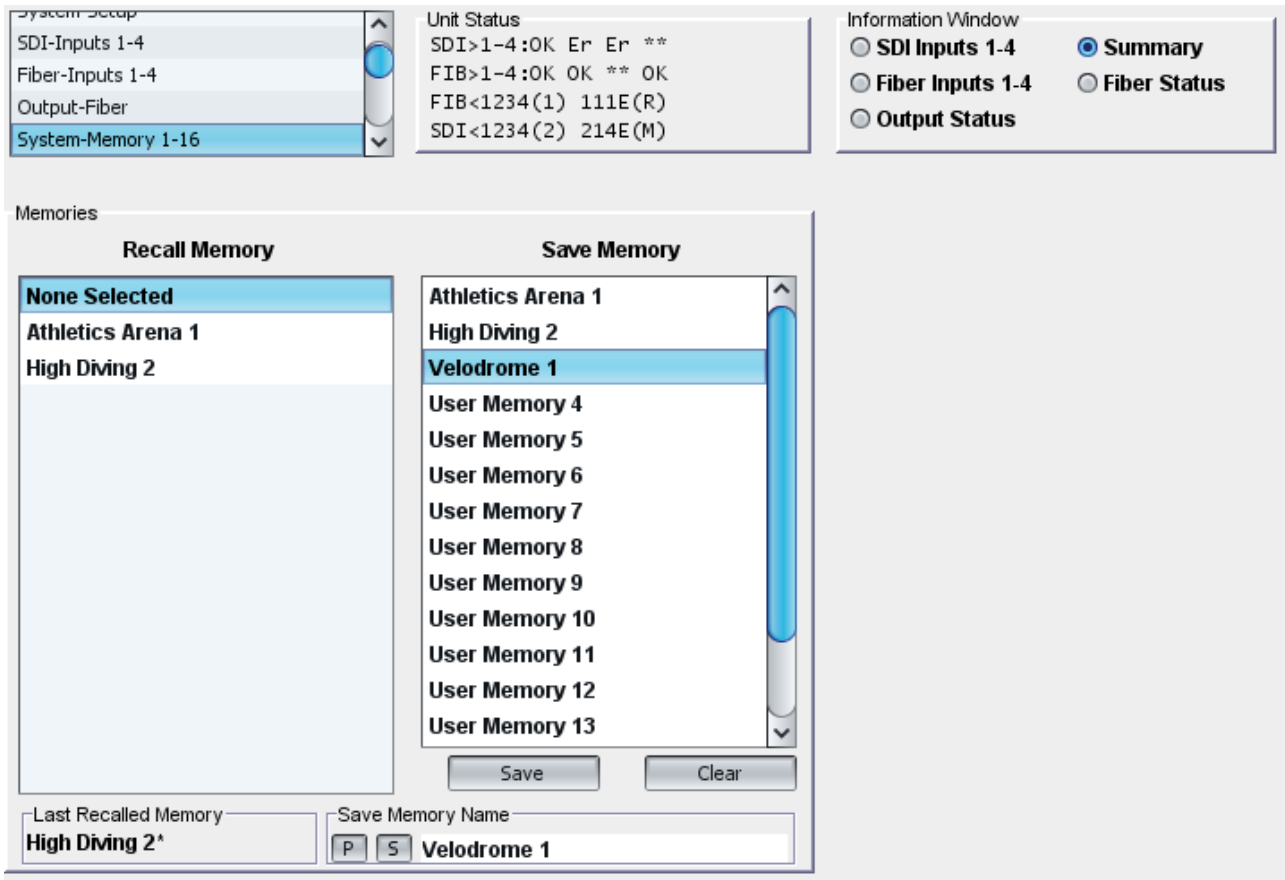

To save settings:

- In the **Save Memory** column, select a memory location, and then click **Save**. The current settings are saved and the memory appears in the **Recall Memory** column.

To change a memory name:

- In the **Save Memory Name** field, type the new memory name, and then click **S**. To return the memory to its default value, click the preset button (**P**).

Use the **Recall Memory** function to recall the settings saved in a memory location. **Last Recalled Memory** displays the most recently recalled memory. If a control is changed after a setup has been recalled, **Last Recalled Memory** will display an asterisk (*) beside the memory name.

To recall a memory:

- In the **Recall Memory** column, select the memory to recall. The recalled settings will be applied and the memory name will appear in the **Last Recalled Memory** section.

Logging

Logged parameters are made available to logging devices connected to the RollCall Network. They are also displayed on a number of RollCall Screens where they can selectively be switched off to prevent them being logged externally.

SDI Inputs 1-4

Fiber-Inputs 1-4

Output-Fiber

System-Memory 1-16

Logging-Misc

Unit Status

SDI>1-4:OK Er Er **

FIB>1-4:OK OK ** OK

FIB<1234(1) 111E(R)

SDI<1234(2) 214E(M)

Information Window

SDI Inputs 1-4 Summary

Fiber Inputs 1-4 Fiber Status

Output Status

Logging Misc

Log Enable	Log Field	Log Value
<input checked="" type="checkbox"/> OS Version	SN=	S12345678
<input checked="" type="checkbox"/> Build No.	OS_VERSION=	V115 Release
<input checked="" type="checkbox"/> Hardware Ver.	BUILD_NUMBER=	0003304836
<input checked="" type="checkbox"/> Firmware Ver.	HARDWARE_VERSION=	RKADM1Y
<input checked="" type="checkbox"/> Rear ID	FIRMWARE_VERSION=	0001.01.0001.01
<input checked="" type="checkbox"/> Rear Status	REAR_ID=	5
<input checked="" type="checkbox"/> Slot Width	REAR_STATUS=	OK
<input checked="" type="checkbox"/> Slot Start	SLOT_WIDTH=	1
<input checked="" type="checkbox"/> IO Mod 1 ID	SLOT_START=	12
<input checked="" type="checkbox"/> IO Mod 2 ID	IOMOD1_ID=	2:RKIOM8V4F
<input checked="" type="checkbox"/> Proc Mod ID	IOMOD2_ID=	0:None fitted
<input checked="" type="checkbox"/> Up Time	PROCMOD_ID=	SAACS RKPRMLED1Y
<input checked="" type="checkbox"/> Licensed Options	UPTIME=	000:00:27:00
	LICENSED_OPTIONS=	SDHD;3G

<div style="border: 1px solid gray; padding: 2px;"> <ul style="list-style-type: none"> Output-Fiber System-Memory 1-16 Logging-Misc <li style="background-color: #e0f0ff;">Logging-SDI 1-4 </div>	<div style="border: 1px solid gray; padding: 2px;"> <p>Unit Status</p> <p>SDI>1-4:OK Er Er **</p> <p>FIB>1-4:OK OK ** OK</p> <p>FIB<1234(1) 111E(R)</p> <p>SDI<1234(2) 214E(M)</p> </div>	<div style="border: 1px solid gray; padding: 2px;"> <p>Information Window</p> <p><input type="radio"/> SDI Inputs 1-4</p> <p><input checked="" type="radio"/> Summary</p> <p><input type="radio"/> Fiber Inputs 1-4</p> <p><input type="radio"/> Fiber Status</p> <p><input type="radio"/> Output Status</p> </div>																																																																																	
<p>Logging Control</p> <table border="1" style="width:100%; border-collapse: collapse;"> <thead> <tr> <th style="width:30%;">Log Enable</th> <th style="width:40%;">Log Field</th> <th style="width:30%;">Log Value</th> </tr> </thead> <tbody> <tr> <td colspan="3" style="padding: 2px;">Logging Config</td> </tr> <tr> <td style="padding: 2px;"><input checked="" type="checkbox"/> Config 1-4 In Use</td> <td style="padding: 2px;">CONFIG_1_4_INUSE=</td> <td style="padding: 2px;">1</td> </tr> <tr> <td colspan="3" style="padding: 2px;">Logging SDI 1</td> </tr> <tr> <td style="padding: 2px;"><input checked="" type="checkbox"/> Input Ident</td> <td style="padding: 2px;">INPUT_1_IDENT=</td> <td style="padding: 2px;">SERIAL IN 1</td> </tr> <tr> <td style="padding: 2px;"><input checked="" type="checkbox"/> Input Name</td> <td style="padding: 2px;">INPUT_1_NAME=</td> <td style="padding: 2px;">CHANNEL 1</td> </tr> <tr> <td style="padding: 2px;"><input checked="" type="checkbox"/> Input Type</td> <td style="padding: 2px;">INPUT_1_TYPE=</td> <td style="padding: 2px;">SD/HD/3G SDI</td> </tr> <tr> <td style="padding: 2px;"><input checked="" type="checkbox"/> Input State</td> <td style="padding: 2px;">INPUT_1_STATE=</td> <td style="padding: 2px;">OK</td> </tr> <tr> <td style="padding: 2px;"><input checked="" type="checkbox"/> Input SDI Bitrate</td> <td style="padding: 2px;">INPUT_1_SDIRATE=</td> <td style="padding: 2px;">1.5Gb/s</td> </tr> <tr> <td colspan="3" style="padding: 2px;">Logging SDI 2</td> </tr> <tr> <td style="padding: 2px;"><input checked="" type="checkbox"/> Input Ident</td> <td style="padding: 2px;">INPUT_2_IDENT=</td> <td style="padding: 2px;">SERIAL IN 2</td> </tr> <tr> <td style="padding: 2px;"><input checked="" type="checkbox"/> Input Name</td> <td style="padding: 2px;">INPUT_2_NAME=</td> <td style="padding: 2px;">CHANNEL 2</td> </tr> <tr> <td style="padding: 2px;"><input checked="" type="checkbox"/> Input Type</td> <td style="padding: 2px;">INPUT_2_TYPE=</td> <td style="padding: 2px;">SD/HD/3G SDI</td> </tr> <tr> <td style="padding: 2px;"><input checked="" type="checkbox"/> Input State</td> <td style="padding: 2px;">INPUT_2_STATE=</td> <td style="padding: 2px;">WARN:Error</td> </tr> <tr> <td style="padding: 2px;"><input checked="" type="checkbox"/> Input SDI Bitrate</td> <td style="padding: 2px;">INPUT_2_SDIRATE=</td> <td style="padding: 2px;">UNKNOWN</td> </tr> <tr> <td colspan="3" style="padding: 2px;">Logging SDI 3</td> </tr> <tr> <td style="padding: 2px;"><input checked="" type="checkbox"/> Input Ident</td> <td style="padding: 2px;">INPUT_3_IDENT=</td> <td style="padding: 2px;">SERIAL IN 3</td> </tr> <tr> <td style="padding: 2px;"><input checked="" type="checkbox"/> Input Name</td> <td style="padding: 2px;">INPUT_3_NAME=</td> <td style="padding: 2px;">CHANNEL 3</td> </tr> <tr> <td style="padding: 2px;"><input checked="" type="checkbox"/> Input Type</td> <td style="padding: 2px;">INPUT_3_TYPE=</td> <td style="padding: 2px;">SD/HD/3G SDI</td> </tr> <tr> <td style="padding: 2px;"><input checked="" type="checkbox"/> Input State</td> <td style="padding: 2px;">INPUT_3_STATE=</td> <td style="padding: 2px;">WARN:Error</td> </tr> <tr> <td style="padding: 2px;"><input checked="" type="checkbox"/> Input SDI Bitrate</td> <td style="padding: 2px;">INPUT_3_SDIRATE=</td> <td style="padding: 2px;">UNKNOWN</td> </tr> <tr> <td colspan="3" style="padding: 2px;">Logging SDI 4</td> </tr> <tr> <td style="padding: 2px;"><input checked="" type="checkbox"/> Input Ident</td> <td style="padding: 2px;">INPUT_4_IDENT=</td> <td style="padding: 2px;">SERIAL IN 4</td> </tr> <tr> <td style="padding: 2px;"><input checked="" type="checkbox"/> Input Name</td> <td style="padding: 2px;">INPUT_4_NAME=</td> <td style="padding: 2px;">CHANNEL 4</td> </tr> <tr> <td style="padding: 2px;"><input checked="" type="checkbox"/> Input Type</td> <td style="padding: 2px;">INPUT_4_TYPE=</td> <td style="padding: 2px;">SD/HD/3G SDI</td> </tr> <tr> <td style="padding: 2px;"><input checked="" type="checkbox"/> Input State</td> <td style="padding: 2px;">INPUT_4_STATE=</td> <td style="padding: 2px;">FAIL:Lost</td> </tr> <tr> <td style="padding: 2px;"><input checked="" type="checkbox"/> Input SDI Bitrate</td> <td style="padding: 2px;">INPUT_4_SDIRATE=</td> <td style="padding: 2px;">UNKNOWN</td> </tr> </tbody> </table>			Log Enable	Log Field	Log Value	Logging Config			<input checked="" type="checkbox"/> Config 1-4 In Use	CONFIG_1_4_INUSE=	1	Logging SDI 1			<input checked="" type="checkbox"/> Input Ident	INPUT_1_IDENT=	SERIAL IN 1	<input checked="" type="checkbox"/> Input Name	INPUT_1_NAME=	CHANNEL 1	<input checked="" type="checkbox"/> Input Type	INPUT_1_TYPE=	SD/HD/3G SDI	<input checked="" type="checkbox"/> Input State	INPUT_1_STATE=	OK	<input checked="" type="checkbox"/> Input SDI Bitrate	INPUT_1_SDIRATE=	1.5Gb/s	Logging SDI 2			<input checked="" type="checkbox"/> Input Ident	INPUT_2_IDENT=	SERIAL IN 2	<input checked="" type="checkbox"/> Input Name	INPUT_2_NAME=	CHANNEL 2	<input checked="" type="checkbox"/> Input Type	INPUT_2_TYPE=	SD/HD/3G SDI	<input checked="" type="checkbox"/> Input State	INPUT_2_STATE=	WARN:Error	<input checked="" type="checkbox"/> Input SDI Bitrate	INPUT_2_SDIRATE=	UNKNOWN	Logging SDI 3			<input checked="" type="checkbox"/> Input Ident	INPUT_3_IDENT=	SERIAL IN 3	<input checked="" type="checkbox"/> Input Name	INPUT_3_NAME=	CHANNEL 3	<input checked="" type="checkbox"/> Input Type	INPUT_3_TYPE=	SD/HD/3G SDI	<input checked="" type="checkbox"/> Input State	INPUT_3_STATE=	WARN:Error	<input checked="" type="checkbox"/> Input SDI Bitrate	INPUT_3_SDIRATE=	UNKNOWN	Logging SDI 4			<input checked="" type="checkbox"/> Input Ident	INPUT_4_IDENT=	SERIAL IN 4	<input checked="" type="checkbox"/> Input Name	INPUT_4_NAME=	CHANNEL 4	<input checked="" type="checkbox"/> Input Type	INPUT_4_TYPE=	SD/HD/3G SDI	<input checked="" type="checkbox"/> Input State	INPUT_4_STATE=	FAIL:Lost	<input checked="" type="checkbox"/> Input SDI Bitrate	INPUT_4_SDIRATE=	UNKNOWN
Log Enable	Log Field	Log Value																																																																																	
Logging Config																																																																																			
<input checked="" type="checkbox"/> Config 1-4 In Use	CONFIG_1_4_INUSE=	1																																																																																	
Logging SDI 1																																																																																			
<input checked="" type="checkbox"/> Input Ident	INPUT_1_IDENT=	SERIAL IN 1																																																																																	
<input checked="" type="checkbox"/> Input Name	INPUT_1_NAME=	CHANNEL 1																																																																																	
<input checked="" type="checkbox"/> Input Type	INPUT_1_TYPE=	SD/HD/3G SDI																																																																																	
<input checked="" type="checkbox"/> Input State	INPUT_1_STATE=	OK																																																																																	
<input checked="" type="checkbox"/> Input SDI Bitrate	INPUT_1_SDIRATE=	1.5Gb/s																																																																																	
Logging SDI 2																																																																																			
<input checked="" type="checkbox"/> Input Ident	INPUT_2_IDENT=	SERIAL IN 2																																																																																	
<input checked="" type="checkbox"/> Input Name	INPUT_2_NAME=	CHANNEL 2																																																																																	
<input checked="" type="checkbox"/> Input Type	INPUT_2_TYPE=	SD/HD/3G SDI																																																																																	
<input checked="" type="checkbox"/> Input State	INPUT_2_STATE=	WARN:Error																																																																																	
<input checked="" type="checkbox"/> Input SDI Bitrate	INPUT_2_SDIRATE=	UNKNOWN																																																																																	
Logging SDI 3																																																																																			
<input checked="" type="checkbox"/> Input Ident	INPUT_3_IDENT=	SERIAL IN 3																																																																																	
<input checked="" type="checkbox"/> Input Name	INPUT_3_NAME=	CHANNEL 3																																																																																	
<input checked="" type="checkbox"/> Input Type	INPUT_3_TYPE=	SD/HD/3G SDI																																																																																	
<input checked="" type="checkbox"/> Input State	INPUT_3_STATE=	WARN:Error																																																																																	
<input checked="" type="checkbox"/> Input SDI Bitrate	INPUT_3_SDIRATE=	UNKNOWN																																																																																	
Logging SDI 4																																																																																			
<input checked="" type="checkbox"/> Input Ident	INPUT_4_IDENT=	SERIAL IN 4																																																																																	
<input checked="" type="checkbox"/> Input Name	INPUT_4_NAME=	CHANNEL 4																																																																																	
<input checked="" type="checkbox"/> Input Type	INPUT_4_TYPE=	SD/HD/3G SDI																																																																																	
<input checked="" type="checkbox"/> Input State	INPUT_4_STATE=	FAIL:Lost																																																																																	
<input checked="" type="checkbox"/> Input SDI Bitrate	INPUT_4_SDIRATE=	UNKNOWN																																																																																	

<ul style="list-style-type: none"> System-Memory 1-16 Logging-Misc Logging-SDI 1-4 <li style="background-color: #e0f0ff;">Logging-SDI 5-8 Logging-Fiber Test 1-4 	<p>Unit Status</p> <p>SDI>1-4:OK Er Er **</p> <p>FIB>1-4:OK OK ** OK</p> <p>FIB<1234(1) 111E(R)</p> <p>SDI<1234(2) 214E(M)</p>	<p>Information Window</p> <p><input type="radio"/> SDI Inputs 1-4</p> <p><input type="radio"/> Fiber Inputs 1-4</p> <p><input type="radio"/> Output Status</p> <p><input checked="" type="radio"/> Summary</p> <p><input type="radio"/> Fiber Status</p>
---	--	---

Logging Control

Log Enable	Log Field	Log Value
-Logging Config		
<input checked="" type="checkbox"/> Config 5-8 In Use	CONFIG_5_8_INUSE=	2
-Logging SDI 5		
<input checked="" type="checkbox"/> Input Ident	INPUT_5_IDENT=	FIBER IN 1
<input checked="" type="checkbox"/> Input Name	INPUT_5_NAME=	CHANNEL 5
<input checked="" type="checkbox"/> Input Type	INPUT_5_TYPE=	SD/HD/3G SDI
<input checked="" type="checkbox"/> Input State	INPUT_5_STATE=	OK
<input checked="" type="checkbox"/> Input SDI Bitrate	INPUT_5_SDIRATE=	1.5Gb/s
-Logging SDI 6		
<input checked="" type="checkbox"/> Input Ident	INPUT_6_IDENT=	FIBER IN 2
<input checked="" type="checkbox"/> Input Name	INPUT_6_NAME=	CHANNEL 6
<input checked="" type="checkbox"/> Input Type	INPUT_6_TYPE=	SD/HD/3G SDI
<input checked="" type="checkbox"/> Input State	INPUT_6_STATE=	OK
<input checked="" type="checkbox"/> Input SDI Bitrate	INPUT_6_SDIRATE=	1.5Gb/s
-Logging SDI 7		
<input checked="" type="checkbox"/> Input Ident	INPUT_7_IDENT=	FIBER IN 3
<input checked="" type="checkbox"/> Input Name	INPUT_7_NAME=	CHANNEL 7
<input checked="" type="checkbox"/> Input Type	INPUT_7_TYPE=	SD/HD/3G SDI
<input checked="" type="checkbox"/> Input State	INPUT_7_STATE=	FAIL:Lost
<input checked="" type="checkbox"/> Input SDI Bitrate	INPUT_7_SDIRATE=	UNKNOWN
-Logging SDI 8		
<input checked="" type="checkbox"/> Input Ident	INPUT_8_IDENT=	FIBER IN 4
<input checked="" type="checkbox"/> Input Name	INPUT_8_NAME=	CHANNEL 8
<input checked="" type="checkbox"/> Input Type	INPUT_8_TYPE=	SD/HD/3G SDI
<input checked="" type="checkbox"/> Input State	INPUT_8_STATE=	OK
<input checked="" type="checkbox"/> Input SDI Bitrate	INPUT_8_SDIRATE=	1.5Gb/s

Logging-SDI 1-4

Logging-SDI 5-8

Logging-Fiber Tx 1-4

Logging-Fiber Rx 1-4

Custom Ball Tools

Unit Status

SDI>1-4:OK Er Er **

FIB>1-4:OK OK ** OK

FIB<1234(1) 111E(R)

SDI<1234(2) 214E(M)

Information Window

SDI Inputs 1-4

Fiber Inputs 1-4

Output Status

Summary

Fiber Status

Logging Control

Log Enable	Log Field	Log Value
Logging Fiber Tx 1		
<input checked="" type="checkbox"/> Laser Bias State	OUTPUT_1_LASER_BIAS_STATE=	OK
<input checked="" type="checkbox"/> Laser Bias Current	OUTPUT_1_LASER_BIAS=	29.2mA
<input checked="" type="checkbox"/> Tx Power State	OUTPUT_1_TX_POWER_STATE=	OK
<input checked="" type="checkbox"/> Tx Power	OUTPUT_1_TX_POWER=	-2.4dBm
<input checked="" type="checkbox"/> Wavelength	OUTPUT_1_WAVELENGTH=	1310nm
<input checked="" type="checkbox"/> Tx SFP Status	OUTPUT_1_SFP=	OK
Logging Fiber Tx 2		
<input checked="" type="checkbox"/> Laser Bias State	OUTPUT_2_LASER_BIAS_STATE=	OK
<input checked="" type="checkbox"/> Laser Bias Current	OUTPUT_2_LASER_BIAS=	28.2mA
<input checked="" type="checkbox"/> Tx Power State	OUTPUT_2_TX_POWER_STATE=	OK
<input checked="" type="checkbox"/> Tx Power	OUTPUT_2_TX_POWER=	-2.9dBm
<input checked="" type="checkbox"/> Wavelength	OUTPUT_2_WAVELENGTH=	1310nm
<input checked="" type="checkbox"/> Tx SFP Status	OUTPUT_2_SFP=	OK
Logging Fiber Tx 3		
<input checked="" type="checkbox"/> Laser Bias State	OUTPUT_3_LASER_BIAS_STATE=	OK
<input checked="" type="checkbox"/> Laser Bias Current	OUTPUT_3_LASER_BIAS=	20.2mA
<input checked="" type="checkbox"/> Tx Power State	OUTPUT_3_TX_POWER_STATE=	OK
<input checked="" type="checkbox"/> Tx Power	OUTPUT_3_TX_POWER=	-1.9dBm
<input checked="" type="checkbox"/> Wavelength	OUTPUT_3_WAVELENGTH=	1310nm
<input checked="" type="checkbox"/> Tx SFP Status	OUTPUT_3_SFP=	OK
Logging Fiber Tx 4		
<input checked="" type="checkbox"/> Laser Bias State	OUTPUT_4_LASER_BIAS_STATE=	OK:OFF
<input checked="" type="checkbox"/> Laser Bias Current	OUTPUT_4_LASER_BIAS=	-
<input checked="" type="checkbox"/> Tx Power State	OUTPUT_4_TX_POWER_STATE=	OK:OFF
<input checked="" type="checkbox"/> Tx Power	OUTPUT_4_TX_POWER=	-
<input checked="" type="checkbox"/> Wavelength	OUTPUT_4_WAVELENGTH=	1310nm
<input checked="" type="checkbox"/> Tx SFP Status	OUTPUT_4_SFP=	OK

Log Enable	Log Field	Log Value
Logging Fiber Rx 1		
<input checked="" type="checkbox"/> Rx Power State	INPUT_5_RX_POWER_STATE=	OK
<input checked="" type="checkbox"/> Rx Power	INPUT_5_RX_POWER=	-2.2dBm
<input checked="" type="checkbox"/> Rx SFP Status	INPUT_5_SFP=	OK
Logging Fiber Rx 2		
<input checked="" type="checkbox"/> Rx Power State	INPUT_6_RX_POWER_STATE=	OK
<input checked="" type="checkbox"/> Rx Power	INPUT_6_RX_POWER=	-2.7dBm
<input checked="" type="checkbox"/> Rx SFP Status	INPUT_6_SFP=	OK
Logging Fiber Rx 3		
<input checked="" type="checkbox"/> Rx Power State	INPUT_7_RX_POWER_STATE=	FAIL:LOW
<input checked="" type="checkbox"/> Rx Power	INPUT_7_RX_POWER=	< -40.0dBm
<input checked="" type="checkbox"/> Rx SFP Status	INPUT_7_SFP=	OK
Logging Fiber Rx 4		
<input checked="" type="checkbox"/> Rx Power State	INPUT_8_RX_POWER_STATE=	OK
<input checked="" type="checkbox"/> Rx Power	INPUT_8_RX_POWER=	-1.8dBm
<input checked="" type="checkbox"/> Rx SFP Status	INPUT_8_SFP=	OK

Each logging screen comprises three columns:

- **Log Enable:** Select the check boxes that correspond to the parameters for which log information should be collected.
- **Log Field:** Displays the name of the logging field.
- **Log Value:** Displays the current log value.

NOTE: In the transceiver products, although on the module rear and in the RollCall screens the SDI inputs are designated SDI Input 1-4 and the Fiber inputs are designated Fiber Input 1-4, in the logging, the SDI input channels are logged as channels 1-4 and the fiber receiver channels are logged as channels 5-8.

RollCall Log Fields

Log Field	Log Description	Log Value (example)
SN=	<Serial number>	S13400781
OS_VERSION=	<Operating system version>	V115 Release
BUILD_NUMBER=	<Software build number>	0003304836
HARDWARE_VERSION=	<Hardware version number>	RKADM1Y
FIRMWARE_VERSION=	<Firmware version number>	0001.01.0001.01
REAR_ID=	<Rear panel type>	5
REAR_STATUS=	<Validity of rear panel type>	OK
		WARN:Mismatch
SLOT_WIDTH=	<Width of rear panel>	1
SLOT_START=	<Module slot number>	12
IOMOD1_ID=	<1 st I/O module type>	1:RKIOM4V2F
IOMOD2_ID=	<2 nd I/O module type>	0:None fitted
UPTIME=	<Time since last restart in days:hrs:mins:sec>	001:23:35:00
LICENSED_OPTIONS=	<License file information>	SDHD
		SDHD:3G
		FAIL:Bad File
		WARN:NONE
		FAIL:NoFile
CONFIG_1_4_INUSE=	<Routing configuration for SDI Inputs 1-4>	1
		2
CONFIG_5_8_INUSE=	<Routing configuration for Fiber Inputs 1-4>	1
		2
INPUT_1_IDENT	<Fixed input identifier>	SERIAL IN 1
...
INPUT_8_IDENT	<Fixed input identifier>	FIBER IN 4
INPUT_1_NAME	<Editable input name>	CHANNEL 1 (default)
...
INPUT_8_NAME	<Editable input name>	CHANNEL 8 (default)
INPUT_1_TYPE	<Input type>	SD/HD/3G SDI
...
INPUT_8_TYPE	<Input type>	SD/HD/3G SDI
INPUT_1_STATE	<Input state>	OK
		FAIL:Lost
		WARN:Error
		WARN:Unrouted
		FAIL:Lost
		WARN:Error
		<blank> (SFP fit error)
...	...	
INPUT_8_STATE	<Input state>	
INPUT_1_SDIRATE	<Input bit rate>	UNKNOWN
		270Mb/s
		1.5Gb/s
		3.0Gb/s
...	...	
INPUT_8_SDIRATE	<Input bit rate>	
OUTPUT_1_SFP	<SFP fit status for Fiber O/P 1>	OK
		<blank> No SFP Required (TR99)
		ERR:Rx
		ERR:No Tx
		ERR:Extra Tx (TR99)
		ERR:Wrong W/L
		WARN:W/L Order
		WARN:Elec Tx
		ERR:UNKNOWN
...	...	
OUTPUT_4_SFP	<SFP fit status for Fiber O/P 4>	
INPUT_5_SFP	<SFP fit status for Fiber I/P 1>	OK
		<blank> No SFP Required (TR99)
		ERR:Tx
		ERR:No Rx
		ERR:Extra Rx (TR99)
		WARN:Elec Rx
		ERR:UNKNOWN
...	...	
INPUT_8_SFP	<SFP fit status for Fiber I/P 4>	

OUTPUT_1_LASER_BIAS_STATE	<Tx SFP 1 laser bias current alarm/warning state>	OK
		WARN:LOW
		FAIL:LOW
		WARN:HI
		FAIL:HI
		OK:OFF
		<blank> (SFP fit error)
...		
OUTPUT_4_LASER_BIAS_STATE	<Tx SFP 4 laser bias current alarm/warning state>	
OUTPUT_1_LASER_BIAS	<Tx SFP 1 laser bias current>	28.5mA
...
OUTPUT_4_LASER_BIAS	<Tx SFP 4 laser bias current>	28.5mA
OUTPUT_1_TX_POWER_STATE	<Tx SFP 1 laser power alarm/warning state>	OK
		WARN:LOW
		FAIL:LOW
		WARN:HI
		FAIL:HI
		OK:OFF
		<blank> (SFP fit error)
...	...	
OUTPUT_4_TX_POWER_STATE	<Tx SFP 4 laser power alarm/warning state>	
OUTPUT_1_TX_POWER	<Tx SFP 1 laser power>	
...
OUTPUT_4_TX_POWER	<Tx SFP 4 laser power>	-2.4dBm
OUTPUT_1_WAVELENGTH	<Tx SFP 1 wavelength>	1310nm
...
OUTPUT_4_WAVELENGTH	<Tx SFP 4 wavelength>	1310nm
INPUT_5_RX_POWER_STATE	<Rx SFP 1 power alarm/warning state>	OK
		WARN:LOW
		FAIL:LOW
		WARN:HI
		FAIL:HI
		<blank> (SFP fit error)
...	...	
INPUT_8_RX_POWER_STATE	<Rx SFP 4 power alarm/warning state>	
INPUT_5_RX_POWER	<Rx SFP 1 power>	-4.1dBm
...
INPUT_8_RX_POWER	<Rx SFP 4 power>	-4.1dBm

System-RollTrack Screen

The RollTrack settings allow information to be sent, by means of the RollCall network, to other compatible units on the same network.

Use the settings on the **RollTrack** screen to:

- Enable or disable the RollTrack functions.
- Configure up to 16 RollTrack outputs.
- Specify the conditions that trigger RollTrack data transmission.
- Set RollTrack destinations.
- Specify the RollTrack commands to be sent.

RollTrack Sources

The RollTrack Source specifies the source of the information that triggers the transmission of data.

RollTrack Addresses

The full RollTrack Address comprises four sets of numbers. For example, 0000:10:01*99.

The first set, 0000 in the example, is the network segment code number.

The second set, 10 in the example, identifies the (enclosure/mainframe) unit.

The third set, 01 in the example, identifies the slot number in the unit.

The fourth set, 99 in the example, is a user-configured number that uniquely identifies the destination unit in a multi-unit system. This ensures that only the correct unit responds to commands. If left at 00, an incorrectly fitted unit may respond inappropriately.

RollTrack Commands

Each RollTrack command comprises two sets of numbers, for example, 33039:3. The first set, 33039 in the example, is the RollTrack command number, which identifies the command. The second set, 3 in the example, is the value that is sent with the command.

Using RollTracks

To enable or disable RollTrack functions:

- To disable RollTrack functions, select the Disable All check box.
- To enable the RollTrack functions, clear the Disable All check box.

To configure a RollTrack action:

1. Select the **Index** number. This identifies the RollTrack action being configured. Up to 32 RollTrack actions can be created.
2. From the **Source** list, select the source of the information that will trigger RollTrack transmission.
3. Enter the RollTrack **Address** and click **S**. To return the address to its default value, click the preset button (**P**).
4. Enter the RollTrack **Command** and click **S**. To return the value to its default, click the preset button (**P**).

Viewing RollTrack Information

RollTrack Sending and **RollTrack Status** display information about the status of RollTracks.

RollTrack Sending displays the information when the unit is actively sending a RollTrack command:

- **No**: The command is not being sent.
- **Yes**: The command is being sent.

RollTrack Status displays the status of the currently selected RollTrack Index:

- **OK**: RollTrack message sent and received OK.
- **Unknown**: RollTrack message has been sent but has not yet completed.
- **Timeout**: RollTrack message sent, but acknowledgement not received. This could be because the destination unit is not at the specified location.
- **Bad**: RollTrack message has not been sent correctly, acknowledged at the destination unit. This could be because the destination unit is not of the type specified.
- **Disabled**: RollTrack sending is disabled.