

HD/SD-SDI Distribution Amplifier with Hyperion™ Content Monitoring



Table of Contents

Module Description	2	PID.....	43
Rear Panel Views	2	Alarm Enable Summary.....	47
Block Diagram	4	Setup	48
Features	5	Memory.....	49
Technical Profile	6	On Screen Display.....	50
INPUTS	8	Log Misc	52
Serial Digital Video Input.....	8	Log Input 1 Monitor 1 and 2	52
OUTPUTS	8	Log Input 1 Aud State.....	53
Serial Digital Video Outputs	8	Log Input 1 Aud Type	53
CARD EDGE INDICATORS	9	Log Input 1 Dolby E State	53
Thumbnailing	9	Log Input 1 Aud Bit Depth	54
Alarm Overview	10	Log Input 1 Aud Level.....	54
On-Screen Display Overview	11	Log Input 1 Aud Clipping	54
RollCall PC Control Panel Screens	14	Log Input 1 Aud Likeness	55
Black/Blackish	14	Log Input 1 UMID/PID	55
Stillish/Freeze	19	Log Output 1 UMID/PID	55
Video Monitor	24	RollCall Logging Priorities	56
Closed Captions	26	RollTrack	57
Ancillary Data	28	Unit Status	59
WSS / VI AFD.....	31	ROLLCALL LOG FIELDS.....	60
Audio Data.....	32	Operation from an Active Control Panel	65
Group 1 to 4	32	Hyperion - an Overview	66
Audio Level Detectors	34	Audio Likeness Detector	67
Audio Level Indicators	39	Unique Material Identifier (UMID)	69
Audio Likeness	40	Manual Revision Record	72
UMID	41		

Hyperion, Snell & Wilcox, IQ Modular and RollCall are trademarks of the Snell & Wilcox Group.
All other trademarks mentioned herein are duly acknowledged.

Module Description

The IQSDA02 is an HD/SD-SDI distribution amplifier with revolutionary Hyperion content QC capability. Hyperion is designed to continuously and automatically monitor signal content providing verification of whether legal and technical obligations are being met and to provide guidance as to whether the content is within the required parameters to be considered as valid. For video factors such as motion level within the content, the amount of darkness and amount of picture color are monitored. For audio factors including Dolby D/E or PCM audio presence, likeness and level information such as silent, quiet, loud and overload are reported.

Picture regions can be monitored to allow for animated logos and onscreen graphics such as crawls. Alarm thresholds can all be adjusted allowing profiles to be set by the user for different material types (genres). Content may be tracked through the broadcast chain by the insertion and reading of SMPTE UMIDs or Internal House Number, title and duration metadata. This data can be used to track content, verify that the correct content is being transmitted and even frame count the duration of every piece of content to ensure contractual obligations are being met.

For remote content identification, delivery of video thumbnail images and audio level monitoring provide a secondary manual level of confidence that content is correct at both internal and remote locations.

All alarms from this product can be integrated into the major Video display wall processors to streamline alarm reporting and reported through RollMap Infrastructure Management system or via SNMP to other vendor Control & Monitoring systems.

Rear Panel Views

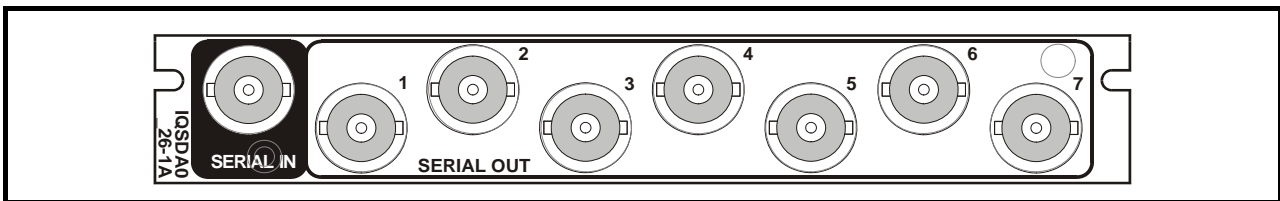

IQSDA0226-1A

HD/SD-SDI Distribution Amplifier with Hyperion Content Monitoring. 7 outputs. Single width module

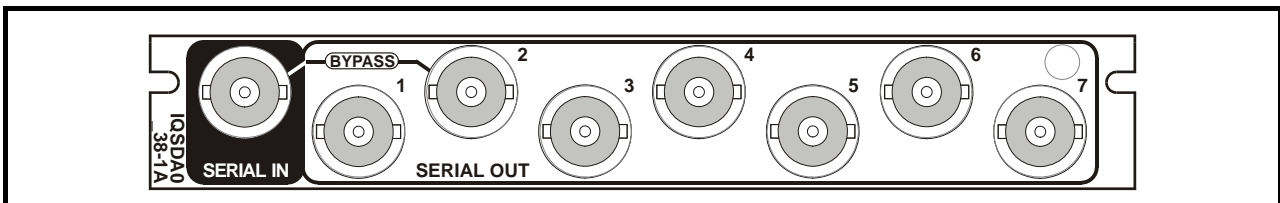

IQSDA0238-1A

HD/SD-SDI Distribution Amplifier with Hyperion Content Monitoring and relay input bypass. 7 outputs. Single width module

Note:

The relay bypass exists between the Serial Input and Output 2 only. In the event of module removal, power failure, or certain types of module failure, the signal from Serial In to Output 2 will be able to bypass the module.

These modules can only be fitted into 'A' style enclosures as shown below.

Enclosure order codes IQH3A-S-0, IQH3A-S-P



Enclosure order codes IQH3A-E-0, IQH3A-E-P, IQH3A-0-0, IQH3A-0-P

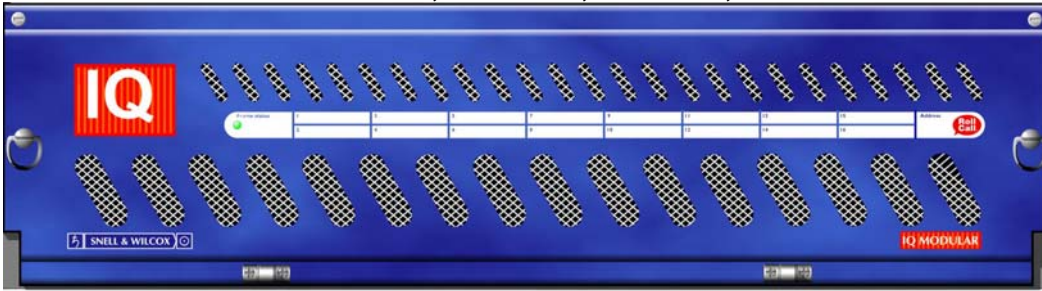

Enclosure order code IQH1A-S-P



Block Diagram

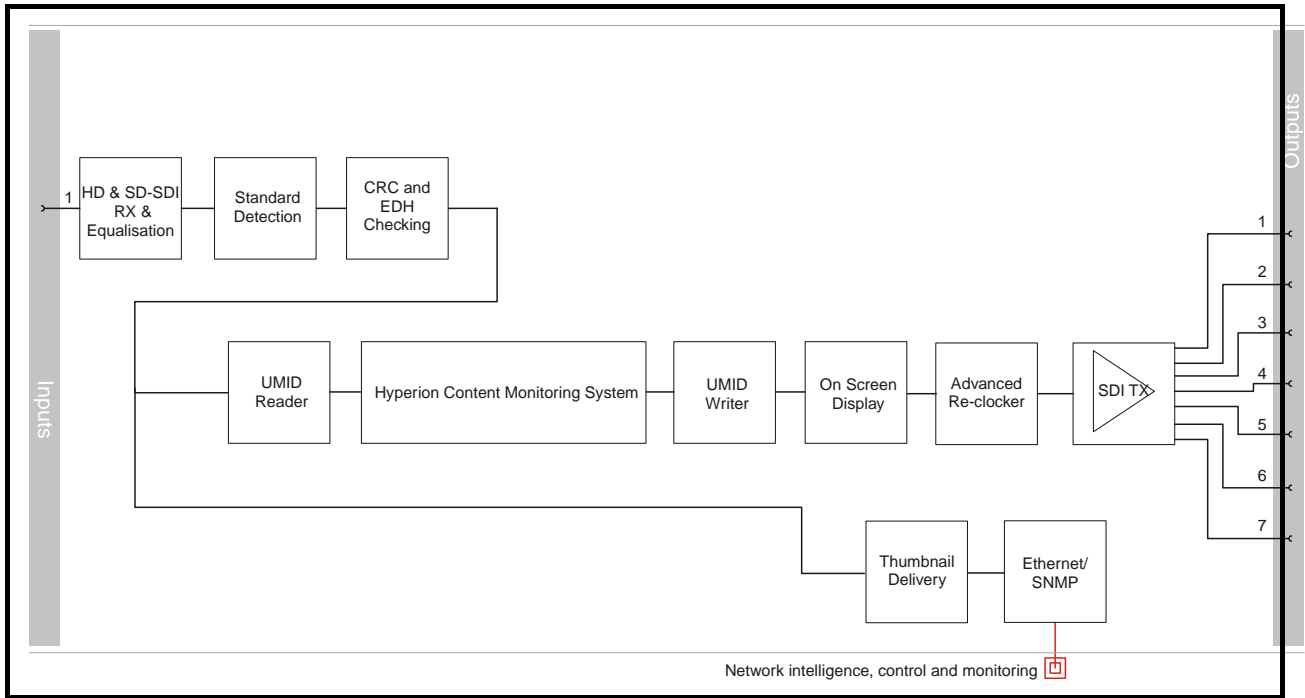

Features

- Intelligent HD-SDI and SD-SDI re-clocking distribution amplifier with integrated Hyperion QC monitoring
- Automated content QC, suited to:
 - Multi-channel playout facilities and complimentary monitoring of high value content
 - Automated ingest processes including timecode logging for accurate location of Hyperion alarms
 - Remote location monitoring such as business continuity sites and unmanned teleport facilities
- Real Time content QC against genre profiles ensure any on air issues are identified with minimal potential impact on revenue, such as scheduling errors or dropped frames on commercial content
- Remote monitoring over TCP/IP via video Thumbnails
- Legal & Technical validation of signal including detection and reporting of closed captions, content advisory rating, XDS Program data
- Automated ingest QC significantly increases throughput efficiency over manual QC processes
- Distribute low cost Hyperion QC capability throughout your facilities by deploying the IQSDA02 as your standard DA technology
- Useful for critical installation thanks to outstanding input equalization capability of up to 140 m at 1.5 Gbit/s and up to 350 m at 270 Mbit/s of Belden 1694A cable
- Standards supported:
 - 625/50, 525/59
 - 720/50p, 1080/25i
 - 720/59p, 1080/29i
- Can be used for current SD systems that will later upgrade to HD
- Sophisticated Hyperion content quality management tools allow true assessment of the value of the signal, not just presence, ideal for unmanned and low-manning operations
- Reporting of all detected alarms via RollMap Infrastructure Management System or via SNMP to other vendor control and automation systems
- Hyperion alarm data integrates with all major Video display wall processors to streamline alarm reporting in playout facilities

Technical Profile

Inputs & Outputs

Signal Input

Electrical1.5Gbit/s HD-SDI, SMPTE 292M
270 Mbit/s SDI, SMPTE 259M-C

Connector / FormatBNC/ 75ohm panel jack on
standard S&W connector panel

Input Cable Length.....Up to 140m Belden 1694A @
1.5 Gbit/s
(40m input cable length and 35m
output cable length, relay bypass
version. Belden 1694A @
1.5 Gbit/s)
Up to 350m Belden 1694A @
270 Mbit/s

Note: Specified cable lengths are a guide only. Exact cable length performance will depend on the quality of the cable used, the SDI video rate and the system setup. It is advisable not to cascade modules using the relay rear version although it may be possible if the interconnecting cable lengths are kept to an absolute minimum.

Return loss> -15dB

Relay bypass versions

Input Return Loss:> -8dB (When not in BYPASS mode)

Output Return Loss:> -8dB (When not in BYPASS mode)

Signal Outputs

Electrical1.5 Gbit/s HD-SDI, SMPTE 292M
270 Mbit/s SDI, SMPTE 259M-C

Connector / FormatBNC/ 75ohm panel jack on
standard S&W connector panel

HD / SD-SDI Outputsx 7

Return loss> -15dB

Controls

Indicators

PowerOK (Green)
 CPU.....OK (Flashing)
 FPGAOK (Flashing)
 Content Status Summary....OK (Green)
 Warning (Yellow)
 Error (Red)

Functions

VideoVideo Thumbnails over TCP/IP
 Motion Level (Stillish)
 Picture Darkness (Blackish)
 CRC/EDH Reporting
 Average Picture Level
 Luma High/Low
 Chroma High/Low
 Chroma/Luma Underflow
 Video Bit Depth
 Black
 Input Status
 Input Standard
 Freeze Detect

AudioAudio Presence
 Audio Type Detection (PCM, Non-PCM, Dolby E, AC3, MPEG Audio (SMPTE 338M)
 Audio Bit Depth
 Audio Level Metering
 Audio Silence
 Audio Quiet
 Audio Loud
 Audio Overload
 Audio Out of Phase (Polarity)
 Audio Mono/Stereo Detection

MetadataSMPTE UMID
 (Insert, Report & Scrub)
 Program ID
 House Number Watermarking
 (Insert, Report & Scrub)
 Closed Captions Detection
 (CEA608, CEA708)
 Signaling detection (WSS, AFD (inc SMPTE 2016), VI)
 Content Advisory Rating
 (XDS, V-chip)
 ANC Timecode (720p, 1080i)
 VITC Timecode (525, 625)
 User Definable ANC Detectors
 Dolby E Guardband reporting
 Timecode Logging

On Screen DisplayPicture Region Configuration
 On/Off
 Audio Level Meters
 Audio Presence & Type
 Content advisory system & rating
 2 x 19 character caption generators
 Timecode display
 Average picture level

User Memories16 x Save / Recall / Rename

Specifications

Electrical

Standards supported:.....625/50, 525/59
 1080/25i, 1080/29i,
 720/50p, 720/59p

Power Consumption

Module Power Consumption
 7 W Max
 7.5 W max – Relay Bypass Version

INPUTS

Serial Digital Video Input

The serial digital input to the unit is made via this BNC connector which terminates in 75 Ohms.



OUTPUTS

Serial Digital Video Outputs

These are the 7 Serial Digital outputs of the unit via BNC connectors for 75 Ohms.

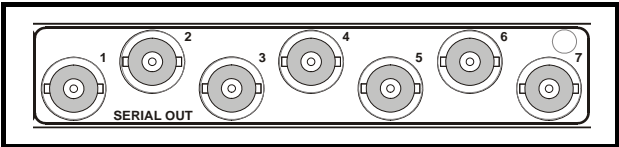

CARD EDGE INDICATORS



LED INDICATORS

+Power and -Power

When illuminated these LED's indicate that the positive and negative supplies are present.

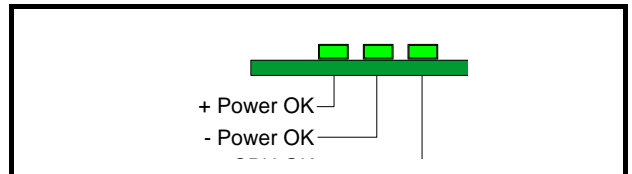

CPU OK

This LED will flash to indicate that the CPU is running

Error (Red)

This will become illuminated if there is no Input.

Warning (Yellow)

When illuminated this will indicate that CRC or EDH errors being detected.

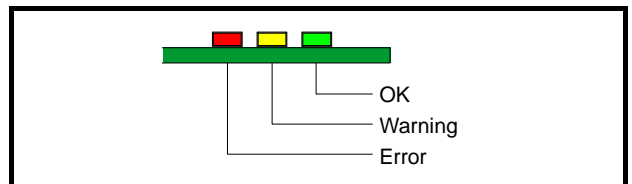

OK (Green)

When illuminated this will indicate that the module has a valid input signal.

Thumbnailing

The Hyperion Distribution amplifier is capable of generating Video thumbnails from the incoming video stream and sending them over Ethernet to be received and displayed on a RollMap client PC.

If the IQSDA02 detects an input lost the thumbnail will show a blue screen and display the caption INPUT:LOST.

Standard definition (525 NTSC/ 625 PAL) sourced thumbnail images are sent at a preset size of 60 x 48 although these can be enlarged within the RollMap client.

Note: The IQ enclosure containing the Hyperion DA must have an Ethernet-equipped gateway and be connected to the network via ETHERNET cable. It cannot send thumbnails over ARCNET.

High definition HD-SDI sourced thumbnail images are sent at a preset size of 72 x 42 pixels, although these can be enlarged within the RollMap client.

The gateway software version must be V5.x or later, and this requires a gateway PCB version RCIF3U2B or later

The rate at which the thumbnails are sent, and hence the refresh rate of the viewed thumbnails will depend on the number of Hyperion cards in the rack generating thumbnails. The more cards generating thumbnails, the slower the refresh rate.

Ethernet gateways on RCIF3U2Y PCBs, running software V1.x or V2.x or V3.x will not support thumbnails, and cannot be software upgraded to support thumbnails; however they can be upgraded with a current gateway PCB.

Alarm Overview

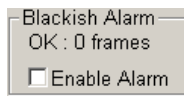
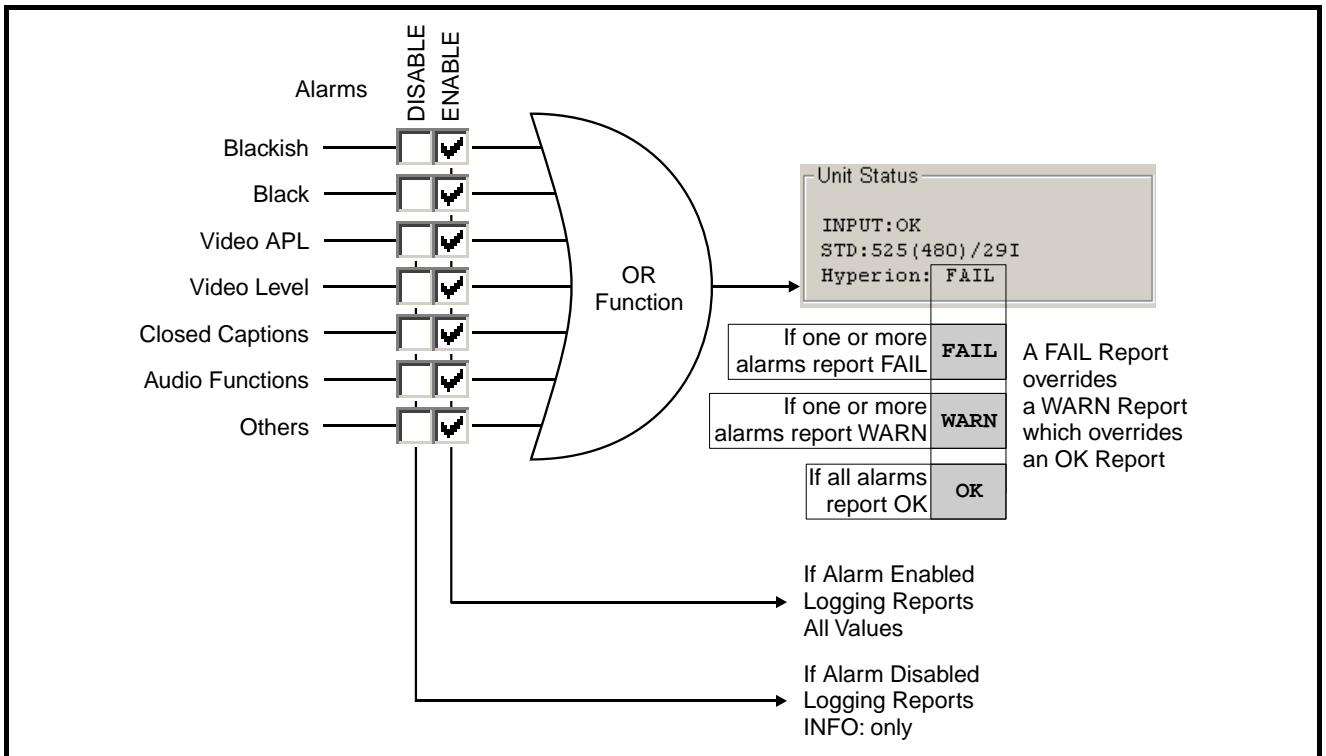

Disabled.

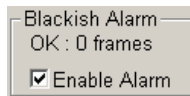

Enabled (Default)



Disabled.

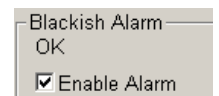

Enabled (Default)

When an alarm is disabled the detector still operates in the background but only reports INFO for logging.

When the alarm is enabled the detector reports all values for logging.

All alarms are monitored and the result is the Hyperion report with the following priority:

If all alarms report OK the result is OK.

If one or more alarm reports WARN the result is WARN and overrides any OK reports.

If one or more alarm reports FAIL the result is FAIL and overrides any WARN or OK reports.

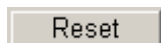

Selecting **Reset** will restart the fail count from zero.

Note that if the Enable Updates box is unchecked



the fail count will not appear.

Time Code Logging

If the source signal has a time code, when an alarm occurs this code is recorded in the log.

On-Screen Display Overview

A HYPERION parameter with a detector window can either detect the parameter inside the window, outside the window or over the entire screen. The controls that define the detector window are x and y start co-ordinates within the active area of the picture, and two length parameters, Width and Height. For details of how to set up the window please see page 50.

When a window is selected (see page 50), the windowed area defined by the controls below will be visible on the outgoing video.

Using the **On Screen Display Enables** (see page 50), other functions may also be displayed on-screen. These are:

Hyperion Status Indicators

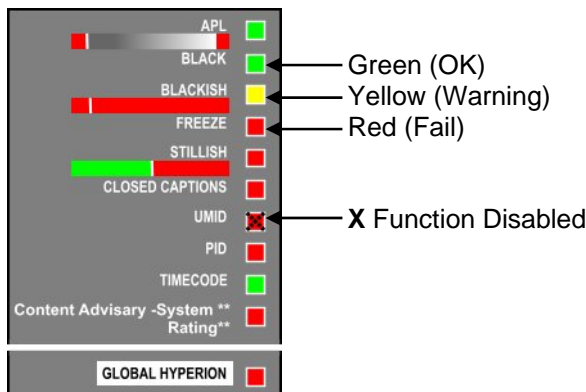

When **Indicators** is checked the items shown above will appear on the screen. The indicators shown are for HD; 525 will also show VI and 625 will show VI and WSS.

The boxes on the right hand side will show the Hyperion status with the following color-coding:

Green

The module has not detected a condition that has exceeded the threshold set by the Warning/Fail temporal controls. This is reported as **OK**.

Yellow

The module has detected a condition that has exceeded the threshold set by the Warning/Fail temporal controls. This is reported as a **Warning**.

Red

The module has detected a condition that has exceeded the threshold set by the Fail temporal controls. This is reported as a **Fail**.

If the box contains an **X** this indicates that the function disabled.

Bargraph Displays

Also shown will be real time bar graph displays of the detected values for the Stillish and Blackish detectors.

The green portion of the bar represents the value of the detected parameter.

For example, for the Stillish detector, when the bar is all red a video freeze has been detected.

The white bar represents the user threshold setting. Maximum is towards the right hand end, minimum (a video freeze) is towards the left hand end.

There is also a real time bar graph of Luminance APL. This will display the APL (Average Picture Level) of the luminance channel of the signal as a percentage. Maximum is towards the right hand end (white = 100%) and minimum (black = 0%) is towards the left-hand end.

This is the average level of the picture signal during active scanning time integrated over a frame period; defined as a percentage of the range between blanking and reference white level.

Audio Level Detectors

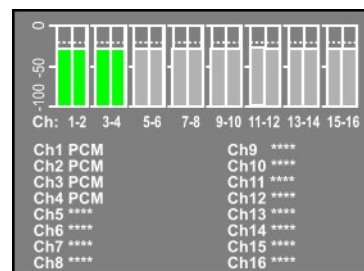

This display appears when **Audio Level Indicators** is checked.

This upper half is for monitoring of the sixteen audio channels via familiar bargraph displays.

The amplitude of each of the audio signals are shown with ascending (for increasing signal strength) green bargraph displays calibrated in dBFS. The overall range is from 0 dBFS (maximum level) to -100 dBFS.

The dotted line is a reference level set by the marker control on the **Audio Level Indicators screen** (see page 39)

The lower half shows what type of signal is on each of the channels.

This may show PCM, Non-PCM, Dolby E, AC3, MPEG Audio (SMPTE 338M) or **** if the signal is not recognized.

Timecode

When checked the timecode readout will appear. It uses the standard format of: Hours:Minutes:Seconds:Frames *Note that an asterisk following the Frames count is a field flag.*

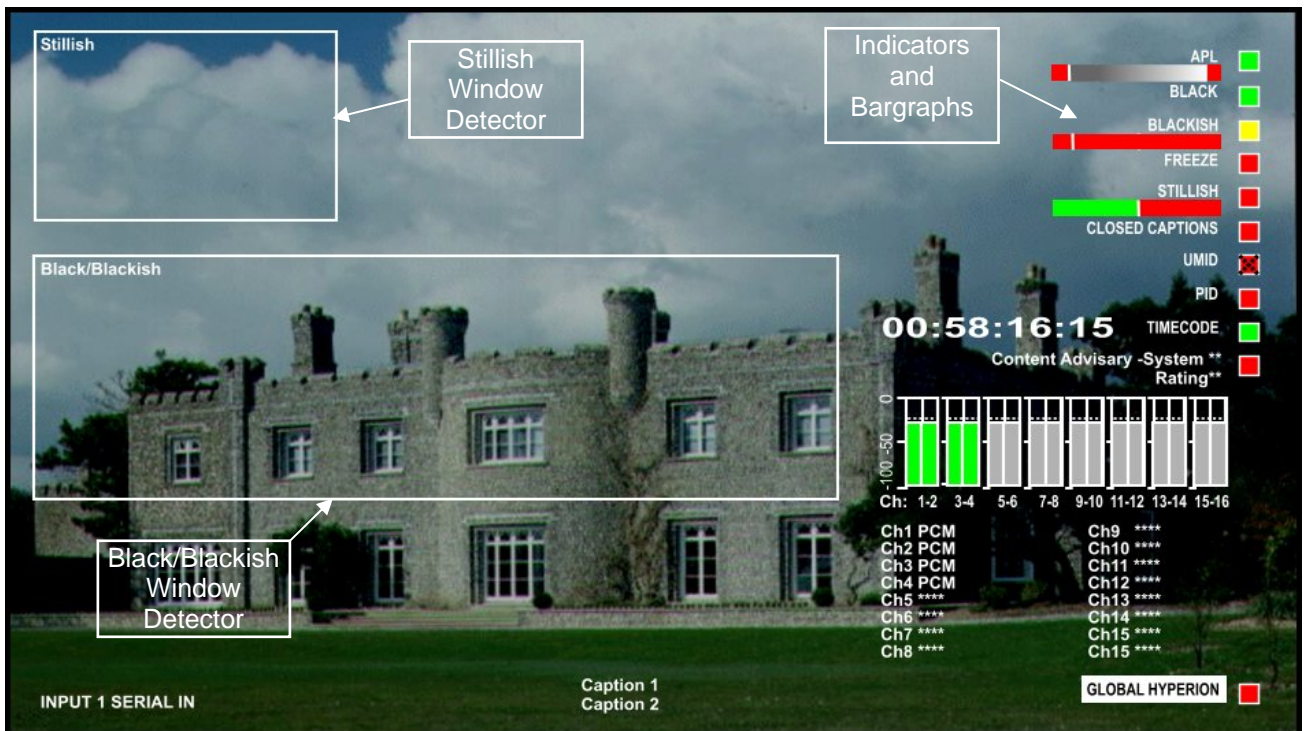

Hyperion information displayed on a HD picture. SD pictures display the same information but in different positions.

Grey Background

When checked the picture area behind the indicators will become monochrome as shown below. This can be used to make the indicators more legible with some picture material. *Note that for some standards the grey area may cover the entire screen.*

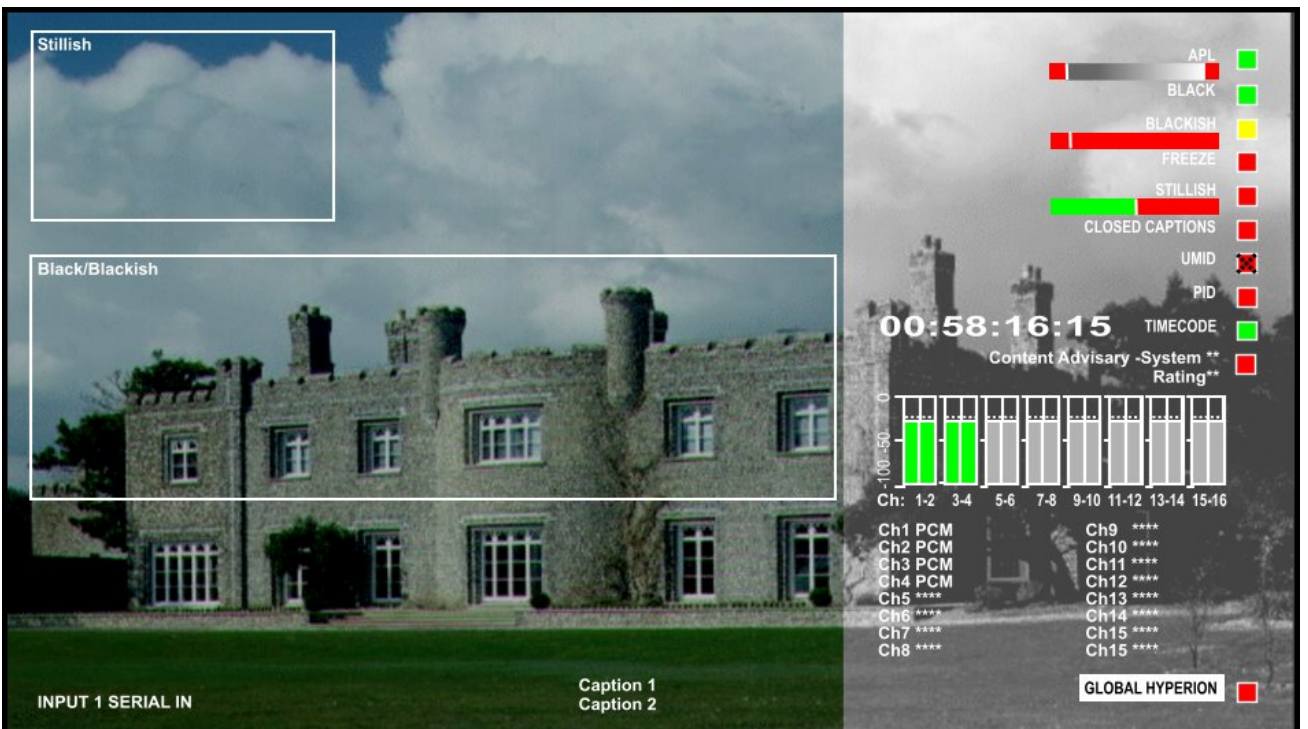

Input 1 name

When checked the name of the input signal will appear on screen. This is the name entered using the renaming function on the **Setup** screen (see page 48).

Caption 1 and 2

When checked this allows one or two captions to be displayed on the screen. The default text is Caption 1 and Caption 2. This text can be changed on the **On Screen Display** screen (see page 50).

Content Advisory

When checked any content advisory text that has detected in the input stream will be displayed on the screen.



Hyperion information displayed on a SD 625 picture



Hyperion information displayed on a SD 525 picture

RollCall PC Control Panel Screens

Black/Blackish

Overview

The Hyperion Black and Blackish modules provide a means of detecting dark or blackish areas within SDI SD or HD video. The Blackish function is different to the average picture luminosity in that the algorithm curve maps closer to the human eye, rather than a straight line as related to luminosity. Any small area that is brilliant white will trigger a large blackish response, whereas, the average picture luminosity for the same image would be very small. There are two blackish functions installed within Hyperion. The first, **Black**, is a blackish detector with a zero threshold. This detector is very selective and will be triggered if the whole window area is black. The second may have its threshold (see below) adjusted for custom blackish settings.

Many of the parameters require a condition to exist for a set duration before logging that there is an issue. These parameters feature 3 temporal controls; Warning, Fail and Fail Hold timers. Each timer is set by entering the number of fields/frames as a duration. (The duration is in fields for interlace standards and in frames for progressive standards.)

On-screen Display Functions

When the on-screen display functions are enabled (see page 50), they will be visible on the outgoing video as show below.

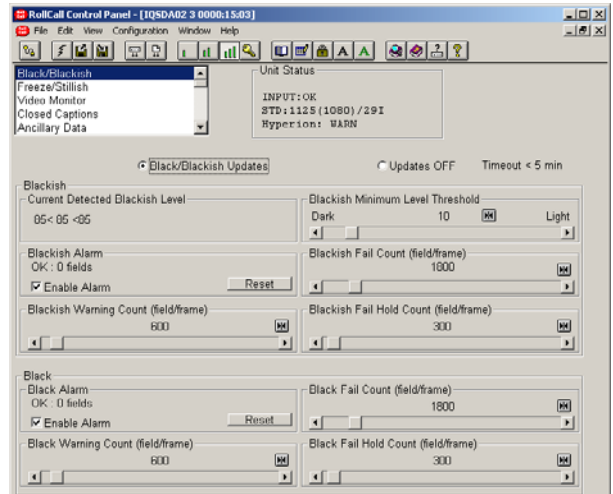

Detector Windows

A HYPERION parameter with a detector window can either detect the parameter inside the window, outside the window or over the entire screen. The controls that define the detector window are x and y start co-ordinates within the active area of the picture, and two length parameters, Width and Height. For details of how to set up the window please see page 50.

When a window is selected (see page 50), the windowed area defined by the controls below will be visible on the outgoing video. Also visible at the top of the window will be a real time bar graph display of the detected value and below that a real time bar graph of Luminance APL.

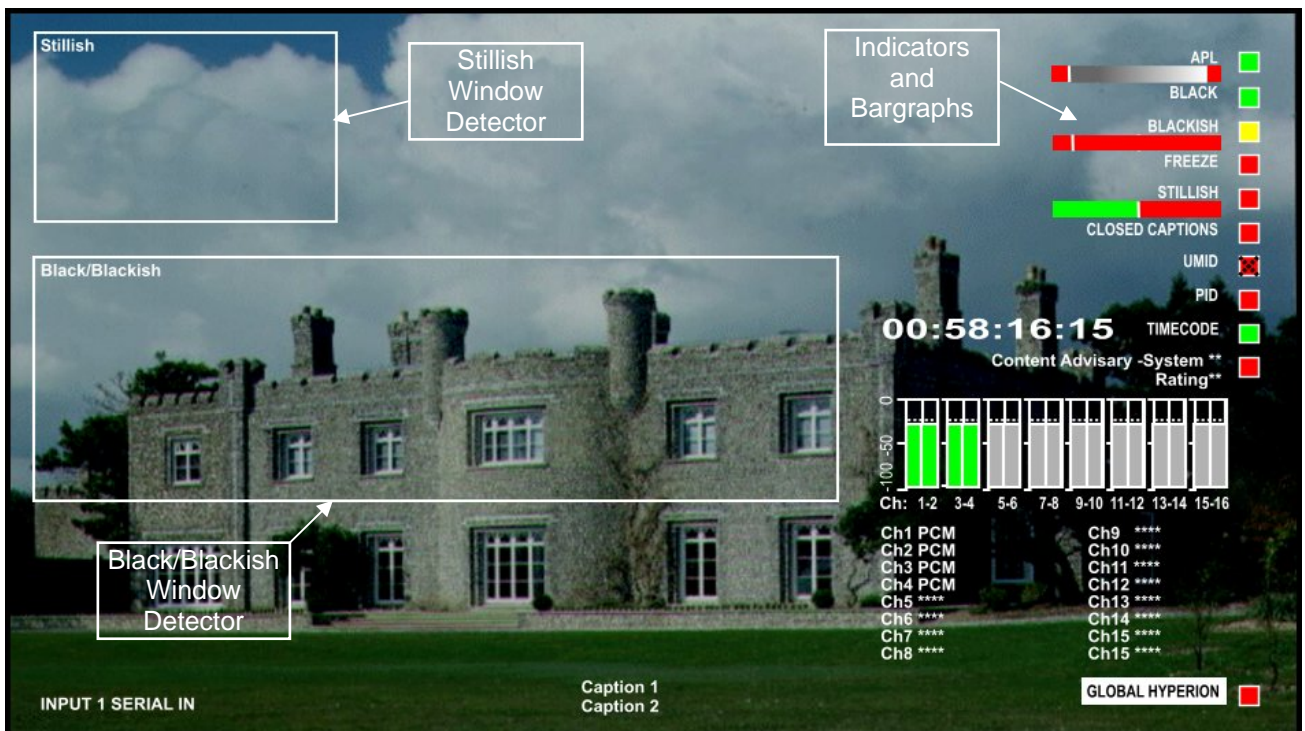

Hyperion information displayed on a HD picture. SD pictures have the same information but in different positions.

Black/Blackish (continued)

Black/Blackish Updates

When checked the detector reports will be enabled for *this function only* but for all other functions (that have an update button) the reports will be disabled. This action will be active for a maximum time of 5 minutes and the remaining time will be shown by the Timeout display; at the end of this time Updates OFF will be automatically selected.

*Note that this button cannot be unchecked; to disable the updates check the **Updates OFF** button.*

*Note also that when this button is checked the **Updates OFF** function will be implemented on **all** other screens; i.e. it is a global command.*

At power-up and when Factory Defaults or Restart Unit are selected **Updates OFF** will be automatically selected.

Current Detected Blackish Level





This will display three sets of figures. The first is the minimum level, the second is the current value and the third is the maximum level that has been detected over the monitoring period.

*Note that when the monitoring period has ended (either by **Updates OFF** being selected or the timeout period exceeded) the second figure (current value) will be replaced by - - and (held) will be displayed indicating that the figures have been frozen.*

This current blackish value is the dividing line between the blackish detector detecting blackish or not blackish. If the threshold setting is below this value, the detector will not detect blackish, if above, then the detector will detect blackish.

NOTE: Due to the slow update rate of this value, it should only be used as a very approximate indication of the level of blackish. A more accurate indication can be seen by using the Real Time on Screen Bar Graph (See On-Screen Window Section)

Note that for this and other screens the following applies to the scroll bars:

The   and   symbols at the ends of the scroll bar allow the value to be adjusted in discrete steps.

The numerical value will be shown next to the scroll bars and selecting Preset  will return the setting to the calibrated value for that item.

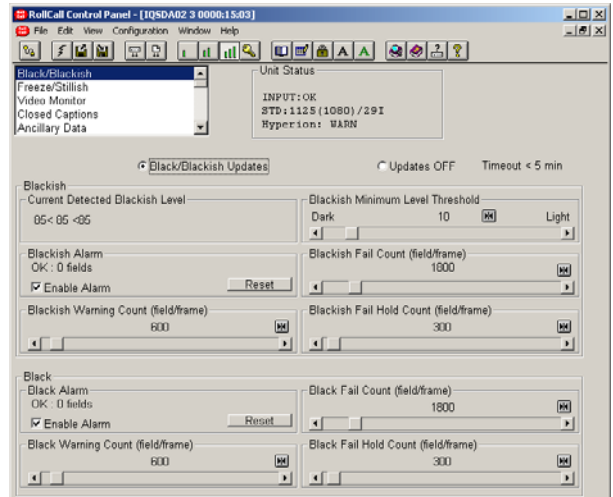

Blackish Level Threshold

This allows the degree of blackish level that triggers the detector, to be set. The range is from 0 to 100 units in 1-unit steps. Factory default is 10.

A visual indication of the set threshold against detected blackish can be seen by enabling the On Screen Window and real time bar graph. (See On Screen Window section).

Black/Blackish (continued)

Blackish Alarm

This item allows the alarm reporting to be enabled and shows the status of the Blackish alarm.

Enable Alarm

When checked the alarm status will be reported and logged.

For more information about alarms please see page 10.

Blackish Warning Count (field/frame)

This sets the duration (in fields/frames) that the condition (exceeding the blackish threshold) has to be detected and maintained before a warning condition is reported. The range of control is from 7 to 16000 in 1-unit steps. Factory default is 600. Note the warning count cannot be set to be greater than the fail count.

NOTE: If the On-Screen Display is enabled (see page 50), the Green indicator will extinguish and the yellow indicator will come on indicating a warning.

Blackish Fail Count (field/frame)

This sets the duration (in fields/frames) that the condition (exceeding the blackish threshold) has to be detected and maintained before the fail condition is reported. The range of control is from 7 to 16000 in 1-unit steps. Factory default is 1800.

NOTE: If the On-Screen Display is enabled (see page 50), the Green/yellow indicator will extinguish and the red indicator will come on indicating a fail condition.

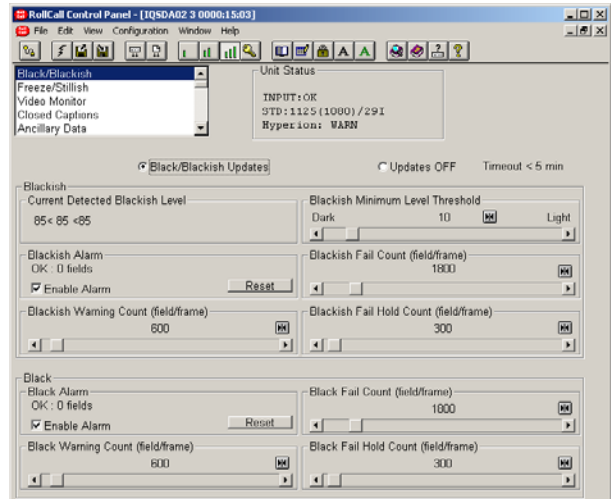

Blackish Fail Hold Count (field/frame)

This sets the duration (in fields/frames) that the condition (not exceeding the blackish threshold) has to be detected and maintained before the fail condition is cleared. The range of control is from 1 to 16000 in 1-unit steps. Factory default is 300.

NOTE: If the On-Screen Display is enabled (see page 50), the red indicator will extinguish and the green indicator will come on

Black/Blackish (continued)

Black Alarm

This item allows the alarm to be enabled and shows the status of the Black alarm.

Enable Alarm

When checked the alarm status will be reported and logged.

For more information about alarms please see page 10.

Black Warning Count (field/frame)

This sets the duration (in fields/frames) that the condition (exceeding the black threshold) has to be detected and maintained before a warning condition is reported. The range of control is from 7 to 16000 in 1-unit steps. Factory default is 600. Note the warning count cannot be set to be greater than the fail count.

NOTE: If the On-Screen Display is enabled (see page 50), the Green indicator will extinguish and the yellow indicator will come on indicating a warning.

Black Fail Count (field/frame)

This sets the duration (in fields/frames) that the condition (exceeding the black threshold) has to be detected and maintained before a **fail** condition is reported. The range of control is from 7 to 16000 in 1-unit steps. Factory default is 1800.

NOTE: If the On-Screen Display is enabled (see page 50), the Green/yellow indicator will extinguish and the red indicator will come on indicating a fail condition.

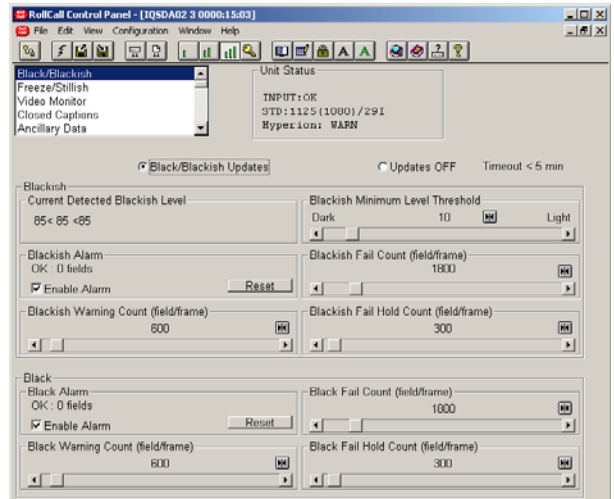

Black Fail Hold Count (field/frame)

This sets the duration (in fields/frames) that the condition (not exceeding the black threshold) has to be detected and maintained before the **fail** condition is cleared. The range of control is from 1 to 16000 in 1-unit steps. Factory default is 300.

NOTE: If the On-Screen Display is enabled (see page 50), the red indicator will extinguish and the green indicator will come on

Black/Blackish (continued)

When this function is enabled (see page 50), the On-screen indicator for the Black and Blackish detectors will be activated. The color of the indicator has the following meanings:

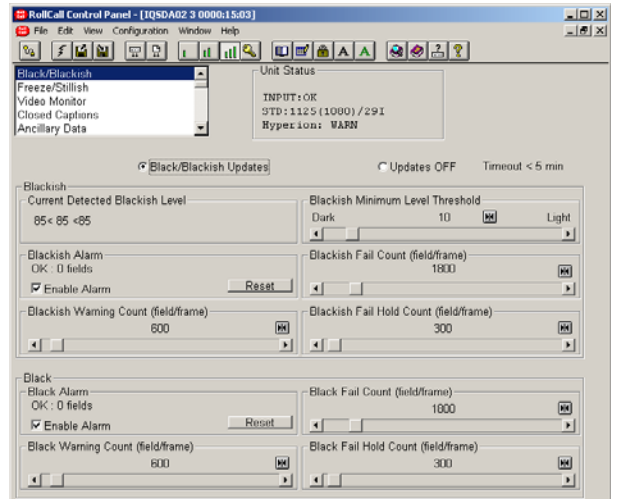
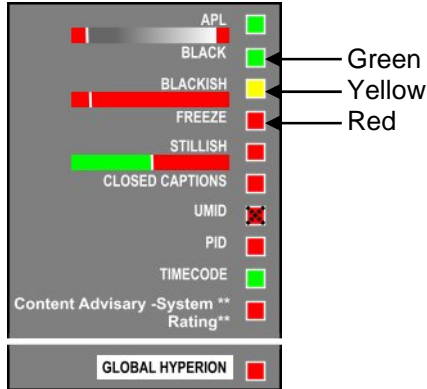

Green

The module has not detected black or blackish video set by the thresholds in the set window as set by the 'black or blackish Warning/Fail' temporal controls.

Yellow

The module has detected black or blackish video set by the thresholds in the set window as set by the 'black or blackish Warning' temporal controls.

Red

The module has detected black or blackish video set by the thresholds in the set window as set by the 'black or blackish Fail' temporal controls.

Note that when an indicator function is disabled the boxes will contain an X.

Stillish/Freeze

Overview

This function detects video that has no and/or very little movement. The degree of movement that triggers the detector is set by the Stillish threshold setting. This detector has a single detector window to allow the detector to be focused upon a particular part of the video image.

A HYPERION parameter with a detector window can either detect the parameter inside the window, outside of the window or over the entire screen.

The controls that define the detector window are x and y start co-ordinates within the active area of the picture, and two length parameters, Width and Height. For details of how to set up the window please see page 50.

When a window is selected (see page 50), the windowed area defined by the controls below will be visible on the outgoing video.

Also visible will be a real time bar graph display of the detected value.

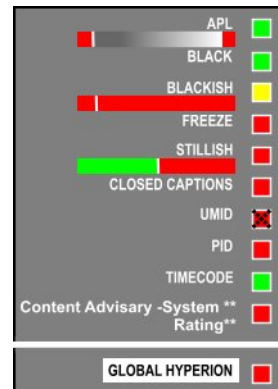
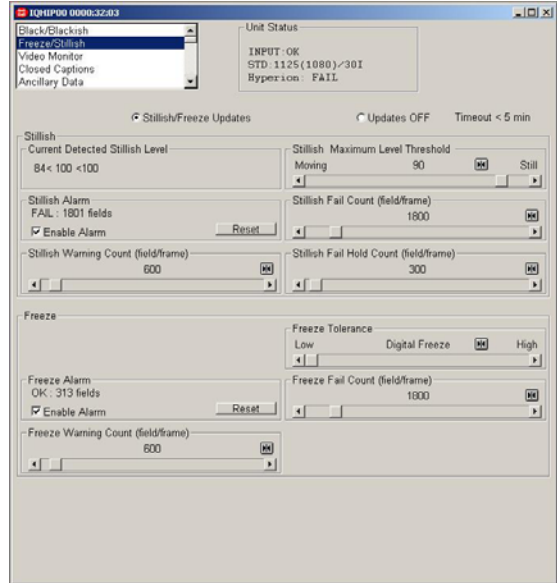

Stillish (continued)

The detector has 3 temporal controls, warning, fail and fail hold. These are used to determine how long a true condition has to be detected and maintained before either a warning or a fail condition is reported.

Stillish/Freeze Updates

When checked the detector reports will be enabled *for this function only* but for all other functions (that have an update button) the reports will be disabled. This action will be active for a maximum time of 5 minutes and the remaining time will be shown by the Timeout display; at the end of this time Updates OFF will be automatically selected.

*Note that this button cannot be unchecked; to disable the updates check the **Updates OFF** button.*

*Note also that when this button is checked the **Updates OFF** function will be implemented on **all** other screens; i.e. it is a global command.*

At power-up and when Factory Defaults or Restart Unit are selected **Updates OFF** will be automatically selected.

Current Detected Stillish Level

This will display three sets of figures. The first is the minimum level, the second is the current value and the third is the maximum level that has been detected over the monitoring period.

*Note that when the monitoring period has ended (either by **Updates OFF** being selected or the timeout period exceeded) the second figure (current value) will be replaced by - - and (**held**) will be displayed indicating that the figures have been frozen.*

The current value is the current stillish level where 1 (minimum) indicates a very large amount of motion and 100 (maximum) indicates a complete video freeze.

NOTE: Due to the slow update rate of this value, it should only be used as a very approximate indication of the level of motion. A more accurate indication can be seen by using the Real Time on Screen Bar Graph (See On-Screen Window Section)

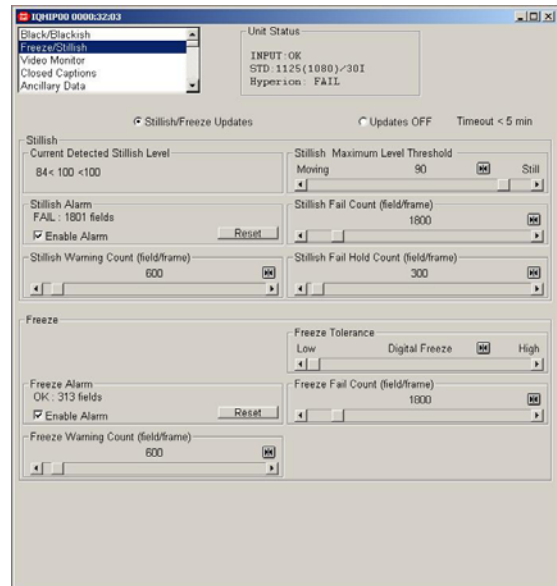

Stillish Level Threshold

This allows the degree of movement that triggers the detector to be set. The range is from 0 to 100 units in 1-unit steps. Factory default is 90.

A threshold setting of 100 would require still video to alarm.

A threshold setting of 1 would alarm unless the video is 100% moving (high movement rate).

A visual indication of the set threshold against detected motion can be seen by enabling the On Screen Window and real time bar graph. (See On Screen Window section).

Stillish (continued)

Stillish Alarm

This item allows the alarm to be enabled and shows the status of the Stillish alarm.

Enable Alarm

When checked the alarm status will be reported and logged.

For more information about alarms please see page 10.

Stillish Fail Count (field/frame)

This is the setting for how many Stillish flagged fields/frames (depending on whether the input video standard is of an interlaced or progressive type) the stillish detector module should go before flagging a Fail.

The range of control is from 12 to 16000 in 1-unit steps. Factory default is 1800.

NOTE: If the On Screen Indicators are enabled, the green/yellow indicators will extinguish and the red indicator will come on.

Stillish Warning Count (field/frame)

This is the setting for how many Stillish flagged fields/frames (depending on whether the input video standard is of an interlaced or progressive type) the stillish detector module should go before flagging a WARNING.

NOTE: If the On Screen Indicators are enabled, the Green indicator will extinguish and the yellow indicator will come on.

The range of control is from 12 to 16000 in 1-unit steps. Factory default is 600.

Note the warning count cannot be set to be greater than the fail count.

Stillish Fail Hold Count (field/frame)

This is the setting for how many NON stillish flagged fields/frames (depending on whether the input video standard is of an interlaced or progressive type) the stillish detector module should go before clearing the FAIL condition.

The range of control is from 1 to 16000 in 1-unit steps. Factory default is 300.

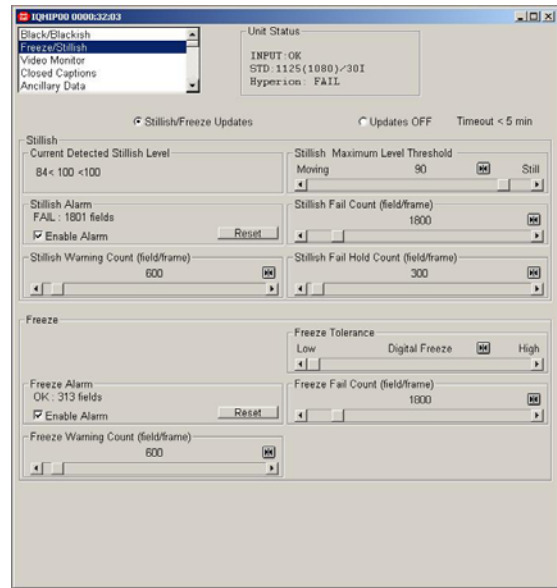

Stillish (continued)

Freeze

Freeze Alarm

This function detects true video freeze conditions, where successive fields or frames – dependant on video standard, either interlaced or progressive – are frozen.

This function uses the same window for monitoring as is used for the stillish detector.

Enable Alarm

When checked the alarm status will be reported and logged.

Freeze Warning Count (field/frame)

This is the setting for how many frozen flagged fields/frames (depending on whether the input video standard is of an interlaced or progressive type) the Freeze detector module should go before flagging a WARNING.

NOTE: If the On Screen Indicators are enabled, the Green indicator will extinguish and the yellow indicator will come on.

The range of control is from 12 to 16000 in 1-unit steps. Factory default is 600.

Note the warning count cannot be set to be greater than the fail count.

Freeze Tolerance

Under certain conditions, an image may appear to be static, when it is in fact not *digitally frozen*. For example, if a source has been compressed and then uncompressed, although it may appear to be static, due to compression artifacts, it is not digitally frozen. This control specifies the freeze sensitivity level, allowing the level of freeze detection to be specified.

When the slider bar is set to low, the words **Digital Freeze** are observed above it. Only an absolute pixel accurate digital freeze will trigger the detector.

When the slider bar is moved away from the extreme left the words **Digital Freeze** change to a number representing the sensitivity on a scale 1 to 10, 1 being the least tolerant, 10 being the most. I.e. On a setting of 10, a fair degree of movement is still deemed as frozen.

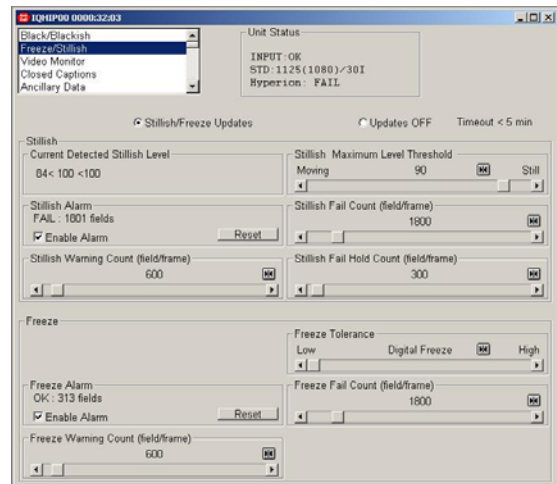

Freeze Fail Count (field/frame)

This is the setting for how many frozen flagged fields/frames (depending on whether the input video standard is of an interlaced or progressive type) the freeze detector module should go before flagging a Fail.

The range of control is from 12 to 16000 in 1-unit steps. Factory default is 1800.

NOTE: If the On Screen Indicators are enabled, the green/yellow indicators will extinguish and the red indicator will come on.

For more information about alarms please see page 10.

When this function is enabled (see page 50), the On-screen indicator for the Freeze detector will be activated. The color of the indicator has the following meanings:

Green

The module has not detected a freeze in the set window as set by the “freeze Warning/Fail” temporal controls.

Yellow

The module has detected a freeze in the set window as set by the “freeze Warning!” temporal controls.

Red

The module has detected a freeze in the set window as set by the “freeze Fail” temporal controls.

Note that when an indicator function is disabled the boxes will contain an X.

Stillish (continued)

When the On Screen Display is enabled (see page 50) the windowed area defined by the controls above will be visible on the outgoing video.

Also visible at the top of the window will be a real time bar graph display of the detected video motion.

The green portion of the bar represents the amount of motion, hence when the bar is all red a video freeze has been detected.

The white bar represents the user threshold. 1 is maximum motion – towards the right hand end, 100 is video freeze – toward the left hand end.

The two bars show two situations.

The first would indicate that the amount of motion is less than the threshold; hence stillish would flag a warning/fail depending on the temporal settings.

The second bar would indicate that the amount of motion is more than the threshold; hence stillish would not flag a warning/ alarm.

When this function is enabled (see page 50), the On-screen indicator for the Stillish detector will be activated. The color of the indicator has the following meanings:

Green

The module has not detected stillish video set by the thresholds in the set window as set by the 'Stillish Warning/Fail' temporal controls.

Yellow

The module has detected stillish video set by the thresholds in the set window as set by the 'Stillish Warning' temporal controls.

Red

The module has detected stillish video set by the thresholds in the set window as set by the 'Stillish Alarm' temporal controls.

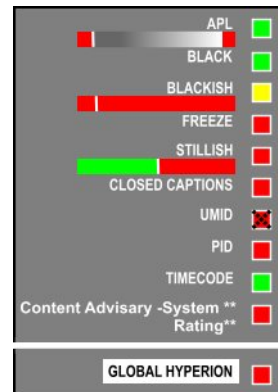
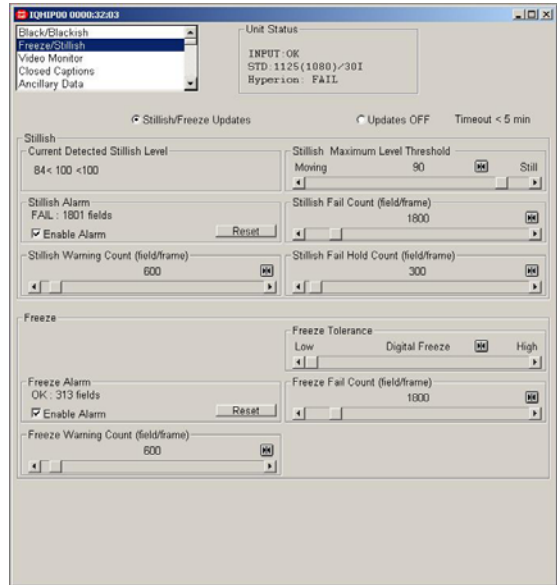

Video Monitor

Video Monitor Updates

When checked the detector reports will be enabled for *this function only* but for all other functions (that have an update button) the reports will be disabled. This action will be active for a maximum time of 5 minutes and the remaining time will be shown by the Timeout display; at the end of this time Updates OFF will be automatically selected.

*Note that this button cannot be unchecked; to disable the updates check the **Updates OFF** button.*

*Note also that when this button is checked the **Updates OFF** function will be implemented on **all** other screens; i.e. it is a global command.*

At power-up and when Factory Defaults or Restart Unit are selected **Updates OFF** will be automatically selected.

Average Picture Level

This will display the APL (Average Picture Level) of the luminance channel of the signal as a percentage (range 0 to 100).

It will display three sets of figures. The first is the minimum level, the second is the current value and the third is the maximum level that has been detected over the monitoring period.

*Note that when the monitoring period has ended (either by **Updates OFF** being selected or the timeout period exceeded) the second figure (current value) will be replaced by - - and (**held**) will be displayed indicating that the figures have been frozen.*

The level is the average level of the picture signal during active scanning time integrated over a frame period; defined as a percentage of the range between blanking and reference white level.

This parameter is displayed in real time by the on-screen display.

NOTE: Due to the slow update rate of this value, It is only to be used as a very approximate indication of the average picture luminosity. A more accurate indication is shown in the Real Time on Screen Bar Graph within the blackish window. The APL control operates over the whole of the active picture and is not affected by changes to the size of the Black/Blackish window.

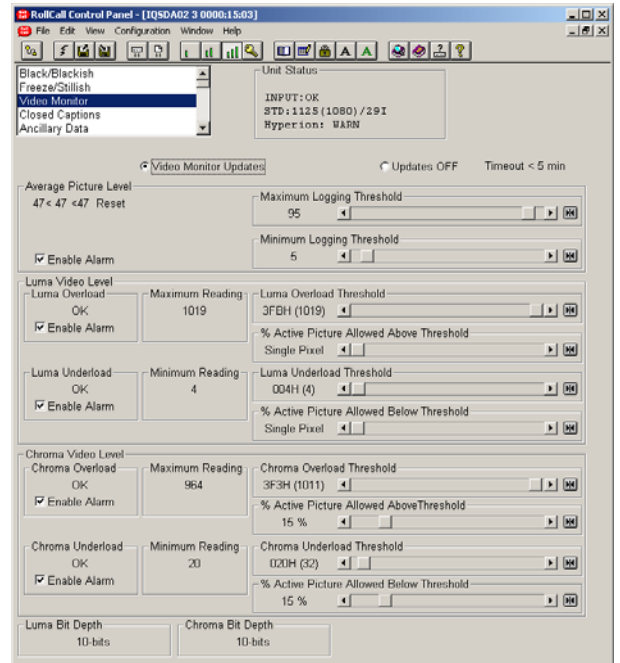

Maximum Logging Threshold

When the APL goes above the value (as a percentage) set by this control a logging signal will be generated.

The range of control is from 0 to 100 in 1-unit steps. Factory default is 95.

Minimum Logging Threshold

When the APL goes below the value (as a percentage) set by this control a logging signal will be generated.

The range of control is from 0 to 100 in 1-unit steps. Factory default is 5.

Enable Alarm

When checked the alarm status will be reported and logged.

For more information about alarms please see page 10

Video Monitor (continued)**Luma/Chroma Video level****Overload/Underload**

The Overload and Underload detectors can be used to search for data above or below a certain value in the chrominance and luminance channels of the active picture in a SDI stream.

The overload and underload threshold values can be set by adjusting the sliders, with the value displayed to the left in hex (decimal value in brackets).

The Luma Overload range of control is from 000H (0) to 3FFH (1023) in 1-unit steps. Factory default is 3ACH (940).

The Luma Underload range of control is from 000H (0) to 3FFH (1023) in 1-unit steps. Factory default is 040H (64).

The Chroma Overload range of control is from 000H (0) to 3FFH (1023) in 1-unit steps. Factory default is 3C0H (960).

The Chroma Underload range of control is from 000H (0) to 3FFH (1023) in 1-unit steps. Factory default is 040H (64).

If any data word in the active picture is above the overload threshold value, then the overload detector will display "FAIL". If not, it will display "OK". Similarly, if any value in the active picture is below the Underload threshold, then the underload detectors will display "FAIL".

% Active Picture Allowed Above Threshold
% Active Picture Allowed Below Threshold

The percentage of active picture pixels that need to exceed the threshold setting before the overload or underload detector is triggered may be set using this control.

The range of control is from a minimum of a single pixel and then from 1% to 99% in 1% steps. Preset is to 1 pixel.

Enable Alarm

When checked the alarm status will be reported and logged.

For more information about alarms please see page 10.

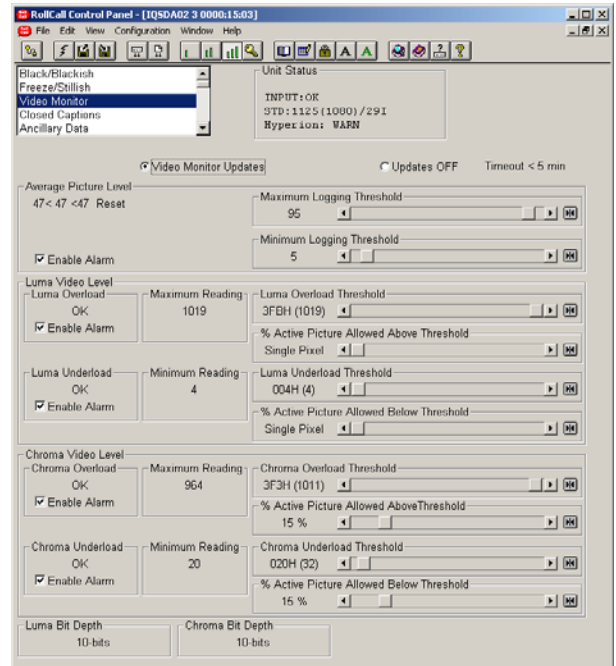
**Video Bit Depth**

The Video Bit Depth Detector can be used to determine the apparent bit depth of the chrominance and luminance channels of the active picture.

The detector operates by looking for activity on each bit of the video data in the active picture over a period of 1 frame.

If activity is found on all the bits then "10-bit" will be displayed.

If no activity is found on the bottom bit, then "9-bit" will be displayed.

If there is no activity on the bottom bit and on the next bit up, then "8-bit" will be displayed, and if there is also no activity on any of the top 8 bits, then "Unknown" will be displayed (for example, if the active video is a flat field).

The log fields for the video overload, underload and bit depth detectors can be found on page 60.

Closed Captions

Overview

Hyperion closed caption detection consists of detection for 525 and for HD signals. In 525, the captions present will be EIA-608-B standard and in HD the captions will be EIA-708-B.

EIA-608-B captions are detected by looking for the run-in code, as described in section 5.2 of CEA-608-B, when carried on Line 21/field 1 and Line 284/field 2 of 525 line signals. When captions are indicated as present, the parity of the data output has been checked and is valid.

EIA-708-B captions are detected by identifying the DID (Data Identifier) and SDID (Secondary Data Identifier) of the appropriate VBI data packet. They can be decoded from any position on any line.

Closed Caption Updates

When checked the detector reports will be enabled *for this function only* but for all other functions (that have an update button) the reports will be disabled. This action will be active for a maximum time of 5 minutes and the remaining time will be shown by the Timeout display; at the end of this time Updates OFF will be automatically selected.

*Note that this button cannot be unchecked; to disable the updates check the **Updates OFF** button.*

*Note also that when this button is checked the **Updates OFF** function will be implemented on **all** other screens; i.e. it is a global command.*

At power-up and when Factory Defaults or Restart Unit are selected **Updates OFF** will be automatically selected.

Closed Captions Indicators

These are turned on via the Closed Caption Indicators function on the On-Screen Display screen (see page 50).

The fail count will set how long captions will have to be not present, for the red light to come on. The CC Warning Count will count how long captions will have to be not present before the yellow light will come on. Finally the CC Fail Hold will count how long the captions have to be present before the Error will be reset and the display will switch from red to green.

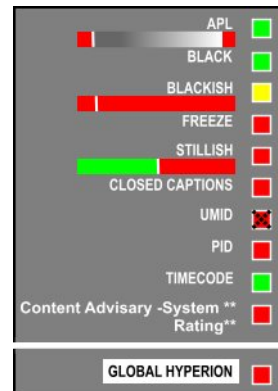
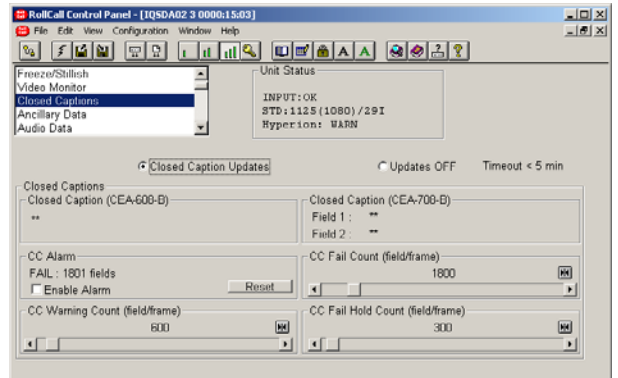

Closed Captions (continued)

Closed Caption (CEA-608-B)

Field 1

Will indicate CEA-608-B closed captions are present. ** indicates captions are not present.

Closed Caption (CEA-708-B)

Field 1, Field 2

Will indicate CEA-708-B closed captions are present on which field. ** indicates captions are not present.

CC Alarm

The alarm shows the state of the Closed Caption detector followed by the frame count. Reset will restart the alarm function.

It can report one of the four following states:

- OK..... Captions are detected
- Warn ... Captions have not been detected for more than the warning count
- Fail Captions have not been detected for more than the Alarm Count

CC Fail Count (Field/frame)

This is the number of Closed Caption free fields/frames that will have to pass before the CC Alarm will change to the Fail state. The range of control is from 10 to16000 in 1-unit steps. Factory default is 1800.

CC Warning Count (Field/frame)

This is the number of Closed Caption free frames that will have to pass before the CC Alarm will change to the Warning state. The range of control is from 10 to16000 in 1-unit steps. Factory default is 600. Note the warning count cannot be set to be greater than the fail count.

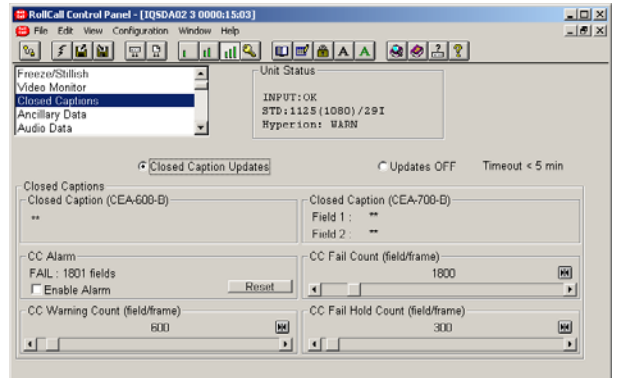

CC Fail Hold Count (Field/frame)

This is the number of frames with Closed Captions present that will have to pass before the CC Alarm will reset from Fail to OK. The range of control is from 1 to16000 in 1-unit steps. Factory default is 300.

Enable Alarm

When checked the alarm status will be reported and logged.

For more information about alarms please see page 10.

Ancillary Data

Content Advisory

Content advisory information is data describing the age rating of programs transmitted. This can be carried in the EIA-608-B standard.

EIA-608-B data can then be carried in EIA-708-B packets, as discussed in section 4.3 of CEA-708-B. This also means that Content Advisory data can be carried in HD EIA-708-B Closed Captions. Hyperion can decode this information and display it on this screen.

When there is content advisory information, as outlined in section 9.5.1.5 of CEA-608-B, then this information is decoded and displayed on this screen.

This will first state the ratings system that is being used (e.g. MPA, US TV Parental Guidelines etc) and then display the rating of the program being transmitted (e.g. TV-PG, TV-14 etc).

Enable Alarm

When checked the alarm status will be reported and logged.

For more information about alarms please see page 10.

Time Code and User Anc Packet Updates

When either of these are checked the detector reports will be enabled *for that function only* but for all other functions (that have an update button) the reports will be disabled. This action will be active for a maximum time of 5 minutes and the remaining time will be shown by the Timeout display; at the end of this time Updates OFF will be automatically selected.

*Note that this button cannot be unchecked; to disable the updates check the **Updates OFF** button.*

*Note also that when this button is checked the **Updates OFF** function will be implemented on **all** other screens; i.e. it is a global command.*

At power-up and when Factory Defaults or Restart Unit are selected **Updates OFF** will be automatically selected.

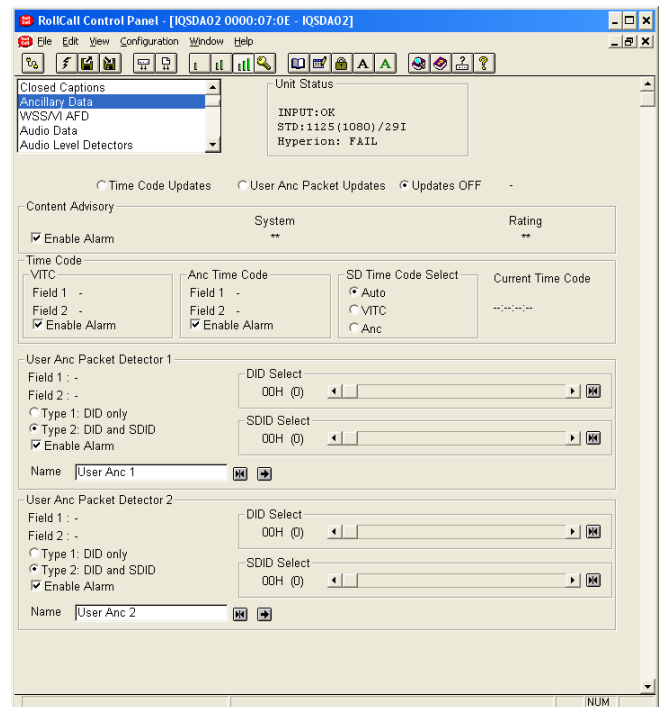

Ancillary Data (continued)

Timecode

This unit has two Time Code detectors, one for Vertical Interval Time Code (VITC) in SD, and one for Ancillary Time code in SD or HD.

VITC

The unit searches for VITC in all vertical interval blanking lines. It reports back whether or not valid VITC has been found, and if so, which line it has been found on in Field 1 and Field 2. If no VITC is found in a particular field, the output will display “** ”.

Enable Alarm

When checked the alarm status will be reported and logged.

For more information about alarms please see page 10.

ANC Time Code

ANC Timecode can be decoded from any position on any line. The Ancillary TimeCode detector operates in a similar manner as VITC, looking for Ancillary Packets with a DID of 60h and an SDID also of 60h.

This reports back whether or not it has been found, and if so, which line it has been found on in Field 1 and Field 2. If none is found in a particular field, the output will display “** ”.

Enable Alarm

When checked the alarm status will be reported and logged.

For more information about alarms please see page 10.

SD Time Code Select

This allows the SD time code type to be specified.

Auto: The unit will automatically determine the time code type.

VITC: VITC time codes will be used.

Anc: ANC time codes will be used.

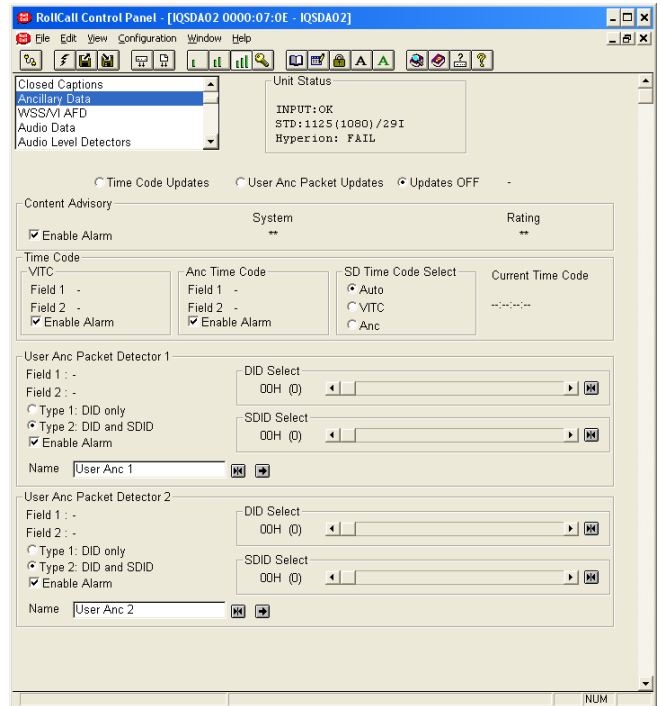

Current Time Code

If Time Code is present this will be displayed on the template and the On Screen Display.

If none is found it will display: ** ** ** **

Indicators

These are turned on via the Timecode function on the On-Screen Display screen (see page 50).

If VITC or Ancillary TimeCode are present, then the indicator will be green, if neither are present then the indicator will be red.

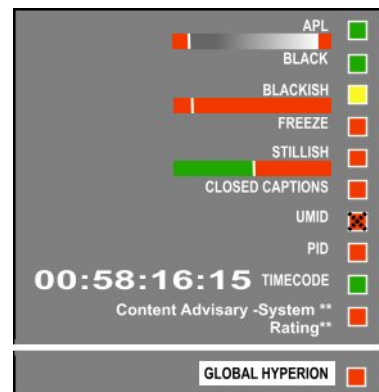

Ancillary Data (continued)

User Anc Packet Detector 1 and 2

Hyperion also has two user-definable Ancillary Packet Detectors.

These can be used to search for Ancillary packets anywhere in the video stream. Each detector can be set to look for either Type 1 packets (DID only, as in detector 2 above) or Type 2 packets (DID and SDID, as in detector 1 above). If found, the last line number in each field to contain the packet will be displayed in the template.



If the packet is not found in a particular field, then “ ** ” will be displayed.

The range of control is from 00H (0) to FFH (255) in 1-unit steps. Factory default is 00H (0).

Enable Alarm

When checked the alarm status will be reported and logged.

The detector name may be changed from the defaults of User Anc 1,2.

To change the name, type the new name in the text area (the return symbol changes to red ) and then select  (return) to save the new name.

The symbol  will then become black again.

Selecting Preset  will return the text to the default name.

For more information about alarms please see page 10.

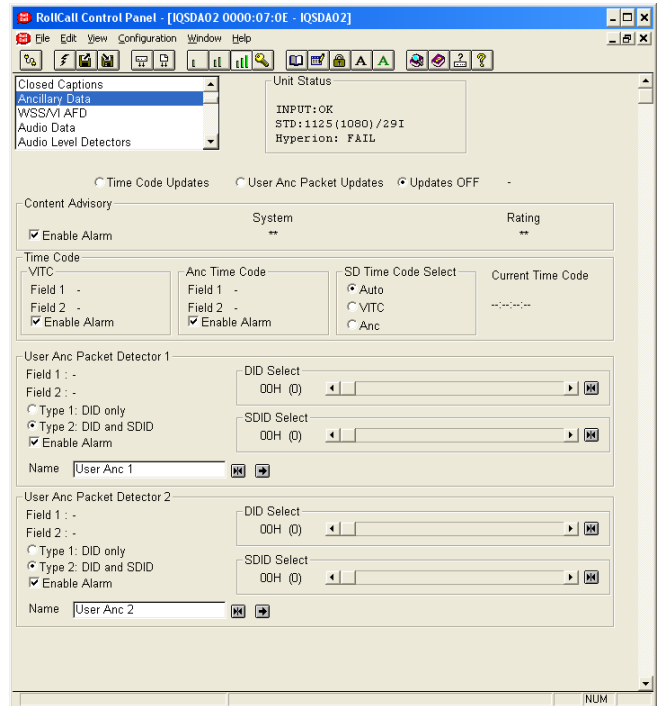

WSS / VI AFD**WSS**

This detector will look for the presence of WSS, whether in ETSI form or AFD, on lines 7 to 23 of 625 PAL video. If WSS is present the line number on which WSS was found will be displayed. If WSS is not found ** will be displayed.

Note that it is important the correct WSS/VI type is selected. If it is not, it is possible that incorrect information will be decoded.

Enable Alarm

When checked, the alarm status will be reported and logged. For more information about alarms, see page 10.

WSS Type

This enables the WSS type to be specified. Select one of the following types:

ETSI: ETSI standard is used

AFD: Active Format Descriptor (AFD) standard is used.

AFD and ScanSys: AFD and the scan system is used.

Notes

WSS is originally an ETSI standard, defined in ETSI 300 294. Video Index is defined by SMPTE in RP186. Both standards have their original data format as defined by ETSI and SMPTE respectively, but also they both have another format called Active Format Descriptor (AFD) which uses the same shell for transmission, but the data means different things.

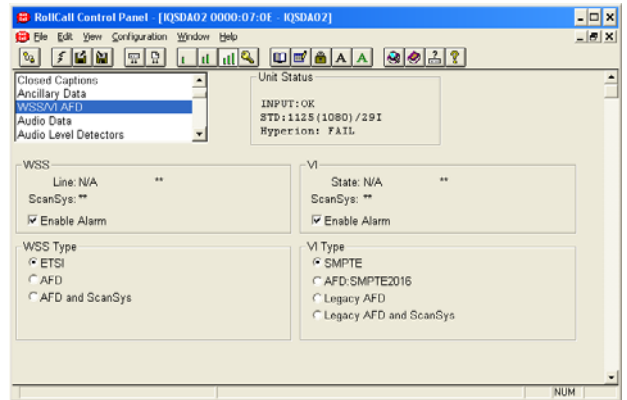
**VI**

This detector will look for the presence of Video Index information, whether in SMPTE format or AFD format, on lines 11 and 324 of 625 PAL video and on lines 14 and 277 of 525 video.

If VI is found, OK will be displayed; if VI is not present ** will be displayed.

Enable Alarm

When checked, the alarm status will be reported and logged. For more information about alarms, see page 10.

VI Type

This enables the VI type to be specified. Select one of the following types:

SMPTE

AFD:SMPTE2016

Legacy AFD

Legacy AFD and ScanSys

Audio Data

The module searches for audio packets transported in the video blanking, and can report back which audio groups and audio channels are present in the video stream. It can also report back what kind of audio is present in each channel, along with an effective audio bit depth for that channel.

Group 1 to 4

Displayed are the 4 groups and 16 possible channels of embedded audio that have been found in the SDI stream.

The logging data for all 16 channels is on the Log Aud State Rollcall screen.

Enable Alarm

When checked the alarm status for that channel will be reported and logged.

For more information about alarms please see page 10.

Data Type

This displays what kind of audio data has been embedded in each of the 16 audio channels.

Bit Depth

This displays the apparent bit depth of the Audio data in each channel. It operates by looking for activity on the 24 bits of audio data over a period of 1 video frame. If all the bits are found to be active then "24-bit" will be displayed. If the bottom 4 bits do not change at all then "20-bit" will be displayed. If the next 2 bits also remain constant then "18-bit" will be displayed, and if none of the bottom 8 bits change then "16-bit" will be displayed. If no activity is found in any of the 24-bits then "****" will be displayed (for example, if the channel is not used, or if it is muted).

This data is logged on the Log Aud Bit Depth Rollcall screen.

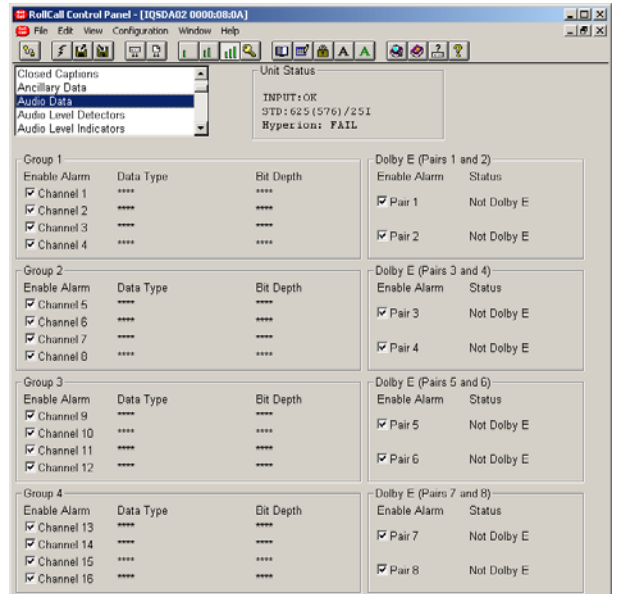

Audio Data (continued)

Dolby E (Pairs 1 and 2) to Dolby E (Pairs 7 and 8)

This function reports whether or not SMPTE337M Dolby E audio packets are embedded in a safe position with regards to the video switching point. The information is calculated for each of the 8 possible Dolby E channel pairs.

As the diagram below shows, a Dolby E packet will be declared as "OK" if it starts after the video switching line and finishes before the end of the video frame.

If a packet starts before the video switching line, then the module will report "Early" and if it finishes after the end of the video frame then the module will report "Late".

If the Dolby E is not locked to the video then "Out of Sync" will be reported, and if there is no Dolby E on a particular channel pair, then the module will report "Not Dolby E"

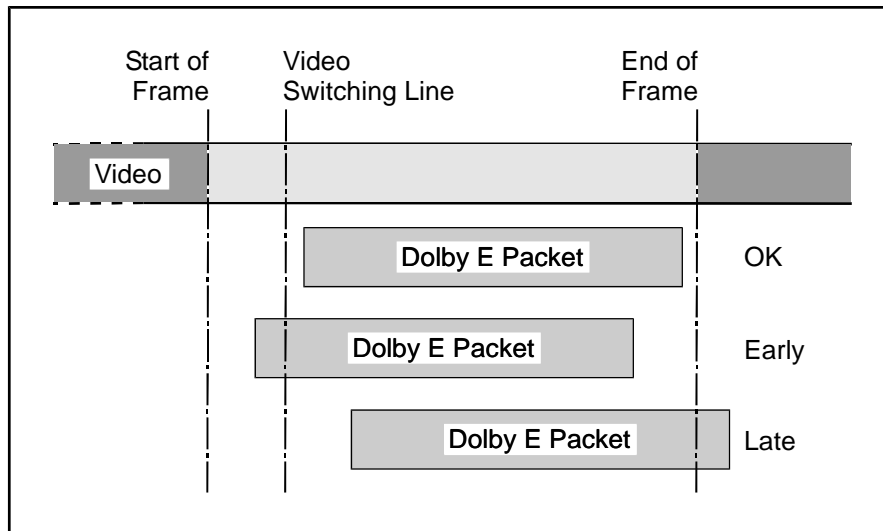

Dolby E Audio Packet Position Reporting

Audio Level Detectors

Associated with each of the supported channels (1 to 16) are four level/time detectors.

Every second the reported level is compared against the thresholds of the parameter selected for that channel. If the value satisfies the detector requirements (above/below set thresholds) the timers are incremented. If the timers reach the user defined limits logging messages of selected severity are issued. If the value does not pass the threshold requirements the timers are reset.

This screen allows the detector parameters to be set up for the 16 audio channels.

Audio Level Updates

When checked the detector reports will be enabled for *this function only* but for all other functions (that have an update button) the reports will be disabled. This action will be active for a maximum time of 5 minutes and the remaining time will be shown by the Timeout display; at the end of this time Updates OFF will be automatically selected; at the end of this time **Updates OFF** will be automatically selected.

*Note that this button cannot be unchecked; to disable the updates check the **Updates OFF** button.*

*Note also that when this button is checked the **Updates OFF** function will be implemented on **all** other screens; i.e. it is a global command.*

At power-up and when Factory Defaults or Restart Unit are selected **Updates OFF** will be automatically selected.

Select Channel

This scroll bar allows any of the 16 channels to be selected. The parameters for the selected channel may then be adjusted. Preset is Channel 1 selected.

Average Audio Level (dB)

This shows the average signal level of the selected audio channel, updated once per second.

The scaling is such that a Sinewave test tone of -20 dBFS peak will produce a reading close to -20 dB. The reading for a Squarewave signal of -20 dBFS peak will be around -17 dB because its average level is higher.

The reading represents the peak of several short term block averages over the previous second, with 3 dB added so that 0 dBFS peak sinewave test tones produce a 'familiar' reading of about 0dB.

*Note that ** will be shown if no audio is detected on the channel or if there is no video input.*

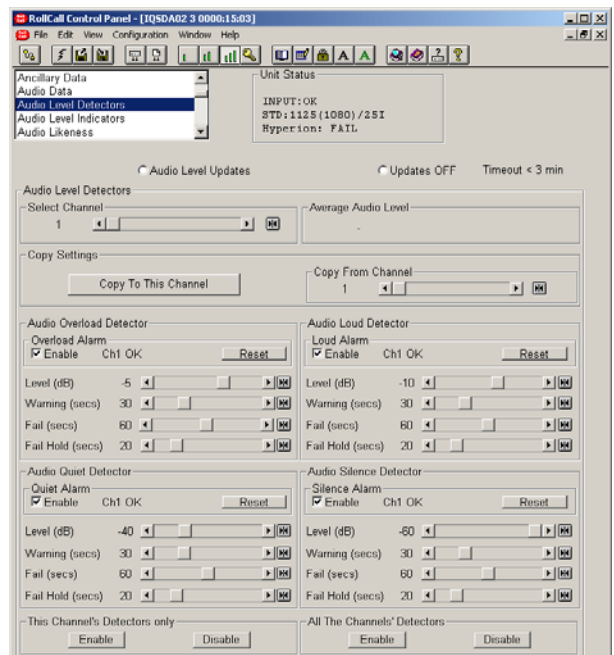
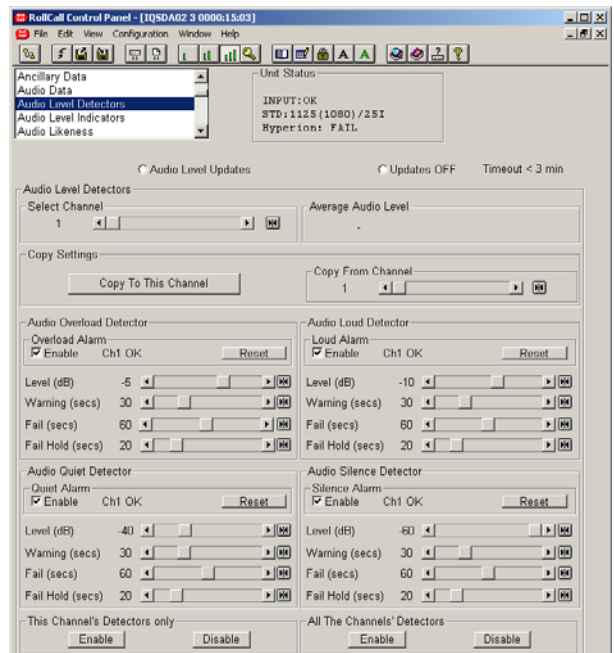

Copy Settings/Copy from Channel

This allows the settings from any of the 16 channels to be applied to the currently displayed channel.

Use the **Copy From Channel** scroll bar to select the channel containing the desired settings and then select **Copy To This Channel**; the settings will then be applied to the channel currently displayed.

Audio Level Detectors (continued)

Performance of the Detectors

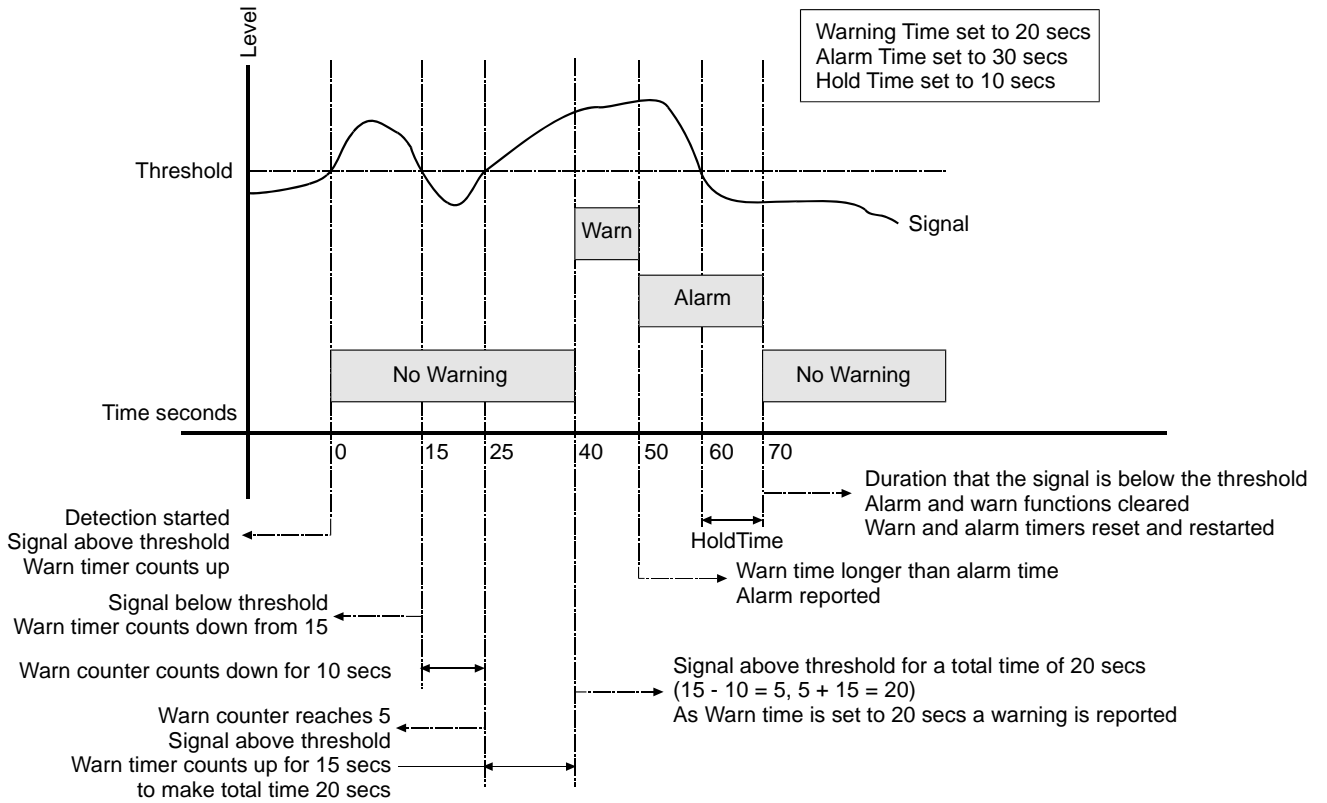

Audio Level Detectors (continued)

Audio Overload Detector

This allows the adjustment of parameters that are considered to represent an overload condition.

Overload Alarm

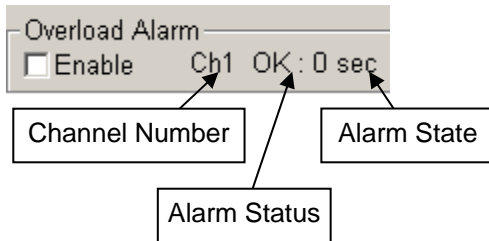

In this example this area shows the number of the selected audio channel (Ch1), the status of the alarm (OK) and the reported state (0 sec).

Enable

When checked the alarm status will be reported and logged.

For more information about alarms please see page 10.

The alarm status can show:

OK A valid audio signal has been detected on the current channel.

****** No audio detected on the current channel.

WARN The overload warning detector has been activated

FAIL The overload failure detector has been activated

The alarm state will show a time countdown related to the setting of the **Fail Hold** control.

Level (dB)

This sets the level that if exceeded would represent an overload condition. The range of control is from 0 to -15 dB in 1 dB steps and preset is to -5 dB.

Warning (secs)

This sets the time the signal must exceed the Level threshold before the **Warn** state is reported. The range of control is from 1 to 120 seconds and preset is to 30 seconds. Note the warning count cannot be set to be greater than the fail count.

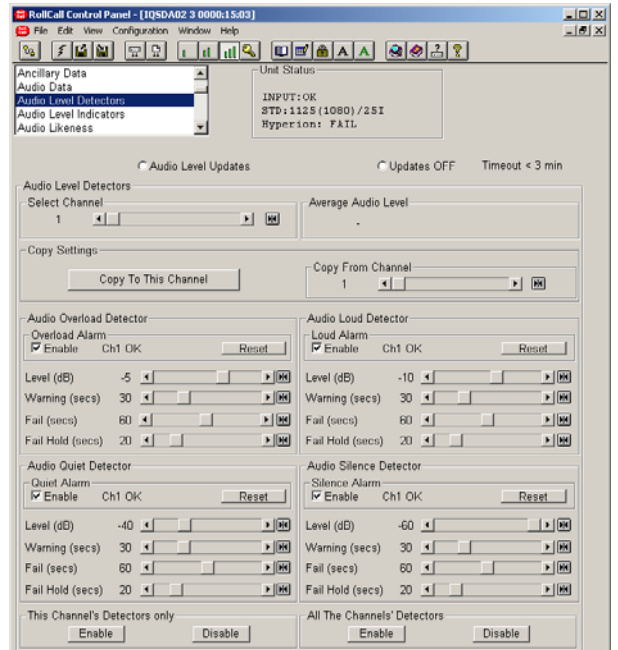

Fail (secs)

This sets the time the **Warn** state must exist before the **Fail** state is reported. The range of control is from 1 to 120 seconds and preset is to 60 seconds.

Fail Hold (secs)

This is the time the signal must not exceed the Level threshold before the **Warn** and **Fail** states are cleared. The range of control is from 1 to 120 seconds and preset is to 20 seconds.

Audio Level Detectors (continued)

Audio Loud Detector

This allows the adjustment of parameters that are considered to represent a loud condition.

Enable

When checked the fail status will be reported and logged.

For more information about alarms please see page 10

The status of the fail will also shown in this area.

Level (dB)

This sets the level that if exceeded would represent a loud condition. The range of control is from 0 to -25 dB in 1 dB steps and preset is to -10 dB.

Warning (secs)

This sets the time the signal must exceed the Level threshold before the **Warn** state is reported. The range of control is from 1 to 120 seconds and preset is to 30 seconds. Note the warning count cannot be set to be greater than the fail count.

Fail (secs)

This sets the time the **Warn** state must exist before the **Fail** state is reported. The range of control is from 1 to 120 seconds and preset is to 60 seconds.

Fail Hold (secs)

This is the time the signal must not exceed the Level threshold before the **Warn** and **Fail** states are cleared. The range of control is from 1 to 120 seconds and preset is to 20 seconds.

Audio Quiet Detector

This allows the adjustment of parameters that are considered to represent a quiet condition.

Enable

When checked the alarm status will be reported and logged.

For more information about alarms please see page 10 .

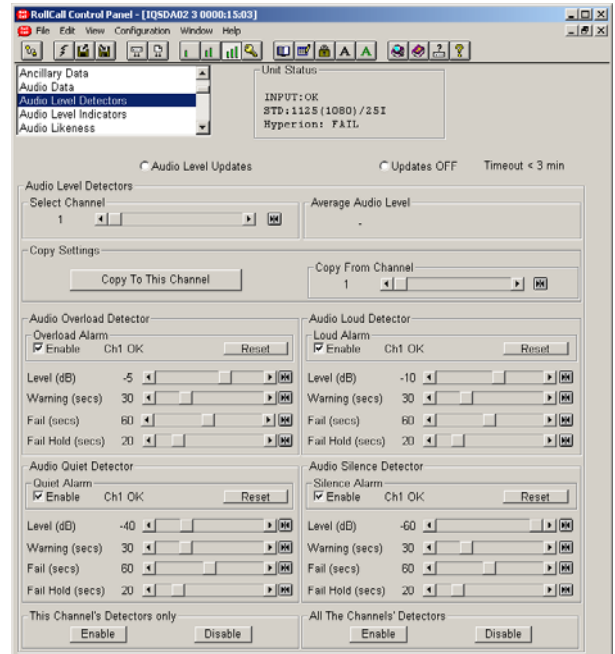

Level (dB)

This sets the level that if the signal were below would represent a quiet condition. The range of control is from -10 to -50 dB in 1 dB steps and preset is to -40 dB.

Warning (secs)

This sets the time the signal must be below the Level threshold before the **Warn** state is reported. The range of control is from 1 to 120 seconds and preset is to 30 seconds. Note the warning count cannot be set to be greater than the fail count.

Fail (secs)

This sets the time the **Warn** state must exist before the **Fail** state is reported. The range of control is from 1 to 120 seconds and preset is to 60 seconds.

Fail Hold (secs)

This is the time the signal must not exceed the Level threshold before the **Warn** and **Fail** states are cleared. The range of control is from 1 to 120 seconds and preset is to 20 seconds.

Audio Level Detectors (continued)

Audio Silence Detector

This allows the adjustment of parameters that are considered to represent a silent condition.

Enable

When checked the alarm status will be reported and logged.

For more information about alarms please see page 10.

The status of the alarm will also be shown in this area.

Level (dB)

This sets the level that if the signal were below would represent a silent condition. The range of control is from -60 to -99 dB in 1 dB steps and preset is to -60 dB.

Warning (secs)

This sets the time the signal must be below the Level threshold before the **Warn** state is reported. The range of control is from 1 to 120 seconds and preset is to 30 seconds. Note the warning count cannot be set to be greater than the fail count.

Fail (secs)

This sets the time the **Warn** state must exist before the **Fail** state is reported. The range of control is from 1 to 120 seconds and preset is to 60 seconds.

Fail Hold (secs)

This is the time the signal must not exceed the Level threshold before the **Warn** and **Fail** states are cleared. The range of control is from 1 to 120 seconds and preset is to 20 seconds.

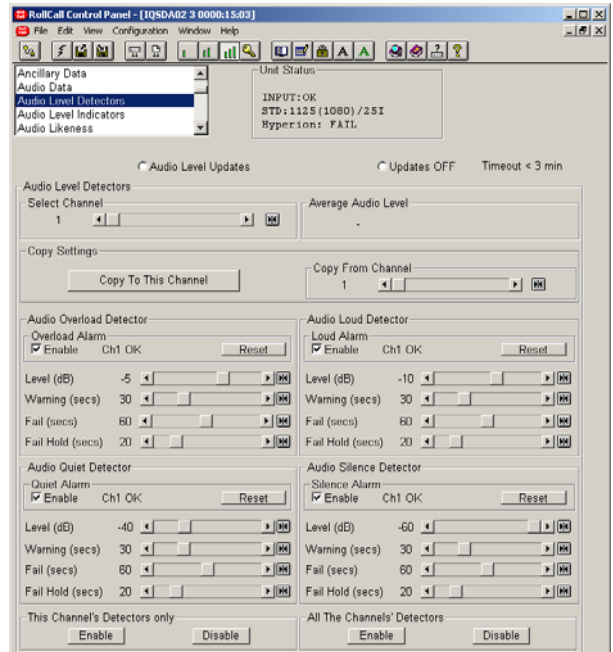

This Channel's Detectors only

When enabled the alarms for only the currently selected channel (as displayed by the **Select Channel** function) will be enabled.

When disabled the alarms for only the currently selected channel (as displayed by the **Select Channel** function) will be disabled.

All The Channel's Detectors

When enabled the alarms for all channels will be enabled.

When disabled the alarms for all channels will be disabled.

Note that when an alarm is disabled the detector still operates in the background but only reports INFO for logging.

Audio Level Indicators

This screen shows the amplitude of the sixteen audio channels and duplicates the On Screen Display Audio Level Indicators. It also allows individual channel indicators to be displayed or to be turned off.

Enable RollMap Audio Level Indicators

When RollMap Audio Level Indicators are connected, this option is automatically selected and cannot be disabled. When RollMap Audio Level Indicators are disconnected, the control is automatically disabled.

When RollMap Audio Level Indicators are not connected, you can deselect this option to stop sending audio data back to RollMap, reducing the amount of data that needs to be generated.

Marker

This control allows a reference audio level to be set and will be seen as a dotted line at the top of the on screen bargraph display as shown below.

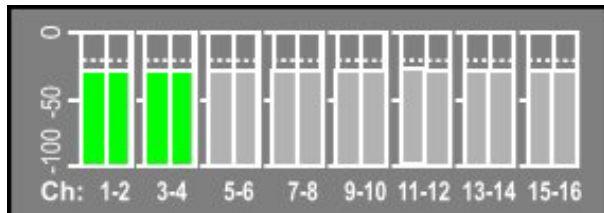

Using the slider this level can be adjusted from -102 dB to 0 dB in steps of 1 dB. Preset value is -20 dB.

The amplitude of the audio channel is shown by the position of the indicator on the sliding bar or by the on screen bargraphs. The amplitude of the signal is sampled approximately 3-5 times a second and the level displayed by the on screen bargraphs and the sliding bar indicator. The bar covers a range of 0 dB to -100 dB and the numerical value (greyed out) is shown at the top of the bar.

Enable

These boxes allow the individual channel indicators to be displayed (checkbox ticked) or turned off (checkbox cleared). In this example channels 5 and 6 have been disabled and do not appear on this screen.

Note that this action will not affect the on screen display and all channel level indicators will be displayed.

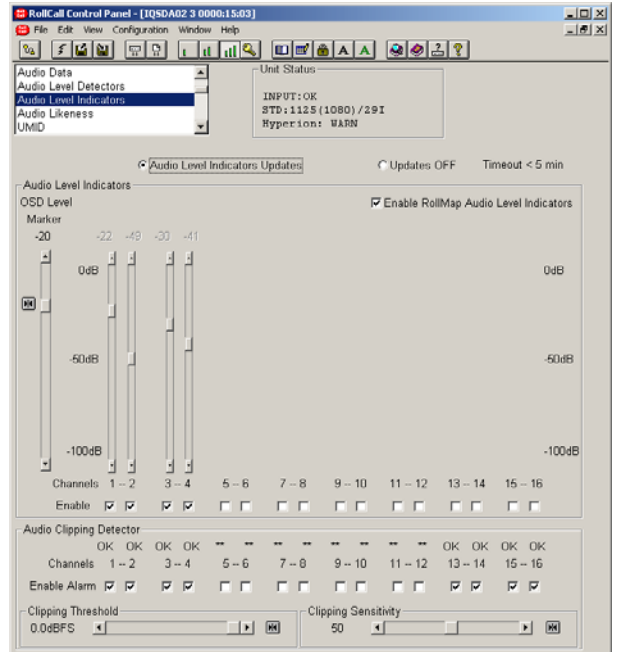

Non-PCM Signals

If a channel is a non-PCM signal the sliding bar indicator will not appear on this screen (in this example channels 13 and 14) even if it is enabled. Also the on-screen bargraphs for channels with non-PCM signals will not be displayed.

Audio Clipping Detector

Each audio channel can be monitored for a clipping condition and the status reported.

Enable Alarm

When checked the clipping condition for that channel will be reported and logged. The status will be shown above channel number.

Clipping Threshold

The level considered to be clipping that will trigger the alarm can be set with this control. The range of control is from 0 dBFS to -2 dBFS in steps of 0.5 dB and preset is to -1.5 dBFS.

Clipping Sensitivity

This allows the detection of a clipping condition to be modified for different types of audio signals. A high setting will allow the detector to report a clipping condition for signals that only occasionally exceed the threshold level.

A low setting allows the detector to report a clipping condition for signals that regularly exceed the threshold level.

The sensitivity value can be set from 1 to 100 in steps of 1. Preset is to 50.

Audio Likeness

This function monitors the relationship between two selected channels, and determines whether the channels are the same (dual monophonic), stereo or largely unrelated. It also determines whether the polarities of the two channels match.

The detector reports a likeness number from -100 to +100. The larger the absolute value, the more alike the two channels are. If the two selected channels are virtually identical (2 x mono) the reported number will be 100 if their polarities match and -100 if one of them has been inverted.

Audio Likeness Updates

When checked the detector reports will be enabled for this function only but for all other functions (that have an update button) the reports will be disabled. This action will be active for a maximum time of 5 minutes and the remaining time will be shown by the Timeout display; at the end of this time Updates OFF will be automatically selected; at the end of this time **Updates OFF** will be automatically selected.

*Note that this button cannot be unchecked; to disable the updates check the **Updates OFF** button.*

*Note also that when this button is checked the **Updates OFF** function will be implemented on all other screens; i.e. it is a global command.*

At power-up and when Factory Defaults or Restart Unit are selected **Updates OFF** will be automatically selected.

Audio Likeness Detector (1 to 4)

These are the four likeness detectors

Likeness

This will display the likeness number for the two channels that are being compared.

Status

This will display the name of the two channels being compared and the probable relationship between the channels.

It may show:

Mono.....Identical channels, same polarity.

StereoSimilar channels, i.e. Stereo.

Wide.....Channels have little/no short term similarity.

Inverted Mono.....Identical channels, one channel reversed polarity.

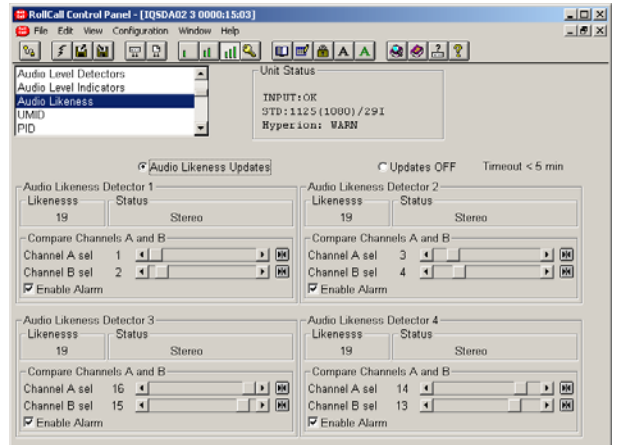

Inverted Stereo Similar channels, i.e. Stereo one channel reversed polarity.

Inverted Wide..... Similar channels, i.e. Wide Stereo one channel reversed polarity.

Ch~(+~) Low/Lost... A channel lost or at low level

Compare Channels A and B

The two channels to be compared (Channels A and B) are selected using the two scroll bars. Any of the 16 audio channels may be selected for comparison.

Preset (for Audio Likeness Detector 1) is Audio channel 1 selected for Channel A to be compared to Audio channel 2 for Channel B.

Enable Alarm

When checked the alarm status will be reported and logged.

For more information about alarms please see page 10.

UMID

A Unique Material Identifier (UMID) is a unique identifier for audio-visual material, which is locally created and globally unique. UMIDs can be inserted into ancillary packets and transported in a HD-SDI or SD-SDI video stream.

The Hyperion UMID operates with Basic 32-byte UMIDs (not the 64-byte extended version) and has three main functions:

Detector

The module searches the vertical ancillary space for UMID packets, and reports back the value of the UMID that it finds and the line that it finds it on. It also reports back any errors in the packet, and counts the number of frames that a UMID has been consistently present for.

Deleter

The module can be used to delete any UMIDs it finds in the Hyperion video stream. If enabled, it will mark UMID ancillary packets for deletion by setting the DID to 80h, and blank all the data held within the packet.

Generator

The module can also be used to insert a new UMID ancillary packet onto a selected line in the active region of the vertical ancillary space of the Hyperion video stream.

UMID Updates

When checked the detector reports will be enabled for *this function only* but for all other functions (that have an update button) the reports will be disabled. This action will be active for a maximum time of 5 minutes and the remaining time will be shown by the Timeout display; at the end of this time Updates OFF will be automatically selected; at the end of this time **Updates OFF** will be automatically selected.

*Note that this button cannot be unchecked; to disable the updates check the **Updates OFF** button.*

*Note also that when this button is checked the **Updates OFF** function will be implemented on **all** other screens; i.e. it is a global command.*

At power-up and when Factory Defaults or Restart Unit are selected **Updates OFF** will be automatically selected.

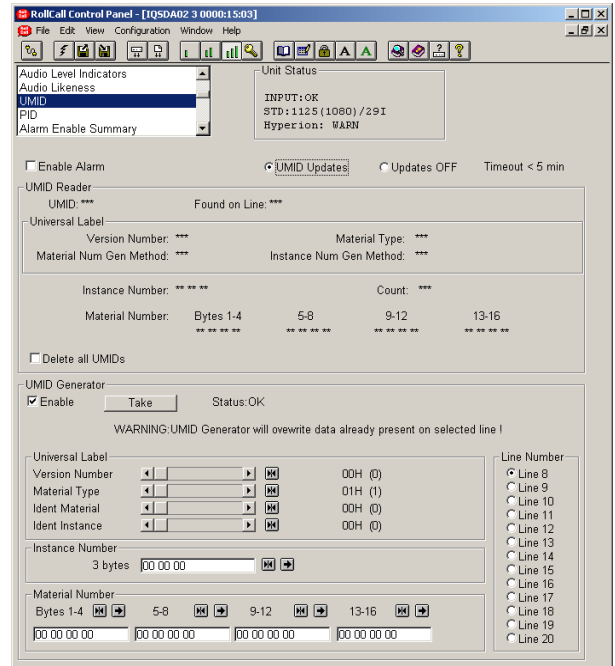

Enable Alarm

When checked the alarm status will be reported and logged.

For more information about alarms please see page 10.

UMID Reader

UMID:

This displays the status of UMIDs on the input video stream.

Text String	Meaning
" *** "	No UMID found, or no input video
" Changing "	UMID value is changing or has recently changed
" OK "	UMID found with no errors
" Multiple Line Error "	Multiple UMIDs found (not allowed)
" Checksum Error "	Ancillary Packet Checksum Error
" Length Error "	UMID is not 32 bytes long (Basic UMID Length)

Found on Line

This displays the line number on which the UMID packet was found.

UMID (continued)

UMID Reader/Universal Label

For more information please see page 69.

Version Number

Material Type

This defines the material type being identified.

Material Num(ber) Gen(eration) Method

This identifies the method by which the material number is created.

Instance Num(ber) Gen(eration) Method

This identifies the method by which the instance number is created.

Instance Number

This shows the 3-byte UMID Instance number in hex format.

Material Number

This shows the 16-byte UMID Material number in hex format as four sets of four bytes.

Delete all UMIDs

Select to turn on the UMID Deleter. All UMID ancillary packets in the input video stream will be marked for deletion in the output video stream. They will have the DID set to 180h, the SDID set to 200h, the User Data Words overwritten with 200h, and the Checksum recalculated.

UMID Generator

Enable

Select to turn on the UMID Generator. A UMID packet will be generated in the active region of vertical blanking in every subsequent frame of the output video.

Take

No changes in the value or line number of the generated UMID will take place until this button has been pressed (To ensure there are no "crossover" UMIDs generated while data is being changed)

Universal Label

This sets the adjustable parameters of the UMID Universal Label. Number next to the sliders is the hex value, with the decimal value in brackets.

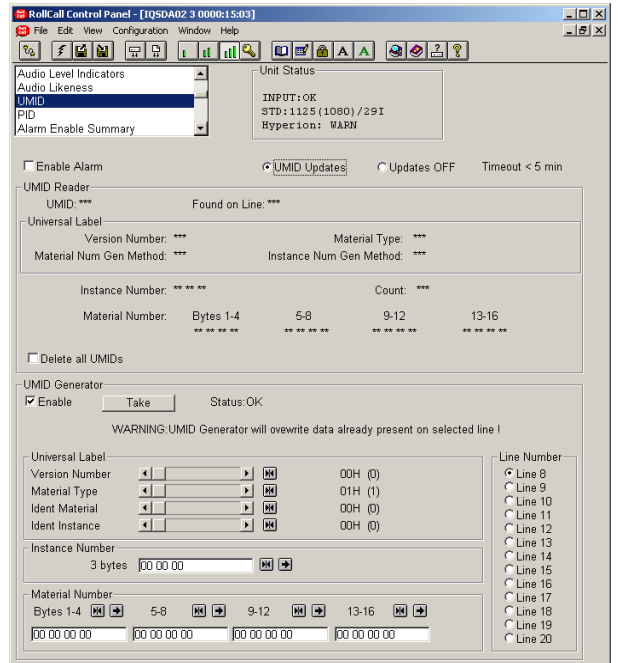

Instance Number

This is the 3-byte UMID Instance number, input in hex format.

Material Number

This is the 16-byte UMID Material number, input in hex format as four sets of four bytes.

Status

This displays the current status of the UMID Generator:

Text String	Meaning
" ** "	No Input Video
" Pass "	Video is being passed through the module untouched
" OK "	Generator is enabled and working without error
" Overwrite "	There is already a UMID present on the output Video and it is being overwritten by the generator
" Multiple Lines "	There is already a UMID present on the output Video and a second one is being generated on a different line
"Deleted"	Generator not enabled, previously generated UMIDs are deleted

Line Number

This selects which line of Vertical Blanking the UMID packet is generated.

PID

A Program Identification label (PID) can be used to store information about a video stream within the stream itself. House ID, program title, segment number, duration and frame rate can be embedded into the active region of vertical blanking of a video stream, using the Key-Length-Value (KLV) encoding method stored in an ancillary packet. The structure of the PID KLV Packet can be found in the Snell and Wilcox Metadata dictionary. All Snell and Wilcox PID packets must begin with a House ID, and can then have any combination of the other 4 data types, in any order. The Hyperion PID module has three main functions:

Detector

The module searches the vertical ancillary space for a PID packet, and reports back the information that is stored in the PID that it finds, along with the line number that it finds the PID on. It also reports if there are any errors in the packet, and counts the number of frames that the current PID has been consistently present for.

Deleter

The module can be used to delete any PID ancillary packets it finds in the video stream. If enabled, it will mark PID ancillary packets for deletion by setting the DID to 80h, and blank all the data held within the packet.

Generator

The module can also be used to insert a new PID ancillary packet into a video stream, with house ID (compulsory) and any combination of program title, segment number, duration and frame rate, onto any line in the active region of the vertical ancillary space.

Enable Alarm

When checked the alarm status will be reported and logged.
For more information about alarms please see page 10.

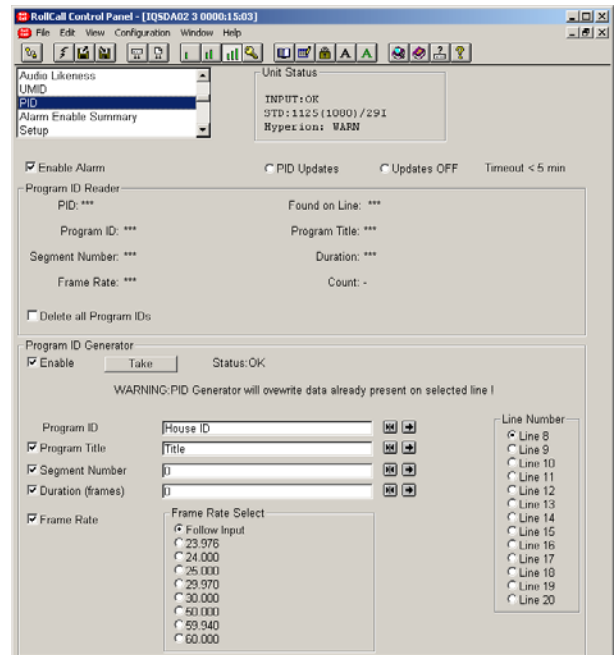

PID Updates

When checked the detector reports will be enabled *for this function only* but for all other functions (that have an update button) the reports will be disabled. This action will be active for a maximum time of 5 minutes and the remaining time will be shown by the Timeout display; at the end of this time Updates OFF will be automatically selected; at the end of this time **Updates OFF** will be automatically selected.

*Note that this button cannot be unchecked; to disable the updates check the **Updates OFF** button.*

*Note also that when this button is checked the **Updates OFF** function will be implemented on **all** other screens; i.e. it is a global command.*

At power-up and when Factory Defaults or Restart Unit are selected **Updates OFF** will be automatically selected.

PID (continued)

Program ID Reader

PID:

This displays the status of PIDs on the input video stream:

Text String	Meaning
" *** "	No PID found, or no input video
" Changing "	PID is changing or has recently changed
" OK "	PID found with no errors
" Multiple Line Error "	Multiple PIDs found (not allowed)
" Not Hyperion PID "	PID found is not a Snell and Wilcox Hyperion PID
" Inc House ID "	House ID Tag is incorrect (Should be 01)
" Illegal Tag Value "	Tag Value is invalid (only 02, 03, 04, 05 are valid)
" Inc Seg Num Len "	Segment Number Length is incorrect (should be 2 bytes)
" Inc Duration Len "	Duration Length is incorrect (should be 8 bytes)
" Inc Frame Rate Len "	Frame Rate Length is incorrect (should be 8 bytes)
" Inc Data Count "	Ancillary Packet Data Count Incorrect
" Checksum Error "	Ancillary Packet Checksum Error

Found on Line:

This displays the line number on which the PID packet was found.

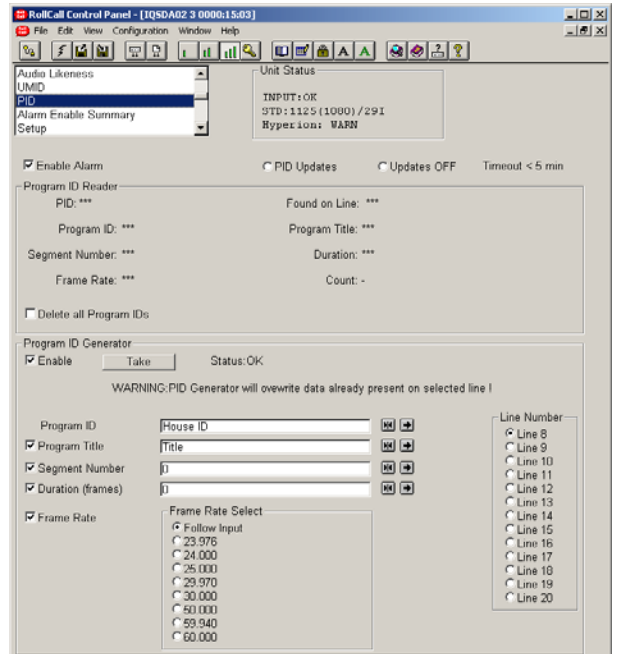

PID (continued)

Program ID: House ID:

This displays the House ID stored in the PID (Compulsory).

Program Title:

This displays the Program Title stored in the PID (** means Program Title missing).

Segment Number:

This displays the Segment Number stored in the PID (** means Segment Number missing).

Duration:

This displays the Duration stored in the PID (** means Duration missing).

Frame Rate:

This displays the Frame Rate stored in the PID (** means Frame Rate missing).

Count:

This displays the number of frames that the current PID has been present for. Resets to zero if the value of the PID changes or if the PID disappears, but will carry on counting if the line number of the PID is changed.

Delete all Program IDs

Check this box to turn the PID Deleter on. All PID ancillary packets in the input video stream will be marked for deletion in the output video stream. They will have the DID set to 180h, the SDID set to 200h, the User Data Words overwritten with 200h, and the Checksum recalculated.

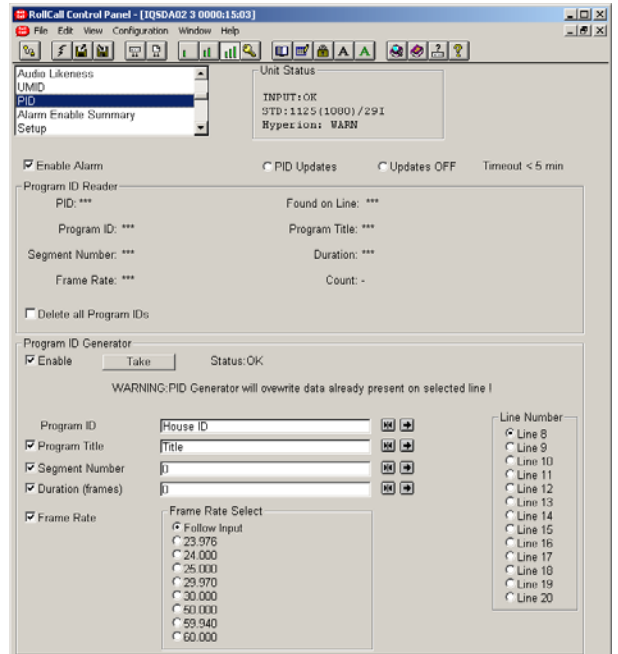

Program ID Generator

Enable:

Check this box to turn the PID Generator on. A PID packet will be generated in the active region of vertical blanking in every subsequent frame of the output video.

Take:

No changes in the value or line number of the generated PID will take place until this button has been pressed (To ensure there are no “crossover” PIDs generated while data is being changed).

Status:

This displays the current status of the PID Generator:

Text String	Meaning
“ ** ”	No Input Video
“ Pass ”	Video is being passed through the module untouched
“ OK ”	Generator is enabled and working without error
“ Overwrite ”	There is already a PID present on the output Video and it is being overwritten by the generator
“ Multiple Lines ”	There is already a PID present on the output Video and a second one is being generated on a different line

PID (continued)

Program ID:

Any combination of letters and numbers, up to a maximum of 19 characters. Always enabled.

Program Title:

Any combination of letters and numbers, up to a maximum of 19 characters. Enable by ticking the checkbox.

Segment Number:

An integer number up to the value of 65535. . Enable by ticking the checkbox.

Duration (frames):

An integer number with a maximum length of 19 digits. Enable by ticking the checkbox.

Frame Rate

When selected the frame rate (as set by the **Frame Rate Select** function) will be included.

Frame Rate Select

This allows a frame rate to be selected for the generated PID. If **Follow Input** is chosen the PID frame rate will be the same as the input signal.

Line Number:

This selects which line of Vertical Blanking the PID packet is generated on.

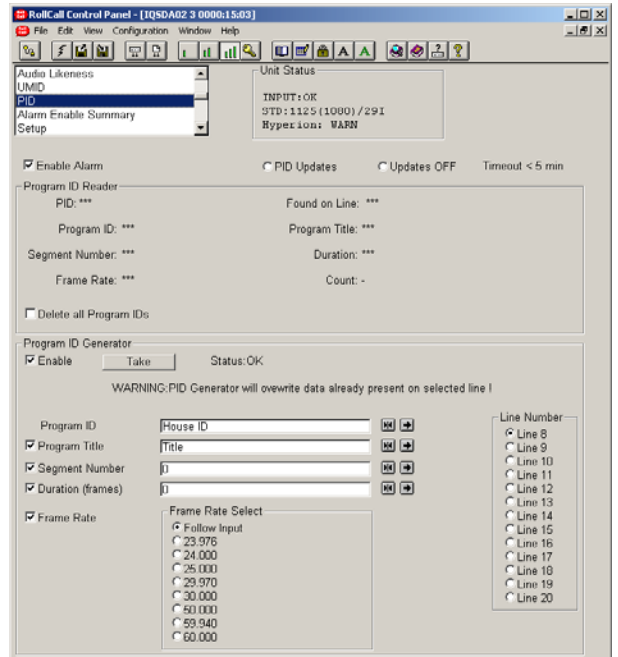

Alarm Enable Summary

This screen shows, on one screen, all the alarms and whether or not they are enabled.

This screen can also be used to enable/disable the alarms, duplicating the functions of the individual screens.

Hyperion Detector Status

This may be used to scroll through all the detectors and display their status.

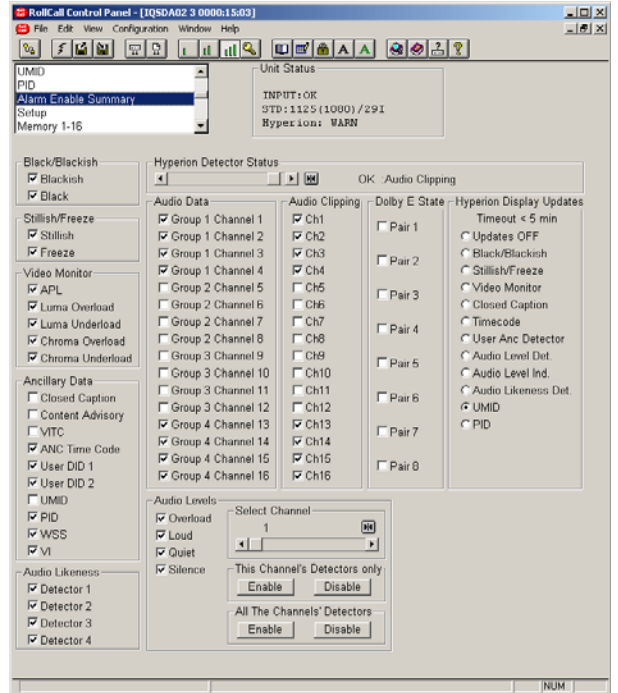

Setup

Product

This will show the name of the module.

Software Version

This item will display the version number of the software fitted to the unit.

Serial

This item will show the serial number of the unit.

Build

This will indicate the factory build number. This number defines all parameters of the unit (software versions, build level etc.) for identification purposes.

KOS

This shows the version of the operating system.

PCB

This shows the PCB revision number.

Firmware

This shows the version of the firmware system

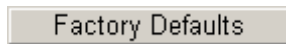

Selecting this item returns all adjustment functions that include a preset facility, to their factory default values.

Note that this operation will not occur instantly and will take time to implement.

IMPORTANT NOTICE
This function will also clear all the saved memory settings and return them to the factory values.

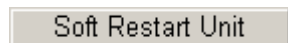
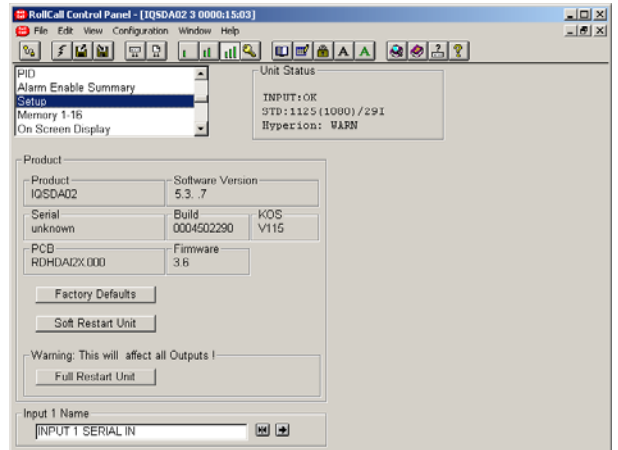

(Only available at Supervisor level)

This will reboot the unit simulating a power-down power-up cycle restoring power-up settings without disturbing the output picture. This function should be used to reboot the software if, for example, it fails to respond.







(Only available at Supervisor level)

This will reboot the unit simulating a power-down power-up cycle restoring power-up settings **but will produce disturbances on the output picture**. This function should be used to reboot the software if a Soft Restart does not solve the problem or if new software has been installed.

Input 1 Name

This is the name of the input signal that will appear on screen.

To change the name, type the new name in the text area (the return symbol changes to red ) and then select  (return) to save the new name. The symbol  will then become black again.

Selecting Preset  will return the text to the default name of INPUT 1 SERIAL IN.

Memory

Save (Memory 1 - 16)



This item will store the settings in the selected memory location.

Recall (Memory 1 - 16)

This item will recall the settings from the selected memory location.

Memory 1 - 16

The memory location name may be renamed.

To change the memory name, type the new name in the text area (the return symbol changes to red ) and then select  (return) to save the new name. The symbol  will then become black again.

Selecting Preset  will return the text to the default name.

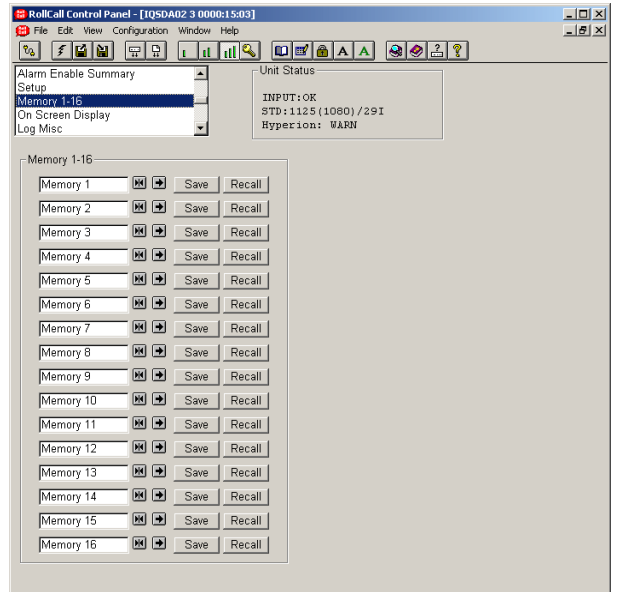

On Screen Display

The On Screen Display may show the detector windows and selected detector indicators.

To prevent the On Screen Display accidentally appearing on the output picture the numbers 1, 2, 3, 4, 5, 6 must first be typed into the text box and then followed by  (return). The On-Screen Display **Enable** box may then be checked and the indicators will appear on the output picture. *Note that the Enable box must be checked within 4 seconds of selecting return.*

! Warning !
Enabling the On Screen Display will add the detector indicators and windows to all outputs.

Detector Windows

A HYPERION parameter with a detector window can either detect the parameter inside the window, outside of the window or over the entire screen. The controls that define the detector window are x and y start co-ordinates within the active area of the picture, and two length parameters, Width and Height.

X Position

This denotes the horizontal starting position of the active windowed area measured from the top left hand corner. *Note that the numerical range of the control is dependent on the operating standard.*

Preset  is the minimum value.

Y Position

This denotes the vertical size position of the active windowed area measured from the top left hand corner. *Note that the numerical range of the control is dependent on the operating standard.*

Preset  is the minimum value.

Width

This denotes the horizontal size of the active windowed area. *Note that the numerical range of the control is dependent on the operating standard.*

Preset  is the maximum value.

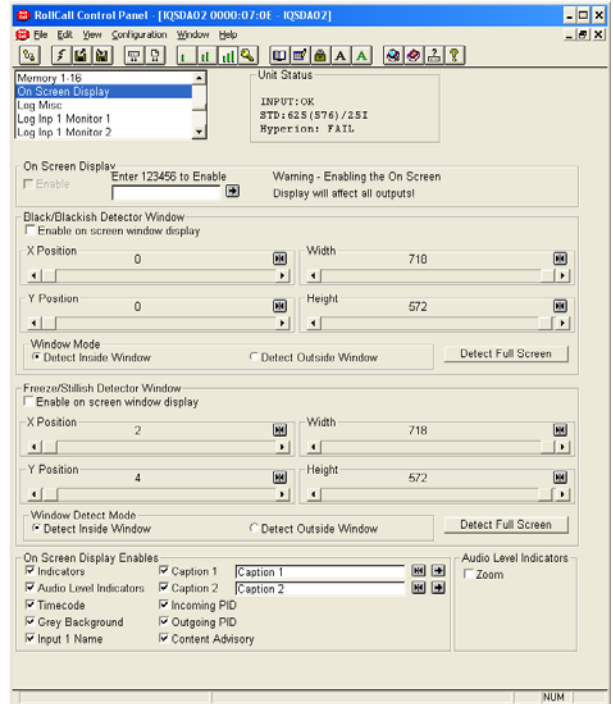

Height

This denotes the vertical size of the active windowed area. *Note that the numerical range of the control is dependent on the operating standard.*

Preset  is the maximum value.

Windows Mode

These selections allow detection to be **Inside** the window, **Outside** of the window or over the **Full Screen**.

Enable on screen window display

When checked the associated detector window will appear on the output picture.

On Screen Display (continued)

On Screen Display Enables

When checked the associated function will be enabled and available for the on screen display. (For more details please see page 11)

Indicators

When checked the Hyperion status boxes and bargraphs will appear on the screen.

Audio Level Detectors

When checked the audio monitoring bargraphs will appear on the screen.

Timecode

When checked the timecode readout will appear on screen.

Grey Background



When checked the picture area behind the indicators will become monochrome.

Input 1 name

When checked the name of the input signal will appear on screen. This is the name entered using the renaming function on the **Setup** screen (see page 48).

Caption 1 and 2

When checked this allows one or two captions to be displayed on the screen

To change the caption text, type the new name in the text area (the return symbol changes to red ) and then select  (return) to save the new name. The symbol  will then become black again.

The factory default text is Caption 1 and Caption 2.

Incoming PID

When checked any incoming Program Identification information (PID) will be displayed on the screen. If nothing has been detected asterisks will be displayed.

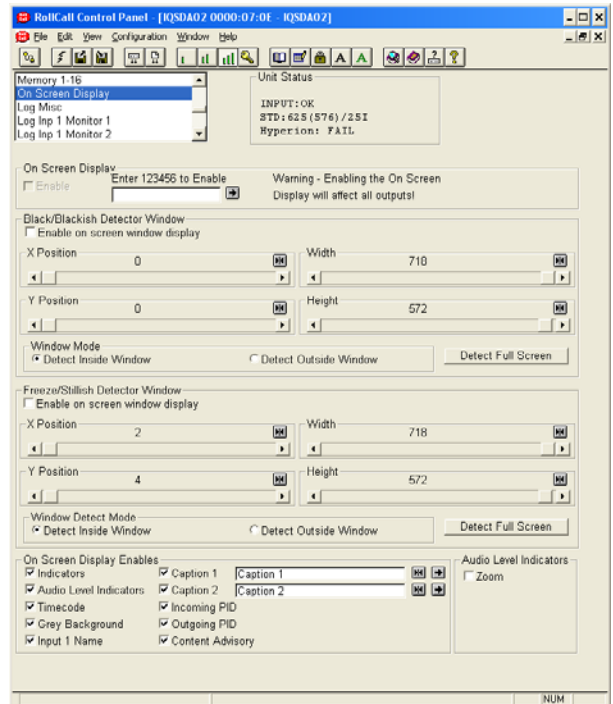

Outgoing PID

When checked any outgoing Program Identification information (PID) will be displayed on the screen. If nothing has been detected asterisks will be displayed.

Content Advisory

When checked any content advisory information that has detected in the input stream will be displayed on the screen. If nothing has been detected asterisks will be displayed.

Audio Level Meters

Normally the range of the audio level meters is from 0 to -100 dB; if the Zoom function is checked the range becomes 0 to - 50 dB. This allows the higher audio levels to be observed more easily.

Normal Display

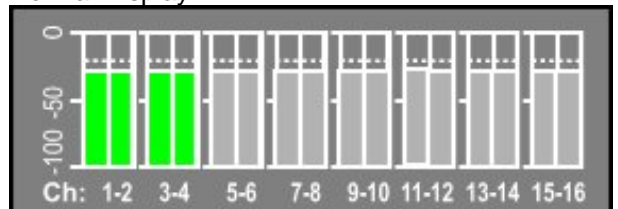

Display with Zoom Enabled

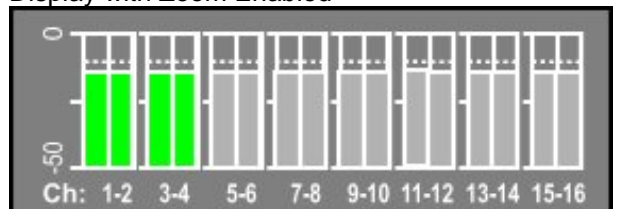

Log Misc

Information about various parameters can be made available to a logging device that is attached to the RollCall™ network by checking the appropriate box. Please see page 60 for RollCall Logfields information.

The status is shown to the right of the item.

Any of the items may be selected from the list.

Logging Misc.

This allows product information to be logged

Logging Input 1

This allows information about the input signal to be logged

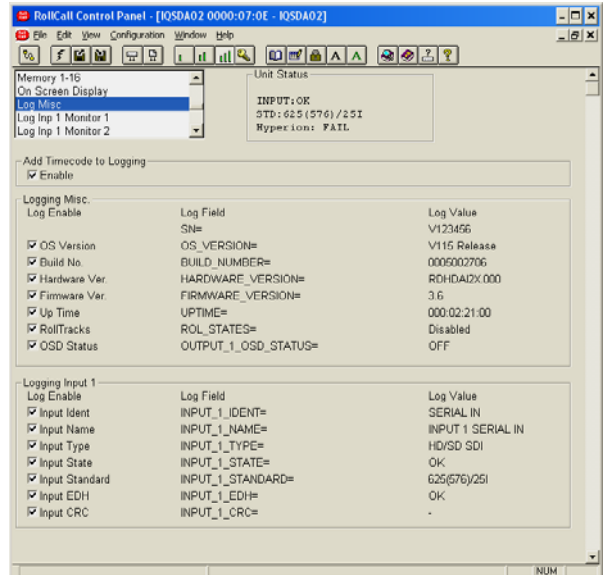

Log Input 1 Monitor 1 and 2

Hyperion Global State

When checked the global state of the Hyperion reporting will be logged.

Note that this function is available on all Logging screens. Checking this on one screen will activate the function on all other screens.

Logging Input 1 Monitor 1 and 2

This allows input monitoring information to be logged.

Note: The Timecode Log option allows failures to be recorded at either the start of failing or at fail.

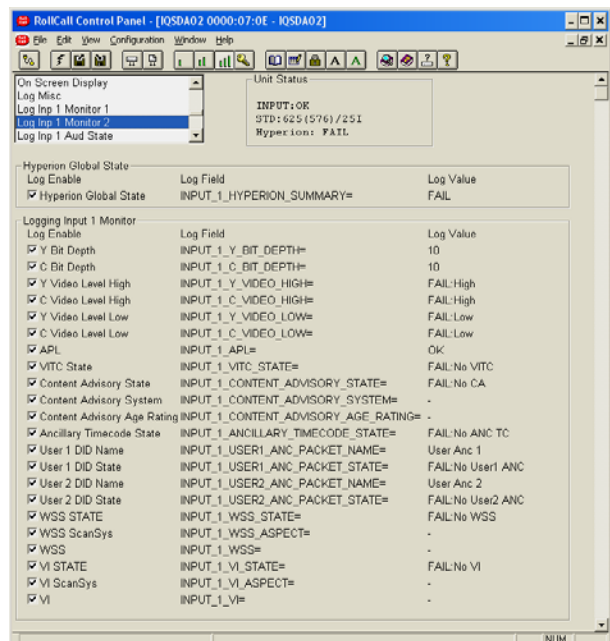
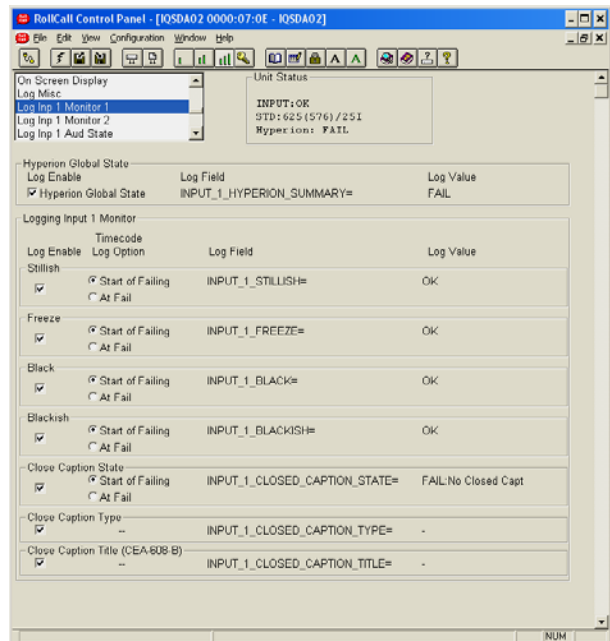

Log Input 1 Aud State

This allows the status of the 16 channels of embedded audio to be logged.

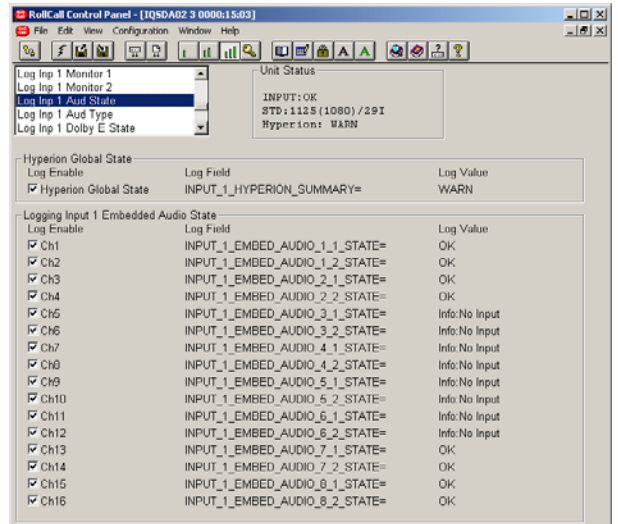

Log Input 1 Aud Type

This allows the type of the 16 channels of embedded audio to be logged.

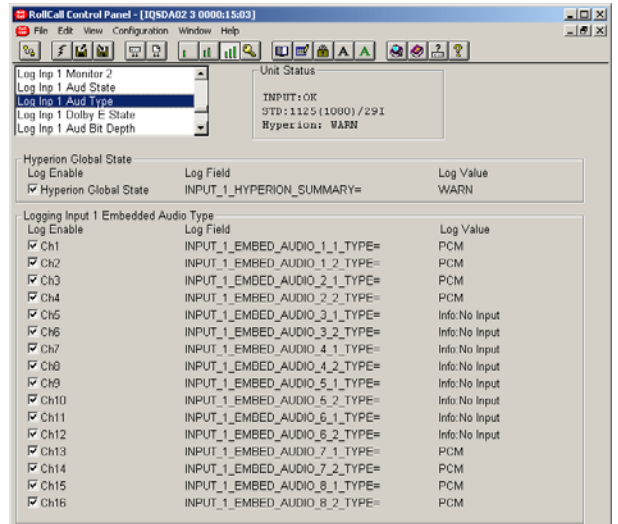

Log Input 1 Dolby E State

Logging Input 1 Embedded Audio Dolby E State

This allows the state of the eight embedded Dolby E audio pairs to be logged.

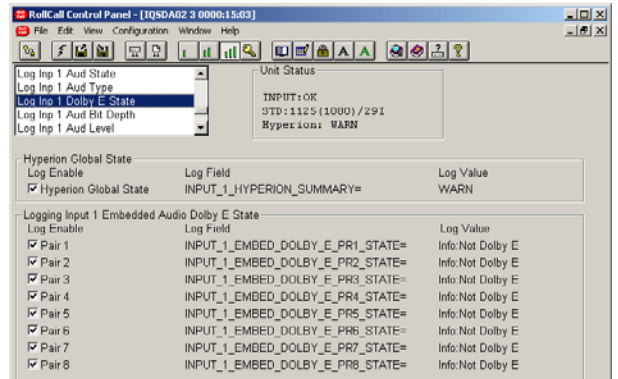

Log Input 1 Aud Bit Depth

This allows the bit depth of the 16 channels of embedded audio to be logged.

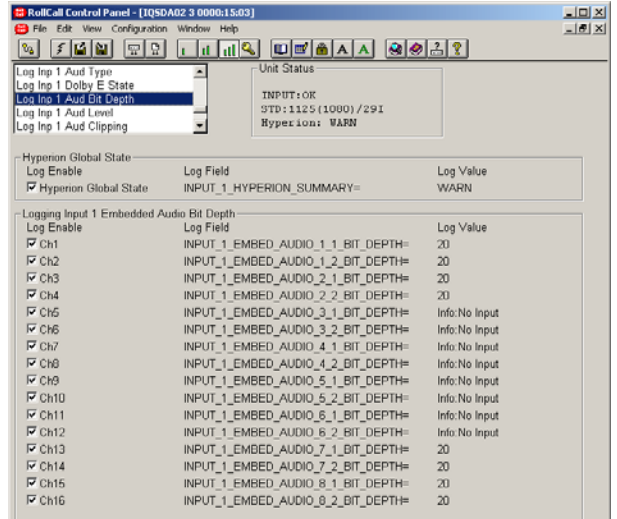

Log Input 1 Aud Level

This allows the levels of the 16 channels of embedded audio to be logged.

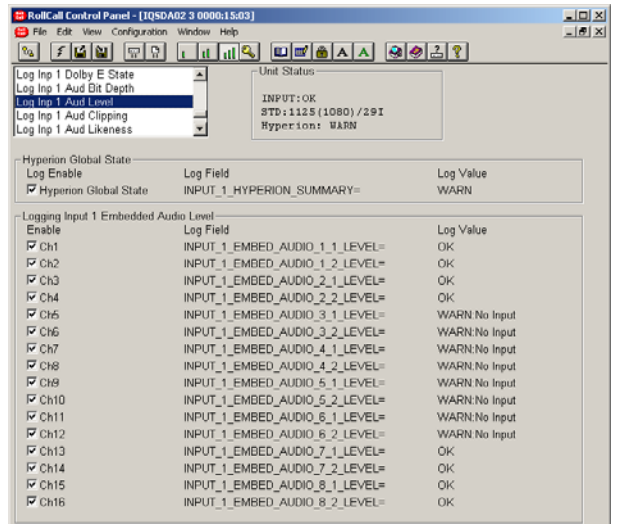

Log Input 1 Aud Clipping

Logging Input 1 Embedded Audio Clipping

This allows the clipping state of the sixteen embedded audio channels to be logged.

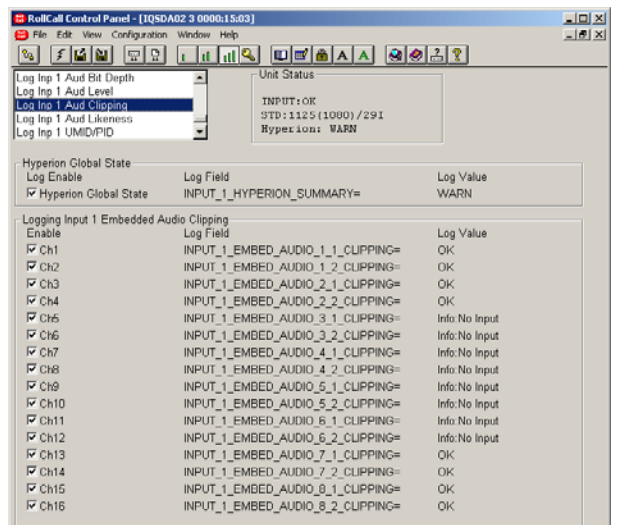

Log Input 1 Aud Likeness

This allows the likeness parameters of the audio channels to be logged.

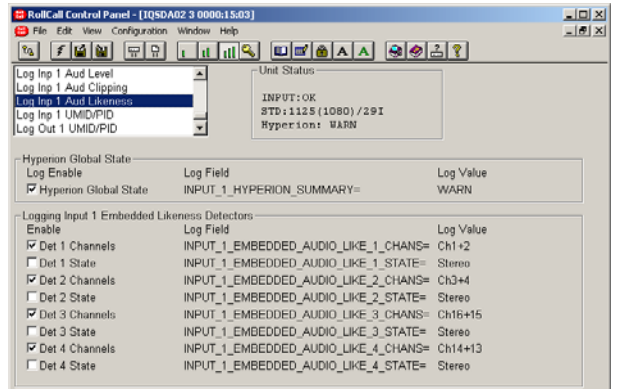

Log Input 1 UMID/PID

This allows the input UMID/PID parameters to be logged.

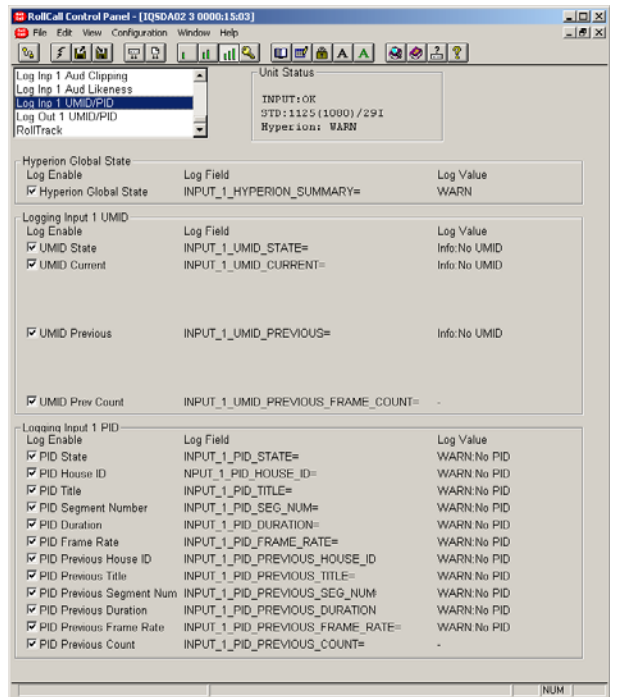

Log Output 1 UMID/PID

This allows output UMID/PID parameters to be logged.

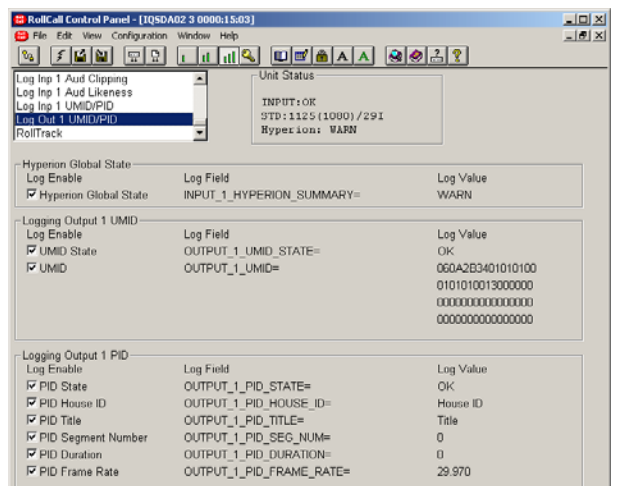

RollCall Logging Priorities

Each audio channel has a set of four level detectors - Silence, Quiet, Loud and Overload. These can independently report 'Fail', 'Warn' or 'Ok'. Only one audio level state is reported for each channel. Certain states are considered to be of higher importance than others so in order to retain the more critical information the issuing of logging messages is governed by a simple priority scheme as shown in the diagram below.

Note that to produce an OK logging message all four detectors must report OK whereas any individual Warn or Fail reports will produce the appropriate logging message.

A logging message will be issued for the highest active priority state.

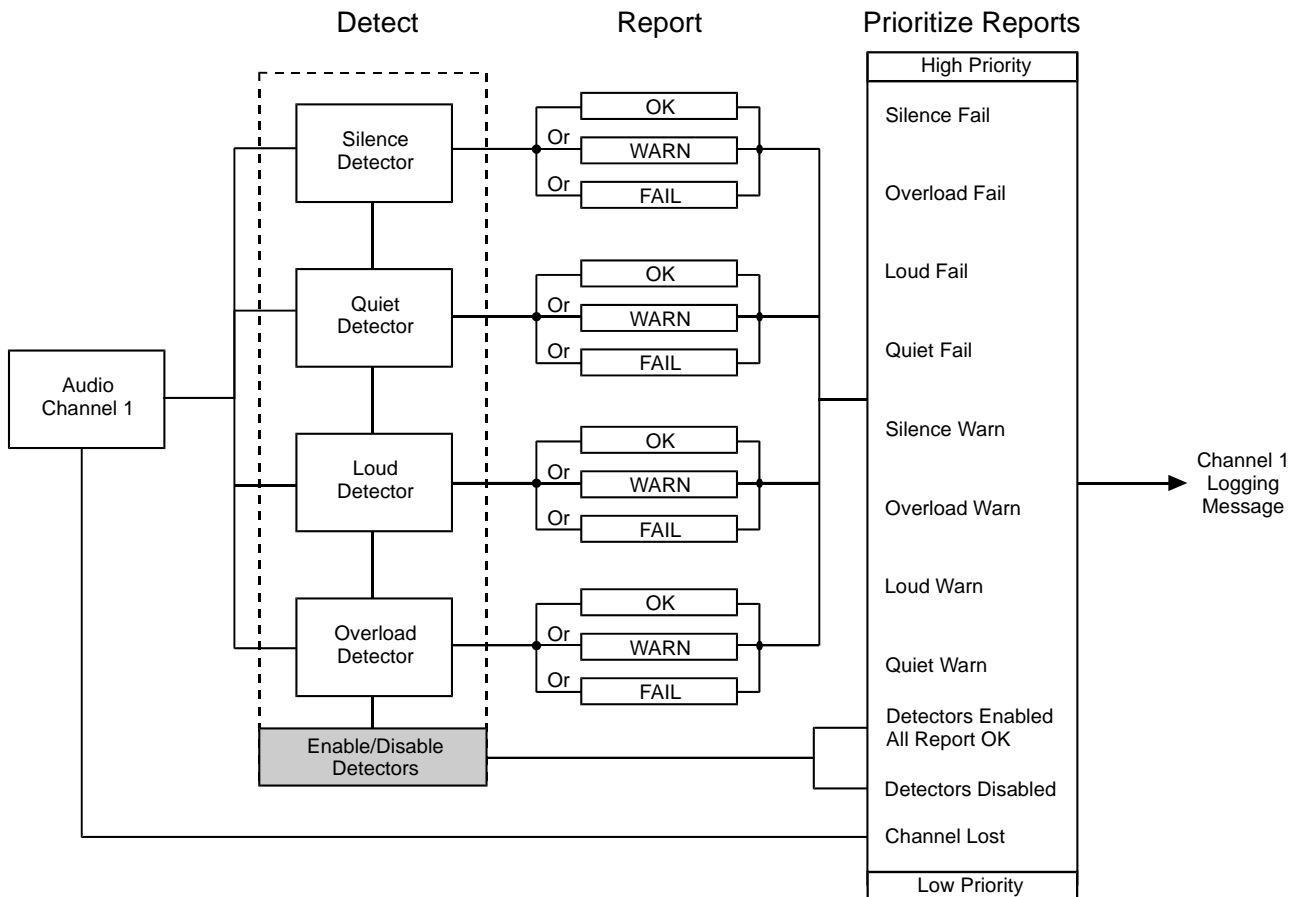

RollCall Logging Priorities Functionality (Channels 2 to 16 are identical)

RollTrack

Rolltrack Output

This function allows information to be sent, via the Rollcall network, to other compatible units connected on the same network.

Disable All

When this item is checked all RollTrack items will be disabled.

Index

This item allows up to 16 destinations to be selected.

Source

This allows the source of information that triggers the transmission of data to be selected.

Options are:

Unused	IP1 750(720)/60P
Input OK	IP1 750(720)/59P
Input None	iP1 525(480)/29i
iP1 1125(1035)/30i	iP1 625(576)/25i
iP1 1125(1035)/29i	IP1 1125(1080)/24sF
iP1 1125(1080)/30i	IP1 1125(1080)/23sF
iP1 1125(1080)/29i	IP1 750(720)/50P
iP1 1125(1080)/25i	IP1 750(720)/30P
IP1 1125(1080)/30P	IP1 750(720)/29P
IP1 1125(1080)/29P	IP1 750(720)/25P
IP1 1125(1080)/25P	Hyperion OK
IP1 1125(1080)/24P	Hyperion WARN
IP1 1125(1080)/23P	Hyperion FAIL
	Hyperion N/A

The destination for the information is set by the network code address as follows:

Address

This item allows the address of the selected destination unit to be set.

To change the address, type the new destination in the text area and then select  (return)

 (Preset) returns to the default destination

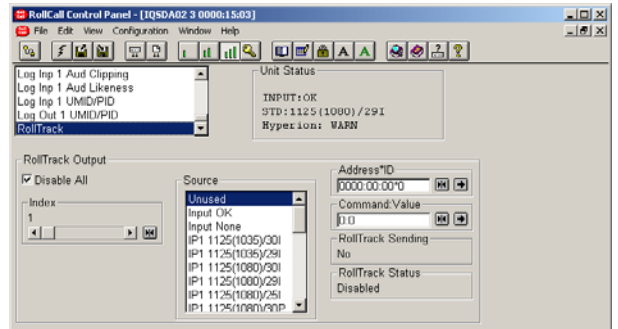

The full **RollTrack** address has four sets of numbers

For example: 0000:10:01*99

The first set (0000) is the network segment code number

The second set (10) is the number identifying the (enclosure/mainframe) unit.

The third set (01) is the slot number in the unit

The fourth set (99) is a user settable number that is a unique identification number for the destination unit in a multi-unit system. This ensures that only the correct unit will respond to the command. If left at 00 an incorrectly fitted unit may respond inappropriately.

Command

The full **RollTrack** command has two sets of numbers

For example: 84:156

The first set (84) is the **RollTrack** command number

The second set (156) is the value sent with the **RollTrack** command number

RollTrack (continued)

RollTrack Sending

This item shows when the unit is actively sending the RollTrack command.

This may show:

String	A string value is always being sent.
Number	A number value is always being sent.
No	The message is not being sent.
Yes	The message is being sent.
Internal Type Error	Inconsistent behavior; please contact your local Snell & Wilcox agent.

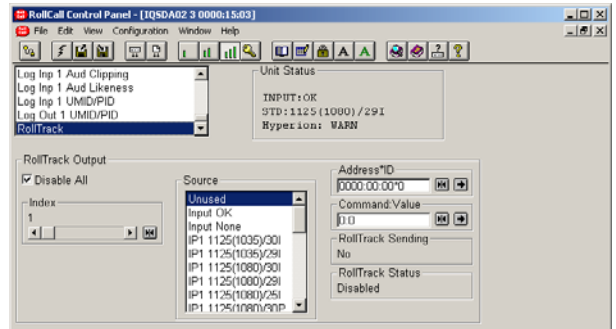

RollTrack Status

This item will show the status of the currently selected RollTrack index.

This may show:

OK	RollTrack message sent and received OK.
Unknown	Rolltrack message has been sent but it has not yet completed.
Timeout	RollTrack message sent but acknowledgement not received. This could be because the destination unit is not at the location specified.
Bad	RollTrack message has not been correctly acknowledged at the destination unit. This could be because the destination unit is not of the type specified.
Disabled	RollTrack sending is disabled.

Unit Status

Basic information about the status of the unit is shown in the information area.

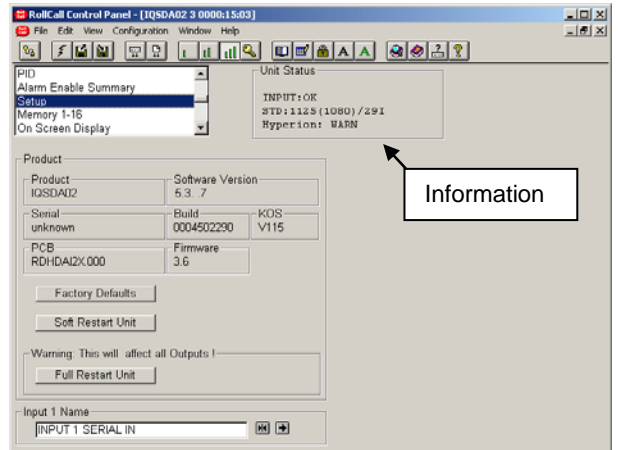

INPUT:

This will show the status of the input.

It may show:

INPUT: OK A valid signal has been detected.

INPUT: LOST

STD: This will show the standard of the input signal.

STD: 625(576)/25i

Hyperion

This will show the Hyperion status. It may show:

Hyperion: OK

Hyperion: WARN

Hyperion: FAIL

EDH/CRC Detection/Insertion

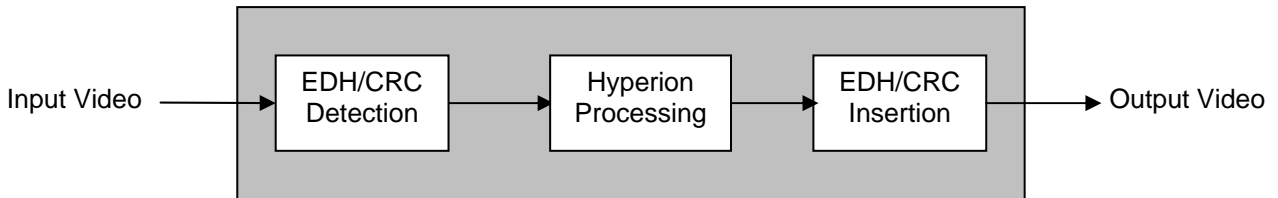

The Hyperion Distribution Amplifier is capable of detecting CRC (HD-SDI) and EDH (SD-SDI) errors on incoming video streams. It also recalculates and inserts CRC and EDH checksums and data on the outgoing video.

ROLLCALL LOG FIELDS

Log Field	Log Value	Description
Misc Logging		
SN=	String	Serial Number
OS_VERSION=	String	Operating System version number
BUILD_NUMBER=	String	Build Number
HARDWARE_VERSION=	String	Hardware version number
FIRMWARE_VERSION=	String	Firmware version number
UP TIME=	String	Time unit has been switched on
ROL_STATES=	Disabled OK FAIL	
OUTPUT_1_OSD_STATUS=	OFF WARN:ON	
Logging Input 1		
INPUT_1_IDENT=	SERIAL IN	
INPUT_1_NAME=	String	
INPUT_1_TYPE=	HD/SD SDI	
INPUT_1_STATE=	FAIL:Lost OK	
INPUT_1_STANDARD=	WARN:No Input UNKNOWN Standard	525(480)29I, 625(576)/25I, 1125(1080)/29I, 750(720)/59P etc
INPUT_1_EDH=	- OK WARN:EDH Error None	
INPUT_1_CRC=	- OK WARN:CRC Error	
Log Input 1 Monitor 1		
INPUT_1_HYPERION_SUMMARY=	OK WARN FAIL	See RollCall Logging Priorities on page 56
INPUT_1_STILLISH=	OK WARN FAIL	
INPUT_1_FREEZE=	OK WARN FAIL	
INPUT_1_BLACK=	OK WARN FAIL	
INPUT_1_BLACKISH=	OK WARN FAIL	
INPUT_1_CLOSED_CAPTION._STATE=	OK WARN FAIL	

Log Field	Log Value	Description
INPUT_1_CLOSED_CAPTION_TYPE=	- CEA-608-B CEA-708-B	
INPUT_1_CLOSED_CAPTION_TITLE=	STRING	
Log Input 1 Monitor 2		
INPUT_1_Y_BIT_DEPTH=	10 9 8 UNKNOWN	
INPUT_1_C_BIT_DEPTH=	10 9 8 UNKNOWN	
INPUT_1_VIDEO_Y_LEVEL_HIGH=	OK FAIL	
INPUT_1_VIDEO_C_LEVEL_HIGH=	OK FAIL	
INPUT_1_VIDEO_Y_LEVEL_LOW=	OK FAIL	
INPUT_1_VIDEO_C_LEVEL_LOW=	OK FAIL	
INPUT_1_APL=	OK WARN:MINAPL WARN:MAXAPL	
INPUT_1_VITC_STATE=	OK FAIL	
INPUT_1_CONTENT_ADVISORY_STATE=	OK FAIL	
INPUT_1_CONTENT_ADVISORY_SYSTEM=	0-MPA 1-US TV PG 2-MPA 3-Canadian Eng 4-Canadian Fr 5-Reserved 6-Reserved	Interpreted from CEA-608-B
INPUT_1_CONTENT_ADVISORY_AGE_RATING=	MPA See table 20 US PG See table 21 Other **	Section 9.5.1.05h Content Advisory
INPUT_1_ANCILLARY_TIMECODE_STATE=	OK FAIL	
INPUT_1_USER_1_ANC_PACKET_NAME=	String	
INPUT_1_USER_1_ANC_PACKET_STATE=	OK FAIL	
INPUT_1_USER_2_ANC_PACKET_NAME=	String	
INPUT_1_USER_2_ANC_PACKET_STATE=	OK FAIL	
INPUT_1_WSS_STATE=	OK FAIL	
INPUT_1_WSS_ASPECT=	STRING	
INPUT_1_WSS=	STRING	
INPUT_1_VI_STATE=	OK FAIL	
INPUT_1_VI_ASPECT=	STRING	
INPUT_1_VI=	STRING	
Log Input 1 Aud State		

Log Field	Log Value	Description
INPUT_EMBED_AUDIO_1_1_STATE= To INPUT_EMBED_AUDIO_8_2_STATE=	OK WARN:No Input	
Log Input 1 Aud Type		
INPUT_EMBEDDED_AUDIO_1_1_TYPE To INPUT_EMBEDDED_AUDIO_8_2_TYPE=	PCM Dolby E Dolby D (AC3) WARN:No Input	
Logging Input 1 Embedded Audio Dolby E State		
INPUT_1_EMBED_DOLBY_E_PR1__STATE= To INPUT_1_EMBED_DOLBY_E_PR8__STATE=	OK WARN:Early WARN:Late WARN:Error FAIL:Not Dolby E	
Log Input 1 Aud Bit Depth		
INPUT_EMBEDDED_AUDIO_1_1_BIT_DEPTH= To INPUT_EMBEDDED_AUDIO_8_2_BIT_DEPTH=	24 20 16 UNKNOWN WARN:No Input	
Log Input 1 Aud Level		
INPUT_EMBEDDED_AUDIO_1_1_LEVEL= To INPUT_EMBEDDED_AUDIO_8_2_LEVEL=	OK WARN FAIL WARN:No Input WARN:NON PCM	Logs state of Overload, Loudness, Quiet and Silence detectors. For order of priority see page 56:
Logging Input 1 Embedded Audio Clipping		
INPUT_1_EMBED_AUDIO_1_1_CLIPPING= INPUT_1_EMBED_AUDIO_1_2_CLIPPING= To INPUT_1_EMBED_AUDIO_8_1_CLIPPING= INPUT_1_EMBED_AUDIO_8_2_CLIPPING=	OK WARN:No Input WARN:NON PCM WARN:Clipping	
Log Input 1 Aud Likeness		
INPUT_EMBEDDED_AUDIO_LIKE_1_CHANS= To INPUT_EMBEDDED_AUDIO_LIKE_4_CHANS=	Ch x +y	Channels being compared
INPUT_EMBED_AUDIO_LIKE_1_STATE= To INPUT_EMBEDDED_AUDIO_LIKE_4_STATE=	Stereo Mono Wide Inv_Stereo Inv_Mono Inv_Wide WARN:Error WARN:NON PCM	
Log Input 1 UMID		
INPUT_1_UMID_STATE=	OK WARN Changing	
INPUT_1_UMID_CURRENT=	String WARN:	

Log Field	Log Value	Description
INPUT_1_UMID_PREVIOUS=	String WARN:	
INPUT_1_UMID_PREV_COUNT=	Number -	Number of frames previous count

Log Input 1 PID		
INPUT_PID_STATE=	OK WARN Changing	
INPUT_PID_HOUSE_ID=	String WARN:	
INPUT_PID_TITLE=	String WARN:	
INPUT_PID_SEG_NUM=	String WARN:	
INPUT_PID_DURATION=	String WARN:	
INPUT_PID_FRAME_RATE=	Number WARN:	
INPUT_PID_PREVIOUS_HOUSE_ID=	String WARN:	
INPUT_PID_PREVIOUS_TITLE=	String WARN:	
INPUT_PID_PREVIOUS_SEG_NUM=	String WARN:	
INPUT_PID_PREVIOUS_DURATION=	String WARN:	
INPUT_PID_PREVIOUS_FRAME_RATE=	Number WARN:	
INPUT_PID_PREVIOUS_COUNT=	Number -	Number of frames previous count
Log out 1 UMID		
OUTPUT_UMID_STATE=	OK PASS OVERWRITE DELETED WARN:Multiple Lines	
OUTPUT_1_UMID=	String WARN:No UMID	
Log out 1 PID		
OUTPUT_1_PID_STATE=	OK PASS OVERWRITE DELETED WARN:Multiple Lines	
OUTPUT_1_PID_HOUSE_ID=	String WARN:No PID	
OUTPUT_1_PID_TITLE=	String WARN:No PID	
OUTPUT_1_PID_SEG_NUM=	String WARN:No PID	
OUTPUT_1_PID_DURATION=	String WARN:No PID	
OUTPUT_1_PID_FRAME_RATE=	Number WARN:No PID	

Note: Any Hyperion function that is not enabled this will log *INFO: (Function information) e.g. INFO:OK.*

Operation from an Active Control Panel

The card may be operated from an active control panel via the RollCall™ network.

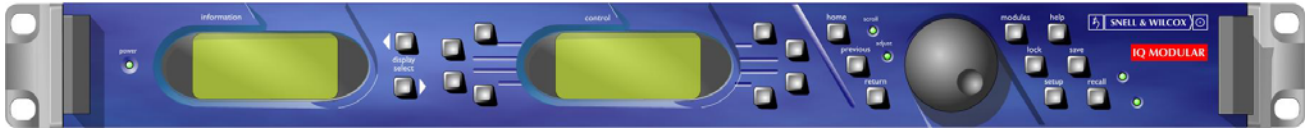

All operational parameters and selections are made using a system of menus displayed in two LCD windows.

The functions are the same as those described for the RollCall Templates.

Operational details for the remote control panel can be found in the Modular System Operator's Manual.

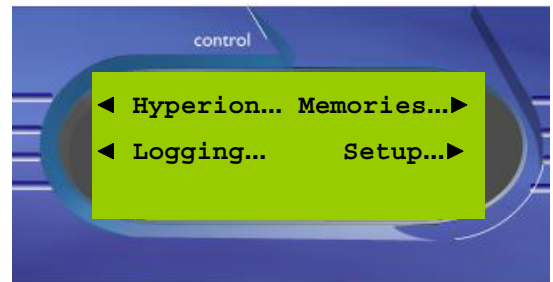

Hyperion - an Overview

Hyperion aims to provide a set of monitoring processes which mimic the eyes and ears of an operator, monitoring the content of a signal rather than measuring the absolute technical properties of the signal carrying the content.

The goal of Hyperion is to have 'an opinion' on whether content is currently earning revenue for the customer. Once a condition has been detected, it needs to be reported to the operator such that they can make a decision on whether any intervention is required.

Hyperion is designed to continuously and automatically monitor signal content and provide guidance as to whether it is still earning revenue. Unlike conventional automated monitoring therefore, Hyperion is not targeted at measuring technical parameters that are easy to measure. Instead, Hyperion monitors content in a similar way to a human observer. Hyperion is designed to interpret whether the content lacks value by matching its actual behavior with a pre-set profile of expected behavior. The factors monitored in this profile include the motion content of the video signal for example or the amount of dark content. Unlike less sophisticated systems the detection works on stillish and not absolutely still pictures or blackish and not absolutely black pictures. The principle is that if a picture is largely still then it is probably not valuable, it is probably not fulfilling its role of generating revenue. Multiple channels of sound are monitored as well as picture content.

Typically, Hyperion would be used in systems where one supervising operator has to attend to many broadcast channels. By alerting operators managing a system rapidly when content falls below expectations issue can be caught before serious loss of revenue occurs.

Hyperion can be used to direct the operator to which of many points in a system should be monitored more closely. Hyperion improves operational efficiency by allowing one person to supervise many more channels than would otherwise be possible while maintaining higher levels of overall system reliability. By directing the observer to view the channel or area of workflow that appears to least closely match a typical healthy profile the observer can operate at maximum efficiency.

Because the minimum acceptable levels will vary between channels, the detector will be provided with a profile for the application. The profile consists of a number of threshold settings for each of the measured factors. The profile would be set differently for a music channel than a film channel for example. Hyperion is a standard monitoring algorithm allowing a measurement made in one place to be compared by another taken at a different point in the signal chain.

Located at the signal output of a piece of equipment, Hyperion is output monitoring. This means that if an audio signal is attenuated in the product itself for example then the Hyperion system will still provide a fail corresponding to a low-level audio warning. It will not be inhibited just because there is a technical explanation of why the audio levels were low. In summary, Hyperion is not interested in the 'why' of the situation, just the 'what'.

Supporting the content issues detection are tools to enable remote monitoring over IP and source to output content identification. These will allow signals to be verified automatically by UMID insertion and comparison to ensure what is supposed to be played out actually is.

For remote content identification, delivery of video thumbnail images to the operator provides a secondary manual level of confidence that content is correct at both internal and remote locations.

Audio Likeness Detector

The Audio Likeness Detector monitors the relationship between the two selected channels, and determines whether the channels are the same (dual monophonic), stereo or largely unrelated. It also determines whether the polarities of the two channels match.

The detector reports a likeness number from -100 to +100. The larger the absolute value, the more alike the two channels are. If the two selected channels are virtually identical (2 x mono) the reported number will be 100 if their polarities match and -100 if one of them has been inverted.

If the values of the Left and Right samples of a stereo pair are plotted as y versus x respectively a Lissajous Figure is produced. For audio applications this is sometimes referred to as a Phase Analysis Diagram, however the concept of phase is only valid when referring to a single frequency component which is common to both channels.

When the Left and Right samples are identical in value (i.e. mono x 2) a 45 degree line is produced. All of the sample pair points lie either in the upper right or lower left quadrants as shown below.

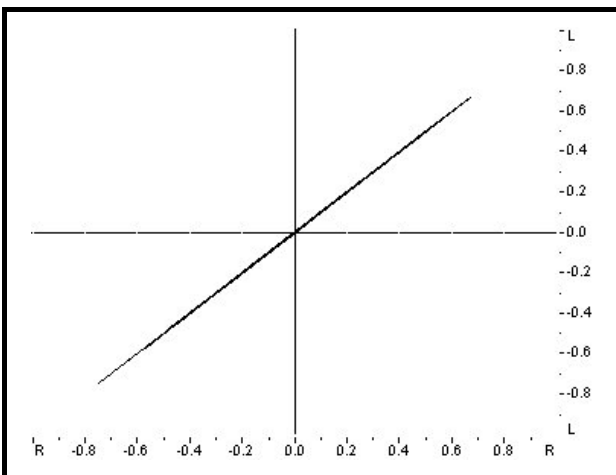

Mono: Likeness = +100

If the two channels form a stereo pair they are related but not identical. Many of the plotted points will be off the 45-degree line, but the underlying trend will remain as shown below.

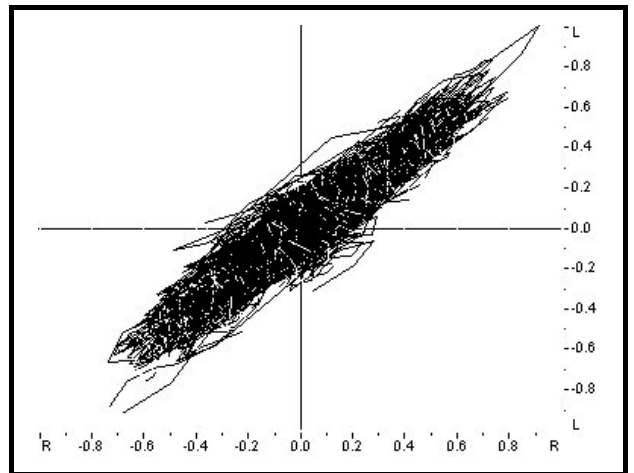

Stereo: Likeness = +70

If one of the channels becomes inverted (e.g. wires crossed on a balanced analog signal) the shape on the diagram will be reflected in either the x (Left inverted) or y (Right inverted) axis.

The majority of the plotted points will now lie in the upper-left and lower-right quadrants as shown below.

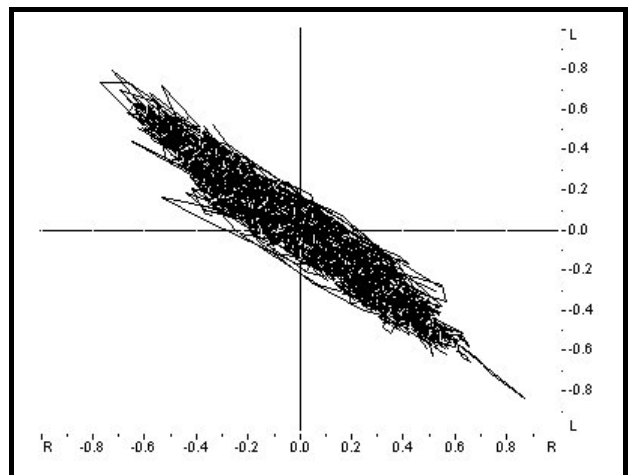

Reversed: Stereo Likeness = -70.

Audio Likeness Detector (continued)

If the two channels are unrelated the shape on the diagram becomes circular. There is a roughly even distribution of plot points across all four quadrants as shown below. Relative polarity has no meaning in this case.

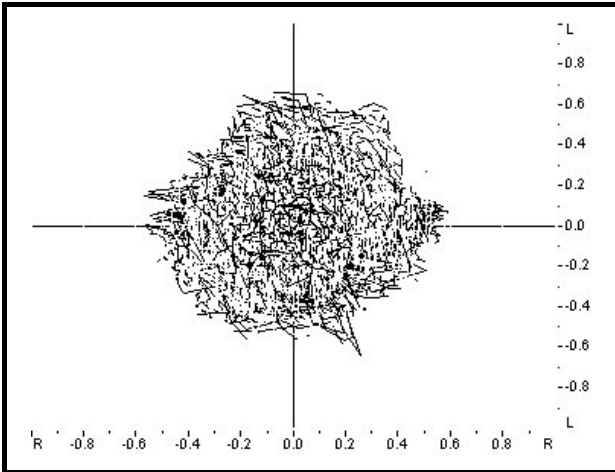

Unrelated channels: Likeness = 0.

A simple timer and a set of thresholds determine logging state.

Value	Type	Description
+91 to +100	Mono	Identical channels, same polarity.
+25 to +90	Stereo	Similar channels, i.e. Stereo.
0 to +24	Wide	Channels have little/no short term similarity.
-1 to -24	Reverse Wide	Little/no similarity, but one may be inverted.
-25 to -90	Reverse Stereo	Stereo pair, but one has been inverted.
-91 to -100	Reverse Mono	Identical channels, but one has been inverted.

The short-term similarity between channels of a typical stereo pair varies and the likeness number can momentarily pass into the Wide and Mono bands, whereas true Mono and Wide pairs tend to stay within their bands. To reduce logging traffic the normal reporting state of the detector is Stereo and it will only report Mono or Wide if the **Likeness** number is in the appropriate ranges (positive or negative) for more than five seconds. As soon as the number goes back to the Stereo range the reported state will revert to Stereo (without a delay).

Limitations

The detector algorithm is robust against relative channel delays, but it is not immune. As relative delay is increased the likeness number reduces. For example, if the two channels are identical (2 x mono) but one is delayed the likeness number will drop below 100. For large delays the detector will report that the channels are a Stereo pair. Delays of such magnitude grossly distort the sound field and are very noticeable.

The detector algorithm looks at the short-term relationship between the selected channels. On some material (e.g. classical music) the similarity between channels is only detectable over longer periods. In such cases where the stereo image is strongly divided between the channels this detector will report **Wide**.

Unique Material Identifier (UMID)

Extracts from SMPTE Standard for Television - Unique Material Identifier (UMID)
SMPTE 330M-2004 © 2004 reproduced with the kind permission of the SMPTE.

5.1 Basic UMID

5.1.1 12-byte universal label

The first 12 bytes of the UMID shall provide identification of the UMID by the registered string value defined in table 1.

Table 1 – UMID universal label

Byte No.	Description	Value (hex)	Meaning
1	Object identifier	06 _h	Universal label start
2	Label size	0A _h	12-byte Universal label
3	Designation: ISO	2B _h	ISO registered
4	Designation: SMPTE	34 _h	SMPTE registered
5	Registry category	01 _h	Dictionaries
6	Specific category	01 _h	Metadata dictionaries
7	Structure	01 _h	Dictionary standard (SMPTE 335M)
8	Version number	VV _h	Version of the metadata dictionary (defined in SMPTE RP 210)
9	Class	01 _h	Identifiers and locators
10	Subclass	01 _h	Globally unique identifiers
11	Material type	XX _h	See 5.1.1.1
12	Number creation method	YY _h	See 5.1.1.2

NOTE – SMPTE 298M defines SMPTE labels as having a length of 16 bytes. The 12-byte UMID universal label is still a valid and unique ISO object identifier as defined in SMPTE 298M. When the UMID universal label is used in isolation, the 12-byte UMID universal label can be converted to a SMPTE label by padding with 4 bytes of null fill and changing the value of the label size in byte 2 from '0A_h' to '0E_h'.

5.1.1.1 Material type identification

Byte 11 of the UL defines the material type being identified as shown in table 2.

Table 2 – Material type identification

Byte value	Meaning	Examples and notes
01 _h	picture material	Deprecated
02 _h	audio material	Deprecated
03 _h	data material	Deprecated
04 _h	other material	Deprecated (originally not only picture, audio, or data material, but may be a combination of material types)
05 _h	single picture component	e.g. Y component
06 _h	Two or more picture components in a single container	e.g. interleaved Y, Cb and Cr components
08 _h	single audio component	e.g. mono audio
09 _h	two or more audio components in a single container	e.g. AES3 audio pair
0B _h	single auxiliary (or data) component	e.g. sub-titles only
0C _h	two or more auxiliary (or data) components in a single container	e.g. multiple sub-titles streams in different languages
0D _h	mixed group of components in a single container	e.g. video & stereo audio pair
0F _h	material type is not identified	

NOTE – The use of material types '01_h', '02_h', '03_h' and '04_h' are deprecated for use in systems using this revised standard. These values are preserved only for compatibility with SMPTE 330M-2000.

5.1.1.2 Number creation method identification

Byte 12 of the UL identifies the methods by which the material and instance numbers are created. This byte is divided into top and bottom nibbles.

The top nibble occupies the 4 MSBs and the value shall be used to define the method of material number creation. The values used by this nibble shall be limited to the range 0 to 7h in order that byte 12 conforms to ASN.1 BER short form coding rules used by SMPTE 298M.

The bottom nibble occupies the 4 LSBs and the value shall be used to define the method of instance number creation. The values used by this nibble shall be limited to the range 0 to Fh.

The methods of material number generation are defined in table 3 and the specifications of the defined methods are given in annex A.

New material number generation methods may be added as a type 1 entity as defined in SMPTE 359M. Each addition shall provide the proposed value (within the range of values currently identified as “Reserved but not defined”) for inclusion in table 3 together with the supporting definition to be added to annex A.

Table 3 – Identification of material number generation method

Value (hex)	Method
0	No defined method
1	SMPTE method
2	UUID/UL method
3	Masked method
4	IEEE 1394 network method
5~7	Reserved but not defined

The methods of instance number generation are defined in table 4 and the specifications of the defined methods are given in annex B.

New instance number generation methods may be added as a type 1 entity as defined in SMPTE 359M. Each addition shall provide the proposed value (within the range of values currently identified as “Reserved but not defined”) for inclusion in table 4 together with the supporting definition to be added to Annex b.

Table 4 – Identification of instance number generation method

Value (hex)	Method
0	No defined method
1	Local registration
2	24-bit PRS generator
3	Copy number and 16-bit PRS generator
4 ~ E	Reserved but not defined
F	Live stream

