

IQSYN01

SDI Frame Synchronizer with Ancillary Data Passing



Table of Contents

Module Description	1	GPI.....	14
Rear Panel Views	1	RollTrack.....	16
Product Comparison	2	Memories	18
Block Diagram	3	Logging 1 and 2.....	19
Features	3	ROLLCALL LOG FIELDS	20
Technical Profile	4	Setup	21
INPUT CONNECTIONS	6	Operation from an Active Control Panel	23
Serial Digital Video Inputs	6	MAIN MENU	26
Analog Reference Input.....	6	Video.....	26
GPI I/O.....	7	Freeze.....	27
OUTPUTS	7	User Mem(ories).....	28
Serial Digital Video Outputs	7	Genlock.....	29
CARD EDGE INDICATORS	8	Setup.....	31
RollCall PC Control Panel Screens	9	ROLLCALL LOG FIELDS	39
Video	9	IQSYN01 RollCall Commands	42
ProcAmp.....	10	Appendix 1 The Firewall	56
Genlock	11	Appendix 2 HANC Control	58
VBI & HANC Blank(ing).....	12	Manual Revision Record	59
Caption & Pattern	13		

Module Description

The IQSYN01 is a SD-SDI video frame synchronizer with ancillary data passing capability. Suitable for SD lines-in its video firewall capability ensures a continuous video output even when the

input signal fails. A dual SDI input allows this synchronizer to take signals from either of two paths.

Rear Panel Views

IQSYN0101-1A

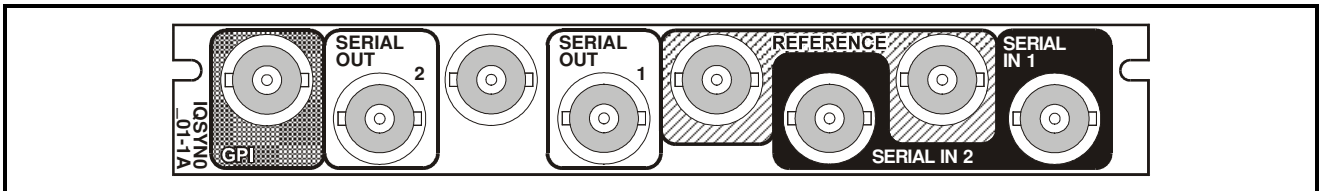

IQSYN0100-1

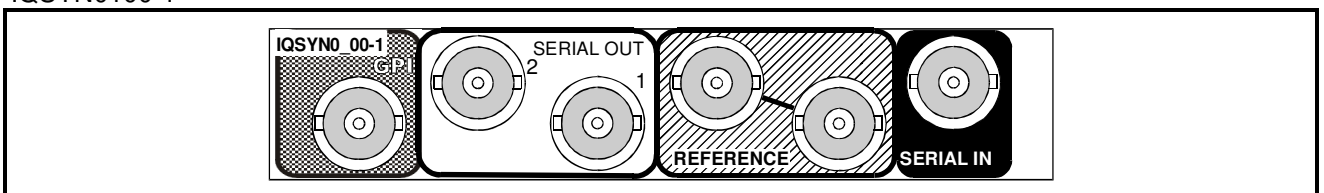

This manual covers the following products:

IQSYN0101-1A SDI frame synchronizer with ancillary data passing. 2 SDI inputs, 2 SDI outputs, analog reference loop-through

IQSYN0100-1 SDI frame synchronizer with ancillary data passing. 1 SDI input, 2 SDI outputs, analog reference loop-through

Product Comparison

Product	SDI Inputs	SDI Outputs	GPI	Genlock	Width & Style
IQSYN0101-1A	2	2	1	Loop-through	Single A
IQ SYN0100-1	1	2	1	Loop-through	Single 0

Note that there are two styles of rear panels available. They are not interchangeable between the two styles of enclosures. However, the cards may be fitted into any style of enclosure.

'A' Style Enclosure

Rear panels **with** the suffix A may only be fitted into the 'A' style enclosure shown below.

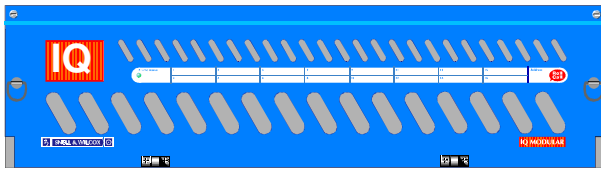

(Enclosure order codes IQH3A-E-0, IQH3A-E-P, IQH3A-0-0, IQH3A-0-P)

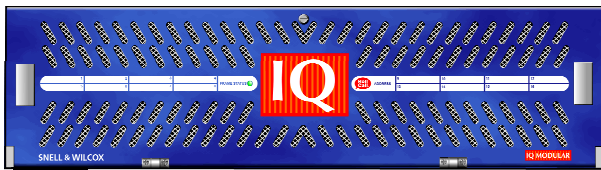

(Enclosure order codes IQH3A-S-0, IQH3A-S-P)

'O' Style Enclosures

Rear panels **without** the suffix A may only be fitted into the '0' style enclosures shown below.

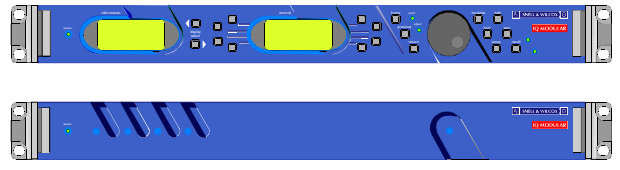

(Enclosure order codes IQH1S-RC-0, IQH1S-RC-AP, IQH1U-RC-0, IQH1U-RC-AP, Kudos Plus Products)

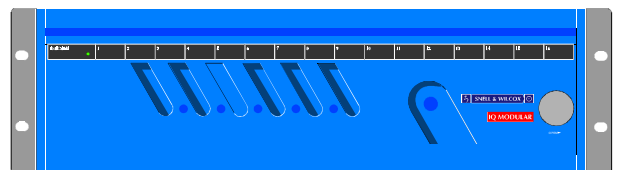

(Enclosure order codes IQH3N-0, IQH3N-P)



(Enclosure order codes IQH3U-RC-0, IQH3U-RC-P)

Block Diagram

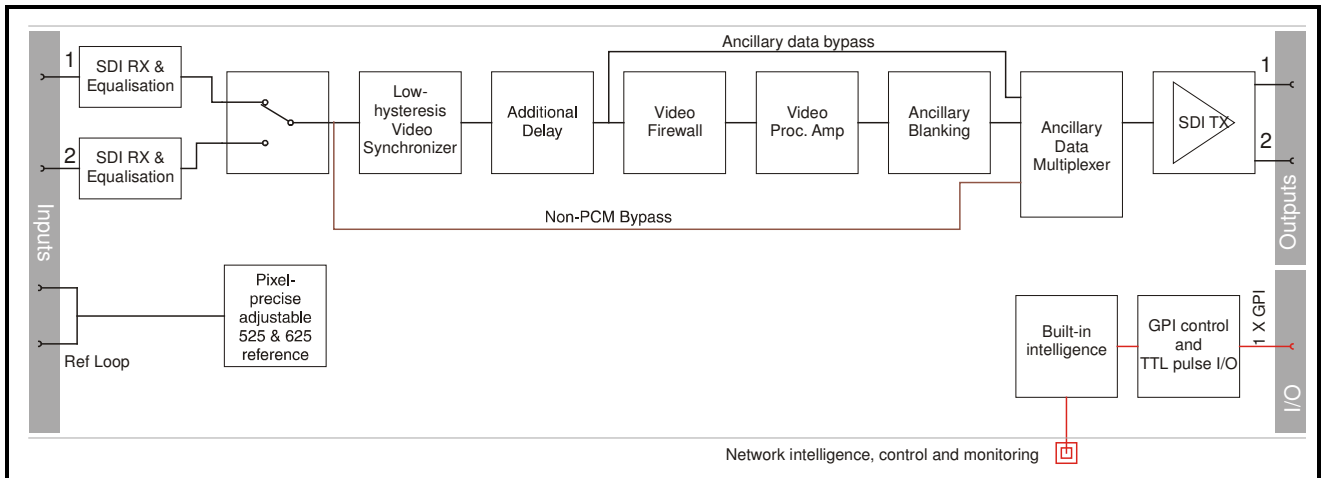

Features

- SDI frame synchronizer with ancillary data passing
- With a minimum delay of $<6 \mu\text{s}$ the IQSYN01 is also useful in typical line synchronizer applications where it is necessary to delay a synchronous input up to a few lines
- Router switching tolerant in accordance with SMPTE RP168, but additionally with 625 line inputs it allows the seamless switching anywhere in the vertical interval of sources up to 23 lines apart
- Firewall for video to provide a continuous output
- Video proc-amp (gain, saturation, black level)
- Up to 3 frames of video delay in delay mode
- Pass or blank horizontal ancillary data
- RollCall control and monitoring compatible

For more information about Firewall behavior please consult the appendix at the end of this manual.

Technical Profile

Signal Inputs

Digital VideoUp to 2 x SDI (BNC)
 Standards.....SMPTE 259M-C-1997, SMPTE
 272M-A-1994
 Video referenceComposite video (BNC)

Signal Outputs

Digital VideoSDI x 2
 Standards.....SMPTE 259M-C-1997, SMPTE
 272M-A-1994

Control Interface

GPI 1x Closing contact I/O interface

Card Edge Controls

NONE

Card Edge Indicators

SDI Input Loss.....Loss = Off, Good = Green
 SDI Input Error.....Yellow (Unused input not at current
 operating standard)
 Reference Loss
 CPU running / Power.....One green LED, flashing = OK

RollCall Functions

Video Controls

Select primary input.....1/2
 Black Level.....± 100 mV in 0.8 mV steps
 Y/C Timing± 592 ns in 148 ns steps
 Picture position± 592 ns in 148 ns steps
 Luminance Gain± 6 dB
 Chrominance Gain.....± 6 dB
 Genlock ModeFree-run / Genlock / Primary SDI
 (delay mode)
 Genlock H Phase.....± 32 µs in 37 ns steps
 Genlock V Phase.....± 262/312 lines in 1 line steps
 Video Horizontal Delay+1 Line in 37 ns steps
 Video Vertical Delay+1 Frame in 1 line steps
 Video Delay Frames0 to +2 frames

Other Controls

Pass vertical dataOn / Off (lines selectable 7/11 to
 23/21 & 320/274 to 335/283)
 Preset Unit.....Returns all settings to default

Pattern Select Animated Pattern
 Black
 EBU Color Bars
 100% Color Bars
 Ramp
 Multiburst
 Pulse & Bar
 User Memories Name, clear, save and read 8 user
 memories
 Default Video Output pattern / freeze/ run through
 Caption Output On / Off
 Caption Generator Programmable up to 19 characters
 GPI/O set-up..... May be attached to any memory
 function / polarity

Reporting * also Logged

EDH (for selected input).... *EDH Error / *Error-Time / *EDH
 Error-Seconds
 No SDI..... *No input present
 No reference..... *No reference present
 Reference error..... Standard different to selected input
 Input error..... Unused input not at current
 operating standard

RollTrack Output

Delay Current video delay
 Reference state Ref Lost, Ref Present, Ref error
 [error: different standard to input –
 input has precedence
 Input state..... Present, Input Missing, Standard
 525, Standard 625
 Input 1: Input Present, Input
 Missing, Standard 525, Standard
 625
 Input 2: Input Present, Input
 Missing, Standard 525, Standard
 625
 GPI 1 Low, High, Inactive

Specifications

Video Internal Processing4:2:2 with 10 bit data paths
Serial Input Return LossBetter than 15 dB to 270 MHz
Maximum Input Cable length
 > 200 m (PSF1/2 or equiv. cable)
Serial Output Level800 mV \pm 5%
Output Overshoot< 70 mV
Output Return LossBetter than -15 dB to 270 MHz
Output Jitter< 0.2 UI (with 10 Hz High pass filter
 selected on 601 monitor)
Reference Return LossBetter than -35 dB to 5.8 MHz
Reference Input Level1 Vp-p \pm 3 dB
Minimum Delay6 μ s
Synchronize Hysteresis Window
 0.5 - 1 μ s
Delay (Synchronize Mode)Sync delay + 0, 1 or 2 Frames
Delay (Delay Mode)6 μ s - 3 Frames + 5.5 μ s

Power Consumption

Module Power Consumption
7.46 W max

INPUT CONNECTIONS

Serial Digital Video Inputs

Serial digital inputs are made to the unit via BNC connectors which terminate in 75 Ohms.

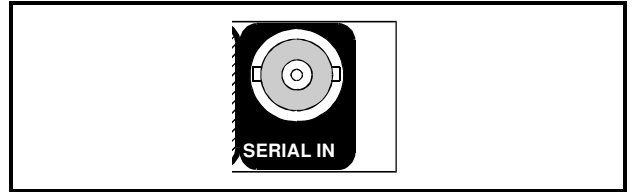
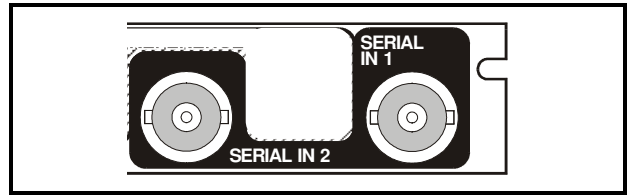

Analog Reference Input

The analog reference input to the unit is made via the passive loop-through BNC connectors for 75 Ohms.

The external sync signal must be the same line standard as the SDI input.

Note that if the loop-through facility is not used the unused BNC socket must be fitted with a 75 Ohm terminator or the Reference Input Termination link on the card set to the 75 ohm position.

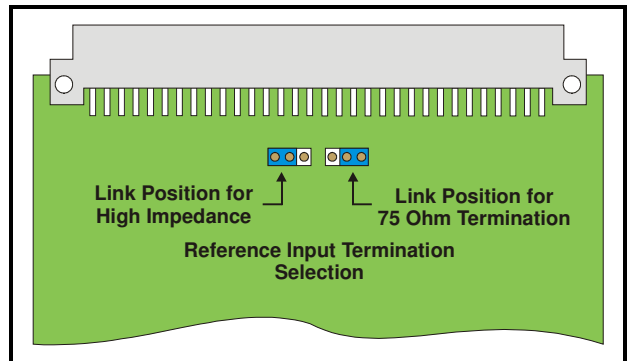
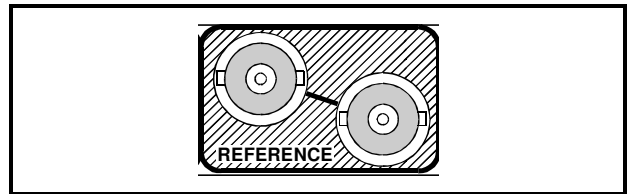
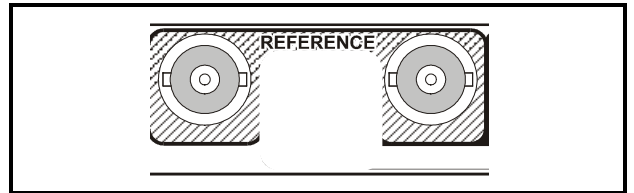

GPI I/O

This connector is used for accepting GPI information (from mechanical switch contacts, relay contacts etc.) The resulting action that the unit takes may be programmed via RollCall.

It may also be configured as an output.



OUTPUTS

Serial Digital Video Outputs

These are the Serial Digital outputs of the unit via BNC connectors for 75 Ohms.

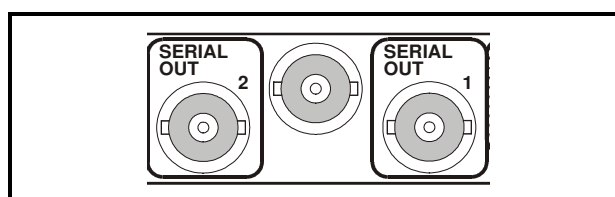
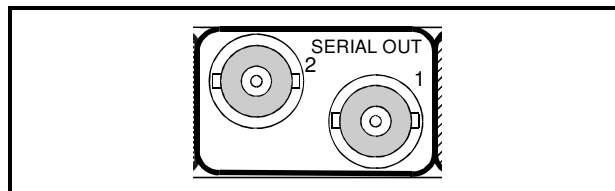

CARD EDGE INDICATORS

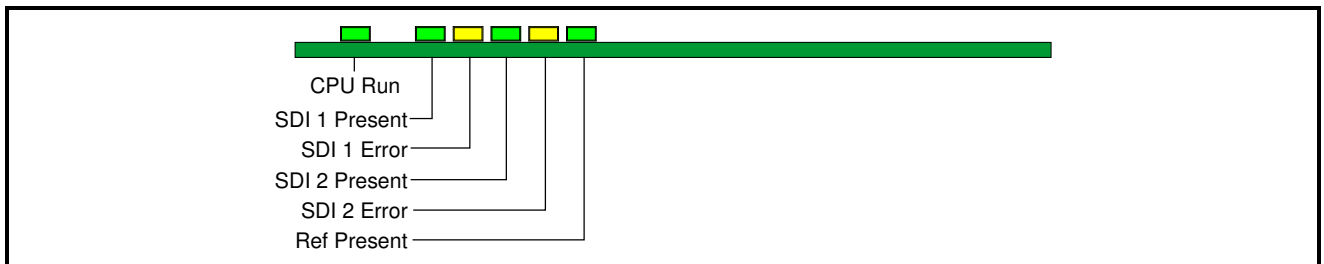
**CPU Run (Green)**

This LED will flash to indicate that the CPU is running.

SDI 1 Present (Green)

When illuminated this indicates that there is a valid signal at SDI 1 input.

SDI 1 Error (Yellow)

When illuminated this indicates that SDI 1 input is not at the current operating standard.

SDI 2 Present (Green)

When illuminated this indicates that there is a valid signal at SDI 2 input.

SDI 2 Error (Yellow)

When illuminated this indicates that SDI 2 input is not at the current operating standard.

Ref Present (Green)

When illuminated this will indicate that a valid reference signal is present.

RollCall PC Control Panel Screens

Video

Input Select

This allows either **Input 1** or **Input 2** to be selected for processing.

Note that as the IQSYN0100-has only one input, Input 1 should always be selected. If Input 2 is selected the unit will report an input loss.

Input Standard

This allows **input standard** to be selected.

If only 625 is selected the unit will be forced to only accept 625 line inputs.

If only 525 is selected the unit will be forced to only accept 525 line inputs.

If 625 and 525 are selected the unit will accept both 625 and 525 line inputs.

Freeze

When checked the output picture will become a frozen frame.

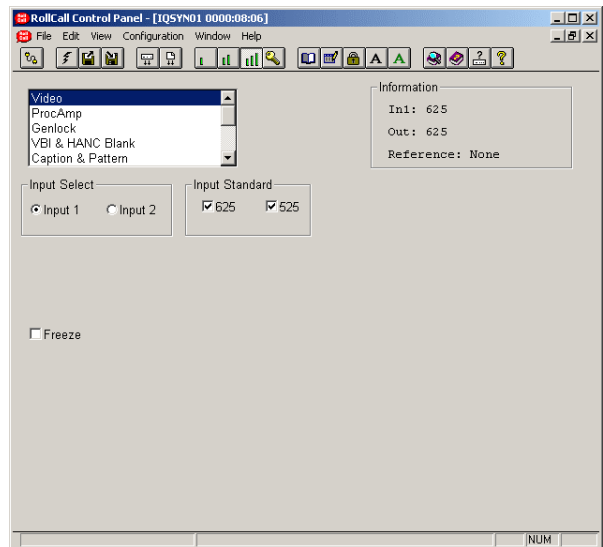



ProcAmp

These items allow signal levels and timings to be adjusted.

Separate adjustments may be made for the two input channels **Input 1 SDI** and **Input 2 SDI**.

Note that as the IQSYN0100-1 has only one input, Input 1 functions should be used.

Note that for this and other screens the following applies to the scroll bars:

The  and  symbols at the ends of the scroll bar allow the value to be adjusted in discrete steps.

The numerical value will be shown above the scroll bars and selecting Preset  will return the setting to the calibrated value for that item.

Input 1 SDI and Input 2 SDI Controls

These items allow the gain, black level and timing of both signals to be adjusted.

ProcAmp Enable

When checked the ProcAmp will become enabled for that channel and the settings will be applied to the signal.

When unchecked the settings will revert to the preset values.

Luma Gain

This allows the Y (luminance) gain to be adjusted by ± 6 dB in steps of 0.1 dB. Preset value is 0.0 dB.

Black Level

This allows the black level to be adjusted by ± 100 mV in 0.8 mV steps. Preset value is 0.

C Gain

This allows the Cb/Cr (color difference) gain to be adjusted by ± 6 dB in steps of 0.1 dB. Preset value is 0.0 dB.

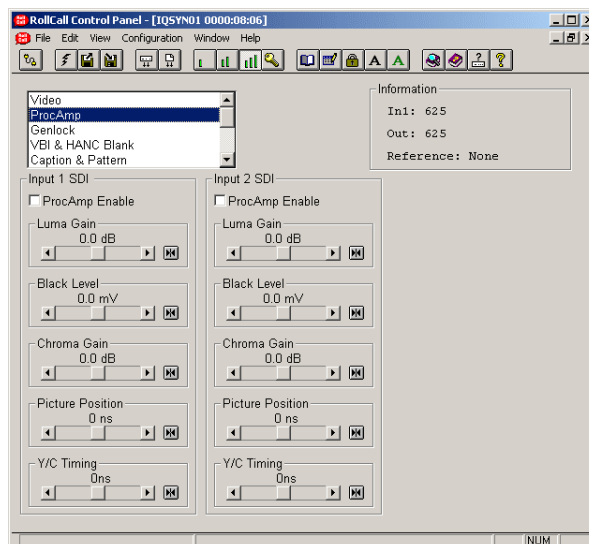

Picture Position

This item allows the timing of the picture position relative to the normal value, to be adjusted.

The timing may be adjusted by ± 592 ns in 148 ns steps.

Y/C Timing

This item allows the timing of the chrominance signal relative to the luminance signal to be adjusted, (i.e. Y to Cb/Cr timing) in nanoseconds. The timing may be adjusted by ± 592 ns in 148 ns steps.

Genlock

This allows the genlock and delay options to be selected.

Lock to Reference

When selected the unit will lock to the external reference signal.

Free Run

When selected the unit will not be locked to any input signals and the unit will free run.

Lock to Input

When selected the unit will lock to the input video signal.

H(orizontal) Phase (625/525)

This item allows the horizontal timing of the output signal relative to the reference sync signal to be adjusted using the scrollbar by $\pm \frac{1}{2}$ line in 37 ns steps.

Note that picture disturbance may occur while this setting is adjusted.

Selecting Preset returns the setting to zero. (Output coincident with reference)

V(ertical) Phase (625/525)

This item allows the vertical timing of the output signal relative to the reference sync signal to be adjusted, in TV lines. The scrollbar will adjust this value. Range is ± 262 lines (525 standard) or ± 312 lines (625 standard) in 1 line steps.

Note that picture disturbance may occur while this setting is adjusted.

Selecting Preset returns the setting to zero. (Output coincident with reference)

Freerun Freq(ueency)

This allows the freerun frequency of the internal sync generator to be adjusted in steps of arbitrary units. Preset is to 0.

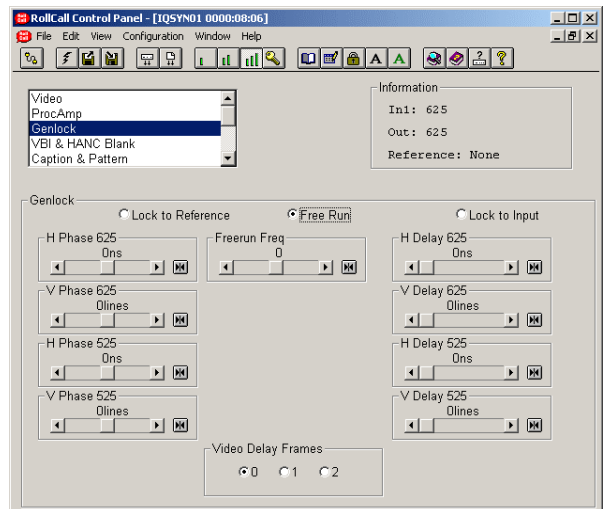

Delay (625/525)

When these controls are used the output signal will appear after the input signal with a time delay. When not used the module will operate in the synchronize mode.

*Note that the H and V delay functions are only active when the **Lock to Input** mode is selected.*

H(orizontal) Delay (625/525)

This item allows the horizontal timing of the output signal relative to the input signal to be adjusted by up to 1 line in 37 ns steps. The scrollbar will adjust this value.

Selecting Preset returns the setting to the minimum horizontal delay.

V(ertical) Delay

This item allows the vertical timing of the output signal relative to the input signal to be adjusted, in TV lines. The scrollbar will adjust this value. Range is from 0 to 624 or 524 lines in 1 line steps.

Selecting Preset returns the setting to the minimum vertical delay.

Video Delay Frames

The number of frames that the output signal will appear after the input signal may be set with this item.

Note that this function is available in any genlock mode and will add to any other delay settings.

VBI & HANC Blank(ing)

This item allows the Vertical Interval data (all or specific lines) contained in the input signal to be blanked or passed through the module.

It allows the selection of which vertical interval lines to pass through to the output and which lines to blank.

525 Pass

This section allows lines 11 to 21 and lines 274 to 283 of 525 line signals to be selected and passed through to the output by checking the appropriate box.

625 Pass

This section allows lines 7 to 23 and lines 320 to 335 of 625 line signals to be selected and passed through to the output by checking the appropriate box.

All

This section allows all vertical interval lines to be selected and either passed to or blanked from the output signal.

Pass 525

Selecting this item will select all vertical interval lines in the 525 line list and allow them to passed through to the output.

Pass 625

Selecting this item will select all vertical interval lines in the 625 line list and allow them to passed through to the output.

Blank 525

Selecting this item will select all vertical interval lines in the 525 line list and blank them from the output.

Blank 625

Selecting this item will select all vertical interval lines in the 625 line list and blank them from the output.

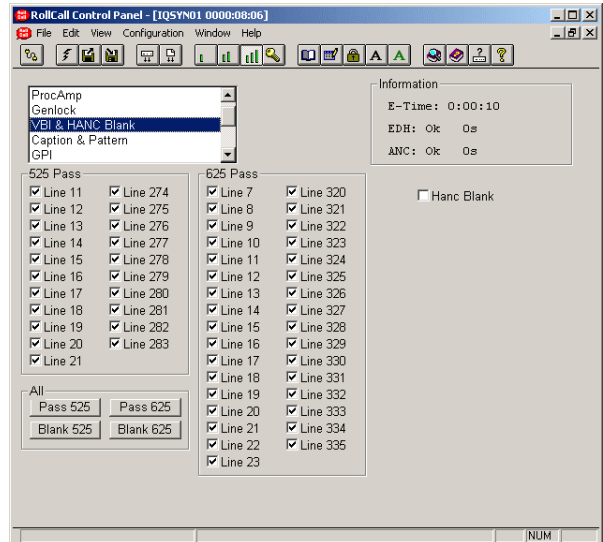

Hanc Blank

When checked all horizontal data will be blanked, on the input. When unselected, passthrough operations will not alter audio packets.

For details of the HANC Data Handling please refer to Appendix 2 on page 58.

Caption & Pattern

This function will allow a caption to be edited and selected and various patterns to be used as the output signal when the Pattern On function is selected.

Caption

This function allows control of the caption (white text on a black background) which may contain a maximum of 19 characters (including spaces).

The caption will appear in the lower section of the picture.

Edit caption

To change the caption, type the new text in the text area and then select  (return).

Selecting Preset  will return the text to the default text (IQSYN01).

Select Caption

- Caption Off The caption will not appear on the screen
- Caption On The caption will appear on screen

Pattern

- Pattern On

When selected the output will become the pattern selected from the **Pattern Select** list.

Pattern Select

One of the patterns (including Black) may be selected from the list.

- Animated Pattern**

When selected, a monochrome rectangular area will appear on the output picture as shown opposite. The brightness of this rectangle will ramp from black, through gray to white and then directly to black over a period of about one second. This action will then be repeated continuously.

This pattern is useful for checking active video paths. Down stream equipment can see that video has not been frozen.

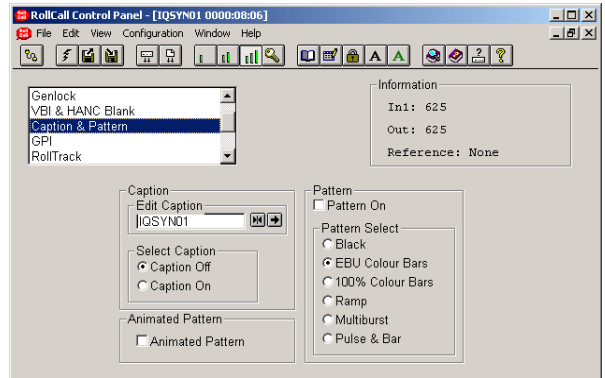

Caption Text

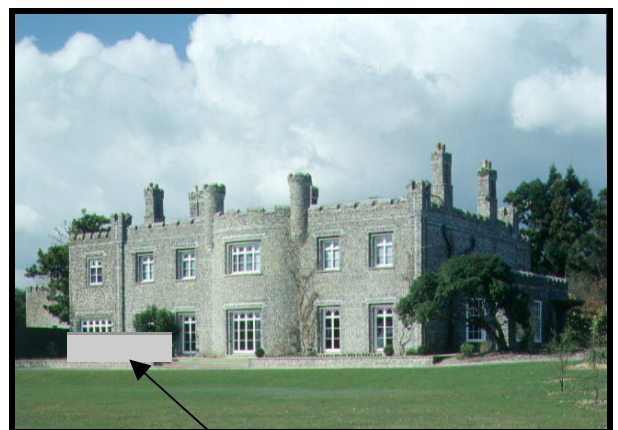

Animated Pattern

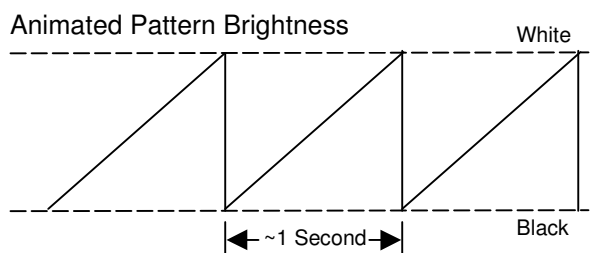

GPI

This screen allows the GPI functions to be configured and their actions defined.

Disable Inputs

When selected all GPI input functions will be disabled.

Input Functions

When configured as an input the GPI connection may be used for accepting GPI information (from mechanical switch contacts, relay contacts etc.) The resulting action that the unit takes may be selected using this item.

The GPI input functions that may be selected are as follows:

- | | |
|------------------|--|
| Unused | The unit will perform no function. This is also the Preset Setting. |
| Pattern | The unit will produce a pattern chosen from the Pattern menu when the input changes from open to closed. |
| Memory
1 to 8 | The unit will use the settings in the selected memory location when the input changes from open to closed. |
| Mem1-2 | The unit will toggle between the settings of memory locations 1 and 2.
Open to Closed = Memory 1 settings
Closed to Open = Memory 2 settings |
| Mem 3-4 | The unit will toggle between the settings of memory locations 3 and 4.
Open to Closed = Memory 3 settings
Closed to Open = Memory 4 settings |
| Mem 5-6 | The unit will toggle between the settings of memory locations 5 and 6.
Open to Closed = Memory 5 settings
Closed to Open = Memory 6 settings |
| Mem 7-8 | The unit will toggle between the settings of memory locations 7 and 8.
Open to Closed = Memory 7 settings
Closed to Open = Memory 8 settings |

GPI In Status

This will display the current status of the selected GPI input.

This may show either High or Low. When low, the associated function will be triggered.

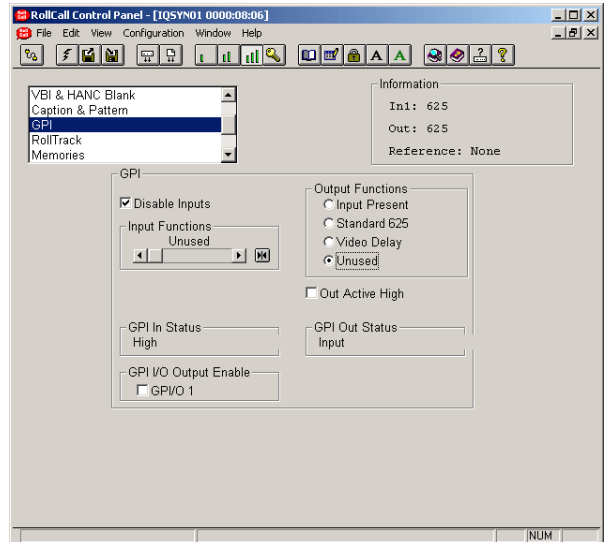

GPI (continued)

Output Functions

The GPO may be configured to produce an output corresponding to one of the following conditions:

- Input Present
- Standard 625
- Video Delay
- Unused

The preset setting for the output is to Unused.

When the condition is not true the output will float but when the condition is true the output is closed to ground via a transistor.

Note that when video delay mode is selected the output is a negative going TTL pulse. The width of the pulse represents the video delay through the unit to the nearest millisecond.

GPI Out Status

This will display the current status of the GPI output. This may show either Unused, High, low or video delay in milliseconds.

Out Active High

This determines the sense of the asserted GPI output signal. When checked the GPI is active the output sense is high. When unchecked the GPI is active low.

GPI I/O Output Enable

When checked the GPI is configured as an output. When unchecked the GPI is configured as input.

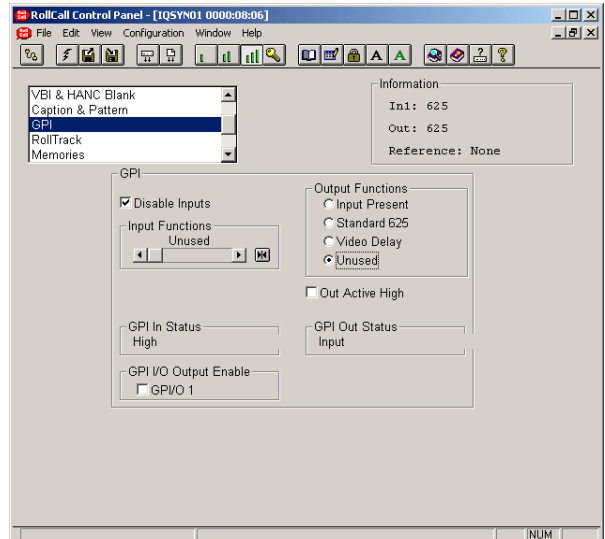

RollTrack

This function allows information to be sent, via the RollCall™ network, to other compatible units connected on the same network.

For example, it can enable compatible audio delay units to produce an audio delay dependent on this and other similar units. The audio delay unit will dynamically follow or track the received delay-time information. This allows processed video signals to be timed correctly with audio signals. This automatic tracking system via the RollCall™ network is called **RollTrack**.

For more detailed information, see the RollTrack section (Appendix) at the end of this manual.

RollTrack Index

This item allows up to 50 destinations to be selected.

RollTrack Source

This allows the source of information that triggers the transmission of data to be selected.

Unused (off)
Input Present
Input Missing
Standard 525
Standard 625
Input 1 Present
Input 1 Missing
Standard 1 525
Standard 1 625
Input 2 Present
Input 2 Missing
Standard 2 525
Standard 2 625
Video Delay
Reference Lost
Reference Present
Reference Error
GPI 1 Low
GPI 1 High
GPI 1 Inactive

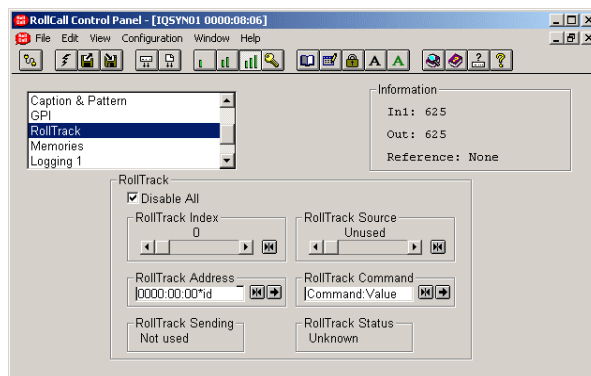

The destination for the information is set by the network code address as follows:

Network Address

This item allows the address of the selected destination unit to be set.

To change the address, type the new destination in the text area and then select  (return)



(Preset) returns to the default destination

The full **RollTrack** address has four sets of numbers

For example: 0000:10:01*99

The first set (0000) is the network segment code number

The second set (10) is the number identifying the (enclosure/mainframe) unit.

The third set (01) is the slot number in the unit

The Fourth Set (99)

Each RollCall unit has a unique identification embedded in the units' software. In this example 99 represents an IQBAXR, 142 would represent an IQDAMDD, 255 a TBS100D etc. Inserting this number in the RollTrack address ensures that only the correct type of unit (in this example an IQBAXR) will respond to the RollTrack command; any other unit will ignore the command.

If this number was set to 00 **any type** of unit at this location would respond to the RollTrack command, possibly causing unpredictable results.

RollTrack (continued)

RollTrack Command

The full **RollTrack** command has two sets of numbers

For example: 84*156

The first set (84) is the **RollTrack** command number

The second set (156) is the value sent with the **RollTrack** command number

*Note that when video delay is selected as the **RollTrack** source the value sent with the **RollTrack** command is the video delay value not the value set.*

For details of the RollCall command values for specific units please contact your local Snell & Wilcox agent.

Disable All

When this item is checked all RollTrack items will be disabled.

RollTrack Sending

This item shows when the unit is actively sending the RollTrack command.

This may show:

String	A string value is always being sent.
Number	A number value is always being sent.
No	The message is not being sent.
Yes	The message is being sent.
Internal Type Error	Inconsistent behavior; please contact your local Snell & Wilcox agent.

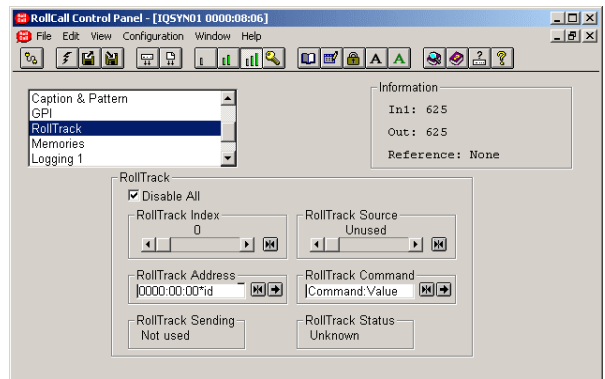

RollTrack Status

This item will show the status of the currently selected RollTrack index.

This may show:

OK	RollTrack message sent and received OK.
Unknown	Rolltrack message has been sent but it has not yet completed.
Timeout	RollTrack message sent but acknowledgement not received. This could be because the destination unit is not at the location specified.
Error	This indicates a broken RollCall state.
Bad	This indicates a broken RollCall packet.

Memories

This function allows a number of particular setups of the unit to be saved and recalled. There are 8 memory locations available.

To change the memory name, type the new name in the text area and then select  (return).

Selecting Preset  will return the text to the default name.



This item allows the memory location to be cleared and returned to the default (preset) setting. This empties the memory location and the Recall button will then appear grayed out.



This function allows the settings of all items to be saved at the memory location.



This function allows the settings saved at the memory location to be recalled. When this button appears grayed out it indicates that the memory location is empty and therefore cannot be recalled. This will occur when the memory is cleared.

Note that all the above functions are a momentary action.

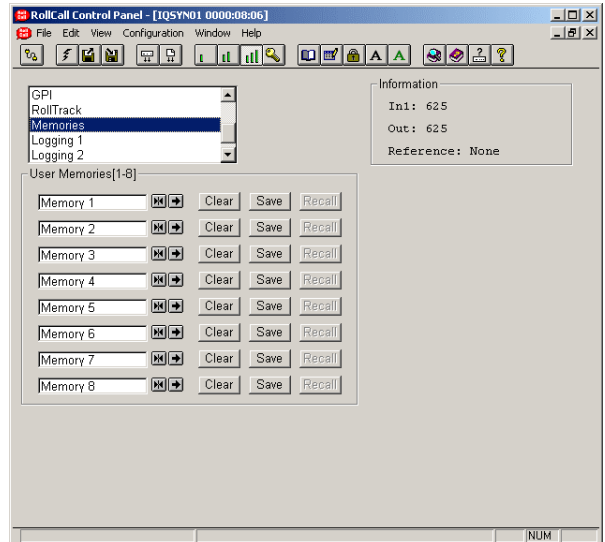

Logging 1 and 2

Information about various parameters can be made available to a logging device that is attached to the RollCall™ network by checking the appropriate box.

The status is shown to the right of the item.

Any of the items may be selected from the list.

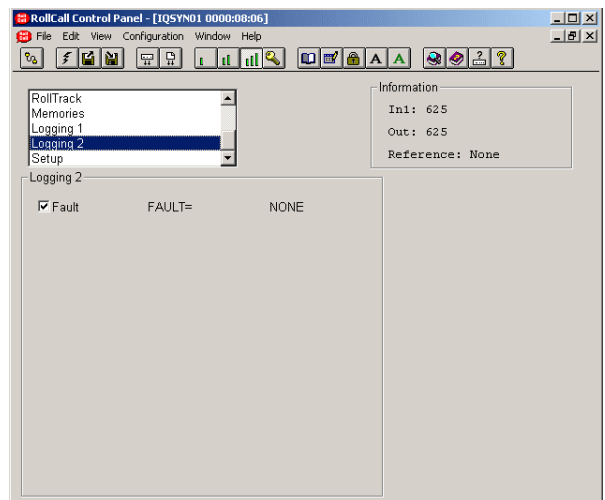
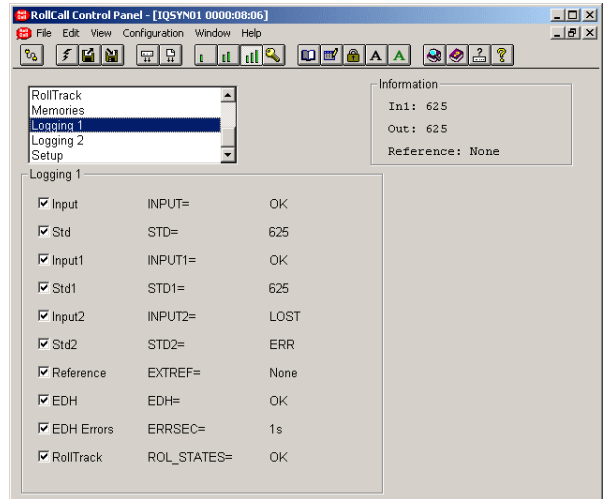

ROLLCALL LOG FIELDS

Log Field	Log Value	Description
INPUT=	OK ERR* LOST	Valid input signal Invalid input signal Input signal lost
STD=	UNKNOWN* STDERR 525 625	Input signal standard not recognized or no signal Not a selected input standard Input standard 525 Input standard 625
INPUT1=	OK ERR* LOST	Valid input signal Invalid input signal Input signal lost
STD1=	ERR 525 625	Not a selected input standard Input standard 525 Input standard 625
INPUT2=	OK ERR* LOST	Valid input signal Invalid input signal Input signal lost
STD2=	ERR 525 625	Not a selected input standard Input standard 525 Input standard 625
EXTREF=	NONE 525 ERROR WARNING 625	No reference signal present Valid 525 reference signal Reference/Output standard mismatch Reference signal available but not selected Valid 625 reference signal
EDH=	NONE FAIL OK RESET	The unit is not locked to the input signal EDH errors have been found on the input signal No EDH errors found on the input signal EDH statistics have been reset
ERRSEC=	Runtime string	The time since EDH was reset in seconds
ROL_STATES=	OK FAIL	RollTrack message sent and received OK RollTrack message not acknowledged
FAULT=	NONE FAIL	No Internal errors detected Internal error detected
SN=	Runtime string	Serial number of unit

Setup

Information Window

The type of information that appears in the Information Window may be chosen with this item.

- Input Status
- EDH & ANC Status

Input Status

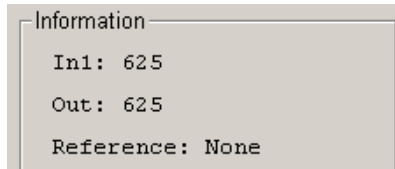

In1: or In2: This shows the status of the input, the line standard and which input has been selected.

Out: This shows the status of the output.

Reference: This will show the status of the reference signal.

EDH & ANC Status

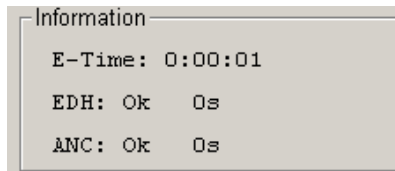

E-Time: This shows the time since EDH was reset in Hours:Minutes:Seconds.

EDH: This shows the number of EDH errors that have occurred since the last EDH reset followed by the time in seconds since the last EDH error.

ANC: This shows the number of ANC errors that have occurred since the last ANC reset followed by the time in seconds since the last ANC error.



Selecting this function will reset EDH and ANC error count and the timer shown in the information window, to zero. If inputs are switched over an automatic reset occurs.

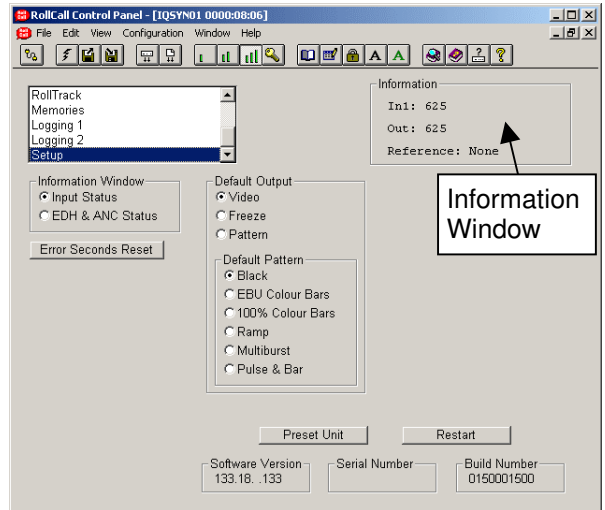

Setup (continued)

Default Output

If the input signal fails or is of poor quality this function will determine what the output signal will become under such conditions.

Default Pattern

If Pattern is chosen in the **Default Output** item the output will become the pattern chosen from this list.

Preset Unit

Selecting this item sets all adjustment functions that include a preset facility, to their preset values.

Note that this is a momentary action.

Restart

This will reboot the unit simulating a power-down power-up cycle restoring power-up settings.

Software version

This item shows the version of the software fitted in the module.

Serial Number

This item shows the serial number of the module

Build Number

This will indicate the factory build number. This number defines all parameters of the unit (software versions, build level etc.) for identification purposes.

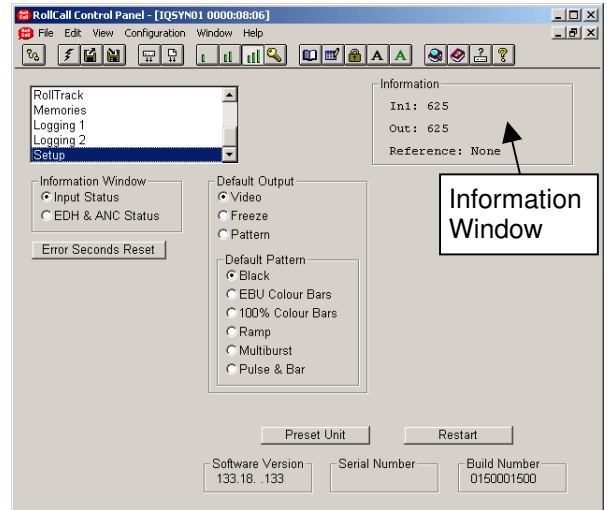

Operation from an Active Control Panel

The card may be operated from an active control panel via the RollCall™ network.

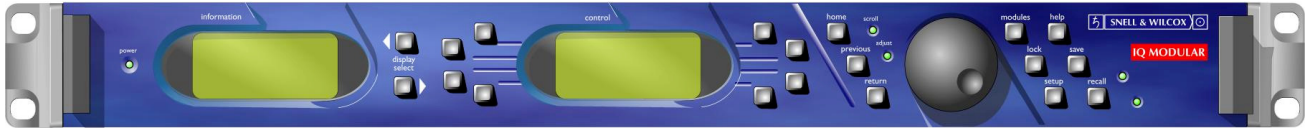

All operational parameters and selections are made using a system of menus displayed in two LCD windows.

Operational details for the remote control panel can be found in the Modular System Operator's Manual.

Information Window

The Information window has four lines of text indicating the current state of the unit.

For details of the abbreviations used please see page 21.

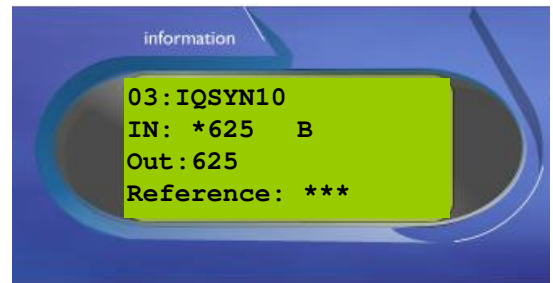

Control Window

The Control window displays all Selection Menus and sub-menus.

The selection is made by pressing the button adjacent to the required item.

The menu structure is detailed in the following pages.

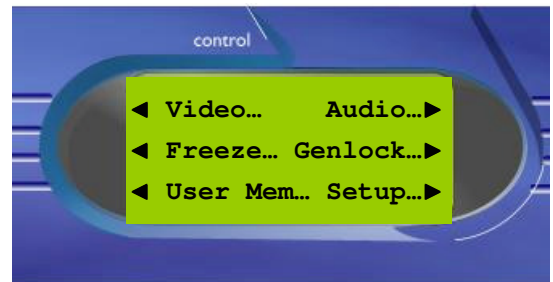

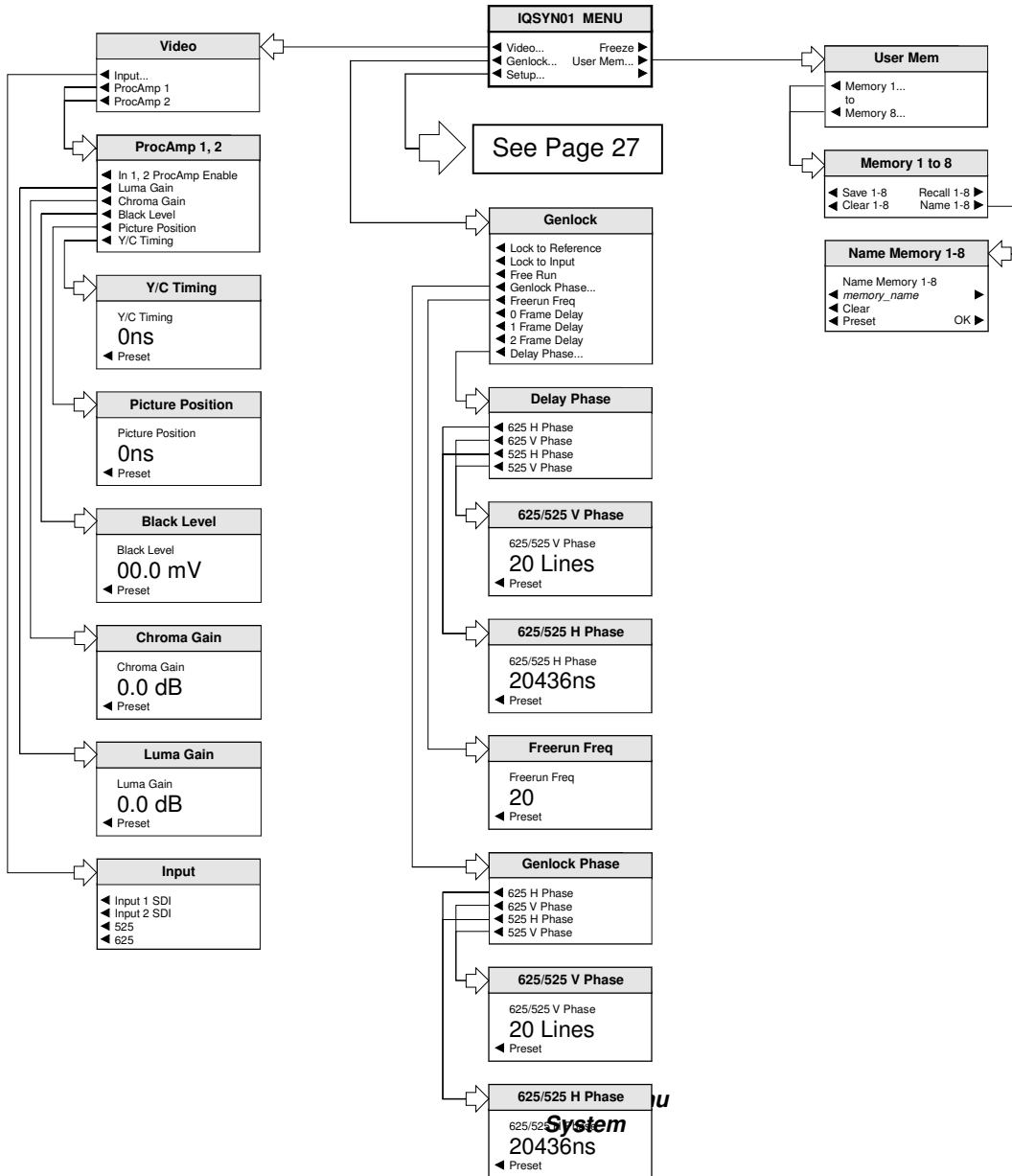

IQSYN01 Menu System

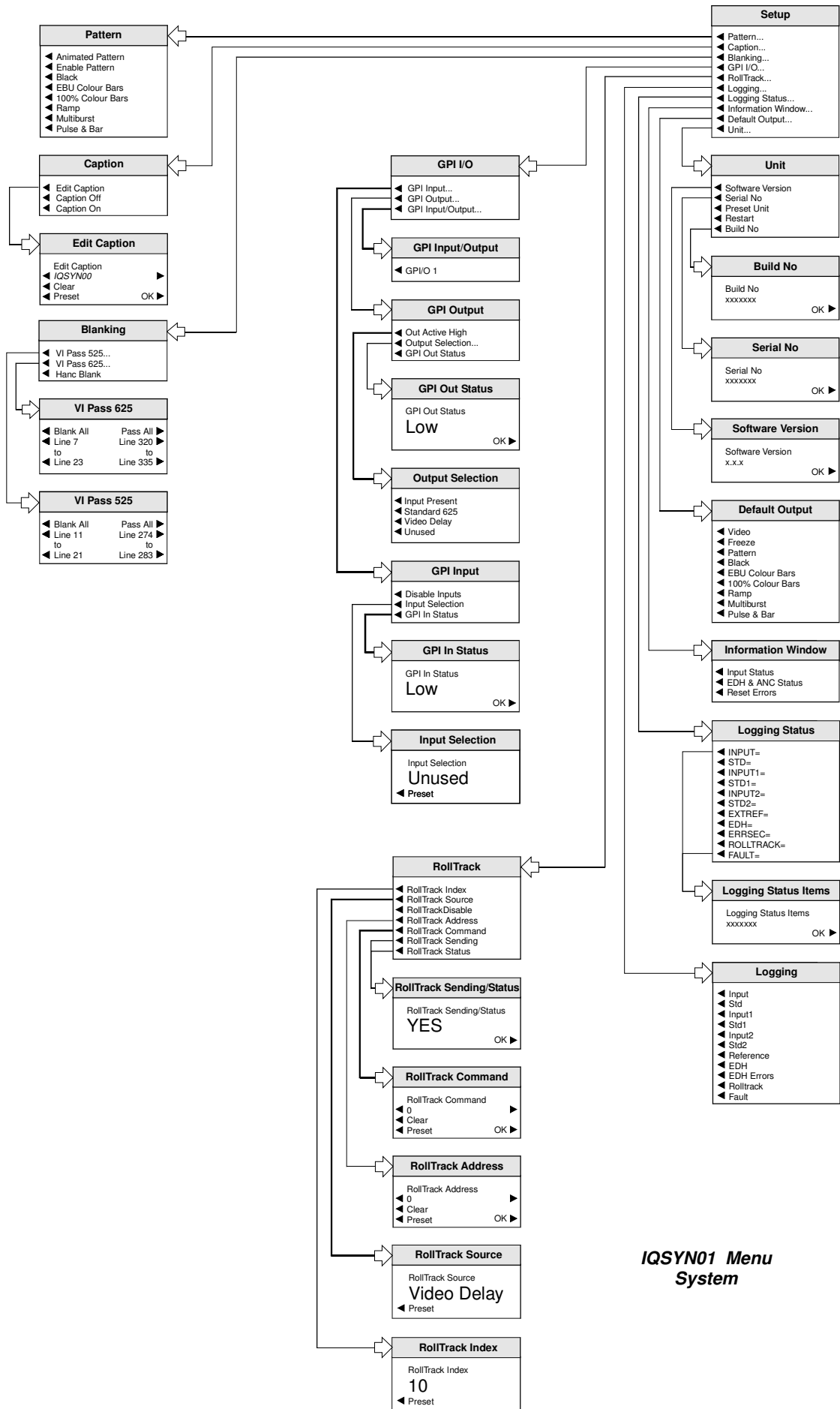

IQSYN01 Menu System

MENU DETAILS

(see IQSYN01 Menu System on previous pages)

MAIN MENU

The main or top level menu allows various sub-menus to be selected by pressing the button adjacent to the required text line.

Note that where a menu item is followed by three dots (...) this indicates that a further sub-menu may be selected.

Whenever a menu item is selected the parameters of that selection will be displayed in the Information window of the front panel. Where the selection is purely a mode selection and does not enable a sub-menu, the text will become reversed (white-on-black) indicating that the mode is active. If the mode is not available for selection the text will remain normal.

Also refer to the block diagram on page 3 for more information.

MAIN MENU

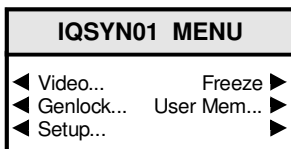

Video

This item allows the input signal to be selected and adjustments to be made.

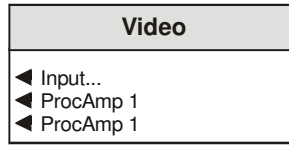

Input

This item allows the input signal and its standard to be selected.

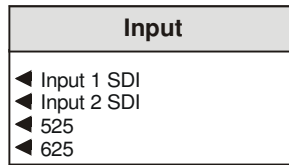

Input 1 SDI, Input 2 SDI

This item allows the input signal to be selected; either Input 1 SDI, Input 2 SDI or may be selected.

Note that as the IQSYN0100-has only one input, Input 1 should always be selected. If Input 2 is selected the unit will report an input loss.

525, 625

This allows input standard to be selected.

If only 625 is selected the unit will be forced to only accept 625 line inputs.

If only 525 is selected the unit will be forced to only accept 525 line inputs.

If 625 and 525 are selected the unit will accept both 625 and 525 line inputs.

ProcAmp 1, ProcAmp 2

These items allow signal levels and timings for each of the input channels to be adjusted.

ProcAmp 1, 2
<ul style="list-style-type: none"> ◀ In 1, 2 ProcAmp Enable ◀ Luma Gain ◀ Chroma Gain ◀ Black Level ◀ Picture Position ◀ Y/C Timing

In 1, 2, ProcAmp Enable

When selected the ProcAmp will become enabled for that channel and the settings will be applied to the signal.

When unselected the settings will revert to the preset values.

All the values below may be adjusted using the spinwheel.

Luma Gain

Luma Gain
Luma Gain 0.0 dB ◀ Preset

This allows the Y (luminance) gain to be adjusted by ± 6 dB in steps of 0.1 dB. Preset value is 0.0 dB.

Chroma Gain

Chroma Gain
Chroma Gain 0.0 dB ◀ Preset

This allows the Cb/Cr (color difference) gain to be adjusted by ± 6 dB in steps of 0.1 dB. Preset value is 0.0 dB.

Black Level

Black Level
Black Level 00.0 mV ◀ Preset

This allows the black level to be adjusted by ± 100 mV in 0.8 mV steps. Preset value is 0.

Picture Position

Picture Position
Picture Position 0ns ◀ Preset

This item allows the timing of the picture position relative to the normal value, to be adjusted.

The timing may be adjusted by ± 592 ns in 148 ns steps.

Y/C Timing

Y/C Timing
Y/C Timing 0ns ◀ Preset

This item allows the timing of the chrominance signal relative to the luminance signal to be adjusted, (i.e. Y to Cb/Cr timing) in nanoseconds. The timing may be adjusted by ± 592 ns in 148 ns steps.

Freeze

When selected the output picture will become a frozen frame.

User Mem(ories)

This function allows a number of particular setups of the IQSYN01 to be saved and recalled. There are 8 memory locations available.

This item allows any of the 8 memory locations to be selected.

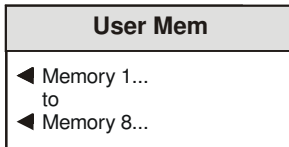

Memory 1 to 8

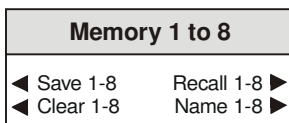

When a memory location has been selected this item allows it to be saved, recalled, cleared or renamed.

Save 1-8

When selected the current settings will be saved at this location.

Recall 1-8 ►

When selected the settings will be recalled from this location and applied to the unit.

Clear 1-8

When selected the memory location will be cleared and returned to the default (preset) setting.

Name 1-8 ►

The selected memory location may be renamed with this function.

To compile/edit the text the right ► and left◀ buttons adjacent to the upper text line in the menu should be used to select the character position in the text and the spinwheel used to select the character.

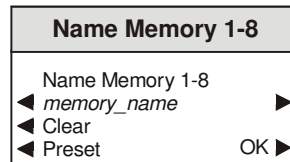

The **Clear** function blanks the selected character.

The **Preset** function loads the default text, for example, **Memory 1**.

O.K. ► saves the memory name text and returns to the main menu.

Genlock...

This allows the genlock and delay options to be selected.

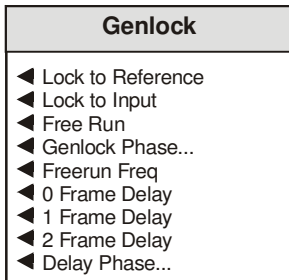

Lock to Reference

When selected and the unit will lock to the external reference signal.

Lock to Input

When selected the unit will lock to the input video signal.

Free Run

When selected the unit will not be locked to any input signals and the unit will free run.

Genlock Phase

This item allows the timing of the output signal relative to the reference sync signal to be adjusted

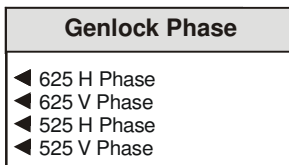

625/525 H(Horizontal) Phase

This item allows the horizontal timing of the output signal relative to the reference sync signal to be adjusted using the spinwheel by $\pm \frac{1}{2}$ line in 37 ns steps.

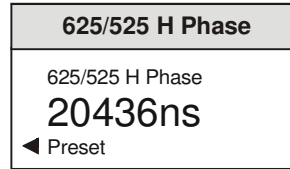

Note that picture disturbance may occur while this setting is adjusted.

Selecting Preset returns the setting to zero. (Output coincident with reference)

625/525 V(Vertical) Phase

This item allows the vertical timing of the output signal relative to the reference sync signal to be adjusted, in TV lines.

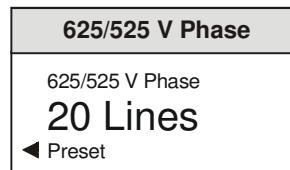

The spinwheel will adjust this value. Range is ± 262 lines (525 standard) or ± 312 lines (625 standard) in 1 line steps.

Note that picture disturbance may occur while this setting is adjusted.

Selecting Preset returns the setting to zero. (Output coincident with reference)

Freerun Freq(ueency)

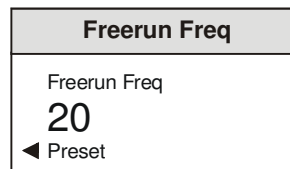

This allows the freerun frequency of the internal sync generator to be adjusted in steps of arbitrary units. Preset is to 0.

0, 1, 2 Frame Delay

The number of frames that the output signal will appear after the input signal may be set with these items.

Note that this function is available in any genlock mode and will add to any other delay settings.

Delay Phase

When these controls are used the output signal will appear after the input signal with a time delay. When not used the module will operate in the synchronize mode.

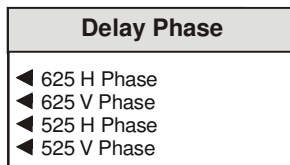

*Note that the delay functions are only active when the **Lock to Input** mode is selected.*

625/525 H(Horizontal) Phase

This item allows the horizontal timing of the output signal relative to the input signal to be adjusted by up to 1 line in 37 ns steps. The spinwheel will adjust this value.

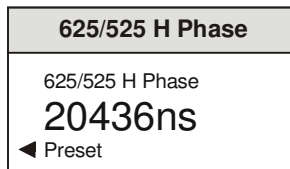

Selecting Preset returns the setting to the minimum horizontal delay.

625/525 V(Vertical) Phase

This item allows the vertical timing of the output signal relative to the input signal to be adjusted, in TV lines. The spinwheel will adjust this value. Range is from 0 to 624 or 524 lines in 1 line steps.

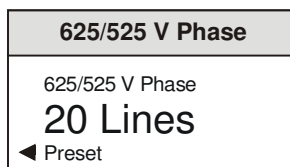

Selecting Preset returns the setting to the minimum vertical delay.

Setup...

Pattern

This function will allow various patterns to be used as the output signal.

Pattern
◀ Animated Pattern
◀ Enable Pattern
◀ Black
◀ EBU Colour Bars
◀ 100% Colour Bars
◀ Ramp
◀ Multiburst
◀ Pulse & Bar

Animated Pattern

When selected, a monochrome rectangular area will appear on the output picture as shown opposite. The brightness of this rectangle will ramp from black, through gray to white and then directly to black over a period of about one second. This action will then be repeated continuously.

This pattern is useful for checking active video paths. Down stream equipment can see that video has not been frozen.

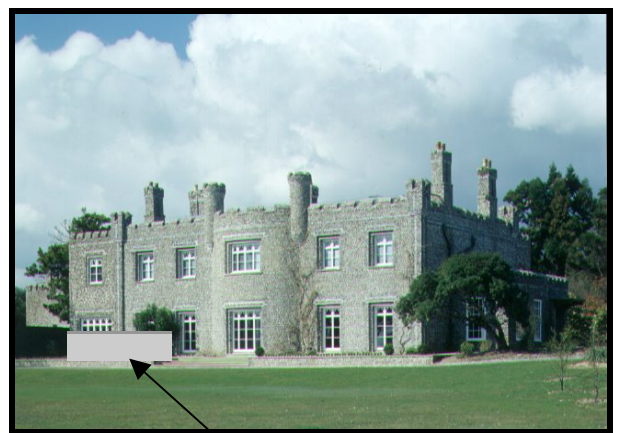

Animated Pattern

Enable Pattern

When selected the output will become the pattern highlighted in the Pattern list.

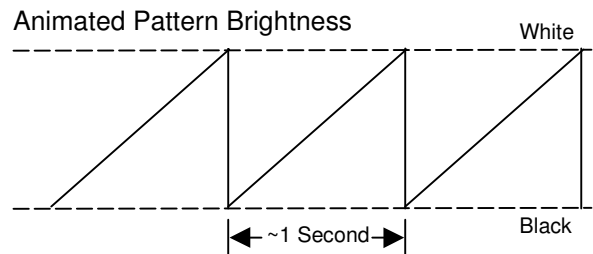

Caption

This function allows control of the caption which may contain a maximum of 19 characters (white text on a black background).

The caption will appear in the lower section of the picture.

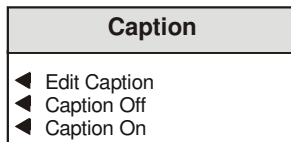

Edit Caption

This allows a caption to be edited.

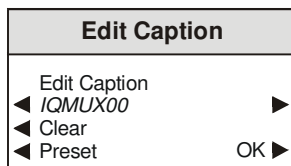

To compile/edit the text the right ▶ and left◀ buttons adjacent to the upper text line in the menu should be used to select the character position in the text and the spinwheel used to select the character.

The **Clear** function blanks the selected character.

The **Preset** function loads the default text, for example, **IQSYN01**.

O.K. ▶ saves the memory name text and returns to the main menu.

Caption Off

When selected the caption will be turned off.

Caption On

When selected the caption will be turned on.



Caption Text

Blanking

This item allows the Vertical Interval data (all or specific lines) contained in the input signal to be blanked or passed through the module.

Blanking	
◀ VI Pass 525...	
◀ VI Pass 625...	
◀ Hanc Blank	

VI Pass 525

This item allows lines 11 to 21 and lines 274 to 283 of 525 line signals to be selected and either passed (highlighted) to the output or blanked from the output.

VI Pass 525	
◀ Blank All	Pass All ▶
◀ Line 11	Line 274 ▶
to	to
◀ Line 21	Line 283 ▶

Blank All

Selecting this item will select all vertical interval lines in the 525 line list and blank them from the output.

Pass All ▶

Selecting this item will select all vertical interval lines in the 525 line list and allow them to be passed through to the output.

VI Pass 625	
◀ Blank All	Pass All ▶
◀ Line 7	Line 320 ▶
to	to
◀ Line 23	Line 335 ▶

VI Pass 625

This section allows lines 7 to 23 and lines 320 to 335 of 625 line signals to be selected and either passed (highlighted) to the output or blanked from the output.

Blank All

Selecting this item will select all vertical interval lines in the 625 line list and blank them from the output.

Pass All ▶

Selecting this item will select all vertical interval lines in the 625 line list and allow them to be passed through to the output.

Hanc Blank

When selected all horizontal data will be blanked, on the input. When unselected, passthrough operations will not alter audio packets.

For details of the HANC Data Handling please refer to Appendix 2 on page 58.

GPI/O

This function allows the GPI functions to be configured and their actions defined.

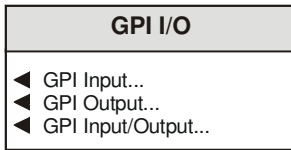

GPI Input

This item allows the GPI input functions to be configured.

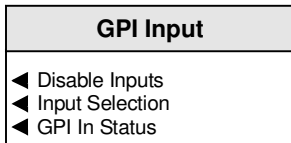

Disable Inputs

When selected all GPI input functions will be disabled.

Input Selection

When configured as an input the GPI connection may be used for accepting GPI information (from mechanical switch contacts, relay contacts etc.)

The resulting action that the unit takes may be selected using this item.

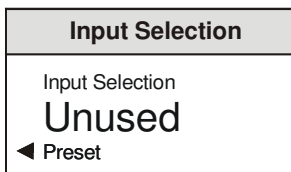

The GPI input functions that may be selected are as follows:

- Unused** The unit will perform no function. This is also the Preset Setting.
- Pattern** The unit will produce a pattern chosen from the Pattern menu when the input changes from open to closed.
- Memory 1 to 8** The unit will use the settings in the selected memory location when the input changes from open to closed.
- Mem1-2** The unit will toggle between the settings of memory locations 1 and 2.
Open to Closed = Memory 1 settings
Closed to Open = Memory 2 settings
- Mem 3-4** The unit will toggle between the settings of memory locations 3 and 4.
Open to Closed = Memory 3 settings
Closed to Open = Memory 4 settings
- Mem 5-6** The unit will toggle between the settings of memory locations 5 and 6.
Open to Closed = Memory 5 settings
Closed to Open = Memory 6 settings
- Mem 7-8** The unit will toggle between the settings of memory locations 7 and 8.
Open to Closed = Memory 7 settings
Closed to Open = Memory 8 settings

GPI In Status

This will display the current status of the selected GPI input.

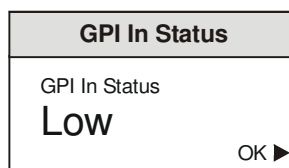

This may show either High or Low. When low, the associated function will be triggered. On a transition, the associated function will be triggered.

GPI Output

This item allows the GPI output functions to be configured.

GPI Output
<ul style="list-style-type: none"> ◀ Out Active High ◀ Output Selection... ◀ GPI Out Status

Out Active High

This determines the sense of the asserted GPI output signal.

When selected the GPI is active the output sense is high. When unchecked the GPI is active low.

Output Selection

The GPO may be configured to produce an output corresponding to one of the conditions highlighted in the list.

Output Selection
<ul style="list-style-type: none"> ◀ Input Present ◀ Standard 625 ◀ Video Delay ◀ Unused

The preset setting for the output is Unused.

When the condition is not true the output will float but when the condition is true the output is closed to ground via a transistor.

Note that when video delay mode is selected the output is a negative going TTL pulse. The width of the pulse represents the video delay through the unit to the nearest millisecond.

GPI Out Status

This will display the current status of the GPI output.

GPI Out Status
GPI Out Status LOW
OK ▶

This may show either Unused, High, low or video delay in milliseconds.

GPI I Input/Output

This allows the GPI port to be configured as an input or an output.

GPI Input/Output
◀ GPI/O 1

When selected the GPI is configured as an output. When unselected the GPI is configured as an input.

RollTrack

This function allows information to be sent, via the RollCall™ network, to other compatible units connected on the same network.

For example, it can enable compatible audio delay units to produce an audio delay dependent on this and other similar units. The audio delay unit will dynamically follow or track the received delay-time information. This allows processed video signals to be timed correctly with audio signals. This automatic tracking system via the RollCall™ network is called **RollTrack**.

RollTrack
◀ RollTrack Index
◀ RollTrack Source
◀ RollTrack Disable
◀ RollTrack Address
◀ RollTrack Command
◀ RollTrack Sending
◀ RollTrack Status

For more detailed information, see the *RollTrack* section (Appendix) at the end of this manual.

RollTrack Index

RollTrack Index
RollTrack Index
10
◀ Preset

This item is used to select which RollTrack Index is set up using the RollTrack Source, RollTrack Address and RollTrack Command functions.

RollTrack Source

RollTrack Source
RollTrack Source
Video Delay
◀ Preset

This allows the source of information that triggers the transmission of data to be selected.

Where applicable options are:

Unused (off)
Input Present
Input Missing
Standard 525
Standard 625
Input 1 Present
Input 1 Missing
Standard 1 525
Standard 1 625
Input 2 Present
Input 2 Missing
Standard 2 525
Standard 2 625
Video Delay
Reference Lost
Reference Present
Reference Error
GPI 1 Low
GPI 1 High
GPI 1 Inactive

The destination for the information is set by the network code address.

RollTrack Disable

When this item is selected all RollTrack items will be disabled.

RollTrack Address

This item allows the address of the selected destination unit to be set.

RollTrack Address	
RollTrack Address	
◀ 0 ▶	
◀ Clear ▶	
◀ Preset ▶	OK ▶

To compile/edit the text the right ▶ and left◀ buttons adjacent to the upper text line in the menu should be used to select the character position in the text and the spinwheel used to select the character.

The **Clear** function blanks the selected character.

The **Preset** function loads the default address.

O.K. ▶ saves the address and returns to the main menu.

The full **RollTrack** address has four sets of numbers

For example: 0000:10:01*99

The first set (0000) is the network segment code number

The second set (10) is the number identifying the (enclosure/mainframe) unit.

The third set (01) is the slot number in the unit

The Fourth Set (99)

Each RollCall unit has a unique identification embedded in the units' software. In this example 99 represents an IQBAXR, 142 would represent an IQDAMDD, 255 a TBS100D etc. Inserting this number in the RollTrack address ensures that only the correct type of unit (in this example an IQBAXR) will respond to the RollTrack command; any other unit will ignore the command.

If this number was set to 00 **any type** of unit at this location would respond to the RollTrack command, possibly causing unpredictable results.

RollTrack Command

RollTrack Command	
RollTrack Command	
◀ 0 ▶	
◀ Clear ▶	
◀ Preset ▶	OK ▶

The full **RollTrack** command has two sets of numbers

For example: 84*156

The first set (84) is the **RollTrack** command number

The second set (156) is the value sent with the **RollTrack** command number.

*Note that when video delay is selected as the **RollTrack** source the value sent with the **RollTrack** command is the video delay value not the value set.*

For details of the RollCall command values for specific units please contact your local Snell & Wilcox agent.

RollTrack Sending

This item shows when the unit is actively sending the RollTrack command.

RollTrack Sending/Status	
RollTrack Sending/Status	
YES	
	OK ▶

This may show:

String	A string value is always being sent.
Number	A number value is always being sent.
No	The message is not being sent.
Yes	The message is being sent.
Internal Type Error	Inconsistent behavior; please contact your local Snell & Wilcox agent.

RollTrack Status

This item will show the status of the currently selected RollTrack index.

This may show:

- OK RollTrack message sent and received OK.
- Unknown Rolltrack message has been sent but it has not yet completed.
- Timeout RollTrack message sent but acknowledgement not received. This could be because the destination unit is not at the location specified.
- Error This indicates a broken RollCall state.
- Bad This indicates a broken RollCall packet.

Logging

Information about up to 25 parameters can be made available to a logging device that is attached to the RollCall™ network by selecting the appropriate item.

Logging
<ul style="list-style-type: none"> ◀ Input ◀ Std ◀ Input1 ◀ Std1 ◀ Input2 ◀ Std2 ◀ Reference ◀ EDH ◀ EDH Errors ◀ Rolltrack ◀ Fault

Any of the items may be selected from the list.

Logging Status

Logging Status
<ul style="list-style-type: none"> ◀ INPUT= ◀ STD= ◀ INPUT1= ◀ STD1= ◀ INPUT2= ◀ STD2= ◀ EXTREF= ◀ EDH= ◀ ERRSEC= ◀ ROLLTRACK= ◀ FAULT=

This will show the status of the selected item.

Logging Status Items
<p>Logging Status Items xxxxxxx</p> <p style="text-align: right;">OK ▶</p>

ROLLCALL LOG FIELDS

Log Field	Log Value	Description
INPUT=	OK ERR* LOST	Valid input signal Invalid input signal Input signal lost
STD=	UNKNOWN* STDERR 525 625	Input signal standard not recognized or no signal Not a selected input standard Input standard 525 Input standard 625
INPUT1=	OK ERR* LOST	Valid input signal Invalid input signal Input signal lost
STD1=	ERR 525 625	Not a selected input standard Input standard 525 Input standard 625
INPUT2=	OK ERR* LOST	Valid input signal Invalid input signal Input signal lost
STD2=	ERR 525 625	Not a selected input standard Input standard 525 Input standard 625
EXTREF=	NONE 525 ERROR WARNING 625	No reference signal present Valid 525 reference signal Reference/Output standard mismatch Reference signal available but not selected Valid 625 reference signal
EDH=	NONE FAIL OK RESET	The unit is not locked to the input signal EDH errors have been found on the input signal No EDH errors found on the input signal EDH statistics have been reset
ERRSEC=	Runtime string	The time since EDH was reset in seconds
ROL_STATES=	OK FAIL	RollTrack message sent and received OK RollTrack message not acknowledged
FAULT=	NONE FAIL	No Internal errors detected Internal error detected
SN=	Runtime string	Serial number of unit

Information Window

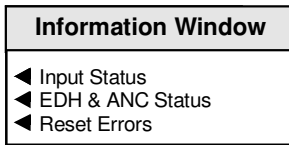

The type of information that appears in the Information Window may be chosen with this item.

Input Status

In1: or In2: This shows the status of the input, the line standard and which input has been selected.

Out: This shows the status of the output.

Reference: This will show the status of the reference signal.

EDH & ANC Status

E-Time: This shows the time since EDH was reset in Hours:Minutes:Seconds.

EDH: This shows the number of EDH errors that have occurred since the last EDH reset followed by the time in seconds since the last EDH error.

ANC: This shows the number of ANC errors that have occurred since the last ANC reset followed by the time in seconds since the last ANC error

Reset Errors

Selecting this function will reset the EDH error count and the timer shown in the information window, to zero.

Default Output

If the input signal fails or is of poor quality this function will determine what the output signal will become under such conditions.

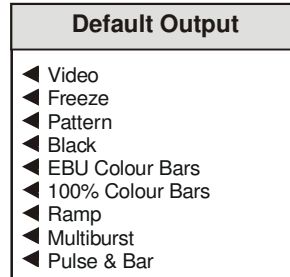

Pattern

If Pattern is chosen in the **Default Output** menu the output will become the pattern chosen from the list.

Unit

This provides various items of information about the unit.

Unit
<ul style="list-style-type: none"> ◀ Software Version ◀ Serial No ◀ Preset Unit ◀ Restart ◀ Build No

Software Version

This item reveals a display showing the version of the software fitted in the module.

Software Version
Software Version x.x.x OK ▶

Select OK to return to the Unit Menu.

Serial No

This item reveals a display showing the serial number of the module.

Serial No
Serial No xxxxxxx OK ▶

Select OK to return to the Unit Menu.

Preset Unit

Selecting this item sets all adjustment functions that include a preset facility, to their preset values.

Note that this is a momentary action.

Restart

This will reboot the unit simulating a power-down power-up cycle restoring power-up settings.

Build No

This will indicate the factory build number. This number defines all parameters of the unit (software versions, build level etc.) for identification purposes.

Build No
Build No xxxxxxx OK ▶

Select OK to return to the Unit Menu.

IQSYN01 RollCall Commands

Supervisor Level

Command No.		Command Name	Values
Hex	Dec		
0001	1	Serial No	Static Display (no control)
0002	2	Software Version	Static Display (no control)
0003	3	<RETURN>	1=Preset Unit
0004	4	<RETURN>	1=Restart
0005	5	Build No	Static Display (no control)
000E	14	Rolltrack 14	Static Display (no control)
000F	15	Rolltrack 15	Static Display (no control)
0010	16	Rolltrack 16	Static Display (no control)
0011	17	Rolltrack 17	Static Display (no control)
040B	1035	Enable Pattern	clear=0 set=1 (toggle=2)
040C	1036	<RETURN>	0=Black 1=EBU Colour Bars 2=100% Colour Bars 3=Ramp 4=Multiburst 5=Pulse & Bar
040D	1037	<RETURN>	0=Caption Off 1=Caption On
040E	1038	<RETURN>	0=Black 1=EBU Colour Bars 2=100% Colour Bars 3=Ramp 4=Multiburst 5=Pulse & Bar
0411	1041	Edit Caption	Edit String
0419	1049	<RETURN>	0=Lock to Reference 1=Lock to Input 2=Free Run
041A	1050	625 H Phase	min=-31999968 max=31962931 Step=37037 Div=1000
041B	1051	625 V Phase	min=-312 max=312 Step=1
041C	1052	525 H Phase	min=-31777746 max=31740709 Step=37037 Div=1000
041D	1053	525 V Phase	min=-262 max=262 Step=1
0424	1060	Input	clear=0 set=1 (toggle=2)
0425	1061	Std	clear=0 set=1 (toggle=2)
0426	1062	Reference	clear=0 set=1 (toggle=2)
0428	1064	EDH	clear=0 set=1 (toggle=2)
042D	1069	Fault	clear=0 set=1 (toggle=2)
042E	1070	EDH Errors	clear=0 set=1 (toggle=2)
0446	1094	Input1	clear=0 set=1 (toggle=2)
0447	1095	Input2	clear=0 set=1 (toggle=2)
0449	1097	Std1	clear=0 set=1 (toggle=2)
044A	1098	Std2	clear=0 set=1 (toggle=2)
0452	1106	RollTrack	clear=0 set=1 (toggle=2)
0454	1108	AES 1	clear=0 set=1 (toggle=2)
0455	1109	AES 2	clear=0 set=1 (toggle=2)
0458	1112	Bus AL	clear=0 set=1 (toggle=2)
0459	1113	Bus AR	clear=0 set=1 (toggle=2)
045A	1114	Bus BL	clear=0 set=1 (toggle=2)
045B	1115	Bus BR	clear=0 set=1 (toggle=2)
045C	1116	Bus CL	clear=0 set=1 (toggle=2)
045D	1117	Bus CR	clear=0 set=1 (toggle=2)
045E	1118	Bus DL	clear=0 set=1 (toggle=2)
045F	1119	Bus DR	clear=0 set=1 (toggle=2)
0460	1120	De-embed 1	clear=0 set=1 (toggle=2)
0461	1121	De-embed 2	clear=0 set=1 (toggle=2)
0462	1122	De-embed 3	clear=0 set=1 (toggle=2)
0463	1123	De-embed 4	clear=0 set=1 (toggle=2)
0464	1124	De-embed 5	clear=0 set=1 (toggle=2)
0465	1125	De-embed 6	clear=0 set=1 (toggle=2)
0466	1126	De-embed 7	clear=0 set=1 (toggle=2)
0467	1127	De-embed 8	clear=0 set=1 (toggle=2)
0468	1128	nPCM 1	clear=0 set=1 (toggle=2)
0469	1129	nPCM 2	clear=0 set=1 (toggle=2)
046A	1130	nPCM 3	clear=0 set=1 (toggle=2)
046B	1131	nPCM 4	clear=0 set=1 (toggle=2)
046C	1132	nPCM 5	clear=0 set=1 (toggle=2)
046D	1133	nPCM 6	clear=0 set=1 (toggle=2)
046E	1134	nPCM 7	clear=0 set=1 (toggle=2)
046F	1135	nPCM 8	clear=0 set=1 (toggle=2)
04B2	1202	<RETURN>	1=Video 2=Freeze 3=Pattern
04B8	1208	Freeze	clear=0 set=1 (toggle=2)
04BB	1211	Line 11	clear=0 set=1 (toggle=2)
04BC	1212	Line 12	clear=0 set=1 (toggle=2)
04BD	1213	Line 13	clear=0 set=1 (toggle=2)
04BE	1214	Line 14	clear=0 set=1 (toggle=2)
04BF	1215	Line 15	clear=0 set=1 (toggle=2)
04C0	1216	Line 16	clear=0 set=1 (toggle=2)
04C1	1217	Line 17	clear=0 set=1 (toggle=2)
04C2	1218	Line 18	clear=0 set=1 (toggle=2)
04C3	1219	Line 19	clear=0 set=1 (toggle=2)
04C4	1220	Line 20	clear=0 set=1 (toggle=2)

04C5	1221	Line 21	clear=0 set=1 (toggle=2)
04CF	1231	Line 274	clear=0 set=1 (toggle=2)
04D0	1232	Line 275	clear=0 set=1 (toggle=2)
04D1	1233	Line 276	clear=0 set=1 (toggle=2)
04D2	1234	Line 277	clear=0 set=1 (toggle=2)
04D3	1235	Line 278	clear=0 set=1 (toggle=2)
04D4	1236	Line 279	clear=0 set=1 (toggle=2)
04D5	1237	Line 280	clear=0 set=1 (toggle=2)
04D6	1238	Line 281	clear=0 set=1 (toggle=2)
04D7	1239	Line 282	clear=0 set=1 (toggle=2)
04D8	1240	Line 283	clear=0 set=1 (toggle=2)
04E3	1251	Line 7	clear=0 set=1 (toggle=2)
04E4	1252	Line 8	clear=0 set=1 (toggle=2)
04E5	1253	Line 9	clear=0 set=1 (toggle=2)
04E6	1254	Line 10	clear=0 set=1 (toggle=2)
04E7	1255	Line 11	clear=0 set=1 (toggle=2)
04E8	1256	Line 12	clear=0 set=1 (toggle=2)
04E9	1257	Line 13	clear=0 set=1 (toggle=2)
04EA	1258	Line 14	clear=0 set=1 (toggle=2)
04EB	1259	Line 15	clear=0 set=1 (toggle=2)
04EC	1260	Line 16	clear=0 set=1 (toggle=2)
04ED	1261	Line 17	clear=0 set=1 (toggle=2)
04EE	1262	Line 18	clear=0 set=1 (toggle=2)
04EF	1263	Line 19	clear=0 set=1 (toggle=2)
04F0	1264	Line 20	clear=0 set=1 (toggle=2)
04F1	1265	Line 21	clear=0 set=1 (toggle=2)
04F2	1266	Line 22	clear=0 set=1 (toggle=2)
04F3	1267	Line 23	clear=0 set=1 (toggle=2)
04F8	1272	Line 320	clear=0 set=1 (toggle=2)
04F9	1273	Line 321	clear=0 set=1 (toggle=2)
04FA	1274	Line 322	clear=0 set=1 (toggle=2)
04FB	1275	Line 323	clear=0 set=1 (toggle=2)
04FC	1276	Line 324	clear=0 set=1 (toggle=2)
04FD	1277	Line 325	clear=0 set=1 (toggle=2)
04FE	1278	Line 326	clear=0 set=1 (toggle=2)
04FF	1279	Line 327	clear=0 set=1 (toggle=2)
0500	1280	Line 328	clear=0 set=1 (toggle=2)
0501	1281	Line 329	clear=0 set=1 (toggle=2)
0502	1282	Line 330	clear=0 set=1 (toggle=2)
0503	1283	Line 331	clear=0 set=1 (toggle=2)
0504	1284	Line 332	clear=0 set=1 (toggle=2)
0505	1285	Line 333	clear=0 set=1 (toggle=2)
0506	1286	Line 334	clear=0 set=1 (toggle=2)
0507	1287	Line 335	clear=0 set=1 (toggle=2)
050F	1295	<VI Pass 625>	1=Pass All
0510	1296	<VI Pass 625>	1=Blank All
0511	1297	<VI Pass 525>	1=Pass All
0512	1298	<VI Pass 525>	1=Blank All
057D	1405	525	clear=0 set=1 (toggle=2)
057E	1406	625	clear=0 set=1 (toggle=2)
05D7	1495	RollTrack Index	min=0 max=15 Step=1
05D8	1496	RollTrack Source	min=-1 max=8 Step=1
05D9	1497	RollTrack Address	Edit String
05DA	1498	RollTrack Command	Edit String
05E7	1511	RollTrack Status	Static Display (no control)
05E9	1513	RollTrack Disable	clear=0 set=1 (toggle=2)
05EA	1514	RollTrack Sending	Static Display (no control)
0640	1600	<Memory 1>	1=Save 1
0641	1601	<Memory 1>	1=Recall 1
0642	1602	<Memory 1>	1=Clear 1
0643	1603	Name 1	Edit String
0644	1604	<Memory 2>	1=Save 2
0645	1605	<Memory 2>	1=Recall 2
0646	1606	<Memory 2>	1=Clear 2
0647	1607	Name 2	Edit String
0648	1608	<Memory 3>	1=Save 3
0649	1609	<Memory 3>	1=Recall 3
064A	1610	<Memory 3>	1=Clear 3
064B	1611	Name 3	Edit String
064C	1612	<Memory 4>	1=Save 4
064D	1613	<Memory 4>	1=Recall 4
064E	1614	<Memory 4>	1=Clear 4
064F	1615	Name 4	Edit String
0650	1616	<Memory 5>	1=Save 5
0651	1617	<Memory 5>	1=Recall 5
0652	1618	<Memory 5>	1=Clear 5
0653	1619	Name 5	Edit String
0654	1620	<Memory 6>	1=Save 6
0655	1621	<Memory 6>	1=Recall 6
0656	1622	<Memory 6>	1=Clear 6
0657	1623	Name 6	Edit String

0658	1624	<Memory 7>	1=Save 7				
0659	1625	<Memory 7>	1=Recall 7				
065A	1626	<Memory 7>	1=Clear 7				
065B	1627	Name 7	Edit String				
065C	1628	<Memory 8>	1=Save 8				
065D	1629	<Memory 8>	1=Recall 8				
065E	1630	<Memory 8>	1=Clear 8				
065F	1631	Name 8	Edit String				
077B	1915	<RETURN>	0=Input Status	1=EDH & ANC Status	2=Audio		
			Input Status				
07DB	2011	Input Selection	min=-1	max=12	Step=1		
07DD	2013	<Output Selection>	0=Input Present	1=Standard 625	2=Video		
			Delay	3=Unused			
07DE	2014	GPI/O 1	clear=0	set=1 (toggle=2)			
0800	2048	GPI In Status	Static Display (no control)				
0801	2049	GPI Out Status	Static Display (no control)				
08CB	2251	<RETURN>	0=Input 1 SDI	1=Input 2 SDI			
0991	2449	Freerun Freq	min=-60	max=60	Step=1		
09B7	2487	Frequency	min=100	max=15000	Step=100		
09B8	2488	Frequency R	min=100	max=15000	Step=100		
09B9	2489	Ident Enable	clear=0	set=1 (toggle=2)			
09D5	2517	Low Level	min=-96	max=0	Step=1		
09D6	2518	Warning Timer	min=1	max=20	Step=1		
09E3	2531	<Pair Selection>	0=Select Pair 1	1=Select Pair 2	2=Select		
			Pair 3	3=Select Pair 4			
			4=Select Pair 5	5=Select Pair 6	6=Select		
			Pair 7	7=Select Pair 8			
09E4	2532	<Pair Selection>	0=Select Pair 1	1=Select Pair 2	2=Select		
			Pair 3	3=Select Pair 4			
			4=Select Pair 5	5=Select Pair 6	6=Select		
			Pair 7	7=Select Pair 8			
09E5	2533	<Pair Selection>	0=Select Pair 1	1=Select Pair 2	2=Select		
			Pair 3	3=Select Pair 4			
			4=Select Pair 5	5=Select Pair 6	6=Select		
			Pair 7	7=Select Pair 8			
09E6	2534	<Pair Selection>	0=Select Pair 1	1=Select Pair 2	2=Select		
			Pair 3	3=Select Pair 4			
			4=Select Pair 5	5=Select Pair 6	6=Select		
			Pair 7	7=Select Pair 8			
09ED	2541	Disable	clear=0	set=1 (toggle=2)			
09EE	2542	Disable	clear=0	set=1 (toggle=2)			
09EF	2543	Disable	clear=0	set=1 (toggle=2)			
09F0	2544	Disable	clear=0	set=1 (toggle=2)			
0A07	2567	Internal	clear=0	set=1 (toggle=2)			
0A08	2568	Manual	clear=0	set=1 (toggle=2)			
0A09	2569	Rolltrack 14	clear=0	set=1 (toggle=2)			
0A0A	2570	Rolltrack 15	clear=0	set=1 (toggle=2)			
0A0B	2571	Rolltrack 16	clear=0	set=1 (toggle=2)			
0A0C	2572	Rolltrack 17	clear=0	set=1 (toggle=2)			
0A0D	2573	Manual Delay	min=-40	max=1500	Step=1		
0A0D	2573	Manual	Static Display (no control)				
0A0E	2574	Internal	Static Display (no control)				
0A2D	2605	Disable Inputs	clear=0	set=1 (toggle=2)			
0A92	2706	Chroma Gain	min=-60	max=60	Step=1	Div=10	Units=dB
0A93	2707	Luma Gain	min=-60	max=60	Step=1	Div=10	Units=dB
0A94	2708	Black Level	min=-1000	max=1000	Step=8	Div=10	Units=mV
0A95	2709	Picture Position	min=-592	max=592	Step=148		
0A96	2710	Chroma Gain	min=-60	max=60	Step=1	Div=10	Units=dB
0A97	2711	Luma Gain	min=-60	max=60	Step=1	Div=10	Units=dB
0A98	2712	Black Level	min=-1000	max=1000	Step=8	Div=10	Units=mV
0A99	2713	Picture Position	min=-592	max=592	Step=148		
0B30	2864	In1 ProcAmp Enable	clear=0	set=1 (toggle=2)			
0B31	2865	In2 ProcAmp Enable	clear=0	set=1 (toggle=2)			
0B36	2870	RollTrack Index	min=0	max=15	Step=1		
0B37	2871	RollTrack Source	min=-1	max=8	Step=1		
0B38	2872	RollTrack Address	Edit String				
0B39	2873	RollTrack Command	Edit String				
0B3B	2875	Input Selection	min=-1	max=12	Step=1		
0B3D	2877	<Output Selection>	0=Input Present	1=Standard 625	2=Video		
			Delay	3=Unused			
0B6B	2923	<RETURN>	0=Input 1 SDI	1=Input 2 SDI	2=Follow Video		
0B6C	2924	Y/C Timing	min=-592	max=592	Step=148		
0B6D	2925	Y/C Timing	min=-592	max=592	Step=148		
0B70	2928	AES 1 Delay	min=0	max=1500	Step=1		
0B71	2929	AES 2 Delay	min=0	max=1500	Step=1		
0B7C	2940	Animated Pattern	clear=0	set=1 (toggle=2)			
0B7D	2941	<Embed 1 Source>	0=BUS A	1=BUS B	2=BUS C		
			3=BUS D				
			4=AES 1 Direct	5=AES 2 Direct	6=Test tone		
			7=Silence				

0B7E	2942	<Embed 2 Source>	0=BUS A	1=BUS B	2=BUS C
			3=BUS D		
			4=AES 1 Direct	5=AES 2 Direct	6=Test tone
			7=Silence		
0B7F	2943	<Embed 3 Source>	0=BUS A	1=BUS B	2=BUS C
			3=BUS D		
			4=AES 1 Direct	5=AES 2 Direct	6=Test tone
			7=Silence		
0B80	2944	<Embed 4 Source>	0=BUS A	1=BUS B	2=BUS C
			3=BUS D		
			4=AES 1 Direct	5=AES 2 Direct	6=Test tone
			7=Silence		
0B9B	2971	Hanc Blank	clear=0	set=1 (toggle=2)	
0B9C	2972	<Slew Rate>	0=Instant	1=Fast	2=Medium
			3=Slow		
			4=Slowest		
0B9D	2973	<Genlock Phase>	0=0 Frame Delay	1=1 Frame Delay	2=2 Frame Delay
0B9E	2974	625 H Phase	min=0	max=63962899	Step=37037 Div=1000
0B9F	2975	625 V Phase	min=0	max=624	Step=1
0BA0	2976	525 H Phase	min=0	max=63518455	Step=37037 Div=1000
0BA1	2977	525 V Phase	min=0	max=524	Step=1
0BA2	2978	<RETURN>	1=Reset Errors		
0BA3	2979	Total Delay Display	Static Display (no control)		
0BA4	2980	INPUT=	Static Display (no control)		
0BA5	2981	STD=	Static Display (no control)		
0BA6	2982	INPUT1=	Static Display (no control)		
0BA7	2983	STD1=	Static Display (no control)		
0BA8	2984	INPUT2=	Static Display (no control)		
0BA9	2985	STD2=	Static Display (no control)		
0BAA	2986	EXTREF=	Static Display (no control)		
0BAB	2987	EDH=	Static Display (no control)		
0BAC	2988	ERRSEC=	Static Display (no control)		
0BAD	2989	ROLLTRACK=	Static Display (no control)		
0BAE	2990	FAULT=	Static Display (no control)		
0BB2	2994	AES1=	Static Display (no control)		
0BB3	2995	AES2=	Static Display (no control)		
0BB6	2998	BUSAL=	Static Display (no control)		
0BB7	2999	BUSAR=	Static Display (no control)		
0BB8	3000	BUSBL=	Static Display (no control)		
0BB9	3001	BUSBR=	Static Display (no control)		
0BBA	3002	BUSCL=	Static Display (no control)		
0BBB	3003	BUSCR=	Static Display (no control)		
0BBC	3004	BUSDL=	Static Display (no control)		
0BBD	3005	BUSDR=	Static Display (no control)		
0BC6	3014	DEEMBDED1=	Static Display (no control)		
0BC7	3015	DEEMBDED2=	Static Display (no control)		
0BC8	3016	DEEMBDED3=	Static Display (no control)		
0BC9	3017	DEEMBDED4=	Static Display (no control)		
0BCA	3018	DEEMBDED5=	Static Display (no control)		
0BCB	3019	DEEMBDED6=	Static Display (no control)		
0BCC	3020	DEEMBDED7=	Static Display (no control)		
0BCD	3021	DEEMBDED8=	Static Display (no control)		
0BCE	3022	NPCM1=	Static Display (no control)		
0BCF	3023	NPCM2=	Static Display (no control)		
0BD0	3024	NPCM3=	Static Display (no control)		
0BD1	3025	NPCM4=	Static Display (no control)		
0BD2	3026	NPCM5=	Static Display (no control)		
0BD3	3027	NPCM6=	Static Display (no control)		
0BD4	3028	NPCM7=	Static Display (no control)		
0BD5	3029	NPCM8=	Static Display (no control)		
0BEB	3051	GPI Delay Select	clear=0	set=1 (toggle=2)	
0BEC	3052	GPI Delay Display	Static Display (no control)		
0BED	3053	InputTimer Enable	clear=0	set=1 (toggle=2)	
0BEE	3054	TimerActive High	clear=0	set=1 (toggle=2)	
0BEF	3055	HeadRoom	min=4	max=24	Step=1
0BF0	3056	Silence Level	min=-96	max=0	Step=1
0BF1	3057	High Level	min=-96	max=0	Step=1
0BF2	3058	Overload Level	min=-96	max=0	Step=1
0BF4	3060	Channel Status	Edit String		
0C08	3080	Gain Bus AL	min=-180	max=180	Step=1 Div=10
0C09	3081	Gain Bus AR	min=-180	max=180	Step=1 Div=10
0C0A	3082	Gain Bus BL	min=-180	max=180	Step=1 Div=10
0C0B	3083	Gain Bus BR	min=-180	max=180	Step=1 Div=10
0C0C	3084	Gain Bus CL	min=-180	max=180	Step=1 Div=10
0C0D	3085	Gain Bus CR	min=-180	max=180	Step=1 Div=10
0C0E	3086	Gain Bus DL	min=-180	max=180	Step=1 Div=10
0C0F	3087	Gain Bus DR	min=-180	max=180	Step=1 Div=10
0C10	3088	Gain De-embed 1L	min=-180	max=180	Step=1 Div=10
0C11	3089	Gain De-embed 1R	min=-180	max=180	Step=1 Div=10
0C12	3090	Gain De-embed 2L	min=-180	max=180	Step=1 Div=10

0C13	3091	Gain De-embed	2R	min=-180	max=180	Step=1	Div=10
0C14	3092	Gain De-embed	3L	min=-180	max=180	Step=1	Div=10
0C15	3093	Gain De-embed	3R	min=-180	max=180	Step=1	Div=10
0C16	3094	Gain De-embed	4L	min=-180	max=180	Step=1	Div=10
0C17	3095	Gain De-embed	4R	min=-180	max=180	Step=1	Div=10
0C18	3096	Gain De-embed	5L	min=-180	max=180	Step=1	Div=10
0C19	3097	Gain De-embed	5R	min=-180	max=180	Step=1	Div=10
0C1A	3098	Gain De-embed	6L	min=-180	max=180	Step=1	Div=10
0C1B	3099	Gain De-embed	6R	min=-180	max=180	Step=1	Div=10
0C1C	3100	Gain De-embed	7L	min=-180	max=180	Step=1	Div=10
0C1D	3101	Gain De-embed	7R	min=-180	max=180	Step=1	Div=10
0C1E	3102	Gain De-embed	8L	min=-180	max=180	Step=1	Div=10
0C1F	3103	Gain De-embed	8R	min=-180	max=180	Step=1	Div=10
0C20	3104	Gain AES	1L	min=-180	max=180	Step=1	Div=10
0C21	3105	Gain AES	1R	min=-180	max=180	Step=1	Div=10
0C22	3106	Gain AES	2L	min=-180	max=180	Step=1	Div=10
0C23	3107	Gain AES	2R	min=-180	max=180	Step=1	Div=10
0C58	3160	Invert		clear=0	set=1	(toggle=2)	
0C59	3161	Invert		clear=0	set=1	(toggle=2)	
0C5A	3162	Invert		clear=0	set=1	(toggle=2)	
0C5B	3163	Invert		clear=0	set=1	(toggle=2)	
0C5C	3164	Invert		clear=0	set=1	(toggle=2)	
0C5D	3165	Invert		clear=0	set=1	(toggle=2)	
0C5E	3166	Invert		clear=0	set=1	(toggle=2)	
0C5F	3167	Invert		clear=0	set=1	(toggle=2)	
0C60	3168	Invert		clear=0	set=1	(toggle=2)	
0C61	3169	Invert		clear=0	set=1	(toggle=2)	
0C62	3170	Invert		clear=0	set=1	(toggle=2)	
0C63	3171	Invert		clear=0	set=1	(toggle=2)	
0C64	3172	Invert		clear=0	set=1	(toggle=2)	
0C65	3173	Invert		clear=0	set=1	(toggle=2)	
0C66	3174	Invert		clear=0	set=1	(toggle=2)	
0C67	3175	Invert		clear=0	set=1	(toggle=2)	
0C68	3176	Invert		clear=0	set=1	(toggle=2)	
0C69	3177	Invert		clear=0	set=1	(toggle=2)	
0C6A	3178	Invert		clear=0	set=1	(toggle=2)	
0C6B	3179	Invert		clear=0	set=1	(toggle=2)	
0C6C	3180	Invert		clear=0	set=1	(toggle=2)	
0C6D	3181	Invert		clear=0	set=1	(toggle=2)	
0C6E	3182	Invert		clear=0	set=1	(toggle=2)	
0C6F	3183	Invert		clear=0	set=1	(toggle=2)	
0C70	3184	Invert		clear=0	set=1	(toggle=2)	
0C71	3185	Invert		clear=0	set=1	(toggle=2)	
0C72	3186	Invert		clear=0	set=1	(toggle=2)	
0C73	3187	Invert		clear=0	set=1	(toggle=2)	
0CA8	3240	Mute		clear=0	set=1	(toggle=2)	
0CA9	3241	Mute		clear=0	set=1	(toggle=2)	
0CAA	3242	Mute		clear=0	set=1	(toggle=2)	
0CAB	3243	Mute		clear=0	set=1	(toggle=2)	
0CAC	3244	Mute		clear=0	set=1	(toggle=2)	
0CAD	3245	Mute		clear=0	set=1	(toggle=2)	
0CAE	3246	Mute		clear=0	set=1	(toggle=2)	
0CAF	3247	Mute		clear=0	set=1	(toggle=2)	
0CB0	3248	Mute		clear=0	set=1	(toggle=2)	
0CB1	3249	Mute		clear=0	set=1	(toggle=2)	
0CB2	3250	Mute		clear=0	set=1	(toggle=2)	
0CB3	3251	Mute		clear=0	set=1	(toggle=2)	
0CB4	3252	Mute		clear=0	set=1	(toggle=2)	
0CB5	3253	Mute		clear=0	set=1	(toggle=2)	
0CB6	3254	Mute		clear=0	set=1	(toggle=2)	
0CB7	3255	Mute		clear=0	set=1	(toggle=2)	
0CB8	3256	Mute		clear=0	set=1	(toggle=2)	
0CB9	3257	Mute		clear=0	set=1	(toggle=2)	
0CBA	3258	Mute		clear=0	set=1	(toggle=2)	
0CBB	3259	Mute		clear=0	set=1	(toggle=2)	
0CBC	3260	Mute		clear=0	set=1	(toggle=2)	
0CBD	3261	Mute		clear=0	set=1	(toggle=2)	
0CBE	3262	Mute		clear=0	set=1	(toggle=2)	
0CBF	3263	Mute		clear=0	set=1	(toggle=2)	
0CC0	3264	Mute		clear=0	set=1	(toggle=2)	
0CC1	3265	Mute		clear=0	set=1	(toggle=2)	
0CC2	3266	Mute		clear=0	set=1	(toggle=2)	
0CC3	3267	Mute		clear=0	set=1	(toggle=2)	
0CF8	3320	Stereo	A	clear=0	set=1	(toggle=2)	
0CF9	3321	Stereo	B	clear=0	set=1	(toggle=2)	
0CFA	3322	Stereo	C	clear=0	set=1	(toggle=2)	
0CFB	3323	Stereo	D	clear=0	set=1	(toggle=2)	
0CFC	3324	Stereo	1	clear=0	set=1	(toggle=2)	
0CFD	3325	Stereo	2	clear=0	set=1	(toggle=2)	
0CFE	3326	Stereo	3	clear=0	set=1	(toggle=2)	
0CFF	3327	Stereo	4	clear=0	set=1	(toggle=2)	

```

0D00 3328 Stereo 5 clear=0 set=1 (toggle=2)
0D01 3329 Stereo 6 clear=0 set=1 (toggle=2)
0D02 3330 Stereo 7 clear=0 set=1 (toggle=2)
0D03 3331 Stereo 8 clear=0 set=1 (toggle=2)
0D04 3332 Stereo 1 clear=0 set=1 (toggle=2)
0D05 3333 Stereo 2 clear=0 set=1 (toggle=2)
0D20 3360 Gain1 min=-71 max=0 Step=1
0D21 3361 Gain2 min=-71 max=0 Step=1
0D22 3362 Gain3 min=-71 max=0 Step=1
0D23 3363 Gain4 min=-71 max=0 Step=1
0D24 3364 Gain1 min=-71 max=0 Step=1
0D25 3365 Gain2 min=-71 max=0 Step=1
0D26 3366 Gain3 min=-71 max=0 Step=1
0D27 3367 Gain4 min=-71 max=0 Step=1
0D28 3368 Gain1 min=-71 max=0 Step=1
0D29 3369 Gain2 min=-71 max=0 Step=1
0D2A 3370 Gain3 min=-71 max=0 Step=1
0D2B 3371 Gain4 min=-71 max=0 Step=1
0D2C 3372 Gain1 min=-71 max=0 Step=1
0D2D 3373 Gain2 min=-71 max=0 Step=1
0D2E 3374 Gain3 min=-71 max=0 Step=1
0D2F 3375 Gain4 min=-71 max=0 Step=1
0D70 3440 <RETURN> 0=DeEmbed 1L 1=DeEmbed 1R 2=DeEmbed 2L
3=DeEmbed 2R 4=DeEmbed 3L 5=DeEmbed 3R 6=DeEmbed 4L
7=DeEmbed 4R 8=DeEmbed 5L 9=DeEmbed 5R 10=DeEmbed 6L
11=DeEmbed 6R 12=DeEmbed 7L 13=DeEmbed 7R 14=DeEmbed 8L
15=DeEmbed 8R 16=AES 1L 17=AES 1R 18=AES 2L
19=AES 2R
0D71 3441 <RETURN> 0=DeEmbed 1L 1=DeEmbed 1R 2=DeEmbed 2L
3=DeEmbed 2R 4=DeEmbed 3L 5=DeEmbed 3R 6=DeEmbed 4L
7=DeEmbed 4R 8=DeEmbed 5L 9=DeEmbed 5R 10=DeEmbed 6L
11=DeEmbed 6R 12=DeEmbed 7L 13=DeEmbed 7R 14=DeEmbed 8L
15=DeEmbed 8R 16=AES 1L 17=AES 1R 18=AES 2L
19=AES 2R
0D72 3442 <RETURN> 0=DeEmbed 1L 1=DeEmbed 1R 2=DeEmbed 2L
3=DeEmbed 2R 4=DeEmbed 3L 5=DeEmbed 3R 6=DeEmbed 4L
7=DeEmbed 4R 8=DeEmbed 5L 9=DeEmbed 5R 10=DeEmbed 6L
11=DeEmbed 6R 12=DeEmbed 7L 13=DeEmbed 7R 14=DeEmbed 8L
15=DeEmbed 8R 16=AES 1L 17=AES 1R 18=AES 2L
19=AES 2R
0D73 3443 <RETURN> 0=DeEmbed 1L 1=DeEmbed 1R 2=DeEmbed 2L
3=DeEmbed 2R 4=DeEmbed 3L 5=DeEmbed 3R 6=DeEmbed 4L
7=DeEmbed 4R 8=DeEmbed 5L 9=DeEmbed 5R 10=DeEmbed 6L
11=DeEmbed 6R 12=DeEmbed 7L 13=DeEmbed 7R 14=DeEmbed 8L
15=DeEmbed 8R 16=AES 1L 17=AES 1R 18=AES 2L
19=AES 2R
0D74 3444 <RETURN> 0=DeEmbed 1L 1=DeEmbed 1R 2=DeEmbed 2L
3=DeEmbed 2R 4=DeEmbed 3L 5=DeEmbed 3R 6=DeEmbed 4L
7=DeEmbed 4R 8=DeEmbed 5L 9=DeEmbed 5R 10=DeEmbed 6L
11=DeEmbed 6R 12=DeEmbed 7L 13=DeEmbed 7R 14=DeEmbed 8L
15=DeEmbed 8R 16=AES 1L 17=AES 1R 18=AES 2L
19=AES 2R

```

0D75	3445	<RETURN>	0=DeEmbed 1L	1=DeEmbed 1R	2=DeEmbed 2L
			3=DeEmbed 2R		
			4=DeEmbed 3L	5=DeEmbed 3R	6=DeEmbed 4L
			7=DeEmbed 4R		
			8=DeEmbed 5L	9=DeEmbed 5R	10=DeEmbed 6L
			11=DeEmbed 6R		
			12=DeEmbed 7L	13=DeEmbed 7R	14=DeEmbed 8L
			15=DeEmbed 8R		
			16=AES 1L	17=AES 1R	18=AES 2L
			19=AES 2R		
0D76	3446	<RETURN>	0=DeEmbed 1L	1=DeEmbed 1R	2=DeEmbed 2L
			3=DeEmbed 2R		
			4=DeEmbed 3L	5=DeEmbed 3R	6=DeEmbed 4L
			7=DeEmbed 4R		
			8=DeEmbed 5L	9=DeEmbed 5R	10=DeEmbed 6L
			11=DeEmbed 6R		
			12=DeEmbed 7L	13=DeEmbed 7R	14=DeEmbed 8L
			15=DeEmbed 8R		
			16=AES 1L	17=AES 1R	18=AES 2L
			19=AES 2R		
0D77	3447	<RETURN>	0=DeEmbed 1L	1=DeEmbed 1R	2=DeEmbed 2L
			3=DeEmbed 2R		
			4=DeEmbed 3L	5=DeEmbed 3R	6=DeEmbed 4L
			7=DeEmbed 4R		
			8=DeEmbed 5L	9=DeEmbed 5R	10=DeEmbed 6L
			11=DeEmbed 6R		
			12=DeEmbed 7L	13=DeEmbed 7R	14=DeEmbed 8L
			15=DeEmbed 8R		
			16=AES 1L	17=AES 1R	18=AES 2L
			19=AES 2R		
0D78	3448	<RETURN>	0=DeEmbed 1L	1=DeEmbed 1R	2=DeEmbed 2L
			3=DeEmbed 2R		
			4=DeEmbed 3L	5=DeEmbed 3R	6=DeEmbed 4L
			7=DeEmbed 4R		
			8=DeEmbed 5L	9=DeEmbed 5R	10=DeEmbed 6L
			11=DeEmbed 6R		
			12=DeEmbed 7L	13=DeEmbed 7R	14=DeEmbed 8L
			15=DeEmbed 8R		
			16=AES 1L	17=AES 1R	18=AES 2L
			19=AES 2R		
0D79	3449	<RETURN>	0=DeEmbed 1L	1=DeEmbed 1R	2=DeEmbed 2L
			3=DeEmbed 2R		
			4=DeEmbed 3L	5=DeEmbed 3R	6=DeEmbed 4L
			7=DeEmbed 4R		
			8=DeEmbed 5L	9=DeEmbed 5R	10=DeEmbed 6L
			11=DeEmbed 6R		
			12=DeEmbed 7L	13=DeEmbed 7R	14=DeEmbed 8L
			15=DeEmbed 8R		
			16=AES 1L	17=AES 1R	18=AES 2L
			19=AES 2R		
0D7A	3450	<RETURN>	0=DeEmbed 1L	1=DeEmbed 1R	2=DeEmbed 2L
			3=DeEmbed 2R		
			4=DeEmbed 3L	5=DeEmbed 3R	6=DeEmbed 4L
			7=DeEmbed 4R		
			8=DeEmbed 5L	9=DeEmbed 5R	10=DeEmbed 6L
			11=DeEmbed 6R		
			12=DeEmbed 7L	13=DeEmbed 7R	14=DeEmbed 8L
			15=DeEmbed 8R		
			16=AES 1L	17=AES 1R	18=AES 2L
			19=AES 2R		
0D7B	3451	<RETURN>	0=DeEmbed 1L	1=DeEmbed 1R	2=DeEmbed 2L
			3=DeEmbed 2R		
			4=DeEmbed 3L	5=DeEmbed 3R	6=DeEmbed 4L
			7=DeEmbed 4R		
			8=DeEmbed 5L	9=DeEmbed 5R	10=DeEmbed 6L
			11=DeEmbed 6R		
			12=DeEmbed 7L	13=DeEmbed 7R	14=DeEmbed 8L
			15=DeEmbed 8R		
			16=AES 1L	17=AES 1R	18=AES 2L
			19=AES 2R		
0D7C	3452	<RETURN>	0=DeEmbed 1L	1=DeEmbed 1R	2=DeEmbed 2L
			3=DeEmbed 2R		
			4=DeEmbed 3L	5=DeEmbed 3R	6=DeEmbed 4L
			7=DeEmbed 4R		
			8=DeEmbed 5L	9=DeEmbed 5R	10=DeEmbed 6L
			11=DeEmbed 6R		
			12=DeEmbed 7L	13=DeEmbed 7R	14=DeEmbed 8L
			15=DeEmbed 8R		
			16=AES 1L	17=AES 1R	18=AES 2L
			19=AES 2R		

0D7D	3453	<RETURN>	0=DeEmbed 1L	1=DeEmbed 1R	2=DeEmbed 2L
			3=DeEmbed 2R		
			4=DeEmbed 3L	5=DeEmbed 3R	6=DeEmbed 4L
			7=DeEmbed 4R		
			8=DeEmbed 5L	9=DeEmbed 5R	10=DeEmbed 6L
			11=DeEmbed 6R		
			12=DeEmbed 7L	13=DeEmbed 7R	14=DeEmbed 8L
			15=DeEmbed 8R		
			16=AES 1L	17=AES 1R	18=AES 2L
			19=AES 2R		
0D7E	3454	<RETURN>	0=DeEmbed 1L	1=DeEmbed 1R	2=DeEmbed 2L
			3=DeEmbed 2R		
			4=DeEmbed 3L	5=DeEmbed 3R	6=DeEmbed 4L
			7=DeEmbed 4R		
			8=DeEmbed 5L	9=DeEmbed 5R	10=DeEmbed 6L
			11=DeEmbed 6R		
			12=DeEmbed 7L	13=DeEmbed 7R	14=DeEmbed 8L
			15=DeEmbed 8R		
			16=AES 1L	17=AES 1R	18=AES 2L
			19=AES 2R		
0D7F	3455	<RETURN>	0=DeEmbed 1L	1=DeEmbed 1R	2=DeEmbed 2L
			3=DeEmbed 2R		
			4=DeEmbed 3L	5=DeEmbed 3R	6=DeEmbed 4L
			7=DeEmbed 4R		
			8=DeEmbed 5L	9=DeEmbed 5R	10=DeEmbed 6L
			11=DeEmbed 6R		
			12=DeEmbed 7L	13=DeEmbed 7R	14=DeEmbed 8L
			15=DeEmbed 8R		
			16=AES 1L	17=AES 1R	18=AES 2L
			19=AES 2R		
0DC0	3520	<RETURN>	0=DeEmbed 1L	1=DeEmbed 1R	2=DeEmbed 2L
			3=DeEmbed 2R		
			4=DeEmbed 3L	5=DeEmbed 3R	6=DeEmbed 4L
			7=DeEmbed 4R		
			8=DeEmbed 5L	9=DeEmbed 5R	10=DeEmbed 6L
			11=DeEmbed 6R		
			12=DeEmbed 7L	13=DeEmbed 7R	14=DeEmbed 8L
			15=DeEmbed 8R		
			16=AES 1L	17=AES 1R	18=AES 2L
			19=AES 2R		
			20=MIX 1	21=MIX 2	22=MIX 3
			23=MIX 4		
0DC1	3521	<RETURN>	0=DeEmbed 1L	1=DeEmbed 1R	2=DeEmbed 2L
			3=DeEmbed 2R		
			4=DeEmbed 3L	5=DeEmbed 3R	6=DeEmbed 4L
			7=DeEmbed 4R		
			8=DeEmbed 5L	9=DeEmbed 5R	10=DeEmbed 6L
			11=DeEmbed 6R		
			12=DeEmbed 7L	13=DeEmbed 7R	14=DeEmbed 8L
			15=DeEmbed 8R		
			16=AES 1L	17=AES 1R	18=AES 2L
			19=AES 2R		
			20=MIX 1	21=MIX 2	22=MIX 3
			23=MIX 4		
0DC2	3522	<RETURN>	0=DeEmbed 1L	1=DeEmbed 1R	2=DeEmbed 2L
			3=DeEmbed 2R		
			4=DeEmbed 3L	5=DeEmbed 3R	6=DeEmbed 4L
			7=DeEmbed 4R		
			8=DeEmbed 5L	9=DeEmbed 5R	10=DeEmbed 6L
			11=DeEmbed 6R		
			12=DeEmbed 7L	13=DeEmbed 7R	14=DeEmbed 8L
			15=DeEmbed 8R		
			16=AES 1L	17=AES 1R	18=AES 2L
			19=AES 2R		
			20=MIX 1	21=MIX 2	22=MIX 3
			23=MIX 4		
0DC3	3523	<RETURN>	0=DeEmbed 1L	1=DeEmbed 1R	2=DeEmbed 2L
			3=DeEmbed 2R		
			4=DeEmbed 3L	5=DeEmbed 3R	6=DeEmbed 4L
			7=DeEmbed 4R		
			8=DeEmbed 5L	9=DeEmbed 5R	10=DeEmbed 6L
			11=DeEmbed 6R		
			12=DeEmbed 7L	13=DeEmbed 7R	14=DeEmbed 8L
			15=DeEmbed 8R		
			16=AES 1L	17=AES 1R	18=AES 2L
			19=AES 2R		
			20=MIX 1	21=MIX 2	22=MIX 3
			23=MIX 4		

0DC4	3524	<RETURN>	0=DeEmbed 1L	1=DeEmbed 1R	2=DeEmbed 2L
			3=DeEmbed 2R		
			4=DeEmbed 3L	5=DeEmbed 3R	6=DeEmbed 4L
			7=DeEmbed 4R		
			8=DeEmbed 5L	9=DeEmbed 5R	10=DeEmbed 6L
			11=DeEmbed 6R		
			12=DeEmbed 7L	13=DeEmbed 7R	14=DeEmbed 8L
			15=DeEmbed 8R		
			16=AES 1L	17=AES 1R	18=AES 2L
			19=AES 2R		
			20=MIX 1	21=MIX 2	22=MIX 3
			23=MIX 4		
0DC5	3525	<RETURN>	0=DeEmbed 1L	1=DeEmbed 1R	2=DeEmbed 2L
			3=DeEmbed 2R		
			4=DeEmbed 3L	5=DeEmbed 3R	6=DeEmbed 4L
			7=DeEmbed 4R		
			8=DeEmbed 5L	9=DeEmbed 5R	10=DeEmbed 6L
			11=DeEmbed 6R		
			12=DeEmbed 7L	13=DeEmbed 7R	14=DeEmbed 8L
			15=DeEmbed 8R		
			16=AES 1L	17=AES 1R	18=AES 2L
			19=AES 2R		
			20=MIX 1	21=MIX 2	22=MIX 3
			23=MIX 4		
0DC6	3526	<RETURN>	0=DeEmbed 1L	1=DeEmbed 1R	2=DeEmbed 2L
			3=DeEmbed 2R		
			4=DeEmbed 3L	5=DeEmbed 3R	6=DeEmbed 4L
			7=DeEmbed 4R		
			8=DeEmbed 5L	9=DeEmbed 5R	10=DeEmbed 6L
			11=DeEmbed 6R		
			12=DeEmbed 7L	13=DeEmbed 7R	14=DeEmbed 8L
			15=DeEmbed 8R		
			16=AES 1L	17=AES 1R	18=AES 2L
			19=AES 2R		
			20=MIX 1	21=MIX 2	22=MIX 3
			23=MIX 4		
0DC7	3527	<RETURN>	0=DeEmbed 1L	1=DeEmbed 1R	2=DeEmbed 2L
			3=DeEmbed 2R		
			4=DeEmbed 3L	5=DeEmbed 3R	6=DeEmbed 4L
			7=DeEmbed 4R		
			8=DeEmbed 5L	9=DeEmbed 5R	10=DeEmbed 6L
			11=DeEmbed 6R		
			12=DeEmbed 7L	13=DeEmbed 7R	14=DeEmbed 8L
			15=DeEmbed 8R		
			16=AES 1L	17=AES 1R	18=AES 2L
			19=AES 2R		
			20=MIX 1	21=MIX 2	22=MIX 3
			23=MIX 4		
0DD4	3540	Out Active High	clear=0 set=1 (toggle=2)		

RollTrack Audio Delay Tracking

RollTrack is a feature of RollCall™ (Snell & Wilcox's proprietary remote control system), that allows devices to communicate across the RollCall network with no direct user intervention.

RollTrack Audio Delay Tracking enables Snell & Wilcox RollCall™ compatible audio delay products to track delay introduced by RollCall™ compatible video processing products.

The current products that implement RollTrack Audio Delay Tracking are:

Audio Delay Modules	Video Modules	Other Products	
IQBAAD	IQD1FSY	ALCHEMIST	MDD3000
IQBADC	IQDMSDS	CPP100	MDD550
IQBDAC	IQDAFS	CPP200	MDD560
IQBDAD	IQDMSDS	NRS500	MDD570
IQBSYN	IQDMSDP	HD5050	MDD2000
IQBADCD	IQDSYN		

The simplest configuration is a single video unit and a single audio delay in a RollCall™ system. The audio delay will have the same delay as through the video path. If the delay changes the audio delay will track.

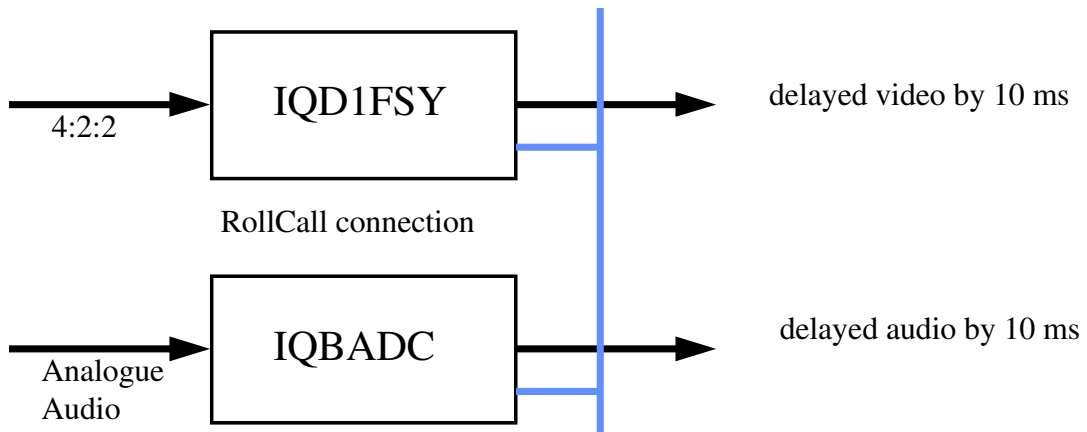

The next level of configuration is where there are multiple Frame Synchronizers (for example) each connected through RollCall™ to their own tracking Audio Delay. (It is worth stating that the synchronizers and audio delays do not have to be in the same enclosure; the addressing scheme, discussed later, allows for the units to be positioned anywhere in the RollCall™ domain.)

The maximum number of video units and audio delays in a RollCall™ system is set by the maximum limit of the number of modules in a RollCall™ network and is currently 3840 on a single network without bridges.

The unique identification of the destination unit (a decimal number) for various modules is as follows:

Module	ID
IQBADC	51
IQBDAC	52
IQBAAD	53
IQBDAD	54
IQBSYN	89
IQBADCD	107

The next level of complexity is a *vertical delay cluster* where a video unit can have up to eight audio delays tracking - of the same or different types.

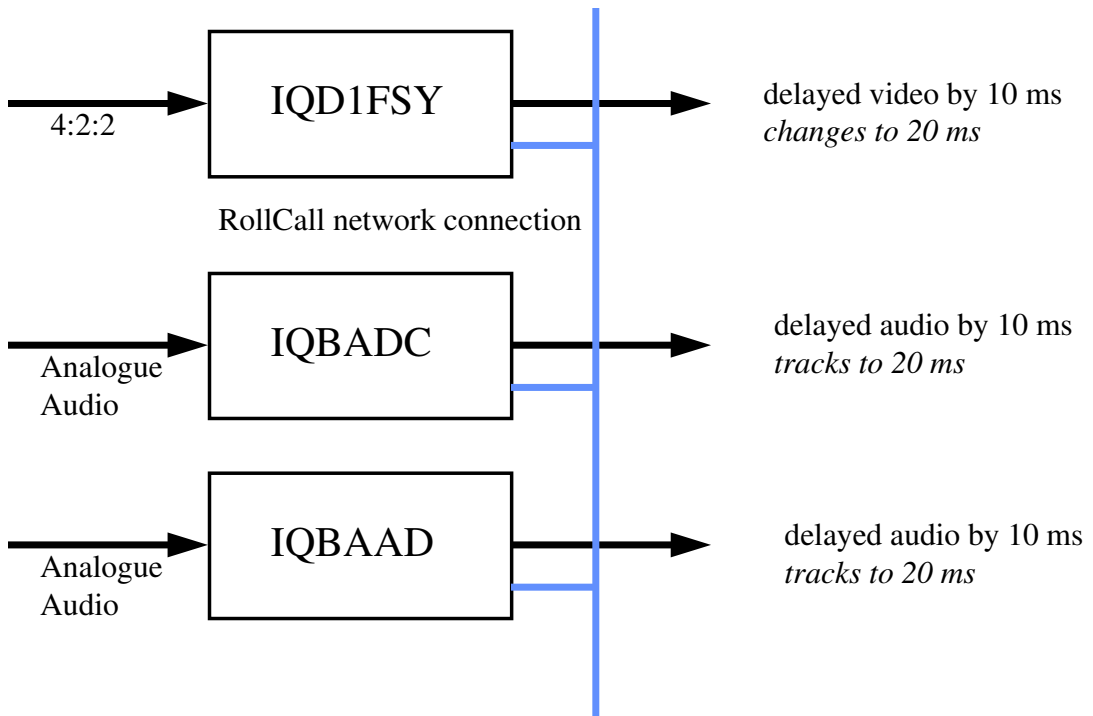

From one to eight audio delay products can be connected via RollCall™ to a single frame synchronizer, for example. If the synchronizer delay changes, then however many audio delays are connected will track the delay. The audio delays can also have a manual delay which will be added to the RollTrack delay.

The next level of complexity is a *horizontal delay cluster* where an audio delay can track up to four video units.

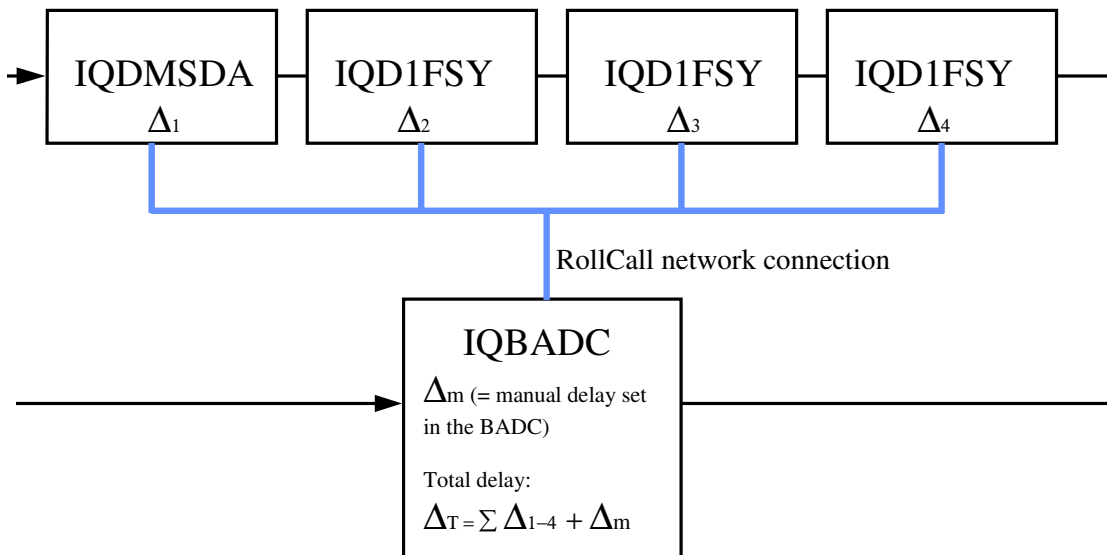

The total delay time through the audio delay is then the sum of the individual delays introduced by the video units plus the manual delay of the audio unit. The manual delay can be set to compensate for any fixed propagation delay in the video path or may be set to zero.

The next level of complexity is a *matrix delay cluster* where each audio delay (up to eight) can track up to four video units. This configuration is in effect a four by eight matrix of video units and audio delay units. The total delay time through the audio delay units is then the sum of the individual delays introduced by the video units plus the manual delay of the audio unit.

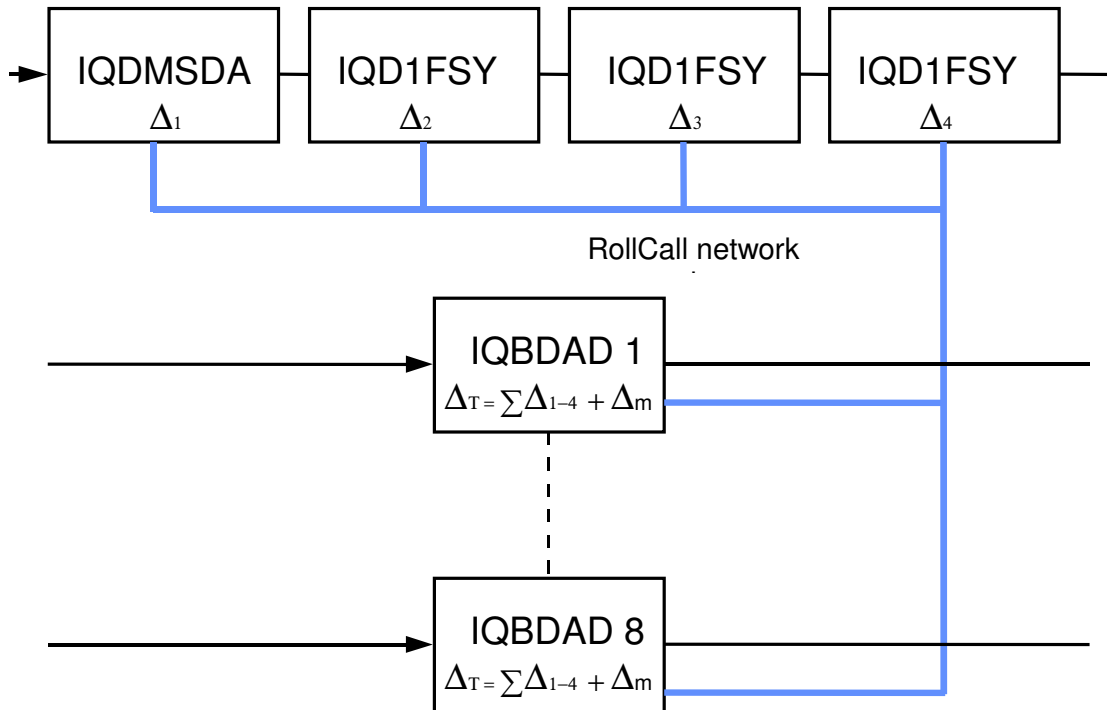

As any of the delay times change in the video path so will the audio delay time track this delay. A virtual connection is made between from, say, an IQD1FSY to an IQBDAD by:

selecting the *Setup...* Menu of the IQD1FSY
 then selecting the *Audio_Delay...* Menu
 then choosing from *Unit_1* to *Unit_8*
 then entering the unique network address of the IQBDAD in the form $nnnn:xx:yy*z*d$
 where $nnnn$ = network address and in most cases will be 0000(hex);
 xx = IQ enclosure address (hex);
 yy = slot address of the IQBDAD (hex)
 z = the connection (or channel) number (decimal) - see table below.
 d = the unique identification of the destination unit (decimal) The ID entered must match the receiving units own ID or else the command will be ignored. If the ID value is set to 00, the receiving unit does not perform an ID match and will always accept the incoming command
 then selecting the *Delay...* Menu of the IQBDAD
 then selecting *RollTrack*

Example of Network Addresses with Channel Numbers and ID Numbers

	D1FSY 1	D1FSY 2	D1FSY 3	D1FSY 4
Audio delay 1	0000:10:01*14*54	0000:10:01*15*54	0000:10:01*16*54	0000:10:01*17*54
Audio delay 2	0000:10:03*14*54	0000:10:03*15*54	0000:10:03*16*54	0000:10:03*17*54
Audio delay 3	0000:10:05*14*54	0000:10:05*15*54	0000:10:05*16*54	0000:10:05*17*54
Audio delay 4	0000:10:07*14*54	0000:10:07*15*54	0000:10:07*16*54	0000:10:07*17*54
Audio delay 5	0000:10:09*14*54	0000:10:09*15*54	0000:10:09*16*54	0000:10:09*17*54
Audio delay 6	0000:10:0B*14*54	0000:10:0B*15*54	0000:10:0B*16*54	0000:10:0B*17*54
Audio delay 7	0000:10:0D*14*54	0000:10:0D*15*54	0000:10:0D*16*54	0000:10:0D*17*54
Audio delay 8	0000:10:0F*14*54	0000:10:0F*15*54	0000:10:0F*16*54	0000:10:0F*17*54

The most complex system would be an array of matrix delay clusters

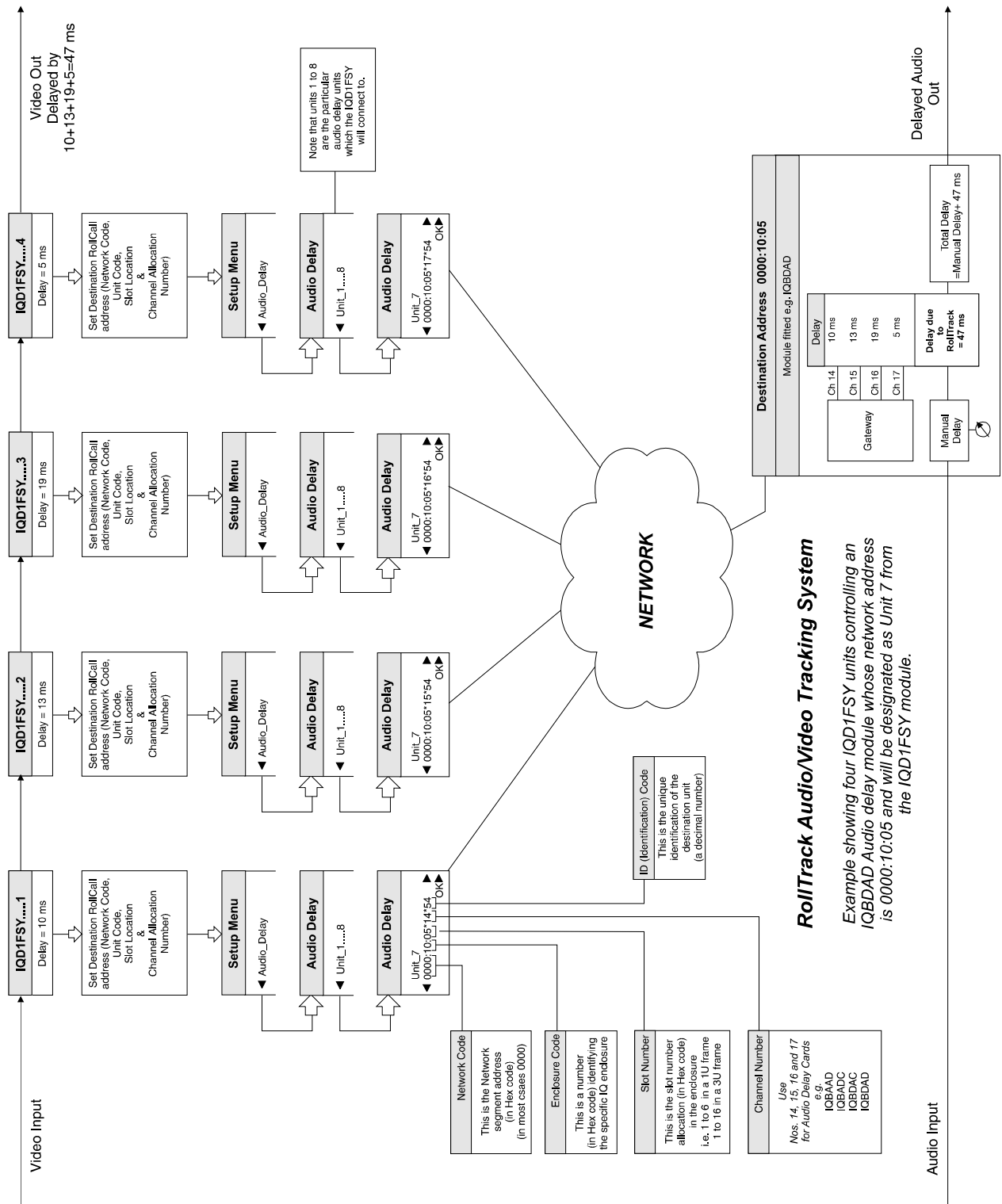

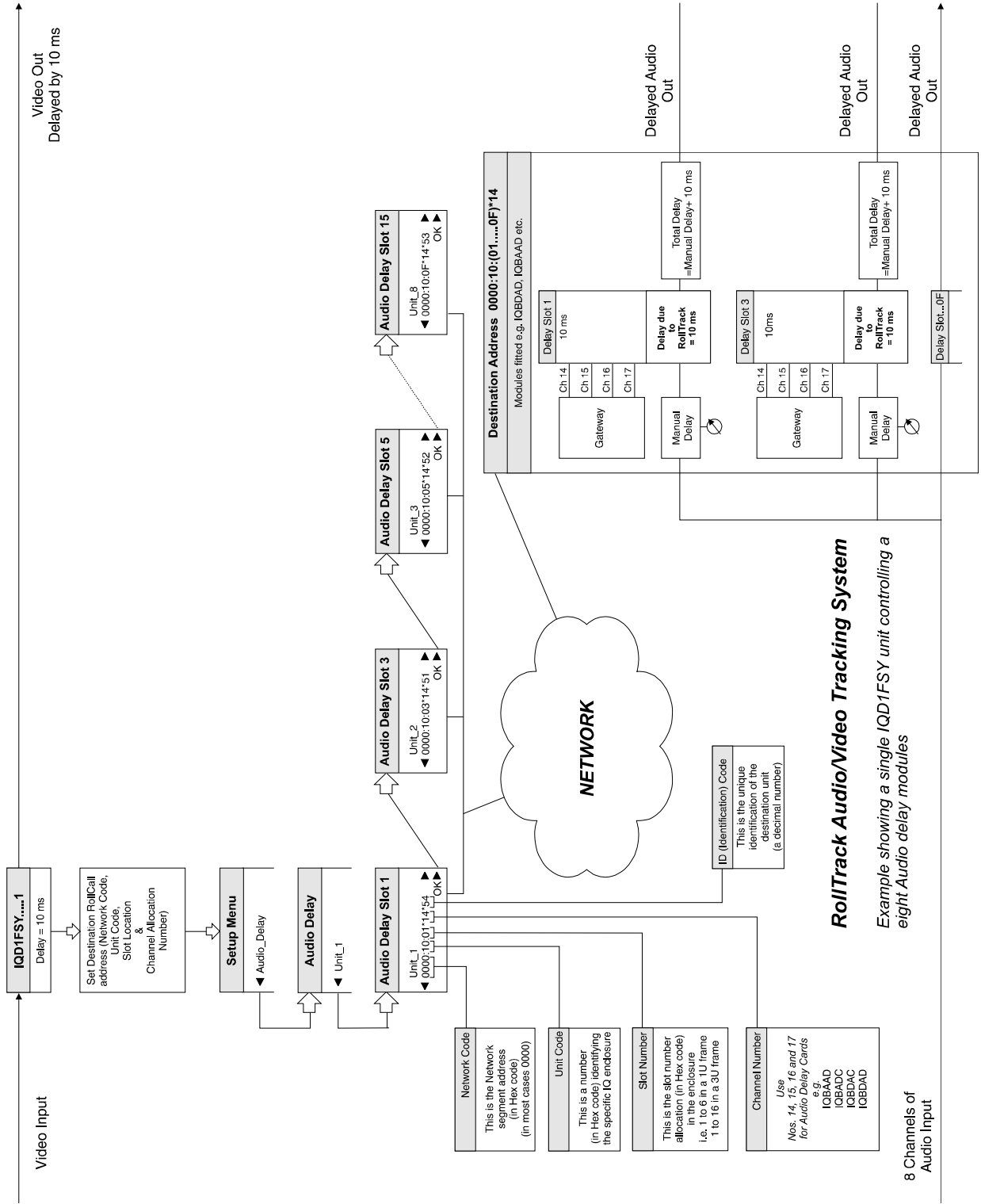

Appendix 1

The Firewall

What is the function of a firewall?

The firewall protects a digital signal output against propagation of errors or disruptions in the input signal. It ensures that the signal stream at that output is continuously valid no matter what happens at the input. If the input suffers any dropout, loss of data, or break or discontinuity in the carrier then this will not be reflected in the output. Default valid data will be used to pad the output stream such as video black, a freeze, or audio silence.

The firewall does not ensure the pictures or the audio is what you want to see or hear of course, a corrupted signal can lead to loss of original content. It will ensure that whatever valid content you have it will get through however. In short it ensures the integrity, not the content, of the digital stream.

How a firewall equipped product behaves

The essential behavior of a system containing a firewall is that:

The input to the unit containing the firewall can be removed and later replaced with another signal and during this sequence the unit following the one with the firewall will see no disturbance at its input.

Why use a firewall?

Any equipment downstream of a Snell & Wilcox product with firewall protection can expect to be fed with a continuous input stream. Dropouts in the signal, disturbances due to switching and errors in the composition of the signal will not penetrate the firewall and will therefore not corrupt operations downstream. The examples below illustrate where firewalls are of most benefit.

At the beginning of a chain

They are excellent for use at the beginning of a chain. Traditionally a damaged signal would be passed by all equipment in a chain. This meant that each unit would lose lock on the digital signal it was passing. The damage in the signal would immediately appear at the input to every device all the way through to the last point in the chain. When the signal was restored, each unit in the chain might take a few seconds to recover. The next unit would not start recovery until the previous unit had locked to the signal again. The effect could be a huge delay in restoring the signal by the end of the chain as each unit recovered one by one. A minor flaw in the input signal such as a tiny break in the carrier could lead to several seconds of disruption on the output.

To protect MPEG encoders

Many people have found to their regret that MPEG encoders do not survive a break in the integrity of their input signal. They often corrupt their output and take a long time to recover. Video synchronizers can help but they only protect the video. Loss of the audio would prove terminal even though the integrity of the video was maintained. For transmission encoders this could mean a break in the output. For recording encoders such as those in a video server this often meant the recording was lost. Placing a Snell & Wilcox firewall product in front of any such encoders will ensure that they never get disrupted in this way even though there may be a break in the incoming content.

How a firewall is tested

A variety of equipment is used to test the firewall behavior. The test consists of analyzing the data downstream of the firewall product looking for discontinuities in the signal stream. While it is intended that all products fed by a firewall equipped unit will accept the signal as uninterrupted, it is accepted that there is a wide variety of real-world performances. Therefore the reference product used to test whether the output streams are continuous is the Snell & Wilcox IQMUX01 for both AES and SDI signals.

Performance of firewall equipped products versus genlock mode

The tables below summarize the behavior of products for different genlock modes:

Synchronizer Mode			
	Referenced	Input locked	Free run
SDI Video	<i>Firewall</i>	<i>No firewall</i>	<i>Firewall</i>
AES	<i>Firewall</i>	<i>Firewall</i>	<i>Firewall</i>

When Firewall Protection is not provided

Video

The firewall protects against disruption or illegal signals at the input and not against corrupt or illegal reference provision. The user should also note that when changing genlock mode, the firewall is not maintained for the video output during the change. Examples would include changing from free-running mode to referenced mode or when the reference is adjusted or interrupted.

Embedded audio

Embedded audio firewall protection follows the video behavior. When the video is protected then the embedded audio is also protected. See all the information relating to video firewall protection.

AES Audio

AES outputs will generally always maintain a firewall with the exceptions noted below. Unlike the video signal, most reference changes do not disrupt the AES firewall.

Exceptions

AES outputs on audio products will normally maintain a firewall for PCM audio except when switching to or from AES1 as a reference.

Only PCM signals are protected by the firewall. The non-PCM direct paths for audio do not have firewall protection.

Appendix 2

HANC Control

Hanc Blanking Control.

When “Hanc Blank” is enabled the HANC space is cleared of all incoming packets. In this case the non-PCM and non-audio data is removed. If pass HANC control is disabled then the incoming non-audio packets are inserted following the packets created by this unit. Bypassing will leave all non-audio packets intact. Any audio group that is to be embedded; will remove any packet from the incoming stream from the same group.

HANC Overflow Condition

The card assumes that the incoming HANC is SMTE291 compliant. If there is data embedded in the HANC space that is non-compliant then that would be outside of the capabilities of the unit to handle.

Alternate HANC Packet Specification

Only audio packet types are validated and with the exception of packets that are of the “Marked for deletion” type, all packets are passed as they are.

“Marked for deletion packets” are removed if they can be while maintaining continuity. Checksum calculation is done on generated packets but not on passed through packets.

If an audio packet has gone through the bypass process then the packet is not changed. If the audio has been processed and embedded then packet parity is calculated for the generated packets.

If pre-existing embedded audio is not valid due to not having enough samples then in bypass mode the same data is passed to the output. If this type of broken input is extracted then the unit will try to rate convert (SRC) to the correct 48kHz sample rate. The SRC'd drops or holds will be more or less audible depending on how broken the incoming audio packets are.

Recognize Audio Data Packet Identifiers

Recognize:(DID)

2FF	1FD	1FB	2F9	Audio Group
1FE	2FC	2FA	1F8	Extended Audio
1EF	2EE	2ED	1EC	Control Packet

Manual Revision Record

Date	Version No.	Issue No.	Change	Comments
09-Aug-06	1	1		First issue released