

System HD Dual Channel Multi-Rate Optical Receiver Operation Manual

CONTENTS

INTRODUCTION TO THIS OPERATION MANUAL.....	2
SCOPE OF THIS OPERATION MANUAL	4
MODULE DESCRIPTION	4
FEATURES.....	6
TECHNICAL PROFILE.....	7
INPUTS CHANNELS 1 AND 2.....	7
OUTPUTS CHANNELS 1 AND 2.....	7
SWITCHES, BOARD EDGE	7
INDICATOR LEDs	7
ROLLCALL™	7
OPTIONS.....	7
REAR INTERFACE CONNECTIONS.....	9
REAR INTERFACE NOTATION GUIDE.....	9
STANDARD RECEIVER INPUTS.....	10
WDM OPTICAL HD-SDI INPUT	10
STANDARD AND WDM RECEIVER OUTPUTS.....	11
ROLLCALL MENU SYSTEM	12
ROLLCALL MONITORING FEATURES.....	13

Introduction to this Operation Manual

This manual covers the operation and use of the modules described below.

WARNING...

THE FRONT PANEL OF THE UNIT MUST NOT BE OPENED BY THE OPERATOR. ACCESS IS ONLY PERMITTED TO FULLY QUALIFIED INSTALLATION ENGINEERS.

System HD Modules must only be installed and/or replaced by qualified service personnel, with reference to the System HD Installation guide. Refer all installation and servicing to qualified personnel only.

All laser transmitters used in this product are Class 1 in accordance with EN60825-1 as well as 21CFR 1040.10 and 1040.11

**Class 1
Laser Product**

1. Laser light can be damaging to the eyes. Optical fibres and Uniteres should be handled with great care.
2. System HD Modules which incorporate Fibre Optic elements, are designed for use with Class 1 laser systems only. Ensure that all inputs do NOT exceed Class 1 as doing so will impair the safety of the system and may result in damage to the equipment.
3. Active fibres should not be handled unless their source can be positively identified as not exceeding Class 1 limits.

Manufacturers Notice

Copyright protection claimed includes all forms and matters of copyrightable material and information now allowed by statutory or judicial law or hereinafter granted, including without limitation, material generated from the software programs which are displayed on the screen such as icons, screen display looks etc.

Reproduction or disassembly of embedded computer programs or algorithms is prohibited.

No part of this publication may be transmitted or reproduced in any form or by any means, electronic or mechanical, including photocopy, recording or any information storage and retrieval system, without permission being granted, in writing, by the publishers or their authorised agents.

Important Notice

No responsibility is taken by the manufacturer or supplier for any non-compliance to EMC standards due to incorrect installation.

Information in this manual and software are subject to change without notice and does not represent a commitment on the part of Snell & Wilcox Ltd. The software described in this manual is furnished under a licence agreement and may not be reproduced or copied in any manner without prior agreement with Snell & Wilcox Ltd. or their authorised agents.

Scope of this Operation Manual

This is the operation manual for the System HD Fibre Optic Receiver module. It covers the modules ordered under the following codes:

- SHDFRM2WWR4** – Standard Dual Input Receiver with 4 electrical outputs from each
- SHDFRM2WWR A** – Single WDM Receiver gives 2 channels each with 4 electrical outputs
- SHDFRM2WWR B** – Single WDM Receiver gives 2 channels each with 4 electrical outputs

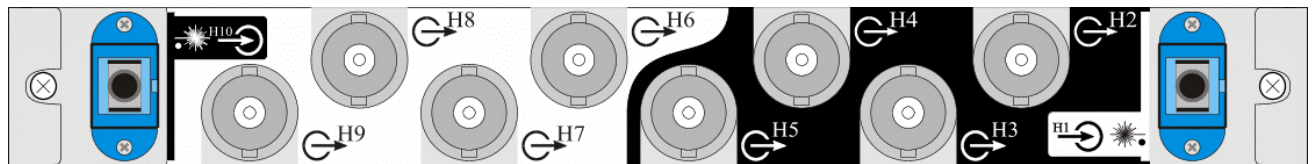

SHDFRM2WWR4 Dual 4-Output Receiver, Rear Panel View

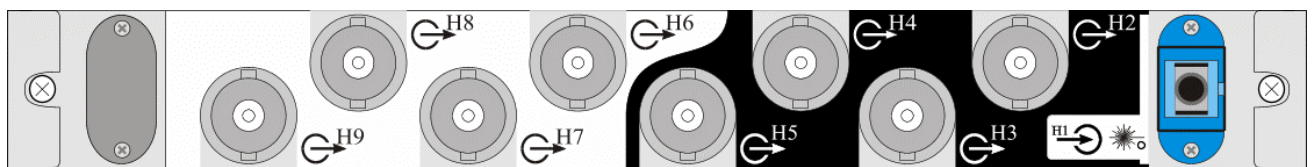

SHDFRM2WWR A and SHDFRM2WWR B WDM Receivers, Rear Panel View

MODULE DESCRIPTION

The Dual Channel Optical Receiver receives two independent optical serial digital bitstreams. Each channel can receive either a single optical high-definition serial digital (HD-SDI / SMPTE 292M) or a single optical standard-definition serial digital (SD-SDI / SMPTE 259M) bitstream and provides four identical electrical HDSDI or SDSDI outputs from each channel.

The inputs are via the SMPTE 292M recommended SC/PC singlemode fibre optic connectors situated on a rear panel interface board. The SC/PC connector is robust and easy to use, a simple snap-fit into the backplane uniter enables a reliable connection to be made in a matter of seconds. The electrical outputs are via eight 75Ω BNC connectors.

Each SDI input signal is fed from the interface board into an optical receiver on the main board which converts the optical signal back into the electrical domain. This electrical SDI signal output is then amplified and reclocked before being split to provide four identical coaxial SDI outputs for the user on the backpanel of the interface board. (Note: In Async mode the signal is only amplified.) When used in conjunction with the Optical Transmitter boards (and depending on the fibre interconnect used) the sensitivity of the optical receiver is sufficient to recover a signal transmitted from up to 20km away.

LEDs mounted at the front of the main board allow monitoring of the receiver performance. More detailed performance information can be obtained via the RollCall interface.

Two rear panel interface board options can be used in conjunction with the dual channel receiver main board. A 'standard' board accepting two optical signals in the wavelength range 1200-1600nm and a 'WDM filter' option. The WDM interface board incorporates an inline optical filter which will allow two wavelengths (1310/1550nm) combined on a single fibre to be received. The WDM filter splits the two input carriers and routes the 1310nm signal to one receiver and the 1550nm signal to the other receiver.

WARNING...

THE FRONT PANEL OF THE UNIT MUST NOT BE OPENED BY THE OPERATOR. ACCESS IS ONLY PERMITTED TO FULLY QUALIFIED INSTALLATION ENGINEERS.

Quick guide to order codes:

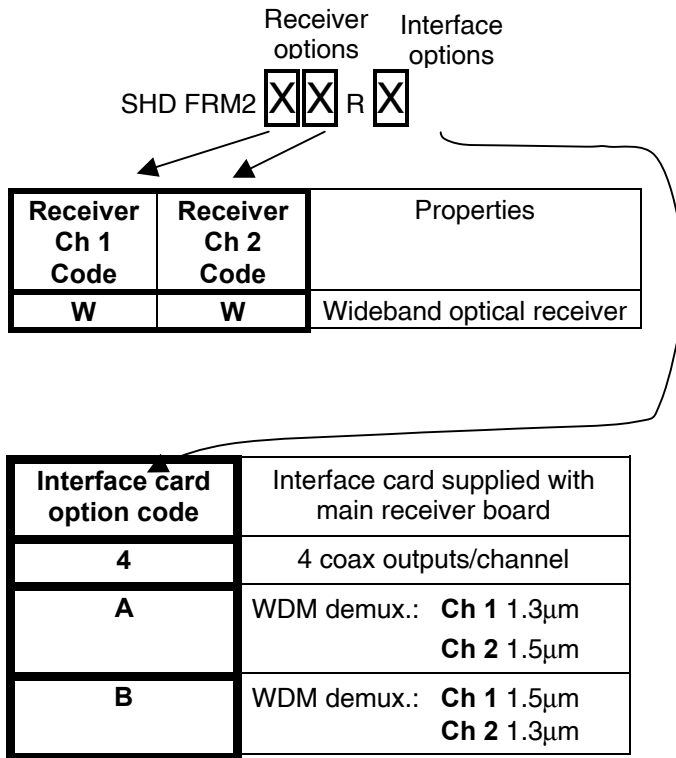

Codes other than those listed refer to custom laser options.

Features

- Dual Channel capability
- SMPTE 292M 1.485Gbit/s HD-SDI data rate supported
- SMPTE 259M 270Mbit/s SD-SDI data rate supported
- Async mode of operation. For use with D2, DVB-ASI, MPEG streams, AES-EBU, etc.
- SMPTE 292M recommended SC/PC singlemode user interface connector
- Four coaxial outputs from each of two optical inputs
- Recovery after distances up to 20km
- Wavelength input range of 1200nm to 1600nm
- Redundant channel capability for critical routing applications
- Wavelength division multiplexing (WDM) supported (optional)
- Bit error rate (BER) <10⁻¹²
- Optical data transport offering:
 - EMI immunity
 - No earth loops
 - Small, lightweight, flexible cabling
 - Easy to locate and repair cable breaks
- Alarm functions for poor quality input signals and device malfunction
- Stand-alone or RollCall™ operation
- Incoming signal analysis available as an option, it includes:
 - CRC status
 - Line standard
 - Frame rate
 - Error rate

Note:

RollCall™ enabled for remote system control & monitoring.

In Async mode some SDI outputs may not be compatible with certain equipment due to the use of complimentary outputs. E.g. Some ASI streams are not inversion compatible.

Technical Profile

INPUTS, Channels 1 and 2

Optical	1.485Gbit/s HD-SDI 270Mbit/s SD-SDI
Connector Format	SC/PC singlemode panel uniter
Input wavelength range	Min. 1200nm Max.1600nm
Optical power input range	< -3dBm > -23dBm
Detector damage threshold	+10dBm

OUTPUTS, Channels 1 and 2

Electrical	1.485Gbit/s HD-SDI 270Mbit/s SD-SDI
Connector Format	BNC 75ohm panel jack
Outputs	4
Output Cable Length	>100m
Peak-to-peak signal amplitude	800mV \pm 10%
D.C. offset	0V \pm 0.5V
Rise time (20-80%)	< 270ps
Fall time (20-80%)	< 270ps
Difference	\leq 100ps
Return loss	> 15dBm

SWITCHES, Board Edge

Rx1 to Rx2	Force the output of channel 2 to be the same as the channel 1 output
Rx1	HD/SD mode select
Rx2	HD/SD mode select
Enable mux	Enable the 'changeover' function

INDICATOR LEDS

Power	Power supplies valid
Fault	Board fault
CPU	Valid CPU activity
SD Rate mode	Rx1 and Rx2
Mux on	'Changeover' enabled. The channel 2 output will switch to channel 1 content when the 'changeover' function is activated
Rx1	The output of channel 2 is the same as the output of
Rx2	

channel 1

For both data channels

P _{in}	Input of sufficient power present
PLL lock	Output locked to input standard
CRC Error	Data error
Line	Indicates line standard
Frame	Indicates frame rate
Prog/Int	Indicates progressive or interlaced frames

RollCall™

RollCall control options:	Force the output of channel 2 to be the same as the channel 1 output Enable the 'changeover' function
Rate Selection	HD / SD / Async
RollCall monitoring options:	General alarm Supply voltage levels Board temperature

For both data channels

CRC status
Line standard
Frame rate
Error rate

POWER CODE 2

WEIGHT <820gm (Main Board plus Interface Board)

OPTIONS See page 5 for options

**Notes...**

1. Each dual receiver board has two wideband optical receiver devices, one for each channel. Each of these receivers can be used to recover wavelengths in the range 1.2-1.6 μm so can be used for WDM applications without any device modification. However, a suitable interface card must be used.
2. A 'standard' interface card for a dual receiver board will provide four coax outputs for each of the two separate optical inputs. If the 'WDM' option is fitted, only one optical input is used as the incoming optical signal contains both wavelengths combined together. The two wavelengths are then split in the WDM demux and routed to the appropriate receiver where four coax outputs per wavelength are then available. Refer to the interface card option code on page 4 to identify what interface card has been supplied with the main receiver board.
3. Codes in the ORDER NUMBER other than those listed on page 5 will refer to custom interface card options. Additional information should have been delivered with the cards. If further information is required please contact the factory.

Rear Interface Connections

Rear Interface Notation Guide

Electrical SDI Output

A Serial Digital electrical output through a 75Ω BNC connector is denoted in the way shown opposite. The “ H ” denotes the High Definition capable element and the “ n ” is the connection number for that particular rear interface.

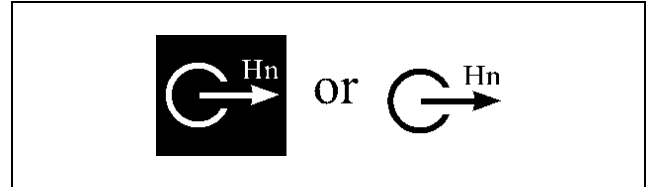

Optical SDI Input

A Serial Digital optical input through a SC/PC single mode panel uniter is denoted in the way shown opposite. The “ H ” denotes the High Definition capable element and the “ n ” is the connection number for that particular rear interface. The solid “dot” indicates that only a single wavelength can be presented through the connector. A hollow circle indicates multiple wavelengths are permissible.

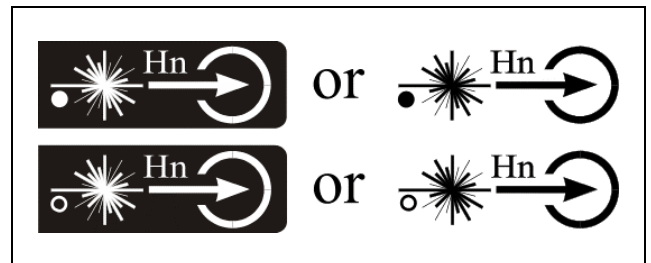

Standard Receiver Inputs

Optical SDI Inputs

Used On : SHDFRM2WWR4

The serial digital optical inputs are connected to SC/PC single mode panel uniters. This connector is shown opposite and is labelled **H1** and **H10** on the rear panel. This is a single optical wavelength interface in these cases.

1. **Laser light can be damaging to the eyes. Optical fibres and Uniters should be handled with great care.**
2. **System HD Modules which incorporate Fibre Optic elements, are designed for use with Class 1 laser systems only. Ensure that all inputs do NOT exceed Class 1 as doing so will impair the safety of the system and may result in damage to the equipment.**
3. **Active fibres should not be handled unless their source can be positively identified as not exceeding Class 1 limits.**

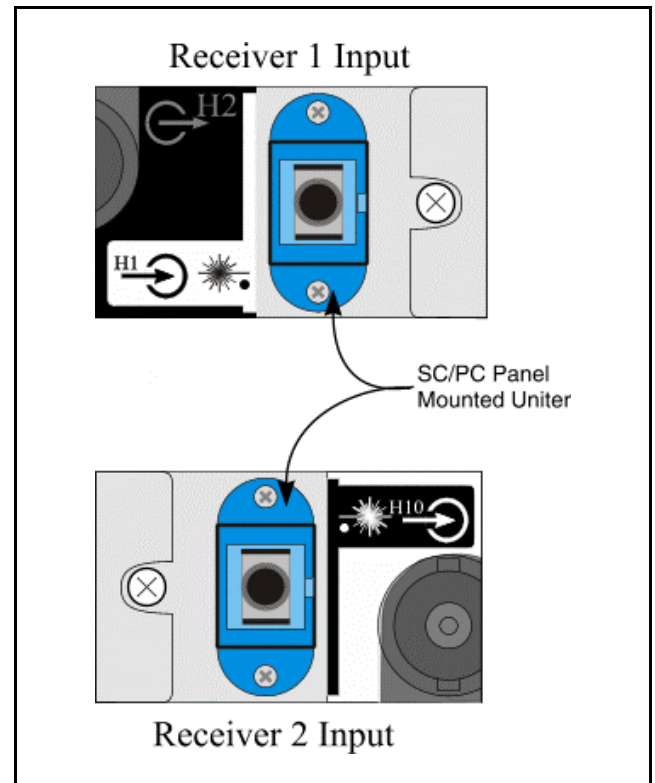

WDM Optical SDI Input

Used On : SHDFRM2WWRA
SHDFRM2WWRB

The serial digital optical input with 2 WDM channels is connected to a SC/PC single mode panel uniter. This connector is shown opposite and is labelled **H1** on the rear panel. This is a dual optical wavelength interface in these cases.

Notes...

1. Optical uniters have plastic covers to prevent the ingress of dust. These covers should only be removed when connecting optical fibres. A uniter should never be left open without a cover or a fibre connector
2. The ends of optical fibres should be cleaned with a liquid fibre cleaner, using a cotton bud, to ensure that there is no dust present, before they are plugged in (the uniter is polarised).
3. Observe the warning about not viewing live optical sources.

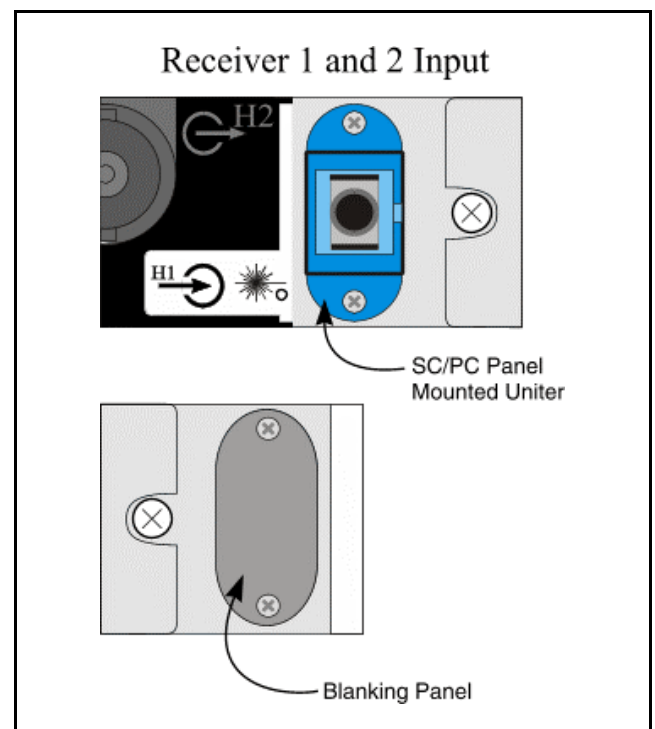

Standard and WDM Receiver Outputs

Electrical SDI : Dual Quad Outputs

Used On: **SHDFRM2WWR4**
SHDFRM2WWRA
SHDFRM2WWRB

The four serial digital electrical outputs are available from four 75Ω BNC connectors for each channel. The same digital bitstream is provided by all four connectors. This bitstream is a reclocked version of the optical signal provided to the optical receiver. (Note: In Async mode the bitstream is not reclocked.) These electrical outputs are labelled as **H2, H3, H4, and H5** for receiver 1 and **H6, H7, H8, and H9** for receiver 2. The annotations on the rear panel are illustrated in the diagram opposite.

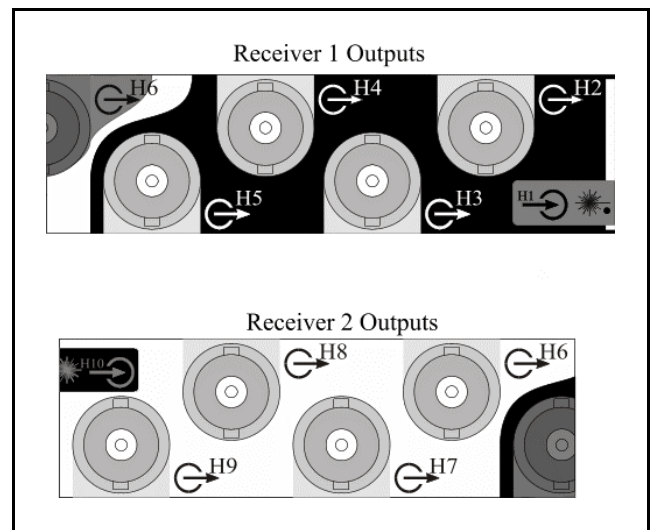

Rollcall Menu System

When a System HD Control and Monitor board is fitted in the enclosure a range of monitoring information is available to RollCall™

External Monitoring	Description
General alarm	Input power fault or overcurrent trip or system failure
Supply voltage levels	Actual voltage levels
Board temperature	Actual board temperature
<i>For Both Data Channels</i>	
Bit error rate	Error rate over defined time period

Rollcall Monitoring Features

- Module Infrastructure:
 - General Alarm
 - Supply Voltage Levels
 - Board Temperature
- Incoming Signal analysis:
 - Input Status
 - Line Standard
 - Frame Type
 - Frame Rate
- CRC Error analysis:
 - CRC Error Count
 - CRC Error Total
 - CRC Reset
- Rate Sel:
 - HD – HD-SDI Reclocking mode.
 - SD – SD-SDI Reclocking mode.
 - Async – Asynchronous mode.
- Received Laser Power (dBm) – This is the amount of Laser power being received. It indicates how much attenuation has been applied to the signal.
- Channel Changeover - The 'changeover' option allows the output of optical receiver 1 to be routed to the reclocker on channel 2 providing a simple signal routing capability or the ability to provide a redundant signal path for critical signals. The table shows the various options available to the user to enable the changeover function and then facilitate the actual routing of the channel 1 signal to the channel 2 outputs. The 'changeover' function can be 'enabled' via manual **or** remote control switches. Note: The manual control switches are the overall master controls for this function.

User options for the Changeover function

Control for changeover function to be activated	Command source to route Rx 1 output to Rx 2 reclocker
Manual card edge switch	Manual card edge switch
Remote via RollCall	Remote via RollCall
	Automatically on low light detect from Rx 2

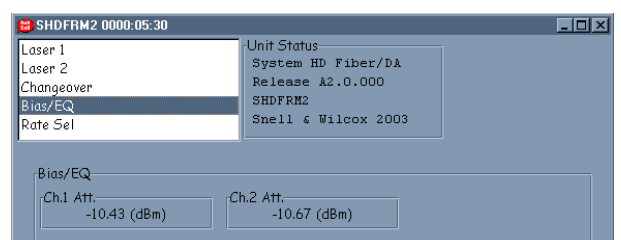
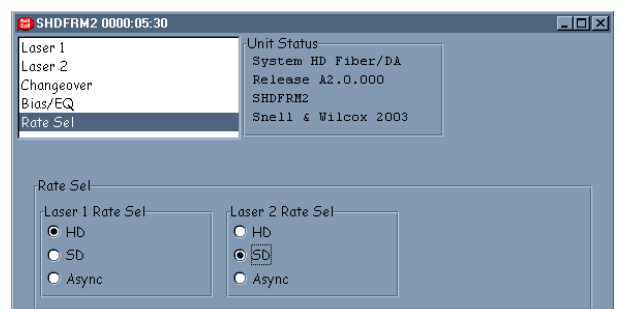
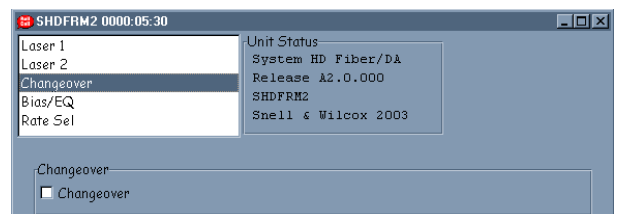
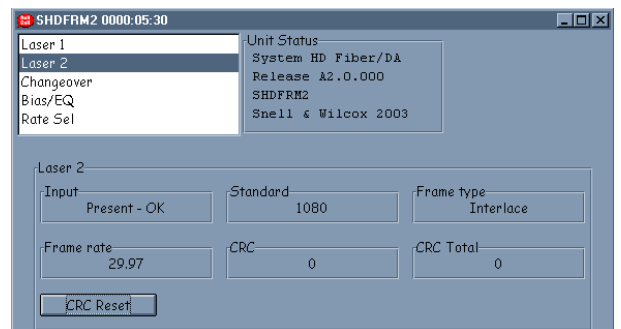
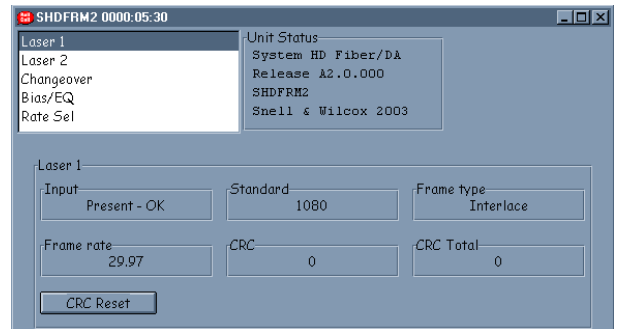

Manual Revision Record

Date	Version No.	Issue No.	Change	Comments
180203	1	1		First issue released