



V6416

HD Up Down Cross ARC Converter

User Guide

Issue: 1.0

www.snellgroup.com



Contents

1	Description	5
2	Installation	6
2.1	Assembly	6
2.2	Connections	7
2.2.1	Video Connections	7
2.2.2	Flash Memory Card	8
3	System Operation	9
3.1	Local Control	9
3.1.1	Start Up	9
3.1.2	Menu Control	10
3.1.3	Menu Examples	10
3.1.4	Sleep	11
3.2	Core Product Features	11
3.2.1	SDI Inputs	11
3.2.2	SDI Reclocked & Buffered Output	11
3.2.3	SDI Main Outputs	11
3.2.4	Video Reference	12
3.2.5	Standard Detection	12
3.2.6	TRS Signals	12
3.2.7	EDH (SD operation only)	12
3.2.8	Illegal Codes	13
3.2.9	VCO Centre Frequency	13
3.2.10	Version Numbers	13
3.2.11	Display Sleep	14
3.2.12	Display Brightness	14
3.3	Output Format and Aspect Ratios	15
3.3.1	Output Line and Frame Rate	15
3.3.2	Up-Conversion	15
3.3.3	Down Conversion	16
3.3.4	SD Aspect Ratio Conversion	17
3.3.5	Conversion mode: Manual or automatic (AFD)	18
3.3.6	SD Width Control	19
3.3.7	Down Conversion Resolution Controls	19

V6416 Up Down Cross Converter



3.4	Active Format Description (AFD) Control Facilities	20
3.4.1	General	20
3.4.2	AFD Insertion	21
3.4.3	AFD Line	21
3.4.4	Standard Definition Output Service: 4:3 or 16:9	21
3.4.5	AFD Flag Missing on Input : LostFlag Control	22
3.4.6	AFD override facility: AFD Mode Control	23
3.4.7	AFD Flag Missing On Input: Default Flag (SD inputs)	24
3.4.8	AFD Flag Missing On Input: Default Flag (HD inputs)	24
3.4.9	AFD Flag Override: Force Flag (SD inputs)	25
3.4.10	AFD Flag Override: Force Flag (HD inputs)	25
3.5	Output Timing, Reference and Frame Synchroniser	26
3.5.1	Timing & Delay Control	26
3.5.2	Delay Pulse	29
3.5.3	Video Reference Fail	29
3.5.4	Video Reference Mismatch	30
3.6	Video Processing Amplifier	30
3.6.1	Video Gain	30
3.6.2	Chroma Gain	30
3.6.3	Black Level	30
3.6.4	Hue Shift	30
3.6.5	Dynamic Rounding	31
3.6.6	Limiting	31
3.6.7	Fade to Black	31
3.7	Time Code and Source Identification	32
3.7.1	General	32
3.7.2	Time code and source ID reader interfaces block	33
3.7.3	Time code generator interfaces block	34
3.7.4	Time code and source ID inserter interfaces block	34
4	Calibration	37
4.1	Set-Up	37
4.2	Free-Run Frequency	38



V6416 Up Down Cross Converter

5	Controls	39
5.1	Video Processing – VIDEO	39
5.2	Active Format Description – AFD	40
5.3	Video Proc Amp – PROC AMP	41
5.4	Audio Control - AUDIO	42
5.5	Timing Adjustments - TIMING	43
5.6	Auxiliary Data – AUX DATA	44
5.7	System Status – STATUS	45
5.8	Engineering Menu – ENG'ING	46
5.9	Calibration Menu – CALIB	46
5.10	Configuration Menu – CONFIG	47
5.11	System Version Information – VERSION	47
6	Appendix	48
6.1	Trouble Shooting Guide (Frequently Asked Questions)	48
6.2	Initialisation, Power On-Selftest & Error Messages	49
6.2.1	Board Initialisation Sequence	49
6.3	Automatic (AFD controlled) Conversion Functions	50
6.4	Menu Structure	52



1 Description

The V6416 is a high quality conversion unit for translating between HD standards, up and down converting between HD and SD formats and performing aspect ratio conversion on SD signals in a broadcast installation. It uses 3 field adaptive signal processing techniques to achieve a very high quality of video when converting between standards.

The V6416 is part of the Vistek V1600 range of modular products. The unit requires a V6991 fan card adjacent to it to maintain the necessary temperature operating range, so the V6416 occupies two slots in the standard Vistek V1606 Frame.

Embedded audio is passed through the unit delayed appropriately. The unit is designed be transparent to Dolby E. If the frame synchroniser has to drop or repeat a video frame, a complete Dolby E frame will be dropped or repeated in accordance, providing the data stream is within the correct guard band relative to the SMPTE168 switching line.

Many other forms of auxiliary data, such as AFD, Closed Captions, Source Identification and Time Code are handled by the unit and processed accordingly.

2 Installation

2.1 Assembly

The V6416 normally occupies two slots in the V1606 Frame

They modules should be mounted into the rack as shown below:

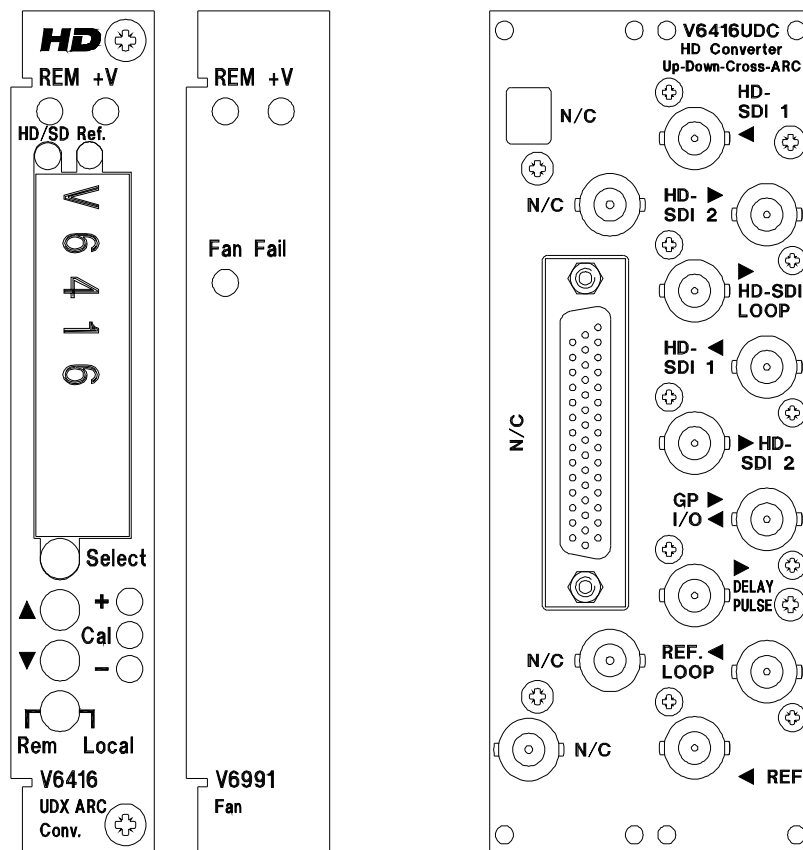

The rear module must be fitted before any of the main modules can be inserted.

For normal operation it is important that the fan module, V6991, is fitted. However for short periods, say up to about 5 minutes in a normal working environment the V6416 can be operated without the fan. This could be useful in the case of the fan being replaced during maintenance.

V6416 Up Down Cross Converter



As with all V1606 Modular Frame installations the modules should be distributed evenly across the fourteen available slots to satisfy the cooling requirements. If there are spaces in the frame then they should generally be on the left, when viewed from the front, and not on the right near the Power Supplies.

2.2 Connections

2.2.1 Video Connections

This table describes the video connections labelled under V6416. The connections on the rear panel marked N/C are unused on this module, and should not be connected.

Connector	Type	Function
▶ HD-SDI 1	BNC	Serial Digital Video Input 1. Can be either SD or HD.
▶ HD-SDI 2	BNC	Serial Digital Video Input 2. Can be either SD or HD.
◀ HD-SDI LOOP	BNC	Serial Digital Video Output from selected Input. Can be either SD or HD. It is buffered and Reclocked from the input, but is not converted. Can be either SD or HD
◀ HD-SDI 1	BNC	Serial Digital Video Main Output 1. Can be either SD or HD.
◀ HD-SDI 2	BNC	Serial Digital Video Main Output 2. Can be either SD or HD on the V6416
▶ ◀ GP I/O	BNC	General Purpose Input or Output (bi-directional)
◀ DELAY PULSE	BNC	Delay Pulse Output. This is a 'TTL' type logic pulse whose positive portion represent the Video delay being inserted.
◀ REF. LOOP	BNC	Passive loop Output from Reference Input (below). This is a hard connection on the rear panel, so remains even if the main board(s) is removed.
▶ REF.	BNC	Video Reference Input. This can be either a conventional bi-level sync or composite video signal, or a modern tri-level sync signal. A 75Ω termination can be applied using a small switch on the V6416, but it will be removed if the board is removed.



V6416 Up Down Cross Converter

2.2.2 Flash Memory Card

The Flash Memory Card stores the firmware for the Micro-controller and the FPGA and is essential for the operation of the module. If this card is missing, the front panel display will come up with an error message (ERROR 10). The Flash Memory Card sits in a socket with a location peg to the right. In case of a firmware upgrade, one has to make sure that the replaced card sits firmly and straight in the socket with the location peg mating with the positioning hole on the baseboard.

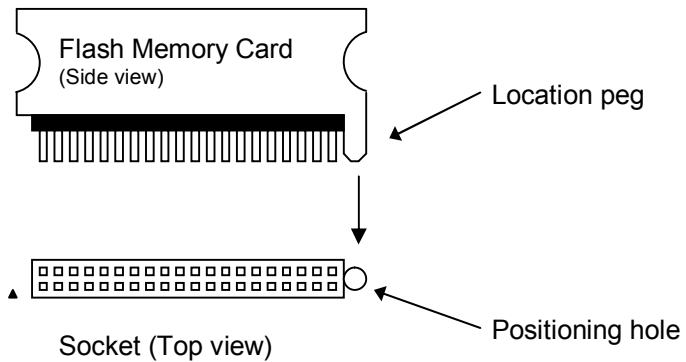

The Flash Memory Card is re-programmable. Customers are kindly asked not to throw it away after having upgraded a module with a newer firmware version. A Vistek service technician will collect it on his/her next visit or it can be put in an envelope and sent back to the postal address shown on the cover of this manual.



3 System Operation

3.1 Local Control

3.1.1 Start Up

Local control and monitoring of the module is done through the front panel with its eight character LED display and three control buttons **Select**, **▲** and **▼**. There are three LEDs which also contribute to the status indication; these are labelled **+**, **Cal** and **-**.

After power up and having successfully passed the power-on-self test, the display will start at the top level and show the unit type.



V6416 Up Down Cross Converter

3.1.2 Menu Control

The **Select**, ▲ and ▼ buttons are used to manoeuvre around the menu system. The menu structure has five levels and the **Select** button is used to go up and down the structure. The ▲ and ▼ buttons are used to move between selections or to adjust a parameter depending on which sort of menu is displayed. The five levels are as follows:

Sleep	Display is blank (except for Banner warnings).
Top Level	As above, e.g. V6416
Main Menu	The Main menu items, such as VIDEO , STATUS , ENG'ING etc. These items are all in Upper Case.
Sub Menu	Menu items under each main heading, such as Source or O/P LStd under the VIDEO main menu. These items are all in Sentence Case (generally lower case but with upper case first letters).
Parameter	The lowest level under the Sub Menu, and used to actually adjust a parameter. The display will depend on the actual parameter and may be a value such as +0.00dB for a gain or ON or OFF for a switch variable. There is usually a title to describe the variable and a small icon in the left hand character position, but 8 characters cannot provide for a detailed description.

To move down a level just press the **Select** button briefly; then press either the **Select** button again to go down another level or the ▲ and ▼ buttons to move around the options within a level.

To move up a level press and hold the **Select** button for about half a second which will move up one level. If you continue to hold the **Select** button then it will move up a level every half a second until it reaches the Sleep level (one above the Top Level).

A complete list of all the menus is given in Section 5.

3.1.3 Menu Examples

This section has examples of how to manoeuvre through the menu system. The first one starts with the unit in its 'sleep' mode where the display is blank, and then proceeds to set the reference source to the processing input (*Vid I/P*).

Action	Display	Comments
Select	V6416	Top Level
Select	VIDEO	The Main Menu we want
Select	Source	The first Sub Menu in the list
▼	O/P LStd	
▼	O/P FldR	The Sub Menu we want
Select	Auto	The default setting
▲	50Hz	Set it as we want it

V6416 Up Down Cross Converter



3.1.4 Sleep

If the front panel is not used for a certain amount of time then the display will automatically go into a sleep mode when it will be blank. Pressing any of the buttons will cause it to 'wake up' back into the top level. The time delay before the unit slips into sleep mode can be set up using the **CONFIG : Sleep** menu.

The brightness of the display can also be adjusted using the **CONFIG : LEDLevel** menu.

3.2 Core Product Features

3.2.1 SDI Inputs

The SDI inputs must conform to either the SMPTE292M or SMPTE259M standards, which describe the Bit Serial Digital Interface for HD and SD operation. If only one input is required then it should be connected to SDI 1. Unused inputs can be left open, it is however recommended to terminate unused inputs with a 75Ω Terminator to improve noise immunity. Signals of different frame-rates, resolutions or even a mixture of SD and HD standards can be connected to both Inputs at the same time, however only one of the two inputs can be selected at a time. Note that switching between different standards is neither instant nor glitch-free. This has to do with the necessity of the SDI de-serialiser hardware to lock to the newly detected standard. Furthermore, in case of an SD-to-HD output switch over (or vice versa), the FPGA on the baseboard must be re-loaded. This process takes about 2 to 3 seconds.

The input selection is done on the **VIDEO : Source** menu.

3.2.2 SDI Reclocked & Buffered Output

This is always available, and is a re-clocked version of either SDI 1 or SDI 2, depending on the source selection. It is an unprocessed signal, i.e. neither synchronised nor converted.

3.2.3 SDI Main Outputs

The main synchronised/processed SDI output is available on two BNCs.



V6416 Up Down Cross Converter

3.2.4 Video Reference

The external video reference is available for units with the Frame Synchroniser function; it can be either a standard composite black and burst video signal, or new style tri-level sync. The unit will automatically detect which and extract the relevant timing information.

The reference is looped on the rear module so it can be daisy chained along several modules. For accurate timing, this is not recommended. There is a termination on the I/O daughter module, which can be switched in at the end of the chain. Care should be taken to ensure that each reference has only one termination set.

The units can operate from either the external reference or use the selected SDI input. This is selected on the **TIMING : Ref Src** menu. When set to *Auto*, the external reference will be used if available; otherwise the selected SDI input will be used as the reference.

3.2.5 Standard Detection

The units detect and report back the detected video standard and frame-rate of the selected SDI input and that of the reference input. The detected standard can be seen in the **STATUS** menu under **I/P Std** and **Ref Std**.

3.2.6 TRS Signals

The TRS signals are the digital equivalent of the analogue synchronising pulses. All modules described in this manual always regenerate the TRS signals on their output, so that any errors on the input signal will not be propagated through.

3.2.7 EDH (SD operation only)

EDH is a method of embedding data within the ancillary data space that carries a measurement of the integrity of video and other data. By regenerating the equivalent measurement at the receiving end it is possible to check that the data has been received correctly.

HD signals always have the EDH data in form of checksums embedded, but for SD signals it is optional. The EDH on the output can be disabled on the **ENG'ING : O/P EDH** menu. Care must be taken if the new EDH generation is disabled and the old EDH is being passed through because it will probably not correctly represent the data. In this case the Ancillary Data really ought to be blanked.

V6416 Up Down Cross Converter



3.2.8 Illegal Codes

A function of these modules is to ensure that the SDI output always meets the relevant specification. In particular this means that the output is always legal in the sense of Line Length, Field Length and data values. In the main this works extremely well, but there are some circumstances where it fails:

- If the output timing is being changed, there will be momentary errors.
- If the input is noisy, such that erroneous data is received, then the ancillary data may get checksum errors. This obviously only applies if the Ancillary data is being passed. The video will be all right, since the EDH (SD operation), respectively the line numbers and CRC codes in accordance with SMPTE 292M (HD operation) are regenerated on the output.
- If the reference is unstable or changing standards then the output will not be stable.

3.2.9 VCO Centre Frequency

Normally, the output is locked to the video reference - if present - and of the same standard as the video, or to the input video itself. If there is no signal or reference connected then the output will free run at the nominal centre frequency of the on board clock generator. This centre frequency can be adjusted under the **CALIB : CntrFreq** menu, but this should not normally be necessary in the field.

It is possible to force the unit into its free-run mode using the **ENG' ING : Free-run** menu. This is an unusual requirement and so is a setting that appears on the top-level banner when set.

3.2.10 Version Numbers

The V6416 module comprises various items of software/hardware and they all have separate version numbers. These can be read on the following read only menus:

VERSION	PROM Ver	01.01	PROM stick version
	Soft Ver	05.01.00	Versions of software / firmware / hardware components.
	Boot Ver	02.00.00	
	Strx Ver	1.4.00	
	FPGA Ver	01.04	
	CPLD Ver	00.01	
	Data Ver	29000002	
	PCB Ver	00.00	
	VModule	* HD PROC	
	IOModule	STD [3]	



V6416 Up Down Cross Converter

3.2.11 Display Sleep

Since, for the vast majority of its life, a module will operate behind the front panel of a rack frame, the display on the local front panel will not be visible so it will go to sleep after a certain time. This timeout delay can be changed on the **CONFIG: Sleep** menu to be anything between 0 and 30 minutes; 0 minutes means that it will stay on indefinitely. The sleep timeout always counts from the last front panel button push. The default time is 5 minutes.

The panel can also be forced into its sleep mode by moving up a level from the Top Level menu, which displays the module type.

To get the display to come on again simply press one of the buttons and the menus will start again at the Top Level.

3.2.12 Display Brightness

The brightness of the front panel display can be adjusted on the **CONFIG: LEDLevel** menu.

ENG' ING LEDLevel █ █ █ █



3.3 Output Format and Aspect Ratios

3.3.1 Output Line and Frame Rate

The output format is selected using two controls; one of these, **VIDEO : O/P LStd** , controls the line standard e.g. 720 or 625, the other, **VIDEO : O/P FldR** selects the field rate for example 50 or 59.94.

These controls have the following available settings:

		O/P FldR		
		Auto	50	59.94
O/P LStd	Vid I/P	ü	ü	ü
	525i	ü	X	ü
	625i	ü	ü	X
	1080i	ü	ü	ü
	720p	ü	ü	ü

When these controls are set to the 'Vid I/P' or 'Auto' settings the input is used to select the output line standard or frame rate. If an illegal combination is selected then a flashing  symbol will appear to the right of the selected field rate or line standard on the front panel.

3.3.2 Up-Conversion

When up-converting, i.e. taking in an SD input signal (either 525 or 625) and converting to an HD output, the aspect ratio is controlled by the **VIDEO : AR Up** menu, which has the following options :

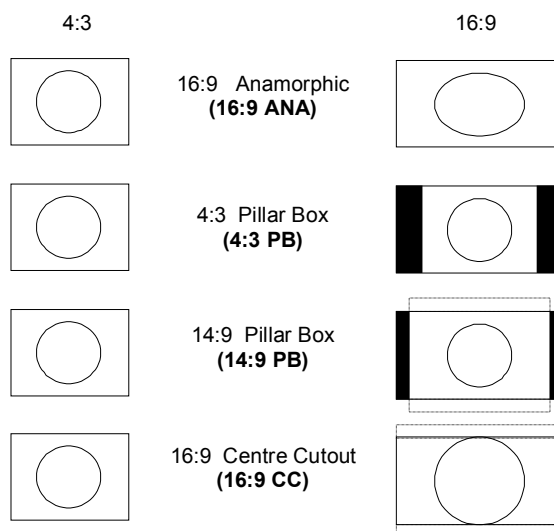

Please note that these conversions will only apply if the Conversion Mode menu parameter (**VIDEO : ConvMode**) is set to manual (**Man**). If, however, the Conversion Mode menu parameter (**VIDEO : ConvMode**) is set to automatic (**AFD**) then the card automatically selects the most appropriate conversion. This will depend on the AFD data contained within the received input signal.



V6416 Up Down Cross Converter

3.3.3 Down Conversion

The V6416 gives four down conversion options in the **VIDEO : AR Down** menu. They are shown diagrammatically below. Note that some conversion settings result in a loss of parts of the original picture (indicated by dotted areas).

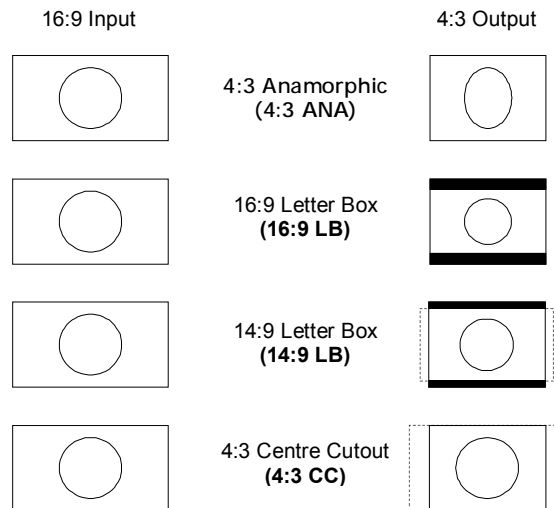

Please note that these conversions will only apply if the Conversion Mode menu parameter (**VIDEO : ConvMode**) is set to manual (**Man**). If, however, the Conversion Mode menu parameter (**VIDEO : ConvMode**) is set to automatic (**AFD**) then the card automatically selects the most appropriate conversion. This will depend on the AFD data contained within the received input signal and whether the output signal is to be used in a 4:3 or 16:9 service environment.

V6416 Up Down Cross Converter



3.3.4 SD Aspect Ratio Conversion

When converting between SD standards, there are 8 available preset aspect ratio conversions. These can be found in the **VIDEO : AR SD>SD** menu. These are described in the diagram below.

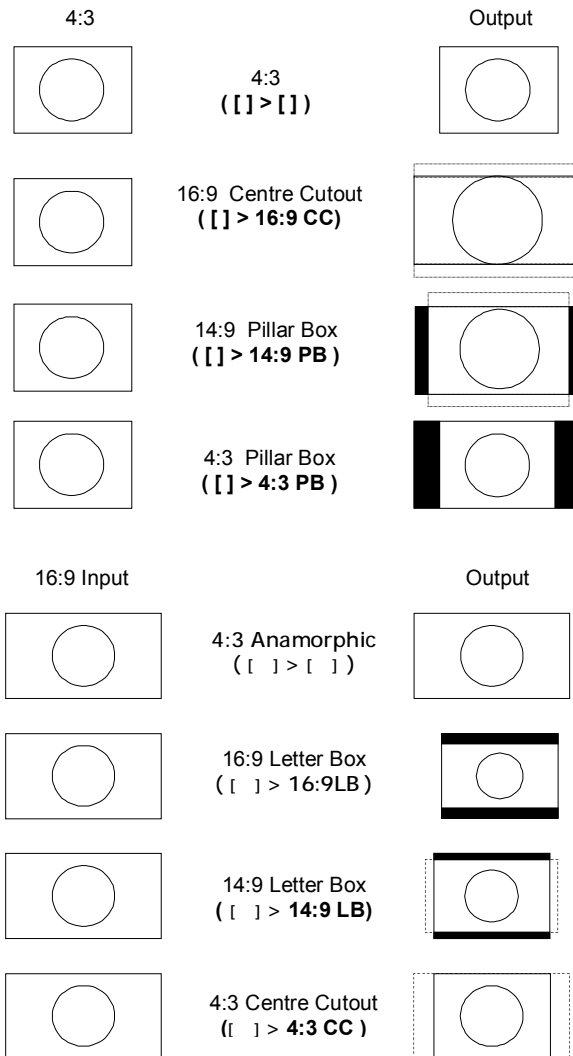

Please note that these conversions will only apply if the Conversion Mode menu parameter (**VIDEO : ConvMode**) is set to manual (**Man**). If, however, the Conversion Mode menu parameter (**VIDEO : ConvMode**) is set to automatic (**AFD**) then the card automatically selects the most appropriate conversion. This will depend on the AFD data contained within the received input signal and whether the output signal is to be used in a 4:3 or 16:9 service environment.



V6416 Up Down Cross Converter

3.3.5 Conversion mode: Manual or automatic (AFD)

When converting a signal between Standard Definition and High Definition formats (ie Up or Down conversion), or for that matter when transferring a Standard Definition signal between 4:3 and 16:9 environments (i.e. Aspect Ratio Conversion), it is important to carefully apply horizontal and vertical scaling such that the resultant image does not exhibit aspect ratio distortions. If scaling is not applied carefully then circles on an input signal will no longer be circular on the resultant output image, but rather will be elliptical. This is very undesirable.

The V6416 offers a number of industry standard fixed (scaling) conversions to the user. These may be selected manually via the following menus:

- Up conversion **VIDEO : AR Up** see section **3.3.2**
- Down conversion **VIDEO : AR Down** see section **3.3.3**
- SD Aspect ratio conversion **VIDEO : AR SD>SD** see section **3.3.4**

To manually apply these fixed conversions the user must ensure that the Conversion Mode menu parameter (**VIDEO : ConvMode**) is set to manual (**Man**).

There is a second mode of operation for controlling the scaling conversions applied to an input signal. This is selected by setting the Conversion Mode menu parameter (**VIDEO : ConvMode**) to automatic (**AFD**). Within this mode of operation the card automatically selects the most appropriate conversion for best output picture display. To make the judgement on which conversion to apply the card reads an ancillary data packet, known as Active Format Description (AFD), from the input signal. The AFD data contains information that describes the image of the associated signal. The primary AFD information read by the V6416 in order to evaluate the best conversion to apply is:

- The coded frame (or AR) bit. This is either 4:3 or 16:9
- The active image description (this is the 4 bit AFD code)

There are 32 possible combinations for describing the incoming signal using the AR bit and 4 bit AFD code. Refer to SMPTE specification 2016-1-2007 through 2016-4-2007 for more information if required.

As well as the AFD data, in order to determine the most appropriate conversion, the V6416 must also know whether the output is to be fed to a 4:3 or 16:9 service environment. This is always 16:9 for high definition format outputs. However, for standard definition outputs this may be 4:3 or 16:9. The user must program this information into the card via the **AFD : OP AR SD** menu item. The two possible settings are **4 : 3** (default) and **16 : 9**.

Armed with the above mentioned information, the V6416 applies the most appropriate conversion to the input signal in order to produce the best output picture display. Please refer to section **6.3** in the appendix for an illustration of which conversions the V6416 applies for various common input AR / AFD code combinations.



3.3.6 SD Width Control

In a digital SD signal there are 720 luminance samples in an active line which equates to 53.33us in the analogue world. A true PAL signal has an analogue line length of 52us, which equates to 702 luminance samples in the digital domain, and NTSC has an analogue line length of 52.66us equating to around 711 luminance samples.

In HD standards the line length is always considered to be the full digital line.

When converting between HD and SD, there is some ambiguity about how images should be scaled. Should the whole HD line be scaled to the whole digital SD line, or the slightly shorter analogue dimension? A control has been provided, **VIDEO : SD Width**, which allows the user to choose which option to use. This control has the options *SDwd Ana* and *SDwd Dig*, referring to analogue and digital SD widths. When set to analogue, the unit will scale images as if the SD line was the shorter analogue length. When set to digital, the SD line will be considered to be 720 samples long.

3.3.7 Down Conversion Resolution Controls

When down converting, the source material is of much higher resolution than the output as a result some fine detail must be lost. In the default mode of operation the unit will preserve as much picture information as it can, giving a very sharp output picture. The resultant image can look too sharp for some purposes, especially in the vertical direction where high-resolution detail can be seen as flickering. For this reason two controls have been provided, **ENG' ING : H Res** and **ENG' ING : V Res**; these control the horizontal and vertical resolution of the output when down-converting, and have the options *high*, *medium* and *low*. The *high* setting passes the most detail, and *low* is the softest.



V6416 Up Down Cross Converter

3.4 Active Format Description (AFD) Control Facilities

3.4.1 General

This section (3.4) describes each of the controls that are available from within the AFD sub-menu of the V6416 front panel control interface. Each control is described in turn. Furthermore, each is addressed in the same order as they appear in the sub-menu.

When operating in the Automatic (AFD controlled) Conversion Mode a 'working' or 'raw' I/P AFD Flag value is used to determine which (scaling) conversion to apply to the incoming video signal. A number of signals and controls interact to determine this value. The block diagram, below, has been included to diagrammatically illustrate the relationship between, and functionality of, these signals and controls.

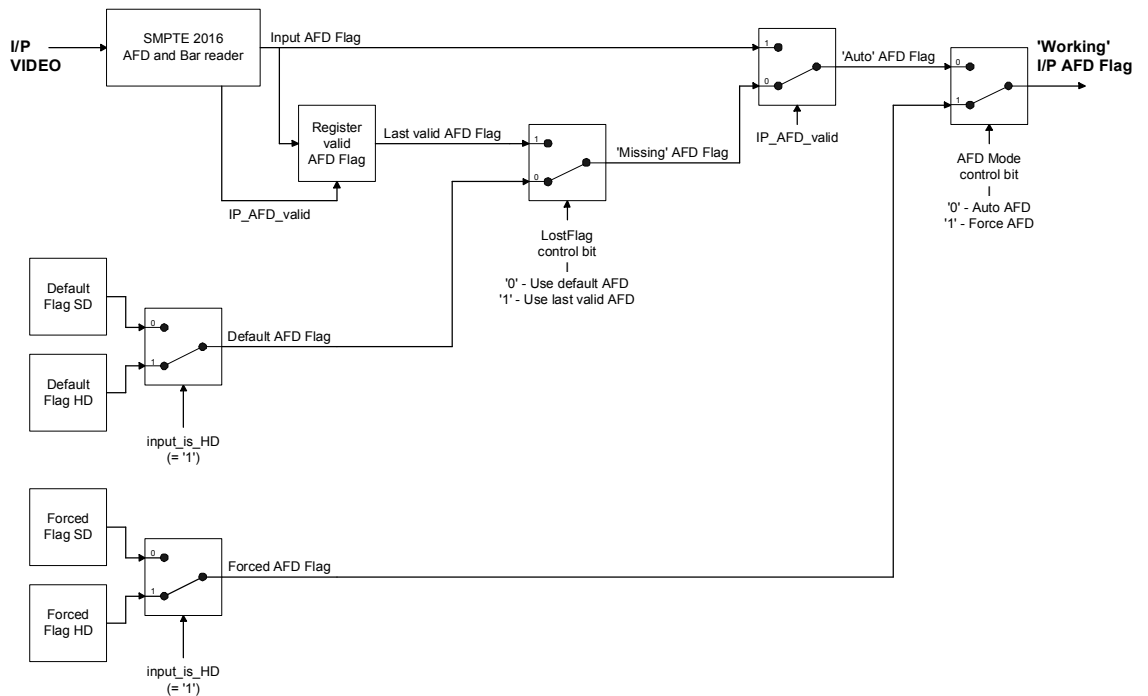

V6416 Up Down Cross Converter



3.4.2 AFD Insertion

This control allows the user to insert, or not, an AFD ancillary data packet onto the output of the unit.

AFD AFD Ins

The two optional settings for this control are:

Off or On

The V6416 automatically assigns the AR and AFD bit values that are inserted into the output, and are dependant on the nature of the input signal presented to the card and the scaling conversion that has been applied.

3.4.3 AFD Line

AFD AFD Line

The **AFD Line** control allows the user to decide into which line(s) in the vertical interval the AFD ancillary data packet should be added. For each possible output standard there is a choice of 16 line pairs (one line in the first field, and the corresponding line in the second field). For example, the choice of line pairs for a 1080i50 output standard ranges from:

Ln 5/568 > Ln13/576 (nominal setting) > Ln20/583

Please note: there are unique non-volatile storage locations for each possible output standard i.e. one location for 1080i50, one for 1080i59, one for 625i50, etc..

3.4.4 Standard Definition Output Service: 4:3 or 16:9

AFD OP AR SD

The two optional settings for this control are:

4:3 or 16:9

This control is active only when the Conversion Mode menu parameter (**VIDEO : ConvMode**) is set to automatic (**AFD**). Please refer to section **3.3.5 Conversion mode: Manual or automatic (AFD)** for a detailed description of the Conversion Mode control if required.



V6416 Up Down Cross Converter

3.4.5 AFD Flag Missing on Input : LostFlag Control

AFD LostFlag

The two optional settings for this control are:

Default Or Last I/P

This control is active only when the Conversion Mode menu parameter (**VIDEO : ConvMode**) is set to automatic (**AFD**).

When operating in the automatic (AFD) Conversion Mode this control determines how the unit responds when there is no AFD flag present on the input signal to the card, or if the AFD flag disappears suddenly.

When the **LostFlag** control is set to the **Last I/P** position the card adopts the last known good received AFD value when the AFD flag disappears from the input signal. The card then uses this value as a substitute for a real AFD input flag when determining which conversion to apply. This mode of operation may be useful if the card is being used in an environment where AFD flag insertion is universal, but may intermittently disappear for a frame or two. This mode of operation would then ensure the card would not change conversion mode unexpectedly mid programme.

When the **LostFlag** control is set to the **Default** position the card adopts a user defined AFD value when there is no AFD flag present on the input signal. The card then uses this value as a substitute for a real AFD input flag when determining which conversion to apply. There are two default AFD flags: one for when there is a standard definition input signal (**Dflag_SD**), and one for when there is a high definition input signal (**Dflag_HD**). This mode of operation may be useful if the card is being used in an environment where AFD flags are not universally present on all input feeds. In this situation, the card will utilize the incoming AFD flag, if present. If there is no AFD flag on the input signal, the user may set the default AFD flag(s) to best reflect the signal active image most likely to be received at the input (e.g. full frame 4:3 for SD feeds and full frame 16:9 for HD feeds).



3.4.6 AFD override facility: AFD Mode Control

AFD AFD Mode

The two optional settings for this control are:

Auto Or Force

This control is active only when the Conversion Mode menu parameter (**VIDEO : ConvMode**) is set to automatic (**AFD**).

The **Auto** mode of operation is very much the normal mode of operation (assuming the Conversion Mode parameter is set to automatic). Whilst in this mode the card uses the incoming AFD flag to determine the most appropriate conversion to apply to ensure best output picture display. However, if the AFD flag received on the input is unreliable or just plain wrong, then the user may switch to the forced (**Force**) mode of operation. In this mode of operation the incoming AFD flag is ignored, and subsequently substituted by a forced AFD override flag. The card consequently uses this forced AFD flag to determine the optimum conversion to apply.

There are two forced AFD flags: one for when there is a standard definition input signal (**Fflag_SD**), and one for when there is a high definition input signal (**Fflag_HD**).



V6416 Up Down Cross Converter

3.4.7 AFD Flag Missing On Input: Default Flag (SD inputs)

`AFD Dflag_SD`

The range of settings for this control is:

`4:3_0` through to `4:3_15` , `16:9_0` through to `16:9_15`

I.e. there are 32 optional values. The nominal setting for this control is `4:3_8` ; this value describes a full frame 4:3 image.

This control is active only when:

- The Conversion Mode menu parameter (`VIDEO: ConvMode`) is set to automatic (`AFD`).
- The `LostFlag` control is set to the `Default` position
- The `AFD Mode` control is set to the `Auto` position
- The input signal to the card is of standard definition format

Please refer to section **3.4.5 AFD Flag Missing on Input : LostFlag Control** for a description of the function of default flags.

3.4.8 AFD Flag Missing On Input: Default Flag (HD inputs)

`AFD Dflag_HD`

The range of settings for this control is:

`16:9_0` through to `16:9_15`

ie there are 16 optional values. The nominal setting for this control is `16:9_8` ; this value describes a full frame 16:9 image.

This control is active only when:

- The Conversion Mode menu parameter (`VIDEO: ConvMode`) is set to automatic (`AFD`).
- The `LostFlag` control is set to the `Default` position
- The `AFD Mode` control is set to the `Auto` position
- The input signal to the card is of high definition format

Please refer to section **3.4.5 AFD Flag Missing on Input : LostFlag Control** for a description of the function of default flags.

V6416 Up Down Cross Converter



3.4.9 AFD Flag Override: Force Flag (SD inputs)

AFD Fflag_SD

The range of settings for this control is:

4:3_0 through to **4:3_15** , **16:9_0** through to **16:9_15**

i.e. there are 32 optional values. The nominal setting for this control is **4:3_8** ; this value describes a full frame 4:3 image.

This control is active only when:

- The Conversion Mode menu parameter (**VIDEO : ConvMode**) is set to automatic (**AFD**).
- The **AFD Mode** control is set to the **Force** position
- The input signal to the card is of standard definition format

Please refer to section **3.4.5 AFD Flag Missing on Input : LostFlag Control** for a description of the function of force flags.

3.4.10 AFD Flag Override: Force Flag (HD inputs)

AFD Fflag_HD

The range of settings for this control is:

16:9_0 through to **16:9_15**

i.e. there are 16 optional values. The nominal setting for this control is **16:9_8** ; this value describes a full frame 16:9 image.

This control is active only when:

- the Conversion Mode menu parameter (**VIDEO : ConvMode**) is set to automatic (**AFD**).
- the **AFD Mode** control is set to the **Force** position
- the input signal to the card is of high definition format

Please refer to section **3.4.5 AFD Flag Missing on Input : LostFlag Control** for a description of the function of force flags.



V6416 Up Down Cross Converter

3.5 Output Timing, Reference and Frame Synchroniser

3.5.1 Timing & Delay Control

3.5.1.1 With External Reference (Ref I/P)

If an external, analogue Reference signal (e.g. Bi- or Tri-Level Sync) of the same frame rate as the output is present, *and* the reference source selection control (**TIMING : Ref Src**) is set to *Auto* or *Ref I/P*, The unit will automatically ensure the output is frame synchronous to the analogue reference input.

The insertion delay of the unit is 4fields + 0-2fields synchronisation delay. This will be dependent on the relative timing of the input and reference, and any offset timing applied relative to the reference. The extra delay being added on top of the unit's fixed 4 field insertion delay is reflected on the delay pulse output.

In order to keep alignment with the incoming SDI data, the Frame-Synchroniser will either repeat a frame or drop a frame once in a while, depending on a) which of the two clock domains (Input Video versus Reference signal) is the faster, and b) how far the two clock domains are apart (typically in the range of 0 to ± 150 ppm).

When operating the V6416 locked to an analogue reference, two timing controls (V- & H-Timing) are available for adjusting the board's output timing relative to the external Reference signal.

TIMING : V Timing: Purpose: For vertical adjustment (in number of lines)
Range: -256..+255 lines

TIMING : H Timing: Purpose: For horizontal adjustment (micro seconds)
Range: 0 μ s up to one line (one pixel resolution)

V6416 Up Down Cross Converter

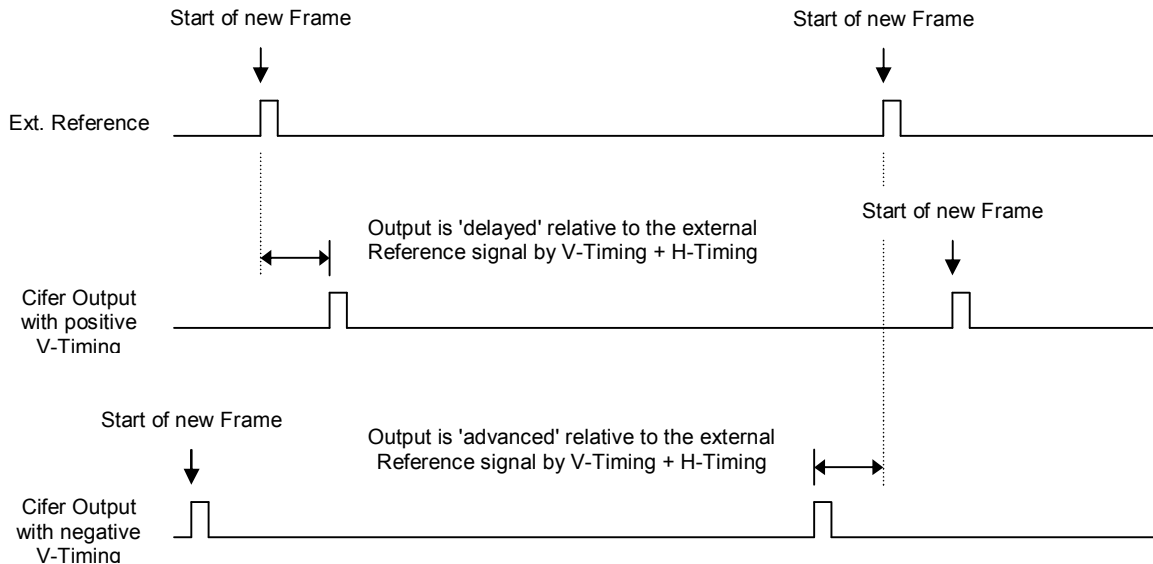

This drawing illustrates the **Reference-to-Output** timing relationship when operating the V6416 locked to an external analogue reference.

Note that the Input-to-Output delay when the unit is not frame rate is variable and spans from a minimum delay up to a complete Frame. This timing variation can be monitored on the Delay Pulse BNC.

3.5.1.2 With Internal Reference (Vid I/P)

When it is not converting frame rates, the V6416 can be used as a straightforward, adjustable delay module, in applications where for example the incoming SDI signal is already frame-synchronous but requires an arbitrary delay.

Disconnecting the external Reference signal (in case `VIDEO : Ref Src` is set to *Auto*) or forcing the unit to take its Video Input as the Reference signal (`VIDEO : Ref Src` is set to *Vid I/P*) will automatically disable the Frame Synchroniser function and put the board into a pure delay mode.

It should be noted that the unit cannot lock to the video input when a frame rate conversion is taking place, so the unit will free-run if the SDI input is selected as the reference source.

When locking to the SDI input, the H- and V-Timing controls are hidden, and H- and V-Delay controls appear in the TIMING menu. These are different controls, and their values are stored separately.



V6416 Up Down Cross Converter

F Important:

If **VIDEO : Ref Src** is set to *Auto* and no external Reference signal is present, the unit assumes that there is a persistent problem with the external Reference and the actual insertion delay is controlled by the setting in the **VIDEO : RFL Mode** menu:

If **RFL Mode** is set to *Min Dly*, all delay control settings will be forced to zero and the unit continues operating in a minimum delay (= intrinsic delay) mode.

If **RFL Mode** is set to *Adj Dly*, the insertion delay is the sum of the unit's intrinsic delay plus whatever is set in the F-, V- and H-Delay controls.

VIDEO : V Delay: Purpose: Fine delay (in number of lines)

Range: 0 up to (number of total lines per field/frame – 1 line)

VIDEO : H Delay: Purpose: Super fine delay (in microseconds)

Range: 0 μ s up to (duration of one line – one pixel)

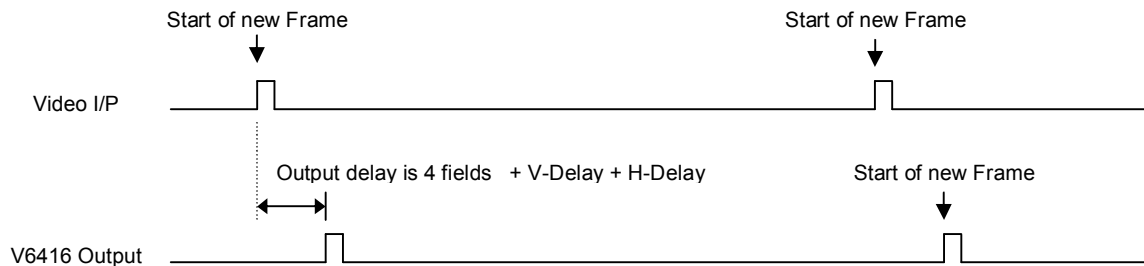

V6416 Up Down Cross Converter



3.5.2 Delay Pulse

The Frame Synchronizer produces a signal that represents the variable delay being inserted into the video path. This delay information is passed on internally to the V6302 Advanced Audio Processor (if present) and used to provide a tracking delay to the audio. The signal is also available externally so it can be used by other audio tracking devices. Please note that the length of the tracking delay pulse is a measure for the variable delay between input and output only – it does not cover for any additional processing delay added on top of the variable delay.

The Delay signal has repetition rate of two frames and the positive pulse width represents the variable delay. This is shown in this diagram.

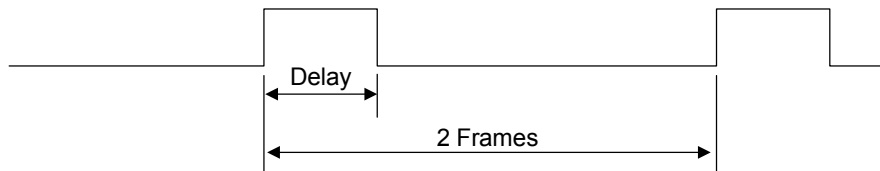

The external Delay Pulse output is available on a BNC on the rear panel. The external pulse itself is nominally 3.3V with a sourcing/sinking capability of $\pm 24\text{mA}$.

When no extra delay is being added on top of the standard 4 field delay, the delay pulse will reduce to its minimum width of 10 μs .

3.5.3 Video Reference Fail

When there is no external reference signal present, the unit will lock to the SDI input.

Under the circumstances described above and depending on the setting of **VIDEO : RFL Mode (Reference Fail Mode)**, the module then switches automatically into a minimum delay mode (*Min Dly*) or it maintains the delay set by the F-, V- and H- Delay controls (*Adj Dly*).

The module can be also forced to use the SDI input as its timing reference by setting **VIDEO : Ref Src** to *Vid I/P*. In this case, the current setting in **VIDEO : RFL Mode** will be ignored and the total insertion delay simply depends on the current settings in the F-, V- and H- Delay controls.



V6416 Up Down Cross Converter

3.5.4 Video Reference Mismatch

When a mismatch between the Video Output's frame-rate and the Reference's frame-rate is being detected, the unit will lock to the video input. When the output frame rate is following the reference, this case cannot occur.

3.6 Video Processing Amplifier

3.6.1 Video Gain

PROC AMP V Gain

The adjustment range is $\pm 6\text{dB}$ and it applies equally to the luminance and both of the chrominance channels (Cb and Cr). The gain is applied after the black level offset. The Video gain is applied simultaneously with the Chrominance gain so they can cancel one another out. For example $+3\text{dB}$ of Video gain along with -3dB of Chroma gain will result in the luminance being increased by $+3\text{dB}$ and the Cb and Cr channels being unchanged.

The output is limited to ensure that there is no numerical overflow as the output fits into the 10 bit D1 domain. There is no gamut legalisation function.

3.6.2 Chroma Gain

PROC AMP C Gain

The adjustment range is $\pm 6\text{dB}$ and it applies equally both the chrominance channels. The gain is applied along with the video gain and after the black level offset. The Chrominance gain is applied simultaneously with the Video gain so they can cancel one another out. For example $+3\text{dB}$ of Video gain along with -3dB of Chroma gain will result in the luminance being increased by $+3\text{dB}$ and the Cb and Cr channels being unchanged.

The output is limited to ensure that there is no numerical overflow as the output fits into the 10 bit D1 domain. There is no gamut legalisation function.

3.6.3 Black Level

PROC AMP Blk Lvl

The adjustment range is -127 and $+128$ D1 levels (equivalent to $-101/+102\text{mV}$). The black level adjustment is applied before the gain stages. This is considered the best arrangement since the unit is usually used to correct incoming errors.

3.6.4 Hue Shift

PROC AMP Hue

The adjustment range of the hue shift is $\pm 45^\circ$ in 0.35° steps.



3.6.5 Dynamic Rounding

PROC AMP Dyn Rnd

Since some quantising effects may be visible on the output of this unit when variable gains are applied, Dynamic Rounding has been applied. This Dynamic Rounding is only used to reduce the effects of the fractional bits of lower significance than the normal 10 bits; it does **not** reduce the resolution to 8 bits.

This can be disabled on the **PROC AMP : Dyn Rnd** menu.

3.6.6 Limiting

PROC AMP Hrd Clip

Since gain can be applied to the D1 signal it is possible to generate levels outside the normal 10 bit gamut of D1 and so limiting is required. The Proc Amp normally applies a soft form of limiting that progressively reduces the gain of a signal as it approaches the limits, either overshooting or undershooting. If this is not required then it can be disabled on the **PROC AMP : Hrd Clip** menu.

The limiting that is applied is 'simple' in that it does not ensure that the output is correctly within the colour gamut, but only that each of the three components (Y, Cb, Cr) remains within the legal 10 bit range.

Certain test patterns, most notable the amplitude ramps, contain data that is within the overshoot and undershoot areas. If they are passed through the Proc Amp with its default soft clipping then they will be modified. This means that the EDH value on the output will be different to that on the input. If this is not wanted then the Hard Clipping can be turned ON, but this is not recommended for normal Proc Amp operation.

3.6.7 Fade to Black

PROC AMP Fade>Blk

This enables the output to be cleanly attenuated to digital black on receipt of an internal command.

The rate of the fade is fixed at half a second.

Locally the fade can be initiated on the **PROC AMP : Fade>Blk** menu. This contains both an ON and OFF command.

The fade can also be initiated over the DART remote control network. The fade will start as soon as the command is sent.

The output will stay at black until any active control input is released, or the unit is reset. There is no direct indication on the front panel that the output is being forced to black except for the top level banner, if enabled.



V6416 Up Down Cross Converter

3.7 Time Code and Source Identification

3.7.1 General

The V6416 offers a number of time code and source identification processing features. The unit is able to read time code data from the input signal (Ancillary or DVITC coded) and fundamentally reproduce the same time code data at the output of the unit (Ancillary and/or DVITC coded). This transfer of time code data between the input and output of the unit may include a change in definition format (SD to HD or vice versa), change in format (1080i to 720p, etc).

The unit is also able to read source identification data from the input signal and fundamentally reproduce the same source identification data at the output of the unit.

As shown in the diagram below, there are 3 main processing blocks:

1. Time code and source identification reader interfaces block.
2. Time code generator interfaces block.
3. Time code and source identification inserter interfaces block.

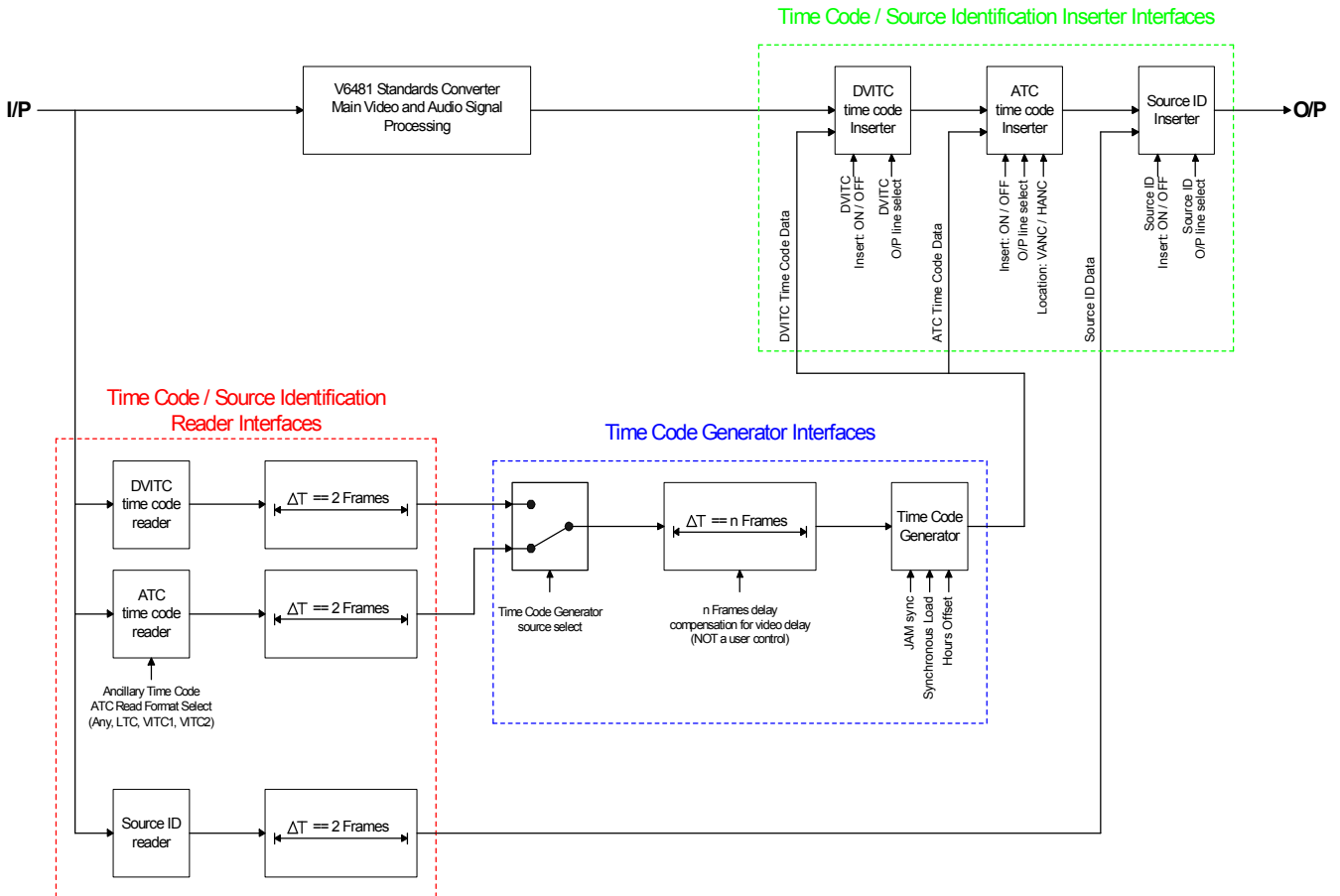

V6416 Up Down Cross Converter



3.7.2 Time code and source ID reader interfaces block

The time code and source identification reader interfaces block contains three primary processing blocks: a DVITC time code reader, an Ancillary time code reader and a source identification reader.

The **DVITC time code reader** block reads and decodes DVITC time code from the input signal. It provides the following output signals for subsequent processing blocks:

Hours, minutes, seconds, frames data

32 user data bits

The **Ancillary Time Code (ATC) reader** block reads and decodes ATC time code from the input signal. It provides the following output signals for subsequent processing blocks:

Hours, minutes, seconds, frames data

32 user data bits

16 Distributed Binary Bits (DBB) data

There is one control available to the user via the front panel that modifies the operation of this block; this is the **ATC Read** control.

AUX DATA ATC Read

This allows the user to decide which type of encoded ATC time code to respond to and decode:

Any, LTC, VITC1 or VITC2

The nominal position for this control is **Any**, and this should be the selection for the vast bulk of operational setups.

The **Source Identification (SID) reader** block reads and decodes source identification data from the input signal. It provides the following output signals for subsequent processing blocks:

Source identification data (15 characters)



V6416 Up Down Cross Converter

3.7.3 Time code generator interfaces block

The time code generator interfaces block contains two primary processing blocks: a Time Code Generator (TCG) module and a Time Code Generator source selection switch.

The **Time Code Generator source selection switch** receives two sets of time code data (hours, minutes, seconds and frames) from the time code and source identification reader interfaces block. One set carries DVITC decoded time code data and the other carries ATC decoded time code data. The Time Code Generator source selection switch selects which set of time code data is passed on to the Time Code Generator module. This control (**TCG Src**) is available to the user via the front panel.

AUX DATA TCG Src

The two options for the setting of this control are:

TC ATC or TC DVITC

The **Time Code Generator module** is effectively a free running generator which is incremented at the output frame rate. To ensure that the input time code is reproduced at the output there is a synchronization process, known as Jam syncing, which effectively locks the output of time code generator to the selected input time code (DVITC or ATC). The Jam sync process is fully automatic (hidden from the user) and occurs momentarily at certain events. Examples of these events are when the input signal reappears after a period when there has been no input to the unit, when the front panel input source selection (input 1 > input 2) has changed, when there is a discontinuity in the incoming time code, etc. Although the Jam sync process is fully automatic, and does not require manual intervention from the user, there is also an optional manual Jam sync control available from the front panel.

AUX DATA TCG Jam

This is a momentary control. When a manual Jam sync is initiated from the front panel the text displayed on the front panel will momentarily toggle between **Off** and **Jam**, then return back to **Off**.

There are operational situations when a user may wish to offset the output time code with respect to the input time code by a number of integer hours. This feature is offered via a user adjustable front panel control (**TCG Ofst**).

AUX DATA TCG Ofst

This control is adjustable between -11 hours (**-11h**) and +12 hours (**+12h**) offset, in one hour increments. The nominal setting for this control is for there to be zero hours offset between the input and output time codes (**+0h**).

3.7.4 Time code and source ID inserter interfaces block

The time code and source identification inserter interfaces block contains three primary processing blocks: a DVITC time code inserter, an Ancillary time code inserter and a source identification inserter.

V6416 Up Down Cross Converter



The **DVITC time code inserter** takes the raw time code data (hours, minutes, seconds, frames) from the Time Code Generator interfaces block, converts it into the appropriate DVITC coded signal and then adds it into the output signal path at the appropriate time in the vertical interval.

There are two controls available to the user via the front panel that modify the operation of this block; these are the **DVITCIns** and **DVITC Ln** controls.

AUX DATA DVITCIns

The two optional settings for this control are **DVITCoff** (Do not insert DVITC on the output signal) and **DVITC On** (Insert DVITC on the output signal).

AUX DATA DVITC Ln

The **DVITC Ln** control allows the user to decide into which line(s) in the vertical interval the DVITC time code data should be added. For each possible output standard there is a choice of 16 line pairs (one line in the first field, and the corresponding line in the second field). For example, the choice of line pairs for a 1080i50 output standard ranges from:

Ln 5/568 > Ln13/576 (nominal setting) > Ln20/583

Please note: there are unique non-volatile storage locations for each possible output standard ie one location for 1080i50, one for 1080i59, one for 625i50, etc..

The **Ancillary Time Code (ATC) inserter** takes the raw time code data (hours, minutes, seconds, frames) from the Time Code Generator interfaces block, converts it into the appropriate ATC coded signal and then adds it into the output signal path at the appropriate time in the vertical interval.

There are three controls available to the user via the front panel that modify the operation of this block; these are the **ATC Ins**, **ATC Line** and **ATC Loc** controls.

AUX DATA ATC Ins

The two optional settings for this control are **ATC off** (Do not insert ATC on the output signal) and **ATC On** (Insert ATC on the output signal).

AUX DATA ATC Line

The **ATC Line** control allows the user to decide into which line(s) in the vertical interval the ATC time code data should be added. For each possible output standard there is a choice of 16 line pairs (one line in the first field, and the corresponding line in the second field). For example, the choice of line pairs for a 1080i50 output standard ranges from:

Ln 5/568 > Ln13/576 (nominal setting) > Ln20/583

Please note: there are unique non-volatile storage locations for each possible output standard ie one location for 1080i50, one for 1080i59, one for 625i50, etc..

AUX DATA ATC Loc

The two optional settings for this control are **ATC VANC** (Insert ATC in the VANC period of the output signal) and **ATC HANC** (Insert ATC in the HANC period of the output signal). The



V6416 Up Down Cross Converter

nominal setting for this control is **ATC VANC**.

The **Source Identification (SID) inserter** takes the raw source identification data (15 characters) from the time code and source identification reader interfaces block, converts it into the appropriate SID coded signal and then adds it into the output signal path at the appropriate time in the vertical interval.

There are two controls available to the user via the front panel that modify the operation of this block; these are the **SID Ins** and **SID Line** controls.

AUX DATA SID Ins

The two optional settings for this control are **SID off** (Do not insert SID on the output signal) and **SID On** (Insert SID on the output signal).

AUX DATA SID Line

The **SID Line** control allows the user to decide into which line(s) in the vertical interval the SID time code data should be added. For each possible output standard there is a choice of 16 line pairs (one line in the first field, and the corresponding line in the second field). For example, the choice of line pairs for a 1080i50 output standard ranges from:

Ln 5/568 > Ln13/576 (nominal setting) > Ln20/583

Please note: there are unique non-volatile storage locations for each possible output standard ie one location for 1080i50, one for 1080i59, one for 625i50, etc..

The **Time Code on Output** control (**TCG Out**) allows the user to decide whether there should always be time code on the output of the unit, irrespective of if there is time code on the input signal, or not.

ENG' ING TCG Out

The two optional settings for this control are **From I/P** (Time Code inserted on the output of the unit **ONLY** if time code is present on the input to the unit) and **Always** (Time Code **ALWAYS** inserted on the output of the unit).



4 Calibration

This section describes how to calibrate the unit as it is done in the factory. The units do not contain any potentiometers, but like most equipment with analogue parts still needs to be calibrated. Normally this calibration is done in the factory and should not need to be repeated in the field but this section describes the procedure and is included for completeness.

High quality, calibrated test equipment should be used for this calibration. Note that it is not possible to return to the pre-calibration settings other than by making a note of the values and re-entering them.

4.1 Set-Up

There is a separate Main Level Menu for Calibration and this should be used throughout. The first sub-level menu is Cal Mode, which can be used to turn calibration ON:

```
    CALIB      Cal Mode  Cal Off
                          Cal On
```

The calibration mode must be turned ON before any parameter can be adjusted. The calibration mode will be turned OFF in one of four ways:

- Manually on the **CALIB : Cal Mode** menu
- By going up to the Top Level Menu
- By re-powering the unit.
- By letting the display timeout and go to sleep mode.

When the calibration mode is ON then the unit will automatically set up the required conditions in the unit as you enter each sub-menu. For example, if you go into the CntrFreq sub-menu, the unit will automatically go into free run. For obvious reasons this should not be done on a unit that is being used On Air.



V6416 Up Down Cross Converter

4.2 Free-Run Frequency

There is a voltage controlled crystal oscillator, which is usually locked to the external video reference or to the input video. However if there is no input or reference then it will free-run and this free running frequency should be set. The oscillator is not accurate enough to be used as a frequency reference, but nevertheless, should be set close to the ideal so that any succeeding SDI equipment will be able to lock to its output, and so that when in free run it will only drift slowly away from its starting reference.

To calibrate the frequency set the unit into Free Run by turning Cal Mode ON and selecting the CntrFreq sub-menu.

```
CALIB      Cal Mode  Cal On
```

Now compare the output picture movement on a monitor with an accurate external reference and adjust the frequency accordingly.

```
CALIB      CntrFreq          Range is -127 to +128
```

The setting is stored on the unit in non-volatile memory, and should not need regular adjustment.



5 Controls

The following tables show a complete list of all the parameters that can be controlled locally for the various configurations. Unless otherwise shown they can also be controlled over the DART remote control system. Not all menus are available at any one time, since they depend on module configurations and sometimes on the operating conditions.

The tables also show the full range of the controls and their ranges and normalised value, if appropriate. The normalised value or setting is shown by the 'n'.

5.1 Video Processing – VIDEO

Main Menu	Sub Menu	Value		Comment	Notes
VIDEO	Source	I/P 1	n	Input Selection	
		I/P 2			
	O/P LStd	Vid I/P	n	Output line standard. Vid I/P selects the input line standard.	
		525i			
		625i			
		1080i			
	O/P FldR	Auto	n	Output field rate. Auto selects the input frame rate.	
		59.94Hz			
		50Hz			
	AR Up	16:9 ANA	n	Aspect ratio control for up-conversions. (SD > HD)	†
		4:3 PB			
		14:9 PB			
		16:9 CC			
	AR Down	4:3 ANA	n	Aspect ratio control for down-conversions. (HD > SD)	†
		16:9 LB			
		14:9 LB			
		4:3 CC			
	AR SD>SD	[] > []	n	Aspect ratio control for standard definition (ARC) conversions. (SD > SD)	†
		[] > 16:9 ^c _c			
		[] > 14:9 ^p _B			
		[] > 16:9 ^c _c			
		[] > []			
		[] > 16:9 ^L _B			
[] > 14:9 ^L _B					
[] > 4:3 ^c _c					
ConvMode	Man	n	Aspect Ratio control Manual or auto AFD		
	AFD				
SD Width	SDwd Dig	n	Selects whether SD aspect ratios should be based on analogue or digital blanking.		
	SDwd Ana				
Norm	*****				

† These Aspect Ratio controls will modify the output image ONLY when the **ConvMode** control bit is set to **Man**.



V6416 Up Down Cross Converter

5.2 Active Format Description – AFD

Main Menu	Sub Menu	Value		Comment	Notes
AFD	AFD Ins	Off	n	Do not insert AFD on the output signal	
		On		Insert AFD on the output signal	
	AFD Line	Ln20/583		< 1080i50 O/P	
		↓		AFD output line select	
		Ln13/576	n	< 1080i50 O/P	
		↓			
	OP AR SD	Ln 5/568		< 1080i50 O/P	
		4:3	n	SD service O/P coded frame : 4:3	
	LostFlag	16:9		SD service O/P coded frame : 16:9	
		Default	n	AFD missing on I/P : use default AFD value	
	AFD Mode	Last I/P		: use last valid received I/P AFD value	
		Auto	n	Normal mode: respond to I/P AFD value	
	Dflag_SD	Force		Override I/P AFD value with a forced value	
		16:9 15		Default (I/P) AFD flag when the input to the unit is of standard definition format.	
		↓		A default AFD value is used when there is no valid AFD flag on the input signal, and the LostFlag bit is set to Default	
		16:9 0			
		4:3 15			
		↓			
	Dflag_HD	4:3 8	n		
		↓			
		4:3 0			
		↓			
	Fflag_SD	16:9 15		Default (I/P) AFD flag when the input to the unit is of high definition format.	
		↓		A default AFD value is used when there is no valid AFD flag on the input signal, and the LostFlag bit is set to Default	
		16:9 8	n		
		↓			
	Fflag_HD	16:9 0			
		4:3 15		Force (I/P) AFD flag when the input to the unit is of standard definition format.	
↓			A forced AFD value is used when the AFD present on the input signal is either unreliable or wrong.		
4:3 8		n	A forced AFD value only becomes active when the AFD Mode bit is set to Force		
↓					
Norm	4:3 0				
	16:9 15		Force (I/P) AFD flag when the input to the unit is of high definition format.		
	↓		A forced AFD value is used when the AFD present on the input signal is either unreliable or wrong.		
	16:9 8	n	The AFD Mode bit must be set to Force .		
Fflag_SD	↓				
	16:9 0				
	↓				
Fflag_HD	16:9 8	n			
	↓				
	16:9 0				
Norm	*****				

V6416 Up Down Cross Converter



5.3 Video Proc Amp – PROC AMP

Main Menu	Sub Menu	Value		Comment	Notes	
PROC AMP	V Gain	-6.02dB		Video Gain Control		
		↓				
		-0.00dB	n			
		↓				
			+6.01dB			
	C Gain	-6.02dB		Chroma Gain Control		
		↓				
		-0.00dB	n			
		↓				
			+6.01dB			
	Blk Lvl	-128		Black Level Control		
		↓				
		+0	n			
		↓				
			+127			
	Hue	-45.00°		Hue Control		
		↓				
		+0.00°	n			
		↓				
			+44.65°			
	Bypass	Byp Off	n	Proc Amp Bypass Off		
		Byp On		Proc Amp Bypass On		
	Dyn Rdn	DR On	n	Dynamic Rounding On		
		DR Off		Dynamic Rounding Off		
Hrd Clip	HClp Off	n	Hard Clipping Off			
	HClp On		Hard Clipping On			
Fade>Blk	F>B Off	n	Fade to Black Off			
	F>B On		Fade to Black On			
Norm	*****					



V6416 Up Down Cross Converter

5.4 Audio Control - AUDIO

Main Menu	Sub Menu	Value		Comment	Notes
AUDIO	6302Data	6302 Off	n	Set this to ' 6302 On ' to allow the V6302 to embed audio data into the output.	
		6302 On			
	Aud Grps	1 2 3 4		Number indicates group present – indicates group absent	s
		- 2 - 4			
		- - - -			
	V6302	V6302 Ü		Ticked if V6302 module detected.	s
		V6302 X			
Norm	*****				

s These menu items are status only.

V6416 Up Down Cross Converter



5.5 Timing Adjustments - TIMING

Main Menu	Sub Menu	Value		Comment	Notes	
TIMING	H Timing	+0.00µs	n	Horizontal offset relative to external reference (µs)	†	
		↓				
		+22.23µs				
	V Timing	-256		Vertical offset relative to external reference (lines)		
		↓				
		+0	n			
		↓				
		+255				
	H Delay	+0	n	Horizontal offset relative to SDI input (µs)		‡
		↓				
	+749					
V Delay	+0.00µs	n	Vertical offset relative to SDI input (lines)			
	↓					
	+22.23µs					
Ref Src	Auto	n	Timing reference source. Auto selects external reference if present, otherwise selects the SDI input.			
	Vid I/P					
	Ref I/P					
RFL Mode	Min DLY	n	Reference fail mode.			
	Adj DLY					
Ref Std	^{R_F} No I/P		Shows the standard of the external reference.	s		
	^{R_F} 625i50					
	^{R_F} 525i59					
	...					
Norm	*****					

† Only available when timing is relative to an analogue reference. Range is dependent on output standard.

‡ Only available when timing is locked to the SDI input. Range is dependent on output standard.

n Default value.

s These menu items are status only.



V6416 Up Down Cross Converter

5.6 Auxiliary Data – AUX DATA

Main Menu	Sub Menu	Value		Comment	Notes
AUX DATA	TCG Jam	Off	n	Time Code Generator manual Jam sync control	
		Jam		Momentary control: forces Jam then returns to Off	
	TCG Ofst	+12h		O/P time code offset by +12 hours wrt I/P time code	
		↓		Integer hours offset control between I/P and O/P TC	
		+0h	n	No offset between I/P and O/P time codes	
		↓			
	TCG Load	Off	n	Time Code Generator manual Load control	
		Load		Momentary control: forces Load then returns to Off	
	TCG Src	TC ATC	n	TCG source: taken from ATC on input signal	
		TC DVITC		TCG source: taken from DVITC on input signal	
	DVITCIns	DVITCoff	n	Do not insert DVITC on the output signal	
		DVITC On		Insert DVITC on the output signal	
	DVITC Ln	Ln20/583		< 1080i50 O/P	
		↓		DVITC output line select	
		Ln13/576	n	< 1080i50 O/P	
		↓			
	ATC Read	Ln 5/568		< 1080i50 O/P	
		AR Any	n	ATC reader: read any form of ATC on I/P signal	
		AR LTC		ATC reader: only detect LTC coded ATC on I/P	
		AR VITC1		ATC reader: only detect VITC1 coded ATC on I/P	
	ATC Ins	AR VITC2		ATC reader: only detect VITC2 coded ATC on I/P	
		ATC Off	n	Do not insert ATC on the output signal	
	ATC Line	ATC On		Insert ATC on the output signal	
		Ln20/583		< 1080i50 O/P	
		↓		ATC output line select	
		Ln13/576	n	< 1080i50 O/P	
	ATC Loc	↓			
		Ln 5/568		< 1080i50 O/P	
	SID Ins	ATC VANC	n	Location of ATC on output signal: in VANC	
		ATC HANC		Location of ATC on output signal: in HANC	
	SID Line	SID Off	n	Do not insert Source ID on the output signal	
		SID On		Insert Source ID on the output signal	
Ln20/583			< 1080i50 O/P		
↓			SID output line select		
Norm	Ln13/576	n	< 1080i50 O/P		
	↓				
	Ln 5/568		< 1080i50 O/P		

V6416 Up Down Cross Converter



5.7 System Status – STATUS

Main Menu	Sub Menu	Value	Comment	Notes	
STATUS	Variant	UDX ARC			
	Options	TC	Time code option fitted		
	V6302	V6302 Ü		Ü indicates that the V6302 unit has been detected	s
		V6302 X			
	Aud Grps	1 2 3 4		Number indicates group present – indicates group absent	
		- 2 - 4			
		- - - -			
	Source	IP 1	Indicates the currently selected input.		
	I/P 1	IP 1 X	These indicate the presence of the two inputs.		
	I/P 2	IP 2 Ü			
	I/P Std	ⁱ _p 720p50	Format of the selected SDI input.		
	O/P Std	^o _p 525i59	Selected output SDI format.		
	Ref I/P	REF Ü	Indicates presence of external video reference.		
	Ref Std	^R _F No I/P ^R _F 625i50 ^R _F 525i59 ...	Shows the standard of the external reference.		
	SC Temp	48.1 °C	SC temperature.		
	TC Stat	TC Ü	Ü indicates presence of selected time code source.		
	DVITC TC	--h--m--s-- 02h15m45s06	DVITC Time Code read from selected input video.	† s	
	ATC TC	--h--m--s-- 09h39m07s01	ATC Time Code read from selected input video.		
	SID Text	No Sourc My SID Te...	Source ID text read from input.		
	Sub-Mod	* Fitted	Indicates that the video processor sub-module is fitted.	s	
AFD I/P	I/P AFD X 16:9_9 Ü	Indicates if there is an AFD packet present on the I/P			
AFD Raw	16:9_9 Ü 16:9_8 D 16:9_9 L 16:9_4 F	Indicates the raw I/P AFD value used when deciding best conversion to apply in auto conversion mode. Ü good incoming AFD D no I/P AFD:default value L no I/P AFD:last good val. F use forced override val.			
AFD O/P	16:9_8A 16:9_9M	Indicates the AFD flag value on the O/P of card. The suffix indicates Auto or Manual conversion mode of operation.			

† When these items are selected, use the up and down buttons on the front panel to navigate the displayed text.
s These menu items are status only.



V6416 Up Down Cross Converter

5.8 Engineering Menu – ENG'ING

Main Menu	Sub Menu	Value		Comment	Notes
ENG' ING	O/P EDH	EDH On	n	Enable/Disable EDH on SD outputs.	
		EDH Off			
	TCG Out	From I/P	n	Time code only inserted on output when it is detected on the input video.	
		Always		Time code always present on output video.	
	DefIpStd	720p59	n	Default input standard.	
	H Res	H High	n	Horizontal resolution control Note: This only applies to down conversions	
		H Medium			
		H Low			
	V Res	V High	n	Vertical resolution control. Note: This only applies to down conversions.	
		V Medium			
		V Low			
	Free-Run	Free Off	n	Forces the unit to ignore references and free-run.	
		Free On			
Norm	*****				

5.9 Calibration Menu – CALIB

Main Menu	Sub Menu	Value		Comment	Notes
CALIB	Cal Mode	Cal Off		Set to 'Cal On' to allow adjustment of 'CntrFreq'	
		Cal On			
	CntrFreq	Frq=-128		VCO centre frequency.	
		Frq= +0	n		
		Frq=+127			
Norm	*****				

V6416 Up Down Cross Converter



5.10 Configuration Menu – CONFIG

Main Menu	Sub Menu	Value		Comment	Notes
CONFIG	Banner	On	n	When 'On' enables warning message banners	
		Off			
	Sleep	^z _z 0 min	n	Length of time from last button push until front panel goes to sleep. When set to 0, the unit never sleeps.	
		...			
		^z _z 5 min			
	LEDLevel	^z _z 30 min		Display brightness control.	
		■■■■■			
		0			
	Variant	V6416		Unit variant options.	s
TestMode	Off	n	Puts unit into test mode.		
	On				
Factory	Mode Off		Test purposes only.	s	
Norm	*****				

5.11 System Version Information – VERSION

Main Menu	Sub Menu	Value		Comment	Notes
VERSION	PROM Ver	03.00		PROM stick version	†
	Soft Ver	05.01.00		Versions of software / firmware / hardware components.	‡
	Boot Ver	02.00.00			
	Strx Ver	1.4.00			
	FPGA Ver	01.02			
	CPLD Ver	00.01			
	Data Ver	29000002			
	PCB Ver	00.00			
	VModule	* HD PROC			
IOModule	STD [3]				

† These are the version numbers of the user upgradeable software in the V6416 'PROM Ver' relates to the physical memory stick plugged into the V6416 unit.

‡ These are constituent parts of the PROM stick.



6 Appendix

6.1 Trouble Shooting Guide (Frequently Asked Questions)

This section is to be a help in solving some common difficulties. If there is no control from the front panel first check that the Rem/Local switch is set to *Local*.

Q: My unit does not synchronise to the external reference.
A1: Check whether the Front Panel Ref. LED is lit. This indicates the presence of an ext. reference.
A2: Check whether the ext. reference input is selected. TIMING: Ref Src: Auto (or Ref IP)

Q: The Proc Amp does not work.
A1: Check whether it is set to Bypass. PROC AMP: Bypass: Byp Off

Q: The display never goes to sleep.
A1: Check whether the Sleep delay has been set to 0 Mins, which means stay awake.



6.2 Initialisation, Power On-Selftest & Error Messages

6.2.1 Board Initialisation Sequence

Every time a board goes through a power-on cycle, either by re-seating the board in the rack or by triggering the manual reset, a sequence of initialisation and self-test events is being carried out by the on-board microcontroller.

If anything goes wrong, an error message is shown on the front panel display and program execution halts. The following table shows the error messages and their meaning:

Flash upgrading	ERROR 01	Flash erasing failed
	ERROR 02	Flash programming failed
	ERROR 03	Main program checksum error after programming
	ERROR 04	Bootloader checksum error after programming
	ERROR 05	No program loaded and no valid upgrade in Flash Stick
	ERROR 06	Bootloader upgrade required but no valid bootloader upgrade in Flash Stick
FPGA Load	ERROR 07	STATUS stayed low after CONFIG pulsed low
	ERROR 08	DONE stayed high after CONFIG pulsed low
	ERROR 09	STATUS went low during configuration
	ERROR 10	DONE stayed low after configuration
Local EEPROM	ERROR 11	Error writing to local EEPROM
	ERROR 12	Error reading from EEPROM
	ERROR 13	Initialising EEPROM to default data
	ERROR 14	Initialising parameters to default data
Debug Port	ERROR 15	Receive buffer overflow
	ERROR 16	Receive overrun
	ERROR 17	Receive framing error
	ERROR 18	Receive parity error

6.3 Automatic (AFD controlled) Conversion Functions

The diagrams shown below and on the following page show the conversions that are applied by the V6416 when operating in the automatic conversion mode (VIDEO : ConvMode set to AFD).

Diagram colour keys:



Black regions indicate areas of the picture that are black.

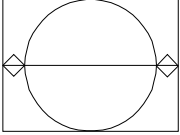
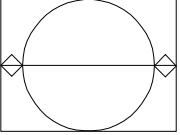
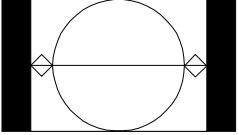
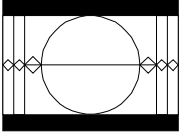
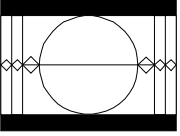
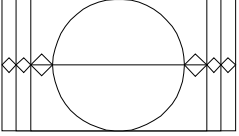
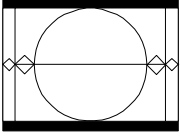
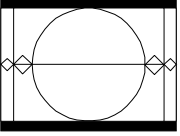
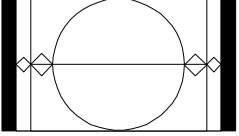
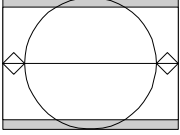
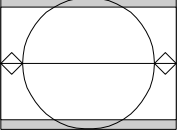
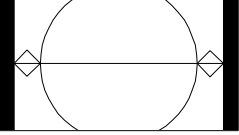
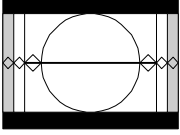
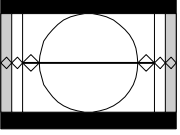
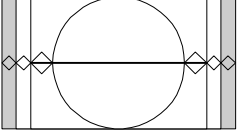

Grey regions indicate areas of the picture that may be cropped by a receiver without significant loss to the viewer.

Input Signal	4:3	Output Signal	16:9
4:3 Full frame image in a 4:3 coded frame  4:3_8	4:3 Full frame image in a 4:3 coded frame  4:3_8	4:3 Pillar-box image in a 16:9 coded frame  16:9_9	
16:9 Letterbox image in a 4:3 coded frame  4:3_10	16:9 Letterbox image in a 4:3 coded frame  4:3_10	16:9 Full frame image in a 16:9 coded frame  16:9_8	
14:9 Letterbox image in a 4:3 coded frame  4:3_11	14:9 Letterbox image in a 4:3 coded frame  4:3_11	14:9 Pillar-box image in a 16:9 coded frame  16:9_11	
4:3 image, shoot and protect 14:9 in a 4:3 coded frame  4:3_13	4:3 image, shoot and protect 14:9 in a 4:3 coded frame  4:3_13	14:9 Pillar-box image in a 16:9 coded frame  16:9_11	
16:9 Letterbox image, shoot and protect 14:9 in a 4:3 coded frame  4:3_14	16:9 Letterbox image, shoot and protect 14:9 in a 4:3 coded frame  4:3_14	16:9 image, shoot and protect 14:9 in a 16:9 coded frame  16:9_14	

V6416 Up Down Cross Converter

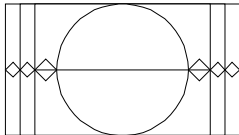
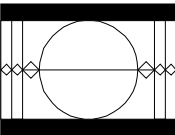
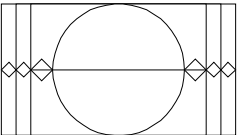
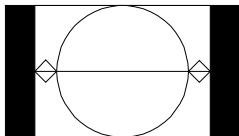
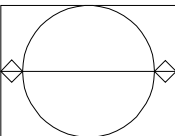
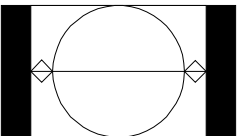
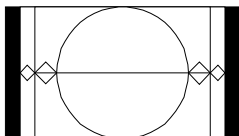
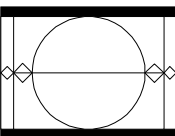
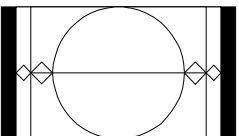
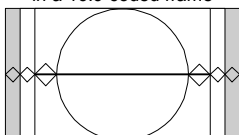
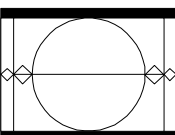
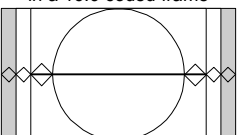
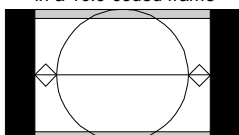
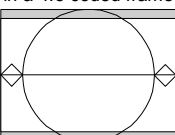
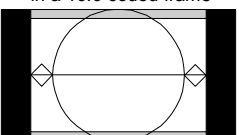
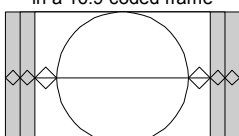
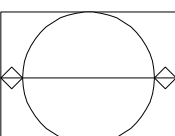
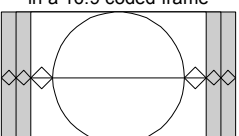
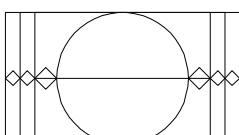
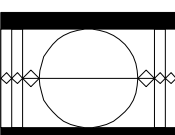
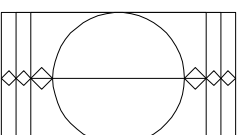

Input Signal	4:3	Output Signal 16:9
<p>16:9 Full frame image in a 16:9 coded frame</p>  <p>16:9_8</p>	<p>16:9 Letterbox image in a 4:3 coded frame</p>  <p>4:3_10</p>	<p>16:9 Full frame image in a 16:9 coded frame</p>  <p>16:9_8</p>
<p>4:3 Pillar-box image in a 16:9 coded frame</p>  <p>16:9_9</p>	<p>4:3 Full frame image in a 4:3 coded frame</p>  <p>4:3_8</p>	<p>4:3 Pillar-box image in a 16:9 coded frame</p>  <p>16:9_9</p>
<p>14:9 Pillar-box image in a 16:9 coded frame</p>  <p>16:9_11</p>	<p>14:9 Letterbox image in a 4:3 coded frame</p>  <p>4:3_11</p>	<p>14:9 Pillar-box image in a 16:9 coded frame</p>  <p>16:9_11</p>
<p>16:9 image, shoot and protect 14:9 in a 16:9 coded frame</p>  <p>16:9_14</p>	<p>14:9 Letterbox image in a 4:3 coded frame</p>  <p>4:3_11</p>	<p>16:9 image, shoot and protect 14:9 in a 16:9 coded frame</p>  <p>16:9_14</p>
<p>4:3 Pillar-box image, shoot and protect 14:9 in a 16:9 coded frame</p>  <p>16:9_13</p>	<p>4:3 image, shoot and protect 14:9 in a 4:3 coded frame</p>  <p>4:3_13</p>	<p>4:3 Pillar-box image, shoot and protect 14:9 in a 16:9 coded frame</p>  <p>16:9_13</p>
<p>16:9 image, shoot and protect 4:3 in a 16:9 coded frame</p>  <p>16:9_15</p>	<p>4:3 Full frame image in a 4:3 coded frame</p>  <p>4:3_8</p>	<p>16:9 image, shoot and protect 4:3 in a 16:9 coded frame</p>  <p>16:9_15</p>
<p>16:9 Full frame image in a 16:9 coded frame</p>  <p>16:9_10</p>	<p>16:9 Letterbox image in a 4:3 coded frame</p>  <p>4:3_10</p>	<p>16:9 Full frame image in a 16:9 coded frame</p>  <p>16:9_10</p>



V6416 Up Down Cross Converter

6.4 Menu Structure

The following page summarizes the menu structure on the V6416 module.

Please note that the presence of some sub-menus depend on the factory configuration of your module. In other words, if an option is not fitted, the entire sub-menu belonging to it will not appear in the menu structure.



V6416 Menu Structure

