

K2™

MEDIA CLIENT

System Guide

● → SOFTWARE VERSION 3.0

071-8460-00
NOVEMBER 2005

the most watched worldwide

Copyright

Copyright © 2005 Thomson Broadcast and Media Solutions, Inc. All rights reserved. Printed in the United States of America.

This document may not be copied in whole or in part, or otherwise reproduced except as specifically permitted under U.S. copyright law, without the prior written consent of Thomson Broadcast and Media Solutions, Inc., P.O. Box 59900, Nevada City, California 95959-7900

Trademarks

Grass Valley, K2, Profile, and Profile XP are either registered trademarks or trademarks of Thomson Broadcast and Media Solutions, Inc. in the United States and/or other countries. Other trademarks used in this document are either registered trademarks or trademarks of the manufacturers or vendors of the associated products. Thomson Broadcast and Media Solutions, Inc. products are covered by U.S. and foreign patents, issued and pending. Additional information regarding Thomson Broadcast and Media Solutions, Inc. trademarks and other proprietary rights may be found at www.thomsongrassvalley.com.

Disclaimer

Product options and specifications subject to change without notice. The information in this manual is furnished for informational use only, is subject to change without notice, and should not be construed as a commitment by Thomson Broadcast and Media Solutions, Inc. Thomson Broadcast and Media Solutions, Inc. assumes no responsibility or liability for any errors or inaccuracies that may appear in this publication.

**U.S. Government
Restricted Rights
Legend**

Use, duplication, or disclosure by the United States Government is subject to restrictions as set forth in subparagraph (c)(1)(ii) of the Rights in Technical Data and Computer Software clause at DFARS 252.277-7013 or in subparagraph c(1) and (2) of the Commercial Computer Software Restricted Rights clause at FAR 52.227-19, as applicable. Manufacturer is Thomson Broadcast and Media Solutions, Inc., P.O. Box 59900, Nevada City, California 95959-7900 U.S.A.

Revision Status

Rev Date	Description
November 23, 2005	Initial release of the K2 Media Client System Guide — 071-8460-00

Contents

	Safety Summaries	7
	Safety Terms and Symbols	8
	Service Safety Summary	9
	Certifications and Compliances.....	9
	Finding Information	13
	Getting more information	14
	Grass Valley Product Support	16
Chapter 1	Product Description	
	K2 Media Client features	18
	Features of Standard Definition models	18
	Features of High Definition models	18
	Features of internal storage models	19
	Features of external storage models	19
	Introducing K2 Media Client models.....	20
	Introducing the SD-04.....	21
	Introducing the HD-02	22
	Introducing the HD-03	23
	Introducing the HD-04	24
	Introducing the HD-12	25
	Introducing the HD-13	26
	Introducing the HD-22	27
	Front panel indicators	28
	Rear panel view.....	29
	SD rear panel view	29
	HD rear panel view	30
	K2 Media Client system overview	31
	Application System	32
	Real Time System	32
	Media control and processing	33
	Locations of rear panel boards	35
	RS-422 ports	35
	RAID drive numbering	36
Chapter 2	Using K2 Media Client system tools	
	Configuration Manager	37
	Accessing Configuration Manager.....	37
	Saving and restoring Configuration Manager settings	37
	Restoring default Configuration Manager settings	38
	K2 System Configuration.....	38
	Storage Utility	40
	NetCentral	41
Chapter 3	System connections and configuration	
	Network connections and configuration	43
	Cable requirements	43
	About teaming Ethernet ports.....	44
	Connecting the Ethernet network cabling	44
	Data and streaming for K2 Media Client systems	45
	Configure Windows network settings	46
	Streaming video between K2 systems	49
	Modifying network settings	53
	Using FTP for file transfer	53
	FTP commands supported	53
	Connecting RS-422	55
	RS-422 ports and channels	56

	AMP TCP Interface	56
	Connecting GPI	57
Chapter 4	Managing Internal Storage	
	About the K2 Media Client internal storage system	59
	Using Storage Utility	59
	Opening Storage Utility	60
	Overview of Storage Utility	62
	Checking storage subsystem status	63
	Checking controller microcode	63
	Identifying disks	63
	Get controller logs	64
	Check disk mode pages	65
	Disabling a disk	65
	Forcing a disk to rebuild	65
	Unbind LUN	66
	Bind Luns	66
	Make New File System	68
	Check File System	68
	Cleaning unreferenced files and movies	69
	Loading RAID controller microcode	70
	Downloading disk drive firmware	70
	Storage Utility operation not supported	71
	Placing the K2 Media Client into online mode	71
Chapter 5	Managing K2 client system software	
	About K2 Media Client system software	73
	Software components installed	74
	Installing Control Point software	74
	Installing K2 software	75
	Re-installing Grass Valley software	75
	Pre-installed software	76
	K2 Media Client pre-installed software	76
	K2 Media Server pre-installed software	77
	Grass Valley Control Point PC pre-installed software	78
	Backup and recovery strategies	78
Chapter 6	Administering and maintaining the K2 system	
	Synchronizing system clocks	79
	Licensing	79
	Security considerations	79
	K2 and NetCentral security considerations	80
	Virus scanning and protection policies	82
	Enabling and disabling the USB ports	83
Chapter 7	External Storage	
	About load balancing	86
	Determining K2 Media Client bandwidth requirements	87
	Preparing the K2 Storage System	87
	Preparing K2 Media Clients	87
	Adding K2 Media Clients	90
	Configuring a K2 Media Client for the K2 Storage System	90
	Basic operations for external storage K2 Media Clients	96
	Power on/off procedures	96
	Taking a K2 Media Client offline	96

Appendix A	Specifications	
	AC power specification	98
	Environmental specifications	98
	Mechanical specifications	99
	Electrical specifications	99
	Serial Digital Video (SDI)	99
	Genlock Reference	100
	System Timing	101
	AES/EBU Digital Audio	102
	LTC Input/Output	102
	VITC Input/Output	103
	RS-422 specification	103
	GPI I/O specifications	103
	Operational specifications	104
	Video codec description – SD-only models	105
	Video codec description – HD/SD models	105
	Playout of multiple formats	106
	VBI/Ancillary data specifications	109
	Internationalization	114
	Video network performance	114
	Supported file input/output formats	115
	Media file system performance	116
	Protocols supported	116
	Transfer compatibility considerations	116
	Control point PC system requirements	117
Appendix B	Connector Pin-outs	
	Rear panel connector pin-outs	120
	RS-422 connector pinouts	120
	LTC connectors pinouts	120
	GPI I/O connector pinouts	121
Appendix C	Rack-mounting	
	Rack-mount considerations	123
	Rack mount hardware shipped with the K2 client system	124
	Mounting the Rack Slides	125
	Installing the K2 client system on the rack mount rails	126
	Making Rack Slide Adjustments	127
	Index	129

Safety Summaries

General Safety Summary

Review the following safety precautions to avoid injury and prevent damage to this product or any products connected to it.

Only qualified personnel should perform service procedures.

While using this product, you may need to access other parts of the system. Read the *General Safety summary* in other system manuals for warnings and cautions related to operating the system.

Injury Precautions

Use Proper Power Cord

To avoid fire hazard, use only the power cord specified for this product.

Ground the Product

This product is grounded through the grounding conductor of the power cord. To avoid electric shock, the grounding conductor must be connected to earth ground. Before making connections to the input or output terminals of the product, ensure that the product is properly grounded.

Do Not Operate Without Covers

To avoid electric shock or fire hazard, do not operate this product with covers or panels removed.

Do Not operate in Wet/Damp Conditions

To avoid electric shock, do not operate this product in wet or damp conditions.

Do Not Operate in an Explosive Atmosphere

To avoid injury or fire hazard, do not operate this product in an explosive atmosphere.

Avoid Exposed Circuitry

To avoid injury, remove jewelry such as rings, watches, and other metallic objects. Do not touch exposed connections and components when power is present.

Product Damage Precautions

Use Proper Power Source

Do not operate this product from a power source that applies more than the voltage specified.

Provide Proper Ventilation

To prevent product overheating, provide proper ventilation.

Do Not Operate With Suspected Failures

If you suspect there is damage to this product, have it inspected by qualified service personnel.

Battery Replacement

To avoid damage, replace only with the same or equivalent type. Dispose of used battery according to the circuit board manufacturer's instructions.

Safety Terms and Symbols

Terms in This Manual

These terms may appear in this manual:



WARNING: Warning statements identify conditions or practices that can result in personal injury or loss of life.



CAUTION: Caution statements identify conditions or practices that may result in damage to equipment or other property, or which may cause equipment crucial to your business environment to become temporarily non-operational.

Terms on the Product

These terms may appear on the product:

DANGER indicates a personal injury hazard immediately accessible as one reads the marking.

WARNING indicates a personal injury hazard not immediately accessible as you read the marking.

CAUTION indicates a hazard to property including the product.

Symbols on the Product

The following symbols may appear on the product:



DANGER high voltage



Protective ground (earth) terminal



ATTENTION – refer to manual

Service Safety Summary



WARNING: *The service instructions in this manual are intended for use by qualified service personnel only. To avoid personal injury, do not perform any servicing unless you are qualified to do so. Refer to all safety summaries before performing service.*

Do Not Service Alone

Do not perform internal service or adjustment of this product unless another person capable of rendering first aid and resuscitation is present.

Disconnect Power

To avoid electric shock, disconnect the main power by means of the power cord or, if provided, the power switch.

Use Care When Servicing With Power On

Dangerous voltages or currents may exist in this product. Disconnect power and remove battery (if applicable) before removing protective panels, soldering, or replacing components.

To avoid electric shock, do not touch exposed connections

Certifications and Compliances

Canadian Certified Power Cords

Canadian approval includes the products and power cords appropriate for use in the North America power network. All other power cords supplied are approved for the country of use.

FCC Emission Control

This equipment has been tested and found to comply with the limits for a Class A digital device, pursuant to Part 15 of the FCC Rules. These limits are designed to provide reasonable protection against harmful interference when the equipment is operated in a commercial environment. This equipment generates, uses, and can radiate radio frequency energy and, if not installed and used in accordance with the instruction manual, may cause harmful interference to radio communications. Operation of this equipment in a residential area is likely to cause harmful interference in which case the user will be required to correct the interference at his own expense. Changes or modifications not expressly approved by Grass Valley can affect emission compliance and could void the user's authority to operate this equipment.

Canadian EMC Notice of Compliance

This digital apparatus does not exceed the Class A limits for radio noise emissions from digital apparatus set out in the Radio Interference Regulations of the Canadian Department of Communications.

Le présent appareil numérique n'émet pas de bruits radioélectriques dépassant les limites applicables aux appareils numériques de la classe A prescrites dans le Règlement sur le brouillage radioélectrique édicté par le ministère des Communications du Canada.

EN55103 1/2 Class A Warning

This product has been evaluated for Electromagnetic Compatibility under the EN 55103-1/2 standards for Emissions and Immunity and meets the requirements for E4 environment.

This product complies with Class A (E4 environment). In a domestic environment this product may cause radio interference in which case the user may be required to take adequate measures.

FCC Emission Limits

This device complies with Part 15 of the FCC Rules. Operation is subject to the following two conditions: (1) This device may not cause harmful interference, and (2) this device must accept any interference received, including interference that may cause undesirable operation.

Laser Compliance

Laser Safety Requirements

The device used in this product is a Class 1 certified laser product. Operating this product outside specifications or altering its original design may result in hazardous radiation exposure, and may be considered an act of modifying or new manufacturing of a laser product under U.S. regulations contained in 21CFR Chapter 1, subchapter J or CENELEC regulations in HD 482 S1. People performing such an act are required by law to recertify and reidentify this product in accordance with provisions of 21CFR subchapter J for distribution within the U.S.A., and in accordance with CENELEC HD 482 S1 for distribution within countries using the IEC 825 standard.

Laser Safety

Laser safety in the United States is regulated by the Center for Devices and Radiological Health (CDRH). The laser safety regulations are published in the "Laser Product Performance Standard," Code of Federal Regulation (CFR), Title 21, Subchapter J.

The International Electrotechnical Commission (IEC) Standard 825, "Radiation of Laser Products, Equipment Classification, Requirements and User's Guide," governs laser products outside the United States. Europe and member nations of the European Free Trade Association fall under the jurisdiction of the Comité Européen de Normalization Electrotechnique (CENELEC).

Safety Certification

This product has been evaluated and meets the following Safety Certification Standards:

Standard	Designed/tested for compliance with:
ANSI/UL60950, CAN/CSA C22.2 No. 60950-00 12/01/2000	Safety of Information Technology Equipment, including Electrical Business Equipment (Third edition).
IEC 950	Safety of Information Technology Equipment, including Electrical Business Equipment (Third edition, 1999).
EN60950	Safety of Information Technology Equipment, including Electrical Business Equipment (Third Edition 2000).

Finding Information

This manual describes K2 Media Client systems and provides all the information you need to go beyond factory default settings and customize your system's configuration to meet your site-specific needs. The manual contains information for all models and options, including both internal storage and external storage K2 Media Clients. Refer to the sections that apply to your particular model and options.

How this manual is organized

This manual is organized around the tasks required to install and configure the K2 Media Client. The following describes the chapters included in this manual:

[Chapter 1, *Product Description*](#)

[Chapter 2, *Using K2 Media Client system tools*](#)

[Chapter 3, *System connections and configuration*](#)

[Chapter 4, *Managing Internal Storage*](#)

[Chapter 5, *Managing K2 client system software*](#)

[Chapter 6, *Administering and maintaining the K2 system*](#)

[Chapter 7, *External Storage*](#)

[Appendix A, *Specifications*](#)

[Appendix B, *Connector Pin-outs*](#)

[Appendix C, *Rack-mounting*](#)

Getting more information

The following illustration shows the recommended order in which to reference the documentation.

Path for the installer of K2 Media Client models with internal storage

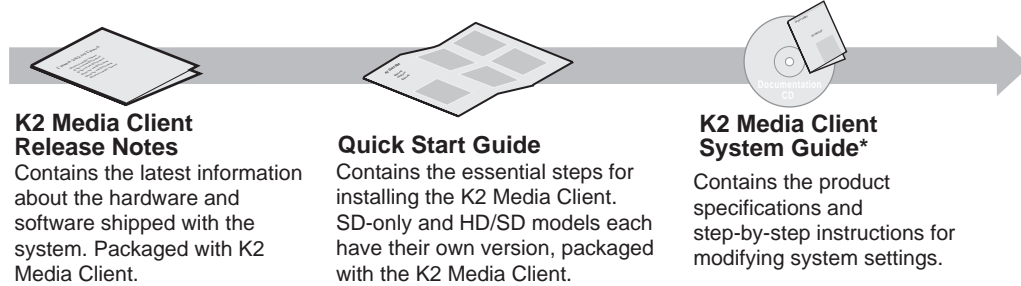

Path for the installer of the K2 Storage System with connected K2 Media Clients

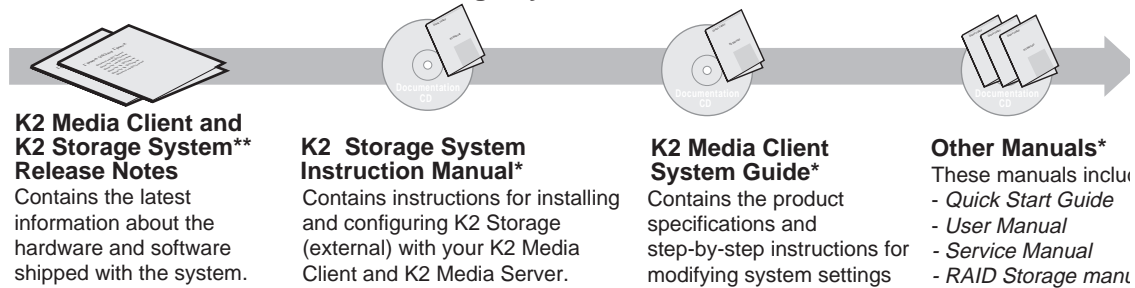

Path for the operator

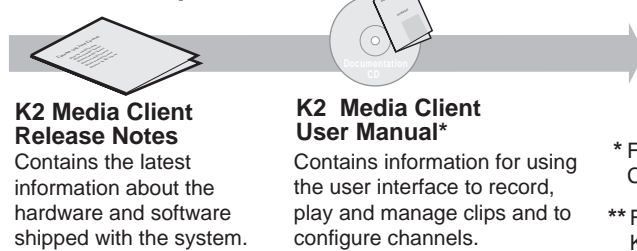

* Find the K2 Documentation CD packaged with K2 Media Clients and with K2 RAID Storage devices, primary cd

** Find the K2 Storage System Release Notes package
K2 RAID Storage devices, primary chassis.

Quick Start Guide

You receive this guide in the product packaging with your K2 Media Client. The Quick Start Guide provides step-by-step installation instructions for basic installation and operation of your SD or HD/SD K2 Media Client, including recording and playing clips.

Release Notes

The release notes contain the latest information about the K2 Media Client software shipped on your system. There are K2 Storage System release notes and K2 Media Client release notes. The information in this document includes software upgrade instructions, software specifications and requirements, feature changes from the previous releases, and any known problems. Because release notes contain the latest information, they are printed out rather than included in the Documentation CD-ROM.

K2 Documentation CD

Except for the release notes and Quick Start guide, the full set of support documentation, including this manual, is available on the Documentation CD-ROM that you received with your K2 Media Client.

The K2 Documentation CD includes the following documents:

- **K2 Media Client User Manual** — Describes the K2 Media Client and provides instructions for operating the product in a variety of applications.
- **K2 Media Client System Guide** — This guide provides all the information you need to go beyond factory default settings and customize your system's configuration to meet your site-specific needs.
- **K2 Media Client Service Manual** — Contains information for solving common setup problems, as well as information on servicing and maintenance
- **K2 Storage System Instruction Manual** — Contains installation and configuration procedures for shared storage options. Also includes administrative and maintenance procedures.
- **K2 RAID Storage Instruction Manuals** — Contains procedures for troubleshooting and servicing the different level RAID storage devices.

NetCentral documentation

The NetCentral product has its own documentation set, described as follows:

- **NetCentral User Guide** — This is a printed manual. It provides instructions for installing, using, and administering the NetCentral monitoring system.
- **NetCentral Help** — From the NetCentral interface access on-line help as follows:
 - For general help with NetCentral manager, select **Help | NetCentral Help Topics**. This content is identical to that in the NetCentral User Guide.
 - For help specific to monitoring K2 Media Client system devices, select **Help | Device Providers** and then select the monitored device.

Thomson Grass Valley Web Site

This public Web site contains all the latest manuals and documentation, and additional support information. Use the following URL.

<http://www.thomsongrassvalley.com>.

Grass Valley Product Support

To get technical assistance, check on the status of problems, or report new problems, contact Grass Valley Product Support via e-mail, the Web, or by phone or fax.

Web Technical Support

To access support information on the Web, visit the product support Web page on the Grass Valley Web site. You can download software or find solutions to problems by searching our Frequently Asked Questions (FAQ) database.

World Wide Web: <http://www.thomsongrassvalley.com/support/>

Technical Support E-mail Address: gvtechsupport@thomson.net.

Phone Support

Use the following information to contact product support by phone during business hours. Afterhours phone support is available for warranty and contract customers.

United States	(800) 547-8949 (Toll Free)	France	+33 (1) 34 20 77 77
Latin America	(800) 547-8949 (Toll Free)	Germany	+49 6155 870 606
Eastern Europe	+49 6155 870 606	Greece	+33 (1) 34 20 77 77
Southern Europe	+33 (1) 34 20 77 77	Hong Kong	+852 2531 3058
Middle East	+33 (1) 34 20 77 77	Italy	+39 06 8720351
Australia	+61 1300 721 495	Netherlands	+31 35 6238421
Belgium	+32 2 3349031	Poland	+49 6155 870 606
Brazil	+55 11 5509 3440	Russia	+49 6155 870 606
Canada	(800) 547-8949 (Toll Free)	Singapore	+656379 1390
China	+86 106615 9450	Spain	+ 34 91 512 03 50
Denmark	+45 45968800	Sweden	+46 87680705
Dubai	+ 971 4 299 64 40	Switzerland	+41 (1) 487 80 02
Finland	+35 9 68284600	UK	+44 870 903 2022

Authorized Support Representative

A local authorized support representative may be available in your country. To locate the support representative for your country, visit the product support Web page on the Grass Valley Web site.

Product Description

The K2 Media Client is a cost-effective Broadcast Enterprise Server that incorporates IT server platform and storage technologies to deliver a networked solution to facilities for ingest, playout, news integration, and media asset management. It is a comprehensive platform that provides a suite of user applications and system tools.

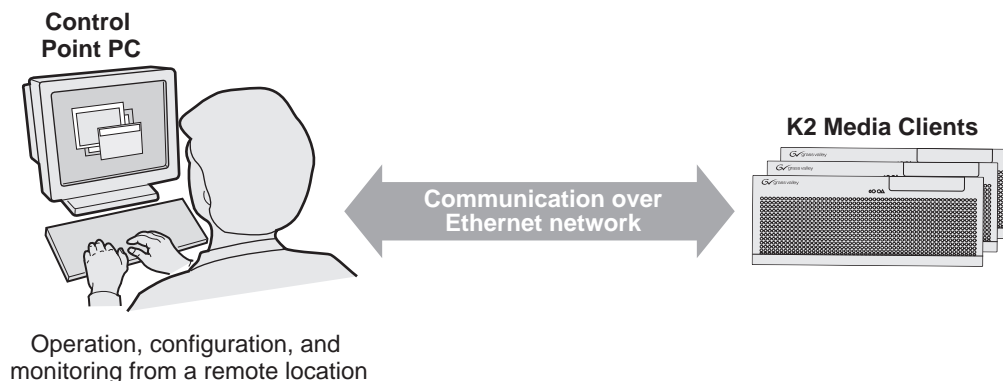

The K2 Media Client is designed for “headless” operation from a remote control point.

The K2 Media Client product is further described in the following sections:

- [“K2 Media Client features” on page 18](#)
- [“Introducing K2 Media Client models” on page 20](#)
- [“Front panel indicators” on page 28](#)
- [“Rear panel view” on page 29](#)
- [“K2 Media Client system overview” on page 31](#)

K2 Media Client features

This section provides an overview of K2 Media Client features. Refer to [Appendix A, Specifications](#) for details.

The following features are common to all models:

- Four channels (maximum) per chassis
- SDI video inputs and outputs
- AES/EBU or embedded audio inputs and outputs.
- Redundant power supply, RAID 1 protected Windows XP system disk, cooling fans for reliability
- RAID media storage
- Remote operation and configuration via AppCenter workstation
- NetCentral™ provides remote error reporting and monitoring via SNMP (Optional for models using internal storage only)
- Gigabit Ethernet
- AMP, VDCP, and BVW remote control protocols supported
- Remote control over RS-422 or Ethernet
- GPI Trigger (12 I/O)
- Support for import of various media and graphics file formats, with transcode as necessary to native file format.

Features of Standard Definition models

Standard definition (SD) models are SD-only, in that they neither encode nor decode high-definition video. SD-only models have bi-directional video codecs, which means each of the four channels can be configured to be either a record or a play channel. You can encode and decode video using the DVCAM, DVCPRO or MPEG-2 compression standards. You can play clips of any of these compression types through any play channel without any configuration changes. For example, you can play DV, DVCPRO25, DVCPRO50, and MPEG-2 clips back-to-back on the same timeline.

SD-only models support encode and decode of VBI data.

Features of High Definition models

High definition (HD) models are really HD/SD, in that they can process either SD or HD video. However, only the MPEG-2 compression standard is used in these HD/SD models. In addition, these models use dedicated encoders for recording and dedicated decoders for playing. The number and type (record or play) of channels in the chassis is determined by the model.

Record channels can record either SD or HD through an HD encoder. Play channels play both SD and HD clips through an Agile HD decoder. Both HD and SD clips are played out in the format specified for the output assigned to the channel. All clips are

either up- or down-converted appropriately to play on that output, and their aspect ratios are adjusted. For example, you can play 50 Hz SD 625, HD 1080i at 25 Hz, and HD 720p at 50 Hz clips back-to-back on the same timeline.

HD/SD models support encode and decode of SD VBI data and HD Ancillary data, with appropriate up/down conversion for playout.

Features of internal storage models

Both HD/SD and SD-only models are available with internal storage, consisting of 12 disk drives configured as six RAID 1 pairs, or LUNs. One LUN is the system drive, while five LUNs are for media storage. This makes the internal storage K2 Media Client a self-contained, stand-alone unit, with no external devices for storage, audio, or video connections required. You can transfer media in and out of the internal storage K2 Media Client via Gigabit Ethernet.

Refer to [Chapter 4, *Managing Internal Storage*](#) for more information.

Features of external storage models

Both HD and SD-only models are available as external storage clients. Multiple external storage K2 Media Clients connect to the K2 storage system via Gigabit Ethernet to share a common pool of storage. The external storage K2 Media Client contains two internal disk drives that make up the RAID 1 system drive.

Refer to [Chapter 7, *External Storage*](#) and the *K2 Storage System Instruction Manual* for more information.

Introducing K2 Media Client models

The following sections provide overview descriptions of the different K2 Media Client models.

Introducing the SD-04

The SD-04 model has four SD bidirectional channels. Each bi-directional channel can be configured as either a record channel or a play channel depending upon your needs at the time. You can have four record channels, four play channels, or a combination of record and play channels.

The illustration below shows the SD-04 with internal storage.

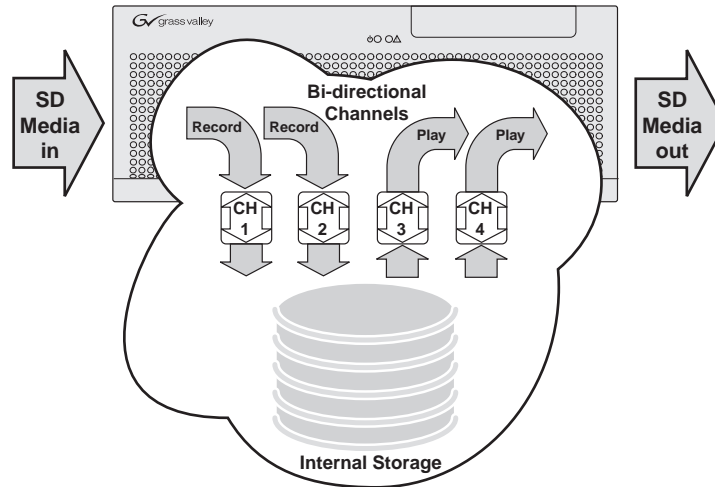

The illustration below shows the SD-04 with external storage. You can connect multiple SD-04 models or other external storage models to a K2 storage system to share a common pool of storage.

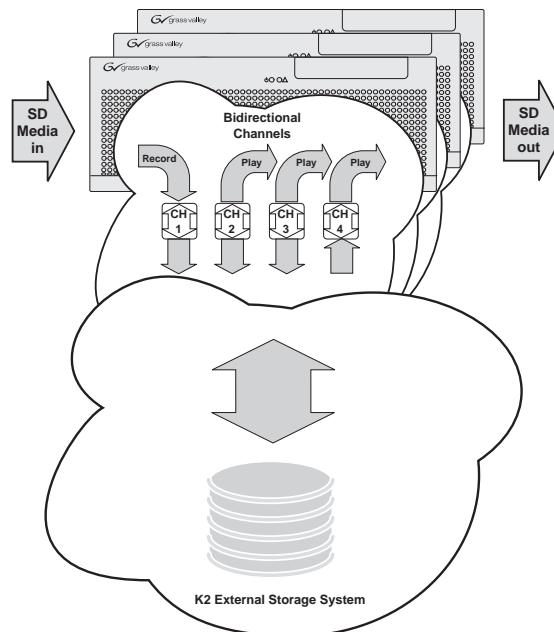

Introducing the HD-02

HD-02 model has two output channels and internal storage. Output channels are Agile, in that you can configure each channel to output either SD or HD; the clips (either SD or HD) are automatically up-converted or down-converted accordingly. The illustration below shows the HD-02 with internal storage.

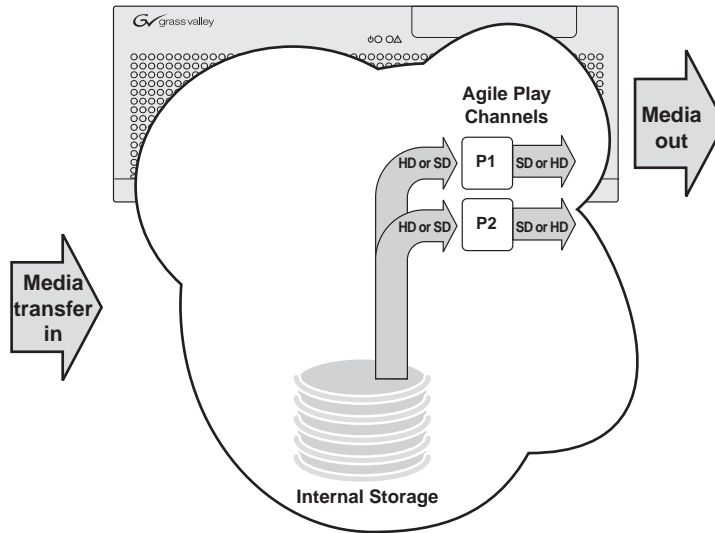

The illustration below shows the HD-02 with external storage. You can connect multiple HD-02 models or other external storage models to a K2 storage system to share a common pool of storage.

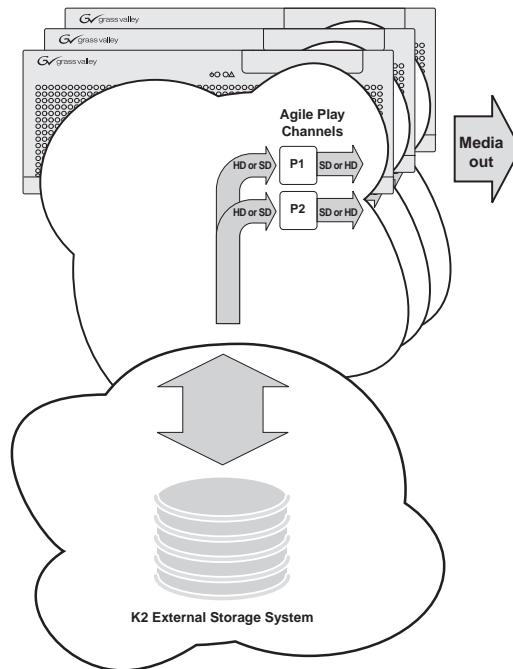

This is a playout-only unit, with media input via transfer.

Introducing the HD-03

The HD-03 model has three output channels and internal storage. Output channels are Agile, in that you can configure each channel to output either SD or HD; the clips (either SD or HD) are automatically up-converted or down-converted accordingly. The illustration below shows the HD-03 with internal storage.

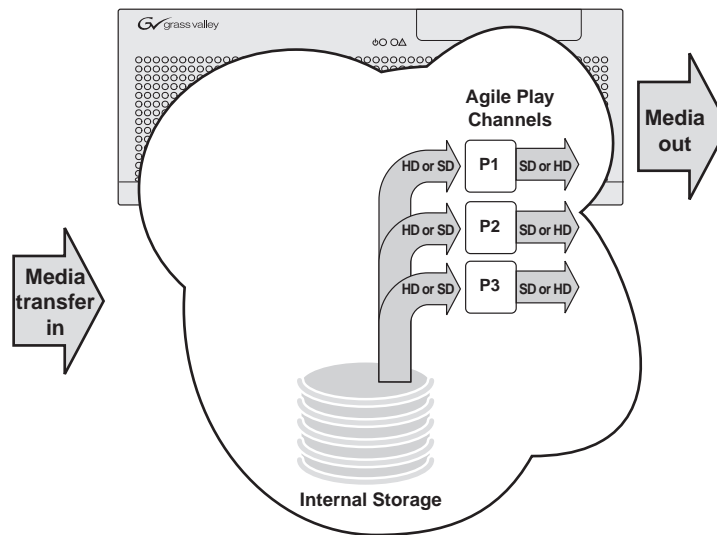

The illustration below shows the HD-03 with external storage. You can connect multiple HD-03 models or other external storage models to a K2 storage system to share a common pool of storage.

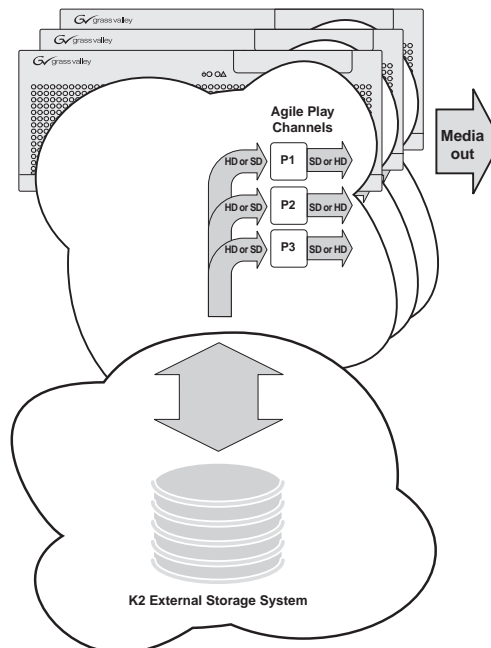

This is a playout-only unit, with media input via transfer.

Introducing the HD-04

The HD-04 model has four output channels and internal storage. Output channels are Agile, in that you can configure each channel to output either SD or HD; the clips (either SD or HD) are automatically up-converted or down-converted accordingly. The illustration below shows the HD-04 with internal storage.

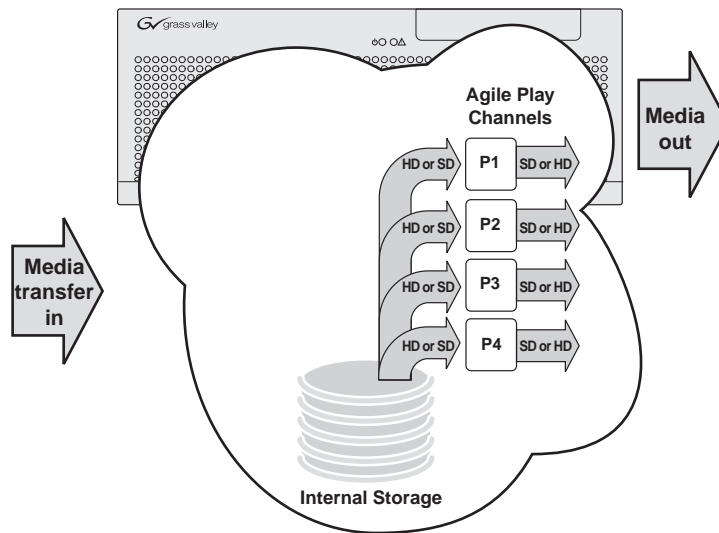

The illustration below shows the HD-04 with external storage. You can connect multiple HD-04 models or other external storage models to a K2 storage system to share a common pool of storage.

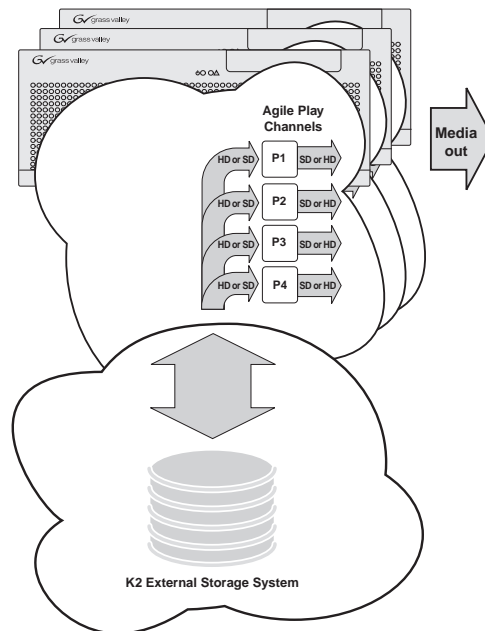

This is a playout-only unit, with media input via transfer.

Introducing the HD-12

The HD-12 model has one input channel, two output channels, and internal storage. The input channel can be configured to record either SD or HD. Output channels are Agile, in that you can configure each channel to output either SD or HD; the clips (either SD or HD) are automatically up-converted or down-converted accordingly. The illustration below shows the HD-12 with internal storage.

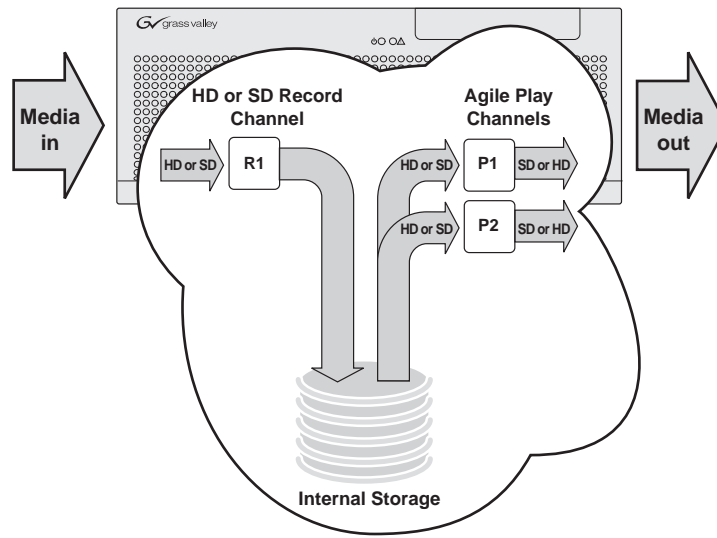

The illustration below shows the HD-12 with external storage. You can connect multiple HD-12 models or other external storage models to a K2 storage system to share a common pool of storage.

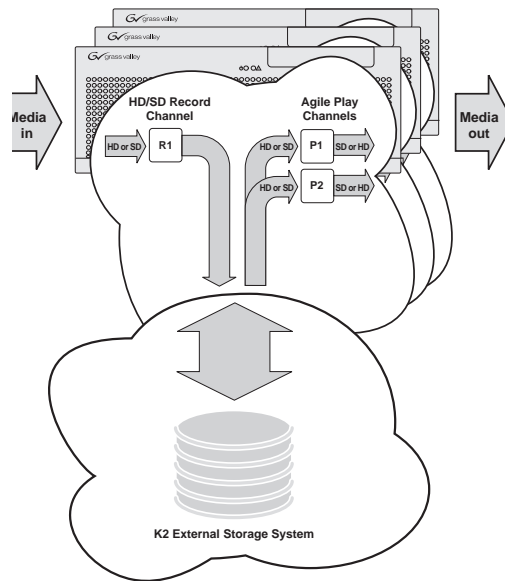

Introducing the HD-13

The HD-13 model has one input channel, three output channels, and internal storage. The input channel can be configured to record either SD or HD. Output channels are Agile, in that you can configure each channel to output either SD or HD; the clips (either SD or HD) are automatically up-converted or down-converted accordingly. The illustration below shows the HD-13 with internal storage.

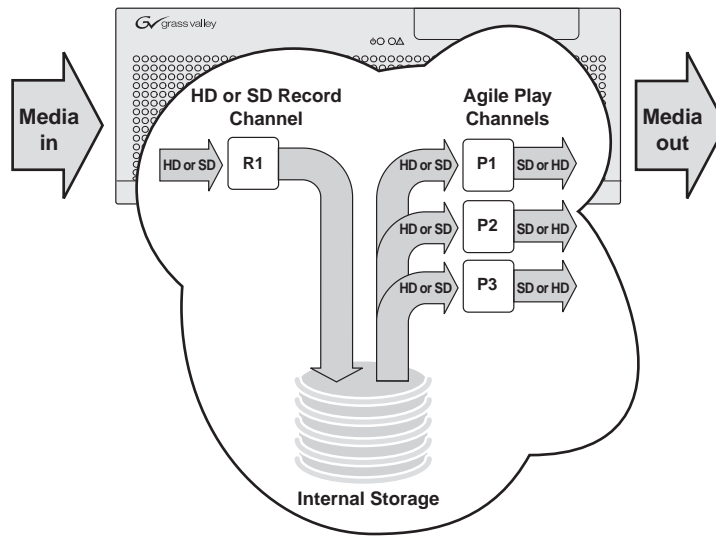

The illustration below shows the HD-13 with external storage. You can connect multiple HD-13 models or other external storage models to a K2 storage system to share a common pool of storage.

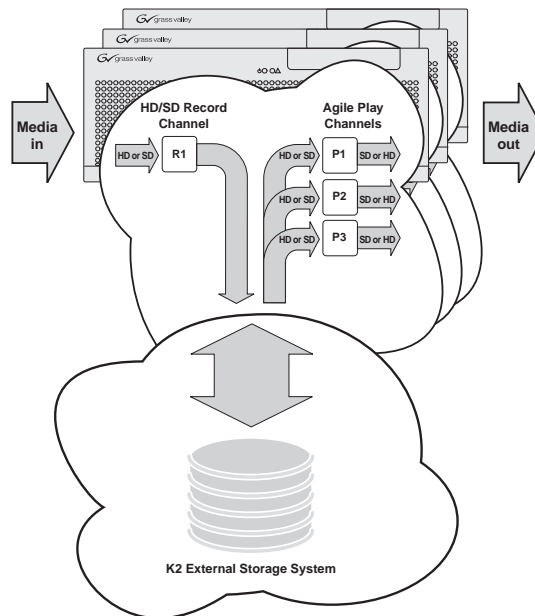

Introducing the HD-22

The HD-22 model has two input channels, two output channels, and internal storage. The input channels can be configured to record either SD or HD. Output channels are Agile, in that you can configure each channel to output either SD or HD; the clips (either SD or HD) are automatically up-converted or down-converted accordingly. The illustration below shows the HD-22 with internal storage.

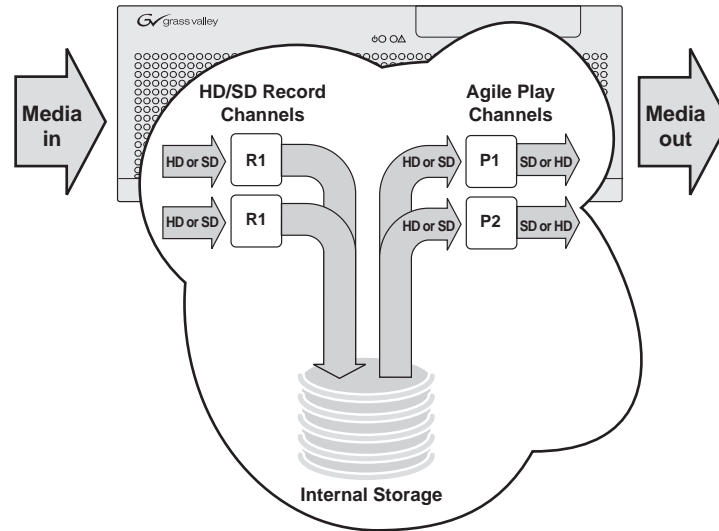

The illustration below shows the HD-22 with external storage. You can connect multiple HD-22 models or other external storage models to a K2 storage system to share a common pool of storage.

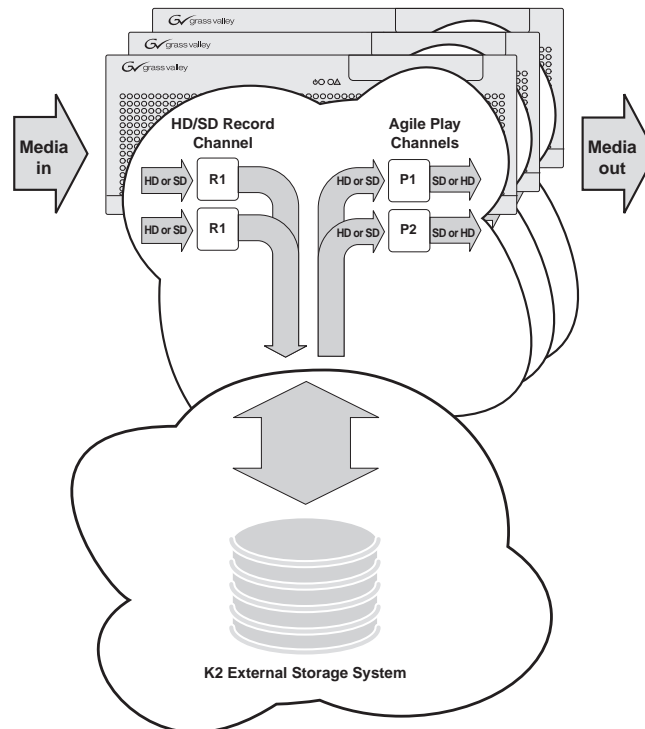

Front panel indicators

With the front bezel in place, the indicator LEDs are visible. The LEDs indicate the status of the machine. For example, when the Service LED is a steady yellow light, this could signify that one of the power cables is unplugged. For more information on indicator LEDs, see the *K2 Media Client Service Manual*.

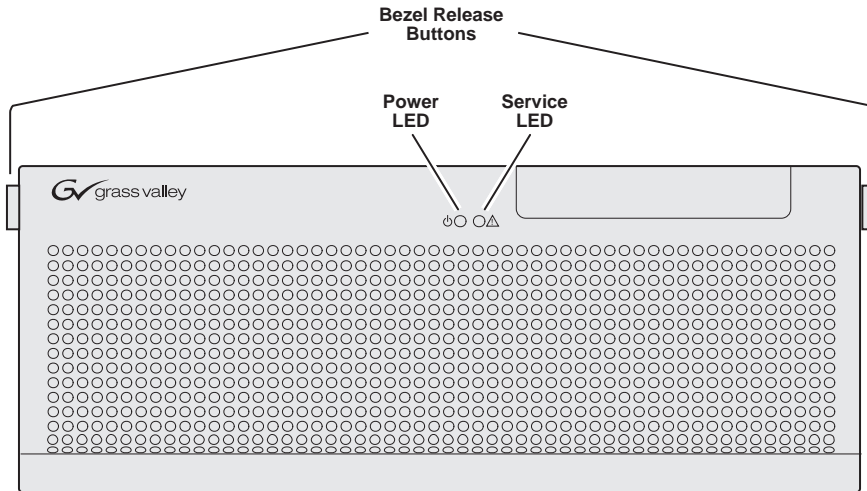

With the front bezel flipped down, you have access to the standby switch, USB port, and the removable media drive.

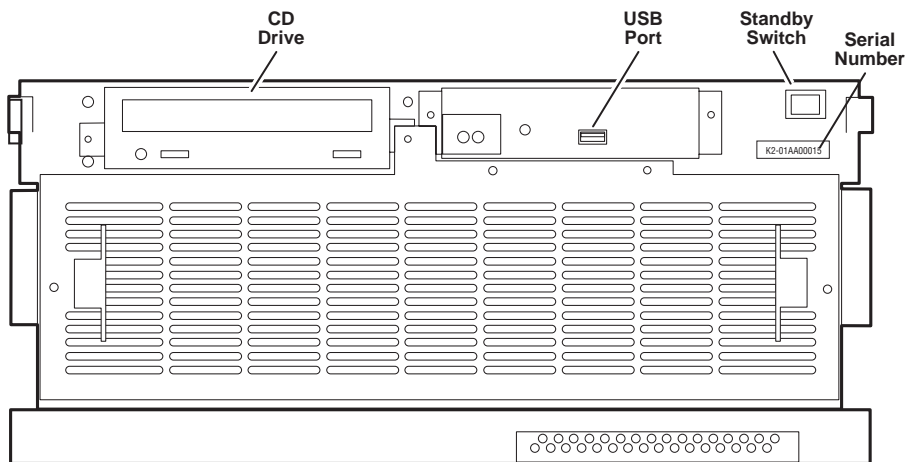

Rear panel view

The following drawings identify the rear panel connectors and components. The cards are in different locations for the SD and HD/SD rear panels. For information on how the connectors map to the SD and HD/SD K2 Media Client channels, see [“RS-422 ports and channels”](#) on page 56.

NOTE: In both the SD and HD/SD models, the GigE port 3/port 4 board can be replaced by an FC board (optional).

SD rear panel view

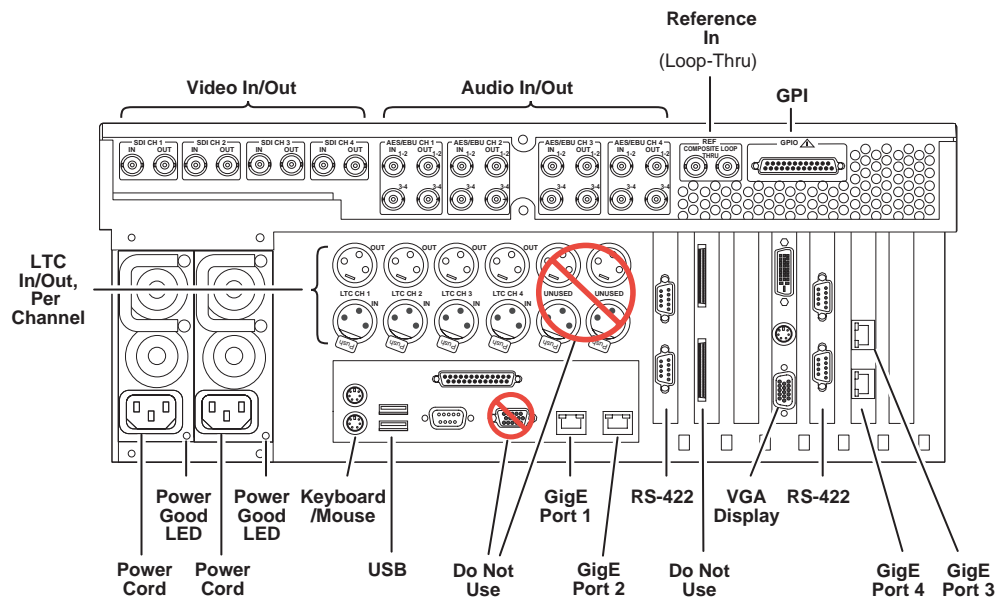

HD rear panel view

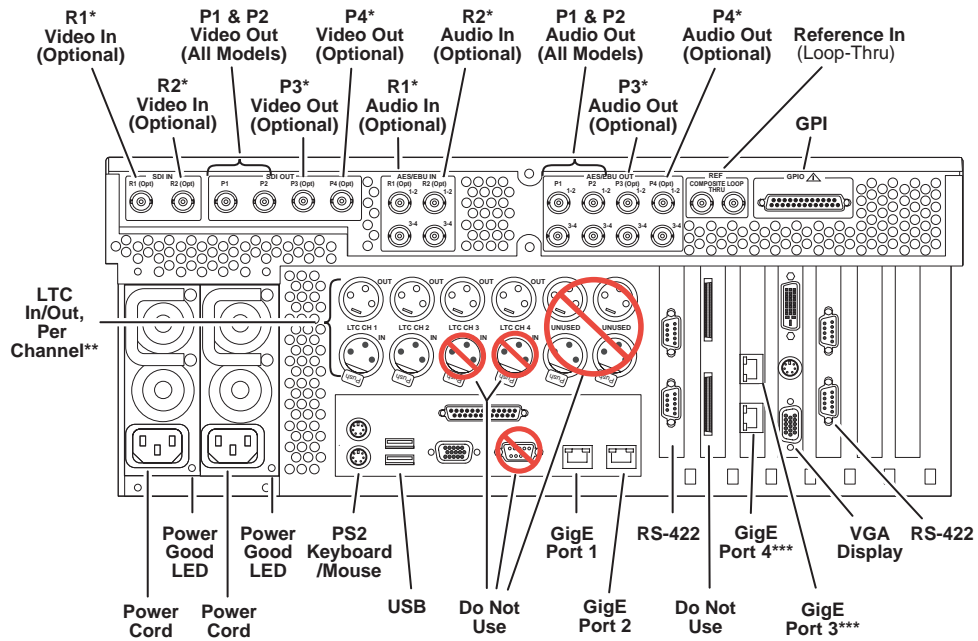

***Key to Optional Channels**

Channel	Models
R1	HD-12, HD-13
R2	HD-22
P1	All
P2	All
P3	HD-03, HD-04, HD-13
P4	HD-04

****Key to LTC Channels and Play/Record Channels**

LTC	Play/Record
CH 1 OUT	= P1
CH 1 IN	= R1
CH 2 OUT	= P2
CH 2 IN	= R2
CH 3 OUT	= P3
CH 3 IN	= Not used
CH 4 OUT	= P4
CH 4 IN	= Not used

K2 Media Client system overview

The K2 Media Client is a standard PCI bus-based Windows computer with extensive enhancements to provide the video disk recorder functionality. This section explains the major architectural blocks.

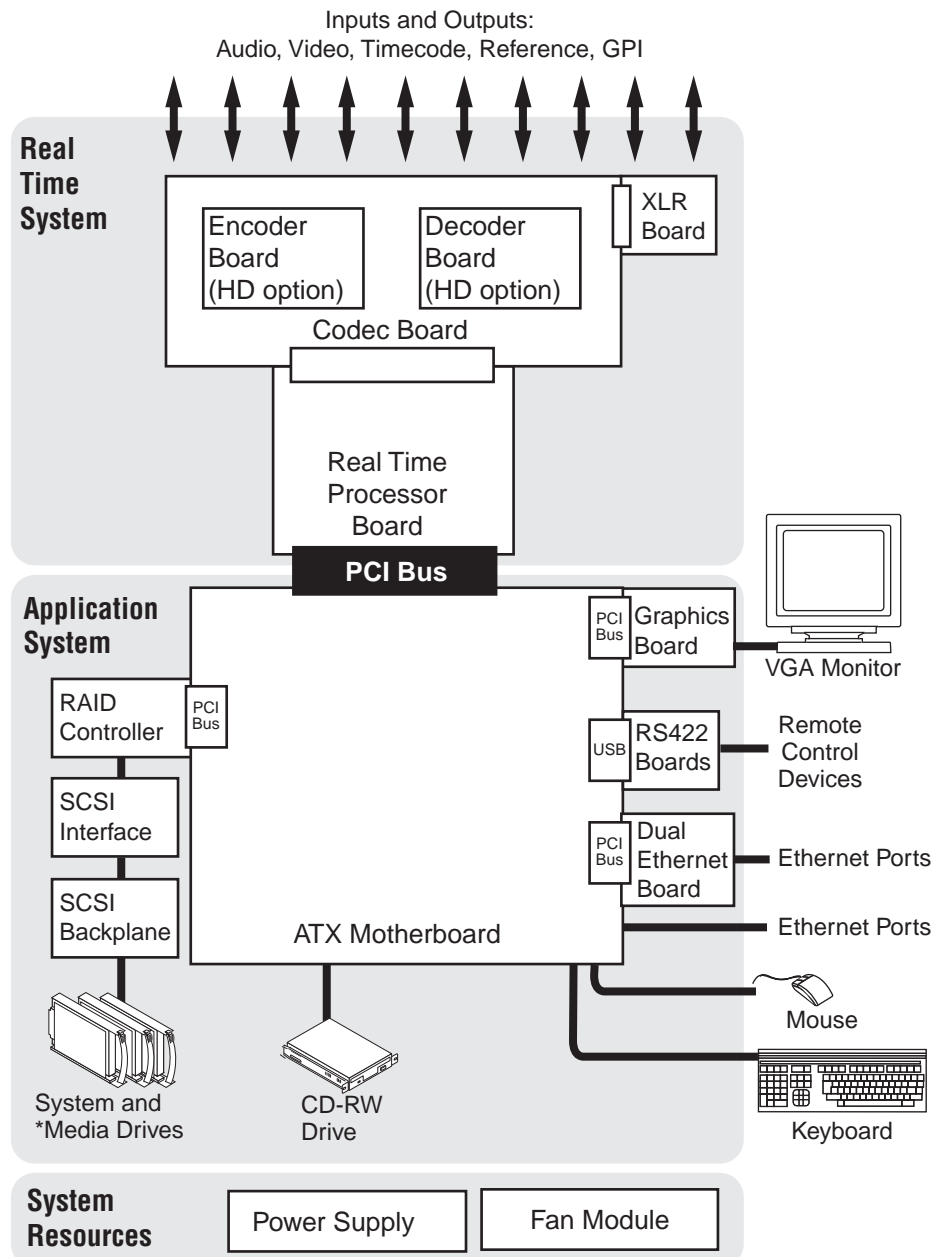

*Media Drives not in external storage models

Application System

The Application system architecture is similar to that of standard PC-type computers. It uses an ATX form factor motherboard which provides PCI board slots for expansion, built in Ethernet, and USB ports.

Standard boards are as follows:

- Graphics Board — This board provides enhanced performance for screen graphics and a connection for a VGA monitor.
- RS422 Boards — The K2 Media Client has two RS422 boards. These standard boards provide four RS-422 ports for connecting remote control devices.
- Dual Ethernet Board — This board provides additional Gigabit Ethernet ports, which are required for redundant (teamed) connections and the connection to the media network for external storage models.
- RAID Controller — This board provides the RAID functionality and SCSI connection for the internal disk drives. This includes both media and system drives for internal storage models, but just the RAID 1 pair of system drives for external storage models. The external ports on this board are not used.

The Application system uses a Windows operating system upon which all K2 Media Client applications run for configuration and control of the unit.

Real Time System

The Real Time system uses Grass Valley boards to provide the core video disk recorder functionality. Primary components are as follows:

- Real Time Processor (RTP) Board — This board provides a dedicated processor and connections for media access and processing. It functions as a riser board, connecting to the PCI slot below and the Codec board above.
- Codec Board — This board hosts the circuits responsible for encoding/decoding video and processing audio and timecode. It also provides the majority of the media-related input and output connectors.
- XLR Board — This board provides XLR connectors, which are used for LTC inputs and outputs. It is primarily an extension of the codec board to allow the space and orientation required for XLR connections.

The Real Time system uses a dedicated operating system. This operating system runs on the RTP board and manages all the hardware involved in controlling the flow of video, audio, timecode, genlock, and GPI in and out of the K2 Media Client.

Media control and processing

The following section explains how the Application system and the Real Time system work together to provide K2 Media Client functionality.

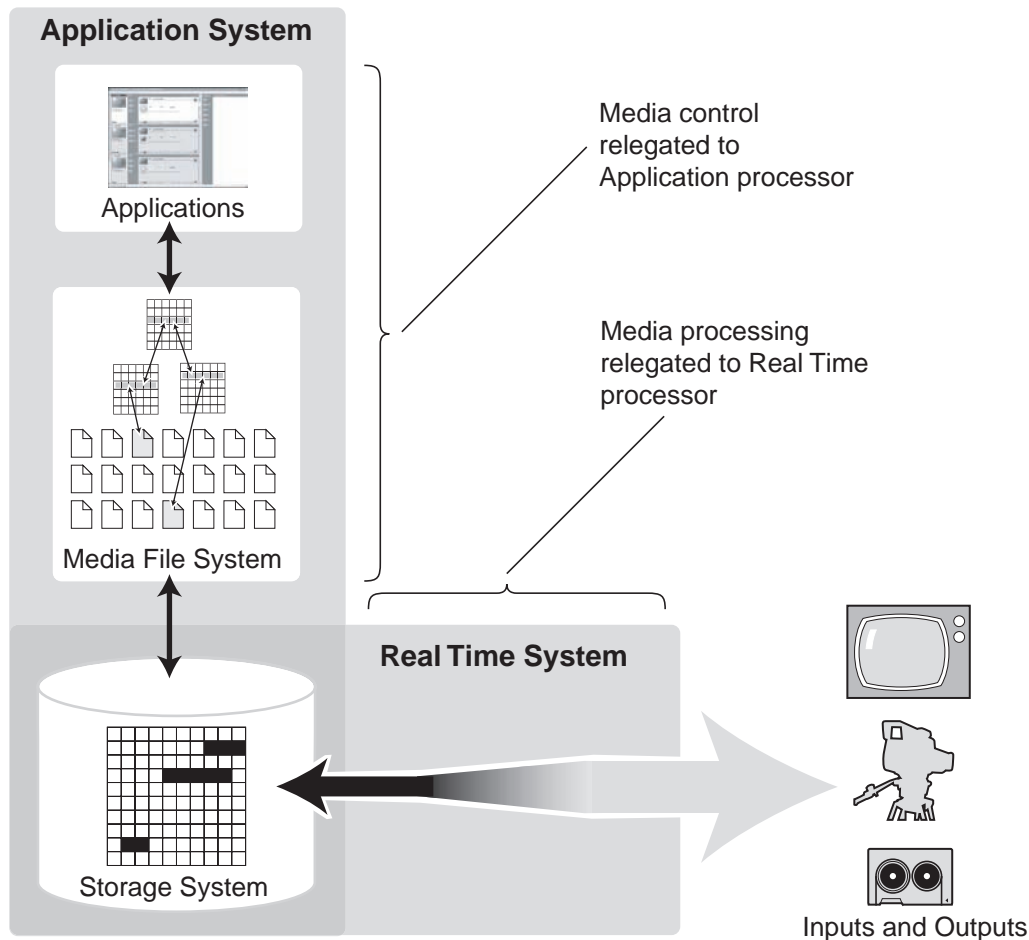

The high processing requirements of digital video can overwhelm the processor on a standard desktop PC, resulting in wait-times that destroy the video's essential real-time aspect. The K2 Media Client avoids this problem by providing dedicated systems that isolate processing needs. The components that work together to provide this functionality are as follows:

The **Application system** is, at its core, a conventional desktop PC-type system. In the K2 Media Client it is dedicated to control, configuration, and networking functions that do not require real-time accuracy. The Application system has the following components:

- Application software provides the user interface for operating the K2 Media Client. The software runs as Windows programs.
- The Media File system manages clips. It includes a database that associates the clip with its video, audio, and timecode files and a dedicated file system (separate from

the Windows file system) that controls access to the raw data that makes up each file. Any reading and writing of clips, be it through play and record operations or through file transfers and media streaming, is managed by the database. The database and file system run as Windows programs.

The **Storage system** includes the media disk drives, controllers, drivers, and adapters necessary for access and movement of the data. While the primary data flow is within the overall control of the Real Time system, some components and their communication pathways cross over into the Application system. For example, the RAID controller board plugs into the motherboard and accesses media drives in internal storage models, yet it is controlled by Windows. The media drives appear as the V: drive to the Windows operating system.

The **Real Time system** manages the media flow between the Storage system and the inputs and outputs. The Real Time system has a dedicated processor and time-sensitive mechanisms to serve media processing needs while maintaining real-time accuracy.

When you control play and record operations from within the Application system you trigger a chain of events that eventually crosses over into the Real Time system and results in media access. The following sequence is an example of this type of chain of events:

1. A user operates the Player application to play a particular clip. The Player application asks the Media File system for permission to access the clip. The Media File system grants access. In external storage models, the Media File system enforces shared storage policies in order to grant the access. When access is granted, the Player application initiates play access to the clip.
2. The database identifies the files that make up the clip and the file system instructs the Storage system to open access to the files.
3. The Storage system finds the raw data and opens the appropriate read access. At this point both the Application system and the Real Time system are involved. Windows controls the media drives and controllers, so the Real Time system makes file requests to Windows and it causes the data to be transferred to buffers on the Real Time processor. The data is then available to the Real Time system so that it can be processed at exactly the right time.
4. The Real Time system processes the media, decompresses it, adjusts its timing, and moves it as required to play the clip as specified by the user.

Locations of rear panel boards

Boards are mapped to rear panel slots as follows:

Board	Slot in SD-only models	Slot in HD/SD models	Comments
ATX Motherboard	—	—	—
Dual Ethernet ^a	2	5	Plugs into PCI bus
RS422	3	3	Occupies a rear panel slot but does not plug into a PCI bus.
Graphics	4	4	Plugs into PCI bus
RTP	5	2	Plugs into PCI bus
RAID controller	6	6	Plugs into PCI bus
RS422	7	7	Occupies a rear panel slot but does not plug into a PCI bus.

^aCan be replaced by an FC board (optional)

RS-422 ports

The Windows COM port assignments to the physical RS-422 port connectors on a K2 Media Client are described in the following illustration. For information on the relationship between RS-422 ports and K2 Media Client channels, see [“RS-422 ports and channels” on page 56](#). For information about RS-422 connectors, see [“Connecting RS-422” on page 55](#). The RS-422 ports correspond to internal USB hubs. For more information on USB see [“Enabling and disabling the USB ports” on page 83](#).

NOTE: The designations *P1, P2, P3, P4* in this illustration refer to *Port 1, Port 2, and so on*. Do not confuse them with the *HD/SD K2 Media Client Player channels P1, P2, etc.*

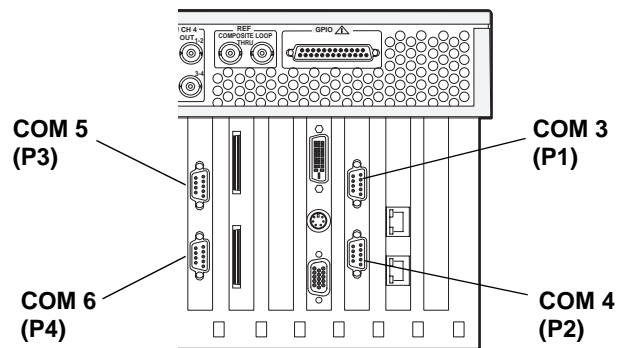

RAID drive numbering

RAID drives are numbered as follows. This numbering is displayed in Storage Utility and on the K2 Media Client chassis RAID drive labeling. You can see the labeling when you remove the fan module.

Drive numbering	Explanation
System Disk0_0	These two RAID drives make up LUN 0, which holds K2 Media Client system data and functions as the system drive. The system drive has three partitions. The partitions appear to the Windows operating system as C:, D:, and E: drives. Both internal storage models and external storage models have these two drives.
System Disk1_0	
Media Disk0_1	These two RAID drives make up LUN 1, which holds media data. The media file system lays down media data in a continuous stripe across this LUN and the other media LUNs. Internal storage models have these drives and the other media drives. External storage models do not have any media drives.
Media Disk1_1	
Media Disk0_2	These two RAID drives make up LUN 2, which holds media data.
Media Disk1_2	
Media Disk0_3	These two RAID drives make up LUN 3, which holds media data.
Media Disk1_3	
Media Disk0_4	These two RAID drives make up LUN 4, which holds media data.
Media Disk1_4	
Media Disk0_5	These two RAID drives make up LUN 5, which holds media data.
Media Disk1_5	

Using K2 Media Client system tools

Topics in the chapter include the following:

- “Configuration Manager” on page 37
- “K2 System Configuration” on page 38
- “Storage Utility” on page 40
- “NetCentral” on page 41

Configuration Manager

The Configuration Manager is the primary configuration tool for a K2 Media Client. It makes settings that apply to the overall K2 Media Client system as well as settings that apply to individual channels.

Configuration Manager settings are stored in a database. When the K2 Media Client starts up it reads the current settings from the database and configures itself accordingly. When you modify a setting in Configuration Manager you must save the setting in order to update the database and reconfigure the K2 Media Client.

You can also save settings out of Configuration Manager into a configuration file, which is a stand-alone XML file. Likewise, you can load settings into Configuration Manager from a configuration file. However, you must use Configuration Manager as the means to save the settings to the database before the settings actually take effect. Configuration files are not linked directly to the database.

You can use configuration files as a means to back up your settings. You can also use configuration files to save several different groups of customized settings, each with a unique name, so that you can quickly load settings for specialized applications.

For Configuration Manager procedures, refer to the *K2 Media Client User Guide*.

Accessing Configuration Manager

You access Configuration Manager through AppCenter from either the local K2 Media Client or the control point PC. To access the configuration settings, open AppCenter and select **System | Configuration**.

Saving and restoring Configuration Manager settings

Settings can be saved as a configuration file. You can save any number of uniquely named custom configuration files. You can load a configuration file to restore system settings.

To save custom settings:

1. In the Configuration Manager, click the **Save** button.
The Save As dialog opens.
2. Use the up arrow or select folders to navigate to the folder in which you want to save the configuration file.

3. Enter a name for the configuration file.

Do not name the file *DefaultConfig.xml*, as this name is reserved for the factory default configuration file. Otherwise, standard Windows 2000 and up file naming restrictions apply.

4. Click **Save** and **Close**.

To restore custom settings:

1. If you want to save current settings, you should save them as a configuration file before continuing.

2. In the Configuration Manager, click the **Load** button.

The Open dialog opens.

3. Use the up arrow or select folders to navigate to the custom configuration file.

4. Select the custom configuration file.

5. Click **Open**.

The custom settings are loaded into Configuration Manager, but they have not been saved and put into effect.

6. Click **OK** to save and apply settings, and to close the Configuration Manager.

Restoring default Configuration Manager settings

You can restore factory default settings as follows:

- You can restore some individual settings or groups of settings by selecting the **Default** button which appears below the settings in the configuration screen.
- You can restore all the settings in Configuration Manager at once to their default values as explained in the following procedure.

To restore all settings at once to their default values:

1. If you want to save current settings you should work through the previous procedure [“Saving and restoring Configuration Manager settings”](#) before proceeding.

2. In the Configuration Manager dialog, click **Restore**.

The default settings are loaded into Configuration Manager, but they have not yet been saved and put into effect.

3. Click **OK** to save settings and close Configuration Manager.

K2 System Configuration

The K2 System Configuration application (K2 Config) is the primary tool for configuring the K2 Storage System. Once the devices of the storage system are cabled and are communicating on the control network, you can do all the configuration required to create a working K2 Storage System using the K2 System Configuration application.

After your K2 Storage System is initially installed and configured, as instructed in the installation chapters in the *K2 Storage System Instruction Manual*, if you need to reconfigure the system you should do so using the K2 System Configuration Application. While some reconfiguration tasks can be accomplished without using the K2 System Configuration Application, it is not recommended. Using the K2 System Configuration Application enforces consistent policy and sequencing for reconfiguration tasks, which makes the system easier to maintain and aids in troubleshooting should a problem arise.

The K2 System Configuration application runs on a control point PC and accesses the devices of the K2 Storage System via the control network. You can configure the devices of the K2 Storage System as follows:

- K2 Media Client and K2 Media Server — These devices are configured directly by the K2 System Configuration application.
- K2 Level 2 RAID and Level 3 RAID storage devices — The K2 System Configuration application launches a remote instance of Storage Utility, which configures RAID storage devices. Storage Utility components run on the K2 Media Server and the configuration actually takes place via the Fibre Channel connection between the K2 Media Server and the RAID storage device.
- K2 Level 1 RAID — The media server parameters are configured by the K2 System Configuration application while the RAID storage parameters are configured by Storage Utility.
- Ethernet switches — The K2 System Configuration application can launch a switch's web-based configuration application.

To open the K2 System Configuration application do the following:

1. On the control point PC open the K2 System Configuration application shortcut on the desktop. The K2 System Configuration application log in dialog box opens.
2. Log in using the designated administrator account for configuring K2 Storage System devices. By default this account is as follows:
Username: administrator
Password: adminK2
3. The K2 System Configuration application opens.

When you select a K2 storage system, device, or subsystem in the tree view...

Toolbar buttons are displayed according to operations available...

And related information and configuration controls appear.

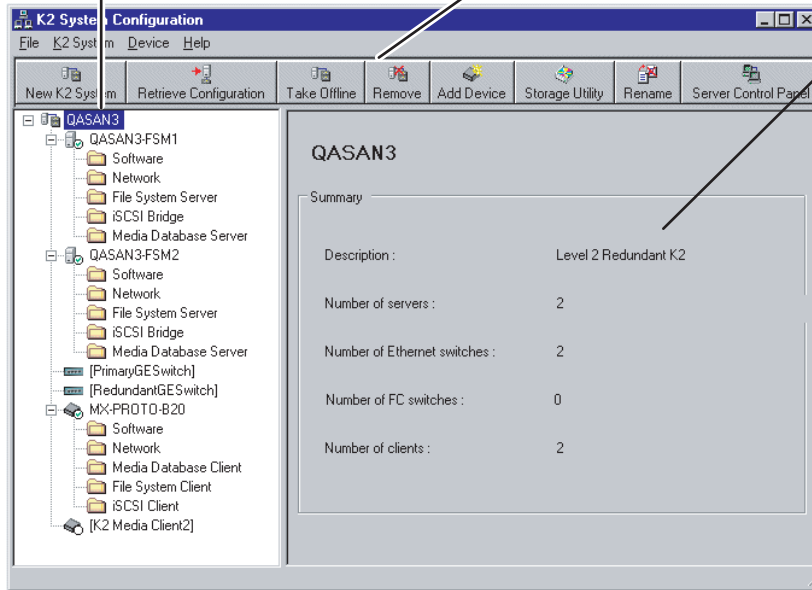

If you have one or more K2 Storage Systems currently configured, the K2 System Configuration application displays the systems in the tree view.

If you have not yet configured a K2 Storage System, the K2 System Configuration application opens with the tree view blank. Refer to the installation chapters in the *K2 Storage System Instruction Manual* to add and configure a new K2 Storage System.

You can expand and select nodes in the tree view to view K2 Storage Systems, individual devices, and configuration settings. When you do so, the K2 System Configuration application displays information as found in a configuration file, rather than continuously polling devices to get their latest information. The configuration file is saved on the V: drive, along with the media files in the shared storage system. The configuration file is updated and saved whenever you change a configuration using the K2 System Configuration application. That is why you must always use the K2 System Configuration application to change settings on the storage system, so the most recently changed configurations will always be stored in the configuration file and displayed.

Storage Utility

You should be aware that there are two versions of Storage Utility:

- Storage Utility for the K2 Storage System.
- Storage Utility for internal storage K2 Media Client models

This manual explains Storage Utility for internal storage K2 Media Client models. Refer to the *K2 External Storage Instruction Manual* to learn about Storage Utility for the K2 Storage System.

NOTE: *Do not run Storage Utility on an external storage K2 Media Client. For external storage, run Storage Utility only via the K2 System Configuration application.*

The Storage Utility is your primary access to the media file system, the media database, and the media disks of the K2 Media Client for configuration, maintenance, and repair. It is launched from AppCenter workstation.



CAUTION: *Use the Storage Utility only as directed by a documented procedure or by Grass Valley Support. If used improperly, the Storage Utility can render your K2 Media Client inoperable or result in the loss of all your media.*

Refer to [Chapter 4, Managing Internal Storage](#) for Storage Utility procedures.

NetCentral

NetCentral is Grass Valley's monitoring application. The NetCentral server component runs on a NetCentral server PC, which could also be a K2 system control point PC. The K2 Media Client report status, primarily via Simple Network Management Protocol (SNMP), to NetCentral on the NetCentral server PC.

Refer to the *NetCentral User Guide* to get the NetCentral system installed and operating. You must install a NetCentral device provider on the NetCentral server PC for each type of device you are monitoring. For detailed information about setting up and monitoring each type of device, go to the NetCentral **Help** menu and read the online help for the device-type.

NOTE: *NetCentral is optional if you are using K2 Media Client with internal storage only. NetCentral is required if you are using K2 Media Client with a shared storage system.*

System connections and configuration

This chapter contains the following topics:

- [“Network connections and configuration”](#)
- [“Modifying network settings”](#)
- [“Using FTP for file transfer”](#)
- [“Connecting RS-422”](#)
- [“RS-422 ports and channels”](#)
- [“Connecting GPI”](#)

Network connections and configuration

Refer to the following list of procedures, then perform the ones required to set up the Gigabit (1GBaseT) Ethernet network for your application:

- [“Cable requirements”](#)
Lists the requirements for Ethernet cables.
- [“About teaming Ethernet ports”](#)
Explains the teaming configuration.
- [“Connecting the Ethernet network cabling”](#)
Shows how to connect the K2 system to an Ethernet network using the standard 1GBaseT ports.
- [“Data and streaming for K2 Media Client systems”](#) Contains instructions for configuring the network connection to support the following:
 - Remote control of the K2 Media Client with AppCenter or with remote protocol applications over Ethernet.
 - Streaming media transfers between K2 systems.
 - Standard data network capability

Cable requirements

For making Ethernet connections, cabling must meet the following requirements:

- CAT5 or higher
- Maximum cable length is 50 meters

About teaming Ethernet ports

The K2 Media Client has four Gigabit Ethernet ports: two on the motherboard and two on the Network Interface Card. The location of the ports is different for the SD and the HD/SD K2 Media Clients.

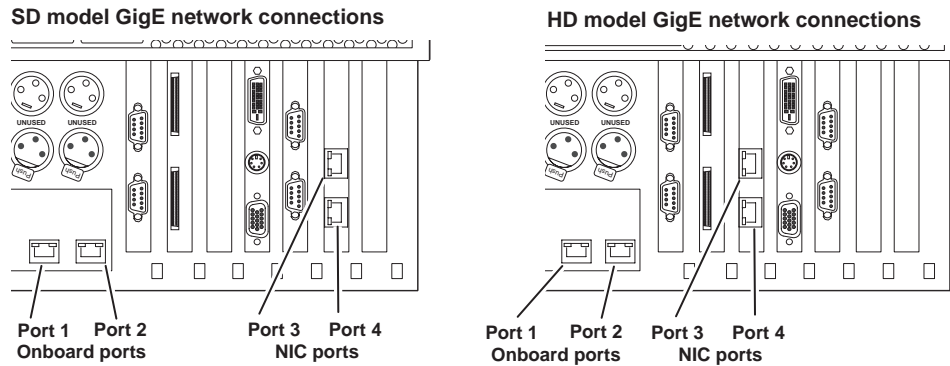

These ports are configured at the factory as two teamed pairs. The first port on the motherboard (Port 1) is teamed with the first port on the Gigabit Ethernet card (Port 3). This is the Control Team. Likewise, the second port on the motherboard (port 2) is teamed with the second port on the Gigabit Ethernet card (port 4). This is the Media Team.

Each teamed pair appears to the network as a single NIC, so there are two NICs presented to the operating system. This teaming configuration is required to support K2 Media Client automatic system recovery features.

Do not modify this teaming configuration. If you need to reset teaming to factory specifications, refer to the *K2 Media Client Service Manual*.

Connecting the Ethernet network cabling

This section is divided into two parts:

[“Configure Windows network settings for K2 Media Client with internal storage” on page 46](#)

[“Configure Windows network settings for K2 Media Clients with shared storage” on page 47](#)

Connecting the Ethernet network cabling for K2 Media Clients with internal storage

On a K2 Media Client with internal storage, port 1 (or ports 1 and 3 if redundant) is used to transmit command information, AMP protocols, etc., while port 2 (or ports 2 and 4 if redundant) is used for FTP transfers.

Control Network

Connect the control network to port 1, or to ports 1 and 3 if a redundant connection is required.

FTP network

Connect the FTP network to port 2, or to ports 2 and 4 if a redundant connection is required.

Connecting the Ethernet network cabling for K2 Media Clients with shared storage

In the K2 Media Client with shared storage, port 1 (or ports 1 and 3) is still used to transmit control information, but port 2 (or ports 2 and 4) is used for the iSCSI traffic, which is the recording or playing of media.

Control Network

Connect the control network to port 1, or to ports 1 and 3 for a redundant connection.

Media/iSCSI network

Connect the media/iSCSI network to port 2, or to ports 2 and 4 if a redundant connection is required.

Data and streaming for K2 Media Client systems

After making 1GBaseT network connections as described in [“Connecting the Ethernet network cabling” on page 44](#), use the following procedure to configure the network settings. Once configured, you can perform the following tasks:

- General networking tasks such as file sharing, mapping network drives, or importing/exporting from networked devices using standard media file formats.
- Remote control and configuration of the K2 Media Client using AppCenter workstation from a control point PC.
- Remote control of the K2 Media Client using devices and applications software developed for the K2 Media Client that use industry standard remote control protocols over Ethernet.
- Stream media transfers between K2 systems using the General Exchange Format (GXF) as described in SMPTE 360M. GXF streaming transfers allow loading and playing a clip before the transfer is complete.

Setting up the K2 system for streaming transfer has the following network requirements:

- Some kind of name resolution process must be followed. You must either reference host names through hosts files located on each networked device or edit the DNS entries. To edit the DNS entries, see your network administrator. To set up host files, see [“Connecting the Ethernet network cabling” on page 44](#).
- The host name of all peer K2 systems, M-Series, and Profile XP systems must be added to a Remote host registry using the K2 Media Client Configuration Manager.
- To import to or export from a K2 system, both the source and destination need to be in the same domain.

This procedure guides you to relevant settings, but does not instruct you on the specific settings required for your network. It is assumed that you understand Ethernet networks in general and your particular network needs and that you can apply that understanding to make the required settings using standard Windows procedures. If you need help with these procedures, contact your network administrator.

Configure Windows network settings

The K2 Media Client ships from the factory DHCP configured. In the simplest possible scenario, no configuration should be necessary. (This assumes no need for a streaming/FTP network and that you are using the K2 Media Client serial number as the host name.)

However, if the Windows network settings for the K2 Media Client need to be configured, you must do so locally. You cannot configure these settings using the remote Control Point PC. You must have Windows administrator security privileges on the computer that you are configuring.

- [“Configure Windows network settings for K2 Media Client with internal storage” on page 46](#)
- [“Configure Windows network settings for K2 Media Clients with shared storage” on page 47](#)
- [“Set up hosts files” on page 49](#)
- [“Add network hosts names for streaming” on page 51](#)



CAUTION: *The K2 Media Client is not a general purpose Windows workstation. The Windows configuration on the K2 system has been specifically set for use as a real time device. To avoid partial or total system failure, do not modify any operating system settings unless approved by Grass Valley, including but not limited to the following:*

- *Do not use the User Manager*
- *Do not use the Disk Administrator*
- *Do not load any third party software*
- *Do not install any Windows updates other than “Critical Updates and Service Packs” without contacting Grass Valley Product Support. (See “Security considerations” on page 79.)*

Configure Windows network settings for K2 Media Client with internal storage

1. Connect keyboard, mouse, and monitor if you have not already done so.
2. Open the Network Connections dialog box:
 - In the Windows Classic view, select **Start | Settings | Network Connections**
 - In the Windows XP view, select **Start | Control Panel | Network Connections**
3. Continue with standard Windows procedures to configure the TCP/IP protocol properties. You can set up the network using DHCP, DNS, WINS, or other standard networking mechanisms.

NOTE: On small networks or networks with certain security policies a DHCP server or domain name server (DNS) might not be available. In this case you can set up a static IP address and create a Host file on each K2 system. The Host file specifies a device name for each IP address used on the network. Refer to the Windows documentation or your network administrator for more information.

- As per your connections, configure the Control Team for port 1 (or ports 1 and 3 if redundant) as shown in the following illustration..

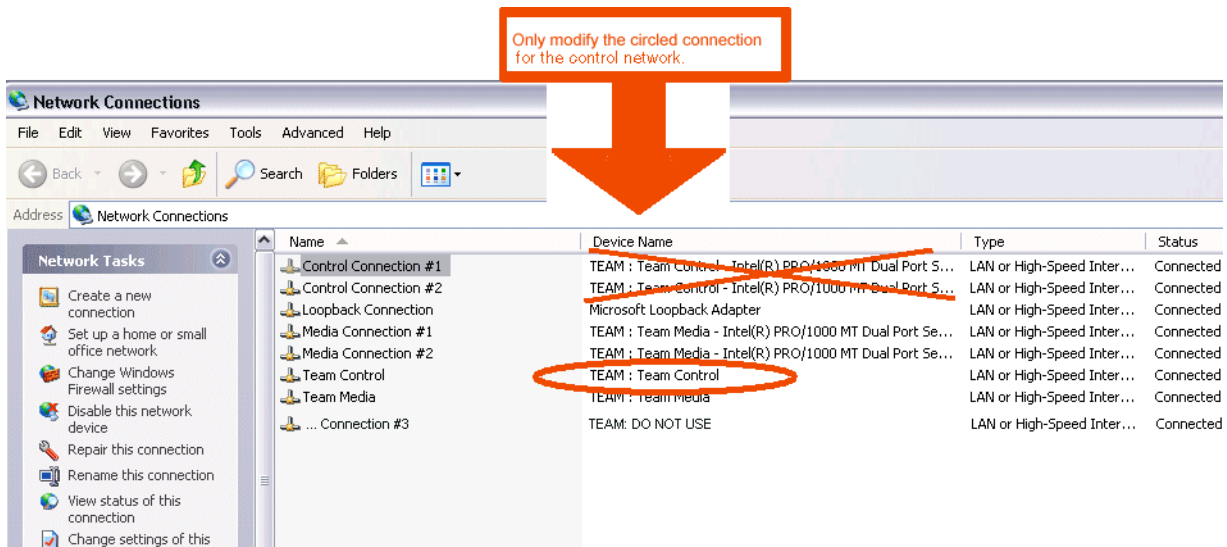

- As per your connections, configure the Media Team for port 2 (or ports 2 and 4 if redundant). Assign an IP address that is on a different subnet from port 1.

CAUTION: Under no circumstances should you modify the loopback adapter. The loopback IP address is 192.168.200.200. Keep that IP address reserved on your network. Don't assign it to any other device.(If this causes conflicts with your existing network, consult your Grass Valley representative.)

- If prompted, shutdown and restart Windows.
- If you are going to stream video between K2 systems, proceed to “[Streaming video between K2 systems](#)”; otherwise, the K2 system is ready for standard data networking tasks.

Configure Windows network settings for K2 Media Clients with shared storage

- Connect keyboard, mouse, and monitor if you have not already done so.
- Open the Network Connections dialog box:
 - In the Windows Classic view, select **Start | Settings | Network Connections**
 - In the Windows XP view, select **Start | Control Panel | Network Connections**
- Continue with standard Windows procedures to configure the TCP/IP protocol properties. You can set up the network using DHCP, DNS, WINS, or other

standard networking mechanisms.

NOTE: If you do not use DHCP and DNS for the control network, you can set up a static IP address and create a Host file on each K2 system. The Host file specifies a device name for each IP address used on the network. Refer to the Windows documentation or your network administrator for more information.

4. As per your connections, configure port 1 (or ports 1 and 3 if redundant). Refer to “Cable requirements” on page 43.

If using shared storage, do not configure port 2 (or teamed ports 2 and 4), as these ports are reserved for the external storage media network and should only be configured using the K2 config application. Refer to the *K2 Storage System Instruction Manual*.

CAUTION: If you are using shared storage, be sure to configure only the connection that is labelled “Team Control” in the Device Name column. If you do not see the Device Name column, verify that you are in the Details view, and select Choose Details to modify the view settings. Under no circumstances should you modify the loopback adapter. The loopback IP address is 192.168.200.200. Keep that IP address reserved on your network. Don’t assign it to any other device. (If this causes conflicts with your existing network, consult your Grass Valley representative.)

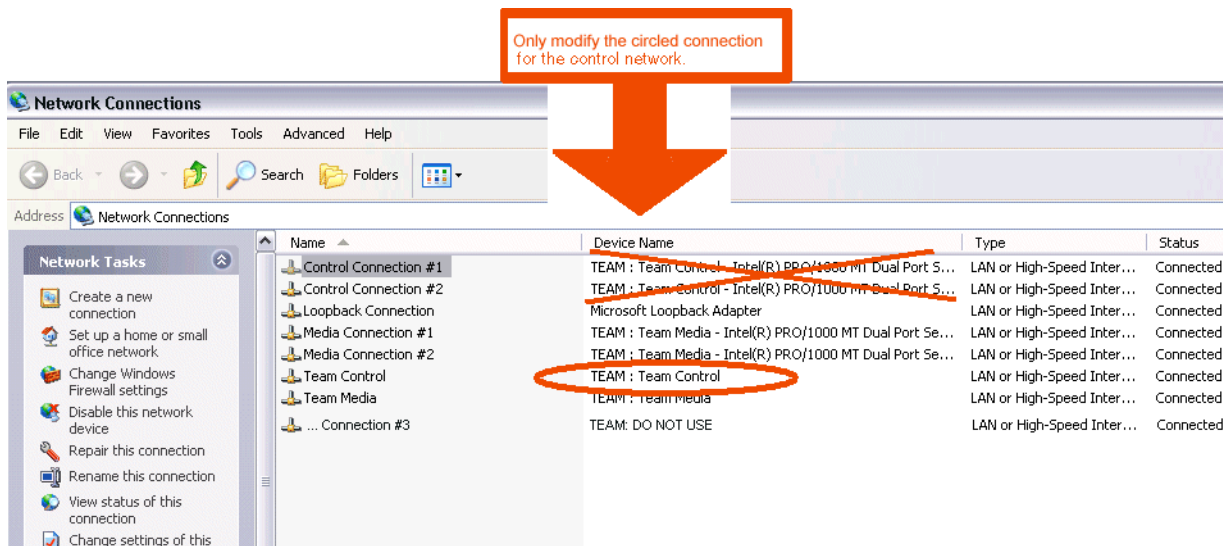

5. If prompted, shutdown and restart Windows.
6. If you are going to stream video between K2 systems, proceed to “Streaming video between K2 systems”; otherwise, the K2 system is ready for standard data networking tasks.

Streaming video between K2 systems

As long as the GigE ports 1 and 2 (or teamed ports 1 and 3, 2 and 4) are on two different subnets, you can use DNS, DHCP, or static IP addresses and a hosts file. However, for the media (iSCSI) network on a K2 Storage System, static IP addresses and a hosts files are required. The following procedure describes how to set up hosts files.

Set up hosts files

Set up a hosts file located in `c:\WINDOWS\system32\drivers\etc\hosts` on each K2 system. If you include the names and addresses of all the K2 Media Clients on the network, then you can create one file and copy it to all the machines instead of editing the hosts file on each machine.

Each host name is listed twice, once for port 1 (or 1 and 3), once for port 2 (or 2 and 4). The host name for port 2 has the extension “_he0” after the name. The K2 Media Client uses this information to keep the control traffic separate from the streaming/FTP traffic.

To see an example of a K2 Media Client configuration setup and hosts file, refer to the [“Sample K2 Media Client configuration and hosts file”](#) on page 50. Otherwise, proceed with the following steps to set up your hosts file.

On each K2 system, set up the hosts file as follows:

1. Open the following file using Notepad or some other text editor.

```
c:\WINDOWS\system32\drivers\etc\hosts
```

2. Enter text in two lines for each K2 system, including the local K2 system.

NOTE: *If you are using DHCP to set IP addresses, skip steps a and b and proceed to step c.*

- a. Type the IP address assigned to port 1 (the Control Team), then use the TAB key or Space bar to insert a few spaces.
 - b. Type the machine name, such as **K2-MediaClient**. This sets up the host file for port 1. The machine name cannot have any spaces in it.
 - c. Type the IP address of port 2 (the Media Team), then use the TAB key or Space bar to insert a few spaces.
 - d. Type the machine name followed by the characters “_he0”. Be sure to use the zero character, not the letter ‘o’, as in the following example:

```
10.16.42.10  K2-MediaClient
10.0.0.10    K2-MediaClient_he0
```
3. Once you have added the host names for each of K2 systems, save the file and exit the text editor.
 4. Copy the new hosts file onto all the other machine to save you editing it again.
 5. Proceed to [“Add network hosts names for streaming”](#).

Sample K2 Media Client configuration and hosts file

The following diagram illustrates one possible configuration setup, with both a K2 Media Client with internal storage and a K2 Media Client with shared storage, as well as other Grass Valley systems.

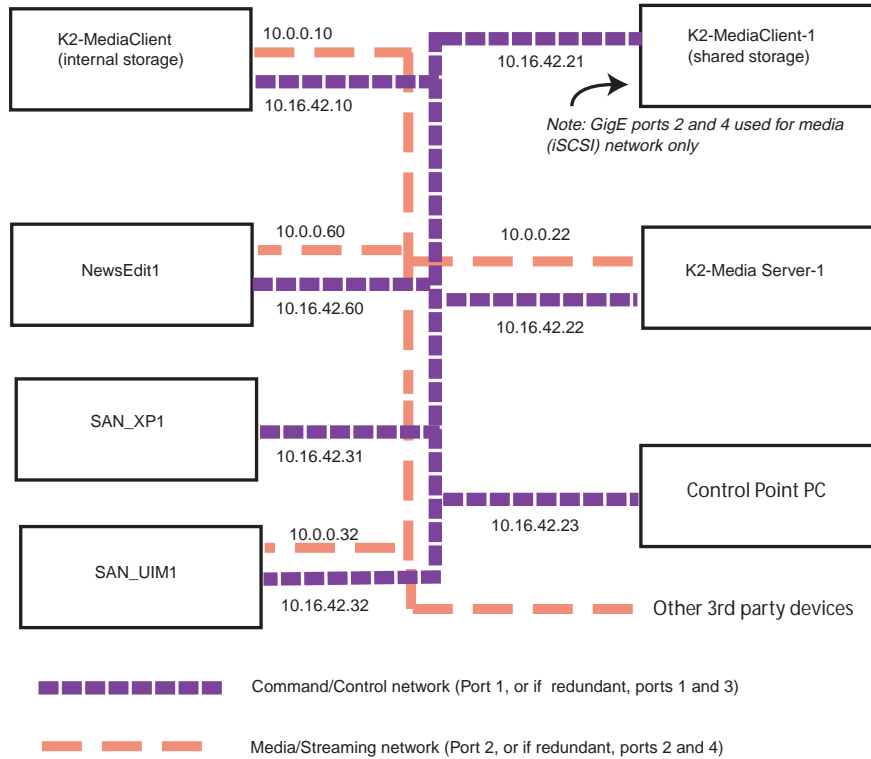

The following example shows the contents of a default Windows hosts file with new lines added that match the IP addresses and host names in the previous sample diagram.

All lines beginning with a # are comments and can be ignored or deleted.

```
# Copyright (c) 1993-1995 Microsoft Corp.
# This is a sample HOSTS file used by Microsoft TCP/IP for Windows.
# This file contains the mappings of IP addresses to host names. Each
# entry should be kept on an individual line. The IP address should
# be placed in the first column followed by the corresponding host name.
# The IP address and the host name should be separated by at least one
# space.
# Additionally, comments (such as these) may be inserted on individual
# lines or following the machine name denoted by a '#' symbol.
```

```

#
# For example:
# 102.54.94.97 rhino.acme.com # source server
# 38.25.63.10 x.acme.com # x client host

127.0.0.1 localhost

10.16.42.10 K2-MediaClient
10.0.0.10 K2-MediaClient_he0

10.16.42.21 K2-MediaClient-1

10.16.42.22 K2-MediaServer-1
10.0.0.22 K2-MediaServer-1_he0

10.16.42.23 ControlPointPC

10.16.42.60 NewsEdit1
10.0.0.60 NewsEdit1_he0

10.16.42.31 SAN_XP1
10.0.0.32 SAN_XP1_he0 SAN_UIM1_he0
10.16.42.32 SAN_UIM1

```

Add network hosts names for streaming

You must add the host names of all peer K2 systems on the network that support streaming transfers. Adding host names is required to allow selection of networked K2 systems in the AppCenter user interface and to provide a successful network connection for streaming. The host names added will appear in the “Import” and “Send to” dialog boxes.

NOTE: *By default, the K2 system host name is the same as the Windows computer name. To determine the K2 system computer name, right-click My Computer on the Windows desktop, then properties. Select the Network Identification tab and look for the “Full computer name”.*

To add network host names:

1. Start AppCenter, if it is not already running, using the desktop shortcut.
2. In AppCenter toolbar, select **System**, then choose **Configuration**.
3. Select the **Remote** tab.

The Remote Settings dialog box displays, showing any network host names that have been added.

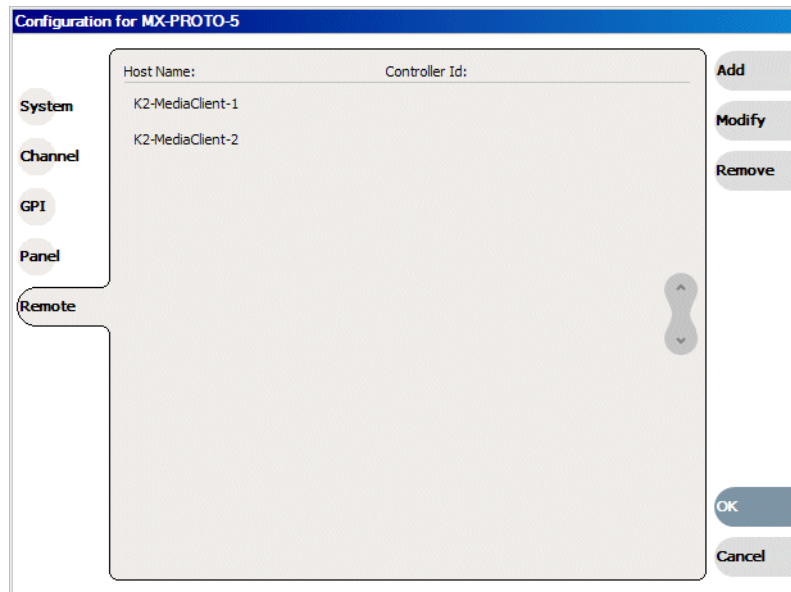

4. Select **Add**, to open the Add Host dialog box, then do the following:
 - a. Select the Host name field, then enter the computer name of a peer K2 system. Make sure to enter the exact computer name. Any differences will result in being unable to connect to the K2 system.

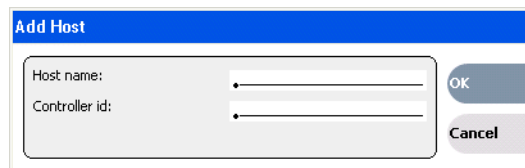

- b. If you are using AMP remote protocols to perform video network transfers, you must use the following steps to add a unique Controller ID for each host. Otherwise, you can ignore this step and proceed to the next step.
 - Select controller id field.
 - Enter the controller ID of the K2 system, then select **OK**. Use a number between 1 and 255 that is not assigned to any other K2 system.
 - c. Select **OK** in the Add Host dialog box.
5. Repeat the previous step for the remaining K2 systems.
6. In the Configuration dialog box, select **OK** to save settings.

Once the host names are added, the K2 system is ready for streaming operation. For information on transfer compatibility and supported formats, refer to [Appendix A, Specifications](#). For procedures on transferring media, refer to the *K2 Media Client User Guide*.

NOTE: *If you have trouble, try using the ping utility in the Windows command prompt using either the IP address or host name. Troubleshoot as needed. Also, refer to the K2 Media Client Service Manual for troubleshooting procedures.*

Modifying network settings

When you receive a K2 Media Client from the factory, it has a loopback adapter installed. The loopback adapter allows the media file system to continue operating if an Ethernet cable is disconnected. Do not modify the loopback adapter. If you need to restore the loopback adapter, refer to the *K2 Media Client Service Manual*.

The loopback IP address is 192.168.200.200. Keep that IP address reserved on your network. Don't assign it to any other device. (If this causes conflicts with your existing network, consult your Grass Valley representative.)

If you change the host name when using a shared storage system, AppCenter could have difficulty connecting. Grass Valley strongly recommends that you do not change the host name IP address unless following the documented K2 Config procedure. For more information, refer to the *K2 Storage System Instruction Manual*.

Using FTP for file transfer

An application writer may choose to initiate media file transfers via FTP. If you do not have a preferred brand of FTP software, you can use Microsoft Internet Explorer. The K2 FTP interface displays with a GXF folder and an MXF folder. Use the appropriate folder, depending on if you are transferring GXF or MXF.

If connecting to the FTP server on a K2 system from a third-party Windows PC, make sure that the PC has TCP Window scaling enabled. (For more information on TCP Window scaling, see the Microsoft Support Knowledge Base web site.)

The K2 FTP server runs on K2 Media Servers that have the role of FTP server. While it also runs on internal storage K2 Media Clients (stand-alone), it is important to understand that it does **not** run on external storage K2 Media Clients. When you FTP files to/from a K2 Storage System, you use the FTP server on the K2 Media Server, not on the K2 Media Client that accesses the shared storage on the K2 Storage System. If you attempt to transfer FTP files to/from one of the K2 Storage System clients, the transfer fails. For information on streaming/transfer procedures in general, see the *K2 Media Client User Guide*.

NOTE: *When using FTP in a shared storage environment, please ensure that all FTP communication takes place on the FTP/Streaming network, and not on the Command/Control network.*

The following section describes the supported FTP commands.

FTP commands supported

The following table lists the FTP commands that the K2 FTP server supports.

FTP command name	FTP command description	Streaming support requirement
------------------	-------------------------	-------------------------------

USER	User Name	Supported
PASS	Password	Supported
ACCT	Account	Not supported
CWD	Change working directory	Supported
CDUP	Change to parent directory	Supported
SMNT	Structure mount	Not supported
REIN	Reinitialize	Not supported
QUIT	Logout	Supported
PORT	Data port	Supported
PASV	Passive	Supported
TYPE	Representation type	Supported
STRU	File structure	Not supported
MODE	Transfer mode	Not supported
RETR	Retrieve	Supported
STOR	Store	Supported
STOU	Store unique	Not supported
APPE	Append (with create)	Not supported
ALLO	Allocate	Not supported
REST	Restart	Not supported
RNFR	Rename From	Supported
RNTO	Rename To	Supported
ABOR	Abort	Supported
DELE	Delete	Supported
RMD	Remove directory	Supported
MKD	Make directory	Supported
PWD	Print working directory	Supported
LIST	List	Supported. Reports size in number of fields.
NLST	Name List	Supported
SITE	Site Parameters	Supported
SYST	System	Supported
SIZE	Size of file (clip)	Supported. Reports size in Bytes.
STAT	Status	Supported

HELP	Help	Supported
NOOP	No Operation	Supported

Connecting RS-422

You can control the K2 system with remote control devices and software developed for the K2 system that use industry-standard serial protocols: AMP, BVW, and VDCP. (AMP protocols can also use Ethernet connections.) You can connect up to four RS-422 cables to control K2 system channels depending on your remote control needs. Connect the RS-422 cabling as required, then refer to the *K2 Media Client User Guide* to configure the K2 system for remote control.

NOTE: The designations P1, P2, P3, P4 in this illustration refer to Port 1, Port 2, and so on. Do not confuse them with the HD/SD K2 Media Client Player channels P1, P2, etc.

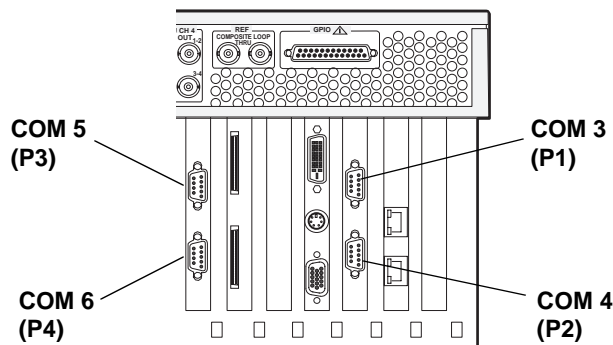

RS-422 ports and channels

The following table lists how the RS-422 ports map to the channels of the different K2 Media Client models.

	COM 3/ Port 1 (P1)	COM 4/ Port 2 (P2)	COM 5/ Port 3 (P3)	COM 6/ Port 4 (P4)
HD/SD model with two ingest channels, two playout channels	R1	P1	R2	P2
HD/SD model with one ingest channel, three playout channels	R1	P1	P2	P3
HD/SD model with one ingest channel, two playout channels	R1	P1	P2	--
HD/SD model with no ingest channel, four playout channels	P1	P2	P3	P4
HD/SD model with no ingest channel, three playout channels	P1	P2	P3	--
HD/SD model with no ingest channel, two playout channels	P1	P2	--	--
SD K2 Media Client	C1	C2	C3	C4

AMP TCP Interface

The following table lists the channel designations for the AMP protocol. When using AMP protocol with Ethernet, channels must always be identified as 'VTR1', 'VTR2', etc. When using AMP protocol with RS-422, the first channel maps to P1, the second channel maps to the P2, and so on. To configure AMP protocols, see the *K2 Media Client User Guide*.

NOTE: In reference to RS-422 connections, the terms *P1, P2, etc.*, refer to *Port 1, Port 2, and so on. Do not confuse them with player channels P1,P2, etc.*

AMP Protocol (Ethernet)	VTR1	VTR2	VTR3	VTR4
AMP Protocol (RS-422)	P1 (COM3)	P2 (COM4)	P3 (COM5)	P4 (COM6)

Connecting GPI

The K2 system provides 12 GPI inputs, and 12 GPI outputs on a single DB-25 rear panel connector.

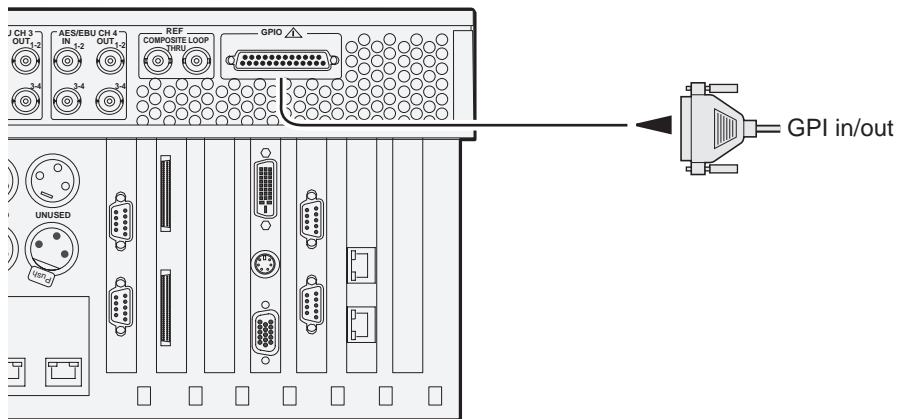

Also see the following related sections of this manual:

- [“GPI I/O specifications” on page 103](#)
- [“GPI I/O connector pinouts” on page 121](#)

Refer to the *K2 Media Client User Guide* for GPI configuration procedures.

Managing Internal Storage

Topics in this chapter include the following:

- [“About the K2 Media Client internal storage system”](#)
- [“Using Storage Utility”](#)

About the K2 Media Client internal storage system

Both HD/SD and SD-only models are available with internal media storage. This makes the internal storage K2 Media Client a self-contained, stand-alone unit, with no external devices for storage, audio, or video connections required.

The storage system on an internal storage K2 Media Client includes the following:

RAID drives — There are twelve RAID drives, located behind the fan module in the front of the unit. They are configured as six RAID 1 pairs, or LUNs. One LUN is the system drive, while five LUNs are for media storage. Each LUN appears to the operating system as a single disk. Media data is written or “striped” across the five media disks in a continuous fashion, which makes the disks a “stripe group”. This media stripe group appears as the V: drive to the Windows operating system.

SCSI controller adapter — This is a PCI board installed in the rear of the chassis. It provides the SCSI controller functionality for the internal RAID disks. Both system and media data require this RAID controller functionality, as both are stored on the internal RAID disks.

SCSI interface board — This board provides the SCSI interface for the RAID drives. It monitors and reports the status of the RAID drives, the chassis fans, and the power supplies. It also controls the individual RAID status LEDs and the front panel Power and Service LEDs. It is mounted horizontally in the front of the unit, above the RAID drives.

RAID redundancy — The two disks in a RAID 1 LUN are redundant partners. Any single disk in a LUN can fail and disk access can continue. When a disk fails, error messages in the AppCenter StatusPane or in NetCentral inform you of the problem. You can then replace the failed disk. The data is rebuilt on the replacement disk and redundancy is restored.

Using Storage Utility

This section describes using Storage Utility for general maintenance tasks on a K2 Media Client with internal media storage. Refer to the *K2 Media Client Service Manual* for repair procedures, such as those required to replace a failed drive. Also refer to [“Storage Utility” on page 40](#) for a general description of Storage Utility.

NOTE: *Do not run Storage Utility on an external storage K2 Media Client. For external storage, run Storage Utility only via the K2 System Configuration application, as explained in the K2 Storage System Instruction Manual.*

The Storage Utility runs on either the local K2 Media Client or from a control point PC. In both cases the Storage Utility's primary functionality is hosted by the K2 Media Client. The Storage Utility uses the internal connection to the RAID disks for access and configuration.

The K2 Media Client runs in either an online mode or an offline mode. These modes are required for Storage Utility operations, as follows:

- Online mode — This is the K2 Media Client's normal operating mode. When the K2 Media Client is in the online mode and you open Storage Utility, you can stay in this mode while you view the devices, LUNs, and disks of the internal storage system, but you can not configure the storage system. However, some operations are available that do not configure the storage system, such as identify a drive (flash the drive LEDs), get controller logs, disable a drive, and force a drive to rebuild.
- Offline mode — In this mode the K2 Media Client channels are disconnected and all media access operations are disabled. You are prompted to put the K2 Media Client into offline mode when you select an operation that configures the storage system. When the K2 Media Client is in the offline mode you can configure the storage system and perform all Storage Utility operations. When you exit Storage Utility you can put the K2 Media Client back into online mode.



CAUTION: Use the Storage Utility only as directed by a documented procedure or by Grass Valley Support. If used improperly, the Storage Utility can render your K2 Media Client inoperable or result in the loss of all your media.

Opening Storage Utility

There are two ways to open Storage Utility for work on an internal storage K2 Media Client, as explained in the following sections.

Opening Storage Utility through AppCenter

Unless prevented by a system problem, you should always open Storage Utility through AppCenter. When you do this your AppCenter login permissions are passed to Storage Utility, so you do not have to log into Storage Utility separately.

If you are running AppCenter on the local K2 Media Client, as Storage Utility opens it connects to the storage system of that K2 Media Client. If you are running AppCenter on a control point PC, as Storage Utility opens it connects to the storage system of the K2 Media Client that hosts the channel currently selected in AppCenter.

To open Storage Utility through AppCenter, do the following:

1. Open AppCenter, either on the local K2 Media Client or on the control point PC and logon.

Make sure you logon to AppCenter with appropriate privileges, as this logon is passed to Storage Utility. Administrator-level permission is necessary for most Storage Utility operations. If you log in with user-level permissions, the Storage Utility menu item is disabled.

2. If you are running AppCenter from a control point PC and you have channels from multiple K2 Media Clients in your channel suite, select a channel from the K2 Media Client whose internal storage you intend to configure with Storage Utility.

This is important as Storage Utility automatically connects to the K2 Media Client that hosts the currently selected channel.

NOTE: Make sure you are connecting to a K2 Media Client with internal storage. You should never connect Storage Utility directly to a K2 Media Client that uses external storage.

3. From the AppCenter **System** menu, select **Storage Utility**.

Storage Utility opens.

4. If you are connecting from a control point PC, you should verify that you are connected to the correct K2 Media Client. To verify this, use the Identify feature to flash the disks on the K2 Media Client. Refer to [“Identifying disks” on page 63](#).

Opening Storage Utility independently

Do not open Storage Utility independently unless there is a problem that prevents you from opening it through AppCenter.

To open Storage Utility independently, do the following:

1. Open the Storage Utility shortcut on the Windows desktop or from the Windows Start Menu at **Programs | Grass Valley | Storage Utility**.

A dialog box opens in which you specify the machine to connect to with Storage Utility.

NOTE: Make sure you are connecting to a K2 Media Client with internal storage. You should never connect Storage Utility directly to a K2 Media Client that uses external storage.

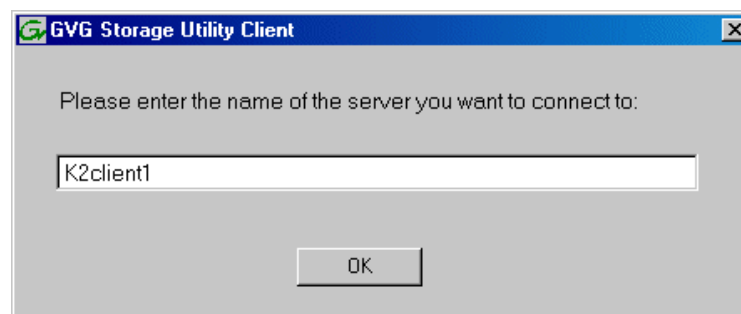

2. Enter the name or IP address of the K2 Media Client for which you intend to use Storage Utility. If you are opening Storage Utility on a local K2 Media Client, enter the name of that K2 Media Client. Click **OK**.

The Storage Utility logon dialog box opens.

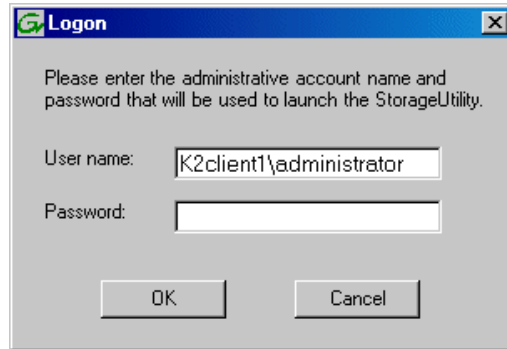

3. Logon to Storage Utility. Make sure you logon with appropriate privileges. Administrator-level permission is necessary for most Storage Utility operations. For User name, you might need to enter the machine name as the domain to successfully log on.
Storage Utility opens.
4. If you are connecting from a control point PC, you should verify that you are connected to the correct K2 Media Client. To verify this, use the Identify feature to flash the disks on the K2 Media Client. Refer to [“Identifying disks” on page 63](#).

Overview of Storage Utility

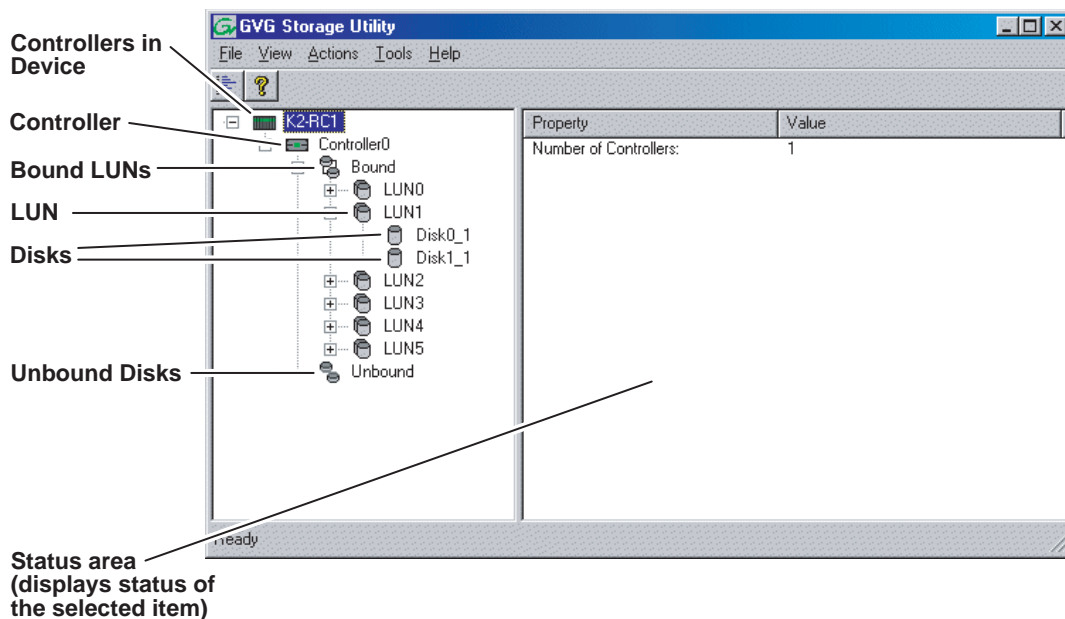

The Storage Utility user interface includes a tree view in the left-hand pane, and a status information area displayed in the right-hand pane. The tree view displays the hardware that make up the storage system connected. The context menus in the tree view are used to configure storage. The right-hand status pane displays information about the item selected in the tree view. The tree view hierarchy is as follows:

Controllers in Device - Provides a logical grouping of RAID Controllers by device.

Controller - Represents the RAID Controllers found. These are numbered in the order discovered. The controller icon represents both RAID Controller A and, if installed, RAID Controller B. To determine if an optional RAID Controller B is installed, select the Controller icon in the tree view, then examine the status pane for peer status.

Bound LUNs - Expanding the Bound node displays all bound LUNs.

LUN - Represents a bound LUN. Expanding the LUN node displays the disk modules that make up the LUN.

UnBound disks - Expanding the UnBound node, displays all unbound disk modules.

Disks - Represents the disk modules.

The Storage Utility detects disks available and lists them on the opening screen. The Storage Utility names the disks by the number of the slot in which they are installed.

Refer to the following procedures to use Storage Utility for maintenance tasks

Checking storage subsystem status

Some limited status information for storage subsystems is displayed in the Storage Utility. This can be helpful when configuring storage. You can view status information by selecting items in the tree view.

Item in tree view	Status information displayed
Controllers in Device	Number of Controllers
Controller	Microcode Version
Bound	Number of LUNs
LUN	Binding Type, such as RAID 1 State (online or offline)
Disk	Firmware Vendor State Product ID Capacity
Unbound	Number of disks

Checking controller microcode

As explained in the previous section, to check controller microcode, select the controller in the tree view and the microcode version is displayed.

Identifying disks

The Identify feature allows you to flash the disk LEDs so that you can physically locate a specific disk module or group of disk modules that make up a LUN. Always use the disk identify feature before removing and replacing a failed disk module. Accidentally removing the wrong disk module can destroy all data on the disk drives.

You can also use this feature to verify the K2 Media Client to which you are currently connected.

To identify RAID disks do the following:

1. Open Storage Utility and in the tree view expand all nodes so that all disks are displayed.

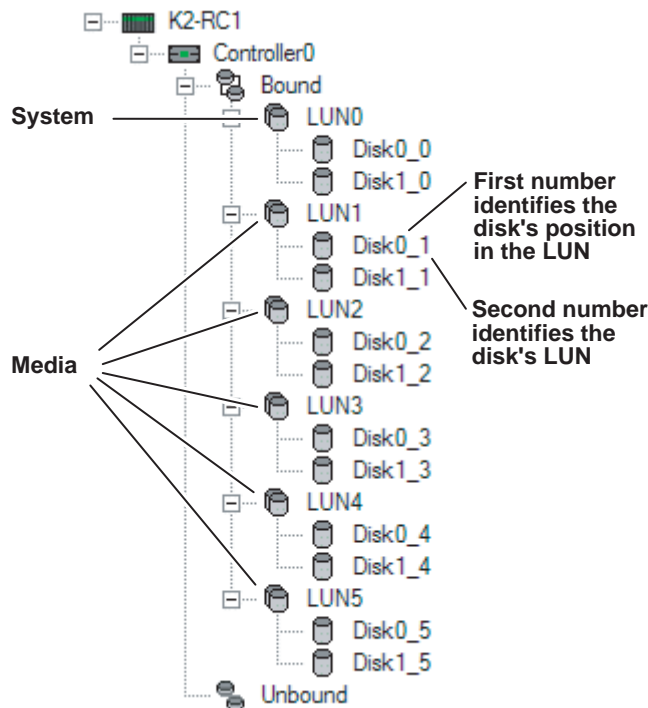

2. Remove the fan module from the K2 Media Client chassis.

NOTE: Replace the fan module within one minute to maintain system cooling.

3. Compare the RAID drive labeling on the K2 Media Client chassis and the disk numbering displayed in Storage Utility to identify drive locations. To understand RAID drive numbering, refer to [“RAID drive numbering” on page 36](#). Then position yourself so you can see the RAID drive LEDs, which are in the rear of the drive bay.
4. Identify the disks in a LUN or identify a single disk, as follows:
 - a. In the Storage Utility tree view, right-click a LUN or right-click a single disk, then select **Identify LUN** or **Identify Disk** in the context menu. A message box opens with a message that informs you that a disk or disks are blinking.
 - b. The LEDs on the disk or disks display a flashing pattern alternating yellow/green once a second. Verify the location of the disk or disks.

Get controller logs

1. In the tree view, select the controller.

2. Click **Actions | Get Controller Logs**.
3. A message informs you of the location of the logs.
4. Find the following files on the local K2 Media Client at *C:\profile\logs*:
 - MegaRaidDriveFailureLog.txt
 - MegaRaidNVRAMLog.txt
 - tty.log

Check disk mode pages

1. In the tree view, right-click the controller and select **Check Disk Mode Pages**.
2. Messages report the results of the check. For each disk that has mode pages set incorrectly, click **Yes** when prompted "...restore the default mode page settings?".

Disabling a disk

1. In the tree view, right-click the disk and select **Advanced | Disable**.
2. When the message "The drive is spinning down...Please wait" appears, click **OK**.
The Service LED on the K2 Media Client displays a flashing yellow pattern three time a second.
3. When the message "Operation succeeded...now safe to remove disk" appears, click **OK**.
4. The Storage Utility displays red Xs on tree view icons to represent a disk fault and a degraded LUN.

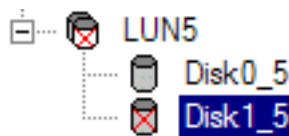

NOTE: Remember that the LUN 0 (disks 0_0 and 0_1) is the system drive. Do not attempt disk operations on the system drive.

Forcing a disk to rebuild

If media access (record/play) is underway, when you insert a media disk it automatically begins to rebuild. If there is no media access underway, to start the rebuild process either begin a media operation or use the following procedure:

1. In the tree view, identify the faulty disk.  If the disk is not currently in the fault state, the Rebuild option is not available.
2. In the tree view, right-click the faulty disk and select **Rebuild**.
3. When the message "Succeeded to start rebuild..." appears, click **OK**.
The Service LED on the K2 Media Client displays a flashing pattern alternating yellow/green once a second.

4. To check the progress of the disk rebuild, click **View | Progress Report**.

Unbind LUN

You can only unbind one LUN at a time. Also make sure the controller is not busy with other processes, such as rebuilding a disk. If the controller is busy, the unbind LUN operation fails.



CAUTION: *Unbinding destroys all data stored on disk modules.*

To unbind a LUN, do the following:

1. In the tree view, right-click the LUN and select **Unbind LUN**.
2. If the K2 Media Client is online, messages appear "...offline mode now?" and "...continue?". Click **Yes** to put the K2 Media Client in offline mode.
AppCenter channels go offline.
3. When warning messages appear "...destroy all existing media..." and "Are you sure?", click **OK** to continue.
4. The Progress Report opens and displays unbind progress.

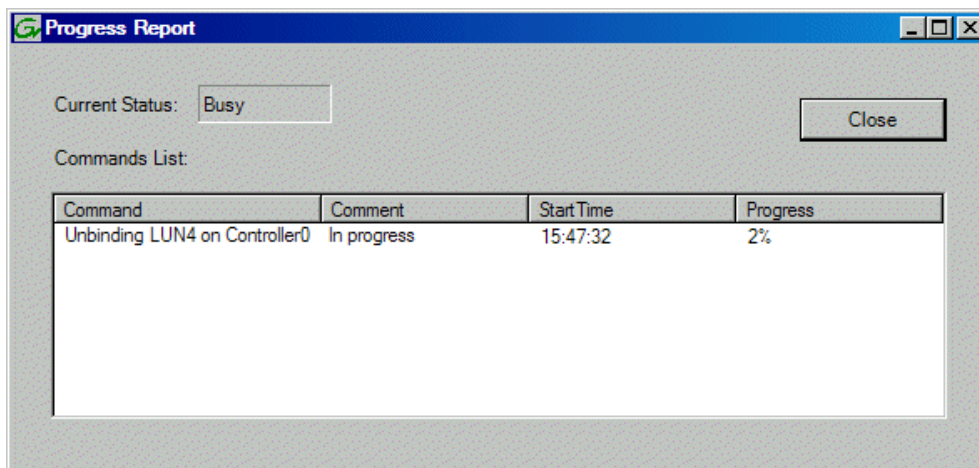

5. When progress reports 100% complete, the LUN is unbound.
6. Restart the K2 Media Client.

NOTE: *Remember that the LUN 0 (disks 0_0 and 0_1) is the system drive. Do not attempt disk operations on the system drive.*

Bind Luns

When you bind a LUN, you select unbound disks and create a new LUN. The Storage Utility places this new LUN at the bottom of the list and numbers it accordingly. However, disk numbers are enforced by the chassis slot in which the disk resides.

Therefore if some LUNs remain bound while you are creating a new LUN, it is possible that the new LUN number and the disk numbers will not match. When you create a new file system, this mismatched numbering does not hamper functionality. However, to make the K2 Media Client easy to service, you should retain the correct numbering sequence. To do this you must unbind all media LUNs (not the System LUN) and then bind disks in sequence.

To bind a LUN, do the following:

1. In the tree view, right-click the **Unbound** node and select **Bind LUN**.
2. If the K2 Media Client is online, messages appear "...offline mode now?" and "...continue?". Click **Yes** to put the K2 Media Client in offline mode.

AppCenter channels go offline.

The Bind LUN dialog box opens showing all unbound disks for the controller listed in the Available Disk list.

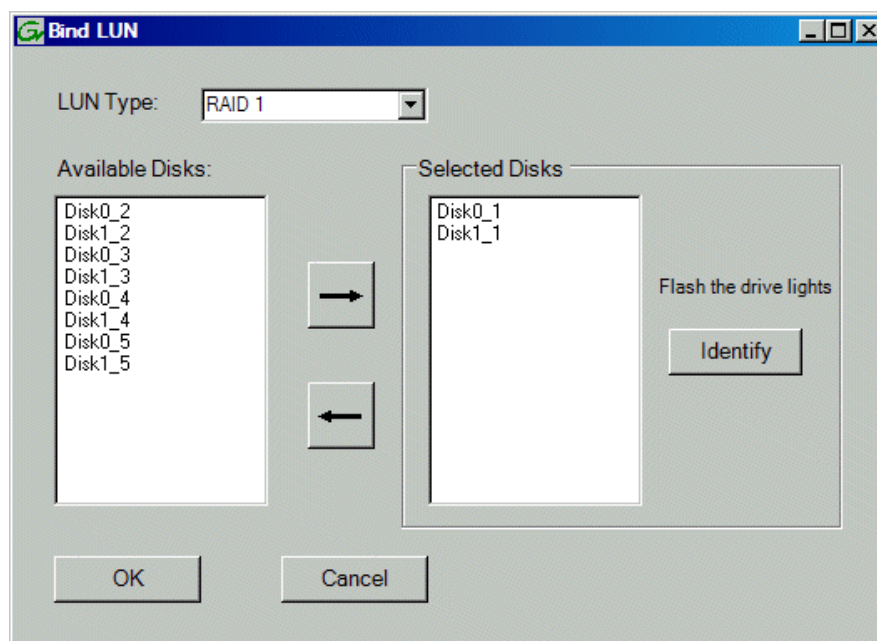

3. Select two contiguous disks, then click the arrow button to add them to the Selected Disks list. (TIP: Use 'shift-click' or 'control-click' to select disks.)

NOTE: *As an aid in identifying a disk module's physical location, select it in the Selected Disks list, then click Identify Disks. This causes the disk drive LED to flash.*

4. Click **OK** to close the Bind LUN dialog box and begin the binding process.
The Progress Report opens and displays unbind progress.
5. When progress reports 100% complete, the LUN is bound.
6. Repeat the previous steps for other unbound disks.
7. Restart the K2 Media Client.

8. After binding one or more new LUNs, you must make a new file system, as explained in the next procedure.

Make New File System

1. Click **Tools | Make New File System**.
2. If the K2 Media Client is online, messages appear "...offline mode now?" and "...continue?". Click **Yes** to put the K2 Media Client in offline mode.
AppCenter channels go offline. The Configuration File window opens.

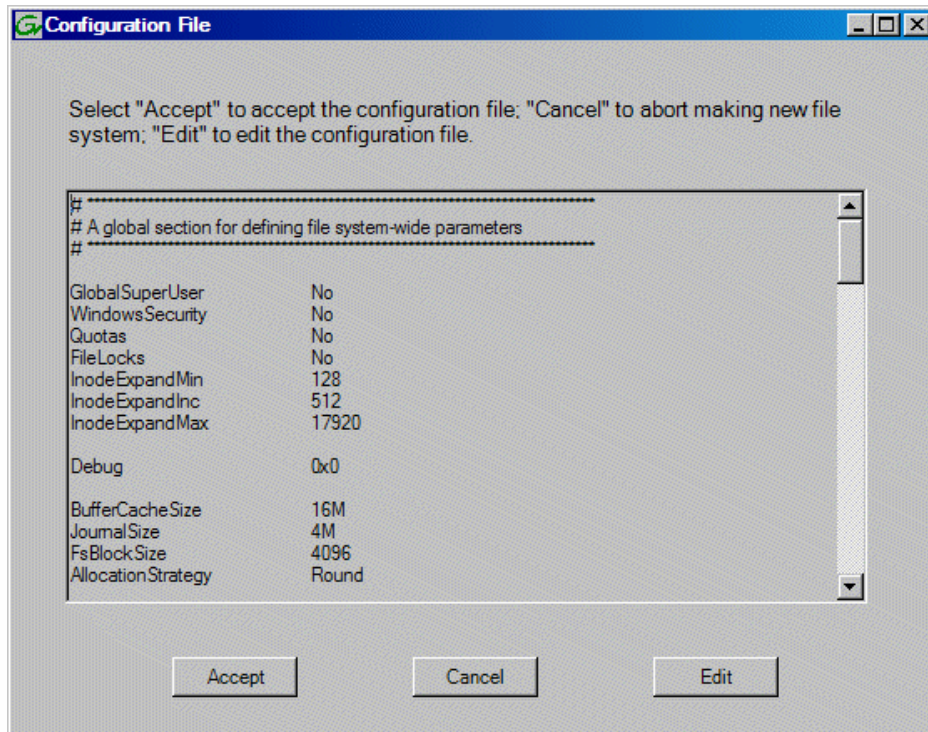

3. You can view media file system settings, but do not attempt to change them. Click **Accept**.
A "Making new file system. Please wait" message box displays progress.
4. When a message "Succeeded to make the new file system. The server will be restarted now" appears, click **OK** to restart the K2 Media Client.

Check File System

This procedure checks the media file system but retains current media files.

1. Click **Tools | Check File System**.
2. If the K2 Media Client is online, messages appear "...offline mode now?" and "...continue?". Click **Yes** to put the K2 Media Client in offline mode.
AppCenter channels go offline.
3. A message box appears "Checking media file system. Please wait". Observe progress.

If problems are discovered they are reported. If the check process passes, when the process is complete a message appears to confirm success.

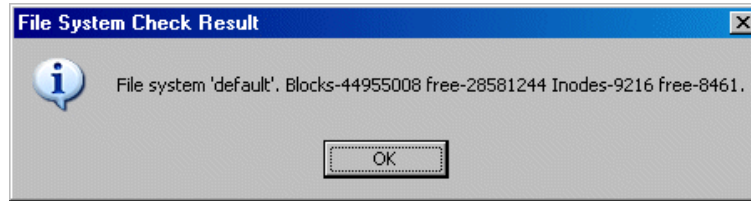

4. Click **OK** to dismiss the results.

Your file system has been checked.

Cleaning unreferenced files and movies

These procedures allow you to keep the media database and the media files in sync. You can check the movies (clips) in the media database for the references to media files that should be currently stored on the media disks. Likewise, you can check for media files that are not referenced by a movie in the media database. If you find any unreferenced files or movies, you can delete them.

To clean unreferenced files, do the following:

1. Click **Tools | Clean Unreferenced Files**.
2. If the K2 Media Client is online, messages appear "...offline mode now?" and "...continue?". Click **Yes** to put the K2 Media Client in offline mode.
AppCenter channels go offline.
3. A message box appears "...searching...Please wait". Observe progress.
4. A message box reports results. Respond as follows:
 - If no unreferenced files are found, click **OK** to dismiss the results.
 - If unreferenced files are discovered, you are prompted to delete them. Click **Yes** to delete the files or **No** to leave the files intact.

To clean unreferenced movies, do the following:

1. Click **Tools | Clean Unreferenced Movies**.
2. If the K2 Media Client is online, messages appear "...offline mode now?" and "...continue?". Click **Yes** to put the K2 Media Client in offline mode.
AppCenter channels go offline.
3. A message box appears "...searching...Please wait". Observe progress.
4. A message box reports results. Respond as follows:
 - If no unreferenced movies are found, click **OK** to dismiss the results.
 - If unreferenced movies are discovered, you are prompted to delete them. Click **Yes** to delete the movies or **No** to leave the movies intact.

Loading RAID controller microcode

You might be instructed in K2 release notes to upgrade the RAID Controller microcode on the RAID chassis. This allows you to take advantage of the RAID enhancements and benefit from improved reliability.

To upgrade RAID Controller microcode, do the following:

1. In Storage Utility, right-click a controller in the tree view, then select **Advanced | Load Controller Microcode**. Redundant controllers that share the same set of disks are automatically selected and upgraded as a pair.

The Open File dialog box appears.

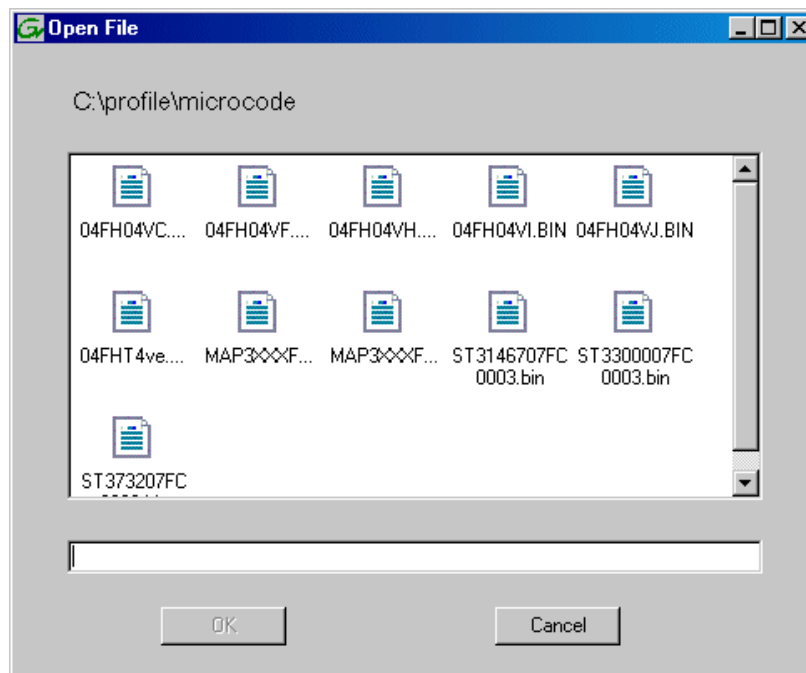

2. In the Open File dialog box, browse to the latest controller microcode file for your controller, select the file, and click **OK**.
3. The Progress Report window appears showing the microcode upgrade task and the percentage completion.
4. On 100% completion, power cycle the RAID controller chassis, then restart the K2 Media Server.

Downloading disk drive firmware

You might be instructed K2 release notes to upgrade disk drive firmware. This allows you to take advantage of the disk drive enhancements and benefit from improved performance and reliability.

To determine your disk drive type and current firmware version, select a disk drive icon in the Storage Utility tree view, then note the drive properties reported in the right-hand pane. Use the following procedure if you need to download disk drive firmware.

NOTE: The disk drives on each controller are upgraded one at a time which can take as long as 2 minutes per drive. Take this into consideration when scheduling the upgrade.

Requirements for this procedure are as follows:

- All K2 Media Clients and other iSCSI clients must be powered down, or in some other way disconnected from the K2 Storage System.
- The K2 Media Server through which Storage Utility is connected to the RAID Storage must be powered up.
- All other K2 Media Servers must be powered down.

To download disk drive firmware, do the following:

1. In the Storage Utility, right-click a controller in the tree view, then select **Advanced | Download Disk Firmware** in the context menu. The Open File dialog box opens.

NOTE: You can download firmware to a single disk by right-clicking a disk icon in the tree view.

2. In the Open File dialog box, browse to the latest firmware file for your disks, select the file, and click .
3. Click **OK**.

The Progress Report window appears showing the disk firmware download task and the percentage completion.

4. When finished, restart the RAID storage and the K2 Media Server.

Storage Utility operation not supported

The following option is displayed in the Storage Utility menu system, but the operation is not supported on the K2 Media Client:

- Expand File System by Capacity

Placing the K2 Media Client into online mode

If the K2 Media Client is in offline mode and you have completed your storage system configuration tasks, you have the following options to return the K2 Media Client to the online mode:

- **Exit Storage Utility and bring channels online** — If Storage Utility is closed, first open Storage Utility and then exit Storage Utility. When you exit Storage Utility you are prompted "...back to online mode?". Click **Yes**.

After exiting Storage Utility, if AppCenter is open the channels remain offline. To bring channels online, if you are running AppCenter on a control point PC, select

System | Reconnect. If you are running AppCenter on a local K2 Media Client, close and reopen AppCenter.

- **Restart the K2 Media Client** — Restarting automatically resets the K2 Media Client to online mode. When you log into AppCenter channels connect and come up online.

Managing K2 client system software

This chapter contains the following topics:

- [“About K2 Media Client system software”](#)
- [“Backup and recovery strategies”](#)

About K2 Media Client system software

The primary software installations for the K2 Media Client and K2 products are as follows:

This software...	Is distributed on...	With the installation file located at...	Which is installed on...	And is described as follows:
K2 Client	The K2 System Software CD	<i>../K2Client/setup.exe</i>	K2 Media Clients	Provides core functionality for all K2 Media Client models, including SD-only, SD/HD, internal storage, and external storage models.
K2 Server	The K2 System Software CD	<i>../K2Server/setup.exe</i>	K2 Media Servers	Provides core functionality for all K2 Media Servers in all roles.
Control Point	The K2 System Software CD	<i>../ControlPoint/setup.exe</i>	Control Point PCs	Provides remote control and configuration of K2 Media Clients (both internal and external storage) as well as the K2 Storage System.
NetCentral	The NetCentral Manager CD	<i>../ServerSetup.exe</i>	The NetCentral server PC (this can be a Control Point PC)	Provides remote monitoring of all K2 products. (Optional for K2 Media Clients with internal storage.)

In addition, the following software is installed in special cases:

- Multi-Path I/O software — You must install this software on K2 Media Clients that are part of a Level 2R or 3R K2 Storage System. Refer to [“External Storage” on page 85](#) for more information.

Software components installed

Each of the K2 installation packages installs software components that provide the functionality for various applications and system tools. The components installed are as follows:

Software	Components installed	Comments
K2 Client	Core system software	Provides the primary media functionality.
	AppCenter user interface	Allows you to operate AppCenter on the local machine.
	AppServer	Provides AppCenter functionality. It is accessed by both the remote AppCenter (on a Control Point PC) and the local AppCenter user interface.
	Storage Utility	Configures the media storage on internal storage K2 Media Clients only. Do not run Storage Utility on external storage K2 Media Clients.
	K2 System Configuration	Installed only on external storage models. Provides to the remotely connected K2 System Configuration application the ability to configure the local machine. You cannot run the K2 System Configuration user interface on the local K2 Media Client.
	Multi-Path I/O	Installation files copied to K2 Media Client but software not installed.
K2 Server	Core system software	Provides the primary media functionality.
	Storage Utility	Provides functionality for the remotely connected Storage Utility that runs on the Control Point PC. You should not run Storage Utility locally on the K2 Media Server.
	K2 System Configuration	Provides to the remotely connected K2 System Configuration application the ability to configure the local machine. You cannot run the K2 System Configuration user interface on the local K2 Media Server.
Control Point	AppCenter user interface	Connects to K2 Media Clients for control and configuration of channels.
	K2 System Configuration user interface	Connects to K2 Media Clients, K2 Media Servers, RAID storage, and Gigabit switches for configuration of the K2 Storage System.
	Storage Utility	Connects to the K2 Media Server, and through the K2 Media Server to the RAID storage, for configuration of the media file system, media database, and RAID storage.

Installing Control Point software

If you are using the Grass Valley control point PC, it comes from the factory with software installed, so you should not need to install software.

If you intend to use a PC that you own as a control point PC, make sure that you choose a PC that meets system requirements for supporting Control Point software. Refer to [“Control point PC system requirements” on page 117](#). Then all that is required is to install the Control Point software from the K2 System Software CD, as referenced in the preceding section.

Installing K2 software

Except as noted in the preceding sections, when you receive your K2 Media Client, you do not need to install software. The system has the most recent software pre-installed at the factory. If you are upgrading software on a K2 Media Client, refer to the *K2 Media Client Release Notes* for that version of software for specific software upgrade procedures.

Re-installing Grass Valley software

NOTE: Follow these instructions if you need to re-install software. If you are upgrading to a new release version, see the *Release Notes for the latest information on installation procedures*. For more information on recovery procedures, see [“Backup and recovery strategies” on page 78](#).

In most cases you can re-install the same version of software by simply running the correct *setup.exe* file from the K2 System Software CD.

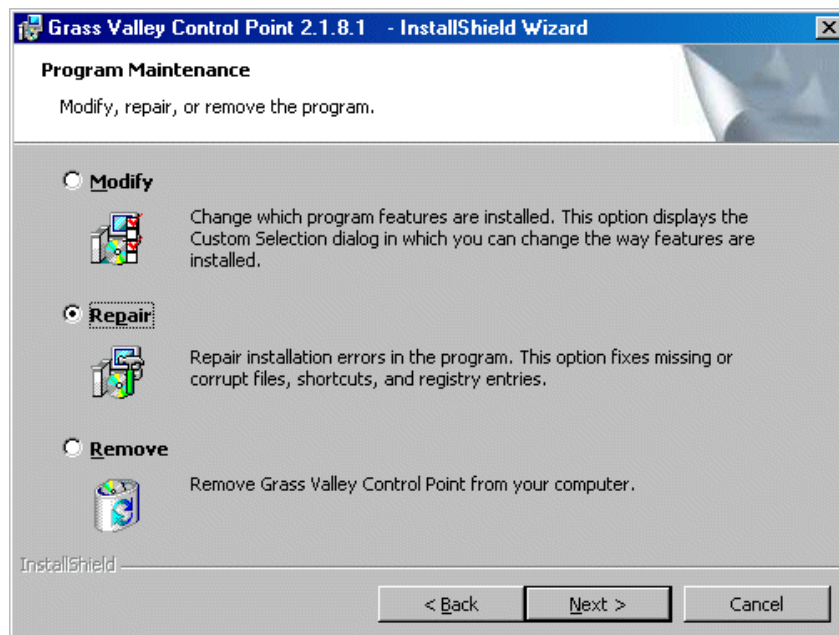

At the opening screen of the install wizard, select **Repair**, then use the following instructions for the type of software you are installing:

K2 Client software

Follow the onscreen instructions, clicking **Next** on each page.

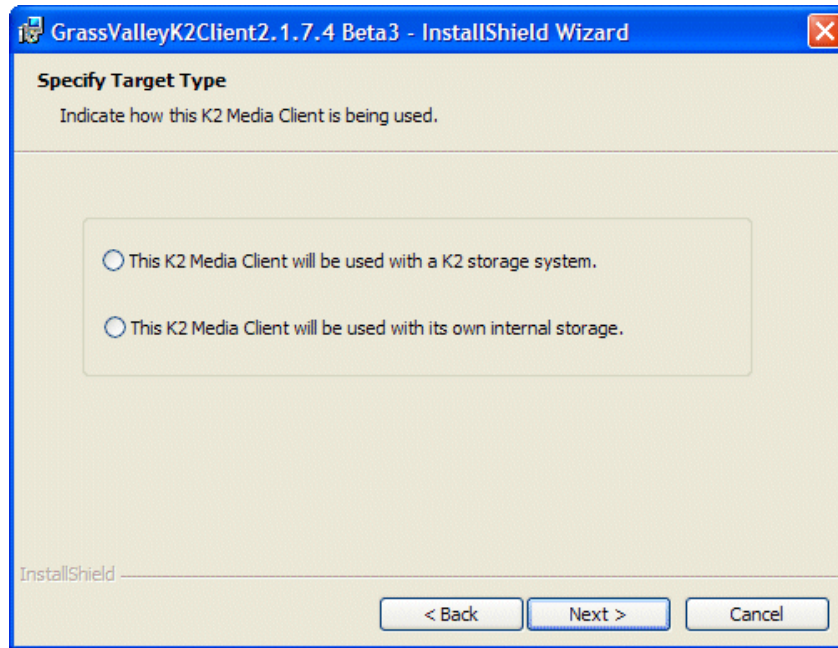

When you arrive at the Specify Target Type page, select as follows:

- **This K2 Media Client will be used with a K2 storage system** — Select this option if you are installing on an external storage K2 Media Client.
- **This K2 Media Client will be used with its own internal storage** — Select this option if you are installing on an internal storage K2 Media Client.

Click **Next** and **Finish** to complete the installation. When prompted, restart the machine.

K2 Server software

Follow the onscreen instructions. Click **Next** and **Finish** to complete the installation. When prompted, restart the machine.

Control Point software

Follow the onscreen instructions. Click **Next** and **Finish** to complete the installation.

Pre-installed software

The following software is pre-installed on K2 products when you receive them from the factory. This load of pre-installed software is referred to as the “golden drive”.

K2 Media Client pre-installed software

- Adobe Acrobat Reader 7.0.2
- ATI video driver for Radeon 9250

- Windows XP CD Writing Wizard
- Intel Client Instrumentation
- Intel Pro Intelligent Installer
- Intel Pro Software 10.1
- Intel Pro WMI Provider 2.0
- J2SE Runtime Environment 5.0 Update 4
- Microsoft iSCSI Initiator 2.0
- MS XML 4.0
- .NET Framework 1.1
- .NET Framework 1.1 Hotfix
- MS-SQL Desktop Engine Service Pack 3
- Power Console Plus 5.00n
- Quicktime
- StorNext 2.5.2b56
- Supero Doctor 3
- Texas Instruments VCP Install 1.2.11.3 - For USB RS422 ports
- Windows Installer 3.1

K2 Media Server pre-installed software

- Adobe Reader 7.0.3
- ATI Display Driver - 8.08-041111a-020816C-Dell
- Dell OpenManage - 4.2.0
- Dell OpenManage Array Manager
- Dell OpenManage IT Assistant
- Easy CD Creator 5 Basic - 5.3.4.21
- Intel LAN Adapter SNMP Agent - 1.00.0000
- Intel Pro Network Adapters & Drivers
- IT Assistant v6.5 SP3
- J2SE RunTime Environment 5.0 Update 4 - 1.5.0.40
- MS J# Redistributable Package 1.1
- MS SQL 2000 SP3 - 8.00.760
- MS XML 4.0 SP2 Parser & SDK - 4.20.9818.0
- OpForce IT Automation Suite v2.1
- OSA BMC Management Utility

- SQL XML 3.0 - 80.1529.1
- StorNext File System - 2.5.2b56
- SanSurfer Control iX - 1.0.0.0
- Windows Server 2003 SP1
- Updates - KB896428, KB883939, KB890046, KB896358, KB896422, KB898715, KB901214, KB903235

Grass Valley Control Point PC pre-installed software

- Broadcom Gigabit Integrated Controller
- Conexant D850 V.9x DFVc Modem
- Dell Resource CD
- HighMAT Extension to WinXP CD Writing Wizard
- .NET Framework 1.1
- .NET Framework 1.1 Hotfix
- MS XML 4.0 Parser & SDK
- Windows Installer 3.1
- Windows Media Connect

Backup and recovery strategies

There are three partitions on the K2 Media Client system drive to support backup and recovery strategies as follows:

- The C: drive is for the Windows operating system and applications.
- The D: drive is for media file system (SNFS) metadata files and media database data files. This allows you to restore the Windows operating system yet keep your media metadata intact.
- The E: drive is for storing a system image of the other partitions. From the E: drive you can restore images to the C: and D: drives. When you receive your K2 Media Client from the factory, the default factory image is stored on the E: drive.

For more information on backup and recovery strategies, see the *K2 Media Client Service Manual*.

Administering and maintaining the K2 system

This chapter contains the following topics:

[“Synchronizing system clocks” on page 79](#)

[“Licensing” on page 79](#)

[“Security considerations” on page 79](#)

[“Enabling and disabling the USB ports” on page 83](#)

Synchronizing system clocks

If you are using a K2 Media Client with internal storage, then synchronizing system clocks is not required. However, if you are using a K2 Media Client with external storage or as part of a larger network, the system clocks on the devices of the K2 system must be kept synchronized. The main purpose for this time synchronization is so that entries in the various logs on the K2 system devices can be correlated. The following procedure describes a mechanism by which clocks are synchronized. If your facility has other mechanisms by which you synchronize system clocks, you can use your own methods, as long as it accomplishes the goal of keeping the system clocks synchronized.

To synchronize system clocks, do the following:

1. Designate a K2 Media Server as the time server.
2. On each K2 Media Client, iSCSI client, and any additional K2 Media Servers, in the Windows **Control Panel** open **Date and Time**.
3. On the **Internet Time** tab, enter the K2 Media Server that is the time server.

Licensing

For SD-only models, a codec upgrade license is available that adds D10 and DV50 compression and increases available MPEG-2 compression data rate up to 50Mbs, 4:2:2. Contact your Grass Valley representative to purchase the license. Instructions are provided when you receive the upgrade kit.

Security considerations

To provide a basic level of security, the K2 Media Client ships from the factory with four different security levels. The following table shows the different types of K2 user and their privileges. The password is case sensitive.

	Windows administrator	K2 administrator	K2 user	Unknown user
Login	Administrator	K2admin	K2user	N/A ^a

	Windows administrator	K2 administrator	K2 user	Unknown user
Password	adminK2	K2admin	K2user	N/A
AppCenter Configuration Manager	Full access	Full access	Can view	Can't access
AppCenter	Full access	Full access	Full access; requires an account on the K2 Media Client(s)	Can view channel suites, channel status, on-line help and System Status pane. Can export logs.
Storage Utility	Full access ^b .	Full access	Can't access	Can't access
K2 Config	Full access ^b	Full access	Can't access	Can't access
PC on which K2 Media Client or Control Point software is run	Full access	Limited access (based on Windows login privileges)	Limited access (based on Windows login privileges)	Limited access (based on Windows login privileges)

a. The unknown user, like all others who access the K2 system, must have a valid Windows login for the K2 Media Client or the control point PC through which the K2 system is being accessed.

b. For more information about Storage Utility or K2 Config security, see the *K2 Storage System Instruction Manual*.

Grass Valley recommends that you implement security with unique usernames and passwords for these user levels. In addition, bear in mind the following:

- To access any of the applications, you need to log on.
- All users except for the unknown user must have a valid password.
- Users must have the same local accounts on all control point PCs, K2 servers, K2 storage systems, and K2 Media Clients that they need to access. For example, to perform Windows administrator tasks from a control point PC, you need Windows administrator rights on the control point PC as well on the K2 Media Clients and K2 Media Servers that you need to access.

K2 and NetCentral security considerations

When using K2 with NetCentral, bear in mind that NetCentral has its own levels of security. Grass Valley recommends mapping the NetCentral administrator with the K2 administrator level. You need Windows administrator privileges to add or modify a user's privileges.

Mapping a NetCentral administrator to the K2 administrator level

The following procedure uses K2admin as an example of a user name. You may want to modify the administrator accounts to bring them in line with your site's security policies.

A user who belongs to a group has all the rights and permissions granted to that group. To be able to use NetCentral and K2, you need to create a local **K2admin** user account and add it to the **NCAAdministrator** group on the NetCentral Server PC. (This could also be the control point PC.)

1. Create the user named **K2admin**:
 - a. Open Computer Management.
 - b. In the console tree, right-click on the Users folder.
 - c. Select New User.
 - d. In the New User dialog box, enter the user name **K2admin** and the password **K2admin**.
 - e. Select or clear the check boxes, as desired, for:
 - User must change password at next logon
 - User cannot change password
 - Password never expires
 - Account is disabled
 - f. Click Create, and then click Close.
2. Add the **NCAAdministrator** group to the **K2admin** user:
 - a. Open Computer Management.
 - b. In the console tree, click Users.
 - c. Right-click the **K2admin** user and select Properties.
 - d. Select the Member Of tab and click Add.
 - e. Enter the group name **NCAAdministrator** and click OK.

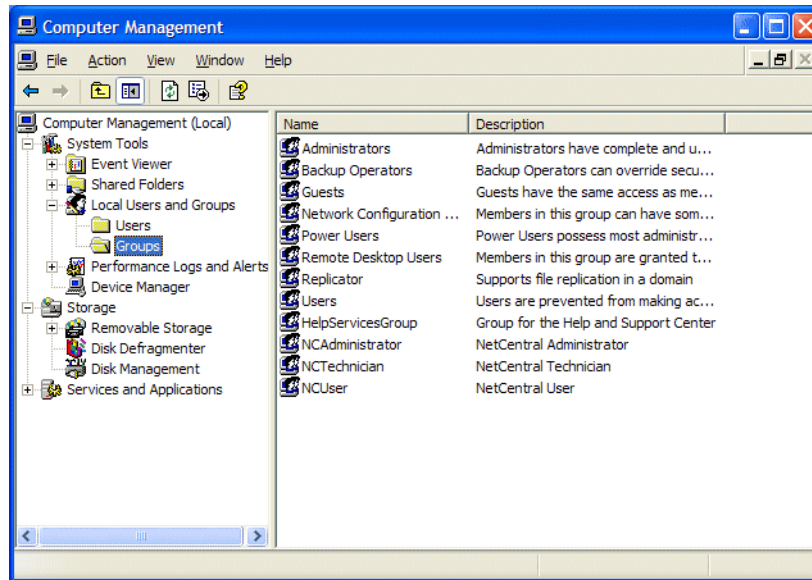

For more information on NetCentral security, see the NetCentral on-line Help.

Virus scanning and protection policies

The K2 system is based on a standard Windows PC platform. It is important to defend this system against virus or SpyWare attacks. Grass Valley supports the scanning of the K2 system drives (the disk drives or drive partition used to house the operating system and installed application software) from a PC that is running the scanning program while the K2 is being used to record or play video to air. The anti-virus package executing on the PC can be scheduled to scan the system drives of multiple K2 Systems.

The following strategies are recommended for virus scanning:

- Run the scanning software on a dedicated PC that connects to the K2 system via a network mount. Do not run scanning software locally on the K2 Media Client.
- Connect to the K2 Media Client via 100BaseT network. This constrains the bandwidth and system resources consumed, so as to not interfere with media operations. Do not connect and scan via Gigabit Ethernet.
- Grass Valley does not support the running of anti-virus programs on a K2 System itself at the same time the system is being used to record or play video to air.

With these recommended strategies, you should be able to scan the K2 Media Client without interrupting media access.

In addition, the following protection policies are recommended:

- Where possible, the K2 system should be run in a closed and protected environment without network access to the corporate IS environment or the outside world.
- If the K2 system must operate in a larger network, Grass Valley recommends that access be through a gateway or firewall to provide anti-virus protection. The

firewall should allow incoming HTTP (TCP ports 80 and 280) connections for client and configuration connections to the K2 system inside the private network. Additionally, ports should allow incoming packets so requests to the Proxy NAS can be properly processed. The port that needs to be open is port 445 for TCP and UDP for Windows and SAMBA shares. If your site's policies require that these port numbers change, contact Grass Valley support for assistance.

- Access to the K2 system should be controlled in order to limit the likelihood of malicious or unintended introduction of viruses.
- The front and rear USB ports of the K2 system should normally be disabled; they should only be used by Windows administrators. (Be careful not to disable the RS-422 USB.) For more information, see [“Enabling and disabling the USB ports” on page 83](#).

Enabling and disabling the USB ports

Grass Valley recommends that the front and rear USB ports be disabled. This protects the K2 Media Client from exposure to unauthorized files. Do not disable the RS-422 USB. The following illustration shows which USB ports should be disabled in Windows Device Manager.

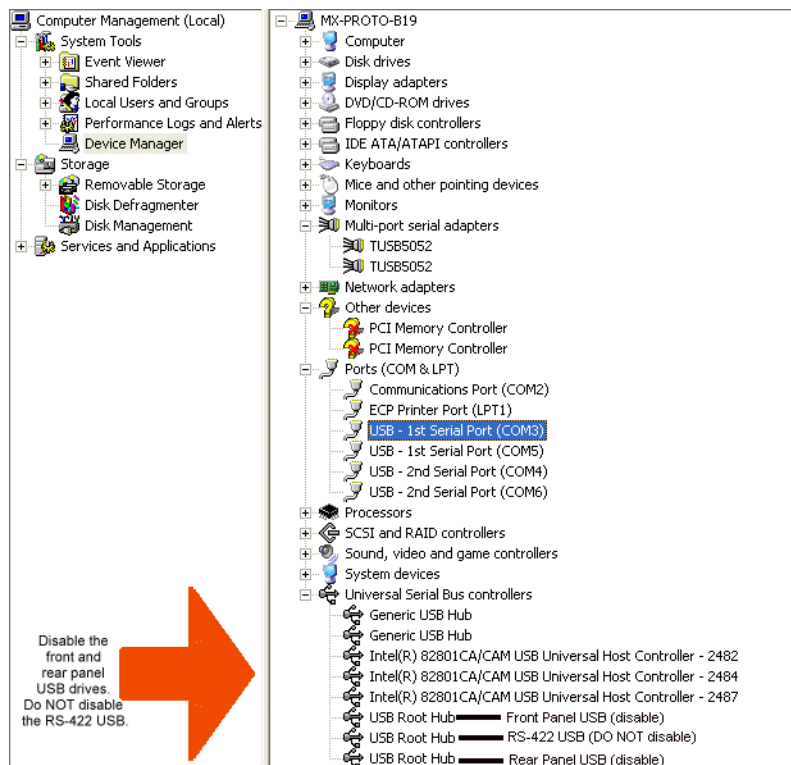

Only the Windows administrator, working locally, can enable or disable USB ports. To enable a USB port, right-click on the USB device in Windows Device Manager and select **Enable**. You cannot enable the K2 Media Client USB port via a control point PC.

To transfer to or from a USB drive on an internal storage K2 Media Client, the Windows administrator should first enable the USB port. When the transfer is complete, the Windows administrator should then disable the USB port to prevent unauthorized use. Transferring to and from a USB drive is supported on a local internal storage K2 Media Client only. USB drive transfers on external storage K2 Media Clients, K2 Media Servers, or control point PCs are not supported. Assets must be exported to a USB drive one at a time. Attempts to export more than one asset at the same time will result in the transfer aborting.

External Storage

Work through the following topics to connect K2 Media Client models with external storage to the K2 Storage System:

- [“About load balancing” on page 86](#)
- [“Determining K2 Media Client bandwidth requirements” on page 87](#)
- [“Preparing the K2 Storage System” on page 87](#)
- [“Preparing K2 Media Clients” on page 87](#)
- [“Adding K2 Media Clients” on page 90](#)
- [“Basic operations for external storage K2 Media Clients” on page 96](#)

About load balancing

When you purchase a K2 Storage System to provide the shared storage for your K2 Media Clients, your Grass Valley representative sizes the storage system based on your bandwidth requirements. These bandwidth requirements are based on how you intend to use the channels of your K2 Media Clients. The bit rates, media formats, and ratio of record channels to play channels all effect your bandwidth requirements.

As you add your K2 Media Clients to the K2 Storage System, you must assign a bandwidth value to each K2 Media Client. This value is based on your intended use of the channels of that K2 Media Client. There is a page in the K2 System Configuration application on which you enter parameters such as channel count, bit rate, and track count per channel to calculate the bandwidth value for a K2 Media Client. The K2 System Configuration application takes that bandwidth value and load balances it across the K2 Storage System, so that the K2 Media Client has adequate bandwidth for its intended media access operations. When the bandwidth values you enter in the K2 System Configuration application match the overall bandwidth requirements upon which your K2 external storage is sized, you have sufficient bandwidth for all your K2 Media Clients.

Load balancing is important for the K2 Storage System because of the relative bandwidth constraints inherent in Gigabit Ethernet and the iSCSI protocol. The K2 Storage System uses a mechanism called a TCP/IP Offload Engine (TOE) as a bridge across which all media must travel between the iSCSI/Gigabit world and the SCSI/Fibre Channel world. Each TOE has a limit as to how much bandwidth it can handle.

Depending on the level of your K2 Storage System you have one or more TOEs available for load balancing. A TOE is hosted by the iSCSI interface board, which also provides the Gigabit Ethernet connection. The Level 1 RAID Storage device has one iSCSI interface board. K2 media servers each have two iSCSI interface boards.

As you configure your K2 Storage System, the K2 System Configuration application assigns a K2 Media Client to a specific TOE and keeps track of the bandwidth so subscribed to each TOE. A single K2 Media Client can only subscribe to a single TOE. However, a single TOE can have multiple K2 Media Clients subscribed to it. The K2 System Configuration application assigns K2 Media Clients to each TOE, filling them until their subscription is full.

You should add your highest bandwidth K2 Media Clients first to the K2 Storage System, so that the K2 System Configuration application can distribute them equally across the available TOEs. Then when you add the lower bandwidth K2 Media Clients, the K2 System Configuration application can add them to the TOEs with bandwidth remaining.

It is important to realize that this load balancing does not adjust itself dynamically. If you change your intended use of a K2 Media Client and increase its bandwidth requirements, you risk oversubscribing the TOE to which that K2 Media Client is assigned. If this happens, media access fails on all the clients assigned to the TOE.

To prevent oversubscription problems you should load balance your K2 Storage System again if you must increase the bandwidth requirements of a K2 Media Client. You can do this using the K2 System Configuration application. To stay under the total bandwidth limit of the K2 Storage System, you might have to decrease the bandwidth requirements of another K2 Media Client. In any case you must again load balance.

Determining K2 Media Client bandwidth requirements

The K2 System Configuration application provides a page in the Configure K2 Client wizard that calculates the bandwidth requirement for a K2 Media Client. On this page you enter information regarding the channel count, bit rate, and tracks per channel for your intended use of the K2 Media Client. The page then calculates the bandwidth requirement and make it available for load balancing. Refer to [“Adding K2 Media Clients” on page 90](#) for procedures.

Preparing the K2 Storage System

Refer to the *K2 Storage System Instruction Manual* to install and configure the K2 Storage System so that it is prepared for the addition of your external storage K2 Media Clients.

The following K2 Storage System preparations are required to support K2 Media Clients:

- All K2 media servers and/or K2 RAID storage devices must be installed and cabled.
- The media network and control network must be operational and K2 devices communicating on these networks as appropriate.
- K2 RAID devices must have LUNs bound and be configured as required for operation on the K2 Storage System.
- K2 media servers (or the K2 Level 1 Storage device) must be configured such that an operational media file system is present.
- K2 Ethernet switches must be configured and have V-LANs set up.
- The storage system to which you are adding your K2 Media Clients must be defined with the appropriate number and type of clients. In other words, in the K2 System Configuration application tree view you should see the K2 Media Clients you are about to add represented as unconfigured devices.

NOTE: Do not run Storage Utility on an external storage K2 Media Client. For external storage, run Storage Utility only via the K2 System Configuration application.

Preparing K2 Media Clients

Do the following to each K2 Media Client in preparation for its addition to the K2 Storage System:

- Install the K2 Media Client in its permanent location.
- Provide power to the K2 Media Client.
- Connect cables as follows:

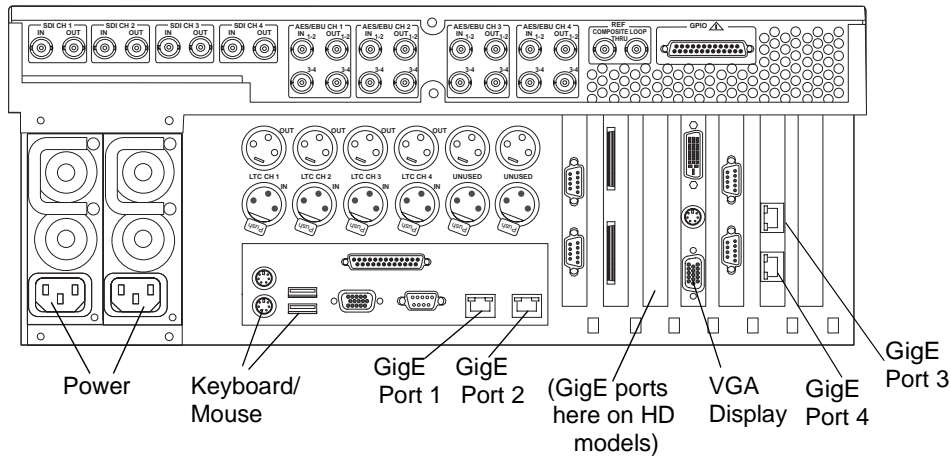

Connect GigE port 1 to a control port on the K2 Ethernet switch. For a redundant connection connect GigE ports 1 and 3 to control ports on the K2 Ethernet switch.

Connect GigE port 2 to a media port on the K2 Ethernet switch. For a redundant connection connect GigE ports 2 and 4 to media ports on the K2 Ethernet switch.

NOTE: *The connections to GigE ports 2 and 4 documented here are only valid for external storage K2 Media Clients that access shared storage on a K2 Storage System. To connect GigE ports 2 and 4 on internal storage K2 Media Clients, refer to the Internal Storage chapter earlier in this manual*

Connect keyboard, mouse, and VGA monitor.

Connect other cabling as required.

- Power on the K2 Media Client and log on to Windows as Windows administrator, which is username *administrator* and password *adminK2* by default. Ignore startup messages referring to a missing media storage system.
- Assign a control network IP address and configure other network settings for the K2 Media Client. Refer to the *K2 Storage System Instruction Manual* for networking information. Ports 1 and 3 are teamed, so even if are making a connection to port 1 only, you must configure network settings for the Control Team, as follows:
 - On the Windows desktop, right-click **My Network Places** and select **Properties**. The Network Connections window opens.
 - Look in the **Device Name** column and identify the entry named **TEAM : Control Team**.
 - Right-click the icon for this entry and select **Properties**. The Properties dialog box opens.
 - On the **General** tab select **Internet Protocol (TCP/IP)** and click the **Properties** button. The Internet Protocol (TCP/IP) Properties dialog box opens.
 - Configure network settings as appropriate for the control network as

implemented in your facility.

- Configure SNMP properties so the trap destination points to the NetCentral server PC. Use standard Windows procedures.
- If the K2 Media Client connects to the K2 Storage System with a redundant Ethernet fabric, such as in levels 2R and 3R, install Multi-Path I/O software. Refer to the next procedure “[Installing Multi-Path I/O Software](#)”.
- Copy the K2 Storage System *hosts* file onto the K2 Media Client. Refer to the *K2 Storage System Instruction Manual* for information about the *hosts* file and networking.

Installing Multi-Path I/O Software

The following procedure is required for external storage K2 Media Clients that have both Gigabit Media ports (ports 2 and 4) connected to the iSCSI Media network. Typically, this configuration is used for redundant K2 Storage Systems, such as Level 2R and Level 3R.

The installation files for the Multi-Path I/O software are copied on to the K2 Media Client when the K2 Client software is installed.

To install Multi-Path I/O software, do the following:

1. If you have not already done so, connect keyboard, monitor, and mouse to the K2 Media Client and log on to Windows.
2. Stop all media access. If AppCenter is open, close it.
3. Click **Start | Run**, type `cmd` and press **Enter**. The MS-DOS command prompt window opens.
4. From the command prompt, navigate to the `C:\profile\mpio` directory.
5. Type the following at the command prompt:
`C:\profile\mpio>gdsminstall.exe -i c:\profile\mpio gdsm.inf Root\GDSM`
6. Press **Enter**. The software is installed. The command prompt window reports the following:

```
Pre-Installing the Multi-Path Adapter Filter...
```

```
Success
```

```
Installing the Multi-Path Bus Driver...
```

```
Success
```

```
Installing the Device Specific Module...
```

```
Success
```

```
Installing the Multi-Path Device Driver...
```

```
Success (but need a reboot)
```

- Restart the K2 Media Client.
- After restart, to verify that the software is installed, on the Windows desktop right-click **My Computer** and select **Manage**. The Computer Management window opens.

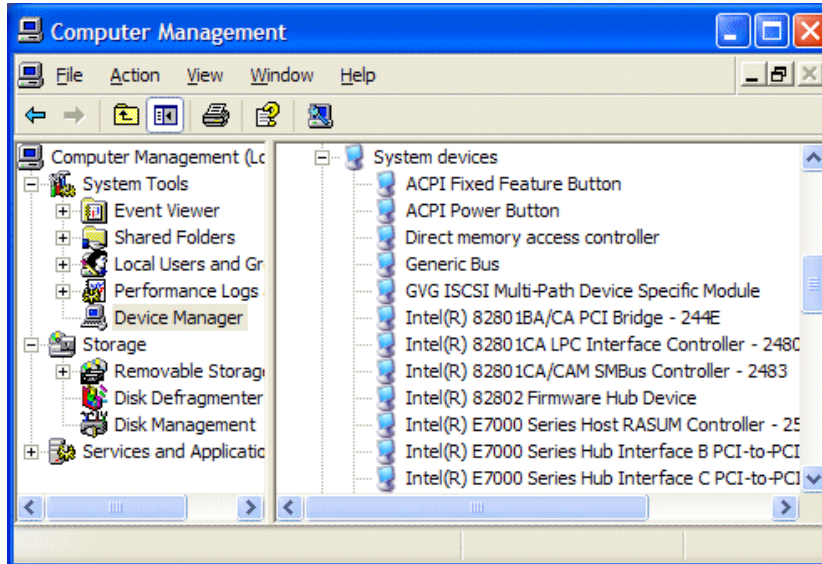

- In the left pane select **Device Manager**.
- In the right pane open the **System devices** node and verify that **GVG ISCSI Multi-Path Device Specific Module** is listed.

Adding K2 Media Clients

For each of your K2 Media Clients, use the procedures in this section to configure for operation using the K2 Storage System as the shared media storage.

Before beginning with these procedures, make sure the K2 Storage System and the K2 Media Clients are prepared as specified in the sections earlier in this chapter. Cabling must be complete, K2 Media Clients must be communicating on the control network, and the K2 Storage System must have a viable media file system.

Configuring a K2 Media Client for the K2 Storage System

Configure a K2 Media Client as follows:

- On the K2 configuration control point PC, open the K2 System Configuration application. A login dialog box opens.

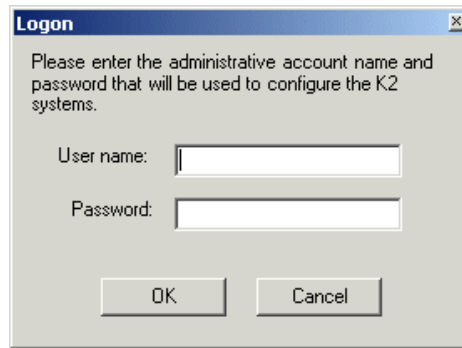

2. Log in to the K2 System Configuration application with the correct administrator account. By default this as follows:

- Username: administrator
- Password: adminK2

Refer to the security topic elsewhere in this manual for more information about administrator accounts and logging in to applications.

3. In the K2 System Configuration application tree view, verify that the K2 Storage System is correctly defined. You should see the correct number of K2 Media Clients. If the correct number of K2 Media Clients is not currently added to the K2 Storage System, you can add or remove clients now (before clients are configured), as follows:

- Select the top node of the storage system and click the **Add Device** button
- Select a unconfigured K2 Media Client and click the **Remove** button.

4. Select the top K2 Media Client. 

5. Click the **Configure** button.  The K2 Media Client Configuration wizard

opens. Follow the on-screen text as described in the following table.:

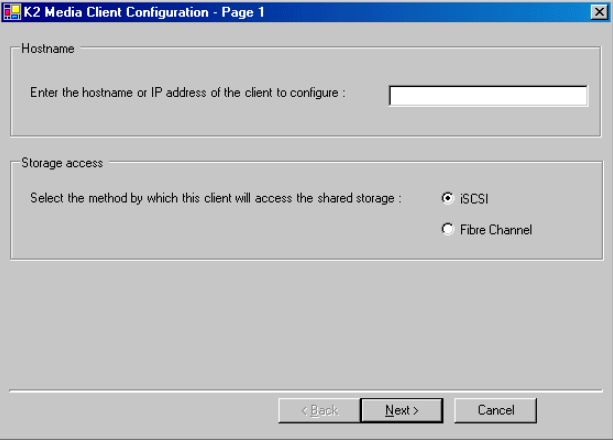
On this page...	Do this...
Page 1	
	<p>Enter the IP address or network name for a K2 Media Client, as currently configured on the K2 Media Client. You should configure your highest bandwidth K2 Media Clients first, as this ensures load balancing is correct. Refer to the load balancing topic earlier in this chapter for information on load balancing.</p> <p>For the Storage Access settings, leave iSCSI selected. Click Next</p>

Software Configuration

This page checks the K2 Media Client for required software.

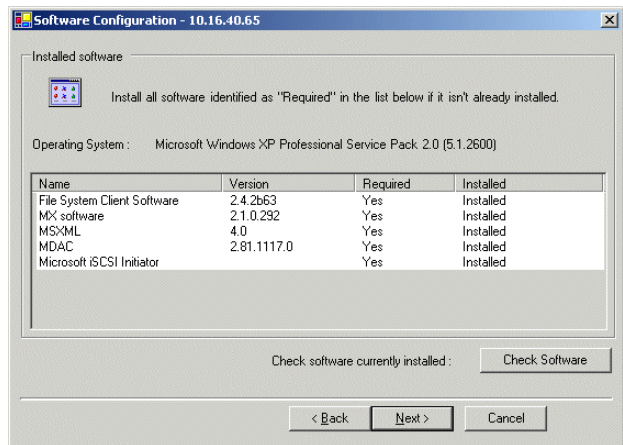

If software with *Yes* in the Required column reports as *Not Installed*, you must first install it on the K2 Media Client before continuing. Refer to [Chapter 5, “Managing K2 client system software”](#). After installing the software, click **Check Software**. When all required software reports as *Installed*, click **Next**.

On this page...

Do this...

Network Configuration

This page configures the Ethernet ports for both the control network and the media network. The K2 Media Client actually has four Gigabit Ethernet ports, but they are configured as two teamed pairs. Each teamed pair shares an IP address and appears on this page as a single port.

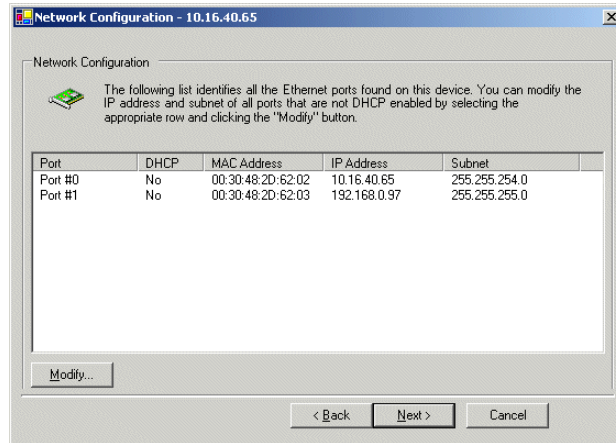

The top port is the port over which the K2 System Configuration application is communicating with the K2 Media Client. If correctly configured, it is already assigned the control network IP address, which is displayed in the window.

Select the other port and click **Modify**. A network configuration dialog box opens. Enter the media network IP address and the subnet mask. Click **Next**.

Database Client Configuration

This page connects the K2 Media Client as a media database client to the K2 Media Server taking the role of media database server. If there are redundant K2 Media Servers, both are listed on this page as database servers.

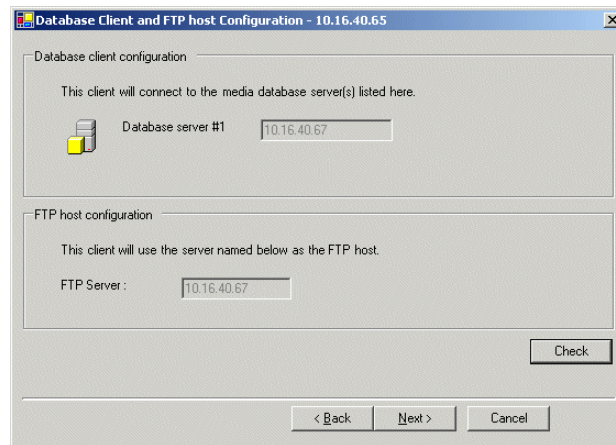

Verify that the K2 Media Client is connecting to the correct K2 Media Server or Servers, as follows:

- For Level 1, the client connects to the L1 RAID storage device.
- For Level 2, the client connects to the only server.
- For Level 2R, the client connects to server A as database server 1 and sever B as database server 2.
- For Level 3, the client connects to server 1.
- For Level 3R, the client connects to server 1A as database server 1 and sever 1B as database server 2.

Refer to the *K2 Storage System Instruction Manual* to identify servers. If there are multiple FTP servers, the K2 System Configuration application automatically assigns the K2 Media Client to a FTP server to provide optimum FTP bandwidth across the system.

Click **Check**. When the wizard reports that the configuration check is successful, click **Next**.

On this page...

File System Client Configuration

This page connects the K2 Media Client as a media file system client to the K2 Media Server taking the role of media file system server. If there are redundant K2 Media Servers, both are listed on this page as file system servers.

Do this...

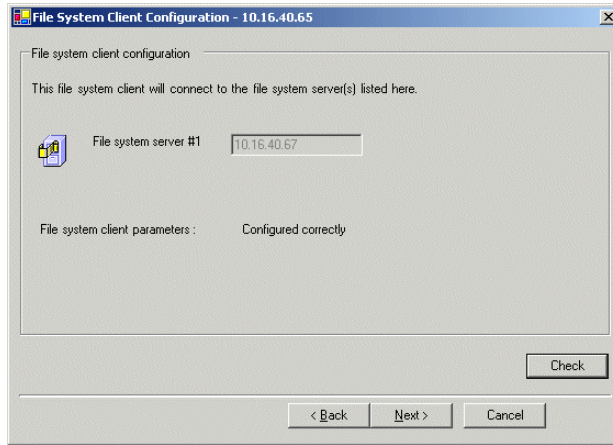

Verify that the K2 Media Client is connecting to the correct K2 Media Server or Servers, as follows:

- For Level 1, the client connects to the L1 RAID storage device.
- For Level 2, the client connects to the only server.
- For Level 2R, the client connects to server A as file system server 1 and server B as file system server 2.
- For Level 3, the client connects to server 1.
- For Level 3R, the client connects to server 1A as file system server 1 and server 1B as file system server 2.

Refer to the *K2 Storage System Instruction Manual* to identify servers. Click **Check**. When the wizard reports that the configuration check is successful, click **Next**.

On this page...

iSCSI Initiator Configuration

This page load balances the K2 Media Client's iSCSI connection to the K2 Storage System. The iSCSI adapters on your K2 Media Server or servers are listed here as iSCSI targets. The K2 System Configuration application determines the iSCSI target to which each K2 Media Client subscribes, based on the bandwidth values that you enter. This enforces policies by which each K2 Media Client has sufficient bandwidth for its intended use and no individual iSCSI target is oversubscribed.

Do this...

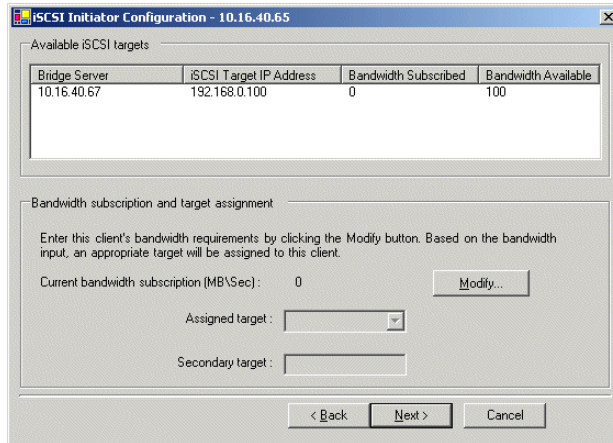

Click **Modify**. The Bandwidth Input dialog box opens.

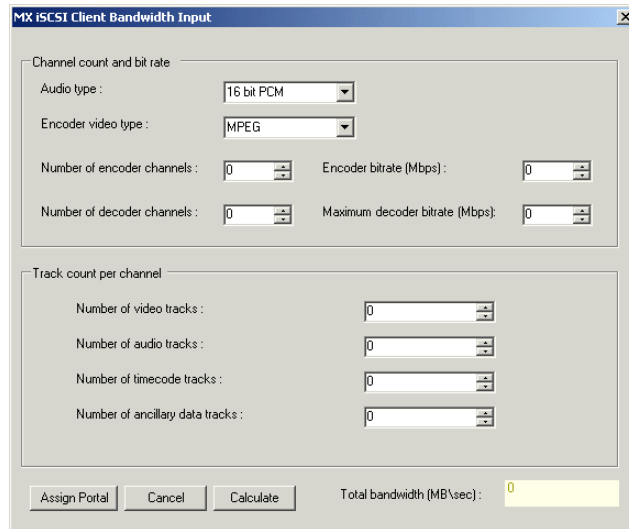

Enter the channel count, bit rate, and track count per channel information according to your intended use of the K2 Media Client.

Click **Calculate** and verify that the total bandwidth is correct according to the system design for your shared storage system. You should be configuring your highest bandwidth K2 Media Clients first, to ensure that they are distributed equally across iSCSI targets. To verify this, while you are on this page for your first K2 Media Client, you can temporarily enter information and calculate the bandwidth for each of your K2 Media Clients and compare bandwidth values.

Click **Assign Portal**, then **OK** to confirm.

If you have a redundant K2 Storage System, the K2 System Configuration application makes the appropriate assignment to the redundant server, as reported in the Secondary target box.

Click **Next**.

Completing the Configuration Wizard

Click **Finish**. The K2 Media Client restarts and the wizard closes.

6. Repeat this procedure for each of your K2 Media Clients.

Basic operations for external storage K2 Media Clients

Use the following procedures as you operate your K2 Media Clients with the K2 Storage System:

- “Power on/off procedures”
- “Taking a K2 Media Client offline”

For other procedures refer to “Administering and maintaining the K2 system” on page 79 and the *K2 Storage System Instruction Manual*.

Power on/off procedures

As long as the K2 Storage System remains operational, you can use the standard power on and power off procedures for K2 Media Clients attached to the K2 Storage System. When a K2 Media Client goes offline or comes online it does not disrupt the K2 Storage System.

However, if you are powering down or otherwise taking the K2 Storage System out of service, you must follow the correct procedure as specified in the *K2 Storage System Instruction Manual*. You must first stop all media access on your K2 Media Clients to ensure that they do not cause error conditions. You can power off the K2 Media Clients or take them offline using the K2 System Configuration application.

When powering up the K2 Storage System, power on the K2 Media Clients last so that they can verify their media storage as part of their start up processes.

Taking a K2 Media Client offline

1. Stop all media operations on the device. This includes, play, record, and transfer operations.
2. Open the K2 System Configuration application on the control point PC.
3. In the K2 System Configuration application’s tree view, select a K2 Media Client and then click the **Take Offline** button.
4. After you have completed your service work on the device, similarly select the K2 Media Client and then click the **Bring online** button.

Appendix **A**

Specifications

Specifications in this chapter:

- “AC power specification”
- “Environmental specifications”
- “Mechanical specifications”
- “Electrical specifications”
- “Operational specifications”
- “Control point PC system requirements”

AC power specification

The K2 Media Client AC power specification is shown in the following table.

Characteristic	Specification
Power supply	Dual, redundant
Mains Input Voltage	100V to 240V auto-range, 50-60Hz
Power consumption	300W typical, 500W maximum



WARNING: Always use a grounded outlet to supply power to the system. Always use a power cable with a grounded plug, such as the one supplied with the system.

Environmental specifications

Characteristic	Specification
Ambient Temperature Non-Operating	-40° to +60° C
Ambient Temperature Operating	10° to +40° C
Relative Humidity	Operating 20% to 80% from -5 to +45 C Non-Operating 10% to 80% from -30 to +60 C Do not operate with visible moisture on the circuit boards
Operating Altitude	To 10,000 feet IEC 950 compliant to 2000 meters
Storage Altitude	To 40,000 feet
Non-Operating Mechanical Shock	Class 5 (30G) Thomson Grass Valley 001131500
Random Vibration	Operational: Class 6 Thomson Grass Valley 001131500 Non-Operational: Class 5 Thomson Grass Valley 001131500
Transportation	Thomson Grass Valley 001131500
Equipment Type	Information Technology
Equipment Class	Class 1
Installation Category	Category II Local level mains, appliances, portable equipment, etc.
Pollution Degree	Level 2 operating environment, indoor use only.

Mechanical specifications

Dimension	Measurement
Height	7 in (177 mm)
Width	17.75 in (450 mm)
Depth ^a	25.75 in (654 mm)
Weight:	69.5 lbs (31.5 kg) maximum

^a Adjustable rack-mounting ears accommodate different rack depth limitations.

Electrical specifications

The following sections describe the electrical specifications:

Serial Digital Video (SDI)

Parameter	Specification
Video Standard	525 Line or 625 Line component
Number of Inputs	1 per record channel
Number of Outputs	1 per play channel
Data format	Conforms to SMPTE 259M (SD) and 292M (HD)
Number of bits	10bits
Embedded Audio Input	SD data format conforms to SMPTE 259M (48kHz, 20bits) HD data format conforms to SMPTE 299. 48 kHz (locked to video) and 16- or 24- bit PCM Compatible with AC-3 and Dolby-E User selectable audio group 1- 4
Embedded Audio Output	Output data format is 48 kHz 24-bit User can disable embedded audio on SDI output
Connector	BNC, 75 ohm, No loop-through
Max Cable Length	225 meters (738 ft) (Belden 8281 type cable)
Return Loss	≥15db, 5Mhz to 270Mhz

Genlock Reference

Characteristic	Description
Signal Type	NTSC/PAL Color Black Composite Analog
Connectors	2 BNC, 75 ohm passive loop through
Burst Frequency Lock Range	PAL, ± 10 Hz at subcarrier NTSC, ± 20 Hz at subcarrier
Signal Amplitude Lock Range	Stays locked to +6 dB and -3 dB
Input Return Loss	≥ 40 dB to 5 MHz

System Timing

Characteristic	Description ^a
Encoder timing	Derived from the video input
Nominal Playback Output Delay	Adjustable (Default: Zero timed to reference genlock)
SD Output Delay Range (Independent for each play channel)	525 lines Frames: 0 to +1 Lines: 0 to +524 Samples: 0 to +1715 clock samples
	625 lines Frames: 0 to +3 Lines: 0 to +624 Samples: 0 to +1727 clock samples
HD Output Delay Range (Independent for each play channel)	1080i at 29.97 FPS (SMPTE 274M-5) Frames: 0 to +1 Lines: 0 to +1124 Pixels: 0 to +2199
	720p at 59.94 FPS (SMPTE 296M-2) Frames: 0 to +1 Lines: 0 to +749 Pixels: 0 to +1649
	1080i at 25 FPS (SMPTE 274M-6) Frames: 0 to +1 Lines: 0 to +1124 Pixels: 0 to +2639
	720p at 50 FPS (SMPTE 296M-3) Frames: 0 to +1 Lines: 0 to +749 Pixels: 0 to +1979
Loop through	On SD-only models, the video, AES, and LTC inputs pass to the their output connectors as loop through. This is on record channels only.
	On HD/SD models there is no loop through of any type
E-to-E video	Not supported

^a All delay values shown are relative to Black Reference.

AES/EBU Digital Audio

Parameter	Specification
Standard	AES3
Audio Inputs	4 Channels per video input; 2 dedicated BNC connectors per video input; two channels per BNC connector 8 Channels of embedded audio from video input. Supports 48kHz, 16 bit, 20 bit, or 24 bit digital audio sources.
Audio Outputs	4 Channels per video output; 2 dedicated BNC connectors per video output; two channels per BNC connector 8 Channels of embedded per video output. Audio mapping is direct and fixed, the first four channels are the same for AES and embedded, the last four channels are only embedded. AES outputs are active at all times; embedded audio insertion on outputs can be disabled. Audio is output using a 48kHz clock derived from the video reference. Supports 16- or 24-bit media. On playout, audio is synchronized with video as it was recorded.
Input Impedance	75 ohms, unbalanced
Audio shift	Configurable relative to the incoming video on record or playout.

LTC Input/Output

Parameter	Specification
Standard	SMPTE 12M Longitudinal Time Code, AC coupled, differential input
Number of Inputs	1 per video input - Female XLR
Number of Outputs	1 per video output - Male XLR
Input Impedance	1K ohm
Output Impedance	50 ohm
Minimum Input Voltage	0.1 V peak-to-peak, differential
Maximum Input Voltage	2.5 V peak-to-peak, differential
Nominal Output Voltage	2.0 V peak-to-peak differential.
LTC Reader	LTC reader will accept LTC at rates between 1/30 and 80 times the nominal rate in either forward or reverse directions.
LTC Transmitter	LTC transmitter outputs LTC at the nominal frame rate for the selected standard at 1x speed, forward direction only.

VITC Input/Output

Parameter	Specification
VITC	lines 10-20 NTSC (525 Line); lines 10-22 PAL (625 Line) VITC is decoded on each SDI input and inserted on each SDI output. VITC Reader configurable for a search window (specified by two lines) or set to manual mode (based on two specified lines). VITC Writer inserts VITC data on two selectable lines per field in the vertical interval. The two lines have the same data. VITC is not decoded off of the video reference input.

RS-422 specification

The RS-422 interface conforms to ANSI/SMPTE 207M-1997 standard (SMPTE 422).

GPI I/O specifications

Characteristic	Description
Number of Inputs/Outputs	12 inputs and 12 outputs.
Connector type	25pin D
GPI Input	TTL 0-0.8 V Low; 2.4-5 V High; 1 mA external current sink
GPI Output	Max Sink Current: 100 ma; Max Voltage: 30 V Outputs are open drain drivers. Max. voltage when outputs are open = 45V Max. current when outputs are closed = 250ma Typical risetimes approximately 625ns Typical falltimes approximately 400ns

Operational specifications

Topics include:

- “Video codec description – SD-only models” on page 105
- “Video codec description – HD/SD models” on page 105
- “Playout of multiple formats” on page 106
- “VBI/Ancillary data specifications” on page 109
- “Internationalization” on page 114
- “Video network performance” on page 114
- “Supported file input/output formats” on page 115
- “Media file system performance” on page 116
- “Protocols supported” on page 116
- “Transfer compatibility considerations” on page 116

Video codec description – SD-only models

Format	Sampling	Frame Rate	Data Rate	Other
DVCPRO25 (720X480/576)	4:1:1	29.97, 25	3.6 MBps	—
DVCPRO50 ^a (720X487.5/585)	4:2:2	29.97, 25	7.2 MBps	—
DVCAM (720X480/576)	4:1:1/ 4:2:0	29.97, 25	3.6 MBps	—
MPEG-2 (720X480/576)	4:2:0	29.97, 25	2-15 Mbps	I-frame and long GoP
MPEG-2 (720X480/576)	4:2:2	29.97, 25	4-50 Mbps	I-frame and long GoP
MPEG-2 (720X512/608)	4:2:2	29.97, 25	4-50 Mbps	I-frame and long GoP
D10/IMX ^a (720X512/608)	4:2:2	29.97, 25	30, 40, 50 Mbps	I-frame only

^aDVCPRO50 / D10/IMX operation is a licensable option.

Video codec description – HD/SD models

Format	Sampling	Frame Rate	Data Rate	GoP
SD formats				
MPEG-2 (720X480/576)	4:2:0	29.97, 25	2-15 Mbps	I-frame and long GoP
MPEG-2 (720X480/576)	4:2:2	29.97, 25	4-50 Mbps	I-frame and long GoP
MPEG-2 (720X512/608)	4:2:2	29.97, 25	4-50 Mbps	I-frame and long GoP
HD formats ^a				
MPEG-2 (1920x1080)	4:2:0	29.97, 25	20-80 Mbps	I-frame and long GoP ^b
MPEG-2 (1920x1080)	4:2:2	29.97, 25	20-100 Mbps	I-frame and long GoP
MPEG-2 (1280x720)	4:2:0	59.94, 50	12-80 Mbps	I-frame and long GoP
MPEG-2 (1280x720)	4:2:2	59.94, 50	20-100 Mbps	I-frame and long GoP

^aLow bitrate I-frame encoding is not recommended

^bDecode of lower bit rate is possible

Playback of multiple formats

The K2 Media Client automatically handles material of various types and formats as specified in the following sections:

Playback on SD-only models

On SD-only models, for a given frame rate, you can play clips of any format back-to-back on the same timeline. Refer to table “[Video codec description – SD-only models](#)” earlier in this chapter for a list of the supported formats.

On SD-only models, both 16:9 and 4:3 resolution formats can be played on the same timeline. Refer to “[Aspect ratio conversions](#)” on page 108.

Both SD-only and HD/SD models support mixed clips with uncompressed and compressed (Dolby-E) audio on the same timeline. (requires external Dolby-E decoder).

Refer to “[VBI/Ancillary data specifications](#)” on page 109 for specifications on how SD-only models handle VBI data and ancillary data.

Playback on HD/SD models

On HD/SD models, for similar frame rates (25/50 fps or 29.97/59.95 fps), MPEG SD material transferred or recorded into the K2 Media Client along with its audio is up-converted when played on a HD output channel. Likewise, HD material is down-converted along with its audio when played on SD output channel. HD and SD clips can be played back-to-back on the same timeline, and aspect ratio conversion is user configurable. Refer to “[Aspect ratio conversions](#)” on page 108. Refer to the following tables for specifications on SD and HD conversions.

Refer to “[VBI/Ancillary data specifications](#)” on page 109 for specifications on how HD/SD models handle VBI data.





25/50 fps conversions on HD/SD models



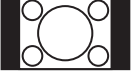

		Converted SD format	Converted HD formats		
		625 at 25 fps	1080i at 25 fps	720p at 50 fps	
Source	SD format	625 at 25 fps	No conversion	Up-convert SD to HD	Up-convert SD to HD
	HD formats	1080i at 25 fps	Down-convert HD to SD	No conversion	Cross-convert from 1080i to 720p
720p at 50 fps		Down-convert HD to SD	Convert HD to HD	No conversion	

29.97/59.95 fps conversions on HD/SD models

		Converted SD format	Converted HD formats	
		525 at 29.97 fps	1080i at 29.97 fps	720p at 59.94 fps
Source SD format	525 at 29.97 fps	No conversion	Up-convert SD to HD	Up-convert SD to HD
	1080i at 29.97 fps	Down-convert HD to SD	No conversion	Convert HD to HD
Source HD formats	720p at 59.94 fps	Down-convert HD to SD	Convert HD to HD	No conversion

Aspect ratio conversions

Source aspect ratio	Source image	Conversion option	Conversion description	Converted aspect ratio	Converted image
4:3		Bar	The 4:3 aspect ratio is maintained, centered on the screen, with black bars filling the left and right portions of the 16:9 display.	16:9	
		Half Bar	The picture aspect ratio is maintained, but the image is slightly enlarged. The top and bottom of the image are slightly cropped, and thin black bars fill the left and right portions of the 16:9 display.	16:9	
		Crop	The picture aspect ratio is maintained, but the image is enlarged so that it horizontally fills the HD display. The top and bottom of the 4:3 SD image are cropped to fit in the 16:9 display.	16:9	
		Stretch	The picture aspect ratio is distorted. The image fills the screen vertically without cropping, and is stretched horizontally to fill the 16:9 display. This conversion up-converts Full Height Anamorphic (FHA) 16:9 SD material.	16:9	

Source aspect ratio	Source image	Conversion option	Conversion description	Converted aspect ratio	Converted image
16:9		Bar	The 16:9 aspect ratio is maintained, centered on the screen, with black bars filling the top and bottom portions of the 4:3 display.	4:3	
		Half Bar	The picture aspect ratio is maintained, but the image is slightly enlarged. The left and right sides the image are slightly cropped, and thin black bars fill the top and bottom portions of the 4:3 display.	4:3	
		Crop	The picture aspect ratio is maintained, but the image is enlarged so that it vertically fills the SD display. The left and right sides of the 16:9 HD image are cropped to fit in the 4:3 SD display	4:3	
		Stretch	The picture aspect ratio is distorted. The image fills the screen horizontally without cropping, and is stretched vertically to fill the 4:3 display. This conversion generates Full Height Anamorphic (FHA) 16:9 SD material.	4:3	

VBI/Ancillary data specifications

The K2 Media Client supports SD Vertical Blanking Interval (VBI) data and HD Ancillary (Anc) data as specified in the following sections:

VBI data support on SD-only models

Video format	Compressed VBI	Uncompressed VBI	Closed Captioning	Comments
DVCPRO25 525 line (NTSC)	Not supported	Not supported by DVCPRO25 format	Supported, as native to DVCPRO25. VCHIP data supported.	—
DVCPRO25 625 line (PAL)	Not supported	Not supported by DVCPRO25 format	Not supported. Teletext not supported	
DVCPRO50 525 line (NTSC)	Supported	Not supported by DVCPRO50 format	Supported, as native to DVCPRO50 (compressed VBI). VCHIP data supported.	DVCPRO50 is a licensable option.
DVCPRO50 625 line (PAL)	Supported	Not supported by DVCPRO50 format	Closed Captioning not supported. Teletext supported, as native to DVCPRO50 (compressed VBI).	
DVCAM 525 line (NTSC)	Not supported	Not supported by DVCAM format	Supported, as native to DVCAM.	—
DVCAM 625 line (PAL)	Not supported	Not supported by DVCAM format	Closed captioning and teletext supported, as native to DVCAM.	—
MPEG-2 525 line (NTSC)	Supported as 16 lines per field. Range: 7–22	Supported. Six lines per field. User selectable. Range: 10–22 Selected lines are saved in MPEG user data space and restored on playout.	Supported and always on. Not selectable.	—
MPEG-2 625 line (PAL)	Supported as 16 selectable lines per field. Range: 7–22	Supported. Six lines per field. User selectable. Range: 6–22 Selected lines are saved in MPEG user data space and restored on playout.	Teletext not supported ^a	—
MPEG-D10 525 line (NTSC)	Supported	Not supported by D10 format.	Supported, as native to D10.	—
MPEG-D10 625 line (PAL)	Supported	Not supported by D10 format.	Closed captioning and teletext supported, as native to D10.	—

^a For 625/PAL, CC user data is disabled, so the only way to get Teletext is by either using Uncompressed VBI Line 21 (if an MPEG format), or Compressed VBI for the 625/PAL formats.

Only Luma VBI/Closed-captioning data is saved/encoded. Chroma VBI/

Closed-captioning data is ignored on playback.

Ancillary data is not supported on SD-only models, except as data bridging when material is transferred to or from a HD/SD model. Refer to [“Data bridging of native material on HD/SD models”](#) on page 112.

VBI data support on HD/SD models

Video format	Compressed VBI	Uncompressed VBI	Closed Captioning	Comments
SD MPEG-2 525 line (NTSC)	Supported for record. Not supported for playback.	Supported as six selectable lines per field. Range: 10–22 Selected lines are saved in MPEG user data space and restored on playout.	Supported and always on. Not selectable.	—
SD MPEG-2 625 line (PAL)	Supported for record. Not supported for playback.	Supported as six selectable lines per field. Range: 6–22 Selected lines are saved in MPEG user data space and restored on playout.	Teletext not supported ^a	—

^aTo pass through PAL MPEG-2 Teletext to playout, record it on VBI line 21, compressed or uncompressed.

Only Luma VBI/Closed-captioning data is saved/encoded. Chroma VBI/Closed-captioning data is ignored on playback.

Ancillary data support on HD/SD models

Video format	Data	Supported as follows:
HD MPEG-2	Vertical interval ancillary data packets	Extracted at input and stored on an ancillary data track. Upon playout, the data packets are inserted into the video stream on specified lines. Maximum 8 packets per field.

Luma ancillary data packets are stored. Chroma ancillary data packets are not supported. Both VANC and HANC packets are stored if they are luma packets.

Data bridging of native material on HD/SD models

When MPEG-2 material that was recorded on a HD/SD model is converted on a HD/SD model, data is bridged as follows:

Source format	Source data	Conversion →	Converted format	Converted data
SD 525 line	Closed-captioning (CC) on line 21 (EIA-608) can be stored as UserData CC packets ^a or UserData VBI Line21 (Uncompressed VBI Line21)	Up-convert	HD	Ancillary Closed Caption EIA-708-B packets
SD 625 line	Teletext on line 21	No up conversion to HD		
SD 625 line 525 line	Ancillary data	No up conversion to HD		
HD	EIA-708 & 608 Ancillary data packets	Down-convert	SD	Closed-captioning on line 21 (EIA-608 standard).
HD	Teletext	No down conversion to SD		
HD 1080i	Ancillary data	Cross-convert	HD 720p	Moved to valid lines
HD 720p	Ancillary data	Cross-convert	HD 1080i	Moved to valid lines. Any data on lines 21-25 is moved to line 20 on 1080i output.

^a UserData CC packets always on. If CC exists, it is recorded and played back.

HD/SD models data compatibility with PVS models

When material is transferred between a PVS Profile XP Media Platform and a K2 Media Client, SD VBI data and HD Ancillary data is supported as follows:

Source device	Source format	Source data	Destination device	Data support: SD Playout	Data support: HD Playout
PVS	SD MPEG-2	Any supported on PVS	SD-only K2 Media Client	All supported	NA
		Uncompressed VBI	HD/SD K2 Media Client	Yes	Yes, with data bridging for CC only. Other VBI lines are discarded.
		Closed captioning	HD/SD K2 Media Client	Yes	Yes. Ancillary data packets
		Compressed VBI	HD/SD K2 Media Client	No	No
		Ancillary data	HD/SD K2 Media Client	No	No
	HD MPEG-2	Ancillary data	HD/SD K2 Media Client	Yes	Yes
SD-only K2 Media Client	SD MPEG-2	Any supported on K2 Media Client	PVS	All supported	NA
HD/SD K2 Media Client	SD MPEG-2	Compressed VBI	PVS	Yes	No
		Uncompressed VBI	PVS	Yes	No
		Closed captioning	PVS	No	No
	HD MPEG-2	Ancillary data	PVS	Yes, with data bridging for ancillary CC packets only.	Yes

Internationalization

When you enable internationalization on a K2 Media Client, you can name your media assets in a local language. The K2 Media Client supports the local language name as specified in the following table:

System	Internationalization support
Media database	<ul style="list-style-type: none"> All external views of movie assets can be represented as wide-file names AppCenter runs in Unicode Only movie assets and searchable User Data keys are Unicode.
Media file system	<ul style="list-style-type: none"> Support for Kanji and wide-character file and folder names. File-folder representation of movie are internationalized, as well as the QuickTime reference file it contains. Key names (V:\PDR) remain unchanged, but are Unicode. Elementary streams remain as GUIDs, but are Unicode.
K2 Media Client applications	<ul style="list-style-type: none"> Movie assets are described in Unicode. Application user interfaces are Unicode compliant.
Protocols	<ul style="list-style-type: none"> AMP supports UTF8. Unicode movie names pass through as opaque bits. VDCP does not support UTF8. VDCP protocols are ASCII and VDCP protocol handler needs to convert movie names to Unicode.
FTP transfers	<ul style="list-style-type: none"> Large file-name supported only via UTF8. All FTP client/server commands are in English The named movie asset is in wide-characters

Video network performance

The K2 Media Client supports streaming transfers to and from K2 Media Clients, M-Series iVDRs, Profile XP Media Platforms, or any device that supports General Exchange Format (GXF) as described in SMPTE 360M.

Parameter	Specification	Comments
Transfer bandwidth per internal storage K2 Media Client	Up to 50 MBytes per second	—
Transfer bandwidth per Level 2 K2 Storage	50 MBytes per second	—
Transfer bandwidth per Level 3 K2 Storage	80 MBytes per second	Additional K2 Media Servers dedicated as FTP servers add 80 MBytes per second each
Maximum concurrent transfers per transfer engine	4	Additional transfers are queued.
Minimum delay from start of record to start of transfer	20 seconds	—
Minimum delay between start of transfer into destination and start of play on destination	20 seconds.	—

Supported file input/output formats

The K2 Media Client can send and receive files of various formats using import, export, and transfer mechanisms.

Formats supported are as follows:

Streaming file format	Video elementary format	Audio elementary format	Transfer Monitor		FTP		Other information
			Import	Export	Import	Export	
GXF	DV25/50 DVCAM MPEG-2	48 kHz, 16 bit or 24 bit PCM or Dolby digital (AC-3)	Yes	Yes	Yes	Yes	Support for complex movies of like format. GXF is the K2 Media Client's native file transfer format.
MXF	DV25/50 DVCAM MPEG-2	MPEG Layer II audio. 48 kHz, 16 bit or 24 bit PCM or Dolby digital (AC-3)	Yes	Yes	Yes	Yes	Simple movies only. Real time file transfer in and out with wrap/unwrap of MXF Op 1a on host platform with no external platform required. Standard Definition only. Preservation of metadata as defined in the Operating Pattern 1a level of MXF. HD Ancillary data is not supported as part of the MXF transfer.
AVI	DV25 DV50	48 kHz 16 bit stereo PCM	Yes	Yes	No	No	Limit of two audio tracks
Quicktime	DV25 DV50	48 kHz 16 bit stereo PCM	Yes	Yes	No	No	Limit of two audio tracks
WAV audio	NA	48 kHz 16 bit stereo PCM	Yes	No	No	No	Limit of two audio tracks
Still image formats: BMP JPEG TIFF	NA	NA	Yes	No	No	No	Still images can be used as clips on the timeline.

Media file system performance

Parameter	Internal Storage Specification	External Storage Specification
Maximum number of clips	20,000	50,000
Minimum delay between start record and start playout when record and play is on the same K2 Media Client	6 seconds	10 seconds
Minimum delay between start record and start playout when record and play is on different K2 Media Clients	NA	20 seconds
Maximum length continuous record	24 hours	24 hours

Protocols supported

The following protocols are supported for remote control of the K2 Media Client:

Protocol	Support
AMP	Commands are available via Ethernet or RS-422 serial ports. Ethernet access is possible using DCOM as well as the socket interface to the AMP server. The AMP's socket interface uses IANA assigned port number 3811 for both TCP and UDP.
VDCP	VDCP preroll: 10 frames for command latency or buffer precharge The Protocol Recorder allows a default bin to be assigned to each record channel. The following categories of commands are not supported 1: <ol style="list-style-type: none"> 1. Deferred (Timeline) Commands --these are the basic timeline commands but use the time specified by the PRESET STANDARD TIME 2. Macro commands 3. Archive Commands
BVW	A subset of BVW commands is supported through the Protocol player. Insert/Edit is not supported.

Transfer compatibility considerations

When transferring material between a K2 Media Client and other Grass Valley products, you must consider the specifications of the different products. The following table illustrates some of these considerations:

Source device	Destination device	Material transferred	Compatibility
K2 Media Client	Profile XP Media Platform	HD 4:2:0, 80 Mb or less	Supported. Can be played out.
K2 Media Client	Profile XP Media Platform	HD 4:2:2	Supported for storage on the only. Transfer is successful but HD 4:2:2 is not supported for playout.

Source device	Destination device	Material transferred	Compatibility
K2 Media Client	M-Series iVDR	1080i	Not supported.
Profile XP Media Platform	K2 Media Client	Any type supported except Ancillary data in SD.	The Profile XP must have system software 5.4.7 or higher in order for the material on the Profile XP to be visible (via Browse) from the K2 Media Client. Otherwise, you must enter an explicit path to the material and add the remote host in Configuration Manager before the transfer. Machine names must be entered in compliance with UIM naming conventions.

Control point PC system requirements

If you are building your own control point PC, the machine you chose must meet the following requirements. These requirements assume that the PC is dedicated to its function as the control point for the K2 Media Client and that no other applications run on the PC that could interfere with system performance.

Control point PC system requirements are as follows:

Requirements	Comments
Operating System	Microsoft Windows XP Professional, Service Pack 2
RAM	Minimum 512 MB, 1 GB recommended
Graphics acceleration	Must have at least 128 MB memory
Processor	Pentium 4 or higher class, 2 GHz or greater
Hard disk space	400 MB
Microsoft .NET Framework	Version 1.1
Java JRE	1.3.1_12 and 1.4.2_05 Required for the HP Ethernet Switch configuration interface, which is used for K2 Storage Systems (external storage).

Appendix **B**

Connector Pin-outs

This appendix contains the following topics:

- [“Rear panel connector pin-outs”](#)

Rear panel connector pin-outs

The following sections describe K2 client system rear panel connector pinouts.

RS-422 connector pinouts

The RS-422 interface conforms to ANSI/SMPTE 207M-1997 standard (SMPTE 422).

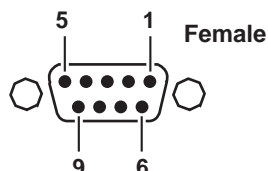

Pin #	Signal	Description
1	GND	Frame Ground
2	-TXD	Differential Transmit Data (low)
3	+RXD	Differential Receive Data (high)
4	GND	Transmit Signal Common
5	NC	Spare
6	GND	Receive Signal Common
7	+TXD	Differential Transmit Data (high)
8	-RXD	Differential Receive Data (low)
9	GND	Signal Ground

LTC connectors pinouts

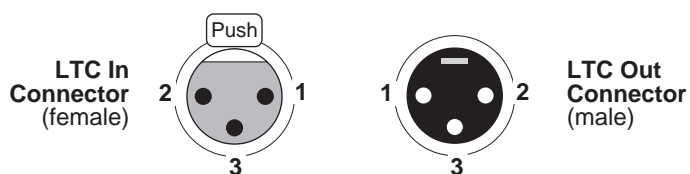

Pin #	LTC In	Pin #	LTC Out
1	Signal Ground	1	Signal Ground
2	(+)	2	(+)
3	(-)	3	(-)

GPI I/O connector pinouts

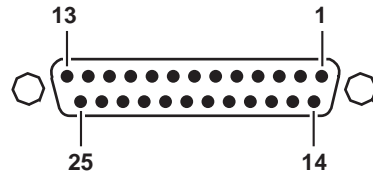

Pin	Signal	Pin	Signal
1	Output 1	14	Input 1
2	Output 2	15	Input 2
3	Output 3	16	Input 3
4	Output 4	17	Input 4
5	Output 5	18	Input 5
6	Output 6	19	Input 6
7	Output 7	20	Input 7
8	Output 8	21	Input 8
9	Output 9	22	Input 9
10	Output 10	23	Input 10
11	Output 11	24	Input 11
12	Output 12	25	Input 12
13	Ground		

Rack-mounting

Rack-mount considerations

When planning the placement of equipment in your equipment rack, bear in mind the following:

- Insure adequate air flow around the chassis to provide sufficient cooling. Operating ambient temperature will affect the amount of air circulation required to keep the K2 client system within its temperature limitations. See [“Environmental specifications” on page 130](#) for details.
- If the system is installed with its ventilation intakes near another system's exhaust or in a closed or multi-unit rack assembly, the operating ambient temperature inside the chassis may be greater than the room's ambient temperature. Install the system in an environment compatible with this recommended maximum ambient temperature.
- Ensure the rack is anchored to the floor so that it cannot tip over when the K2 client system is extended out of the rack.
- Be sure to mount the K2 client system in a way that ensures even weight distribution in the rack. Uneven mechanical loading can result in a hazardous condition. Secure all mounting bolts when installing the chassis to the rack.

The following sections describe installing the K2 Media Client step-by-step.

Rack mount hardware shipped with the K2 client system

Your K2 client system rack-mount kit comes with rack mounting hardware as shown.

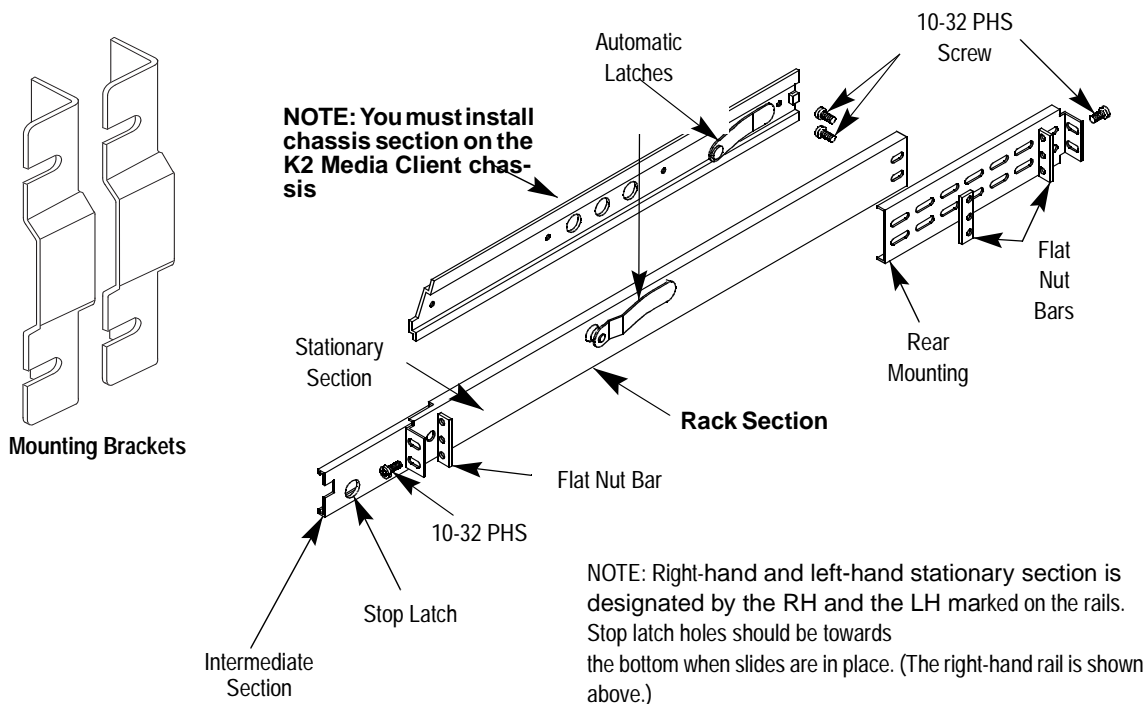

Mounting the Rack Slides

Choose the proper set of rail mounting holes on the rack. Notice that the hole spacing can vary with the rack type. When mounting the slides in racks with EIA spacing, make sure that the slides are attached to the 0.5-inch spaced holes.

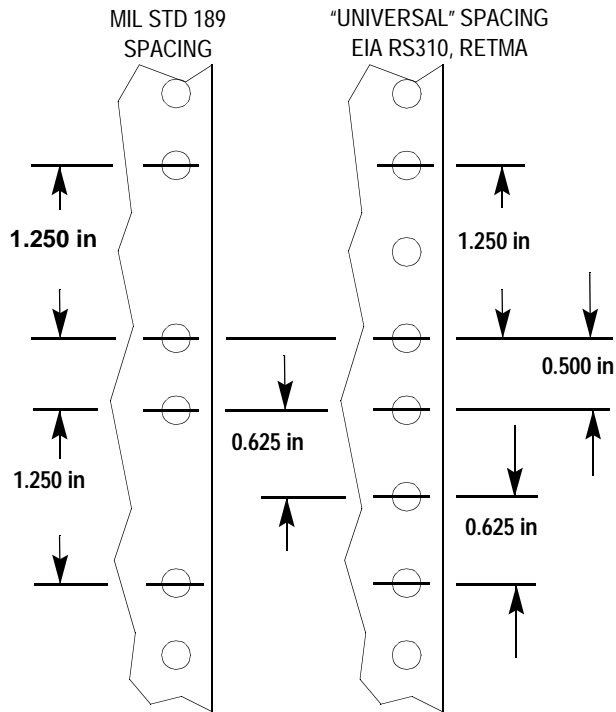

Front and rear rack rail mounting hardware is provided with the rack mount kit. Mount the rails using the enclosed hardware. Make sure the stationary sections are horizontally aligned and are level, as well as parallel to each other.

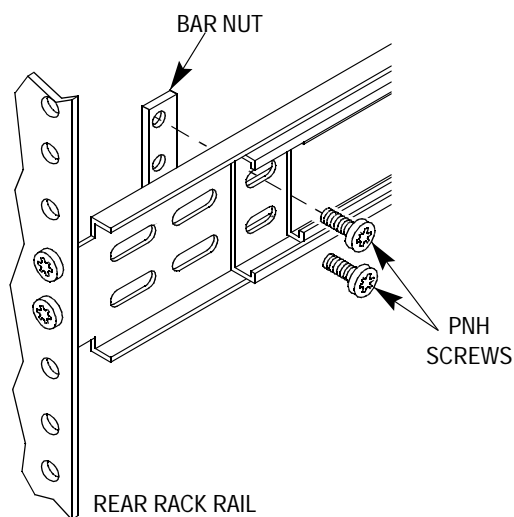
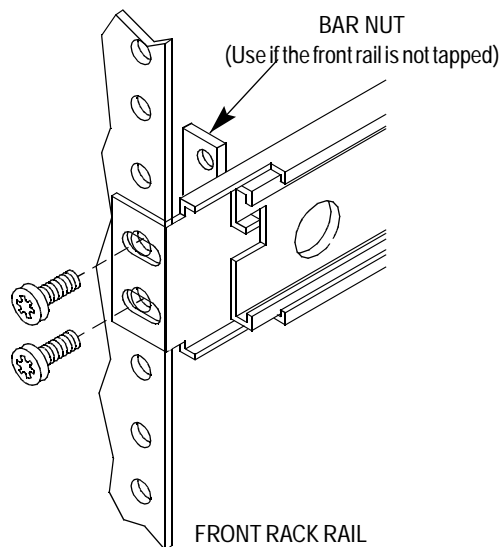

Installing the K2 client system on the rack mount rails

To install the K2 client system on the rack mount rails:

1. Pull the slide-out track section to the fully extended position.



WARNING: To prevent injury, two people are required to lift the K2 client system. It is too heavy for one person to install in the rack.



WARNING: To prevent serious injury, insure that the rack is anchored to the floor so that it cannot tip over when the K2 client system is extended out of the rack.

2. Insert the ends of the chassis sections into the slide-out sections.
3. Push the chassis toward the rack until the chassis sections lock into the intermediate sections.
4. Press the stop latches in the intermediate sections and push the chassis toward the rack until the latches snap into their holes.

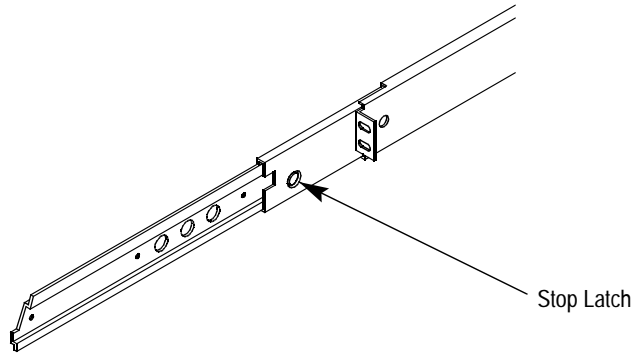

5. Again, press the stop latches and push the cabinet fully into the rack.
6. Insert and tighten the front panel retaining screws.

Making Rack Slide Adjustments

After installation, binding may occur if the slide tracks are not properly adjusted. To adjust the tracks:

1. Slide the chassis out approximately 10 inches.
2. Slightly loosen the mounting screws holding the tracks to the front of the rails and allow the tracks to seek an unbound position.
3. Tighten the mounting screws and check the tracks for smooth operation by sliding the chassis in and out of the rack several times.
4. Tighten the front panel retaining screws once the cabinet is in place within the rack to complete the installation.

Index

A

- AES/EBU audio
 - specification 102
- AMP TCP interface 56
- application system
 - architecture 32
 - software 33
- art 75, 76
- ATX 32
- audio
 - digital audio specification 102

B

- battery replacement 8
- board map 35

C

- certifications and compliances 9
- closed captioning 109
- codec board 32
- configuration
 - loading defaults 38
 - opening 37
 - saving and restoring 37
- configuration file 40
- Configuration Manager 37
- connector pin-outs
 - GPI 121
 - LTC connector 120
 - RS-422 120
- Control point PC system requirements 117

D

- database
 - description 33
- disk firmware
 - downloading, PFR700 70

E

- electric shock, avoiding 7
- emission limits, certifications 9

F

- file system

- description 33
- fire hazard, avoiding 7

G

- GPI
 - connector pinout 121
 - electrical specification 103
- grounding, safety 7

H

- host names, adding 51

I

- injury precautions 7

K

- K2 System Configuration 38

L

- LTC connector 120

M

- mechanical specifications 99
- media disk drive
 - naming 63
- media file system
 - checking 68
 - description 33
- Multi-Path I/O software 89

N

- NetCentral 41
- network
 - 100BaseT, setup 45
 - cabling, connecting for external, shared storage 45
 - cabling, connecting for internal storage 44
 - host file, setup 49
 - host names, adding 51
- network settings
 - Control Team 88

P

- PFR 700
 - downloading disk firmware 70
- power cords, certification 9
- product damage precautions 7
- Protocols
 - AMP TCP interface 56

R

- rack-mounting
 - rack slide adjustments 127
- Real Time Processor (RTP) 32
- real time system
 - components 32
 - description 34
- RS-422
 - connector pinout 120
 - rear panel connections 55
- RS422 32
- RS-422 ports 35

S

- safety
 - certification 11
 - grounding 7
 - summary 7
 - terms and symbols 8
- service safety summary 9
- slot map 35
- specification
 - AC Power 98
 - electrical 99
 - mechanical 99
- storage system, description 34
- Storage Utility 39, 40
- stripe group
 - description 59
- support, Grass Valley 16
- synchronizing the media file system 69

V

- V drive 34, 59
- VBI compression 109
- VBI Line 21 data services 109
- ventilation 7

W

- web site, for Thomson Grass Valley 15
- Windows
 - system description 32

X

- XLR Board 32
- XML 37