

System Guide

software release **4.0**

071-0624-04
JULY 2001

PROFILE XP PVS Series
MEDIA PLATFORM

Copyright

Copyright © 2001 Grass Valley Group Inc. All rights reserved. Printed in the United States of America.

This document may not be copied in whole or in part, or otherwise reproduced except as specifically permitted under U.S. copyright law, without the prior written consent of Grass Valley Group Inc., P.O. Box 59900, Nevada City,

Trademarks

California 95959-7900 Grass Valley, GRASS VALLEY GROUP, Profile and Profile XP are either registered trademarks or trademarks of Grass Valley Group in the United States and/or other countries. Other trademarks used in this document are either registered trademarks or trademarks of the manufacturers or vendors of the associated products. Grass Valley Group products are covered by U.S. and foreign patents, issued and pending. Additional information regarding

Grass Valley Group's trademarks and other proprietary rights may be found at www.grassvalleygroup.com.

Disclaimer

Product options and specifications subject to change without notice. The information in this manual is furnished for informational use only, is subject to change without notice, and should not be construed as a commitment by Grass Valley Group. Grass Valley Group assumes no responsibility or liability for any errors or inaccuracies that may appear in this publication.

**U.S. Government
Restricted Rights
Legend**

Use, duplication, or disclosure by the United States Government is subject to restrictions as set forth in subparagraph (c)(1)(ii) of the Rights in Technical Data and Computer Software clause at DFARS 252.277-7013 or in subparagraph c(1) and (2) of the Commercial Computer Software Restricted Rights clause at FAR 52.227-19, as applicable. Manufacturer is Grass Valley Group Inc., P.O. Box 59900, Nevada City, California 95959-7900 U.S.A.

Revision Status

Rev Date	Description
December 1, 1999	Initial release of the Profile XP System Guide 071-0624-00A
December 6, 1999	Updated to include version 4.0.1 features 071-0624-01
November 15, 2000	Updated to include support for 73 GB RAID drives — 071-0624-02
January 17, 2001	Supports new system processor board connections. 071-0624-03
July 27, 2001	Updated to include WebAble support. 071-0624-04

Contents

	Preface	
	About this manual	9
	Getting more information	13
	Grass Valley Group Product Support.....	14
	Safety Summaries	
	General Safety Summary.....	15
	Safety Terms and Symbols.....	16
	Service Safety Summary	16
	Certifications and Compliances	17
Chapter 1	Introducing the Profile XP	
	Profile XP Media Platform highlights.....	19
	Front panel controls and indicators.....	20
	Rear Panel View	23
	Standard accessories shipped with the Profile XP	24
	Profile XP Media Platform features	25
	Summary of Profile XP Models	25
	About channels and factory default configuration	25
	Video compression.....	26
	Fibre Channel RAID storage	27
	Fibre Channel and/or Ethernet IP Networks	27
	Profile XP Media Platform system overview	28
	High level block diagram	28
	Board level block diagram	30
	Starting the Profile XP system	34
	Logging on Windows NT.....	35
	Automatic Logon	35
	Logging on as Administrator	35
	Logging on as Profile	36
	Shutting down the Profile XP system	37
Chapter 2	Working with Configuration Manager	
	Tour of Configuration Manager	40
	File System	40
	Network	41
	Video setup items.....	42
	Audio setup items.....	43
	Channel Configuration	44
	Viewing hardware settings summary dialog boxes	45
	Viewing board location information	47
	Saving and restoring your system settings	48
	Saving a copy of your system configuration.....	48
	Opening saved configuration files	49
	Restoring default settings.....	50
	Importing and Exporting system settings	51
	Exporting a configuration	51
	Importing a configuration.....	53
	Remote configuration: NetCentral XP Enterprise	55



Chapter 3	Working with Profile XP storage systems	
	PFC500 Fibre Channel RAID Chassis key features	57
	PFC500 product description	58
	Storage capacity estimates	58
	Maximum video data rate per channel	60
	Connecting storage: Using a single PFC500	61
	Connecting storage: Using multiple PFC500s	64
	Addressing requirements	64
	Configuring storage using Disk Utility	69
	About configuring storage	69
	Configuring storage without hot spare drives	71
	Configuring storage to include hot spare drives	75
	Changing the volume name	80
	Expanding storage	83
	Determining which disk modules make up a LUN	85
	Updating your PFC500 firmware	86
Chapter 4	Adding or Removing Channels	
	Using the Channel Configuration dialog box	87
	Displaying the Channel Configuration dialog box	88
	Working with channels	89
	Default settings for channels you add	89
	Why resources appear dimmed, red, or in use	90
	Using Tool Tips to manage resources	91
	Using the Warning symbol to find shared resources	92
	Using the Summary button to review channel settings	93
	Adding and configuring a new channel	94
	To add a channel	94
	Entering channel name and description	94
	Selecting the channel type	96
	Selecting video quality and crosspoints	98
	Selecting audio channels for each audio track	103
	Selecting timecode I/O for each timecode track	104
	Removing a channel	105
Chapter 5	Modifying a Channel: Video Settings	
	Adjusting video output timing	107
	Adjusting playout timing to match zero time	108
	Adjusting playout timing to match E to E timing	110
	Adjusting system reference timing to offset all playout timing	112
	Auto-timing synchronous video feeds	113
	Options for timing asynchronous feeds	114
	Changing the system video standard	116
	Selecting the video I/Os used by a channel	117
	Selecting video quality for a channel	118
	Guidelines for selecting Video Quality Presets	118
	Selecting video quality settings for a channel	120
	Selecting browse video quality settings for a channel	121
	Defining and selecting a custom video quality preset	123
	Recording VBI information uncompressed	124
	Selecting the video still-play mode	126
	Viewing video input status	127

Modifying video input settings	128
Setting up the VITC reader	128
Erasing video input VBI information	130
Selecting freeze or black upon video input loss	132
Modifying video output settings.....	133
Setting up the VITC generator	133
Erasing video output VBI information	135
Selecting freeze or black for video output signal loss	137
Erasing the horizontal blanking interval	138
Renaming video I/Os in crosspoint lists	139
Renaming the video inputs.....	139
Renaming the video outputs	140
Configuring the video monitor output	141
Enabling or disabling dither on the Video Monitor output.....	141
Enabling or disabling NTSC pedestal	142
Configuring Text Overlay on the Video Monitor output	143
Enabling Video Monitor timecode burn-in	144
Using multiple video tracks for one channel	146

Chapter 6 Modifying a Channel: Audio Settings

About Profile XP Audio	149
Determining the number of audio channels available	149
Determining the audio formats available.....	150
Adding or removing audio tracks	151
Removing audio tracks.....	151
Adding audio tracks.....	152
Selecting audio channels for an audio track	154
Changing the audio I/O format.....	155
Select audio input format	155
Select audio output format	157
Checking AES/EBU input status	159
Selecting the audio clock reference	160
Selecting incoming digital audio coding format.....	161
Adjusting audio delay	162
Selecting audio delay presets	162
Selecting custom audio delay	163
Adjusting analog audio input level	164
Adjusting analog audio output level	165
Muting analog audio outputs.....	166
Selecting analog audio output line mode	167
Selecting audio reference level.....	168
Changing how audio sounds during shuttle	169

Chapter 7 Modifying a Channel: Timecode Settings

About Profile XP series timecode	171
Using the internal timecode generators	172
Selecting the internal generator as a timecode source	172
Using the same TC generator multiple channels	173
Setting up an internal timecode generator	175



	Recording VITC	177
	Selecting a VITC input for a channel	177
	Setting up the VITC reader on a Video Input	178
	Setting up the VITC reader on the Reference Input.....	180
	Generating VITC on a video output	182
	Selecting the video output as a timecode output for the channel	182
	Setting up the VITC generator on a video output.....	184
	Deleting unwanted VITC signals.....	185
	Recording or generating LTC	187
	Select a timecode source for timecode burn-in	188
Chapter 8	Controlling the Profile XP Remotely	
	Setting up RS-422 remote control in VdrPanel.....	190
	Setting up RS-422 remote control using ProLink	193
	How to set up ProLink	193
	Overview of the ProLink communications window	194
	Running PortServer to enable remote operation	195
Chapter 9	Setting up a Simple Network	
	About Profile Networking	197
	About Windows NT networking.....	197
	About the Fibre Channel video network option	198
	About the Ethernet video network option	201
	Simple Networks	203
	Profile XP systems with both video network options installed.....	203
	Setting up a simple Windows NT network	204
	Set machine name and IP address on each Profile XP system.....	204
	Power-off and connect proper cabling	206
	Power-on the hub or switch and configure if necessary	207
	Power-on and test each Profile XP system on the network	207
	Setting up a simple video network: Fibre Channel	208
	Set up the Windows NT Ethernet network	208
	Configure Fibre Channel network settings on each Profile XP	209
	Manually Edit the <i>hosts</i> file on each Profile XP	210
	Power-down and connect proper Fibre Channel cabling	212
	Power-on the switch and configure if necessary.....	213
	Test the Fibre Channel network using Media Manager	213
	Setting up a simple video network: Ethernet	218
	Set up the Windows NT Ethernet network	218
	Configure the video network on each Profile XP: Ethernet.....	218
	Manually Edit the <i>hosts</i> file on each Profile XP	220
	Power-off and connect proper Ethernet cabling.....	222
	Power-on the hub or switch and configure if necessary	223
	Test the Ethernet video network using Media Manager.....	223

Chapter 10	Solving Common Setup Problems	
	Summary of setup problems	229
	Common record/play problems	230
	Problems with video	231
	Problems with audio	232
	Problems with timecode	234
	Storage system problems	236
	Problems using Configuration Manager	237
	Channel control problems	238
	Common Ethernet network problems	239
	Common Fibre Channel video network problems	240
	Testing the Fibre Channel Video network	241
	Common Ethernet video network problems	245
	Testing the Ethernet Video network	246
Appendix A	Electrical and Environmental Specifications	
	General Information	251
	Test Equipment	251
	Electrical Specifications	252
	Profile XP System Power Specifications	256
	PAC 216 Power Requirements	256
	Environmental Criteria	257
Appendix B	Connector Pin-outs	
	S-VGA connector	259
	RJ-45 Ethernet connector	260
	Parallel Port connector	261
	RS-232 connectors	262
	I/O Panel RS-422 connectors	263
	I/O Panel GPI connectors	264
	GPI Input connector (on I/O Panel)	264
	GPI output connector (on I/O Panel)	265
	I/O Panel LTC connectors	266
	Fibre Channel Disk board connectors	267
	Fibre Channel Cable Specifications	267
	Fibre Channel Network board connector	268
	Audio board connector	269
Appendix C	Rack Mounting Information and Rear Panel Drawings	
	Rack mounting the Profile XP	271
	Chassis dimensions for Profile XP and peripheral equipment	272
	Rack mount hardware shipped with the Profile XP system	273
	Rack mount hardware for the PFC500 Fibre Channel RAID system	273
	Mounting the Rack Slides	274
	Installing the Profile XP on the rack mount rails	276
	Making Rack Slide Adjustments	276
	Mounting Panels and Audio Chassis	277
	Rear Panel Drawings	278
	Profile XP Media Platform Chassis	278
	XLR216 and BNC216 AES/EBU Breakout Panels	278
	PAC216 Profile Audio Chassis	279
	I/O Panel	279
	PFC500 Fibre Channel RAID Chassis	280
	PFC500E Expansion Chassis	280



Preface

About this manual

This *Profile XP System Guide* describes the features of the Profile XP Media Platform and presents step-by-step procedures for modifying system settings to meet the specific needs of our system. This manual assumes you have already installed your Profile XP system using the *Installation Guide* shipped with your unit.

Using the Profile XP Documentation Set

This manual is part of a full set of support documentation for the Profile XP Media Platform. The following illustrates how to use the Profile XP documentation depending on the task you are performing.

Path for the Installer

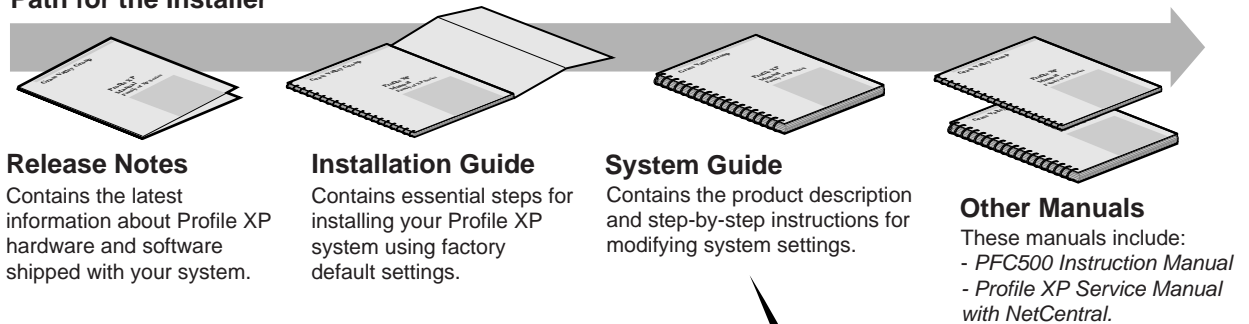

Path for the Operator

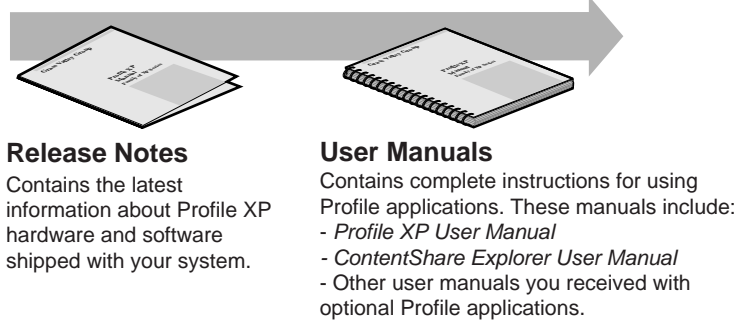

Installers consult the User Manuals as needed.

0624-39



Manual Descriptions

- **Installation Guide** (for your Profile XP Model) This guide provides step-by-step instructions for installing the Profile XP Media Platform using factory default settings for all record/play channels. Factory default settings are indicated within the guide. After installing the Profile XP system using this installation guide, you can refer to this *Profile XP System Guide* to customize system settings for your installation.
- **Profile XP User Manual** Contains complete instructions for using Profile applications to operate the Profile XP Media Platform.
- **Profile XP Service Manual with NetCentral** Contains information for servicing the Profile XP Media Platform and monitoring systems using NetCentral. Procedures are included for following tasks:
 - Setting up and using NetCentral to monitor and diagnose problems on local and remote Profile XP systems.
 - Problem analysis using symptom, possible problem, solution tables.
 - Running diagnostics
 - Replacing field replaceable units.
- **Profile XP Release Notes** Contains the latest information about the Profile hardware and the software release shipped on your system. This information includes software specifications and requirements, feature changes from the previous releases, helpful system administrative information, and any known problems.
- **PFC500 Instruction Manual** Contains information for servicing the PFC 500 Fibre Channel RAID Chassis including step-by-step procedures for replacing field replaceable units.

How this manual is organized

The *Profile XP System Guide* is organized around the tasks you'll be performing to customize the Profile XP settings to meet your system needs. You can see this reflected in the chapter titles chosen for this manual. The following identifies and describes the chapters included in this manual:

Chapter 1 - Introducing the Profile XP

Introduces the Profile XP Media Platform. You can read this chapter to get familiar with the Profile XP key features and system components. Also included is a brief architectural overview of the Profile XP system.

Chapter 2 - Working with Configuration Manager

Describes the Configuration Manager user interface and functionality. Configuration Manager is the application used to configure and manage the Profile XP system.

Chapter 3 - Working with Profile XP storage systems

Describes how to set up the external storage for the Profile XP. Procedures are included for configurations with multiple PFC500 Fibre Channel RAID Chassis and PFC500E expansion chassis, and for systems with the optional second controller board.

Chapter 4 - Adding or Removing Channels

Describes the basics of adding, configuring, or removing channels. Information on advanced channel settings are referenced to chapters 5 through 7.

Chapter 5 - Modifying a Channel: Video Settings

Describes how to modify the video settings for a channel.

Chapter 6 - Modifying a Channel: Audio Settings

Describes how to modify the audio settings for a channel.

Chapter 7 - Modifying a Channel: Timecode Settings

Describes how to modify the timecode settings for a channel.

Chapter 8 - Controlling the Profile XP Remotely

Describes how to set up the Profile XP Media Platform for the control mode you want to use: remote control protocol over RS-422 or remote applications over Ethernet.



Chapter 9 - Setting up a Simple Network

Describes how to set up a simple network of Profile XP systems. Procedures are included for setting up the Windows NT network and both Profile XP video network options.

Chapter 10 - Solving Common Setup Problems

Provides help for solving common set up problems that occur when Profile XP features or signal requirements are not understood.

Appendix A - Electrical and Environmental Specifications

This appendix consists of electrical and environmental specifications.

Appendix B - Connector Pin-outs

This appendix identifies connectors and the signals present on the pins of those connectors.

Appendix C - Rack Mounting Information and Rear Panel Drawings

This appendix provides rack mounting information for the Profile XP system and peripheral equipment. Also provided are rear panel illustrations for the Profile XP and peripheral equipment.

Getting more information

In addition to printed documents, Profile XP product information is available in on-line manuals and the Profile XP help system. Use these as additional sources for information.

On-line manuals

Electronic versions of the following manuals are located on the system drive of your Profile XP Media Platform and on the Profile XP software CD-ROM.

- *Installation Guide* (for your model)
- *Profile XP System Guide*
- *Profile XP User Manual*
- *Profile XP Release Notes*
- *ContentShare User Guide*
- *Profile XP Service Manual with NetCentral XP*

You can view these manuals using Adobe Acrobat Reader which is also pre-installed on your Profile XP system.

On-line Help

Contains all the information in the Profile XP System Guide, optimized for use on-line. You can access on-line help by choosing the Help menu, or by clicking the Help button in a dialog box.



Grass Valley Group Product Support

You can get technical assistance, check on the status of problems, or report new problems by contacting our Product Support Group.

United States and Canada

Monday–Friday 5:30AM–5:00PM Pacific Time
(800) 547-8949

Europe

Monday–Friday 9:00AM–5:30PM

France	01 69 86 83 47	United Kingdom	01628 405830
Germany	0221 9477 446	Other	+44 1628 405840
Italy	02 25086606		

Asia and South America

Australia	02-9888 0100	Japan	81-3-3448-3111
- from overseas	61-2-9888 0100	Korea	82-2-528-5299
Beijing	86-10-62351230 ext. 711	Mexico	52-5-666-6333
Brazil	55-11-3741-8422	Singapore	65-356-3900
Hong Kong	852-25856655	Taiwan	886-2-27571571

World Wide

24-hour Emergency Hotline (530) 478-4148 (Contract and warranty customers)

World Wide Web	http://www.grassvalleygroup.com
FTP Site	ftp.grassvalleygroup.com
Email	ProfileSupport@grassvalleygroup.com
Users Group	profile-users@grassvalleygroup.com

Safety Summaries

General Safety Summary

Review the following safety precautions to avoid injury and prevent damage to this product or any products connected to it.

Only qualified personnel should perform service procedures.

While using this product, you may need to access other parts of the system. Read the *General Safety summary* in other system manuals for warnings and cautions related to operating the system.

Injury Precautions

- | | |
|--|--|
| Use Proper Power Cord | To avoid fire hazard, use only the power cord specified for this product. |
| Ground the Product | This product is grounded through the grounding conductor of the power cord. To avoid electric shock, the grounding conductor must be connected to earth ground. Before making connections to the input or output terminals of the product, ensure that the product is properly grounded. |
| Do Not Operate Without Covers | To avoid electric shock or fire hazard, do not operate this product with covers or panels removed. |
| Do Not operate in Wet/Damp Conditions | To avoid electric shock, do not operate this product in wet or damp conditions. |
| Do Not Operate in an Explosive Atmosphere | To avoid injury or fire hazard, do not operate this product in an explosive atmosphere. |
| Avoid Exposed Circuitry | To avoid injury, remove jewelry such as rings, watches, and other metallic objects. Do not touch exposed connections and components when power is present. |

Product Damage Precautions

- | | |
|---|---|
| Use Proper Power Source | Do not operate this product from a power source that applies more than the voltage specified. |
| Provide Proper Ventilation | To prevent product overheating, provide proper ventilation. |
| Do Not Operate With Suspected Failures | If you suspect there is damage to this product, have it inspected by qualified service personnel. |
| Battery Replacement | To avoid damage, replace only with the same or equivalent type recommended by the circuit board manufacturer. Dispose of used battery according to the circuit board manufacturer's instructions. |



Safety Terms and Symbols

Terms in This Manual

These terms may appear in this manual:



WARNING: Warning statements identify conditions or practices that can result in personal injury or loss of life.



CAUTION: Caution statements identify conditions or practices that can result in damage to the equipment or other property.

Terms on the Product

These terms may appear on the product:

DANGER indicates a personal injury hazard immediately accessible as one reads the marking.

WARNING indicates a personal injury hazard not immediately accessible as you read the marking.

CAUTION indicates a hazard to property including the product.

Symbols on the Product

The following symbols may appear on the product:



DANGER high voltage



Protective ground (earth) terminal



ATTENTION – refer to manual

Service Safety Summary

Do Not Service Alone

Do not perform internal service or adjustment of this product unless another person capable of rendering first aid and resuscitation is present.

Disconnect Power

To avoid electric shock, disconnect the main power by means of the power cord or, if provided, the power switch.

Use Care When Servicing With Power On

Dangerous voltages or currents may exist in this product. Disconnect power and remove battery (if applicable) before removing protective panels, soldering, or replacing components.

To avoid electric shock, do not touch exposed connections

Certifications and Compliances

Canadian Certified Power Cords

Canadian approval includes the products and power cords appropriate for use in the North America power network. All other power cords supplied are approved for the country of use.

FCC Emission Control

This equipment has been tested and found to comply with the limits for a Class A digital device, pursuant to Part 15 of the FCC Rules. These limits are designed to provide reasonable protection against harmful interference when the equipment is operated in a commercial environment. This equipment generates, uses, and can radiate radio frequency energy and, if not installed and used in accordance with the instruction manual, may cause harmful interference to radio communications. Operation of this equipment in a residential area is likely to cause harmful interference in which case the user will be required to correct the interference at his own expense. Changes or modifications not expressly approved by Tektronix can affect emission compliance and could void the user's authority to operate this equipment.

Canadian EMC Notice of Compliance

This digital apparatus does not exceed the Class A limits for radio noise emissions from digital apparatus set out in the Radio Interference Regulations of the Canadian Department of Communications.

Le présent appareil numérique n'émet pas de bruits radioélectriques dépassant les limites applicables aux appareils numériques de la classe A prescrites dans le Règlement sur le brouillage radioélectrique édicté par le ministère des Communications du Canada.

Canadian Certified AC Adapter

Canadian approval includes the AC adapters appropriate for use in the North America power network. All other AC adapters supplied are approved for the country of use.

EN55022 Class A Warning

For products that comply with Class A. In a domestic environment this product may cause radio interference in which case the user may be required to take adequate measures.

Laser Compliance

Laser Safety Requirements

The device used in this product is a Class 1 certified laser product. Operating this product outside specifications or altering its original design may result in hazardous radiation exposure, and may be considered an act of modifying or new manufacturing of a laser product under U.S. regulations contained in 21CFR Chapter 1, subchapter J or CENELEC regulations in HD 482 S1. People performing such an act are required by law to recertify and reidentify this product in accordance with provisions of 21CFR subchapter J for distribution within the U.S.A., and in accordance with CENELEC HD 482 S1 for distribution within countries using the IEC 825 standard.



Laser Safety Laser safety in the United States is regulated by the Center for Devices and Radiological Health (CDRH). The laser safety regulations are published in the “Laser Product Performance Standard,” Code of Federal Regulation (CFR), Title 21, Subchapter J.

The International Electrotechnical Commission (IEC) Standard 825, “Radiation of Laser Products, Equipment Classification, Requirements and User’s Guide,” governs laser products outside the United States. Europe and member nations of the European Free Trade Association fall under the jurisdiction of the Comité Européen de Normalization Electrotechnique (CENELEC).

FCC Emission Limits This device complies with Part 15 of the FCC Rules. Operation is subject to the following two conditions: (1) This device may not cause harmful interference, and (2) this device must accept any interference received, including interference that may cause undesirable operation.

Certification

Category	Standard
Safety	<i>Designed/tested for compliance with:</i> UL1950 - Safety of Information Technology Equipment, including Electrical Business Equipment (Third Edition, 1995) IEC 950 - Safety of Information Technology Equipment, including Electrical Business Equipment (Second edition, 1991) CAN/CSA C22.2, No. 950-95 - Safety of Information Technology Equipment, including Electrical Business Equipment EN60950 - Safety of Information Technology Equipment, including Electrical Business Equipment

Introducing the Profile XP

The Profile XP Media Platform provides a multi-channel, high bandwidth platform for the storage and manipulation of video and audio in professional applications. The Profile XP has a wide range of capabilities, from a stand alone digital disk recorder to being part of a large network of video servers. The Profile XP Media Platform can be used in a wide variety of applications including spot insertion, program delay, store and forward, and multi-channel replay.

Profile XP Media Platform highlights

Highlights include:

- Up to 8 channels of broadcast-quality video
- MPEG-2 4:2:2 @ Main Level from 4-50Mb/s, long GOP
- SMPTE 259M, 270MHz Serial Digital I/O (Analog monitor optional)
- 16/32 channels audio — AES/EBU, embedded, analog uncompressed audio, Dolby E and AC-3 compressed audio
- 600Mb/s System Bandwidth
- Redundant power supply, NT disk, cooling fans for reliability
- Fibre Channel attached high performance RAID storage
- Remote error reporting & monitoring via SNMP
- High speed Fibre Channel networking up to 300Mb/s
- 100BaseT Ethernet networking up to 30Mb/s
- 525/60 or 625/50 operation: accepts NTSC, PAL reference.
- Remote control including:
 - Remote Applications over Ethernet
 - RS-422 control protocol including Louth, Odetics, BVW, or Profile protocols.
 - GPI Trigger (8 I/O)



Front panel controls and indicators

The Profile XP front panel includes the following controls and indicators:

- ❶ **Power-On LED** - indicates the standby switch is in the on position and that secondary voltages are present in the chassis.
- ❷ **Standby Switch** - provides system On/Off control.
- ❸ **System Fault LED** - indicates a system fault exist somewhere in the Profile XP unit.

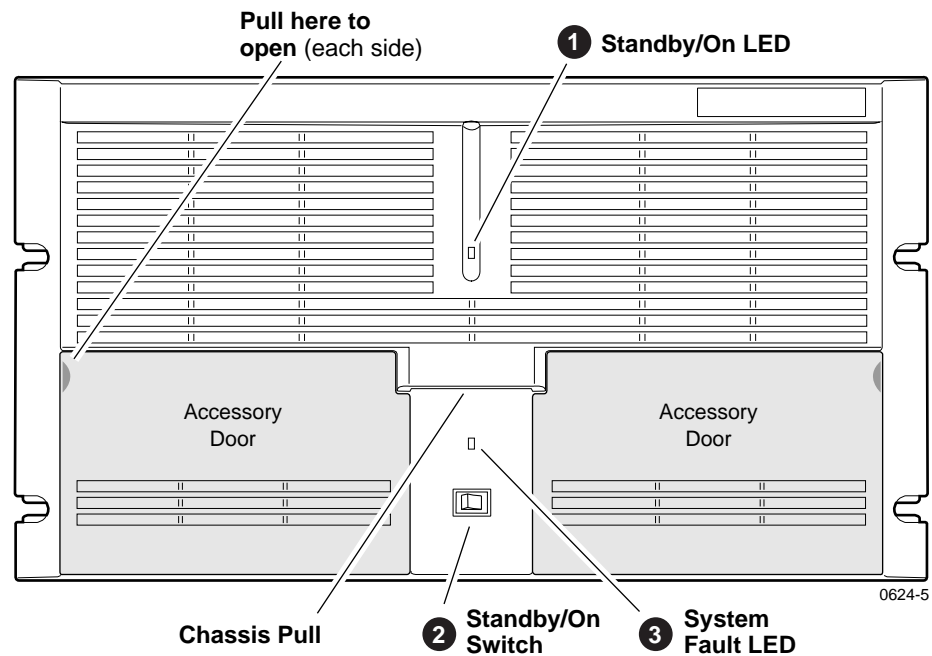

The Profile XP front panel features two accessory doors that provide access to several storage devices. The following describes the storage devices installed on the standard Profile XP system.

- ❶ **System Disk** - contains the Windows NT operating system and Profile XP system software and applications.
- ❷ **1.44MB Floppy Disk Drive**
- ❸ **CD-ROM Drive** - for maintaining the Windows NT operating system and performing Profile XP system software upgrades.

NOTE: If an accessory door is accidentally dislocated from its hinges, you can easily pop it back into place.

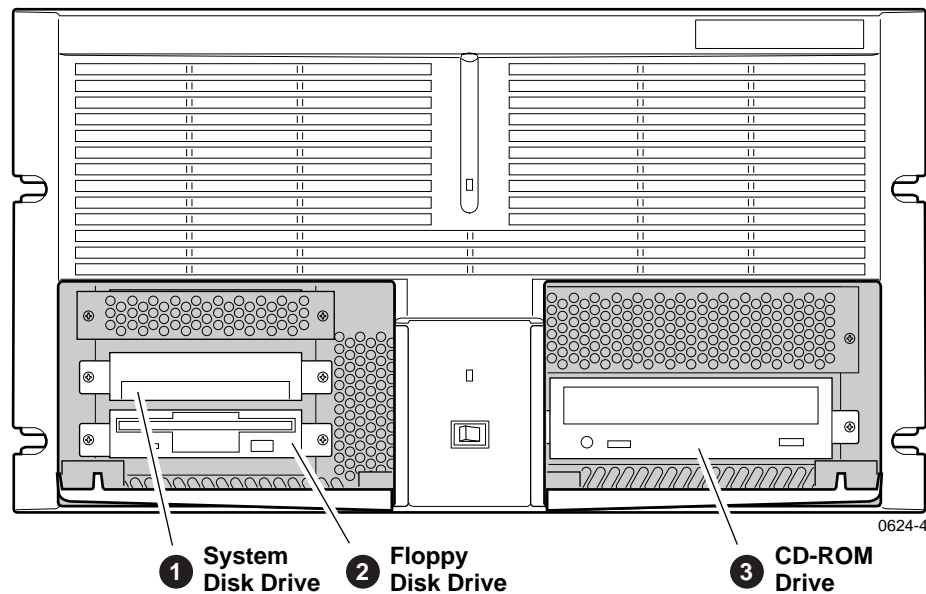



The following describes the storage devices in a Profile XP system with the redundant system disk option.

- ❶ **Primary System Drive** - contains Windows NT operating system and Profile XP software and applications.
- ❷ **Mirror System Disk** - mirrors primary system disk and provides automatic fail-over in the event the primary system disk fails.

❸ **Drive Mirroring Controller and Indicator Panel** -

The Indicator Panel status LEDs indicate the operating mode of the mirroring system as follows:

- **Green** - Drives are in Mirror mode
- **Red** - Drives in Single mode
- **Orange** - Drive activity

The Buzzer Off switch can be used to silence the buzzer, which sounds under the following conditions:

- Short beep during power on indicates successful boot-up
- Second beep indicates the mirroring system is running in single mode
- Continuous or intermittent beep indicates a drive failure

- ❹ **CD-ROM Drive** - for maintaining the Windows NT operating system and performing Profile XP system software upgrades.

- ❺ **120MB Super-Drive** - accepts 1.44MB floppy disks and 120MB disks.

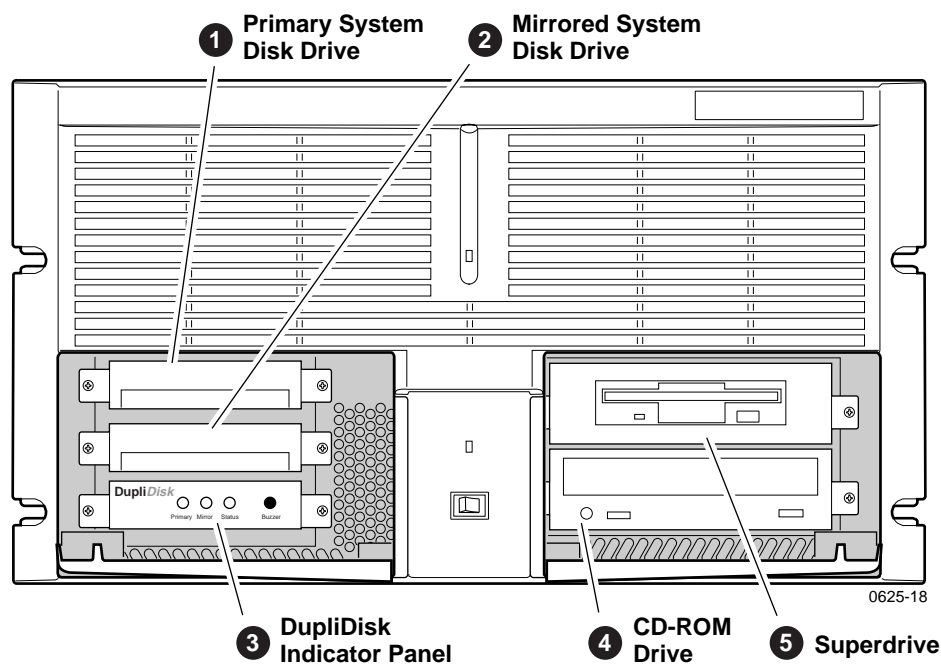

Rear Panel View

The figure shows the Profile XP rear panel connectors. Rear panel drawings for peripheral equipment are located in Appendix C, “Rack Mounting Information and Rear Panel Drawings”.

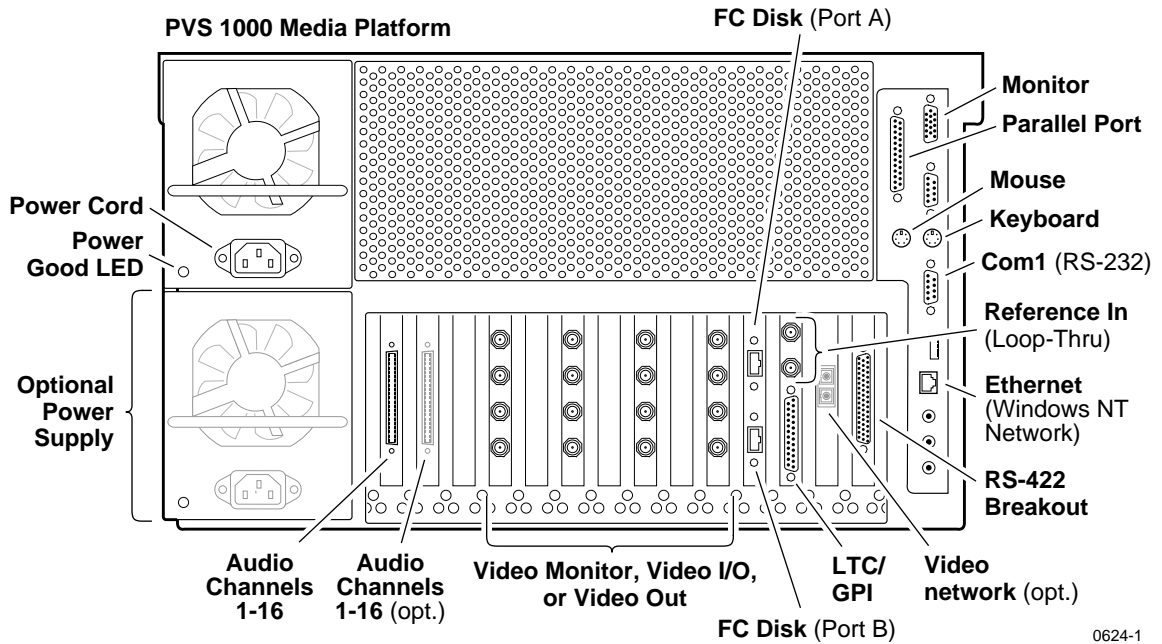

0624-1



Standard accessories shipped with the Profile XP

The Profile XP Media Platform is shipped with the following standard accessories:

- Manuals Include:
 - *Installation Guide*
 - *Profile XP System Guide*
 - *Profile XP User Manual*
 - *Profile XP Service Manual with NetCentral*
 - *Content Share User Manual*
 - *Profile XP Release Notes*
- Software package which includes the Profile XP Software CD-ROM and an emergency repair disk.
- Windows NT software package
- Keyboard and mouse
- I/O Panel and cables (provides LTC, RS-422 & GPI interfaces)
- Power cable assembly
- Rack mounting slides
- Ethernet cable

Profile XP Media Platform features

The Profile XP Media Platform is an all digital architecture supporting SDI video I/O and either uncompressed or compressed audio.

Summary of Profile XP Models

Profile XP is available in several factory installed configurations. The following figure shows the number of encoders and decoders available in each model.

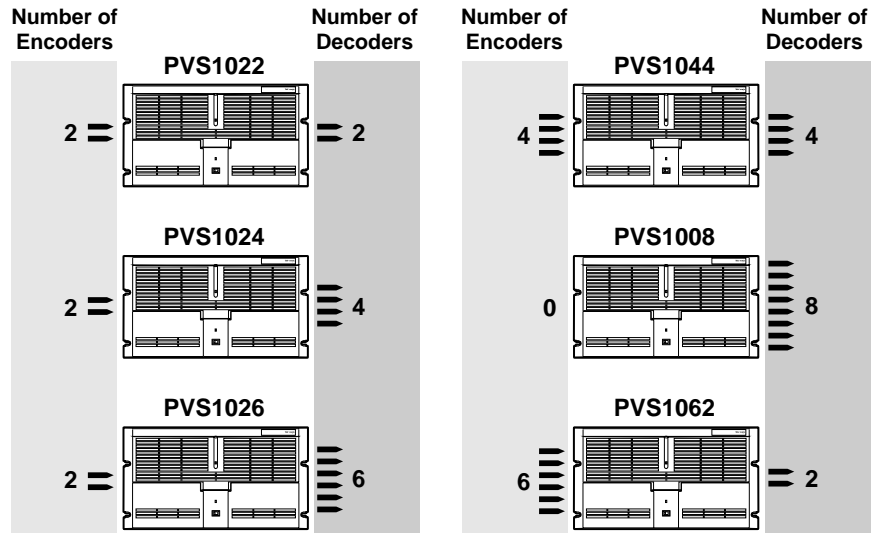

0624-19

About channels and factory default configuration

Profile applications use channels to control disk recording and playback. A channel defines a grouping of Profile XP video, audio, and timecode resources and is identified by a unique name. Profile XP software supports three channel types: Recorder channel, Player channel, or Player/Recorder channel. For more information on channel types and creating or modifying channels, refer the *Profile XP System Guide*.

Your Profile XP system is shipped with default Recorder and Player channels. These default channels are named Vtr1, Vtr2, Vtr3 and so on. The following table describes the video and audio connections you'll make for the two channel types. The



Installation Guide contains specifics about the type and number of default channels in your Profile XP model, and their video and audio I/O connections.

Default channel type	Video I/O connections	Audio connections ^a	Timecode I/O
Recorder	1 SDI video input 1 analog monitor ^b	2, 4, or 8 audio I/Os	Uses the internal timecode generator.
Player	1 SDI video output	2, 4, or 8 audio I/Os	Recorded timecode is used to generate VITC on the SDI video output

^a. The number of audio I/Os is determined by your Profile XP model and the number of Audio boards installed.

^b. Available if the optional Video Monitor board is installed.

You can use the information in this System Guide to modify default channel settings to satisfy the needs of your system. For more information about channels, refer to Chapter 4, *Adding or Removing Channels*.

Video compression

The Profile XP Media Platform uses MPEG 2 4:2:2 @ Main Level encoding with selectable bit rates from 4Mbps to 50Mbps. The additional chroma resolution that 4:2:2 sampling gives provides good multi-generation capability as well as up-conversion quality.

Seamless play and cuts editing at any bit rate and any GOP is made possible by the Profile XP dual MPEG decoder architecture that allows storage efficiencies of a long GOP and maintains the ability to cut on any frame and play clips back-to-back seamlessly. This provides all of the advantages of long GOP encoding, without the limitations.

Fibre Channel RAID storage

Profile XP storage is comprised of the PFC500 Fibre Channel RAID Chassis and the PFC500E Expansion Chassis. Both are 3.5 RU ten drive Fibre Channel disk arrays with hot swap and redundant drives, power supplies and fans. The PFC500 houses the controller for the system.

The PFC500 Fibre Channel RAID Chassis contains five or ten 18 or 36 GB drives. Additional storage is available by adding up to two PFC500E Expansion Chassis. Each PFC500E Expansion chassis can hold five or ten 18 (PFC518) or 36 GB (PFC536) drives. The PFC500's RAID controller will control up to two PFC500E expansion chassis.

The PFC500 is available in a two controller configuration for redundancy. If the primary RAID Controller fails, the system will automatically switch over to the redundant controller within a few seconds.

The PFC500 is configured to use RAID-3 storage for high availability to media.

Fibre Channel and/or Ethernet IP Networks

The Profile XP family offers true IP networking over Fibre Channel or Ethernet.

- Faster than real time transfers (up to 40x) with no generation loss
- Reliable transfers using secure file transfer protocols
- IP networking enables files to be moved between devices or between facilities over standard public networks.
- Profile network streaming enables “play while transferring”

Fibre Channel Streaming enables the file to be used shortly after the destination Profile starts receiving it — just like you can do with a traditional video router. This eliminates the traditional drawback of networking in which the file must finish transferring before a user has access to edit it or play it out.



Profile XP Media Platform system overview

The Profile XP Media Platform system is an extension to a standard PCI bus-based Windows NT computer. This standard is enhanced to add functionality and performance necessary to deliver an industrial grade, broadcast quality disk based video server. This section discusses the major architectural blocks, what they do, and how they interconnect.

High level block diagram

The Profile XP Media Platform has three subsystems: Application Subsystem, Real Time Subsystem, and Storage Subsystem.

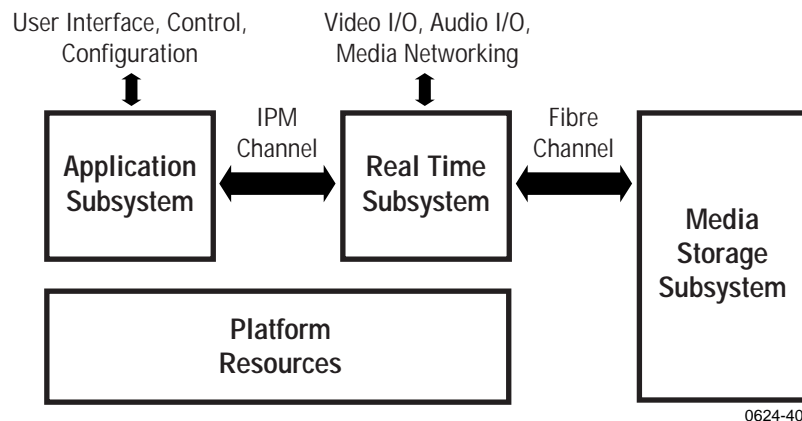

Application Subsystem

The Application Subsystem is a Windows NT computer subsystem. The Application Subsystem provides a platform for running Windows based applications for configuring and controlling the Real Time Subsystem both locally and remotely.

Real Time Subsystem

The Real-Time Subsystem contains a real time processor and peripheral devices and runs the VXWorks operating system. The Real Time Subsystem manages all the hardware involved in controlling the flow of video, audio, timecode in and out of the system. This includes video I/O boards, audio I/O boards, video compression boards, and networking and storage. The Real Time Subsystem is controlled by applications running on the Applications Subsystem using Inter-Processor Messaging channels (IPM). It is responsible for the execution of events on the play timeline.

Media Storage Subsystem

The Storage Subsystem is where the video, audio, timecode and other media related data is stored. This storage system is made up of one or more external RAID level 3 storage chassis containing Fibre Channel disks. The Profile XP Real Time Subsystem controls read/write disk operations by sending SCSI protocol commands over one or more Fibre Channel links.

Platform Resources

The platform resources provide the infrastructure necessary to operate, interconnect, and integrate all the Application Subsystem, Real Time Subsystem components. The elements that comprise the Platform Resources are: Multi-slot PCI bus, video & audio crosspoint fabric, power supply and system cooling.



Board level block diagram

This section describes the Profile XP architecture in more detail using a board level block diagram. From this discussion you'll gain an understanding of the basic signal flow in the Profile XP system. Use this information when you are installing and setting up the Profile XP Media Platform.

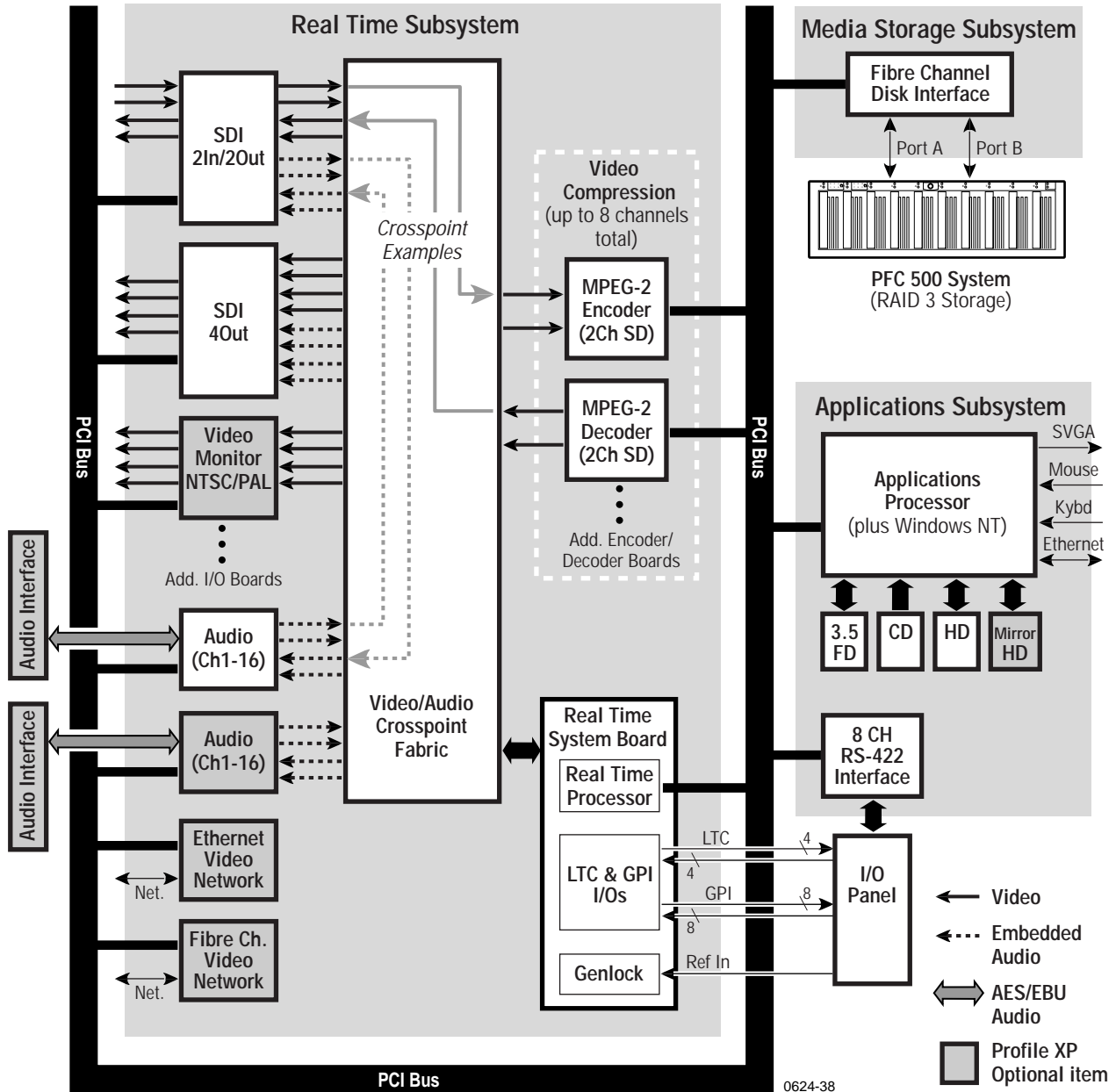

Motherboard

The Profile XP system motherboard contains 14 board slots. Each slot includes a connection to the system PCI bus and the Video/Audio Transport Fabric. The video/Audio transport fabric is an integrated 96x96 crosspoint switch which provides uncompressed video (CCIR601) and audio (24bit) routing. Video is routed in

Applications Subsystem

The Applications Subsystem is a Windows NT computer system and includes the following components:

Application Processor Board

The Application Engine is a standard NLX single board computer. The Application Subsystem provides a platform for running Windows based applications for configuring and controlling the Real Time Subsystem both locally and remotely. Rear panel I/O includes:

- Mouse, Keyboard, and SVGA Connectors
- Two Serial Ports
- One Parallel Port
- Two USB Ports
- Audio Line Level IN/OUT, and Mic Input
- 10/100BASE-T RJ-45 Ethernet Port

RS422 Board

This RS-422 adapter is installed as part of the Applications Processor system under Windows NT. Control applications running on the Application Processor receive control commands from a remote protocol listener that monitors the RS-422 ports.

Real Time Subsystem

The Real Time Subsystem includes the following components:

Real Time Processor

The Real Time Processor board contains a real time processor and peripheral devices and runs the VXWorks operating system. This board manages all the hardware involved in controlling the flow of video, audio, timecode in and out of the system. This includes video I/O boards, audio I/O boards, video compression boards, and networking and storage. Other board functionality includes:

- Generation of system 27MHz clock and frame reference pulse locked to reference video input.
- LTC In reader and LTC Out generator.
- VITC reader for reference video input.
- GPIO (8 In, 8 Out)
- Black generator and Colorbar generator used for loss of input or output video conditions.



Serial Digital Video Boards

These boards provide four serial digital video (270Mb/s SMPTE 259M), either 2In/2Out or 4 Out, through four BNC connectors on the rear of the board. An internal frame buffer is provided for each video input on the board for auto-timing synchronous and asynchronous inputs. Embedded audio is supported—maximum of 8 channels audio per video input—and is routed over the video routing fabric. VITC can be read from each input and generated on each output.

Video Monitor (Optional)

The Video Monitor board provides 4 analog composite video outputs for monitoring purposes. The outputs include Text Overlay and Timecode burnin.

Audio Board

The Audio board provides sixteen channels of 16 or 24 bit audio I/O. An additional Audio Board may be added as an option for a total of 32 channels of audio. Audio I/O formats include

- Embedded
- AES/EBU
- Analog

The Audio board includes a rear panel 80 pin interface connector for AES/EBU audio I/O. For AES/EBU operation, a breakout panel is required. For operation with analog signals, the PAC216 Analog Audio Chassis is required for conversion of analog signals to AES/EBU.

Embedded audio is extracted from the video inputs by the Video I/O boards and routed over the Video/Audio Transport Fabric to the Audio board.

Audio processed by the Audio board is routed over the PCI bus to the Media Storage Subsystem. The audio board does not compress the audio for storage, but can pass through pre-compressed Dolby E and AC-3 compressed signals.

MPEG-2 Encoder and Decoder Boards

Each MPEG-2 Encoder or MPEG-2 Decoder board provides 2 channels of video processing. Encoding bit rates are from 4Mb/s to 50 Mb/s. Up to four of these type boards can be installed in a Profile XP system.

For record mode, video is routed from the Video I/O boards, over the video transport fabric to the MPEG-2 Encoder Board. MPEG-2 compressed data is moved over the PCI bus to the Media Storage Subsystem. For play mode, MPEG-2 compressed data is routed from the Media Storage Subsystem, over PCI bus, to the MPEG-2 Decoder board where the data is processed. Full bandwidth video is routed from the MPEG-2 Decoder board over the video transport fabric to the Video I/O boards.

Video Network Adapter (Optional)

The Video Network Adapter is a 1Gb/s Fibre Channel board or 100BaseT Ethernet board for video network connections. Both provide faster than real-time transfers of video data.

Media Storage Subsystem

The Media Storage Subsystem includes the following components:

Fibre Channel Disk Board

This is a dual port Fibre Channel Disk board for connecting the Profile XP system to the external Fibre Channel RAID storage system. Both ports use a copper Gigabit Link Module (GLM) for copper Fibre Channel cables. The system normally operates with only Port A connected to the PFC500 system. When the PFC500 is ordered with the optional second controller board, Port B can be connected to provide a redundant path to the disks, or for increased disk I/O bandwidth.

PFC500 Fibre Channel RAID Chassis

The PFC500 high performance RAID storage system provides the Profile XP a low profile, compact storage system with either 18 GB or 36 GB fibre channel drives. The PFC500 is a 3.5 RU 10 drive Fibre Channel disk array with RAID drives, hot spares, dual power supplies (optional), redundant controllers (optional) and spare fans – all hot swappable.

The PFC500 comes with either 18 GB (PFC518) or 36 GB drives (PFC536). Expansion can be done with the PFC518E/536E expansion system which houses 5 or 10 drives but does not need a RAID controller. The PFC500's RAID controller will control up to 2 expansion frames (30 total drives). The PFC500 offers optional redundant RAID controllers. If one fails, the system will automatically switch over to the second controller within a few seconds.



Starting the Profile XP system

When starting your system, you must power-on the Profile XP Media Platform and the PFC500 storage system as described in the following procedure.

To power-on the Profile XP system:

1. Turn on power to all peripheral devices connected to the Profile XP. The PFC500 and PFC500E power switches are located behind the fan pack as shown.

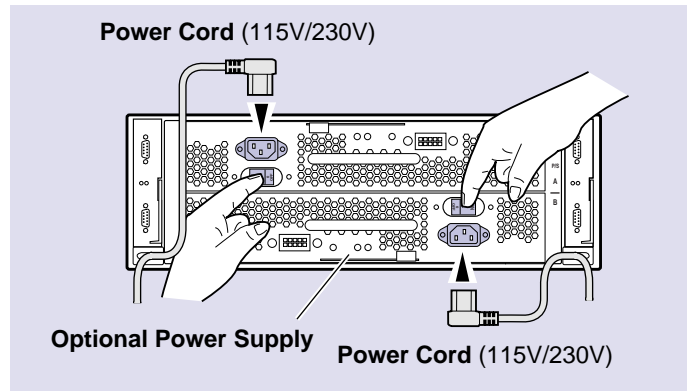

2. After about 90 seconds, verify that the **System Check LED** is out on the PFC 500 Fibre Channel RAID Chassis and all PFC 500E Expansion Chassis, if installed. Refer to the *PFC 500 Instruction Manual* for more information if the System Check LED remains lit.

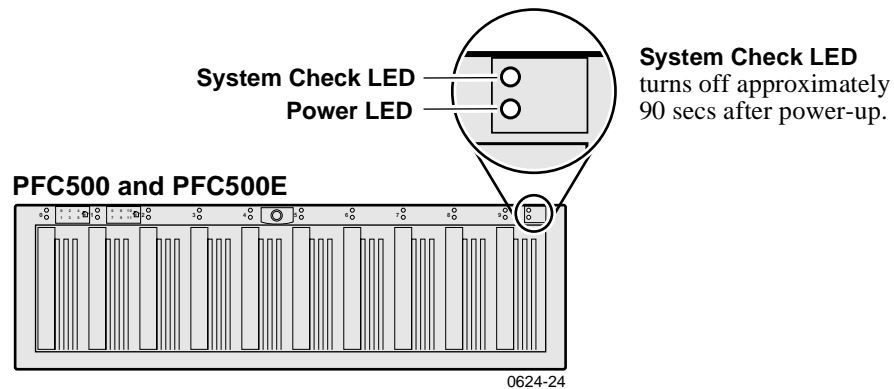

NOTE: Do not power-on the PVS1000 until the PFC500 Fibre Channel RAID storage system is fully initialized; approximately 2-3 minutes.

3. Turn on the power to the Profile XP Media Platform and wait for Windows NT to initialize and perform auto-logon. The Windows NT desktop will appear after successful auto-logon.

Logging on Windows NT

When the Profile system powered-on and before Windows NT boots, you must make a choice of how you want to logon the system.

Automatic Logon

When the Profile XP system is powered on, you may let Windows NT go through an automatic logon sequence. The system will perform automatic logon using a default account called *profile*. After automatic logon, the Windows NT desktop will appear.

Automatic logon will occur at power On when:

- The *profile* account was used the last time the Profile XP Media Platform was turned off.
- The Profile XP Media Platform is initially powered On from the factory. (The factory sets the last user to *profile* prior to shipment.)

Logging on as Administrator

When the Profile XP system is powered On, you may interrupt automatic logon and logon as Administrator. It is not necessary to logon as administrator to configure Profile System software. However, you must logon as Administrator for Windows NT administration and to:

- Configure Ethernet network settings (see Chapter 9, *Setting up a Simple Network*).
- Install new software applications or upgrades (see *Profile XP Release Notes*).

To log on as Administrator at Power Up

To logon as Administrator at power-up:

1. Power-on the Profile XP system, then hold the **Shift** key down during start-up to prevent auto-logon as *profile*. Be sure to continue holding the shift key until the logon dialog box appears.
2. Logon as *administrator*. The default *administrator* password on a Profile system is *triton*.

The next time the Profile XP system is restarted, Windows NT will display a logon error message. When this occurs, use the logon dialog box to logon manually as *administrator* or as *profile* (see the following procedure).



Logging on as Administrator from Profile account

To logon as Administrator from Profile account:

1. Log on as Administrator using the following steps:
 - a. Press the **Control-Alt-Del** key sequence. The Windows NT Security dialog box appears.
 - b. Click **Log off**. The Log off Windows NT dialog box appears.
 - c. Press and hold down the **Shift** key on the Profile XP keyboard, then click **OK**.

NOTE: *You must hold down the shift key to over-ride auto-logon.*

- d. When the Begin Logon dialog box appears release the **Shift** key, then press the **Control-Alt-Del** key sequence.
- e. Enter the following, then click **OK**.

Username: *Administrator*

Password: *triton*

You are now logged on as Administrator and can modify system settings.

Logging on as Profile

After performing system administrative tasks using the *Administrator* user account, *Profile* account to enable the automatic logon feature for future system boots.

To logon as *profile*:

1. Power up or log off the Profile XP System.
2. When the logon error message appears click **OK**.
3. Enter the following, then click **OK**.

Username: *Profile*

Password: *profile*

Windows NT will now perform automatic logon the next time the system is restarted.

Shutting down the Profile XP system

To shutdown your Profile XP system without loss of data, you must:

1. Quit all Profile applications by selecting **Quit** or **Exit** from the **File** menu.
2. Exit or Quit any other processes which may be running in the same way.
3. Shutdown Windows NT by pressing the **CTRL+ALT+DEL** key sequence and choosing **Shutdown**.
4. When Windows NT displays a message that it is safe to turn off the system, turn the front panel switch to **Standby**.
5. Power-off all peripheral devices including the PFC 500 Fibre Channel RAID chassis and PFC 500E Expansion chassis (if installed) as shown.

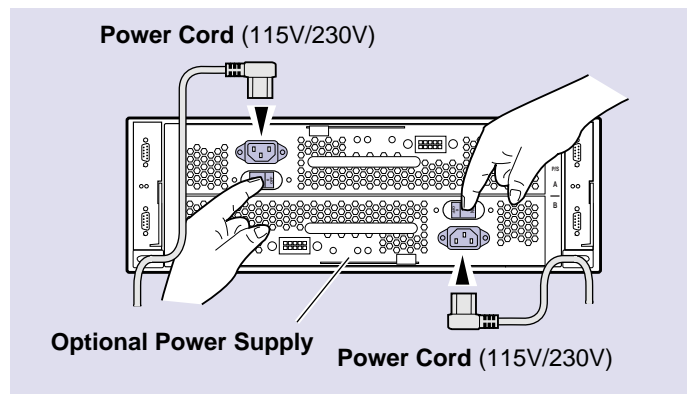



Chapter 1 Introducing the Profile XP

Working with Configuration Manager

Configuration manager is the tool you'll use to set up the Profile XP for operation. You'll use Configuration Manager to do things like create a video file system on the RAID storage system, create or modify channels, and configure system hardware settings. The Configuration Manager window appears as shown.



This chapter gives a brief tour of Configuration Manager. Also included are instructions for remote configuration and saving/restoring configuration settings.

Sections in this chapter include:

- Tour of Configuration Manager
- Viewing board location information
- Saving and restoring your system settings
- Importing and Exporting system settings
- Remote configuration: NetCentral XP Enterprise



Tour of Configuration Manager

Configuration Manager provides a central graphical user interface for all system configuration tasks. Configuration Manager includes the following selection items:

- File System - used to configure the media storage system
- Network - used to set up the video network option
- Video setup items - used to configure video input and output settings
- Audio setup items - used to configure audio input and output settings
- Channel Configuration - used to add and modify channels.

File System

Choosing File System in Configuration Manager opens the Disk Utility dialog box. Use the pages in the Disk Utility to configure storage for the Profile XP system.

For more information on configuring storage, see Chapter 3, *Working with Profile XP storage systems*.

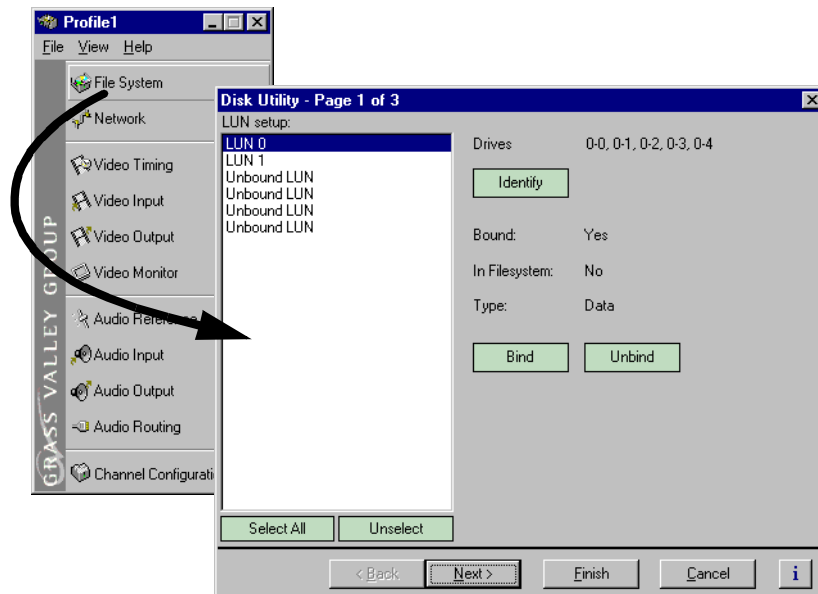

Network

Choosing Network in Configuration Manager opens the video network configuration pages. Use these pages to configure the settings for the optional video network.

For more information on setting up the video network option, see Chapter 9, *Setting up a Simple Network*.

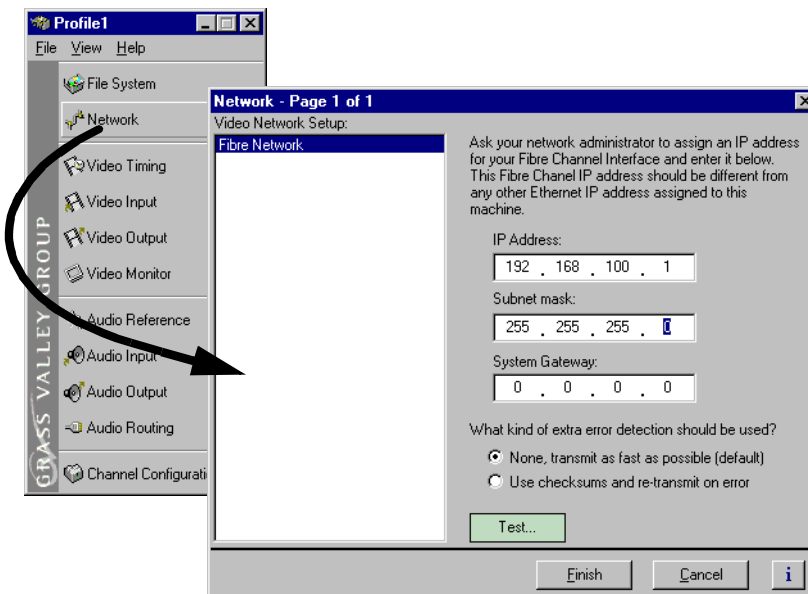



Video setup items

Configuration Manager includes four items used for configuring the video input/output settings. These include:

- Video Timing - used to select the video standard and for setting up reference genlock and video output timing.
- Video Input - used to configure the settings for each video input, including: input frame buffer operation, input blanking, loss of signal behavior and VITC reader settings.
- Video Output - used to configure the settings for each video output including: loss of signal behavior, vertical interval blanking, and VITC generator settings.
- Video Monitor - used to set up timecode burn-in and text overlay on the optional video monitor board.

See Chapter 5, *Modifying a Channel: Video Settings*, for more information on modifying video settings.

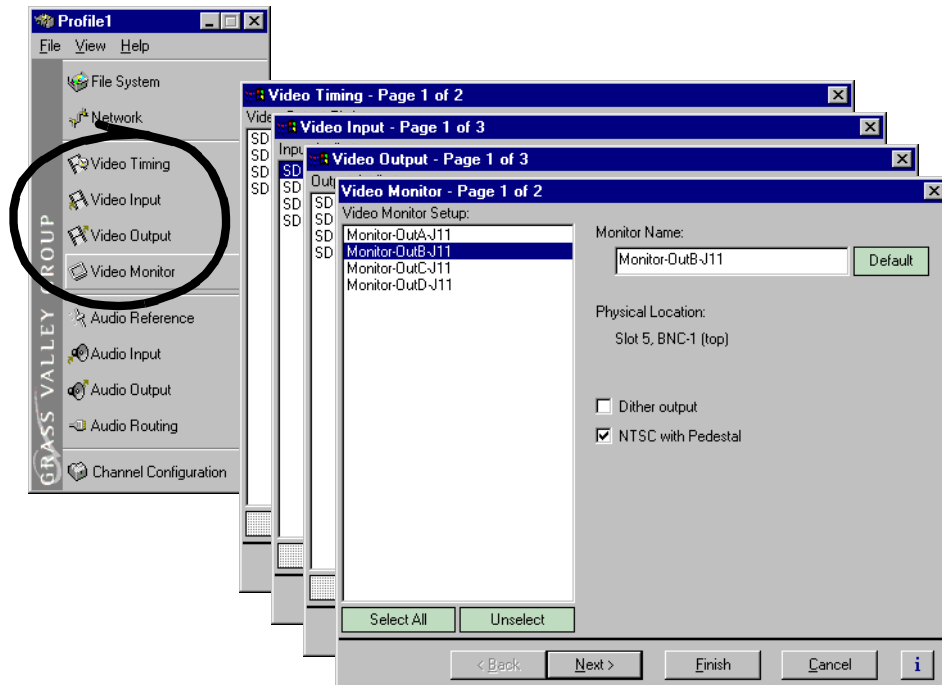

Audio setup items

Configuration Manager includes four menu items used for configuring the audio input/output settings. These include:

- Audio Reference - used to set the audio reference level. The audio reference level is used to set the default audio level in some Profile applications.
- Audio Input - used to adjust the analog audio input gain and monitor the status of AES/EBU input signals.
- Audio Output - used to adjust the analog audio output gain.
- Audio Routing - used to set up audio sources and destinations for Profile XP audio channels.

See Chapter 6, *Modifying a Channel: Audio Settings*, for more information on modifying audio settings.

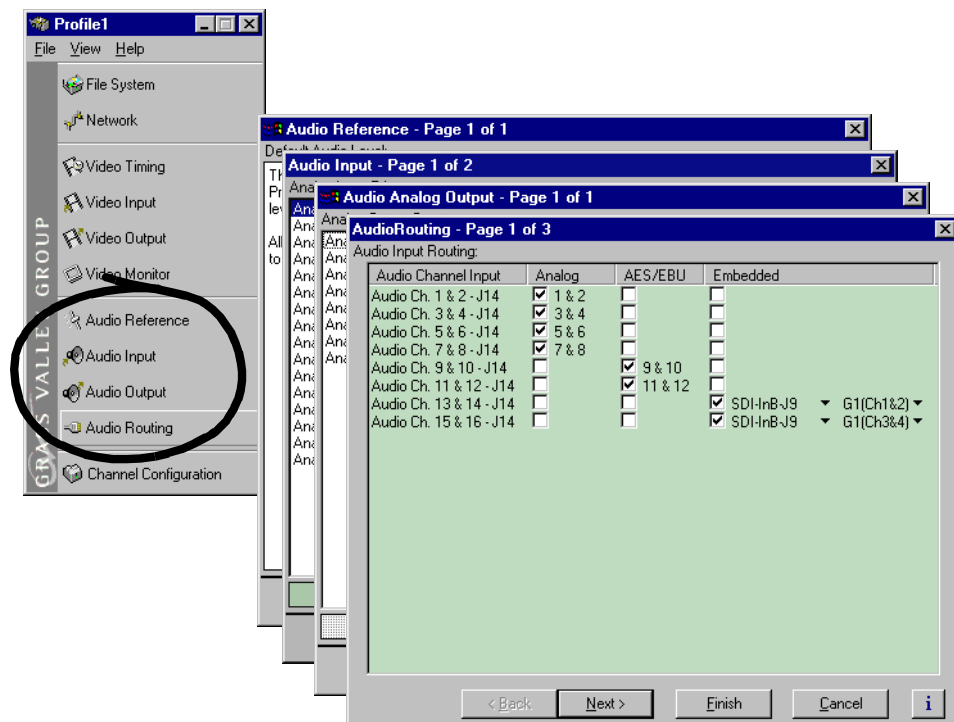



Channel Configuration

Choosing Channel Configuration in Configuration Manager opens the Channel Configuration window. Channel Configuration is used to modify or create channels that are used by Profile applications.

See Chapter 4, *Adding or Removing Channels*, for more information on using Channel Configuration.

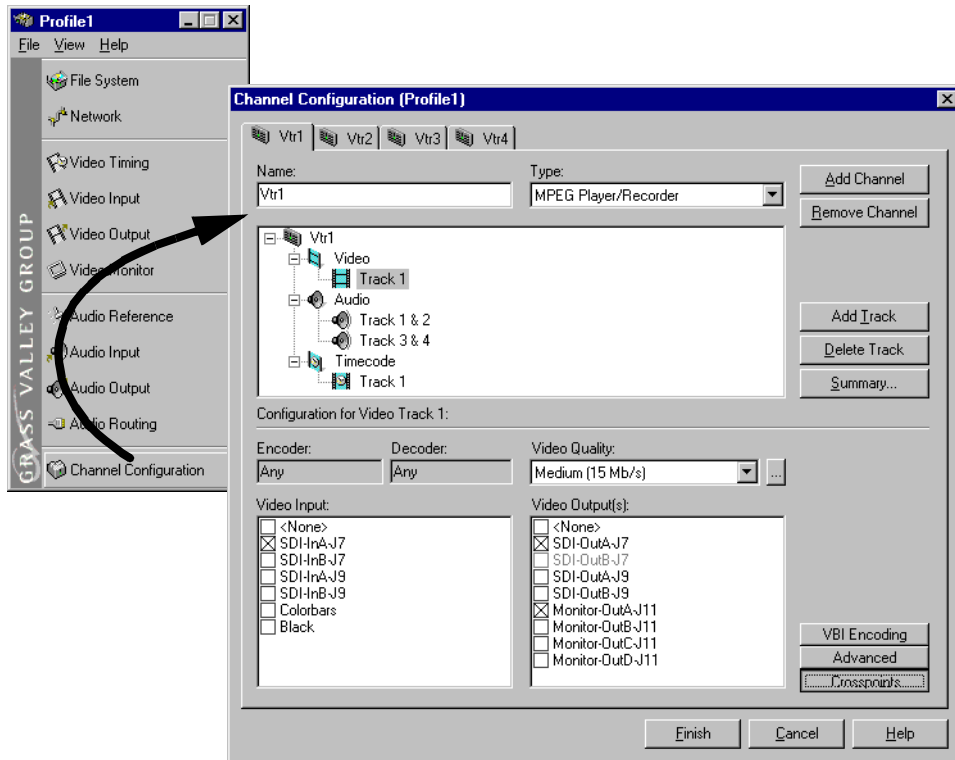

Viewing hardware settings summary dialog boxes

Use summary dialog boxes to view hardware settings in Configuration Manager. Summary dialog boxes are displayed when you click the Finish button on a configuration page. The Video Monitor Summary dialog box is shown here as an example.

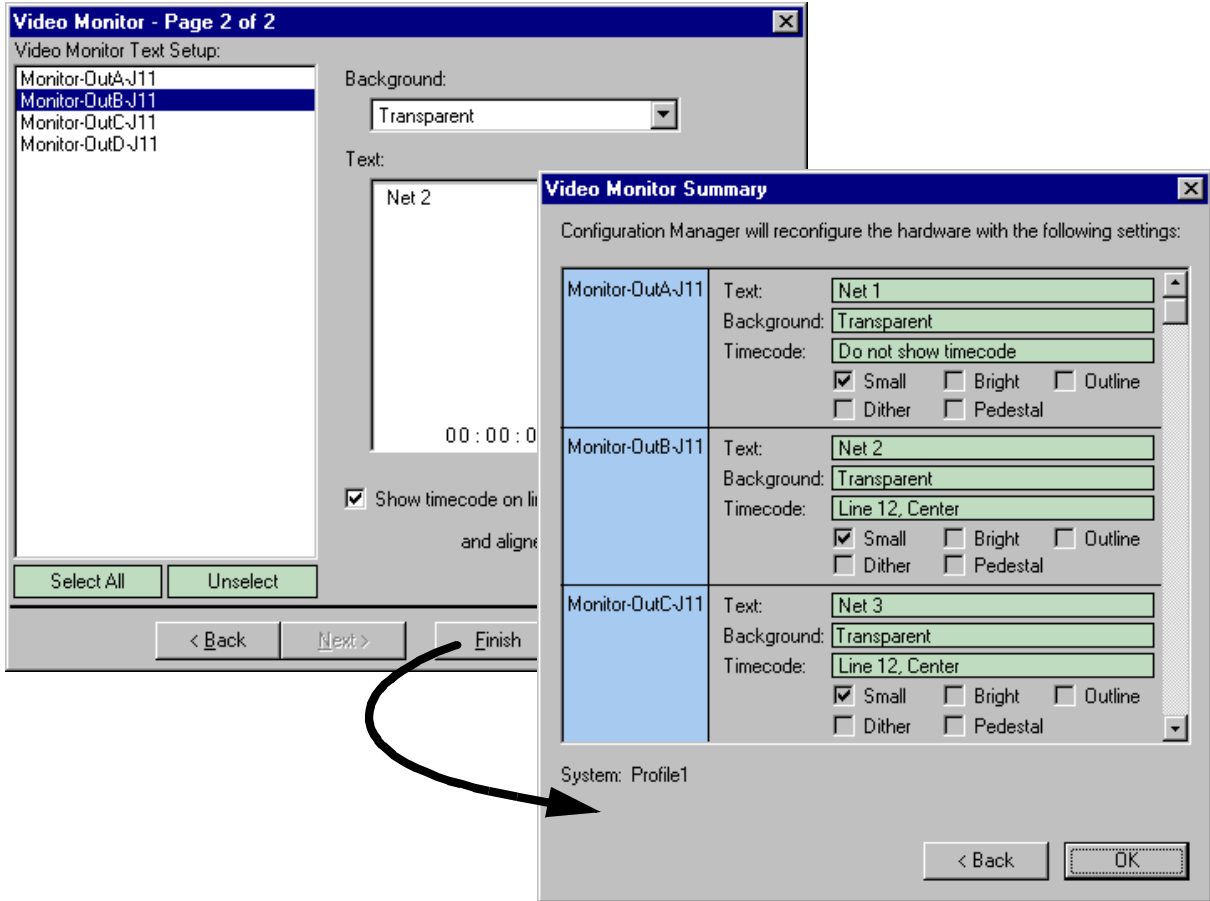

Clicking **Back** in a summary dialog box returns you to the configuration page without saving your settings. Clicking the **OK** closes the summary dialog box and saves your settings.



Show or hide summary dialog boxes

You can choose to hide the summary dialog boxes. This allows you to click the Finish button on configuration pages to store your settings without displaying the summary.

To show or hide summary dialog boxes, in the Configuration Manager **View** menu, choose **Show Summary**.

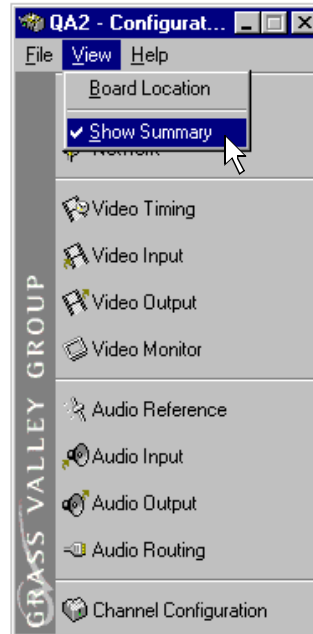

Viewing board location information

Selecting **Board Location** in the **View** menu allows you to view the location and type of circuit boards installed in your Profile XP.

To view board location information:

1. Select **View | Board Location**. The Profile Board Location window appears.

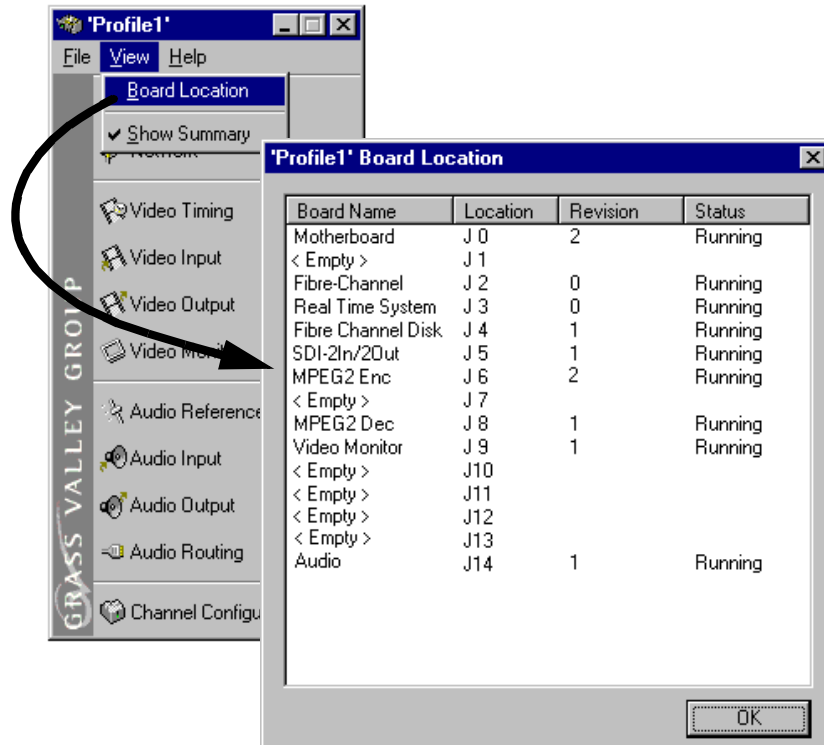

2. Click **OK** to close the window.



Saving and restoring your system settings

You can use Configuration Manager to save a copy of your hardware settings and channels in named configuration files. Later, you can easily restore settings by opening the saved configuration files. Configuration Manager also allows you to restore factory default settings.

Using the Save a copy/Open feature you can:

- Easily modify Profile XP system configuration for a different use.
- Revert to a known good configuration.
- Duplicate configurations on Profile XP systems.

Saving a copy of your system configuration

Use the **Save a Copy** command in the Configuration Manager **File** menu to save the current configuration to a named configuration file. You can choose to save the current channel and hardware settings or just channel settings by saving the appropriate file type.

To save a copy of your system configuration:

1. In Configuration Manager select, **File | Save a Copy**. The Save As dialog box appears.
2. Choose whether to save hardware and channel configuration (.cfg) or the channel configuration only (.cdf) using the **Save as type** drop down list.

NOTE: Opening a .cfg file changes both channel and hardware configuration while opening a .cdf file changes only channel configuration.

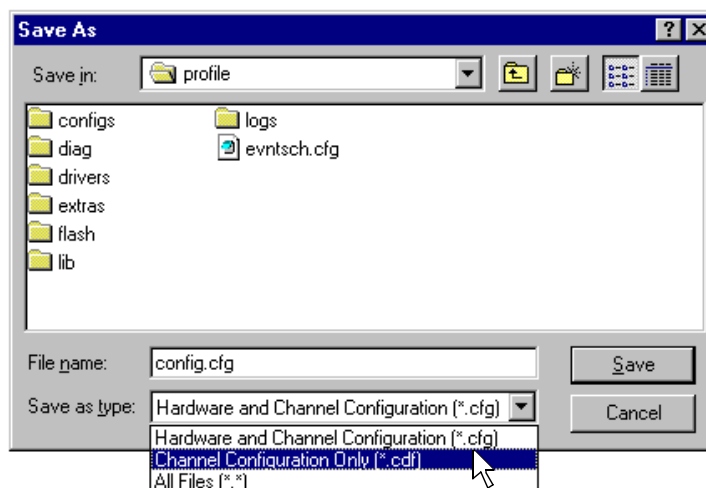

3. Enter the file name, then click **Save**. Your configuration is stored in the file you named. You may want to copy your file to floppy disk and store it in a safe place.

NOTE: You can quickly duplicate a configuration on two Profile XP systems by placing a copy of the saved configuration files on the other machine and then using the File menu Open command. See “Opening saved configuration files” on page 49.

Opening saved configuration files

You can restore system hardware settings and channels using configuration files you saved earlier. You can choose to restore the channels and hardware settings or just the hardware settings by selecting the file type to open.

NOTE: *When a configuration file is opened, the current configuration is lost. Be sure to use the “Save a copy” command in the File menu, if you want to save the current system configuration.*

To open a saved configuration:

1. In Configuration Manager, select **File | Open**. The Open dialog box appears.
2. Choose the file type you want to open, either *.cdf* or *.cfg*, using the **File of type** drop down list.

Opening a *.cdf* file changes the channel configuration settings and keeps the existing hardware settings. Opening a *.cfg* file changes both channel and hardware settings.

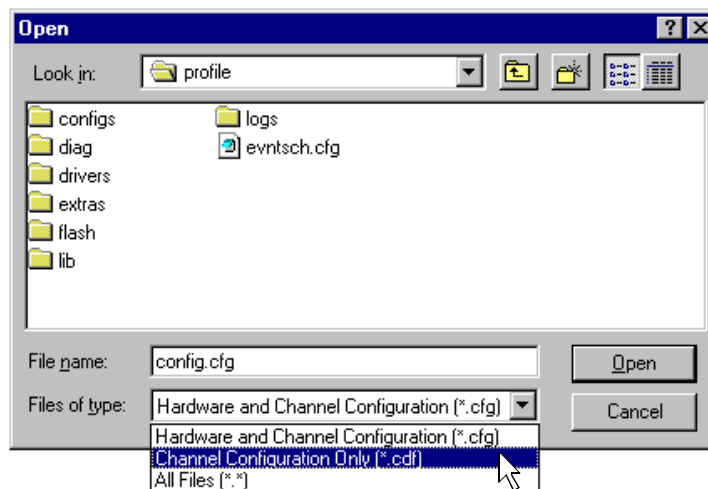

3. Find and select the file name you want to open, then click **Open**. All hardware settings take immediate effect. If you opened a *.cdf* file, the new channels are also available for you to select in Profile applications.

NOTE: *If there are hardware differences between Profile XP systems, unusable configuration items are ignored. Also, the settings for video inputs/outputs are assigned beginning with the video board closest to slot 1.*



Restoring default settings

You can quickly restore hardware settings and channel configurations back to factory defaults using the Restore Defaults command in the File menu.

NOTE: When you use Restore Defaults, the current configuration will be lost. Be sure to use the “Save a copy” command in the File menu, if you want to save the current configuration

To restore default channels and hardware settings:

1. Select **Restore Defaults** in the Configuration Manager **File** menu.
2. Choose whether to restore the channel and hardware settings or only the channel settings.

All hardware settings take immediate effect. The Channels are now available for you to select in Profile applications.

Importing and Exporting system settings

If your Profile XP systems are connected by an Ethernet network, you can import or export configurations to quickly set up two machines the same way. Imported or exported configurations take immediate effect.

NOTE: *When a new configuration is imported or exported, the current configuration is lost. Be sure to save the current configuration using the Save As command before using Import or Export.*

When you import or export a configuration, you can select whether you want to modify hardware settings, channel configuration, or both. Channel configurations are used by applications and specify what video, audio, and timecode resources makeup each channel. The hardware settings specify the video and audio hardware setup for the Profile XP system.

If there are hardware differences between Profile XP systems, unusable configuration items are ignored. Also, the settings for video inputs/outputs are assigned beginning with the video board closest to slot 1.

Exporting a configuration

Export allows you to select several remote Profile XP systems to configure at the same time.

To export a configuration:

1. In Configuration Manager, choose **File | Export**.

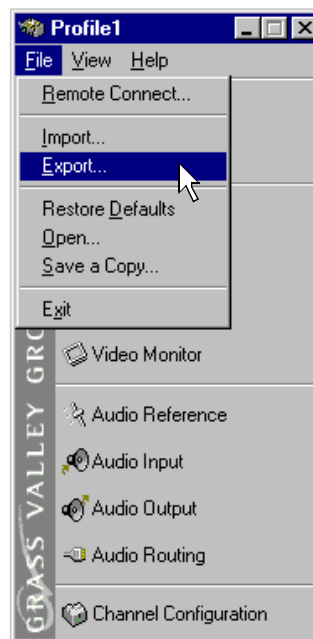



2. In the Export Configuration dialog box, select the check box for the Profile XP systems you want to configure.

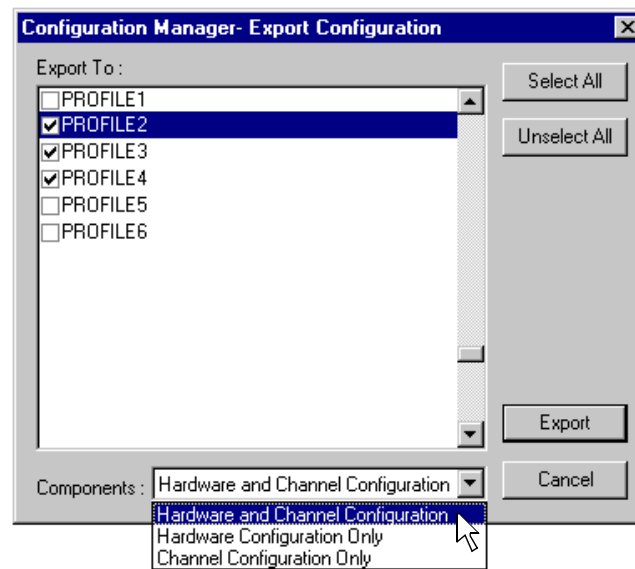

3. In the Components drop down list, select whether you want to export hardware or channel configuration, or both, then click the **Export**.

The local configuration is exported to all selected Profile XP systems.

Importing a configuration

To import a configuration:

1. In Configuration Manager, choose **File | Import**.

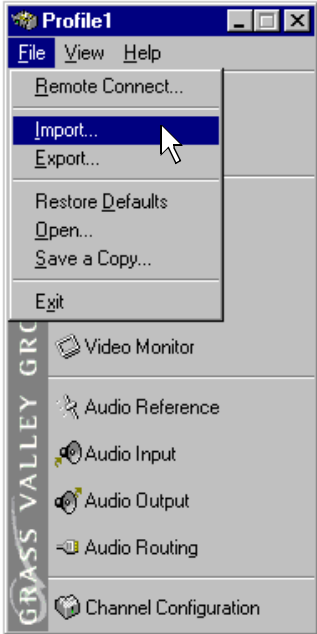



2. In the Import Configuration dialog box, select the Profile XP system from which you want to import the configuration.

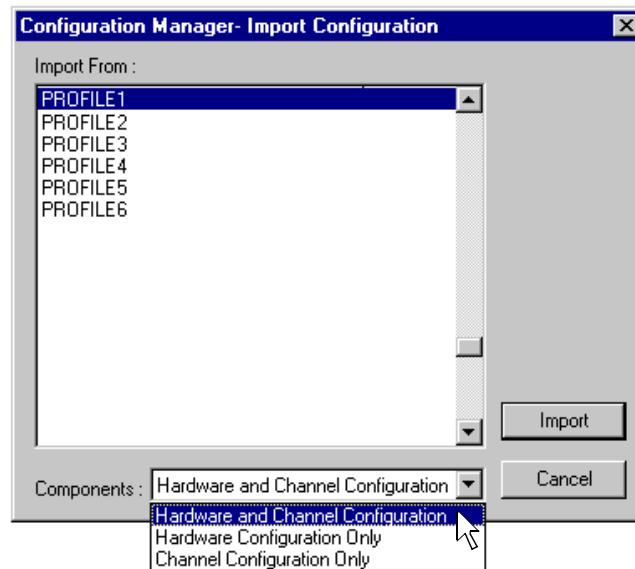

3. In the Components drop down list, select whether you want to import hardware or channel configuration, or both, then click the **Import** button.

The remote configuration is imported to the local Profile XP system.

Remote configuration: NetCentral XP Enterprise

NetCentral XP Enterprise remote monitoring software includes a remote version of Configuration Manager. After installing NetCentral XP Enterprise on a Profile XP system or a Windows NT 4.0 workstation, you can use the remote version of Configuration Manager to configure Profile XP systems over the Ethernet network.

NOTE: For more information on NetCentral XP Enterprise remote monitoring software, visit <http://www.GrassValleyGroup.com>.

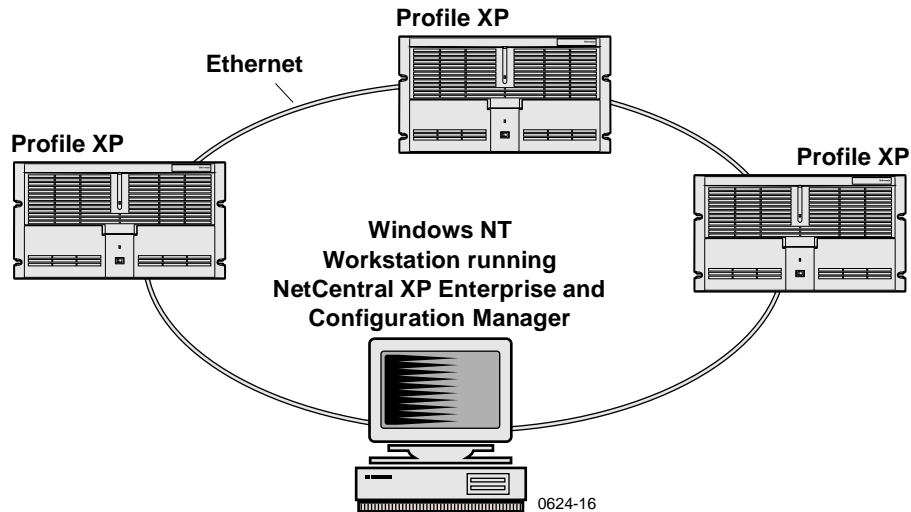

To configure remote Profile XP systems:

1. Set up the Windows NT Ethernet network using the procedures in Chapter 9, "Setting up a Simple Network", on page 197, then return to this procedure.
2. Install NetCentral XP Enterprise on the Profile XP or Windows NT workstation you want to use to monitor and configure remote Profile XP systems. Refer to the installation instructions shipped with your NetCentral XP Enterprise package.
3. Start Port Server on all Profile XP systems by double-clicking the Port Server shortcut on the desktop or choose **Start | Programs | Profile Applications | Port Server**.



4. Start Configuration Manager on the local system, then, in Configuration Manager, choose **File | Remote Connection**. The Remote Connection dialog box appears.

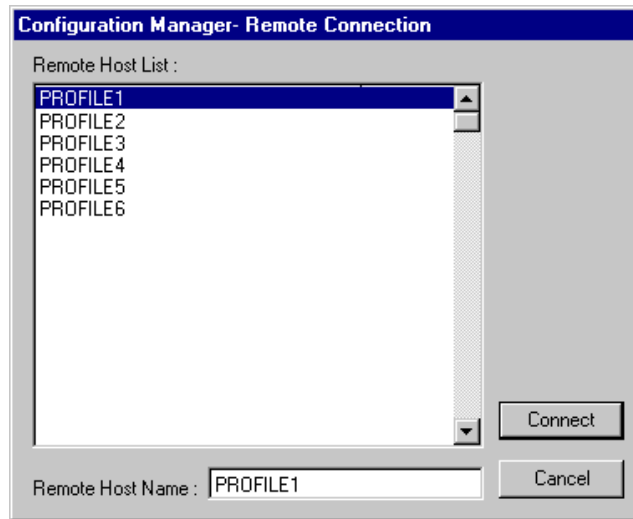

5. Select a Profile XP system in the Remote Host List, then click **Connect**. The Configuration Manager reappears. Note that the remote host now appears in the Configuration Manager title bar.

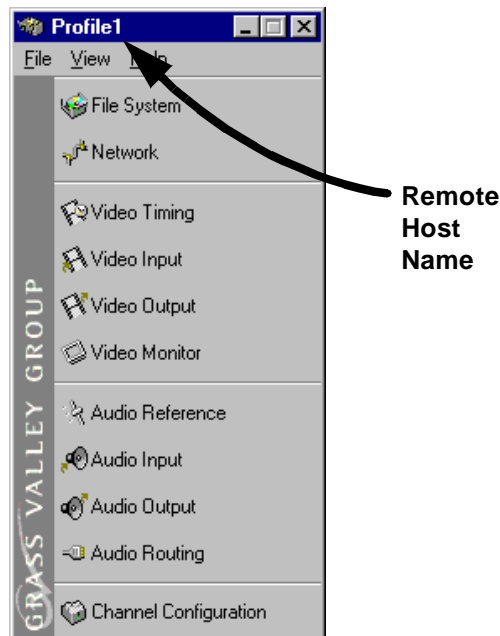

6. Configure the remote machine using Configuration Manager. Then use step 4 and step 5 to configure other remote Profile XP systems as required.

Working with Profile XP storage systems

This chapter introduces the PFC500 Fibre Channel RAID storage system and describes how to connect and configure storage on the Profile XP system. Topics included are:

- PFC500 Fibre Channel RAID Chassis key features (page 57)
- PFC500 product description (page 58)
- Storage capacity estimates (page 58)
- Maximum video data rate per channel (page 60)
- Connecting storage: Using a single PFC500 (page 61)
- Connecting storage: Using multiple PFC500s (page 64)
- Configuring storage using Disk Utility (page 69)

PFC500 Fibre Channel RAID Chassis key features

The PFC500 high performance RAID storage system provides the Profile XP a low profile, compact storage system with either 18, 36, or 73 GB fibre channel drives. The system can stay on-air with a drive, power supply, controller, or fan failure and can be repaired without taking the system off-air.

- High bandwidth Fibre Channel link to the Profile XP Media Platform
- Ten Fibre Channel drives per frame
- 18, 36, or 73 GB Fibre Channel drive options
- RAID-3 arrays configured as 4 data / 1 parity
- 3.5 RU low-profile chassis
- Optional redundant hot swappable power supply
- Optional redundant hot swappable RAID controller
- Auto failover with optional 2nd controller
- Redundant fans for cooling
- Option for hot spare drives
- Drives, power supply, RAID controller & fans are all replaceable while system is in service
- Expansion using the PFC500E, 2 per PFC500



PFC500 product description

The PFC500 is a 3.5 RU 10 drive Fibre Channel disk array with RAID drives, hot spare drives, dual power supplies (optional), redundant controllers (optional) and spare fans – all hot swappable. The PFC500 comes with either 18 GB (PFC518), 36 GB (PFC536), or 73 GB drives (PFC573).

PFC500 expansion is available using the PFC500E Expansion Chassis which houses 5 or 10 drives, but does not need a RAID controller. The PFC500's RAID controller will control up to 2 expansion frames (30 drives total). All PFC500 chassis must contain the same size disk modules to make full use of the storage capacity.

NOTE: Grass Valley Group does not support mixing disk drives of differing capacities in any RAID chassis connected to a Profile XP media platform. All disk drives in any RAID chassis connected to a Profile XP media platform must be of the same capacity. For example, if a PFC500 and a PFC500E are connected to a Profile XP system, all the disk drives in both the PFC500 and the PFC500E must be of the same capacity.

The PFC500 offers optional redundant RAID controllers for automatic failover. Failover can occur when the primary RAID Controller, Fibre Channel Port of the Profile XP, or Fibre Channel cable fails. When failover occurs, the system continues to run with minimal interruption.

For additional information on the PFC500 Fibre Channel RAID chassis and the PFC500E Expansion chassis, refer to the *PFC500 Instruction Manual*.

Storage capacity estimates

The storage capacity is determined by the number and size of disk drives in system, and the video data rate selected to record video. The PFC500 Fibre Channel RAID storage system can be configured with five to thirty disk drives, including the PFC500E Expansion chassis.

You can refer the following tables for storage capacity estimates based on the number of disk drives installed and the video data rate. The estimates in these tables are based on use of four audio channels and one time code channel per video channel using the 525 video format.

PFC500 storage capacity estimates in hours using 18 GB drives:

Video Data Rate	Number of Drives					
	5	10	15	20	25	30
4 Mbs	19	38	57	76	95	114
8 Mbs	12.5	25.4	38.2	51	63.6	76.5
12 Mbs	9.5	19.1	28.6	38.2	47.9	57.5
15Mbs	8	16.1	24.2	32.3	40.4	48.5
18 Mbs	7	14	21	28	35	42
24 Mbs	5.5	11	16.5	22	27.5	33
32 Mbs	4.2	8.4	12.6	16.8	21	25.2
40 Mbs	3.4	6.8	10.2	13.6	17	20.4
50 Mbs	2.8	5.6	8.4	11.2	14	16.8

PFC500 storage capacity estimates in hours using 36 GB drives:

Video Data Rate	Number of Drives					
	5	10	15	20	25	30
4 Mbs	37.8	75.6	113.4	151.2	189	226.8
8 Mbs	25.4	50.8	76.2	101.6	127	152.4
12 Mbs	19.1	38.2	57.3	76.4	95.5	114.6
15Mbs	16.1	32.2	48.3	64.4	80.5	96.6
18 Mbs	13.8	27.6	41.4	55.2	69	82.8
24 Mbs	10.8	21.6	32.4	43.2	54	64.8
32 Mbs	8.4	16.8	25.2	33.6	42	50.4
40 Mbs	6.8	13.6	20.4	27.2	34	40.8
50 Mbs	5.5	11	16.5	22	27.5	33

PFC500 storage capacity estimates in hours using 73 GB drives

Video Data Rate	Number of Drives					
	5	10	15	20	25	30
4 Mb/s	76.6	153.2	229.9	306.4	383.1	459.6
8 Mb/s	51.4	102.8	154.4	205.6	257.3	308.4
12 Mb/s	38.7	77.4	116.1	154.8	193.5	232.2
15 Mb/s	32.6	65.3	97.9	130.5	163.1	195.7
24 Mb/s	22.2	44.3	66.4	88.6	110.7	132.9
30 Mb/s	18.2	36.5	54.7	72.9	91.1	109.4
40 Mb/s	14.1	28.1	42.2	56.2	70.3	84.3
50 Mb/s	11.4	22.9	34.3	45.7	57.1	68.5
65 Mb/s	8.8	17.6	26.3	35.1	43.9	52.6



Maximum video data rate per channel

The maximum video data rate per channel depends on the Profile XP model, the number of PFC500 chassis connected, and the number of disk drives in the system.

The Profile XP system accesses the disk array through the PFC500's RAID Controller board. As video data rates and number of channels in operation increase, the bandwidth of a single RAID controller board may be exceeded. Some Profile XP models require at least two or three PFC500s to satisfy the bandwidth required.

The table shows the minimum storage configuration required for your Profile XP model for different video data rates.

Profile XPMoDel	Number of Channels	Video Data Rate Per Channel*					
		8Mbs	12Mbs	15Mbs	24Mbs	30Mbs	50Mbs
PVS1022	4	5 drives 1 PFC500	5 drives 1 PFC500	5 drives 1 PFC500	10 drives 1 PFC500	15 drives 1 PFC500	20 drives 2 PFC500
PVS1024	6	5 drives 1 PFC500	10 drives 1 PFC500	10 drives 1 PFC500	15 drives 1 PFC500	20 drives 1 PFC500	30 drives 3 PFC500
PVS1044 PVS1026 PVS1062 PVS1008	8	10 drives 1 PFC500	10 drives 1 PFC500	10 drives 1 PFC500	20 drives 1 PFC500	20 drives 2 PFC500	30 drives 3 PFC500

*2 channels audio and 1 timecode channel. Does not take into account video network transfers. PFC500 refers to PFC518 or PFC536.

You can select the video data rate the Profile XP system uses to record the video signal. When selecting video data rates, be sure not to exceed the total maximum system bandwidth. Fibre channel transfers, archive operations, and high bandwidth recording or playout may require that you reduce the data rate on other channels or operate fewer channels at one time. Although playout and recording take priority over other operations, exceeding your Profile XP system bandwidth may result in record or playback problems. For information on setting the video data rate, refer to "Selecting video quality for a channel" on page 118.

Connecting storage: Using a single PFC500

This section describes how to connect and set up Profile XP storage using a single PFC500 Fibre Channel RAID Chassis and optional PFC500E expansion chassis. After completing the procedures in this section, you must configure the PFC500 System. See “Configuring storage using Disk Utility” on page 69.

To connect storage using a single PFC500:

1. Connect fibre channel cabling as shown in the figure.

The figure shows how Port B on the Profile XP system is used to provide a connection to the optional redundant controller in PFC500's. This provides a redundant connection to the Fibre Channel RAID drives in the event a failure occurs on the primary controller board attached to Port A. When failover occurs, the system continues to run with minimal interruption.

Connect fibre channel cabling.

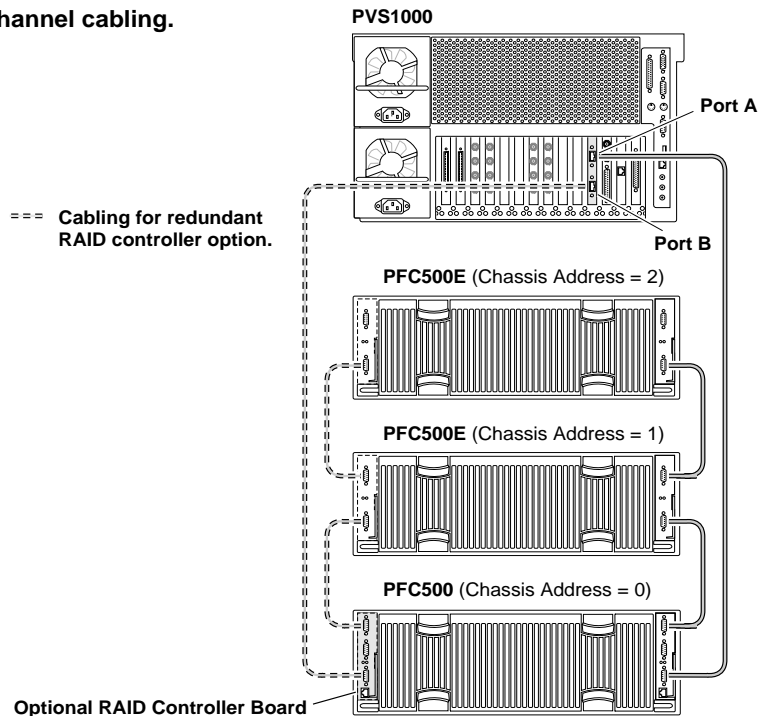

Set required chassis addresses as labeled above.

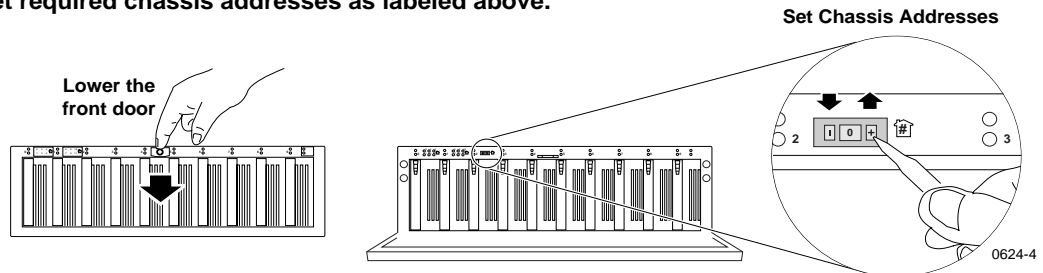

2. Set the chassis addresses on the PFC500 and each PFC500E chassis (if installed) as shown in the figure. The PFC500 chassis address must be set to 0.



3. Connect PFC500(E) power cords and turn on power as shown. Begin with the PFC500Es, if installed.

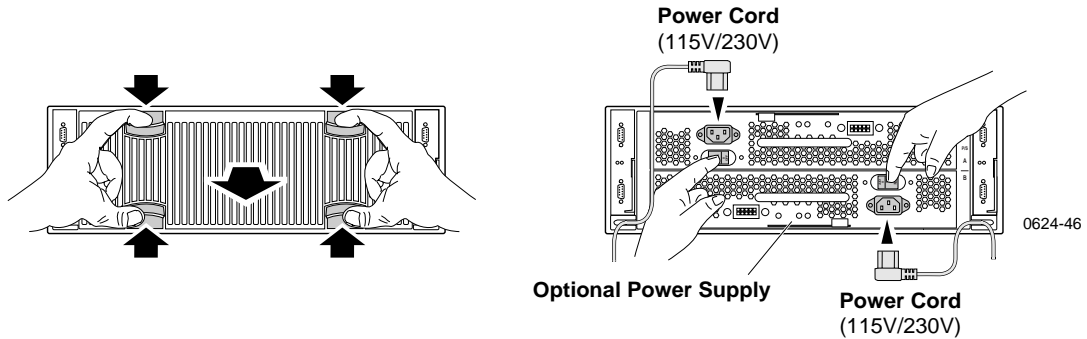

4. Verify that the **System Check LED** is out on the PFC 500 Fibre Channel RAID Chassis and all PFC500E Expansion Chassis, if installed. Refer to the *PFC 500 Instruction Manual* for more information if the System Check LED remains lit.

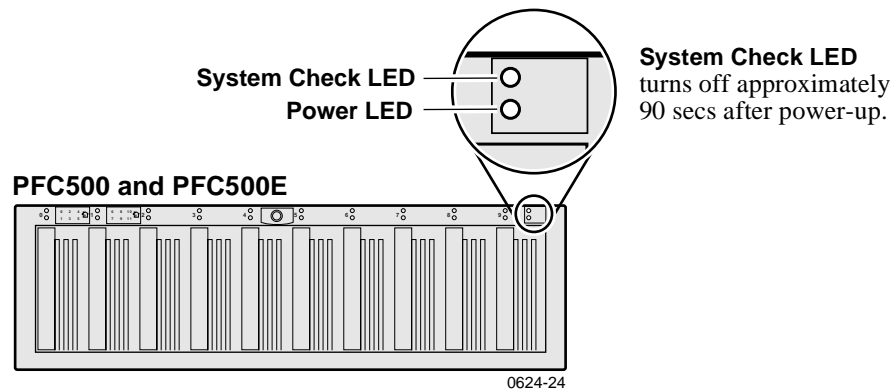

5. Turn on power to all peripheral devices connected to the Profile XP Media Platform.

NOTE: Do not power-on the Profile XP system until the PFC500 Fibre Channel RAID storage system is fully initialized; approximately 2-3 minutes.

6. Connect Profile XP system power cord as shown, and turn on the front panel standby switch.

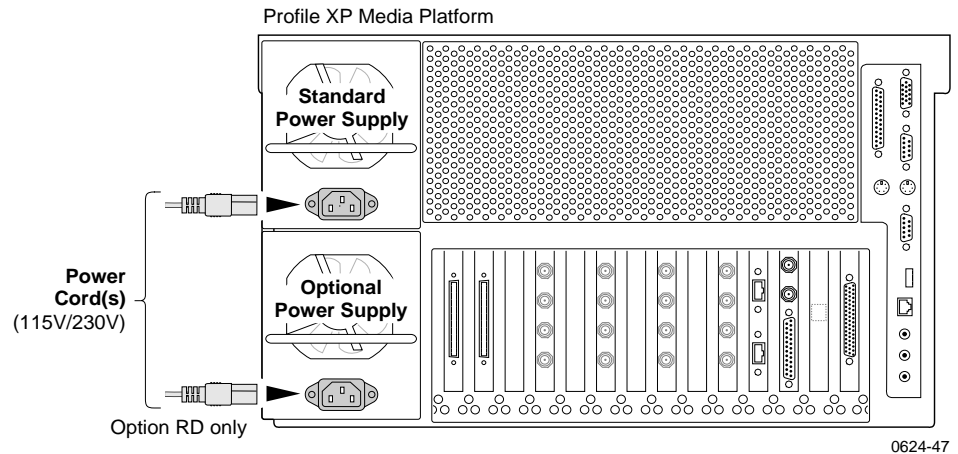

7. Wait for Windows NT to initialize and perform auto-logout. The Windows NT desktop will appear after successful auto-logout.

During initialization, the Profile XP system software checks the PFC500 storage system for a valid video file system. If one is not found, a warning message is displayed. A valid file system is required for Profile Applications to start.

8. Do one of the following:

- If this is the first time power-up of the system, you must configure the PFC500 system. Proceed by following the procedures in “Configuring storage using Disk Utility” on page 69.
- If you know you have a valid file system, and one is not found, first make sure all PFC chassis are connected, powered-up, and fully initialized. If this does not help, refer to the *Profile XP Service Manual* and the *PFC500 Instruction Manual* for help in isolating the problem.

NOTE: Always make sure all chassis in the PFC500 storage system are powered-on and fully initialized (2-3 minutes) before powering on the Profile XP system or restarting Windows NT. Failure to do so will prevent the Profile XP system from having access the media files stored on the PFC500 storage system.



Connecting storage: Using multiple PFC500s

This section describes how to connect and set up Profile XP storage using multiple PFC500s and optional PFC500E expansion chassis. Connecting multiple PFC500 Fibre Channel RAID chassis increases storage capacity and bandwidth. After completing the procedures in this section, you must configure the PFC500 System. See “Configuring storage using Disk Utility” on page 69.

Addressing requirements

There are two addresses for the PFC500: the Fibre Channel Arbitrated Loop address ID and the chassis address.

Fibre Channel Loop address ID

Each device on a Fibre Channel loop must have a unique Fibre Channel address ID. You must set the Fibre Channel address ID for the PFC500 using switches on the RAID Controller board, as explained later in this procedure. If your PFC500 has a second, redundant RAID Controller board, it should be set to a different Fibre Channel address ID than the primary RAID Controller board.

Chassis address (CA)

Each PFC500 and PFC500E needs a unique chassis address that identifies the chassis and determines disk module addresses. All PFC500s must have a chassis address of 0. You must set the chassis address using the chassis address switches, as explained later in this procedure. If you cable any PFC500Es to the PFC500, you might want to set the nearest PFC500E's chassis address to 1, and the next to 2. The chassis address is displayed in lights visible behind the front door.

To connect storage using multiple PFC500s:

1. At the back of the PFC500 chassis, remove each RAID Controller from its slot and check the switches as shown in the figure.

If you do not have the redundant RAID controller option, only one RAID controller is installed.

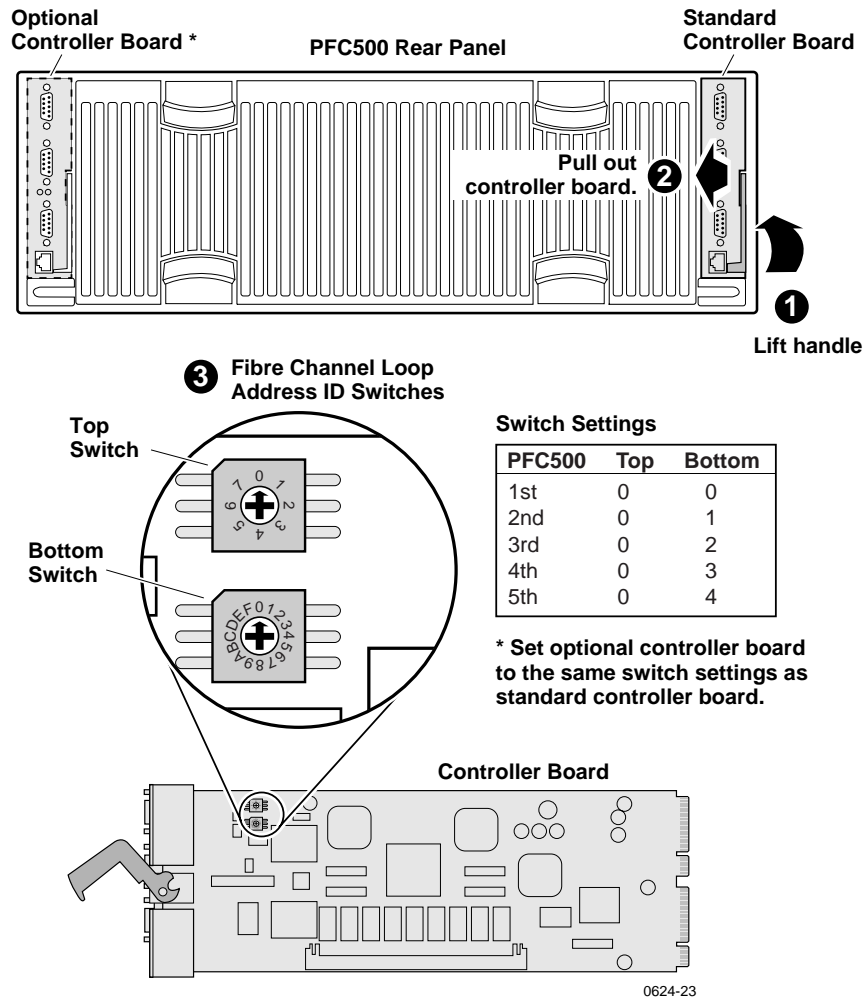

2. Set the Fibre Channel address ID on the RAID controllers for all PFC500s connected as indicated in the following table.

Number of PFC500s	PFC 500 chassis	Primary controller address ID	Redundant controller address ID
1	First	0	1
2	First	0	2
	Second	1	3
3	First	0	3
	Second	1	4
	Third	2	5

3. Fabricate labels and attach them to the rack next to each PFC500 to indicate the Fibre Channel address ID. This helps in fault isolation in the event disk drive status messages appear during operation.



- 4. Connect Fibre Channel cabling as shown in the figure.

The figure shows how Port B on the Profile XP system is used to provide a connection to the optional redundant controllers in PFC500's. This provides a redundant connection to the Fibre Channel RAID drives in the event a failure occurs on the controller card attached to Port A. When failover occurs, the system continues to run with minimal interruption.

Connect fibre channel cabling.

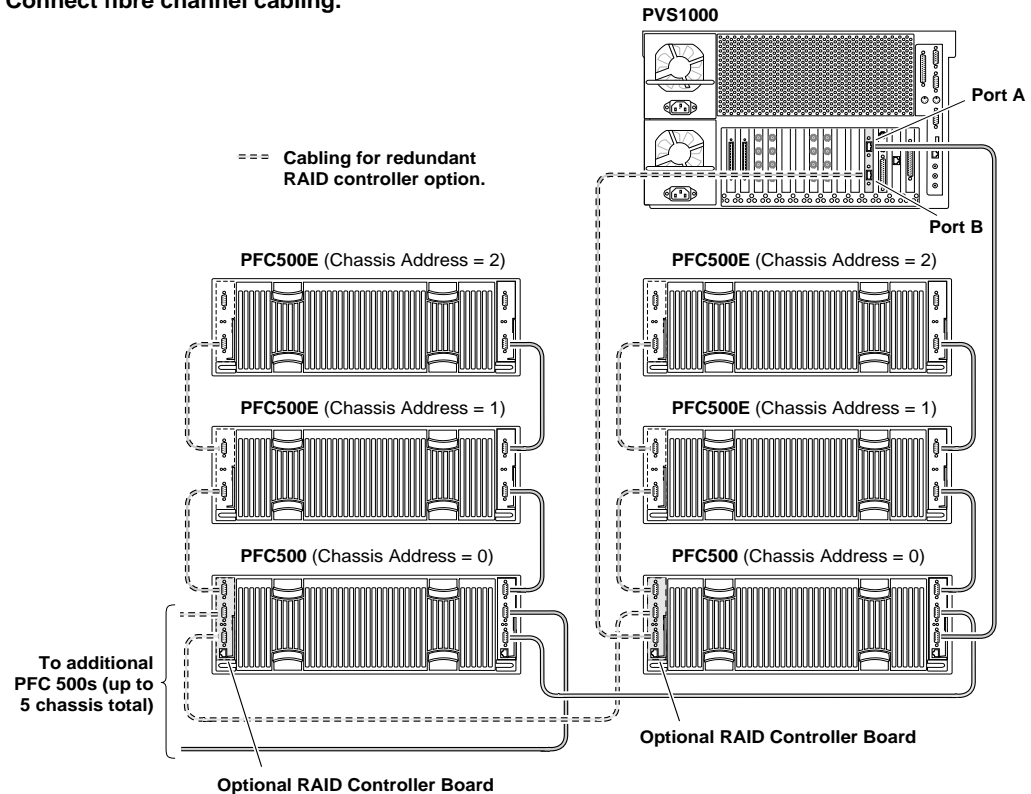

Set required chassis addresses as labeled above.

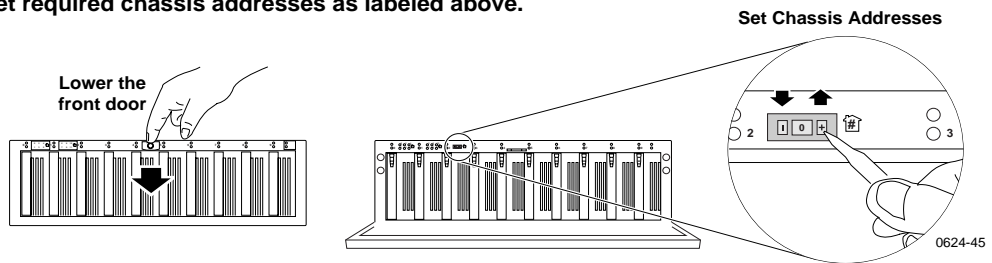

- 5. Set the chassis addresses on each PFC 500 and PFC 500E chassis (if installed) as shown in the figure. The chassis address of each PFC 500 must be set to 0.

If you cable any PFC 500Es to the PFC 500s, you might want to set the nearest PFC 500E's chassis address to 1, and the next to 2. When powered-on, the chassis addresses are indicated on the front panel.

6. Connect PFC500(E) power cords and turn on power as shown. Begin with the PFC500Es, if installed.

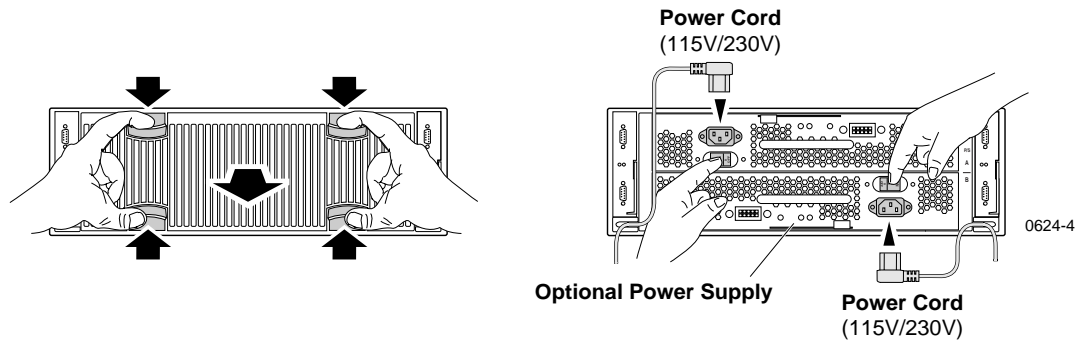

7. Verify that the **System Check LED** is out on the PFC 500 Fibre Channel RAID Chassis and all PFC500E Expansion Chassis, if installed. Refer to the *PFC 500 Instruction Manual* for more information if the System Check LED remains lit.

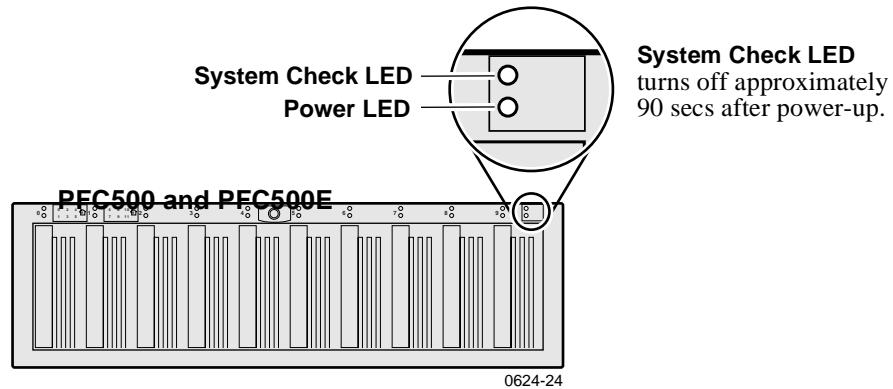

8. Turn on power to all peripheral devices connected to the Profile XP Media Platform.

NOTE: Do not power-on the Profile XP system until the PFC500 Fibre Channel RAID storage system is fully initialized; approximately 2-3 minutes.



9. Connect Profile XP system power cord as shown, and turn on the front panel standby switch.

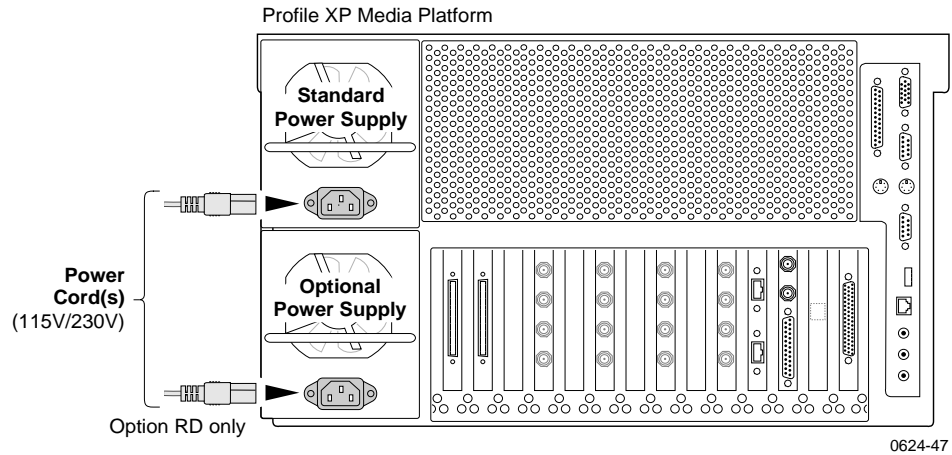

10. Wait for Windows NT to initialize and perform auto-logon. The Windows NT desktop will appear after successful auto-logon.

During initialization, the Profile XP system software checks the PFC500 storage system for a valid video file system. If one is not found, a warning message is displayed. A valid file system is required for Profile Applications to start.

11. Do one of the following:

- a. If this is the first time power-up of the system, you must configure the storage system. Proceed by following the procedures in “Configuring storage using Disk Utility” on page 69.
- b. If you know you have a valid file system, and one is not found, first make sure all PFC chassis are connected, powered-up, and fully initialized. If this does not help, refer to the *Profile XP Service Manual* and the *PFC500 Instruction Manual* for help in isolating the problem.

NOTE: Always make sure all chassis in the PFC500 storage system are powered-on and fully initialized (2-3 minutes) before powering on the Profile XP system or restarting Windows NT. Failure to do so will prevent the Profile XP system from having access the media files stored on the PFC500 storage system.

Configuring storage using Disk Utility

After connecting the PFC 500 storage system to the Profile XP Media Platform, you must use the Disk Utility to bind the storage system's disk modules into logical units (LUNs) and create a video file system that is recognizable by the Profile XP Media Platform.

This section includes the following:

- About configuring storage (page 69)
- Configuring storage without hot spare drives (page 71)
- Configuring storage to include hot spare drives (page 75)
- Changing the volume name (page 80)
- Expanding storage (page 83)
- Determining which disk modules make up a LUN (page 85)

About configuring storage

This section describes terms and concepts related to configuring your the PFC 500 storage system. Topics include:

- Binding disk modules
- Unbinding disk modules
- Creating a video file system
- Expanding Storage
- File system volume name
- Using Hot Spare disks

Binding disk modules

Binding the disk modules hardware formats them into a logical units called LUNs. The disks that make up a LUN are accessed as a contiguous disk space. Disk modules must be bound before they can be part of the video storage file system.

You can use the Profile XP Disk Utility to bind disks modules as Data LUNs (RAID-3 containing 4 data disks and 1 parity disk) or as hot spare LUNs, depending on the storage needs of your system.

A PFC chassis can contain up to 10 drives. For simplicity, the Disk Utility automatically groups consecutive disk modules into unbound LUNs, that is, disks 0-4 and 5-9 are grouped as unbound LUNs. To help in finding the physical location of a LUN in large systems, refer to "Determining which disk modules make up a LUN" on page 85.

After binding, disk modules become slot specific and cannot be moved to other disk module slots.



Unbinding disk modules

Unbinding reverses the bind process, changing a LUN into an unbound LUN. Unbinding is required only when changing LUN types, for example, reconfiguring a hot spare LUN as a data LUN.

NOTE: *Unbinding destroys all user media files stored on the disk modules.*

Creating a video file system

The PFC 500 storage system must contain a video file system recognizable by the Profile XP Media Platform system. When you choose to make a new video file system, the Disk Utility creates one video file system using all available data LUNs. All hot spare LUNs and Unbound LUNs are ignored.

NOTE: *Creating a video file system destroys the existing file system and all user media files stored on the disk modules.*

Expanding Storage

You can expand storage by installing additional disk modules in empty disk slots or by connecting additional PFC 500 or PFC 500E chassis. To use the additional storage, you must bind the new disk modules and create a new video file system.

The disk modules you use in a LUN must all have the same capacity to fully use the modules' disk space. The same applies to LUNs. Make sure all LUNs have the same capacity to fully use the LUN's disk space.

File system volume name

The video file system volume name is the logical name used when accessing the storage system. All local and remote Profile XP applications use the volume name when referencing the video file system.

You can change the video file system volume name at any time without affecting the media files stored on the system. Changing the volume name may be required with some third party Profile XP control software which requires a specific volume name.

Using Hot Spare disks

You can bind an unbound LUN as a hot spare LUN. Drives in a hot spare LUN are available for automatic failover in the event a disk module fails in a data LUN. When the failed disk module is replaced, the RAID controller copies the hot spare drive data to the replacement drive, then returns the hot spare drive back to hot spare status.

If the drives you want to designate as hot spares are bound as part of a data LUN, you must unbind the drives first, then bind them as hot spares. A hot spare LUN can contain 1 to 5 disk modules. Hot spare drives are available only to the RAID Controller in the PFC 500 controlling them.

Configuring storage without hot spare drives

In order to use the Profile XP system, you must use Disk Utility to configure the PFC500 Fibre Channel RAID storage system.

Creating a video file system involves:

- Binding any unbound disk modules
- Creating and naming the video file system

NOTE: If you want to use hot spare drives in your system, do not perform this procedure. Instead, perform the procedures in “Configuring storage to include hot spare drives” on page 75.

To configure the PFC500 storage system:

1. Start Configuration Manager using the desktop shortcut or by selecting **Start | Programs | Profile Apps | Configuration Manager**. The Configuration Manager dialog box appears.

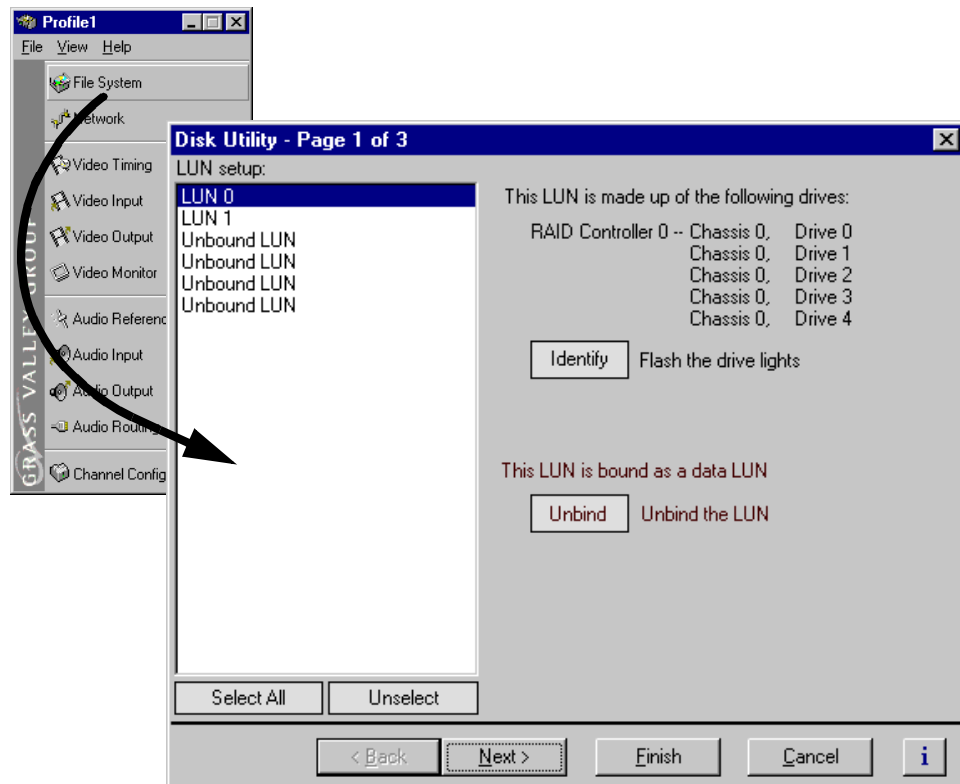

2. Click **File System** in the Configuration Manager window. Page 1 of the Disk Utility dialog box appears.

NOTE: For simplicity, this example shows only a 30 disk system in the Disk Utility.



3. If there are Unbound LUNs displayed in the LUN setup list, perform the following steps, otherwise, proceed to step 4.
 - a. Select all Unbound LUNs using **SHIFT** or **CTRL** and click.
 - b. Verify the LUN type selected is **Data**.

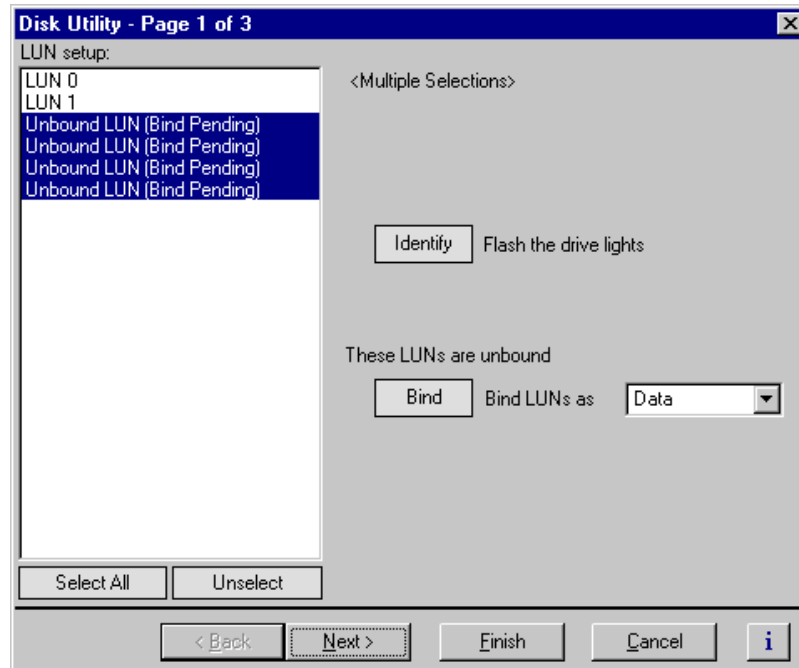

- c. Click **Bind**, then click **OK** in the dialog box.

The list now shows the Unbound LUN status as Bind Pending.

4. Click **Next** to navigate to page 2 of 3, then enter the file system volume name, or use the default name.

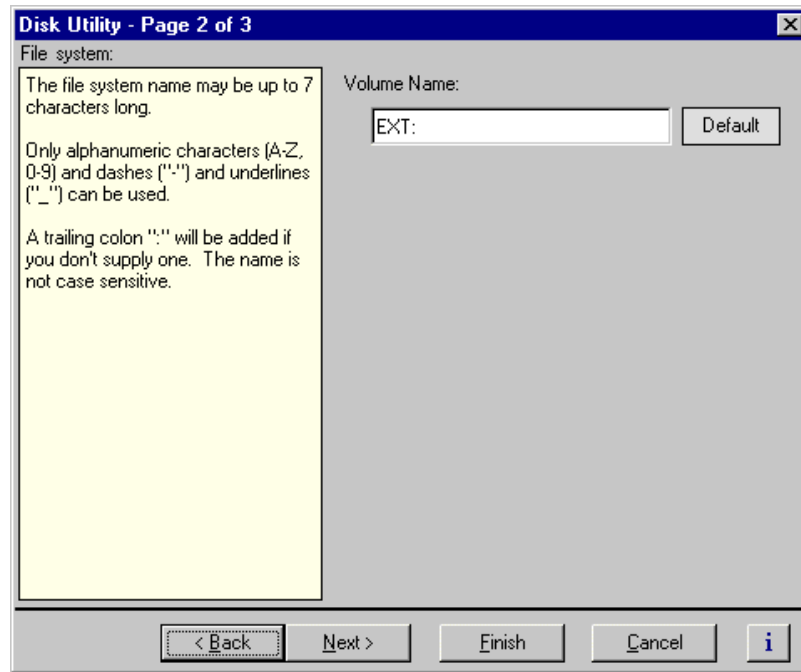



5. Click **Finish**. The summary dialog box appears.

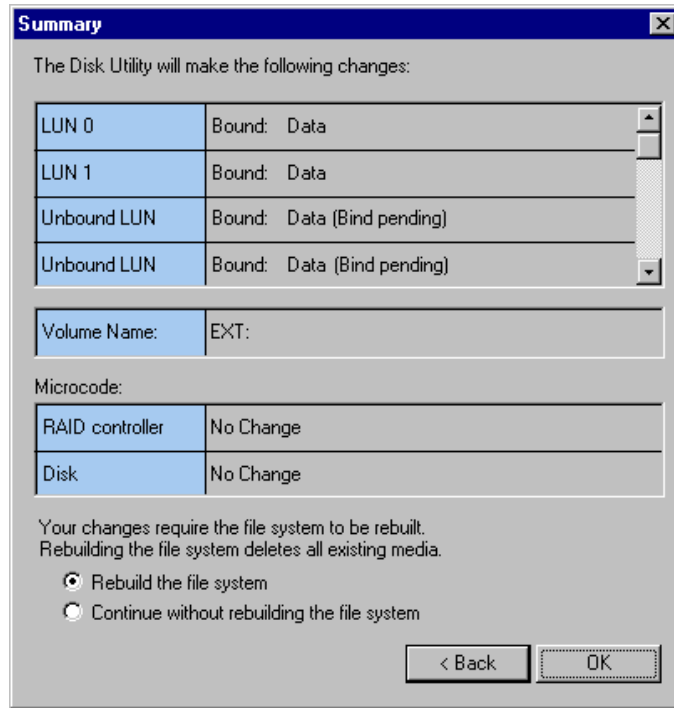

6. Select **Rebuild the file system**, then click **OK** in the Summary dialog box.

7. Read the warning message, then click **OK** to bind all unbound LUNs and create a file system.

- Binding 18 GB drives - approximately one hour
- Binding 36 GB drives - approximately two hours
- Binding 73 GB drives - approximately four hours
- Creating a file system - if you have no unbound LUNs, creating the file system takes only a few seconds.

When the operation is complete, the Profile XP system is ready for testing.

Configuring storage to include hot spare drives

Before using your Profile XP system, you must use the Disk Utility to configure the PFC500 storage system. Configuring the storage system involves:

- Binding any unbound LUNs
- Creating and naming a video file system

When you configure storage, you can also designate drives as hot spare drives. Hot spare drives are used in the event of a drive failure in a data LUN. If a drive failure occurs, the RAID Controller automatically selects a hot spare drive to use in place of the failed drive. When the failed disk module is replaced, the RAID controller copies the hot spare drive data to the replacement drive, then returns the hot spare drive back to hot spare status.

If the drives you want to designate as hot spares are bound as part of a data LUN, you must unbind the drives first, then bind them as hot spares. A hot spare LUN can contain 1 to 5 drives. Hot spares drives are available only to RAID Controller to which they are connected.

Perform the following procedure if you are configuring PFC 500 storage systems to include hot spare drives.



To configure the PFC500 storage system to include hot spare drives:

1. Start Configuration Manager using the desktop shortcut or by selecting **Start | Programs | Profile Apps | Configuration Manager**. The Configuration Manager dialog box appears.

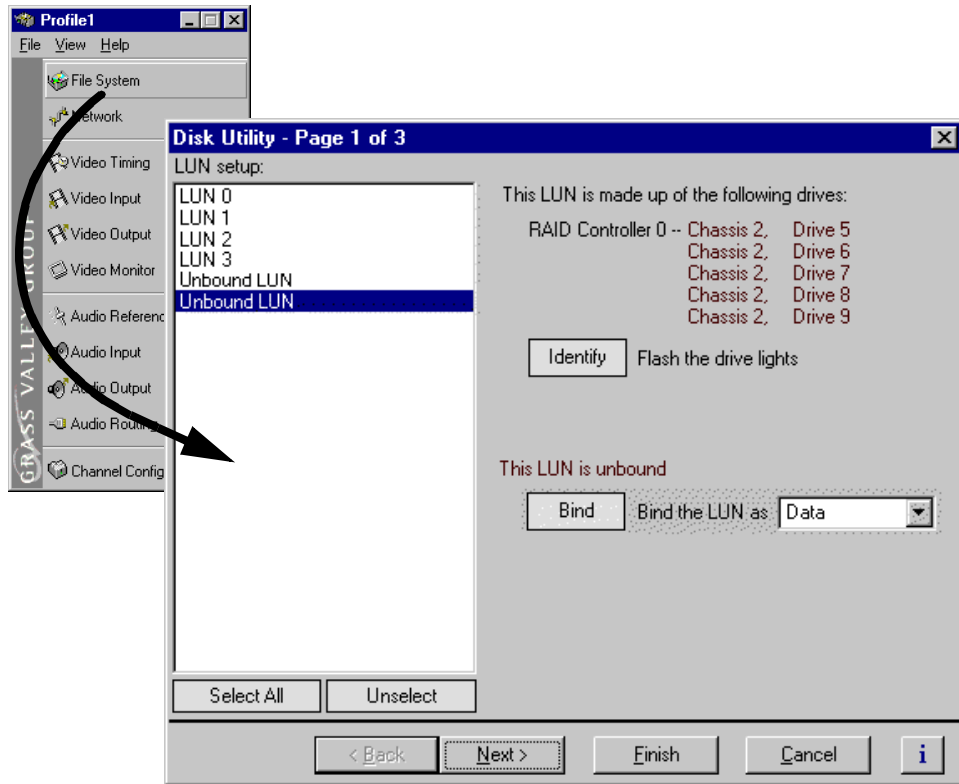

2. Click **File System** in the Configuration Manager window. Page 1 of the Disk Utility dialog box appears.

NOTE: For simplicity, this example shows only a 30 disk system in the Disk Utility.

3. Bind drives as hot spares using the following steps:
 - a. Select an unbound LUN to use for hot spare drives.

If the drives you want to designate as hot spares are bound as part of a data LUN, click **Unbind** to change them to unbound status, then **Bind**.
 - b. Use the drop-down list to set the LUN type to Hot Spare.

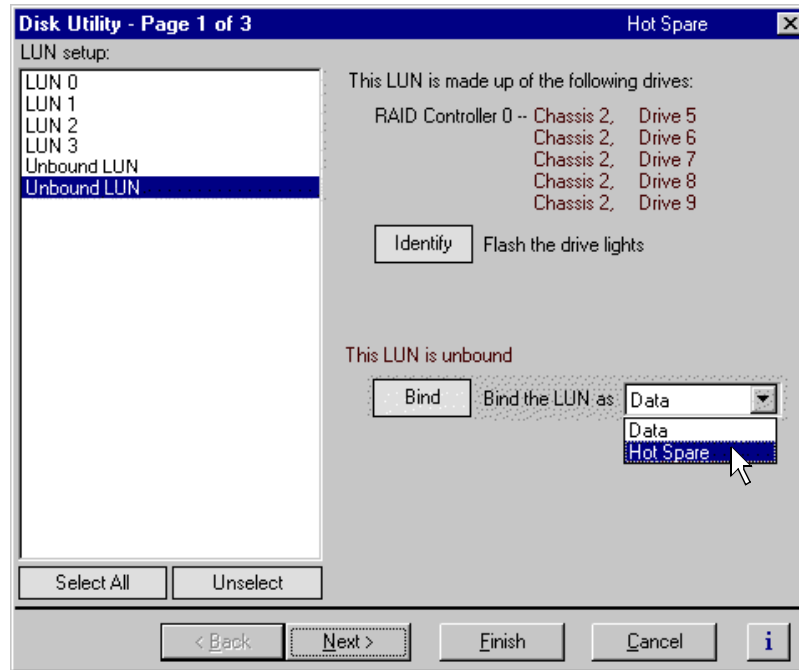

- c. Click **Bind**, then click **OK** in the dialog box.

“Bind Pending” appears next to the unbound LUN.
 4. If there are unbound LUNs remaining in the LUN setup list, perform the following steps, otherwise, proceed to step 4.
 - a. Select all Unbound LUNs. Use **SHIFT** or **CTRL** and click.
 - b. Verify the LUN type selected is **Data**.
 - c. Click **Bind**, then click **OK** in the dialog box.

The list now shows the Unbound LUN status as “Bind Pending”.



4. Click **Next** to navigate to page 2 of 3.

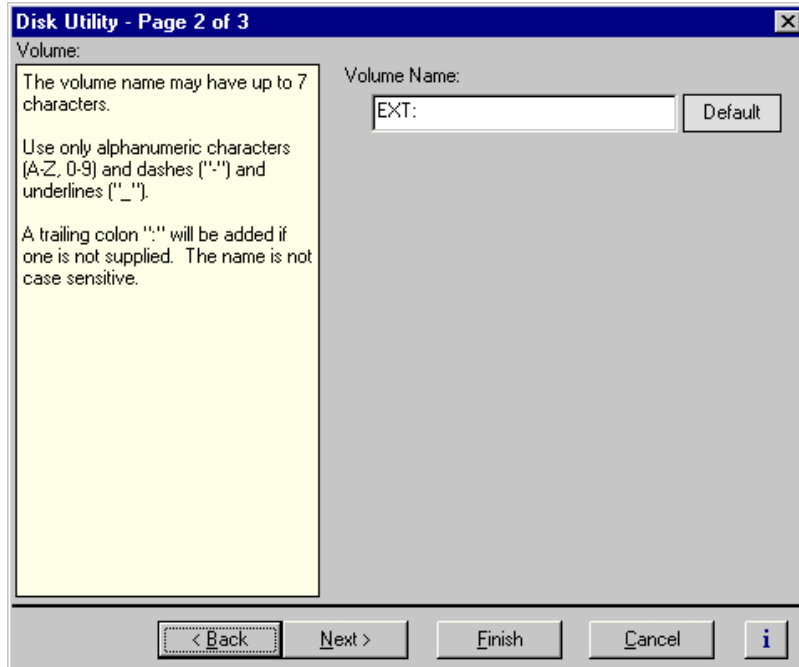

5. Enter the file system volume name, or use the default name.
6. Click **Finish**. The summary dialog box appears.

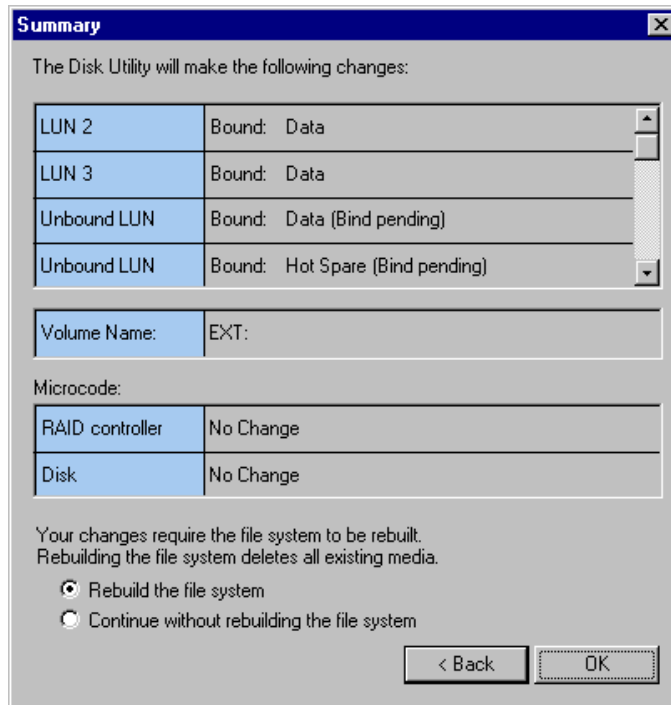

7. Select one of the following:
 - If you are only adding hot spare drives, select **Continue without rebuilding the file system**.
 - If you are adding hot spare drives and binding new data LUNs, select **Rebuild the file system**.
8. Click **OK** in the Summary dialog box.
9. Read the warning message, then click **OK** to bind all unbound LUNs and create a file system.
 - Binding 18 GB drives - approximately one hour
 - Binding 36 GB drives - approximately two hours
 - Binding 73 GB drives - approximately four hours
 - Creating a file system - if you have no unbound LUNs, creating the file system takes only a few seconds.

When the operation is complete, the Profile XP system is ready for testing.



Changing the volume name

You can change the video file system volume name at any time without affecting the media files stored on the system. Changing the volume name may be required with some third party Profile XP control software which requires a specific volume name.

To change the files system volume name:

1. Start Configuration Manager using the desktop shortcut or by selecting **Start | Programs | Profile Apps | Configuration Manager**. The Configuration Manager dialog box appears.
2. Click **File System** in the Configuration Manager window. Page 1 of the Disk Utility dialog box appears.

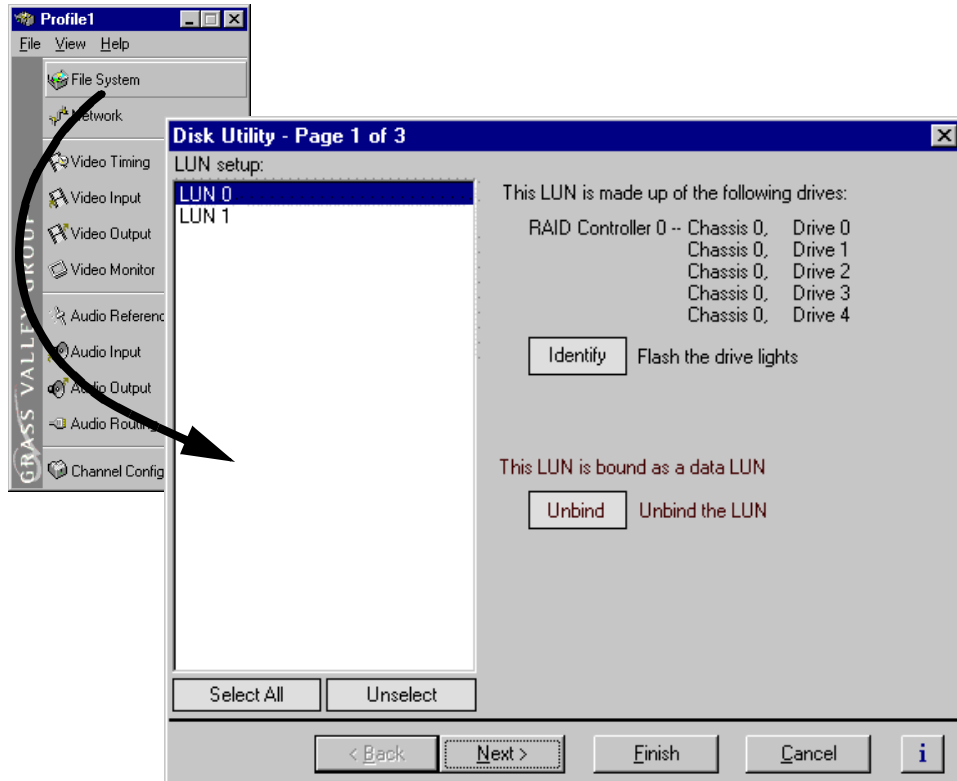

3. Click **Next** to navigate to page 2 of 3, then enter the file system volume name.

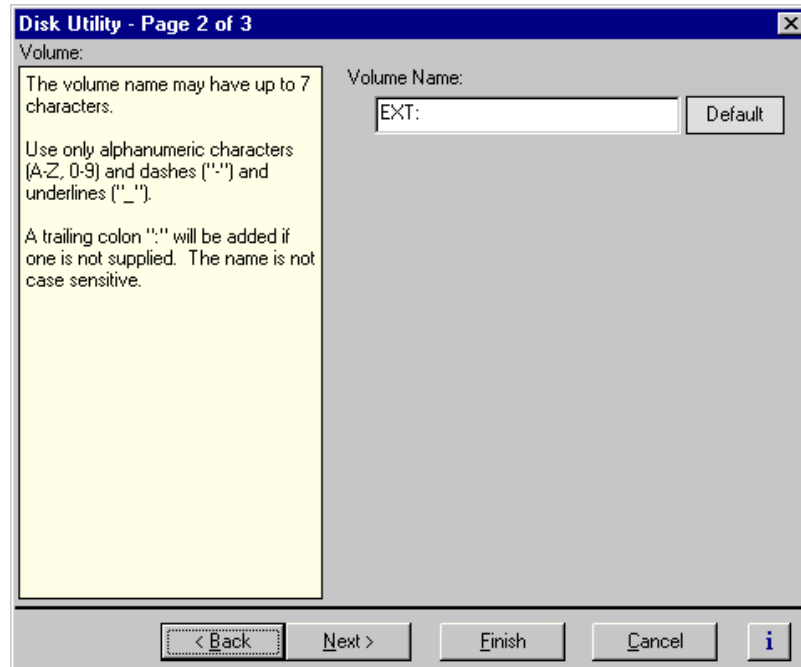



- Click **Finish**. The summary dialog box appears.

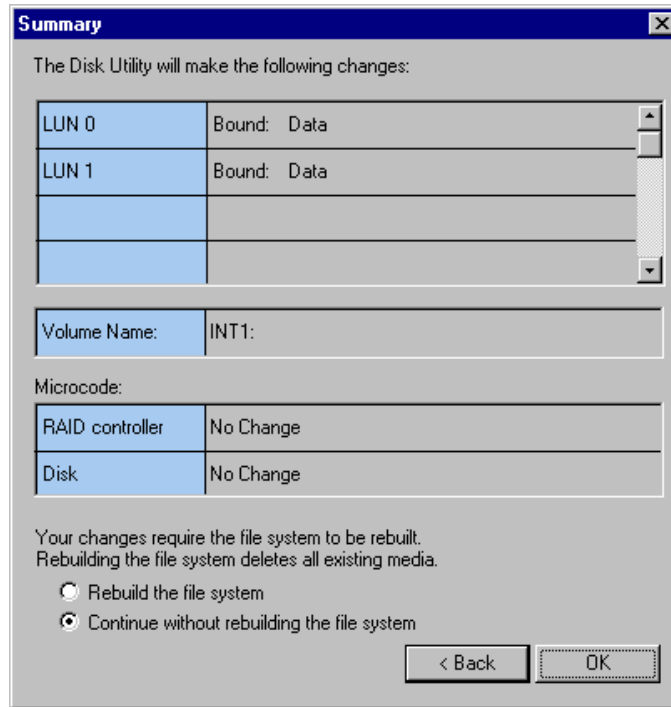

- Select **Continue without rebuilding the file system**, then click **OK** in the Summary dialog box.
- When the operation is complete, a message is displayed.
This completes the procedure for changing the file system volume name.

Expanding storage

You can expand storage by installing additional disk modules in empty disk slots or by connecting additional PFC storage chassis. To use the additional storage, you must bind unbound LUNs and create a new video file system which includes the new disk modules.

>>> **CAUTION: Back-up all media on existing drives before creating a new video file system. Creating a new video file system destroys all media files and other data on the disk modules.**

If you are adding additional PFC500s or PFC500E Expansion chassis, refer to one of the following procedures, then return to this procedure to configure the storage system:

- “Connecting storage: Using a single PFC500” on page 61
- “Connecting storage: Using multiple PFC500s” on page 64

To create a video file system on expanded storage:

1. Start Configuration Manager using the desktop shortcut or by selecting **Start | Programs | Profile Apps | Configuration Manager**. The Configuration Manager dialog box appears.
2. Click **File System** in the Configuration Manager window. Page 1 of the Disk Utility dialog box appears. For simplicity, a 20 disk system is shown.

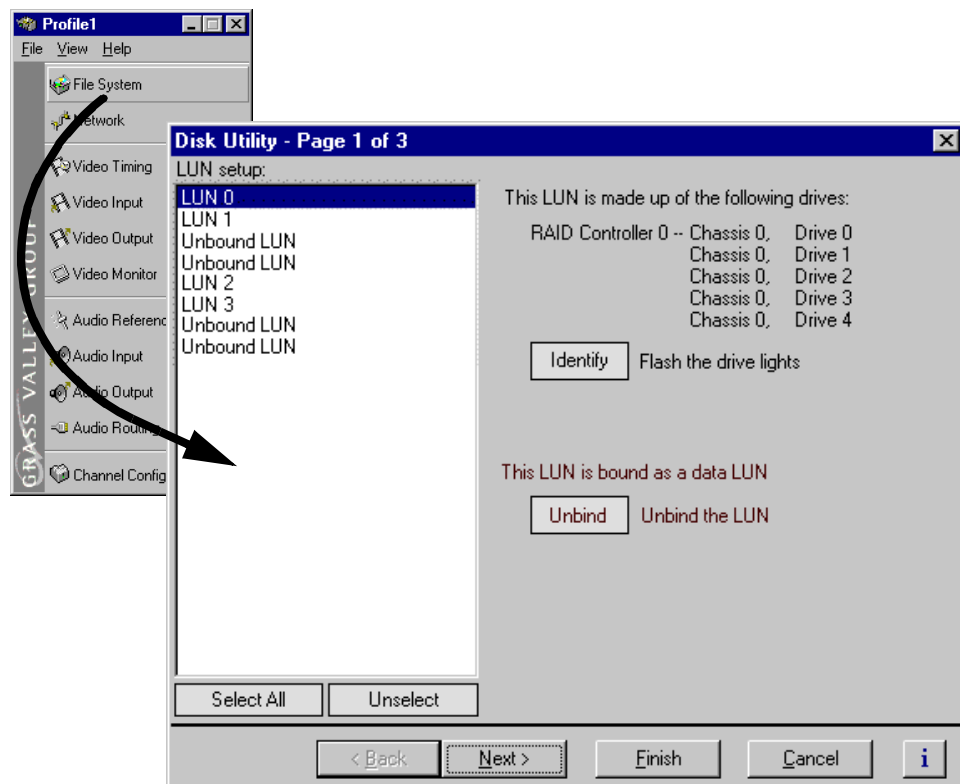

3. If there are Unbound LUNs displayed in the LUN setup list, perform the following



steps, otherwise, proceed to step 4.

- a. Select all Unbound LUNs using **SHIFT** or **CTRL** and click.
- b. Verify the LUN type selected is **Data**.
- c. Click **Bind**, then click **OK** in the dialog box.

The list now shows the Unbound LUN status as Bind Pending.

4. Click **Next** to navigate to page 2 of 3.
5. Enter the file system volume name, or use the default name.
6. Click **Finish**. The summary dialog box appears.

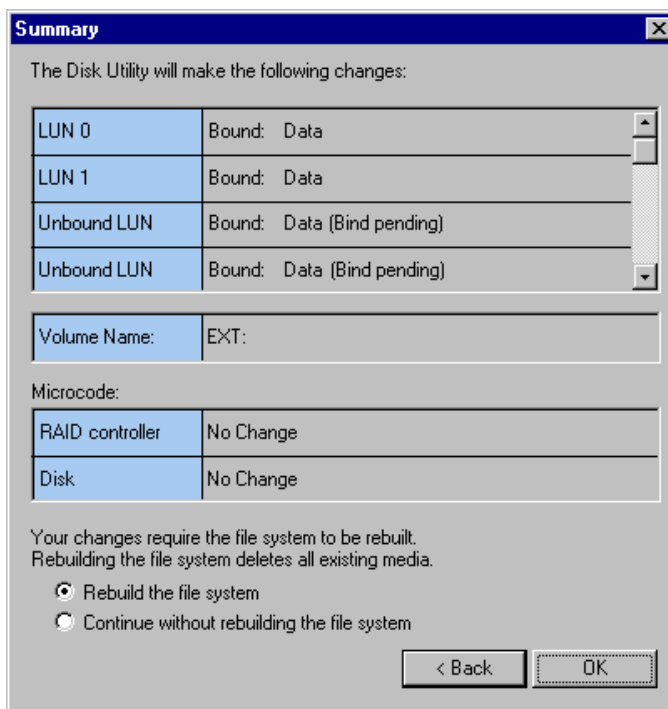

7. Select **Rebuild the file system**, then click **OK** in the Summary dialog box.
8. Read the warning message, then click **OK** to bind all unbound LUNs and create a file system.
 - Binding 18 GB drives - approximately one hour
 - Binding 36 GB drives - approximately two hours
 - Binding 73 GB drives - approximately four hours
 - Creating a file system - if you have no unbound LUNs, creating the file system takes only a few seconds.

When the operation is complete, the Profile XP system is ready for testing.

Determining which disk modules make up a LUN

Use the Identify button in the Disk Utility to determine which disk modules in the disk array make up a LUN. Clicking the Identify button flashes the disk LEDs of all the drives in the LUN. This is helpful in Profile XP systems with several Fibre Channel RAID chassis connected, for instance in locating the drives bound as hot spares.

To determine LUN physical location:

1. Start Configuration Manager using the desktop shortcut or by selecting **Start | Programs | Profile Apps | Configuration Manager**. The Configuration Manager dialog box appears.

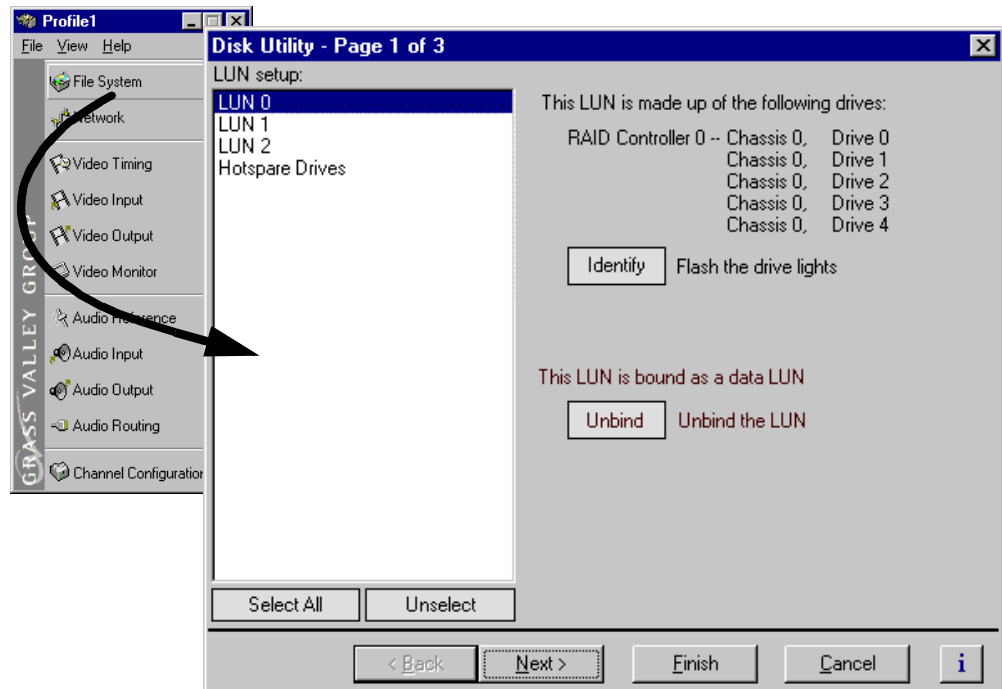

2. Click **File System** in the Configuration Manager window. Page 1 of the Disk Utility dialog box appears.
3. Select a LUN in the LUN setup list.
4. Click **Identify**. The dialog box appears.
5. Locate the LUN physical location, then click **OK** to clear Identify mode.
6. Click **Cancel** to close the Disk Utility dialog box.



Updating your PFC500 firmware

If you upgrade your Profile system software, you must update the microcode on all your PFC500 Fibre Channel RAID chassis. This will allow you to take advantage of all of the RAID enhancements and benefit from improved reliability.

To update your PFC500 Fibre Channel RAID microcode:

1. Start Configuration Manager and choose **File System**.
2. Click **Next** twice to open the third page, Disk Utility.
3. In the Disk Utility - Page 3 of 3, browse for the latest RAID microcode file in the `c:\profile\microcode` directory. Select the `.bin` file with the highest “flare” or “prom” version number. For example, `flare32104prom202.bin` is more recent than `flare32103prom202.bin` and `flare32103prom203.bin` is more recent than `flare32103prom202.bin`.
4. Click Finish and wait for the microcode to load.

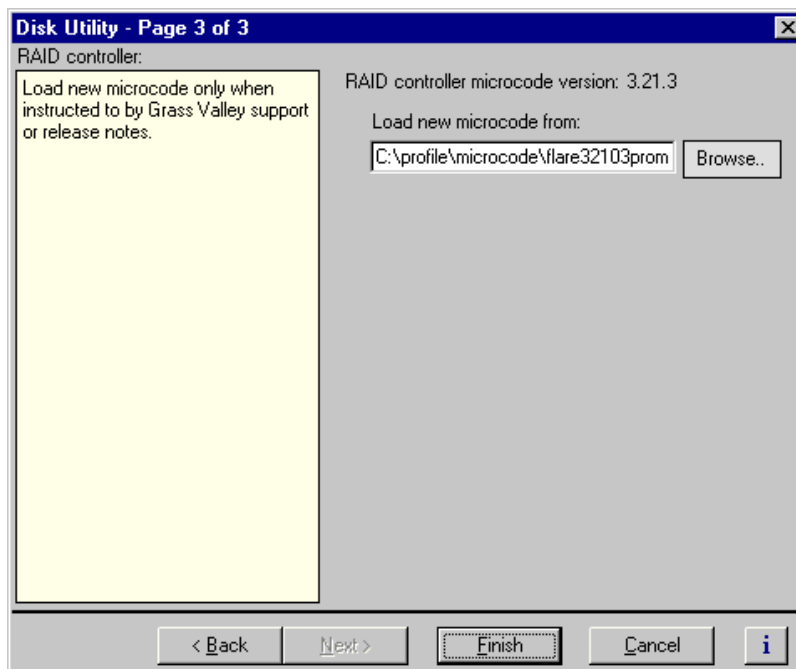

5. When the loading is completed, shut down and turn off the power to the Profile XP system **and to all attached PFC500 Fibre channel RAID chassis**. Failure to shut down the RAID units will prevent the new microcode from taking effect.
6. Turn on the power to all the RAID chassis, wait two to three minutes, then turn on the Profile XP system.

Adding or Removing Channels

Profile applications use channels to control disk recording and playback. A channel defines a logical collection of Profile video, audio, and timecode resources and is identified by a unique name. This chapter describes how you can remove channels you no longer use and how to add and configure new channels for your specific needs. Once you add and configure a new channel, it becomes available for use by Profile applications.

Using the Channel Configuration dialog box

You use the Channel Configuration dialog box in Configuration Manager to remove, add and configure channels. The Channel Configuration dialog box allows you to define channel properties, including:

- Channel name
- Channel type (MPEG Player, MPEG Recorder, MPEG Player/Recorder)
- Video inputs and outputs
- Audio inputs and outputs
- Timecode sources (inputs and outputs)



Displaying the Channel Configuration dialog box

To display the Channel Configuration dialog box:

In the Configuration Manager window, choose **Channel Configuration**. The Channel Configuration dialog box appears.

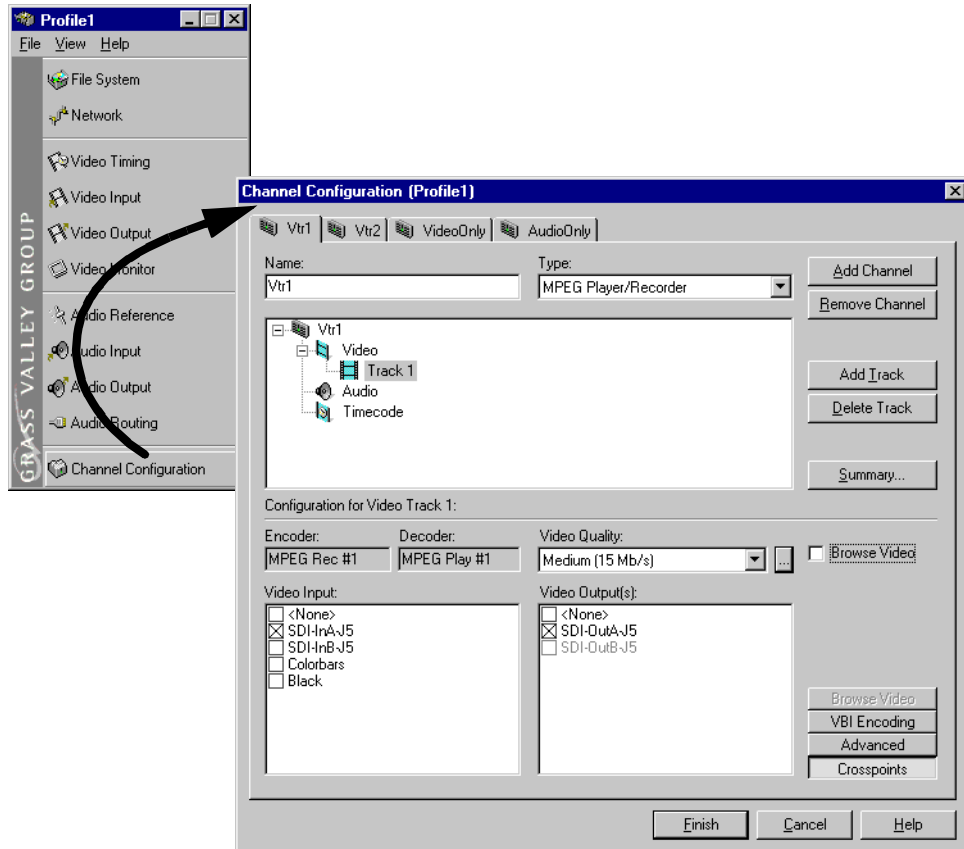

Working with channels

Listed here are a few things to consider when working with channels and the Channel Configuration dialog box.

- Clicking the **Finish** button saves the changes you've made to the channels and closes the Configuration Manager dialog box.
- If you make changes to a channel while it is in use by an application, you must reselect the channel in the application, otherwise you won't see the change until the next time the application is started.
- When the Channel Configuration dialog box is opened, it allocates all available outputs so the effect of crosspoint changes may be seen as you make them.
- Adding and configuring channels is not dependent on the number or availability of video, audio, and timecode resources since you are only defining a channel. Resources are allocated when a channel is selected by a Profile application. Only one instance of a channel can be used at a time.
- Configuration Manager limits the number of channels you can define to sixteen. If you need to define more than sixteen channels, consider saving channel configurations and then defining new ones. Refer to "Saving and restoring your system settings" on page 48.

Default settings for channels you add

When you add a channel, the new channel is created with settings derived from the current channel. The current channel is the channel tab selected in the Channel Configuration dialog box. Channel settings that are copied include channel type, number of video, audio, uncompressed VBI lines, and timecode tracks, video quality, still play mode, and audio window size. After adding a channel, all you have to do is specify video, audio, and timecode inputs and outputs.

When a channel is added, it is given a default name. You may change the name by entering it in the name text box in the channel tab. Channel names can have up to 32 characters.



Why resources appear dimmed, red, or in use

The channel configuration dialog box uses colored text to display resource names to help prevent you from creating resource conflicts that could occur if you try to use channels at the same time.

When a resource, such as a video output, is not assigned to any channel, the check box next to its name is cleared and its name is in black print. If the resource is selected on another channel tab, its check box and name are dimmed.

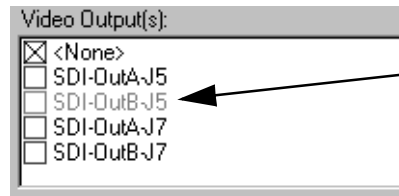

Dimmed text
Indicates the resource is selected on another channel tab.

If you select a resource that's already selected on another channel tab, its text changes from dimmed to red. Selecting a resource assigned to another channel is not necessarily a problem. You can have several channels that use the same resources. However, channels assigned the same resource will display a Warning symbol on their channel tabs because the channels cannot be used at the same time. (See "Using the Warning symbol to find shared resources" on page 92.)

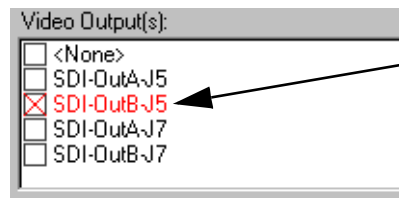

Red text
Indicates the resource is selected on more than one channel tab.

The words "in use" appear next to a resource name when an application is currently using the resource. Resources that are in use are not effected by your crosspoint selections in the Channel Configuration dialog box.

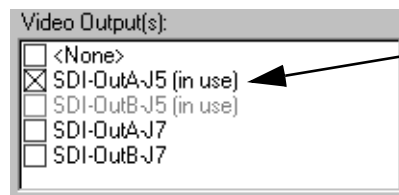

(in use)
Indicates the resource is in use by an application.

You can use Tool Tips to find out which application is using the resource that is marked "in use". See "Using Tool Tips to manage resources" on page 91.

NOTE: You can select a resource marked "in use", but you won't see the crosspoint change because the resource is in use by an application.

Using Tool Tips to manage resources

The Channel Configuration dialog box uses Tool Tips to provide additional information about how a resource is used. When you hold the cursor for a short period of time over a resource displayed as gray, red, or “in use”, a Tool Tip will appear showing status of the resource.

- If the resource is assigned to another channel (dimmed or red) the Tool Tip displays the channel name.

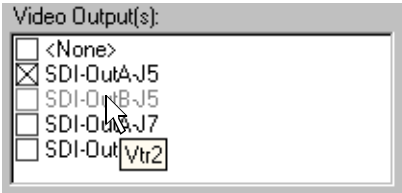

- If the current channel has selected a resource that is in use, the Tool Tip displays the name of the application using the resource and the name of the machine running the application.

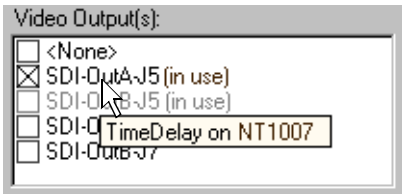



Using the Warning symbol to find shared resources

The Warning symbol appears on channel tabs that share the same resource. This feature helps you identify resource conflicts which will occur if you try to use both channels at the same time.

To determine which resource is assigned to more than one channel:

1. Click on one of the channel tabs displaying the Warning symbol.

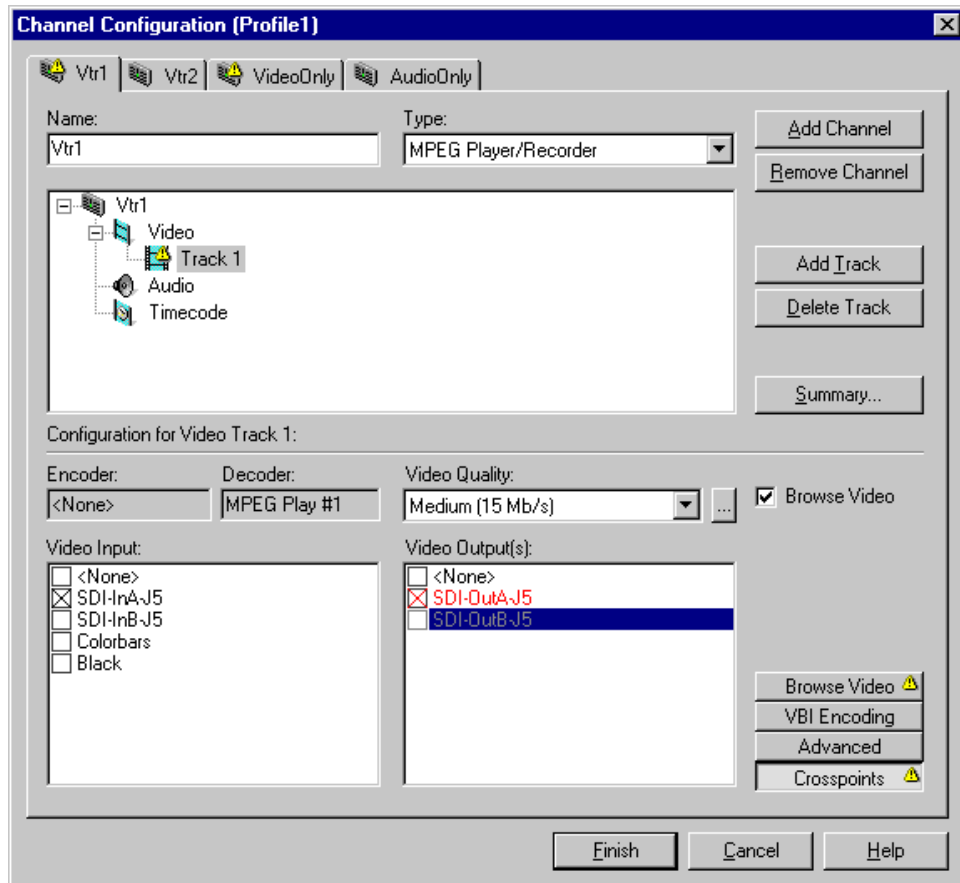

2. Click on the Track in the configuration tree displaying the Warning symbol, then click the **Crosspoint** button.
3. The resource assigned to more than one channel is displayed in “red” text.

Using the Summary button to review channel settings

Choosing the **Summary** button opens the channel summary dialog box which provides a list of channels and the resources assigned to them. The Summary dialog box allows you to review all channels and their settings as you scroll through the channel summary list. When the dialog box opens, the display automatically scrolls to show the properties of the channel tab you have selected.

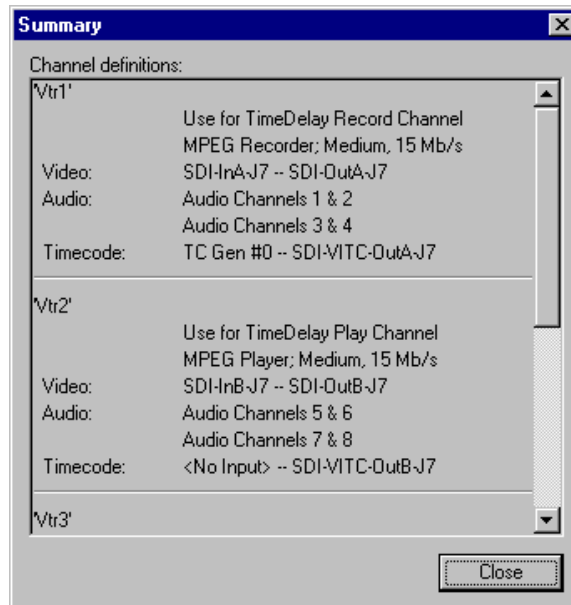

A similar summary dialog box appears in Profile applications to help you when you are selecting channels.



Adding and configuring a new channel

Adding a channel involves naming the channel, choosing the channel type and number of video, audio, and timecode tracks, along with the crosspoints for each track.

To add a channel

Use the Add Channel button in the Channel Configuration dialog box to add a new channel. When you click the Add Channel button, a new channel is created with the same properties as the current channel tab selected.

1. Click the channel tab most similar to the channel you want to configure in the Channel Configuration dialog box
2. Click the **Add Channel** button.

Entering channel name and description

You can enter the name to identify the new channel. You can also enter text into the channel description window. The channel description is displayed along with the channel name in Profile applications and can help operators select channels. For example, a channel description could be “Weekend news setup” or “Use for play channel in TimeDelay”.

To enter channel name and description:

1. Enter a channel name in the **Name** text box.
2. Click the channel icon () in the configuration tree to display the Channel **Description** text box.

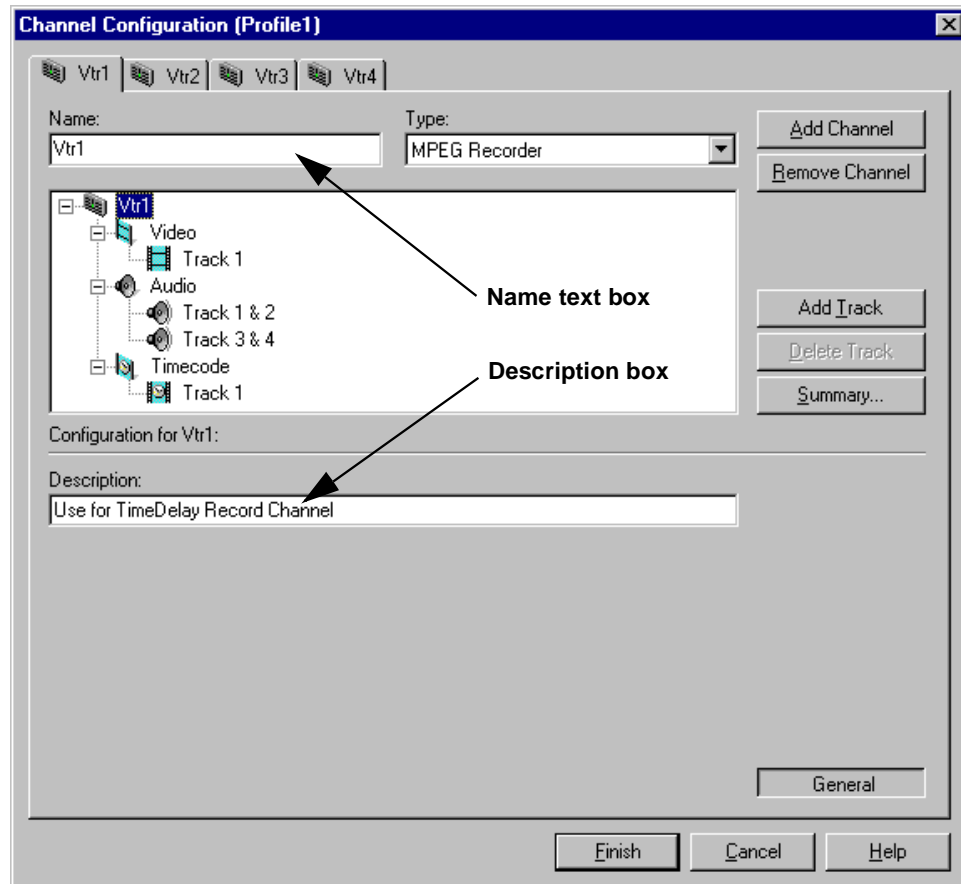

3. Enter a channel description in the **Description** text box. The channel description is displayed with other channel properties when the **Summary** button is selected. See “Using the Summary button to review channel settings” on page 93. Profile applications can also show the channel descriptions to help you select the appropriate channel.



Selecting the channel type

You can use the **Type** drop-down list to change the channel type. Channel types are described in the following table.

Channel Type	MPEG Resource Used	Description
MPEG Recorder	Encoder only	Can only record clips. Recorded clips must be loaded and played using a Player or Player/Recorder Channel
MPEG Player	Decoder only	Can only play clips.
MPEG Player/Recorder	Decoder and Encoder	Can record and play clips, but not at the same time.

The channel types you choose will effect how many channels you can operate at the same time. A Player/Recorder channel consumes both a video encoder and decoder (but uses only one at a time). Defining channels which can only play or only record uses resources more efficiently, but does not allow you to play and record using a single channel.

To change the channel type:

1. Select Channel Configuration in the Configuration Manager window. The Channel Configuration dialog box appears.
2. Select the tab for the channel you want to modify.

3. Select an appropriate channel type: **MPEG Player/Recorder**, **MPEG Player**, or **MPEG Recorder**. Depending on the channel type, different codec or encoder/decoder information is displayed below the configuration tree.

Video quality and crosspoints remain the same after changing channel type.

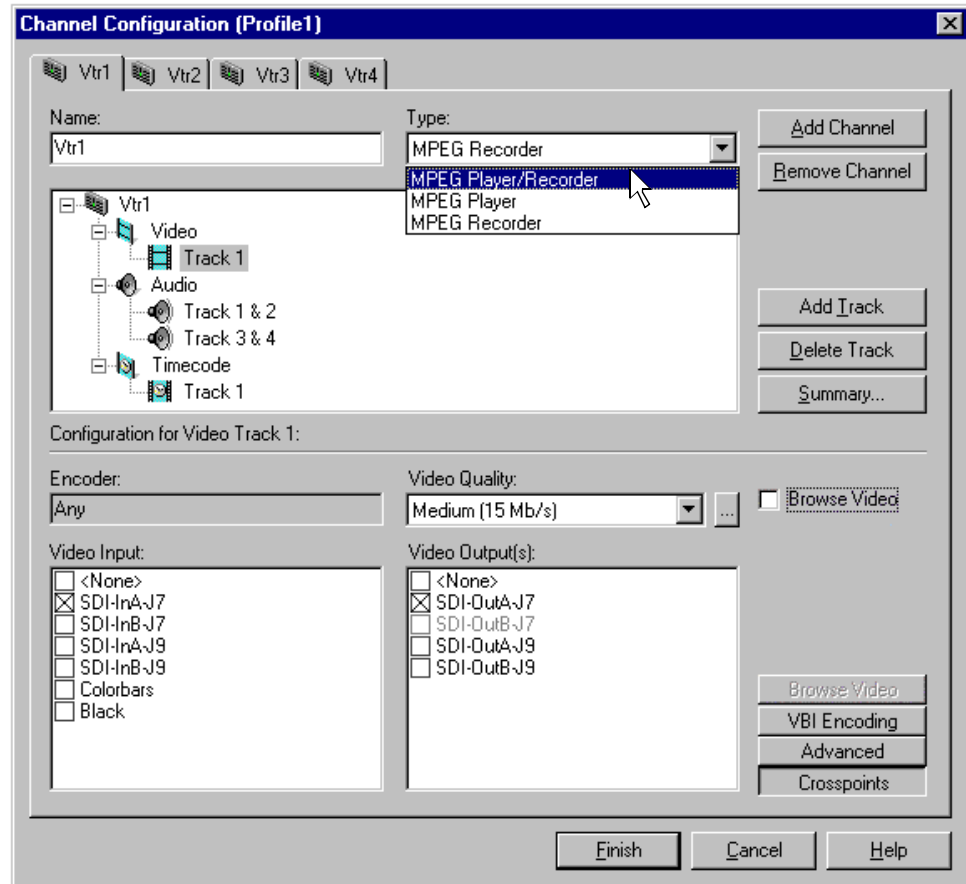



Selecting video quality and crosspoints

You'll need to select which video inputs and outputs you want a channel to use as well as the video quality for channels that can record.

The Channel Configuration dialog box allocates all available outputs so that you can monitor your crosspoint selections. The colorbars video input is always available and can be used to verify video output routing.

To select input and output resources for each video track:

1. Double-click the video icon () to expand the configuration tree.
2. Choose a video track in the configuration tree, such as **Track 1**.
3. Click the **Crosspoints** button, then select a video input from the Video Input check boxes. You can choose only one video input for a video track.

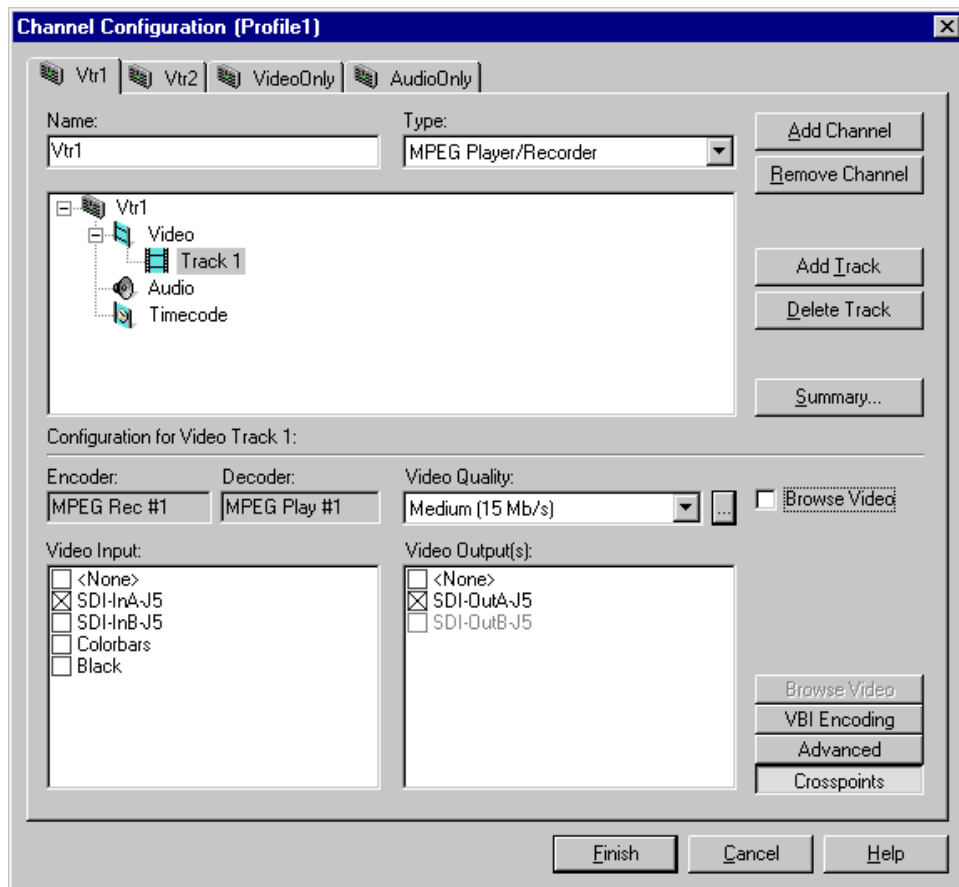

4. With the video **Crosspoints** button still selected, choose a video output from the Video Output(s) list. You can choose one or more video outputs for a video track. Each output corresponds to one of the video output connectors on the back of the Profile XP system.

NOTE: You can temporarily select the internal colorbars to verify crosspoint routing. Play channels in E to E mode will display colorbars if selected.

5. Select the video data rate using the Video Quality drop-down list. Video quality settings for each data rate are shown in the table.

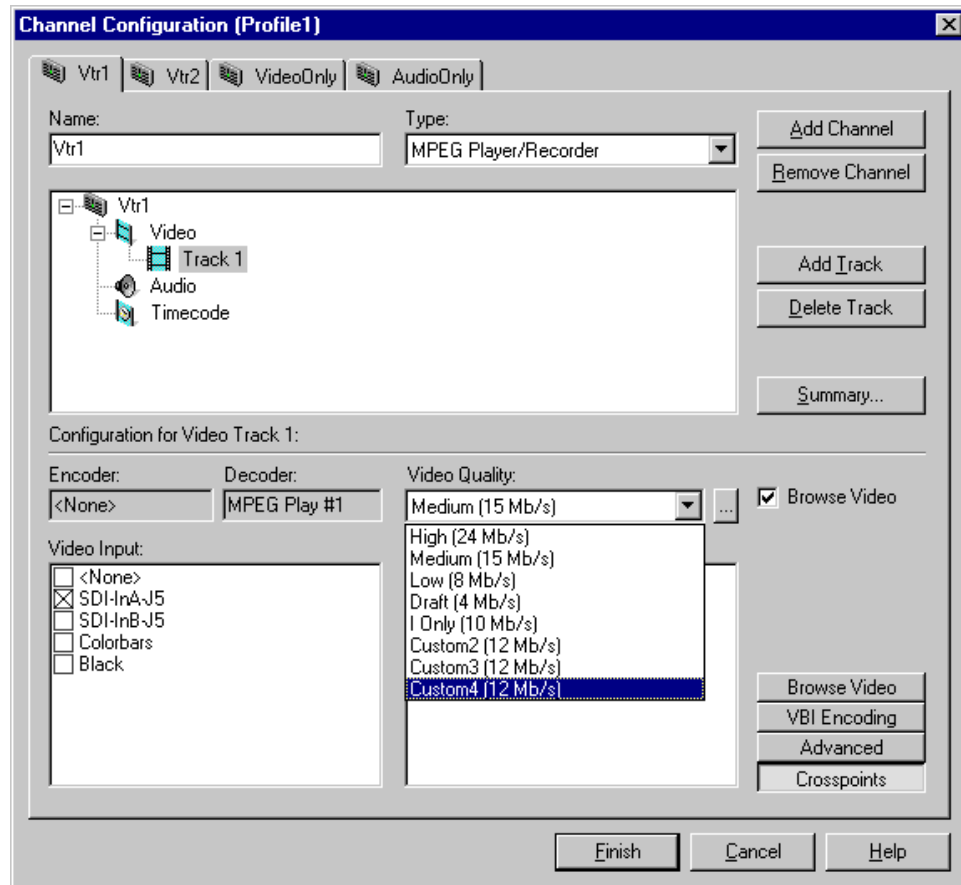

Quality Settings	Data Rate	Chrominance Sampling	GOP
Draft	4 Mbps	4:2:0	IBBPBBPBBPBBPBBP (default)
Low	8 Mbps		
Medium (default)	15Mbps	4:2:2	
High	24Mbps		

You can customize video quality settings using the Custom Video Quality Settings dialog box. Refer to Chapter 5, “Selecting video quality for a channel”.



6. Click the Browse Video check box if you want to add MPEG-1 proxy video to the track.

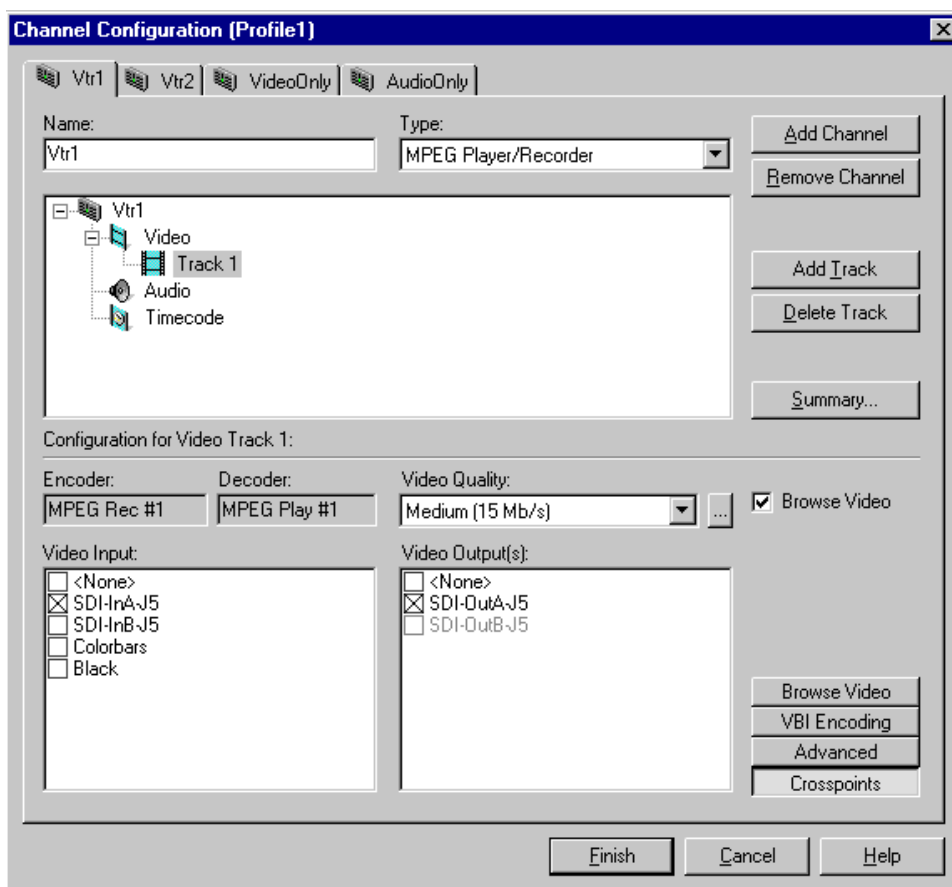

- Click **Browse Video**. Select an encoder for the browse video. The size of the MPEG-1 video image when played back is 352 x 240 for NTSC, and 352 x 288 for PAL.

NOTE: The MPEG encoder that you select for use with browse video is dedicated to that use and is no longer available for encoding broadcast quality video.

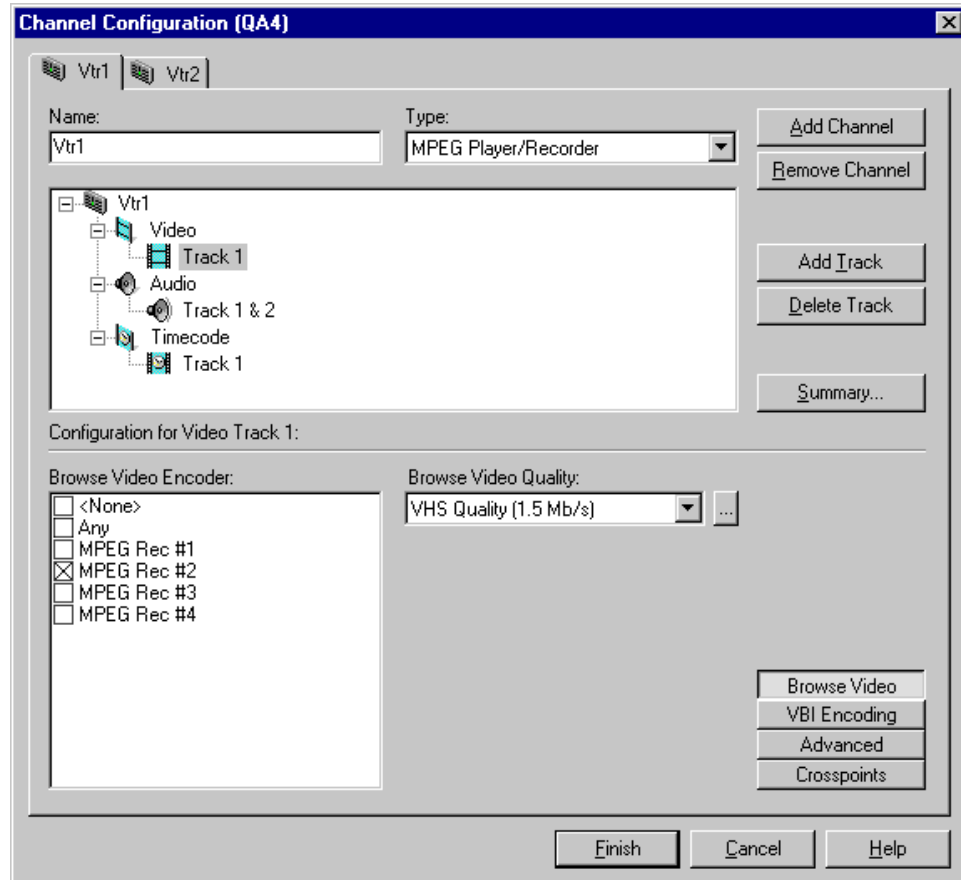



8. Select the browse video data rate using the Browse Video Quality drop-down list. Browse video quality settings for each data rate are shown in the table.

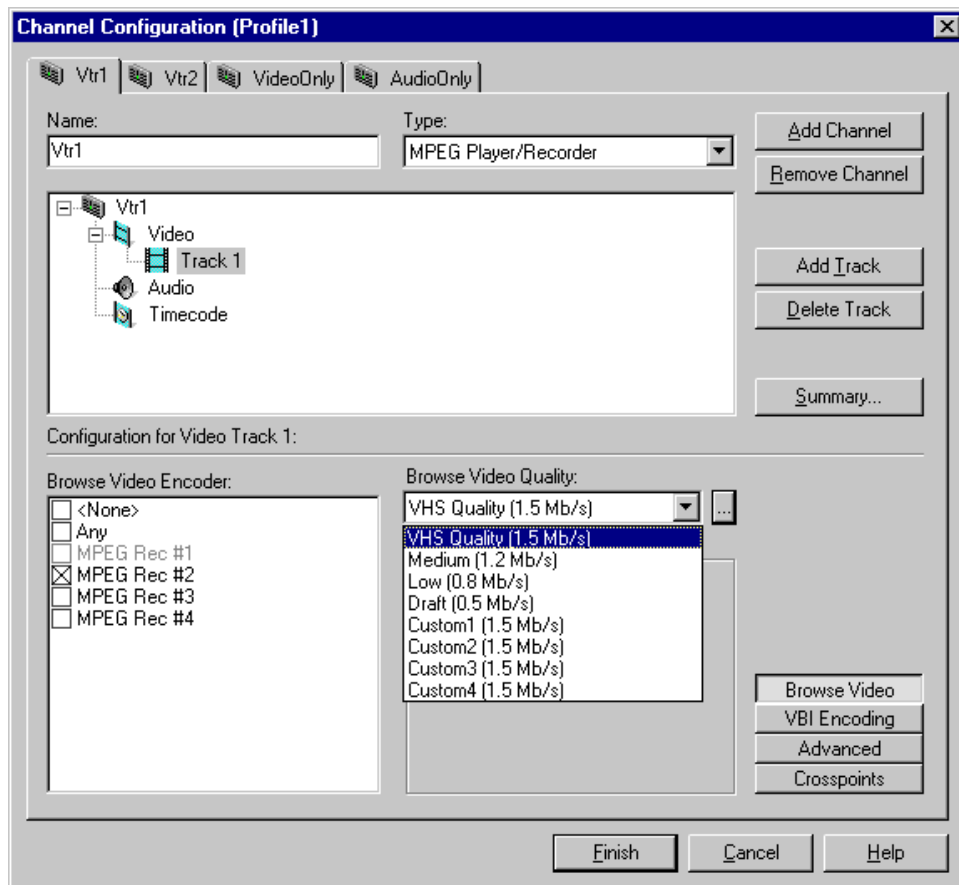

Browse Video Quality Settings	Data Rate	GOP
Draft	.5 Mbps	IBBPBBPBBPBBPBBP (default)
Low	.8 Mbps	
Medium	1.2Mbps	
VHS Quality (default)	1.5Mbps	

You can customize video quality settings using the Custom Video Quality Settings dialog box. Refer to “Defining and selecting a custom video quality preset” on page 123.

Selecting audio channels for each audio track

To select audio channels for each audio track:

1. Double click the Audio icon (🔊) to expand the configuration tree.
2. Select the audio Track icon in the configuration tree.

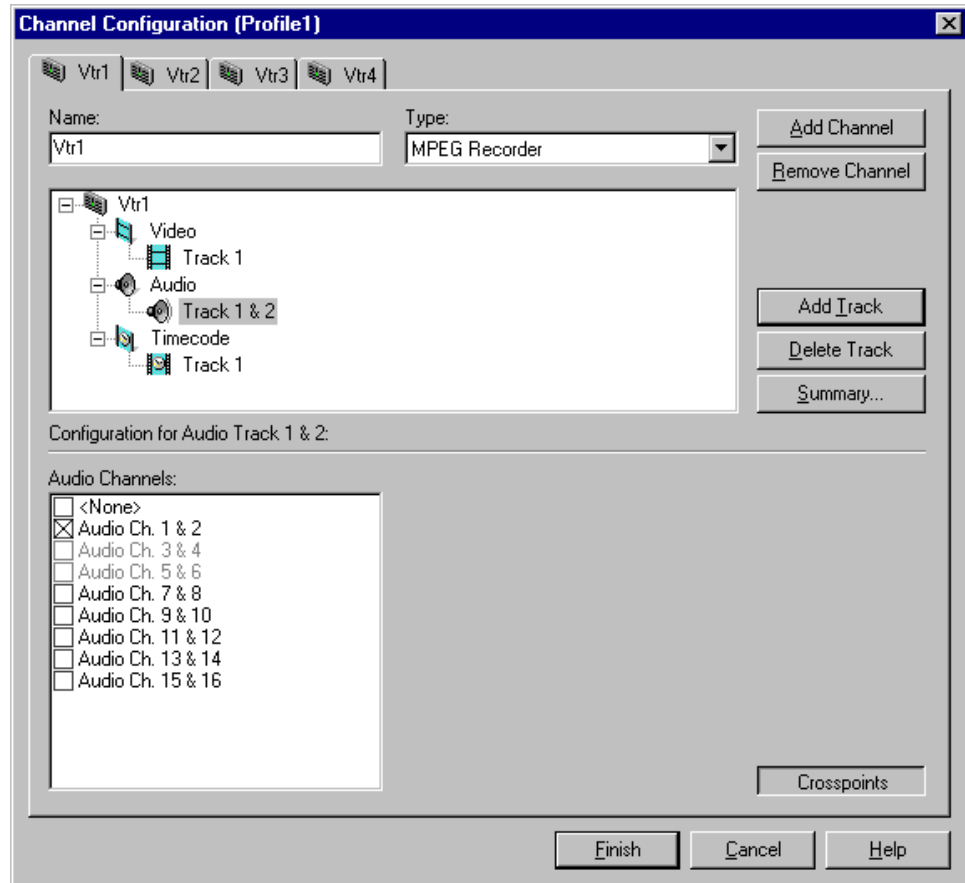

3. For each pair of audio tracks, select an audio channel pair by placing a check in the appropriate check box. You can change the audio format for the audio channels using Configuration Manager (refer to Chapter 6, “Changing the audio I/O format”).



Selecting timecode I/O for each timecode track

To select timecode inputs and outputs for each timecode track:

1. Double-click the Timecode icon () to expand the configuration tree.
2. Click the **Crosspoints** button and then select a timecode input from the Timecode Input list. If you choose TC Generator, refer to “Using the internal timecode generators” on page 172 for instructions on setting up the timecode generator.

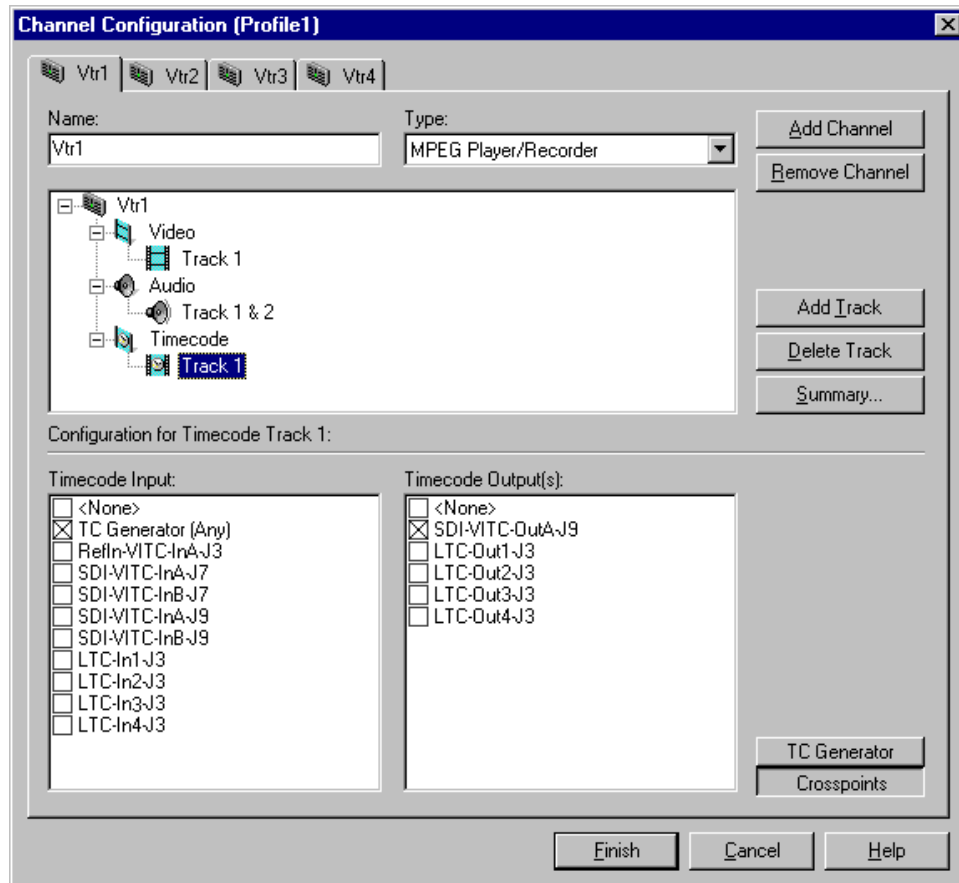

3. With the **Crosspoints** button still selected, choose a timecode output from the Timecode Output(s) list.

NOTE: The VITC output listed corresponds to the video output assigned to the channel. For example, “SDI-VITC-OutA-J5” appears in the Timecode Output list box for Vtr1 when “SDI-OutA-J5” is selected as the video output. If you change a video output for a channel, the VITC output listed also changes.

4. Click the **Finish** to save your channel settings and close the Channel Configuration dialog box. You can now select the new channel in your Profile application.

Removing a channel

You can remove a channel that is no longer needed. Once a channel is removed, it cannot be recalled again. You will have to create it again by using the **Add Channel** button.

To remove a channel:

1. Click the tab of the channel to be removed.
2. Click the **Remove Channel** button in the Channel Configuration dialog box.
3. Click **Finish** to save the change and close the dialog box.

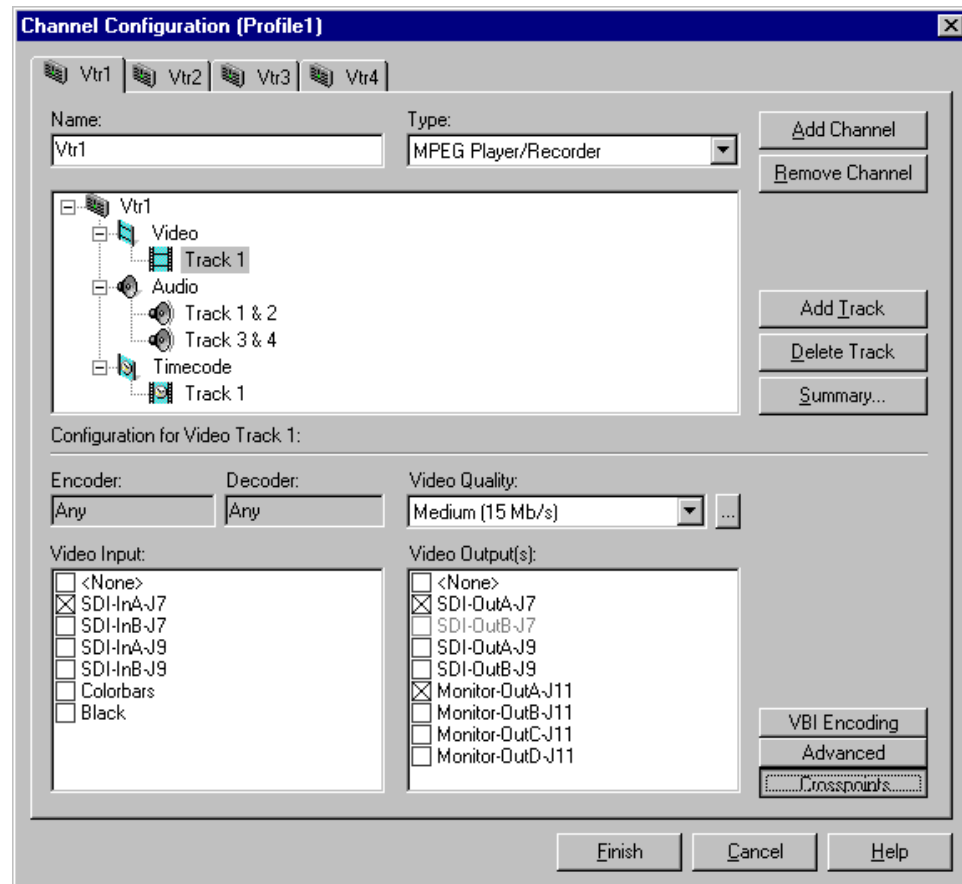



Chapter 4 Adding or Removing Channels

Modifying a Channel: Video Settings

You can use Configuration Manager to customize channel video settings to satisfy the needs of your video system.

Using Configuration Manager you can:

- Adjust video output timing for any channel.
- Set up how the video input frame buffers handle synchronous or asynchronous feeds.
- Change the video standard for the system.
- Change the video input/outputs used by a channel.
- Change the compression settings for a channel.
- Select the video still-play mode
- View the status of the video input signal for a channel.
- Set up timecode burn-in and text overlay on the optional video monitor board.

Adjusting video output timing

Two output timing modes are provided for timing the Profile XP Media Platform into your system: Zero Timed mode and E to E Timed mode. In Zero Timed mode, the playout timing of all video outputs are set to match zero time of the system reference. In E to E Timed mode, playout timing is set to match the 16 line E to E signal delay through the system.

The timing mode you choose depends on how you use the Profile XP system. When using the Profile XP system as a playout source, you will, most likely use Zero Timed output mode so that video output timing will be zero timed. If you are using the Profile XP system to switch between playout and video input signals, you must use E to E Timed mode so that playout timing matches E to E timing through the system. This ensures clean switching between the video input and decoder output.

With the Profile XP system timing controls, you can make additional playout timing adjustments in both video output timing modes to meet downstream system requirements.



Adjusting playout timing to match zero time

In Zero Timed Output mode, all playout timing is set to match the system reference timing. You can use the Video Output Timing Offset adjustment, provided for each video output, to meet downstream timing requirements.

To adjust playout timing offset to match zero time:

1. Choose **Video Timing** in the Configuration Manager window. The Video Timing dialog box appears.
2. Click **Next** to navigate to Video Timing page 3 of 3.

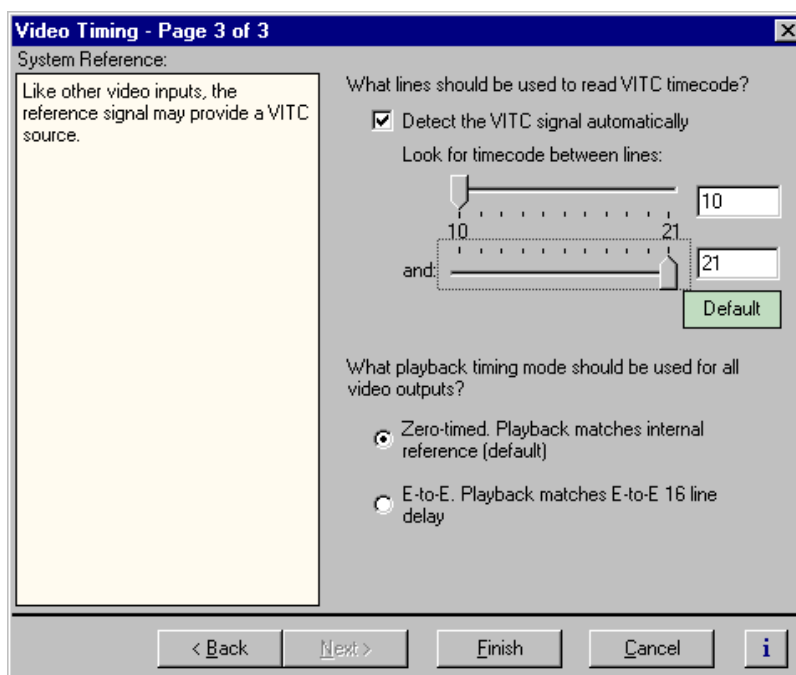

3. Select **Zero-Timed** mode, then click **Finish**. Playout timing is now set to match internal reference.

NOTE: When you change the playout timing mode, restart all Profile applications currently using the system.

4. Some playout timing adjustment may be required to satisfy downstream timing requirements in your system. If so, adjust playout timing as follows:
 - a. Select **Video Timing** in the Configuration Manager window. The Video Timing dialog box appears.
 - b. Click **Next** to navigate to Video Timing page 2 of 3.

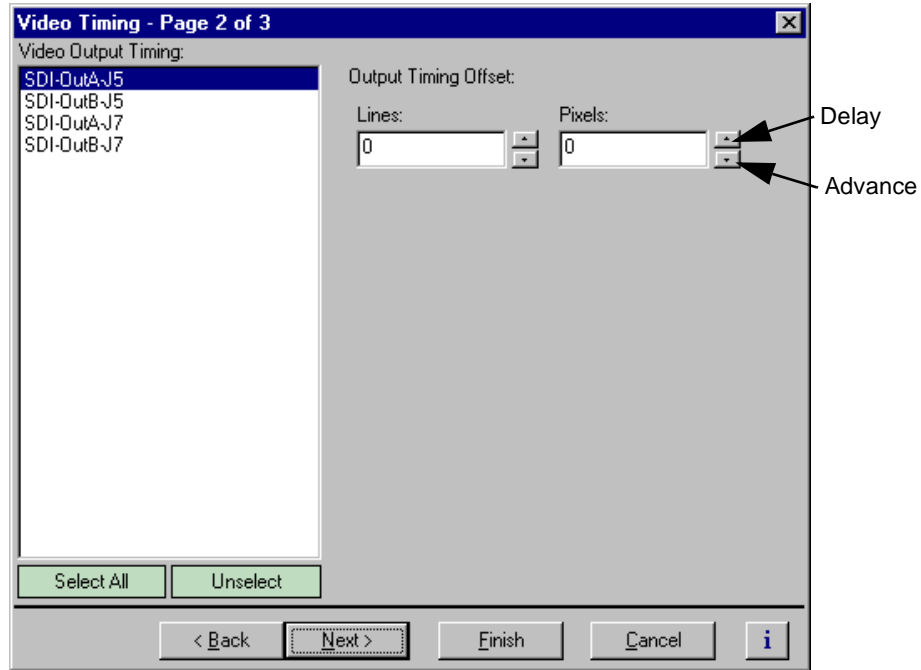

- c. Select a video output from the Video Output Timing list or click **Select All** to adjust all outputs at the same time.
- d. Use the Output Timing Offset controls to adjust playout timing to meet your timing requirements.
- e. Repeat step c and step d for the remaining video outputs, if required, then select **Finish**.



Adjusting playout timing to match E to E timing

In E to E Timed Output mode, all playout timing is delayed from the system reference by +16 lines to match the E to E delay through the system. This ensures clean switching between video inputs and decoders outputs. You can use the Output Timing Offset adjustment, provided for each video output, to meet downstream timing requirements.

To adjust playout timing to match E to E timing:

1. Choose **Video Timing** in the Configuration Manager window. The Video Output Timing dialog box appears.
2. Click **Next** to navigate to Video Timing page 3 of 3.

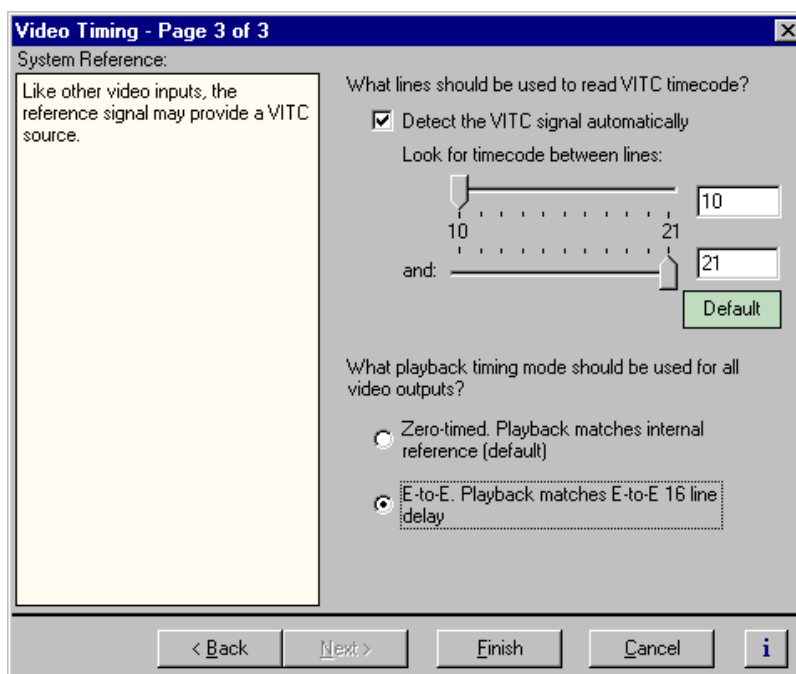

3. Select **E to E** output timing mode, then click **Finish**. Playout timing is now set to match E to E timing.

NOTE: If you changed the playout timing mode, restart all Profile applications currently using the system.

4. Some playout timing adjustment may be required to satisfy downstream timing requirements in your system. If so, adjust playout timing as follows:
 - a. Select **Video Timing** in the Configuration Manager window. The Video Timing dialog box appears.
 - b. Click **Next** to navigate to Video Timing page 2 of 3.

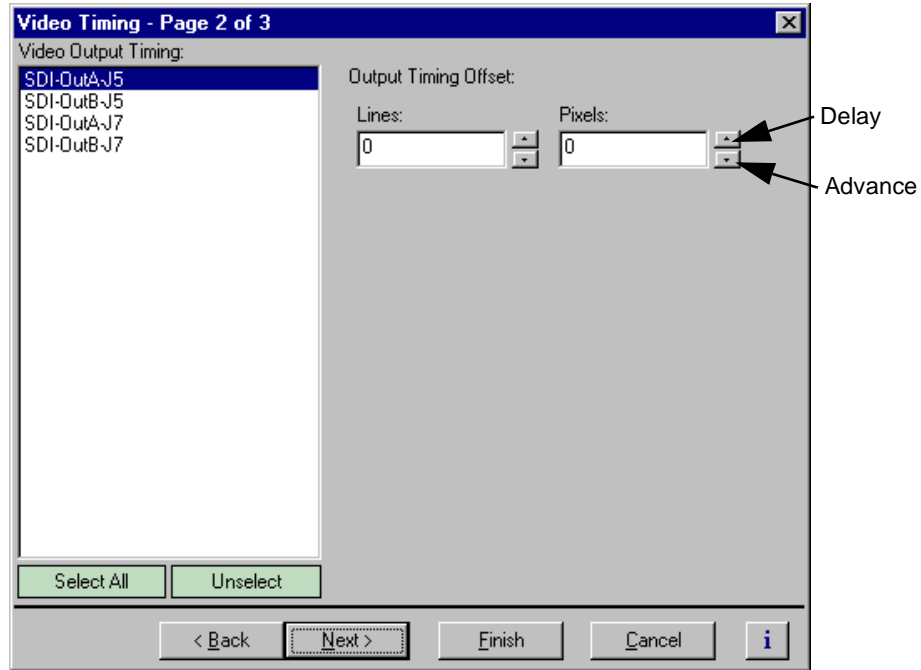

- c. Select a video output from the Video Output Timing list or click **Select All** to adjust all outputs at the same time.
- d. Use the Output Timing Offset controls to adjust playout timing to meet your timing requirements.
- e. Repeat step c and step d for the remaining video outputs, if required, then select **Finish**.



Adjusting system reference timing to offset all playout timing

Adjusting system reference timing offsets all playout timing relative to the reference. The reference timing should only be changed if the downstream timing requirements cannot be met by adjusting the video output timing.

To adjust system timing relative to system reference:

1. Choose **Video Timing** in the Configuration Manager window. The Video Timing dialog box appears.

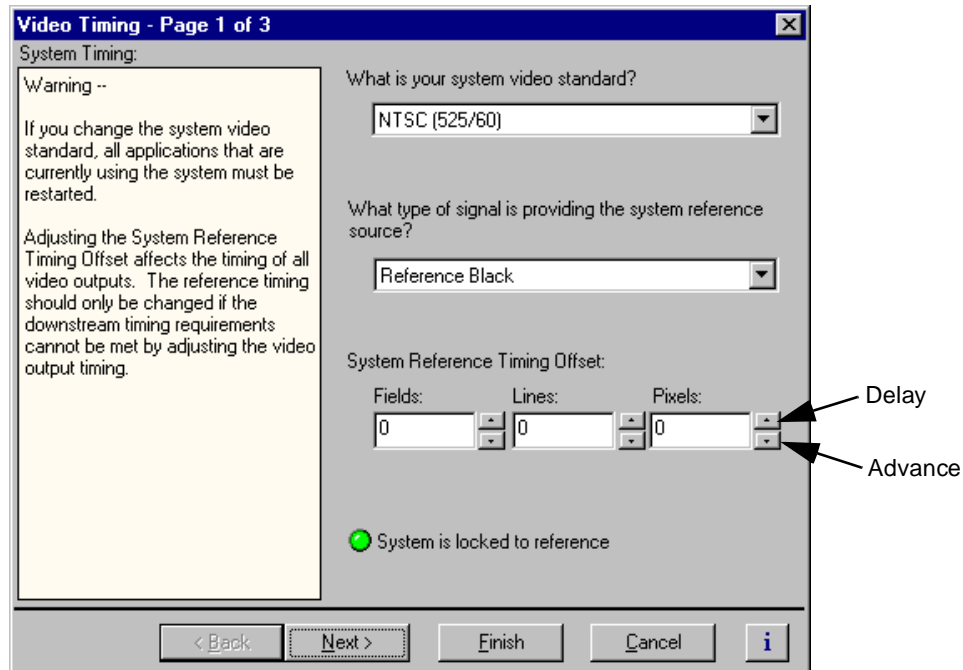

2. Adjust system timing using the System Reference Timing Offset controls, then click **Finish**.

Auto-timing synchronous video feeds

You can enable auto-timing to ensure clean switching between other inputs and decoder outputs. Auto-timing is accomplished by frame buffers on each video input providing an infinite auto-timing window. When auto-timing is used, the frame buffer automatically times synchronous feeds relative to the system reference: zero time +16 lines by default.

NOTE: *If you are using the Profile XP Media Platform to switch between video inputs and decoder outputs (playback), you must set the output timing mode to E to E Timed Outputs. For more information see “Adjusting video output timing” on page 107.*

When auto-timing is enabled, a maximum delay of slightly more than 1 frame can occur to time the video input. Audio channels assigned to the same video channel automatically track the video delay to eliminate lip sync errors.

To enable auto-timing for synchronous feeds:

1. Choose **Video Input** in the Configuration Manager window. The Video Input dialog box appears.
2. Click **Next** to navigate to Video Input page 3 of 3.

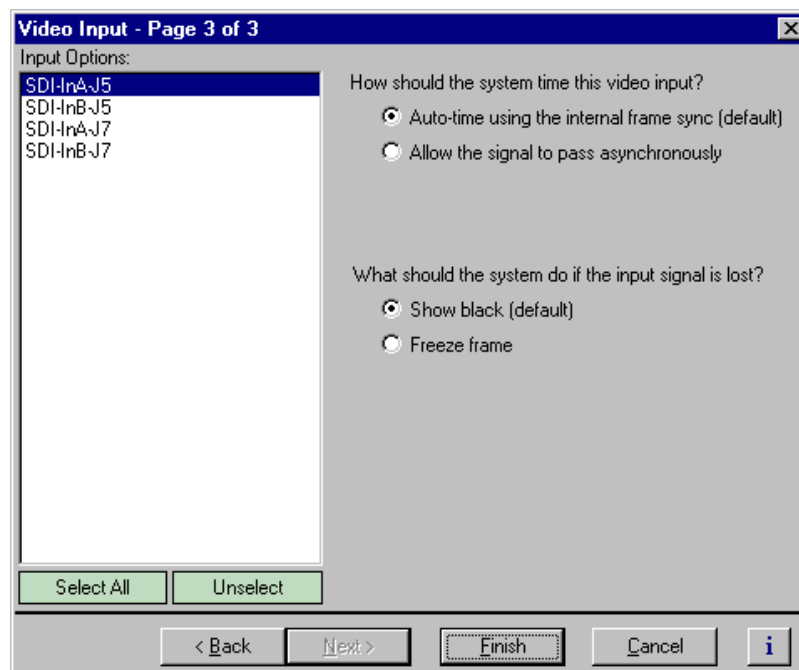

3. Select a video input from the list or click **Select All** to configure all inputs at the same time.
4. Select the option “Auto-time using the internal frame sync (default)”, then click **Finish**.



Options for timing asynchronous feeds

All video inputs include an input frame buffer. You must select how the frame buffer handles asynchronous feeds based on your application. The two video timing modes for the frame buffer are described here.

- “Auto-time using the internal frame sync (default)”

This is the frame buffer default setting. When selected, the frame buffer synchronizes and times the input relative to the system reference: zero time +16 lines by default. This mode allows clean switching between the video input and decoder outputs (playback) provided E to E playback timing is also selected (see “Adjusting playout timing to match E to E timing” on page 110).

A maximum delay of slightly more than 1 frame can occur to time the video input. Audio channels assigned to the same video channel automatically track the video delay to eliminate lip sync errors.

In order to synchronize an asynchronous input, the frame buffer may drop or repeat frames from time to time. This artifact is captured if you are recording at the time. If this artifact in the recorded video is not acceptable, either use a synchronous input or do not use this timing mode.

- “Allow signal to pass asynchronously”

This input timing mode allows an asynchronous signal to pass through the input frame buffer, clock locked only. No attempt is made to time the signal to the system reference so that no frames are repeated or dropped. Select this mode when you want to be sure that all video frames are recorded.

The clock locking that occurs in this timing mode may result in non-standard horizontal blanking interval on the video input. This artifact is visible in the video in E to E mode, such as when you are monitoring a channel during record. The recorded clip is not effected since horizontal blanking is not recorded; it is reinserted during playout

To select the input timing mode for an asynchronous video input:

1. Choose **Video Input** in the Configuration Manager window. The Video Timing dialog box appears.
2. Click **Next** to navigate to Video Input page 3 of 3.

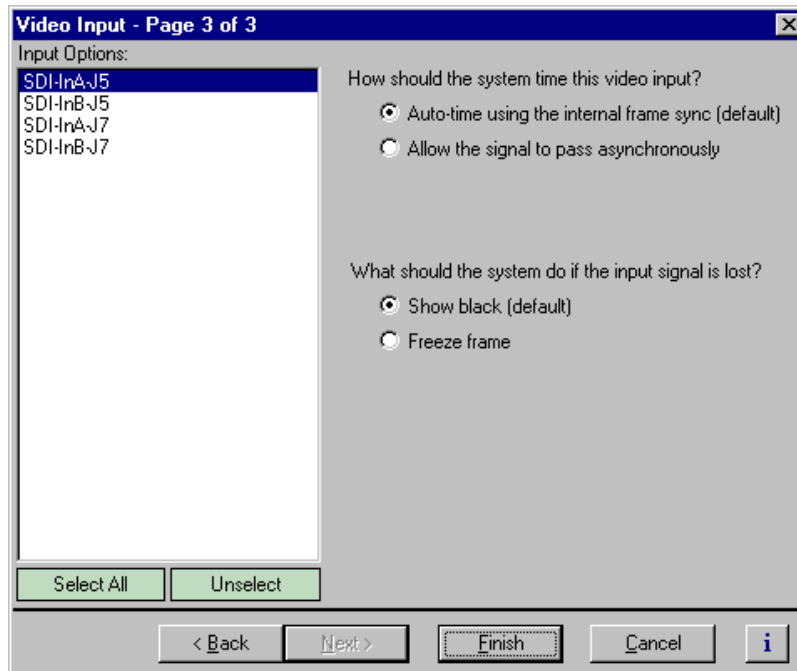

3. Select an input from the list or click **Select All**.
4. Select the video timing option for your application. Refer to the following:
 - “Auto-time using the internal frame sync (default)” - Select this mode to ensure clean switching between the video input and decoder outputs (playback).
 - “Allow signal to pass asynchronously” - Select this mode when you want to be sure that all video frames are recorded and are not using the signal in E to E mode.

NOTE: If you are using the Profile XP Media Platform to switch between video inputs and decoder outputs (playback), you must set the output timing mode to E to E Timed Outputs. For more information see “Adjusting video output timing” on page 107.

5. Click **Finish**.



Changing the system video standard

Changing the system video standard resets the Profile XP system hardware for operation with either 525/60 or 625/50 line standards.

To change the system video standard:

1. Choose **Video Timing** in the Configuration Manager window. Page 1 of the Video Timing dialog box appears.

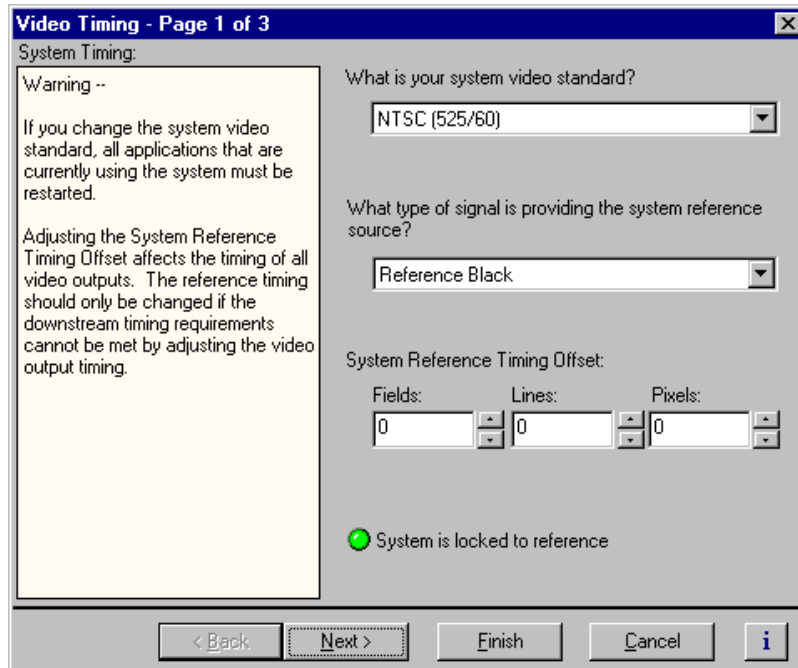

2. Under “What is your system video standard?”, select a video standard using the drop-down list. The change takes immediate effect.

NOTE: After changing the system video standard, you must restart all Profile control applications currently using the system resources.

3. Click **Finish** to saving your settings.

Selecting the video I/Os used by a channel

You can use the Channel Configuration dialog box to change the video input and outputs used by a channel.

To change video input and output used by a channel:

1. Choose **Channel Configuration** in the Configuration Manager window. The Channel Configuration dialog box appears.

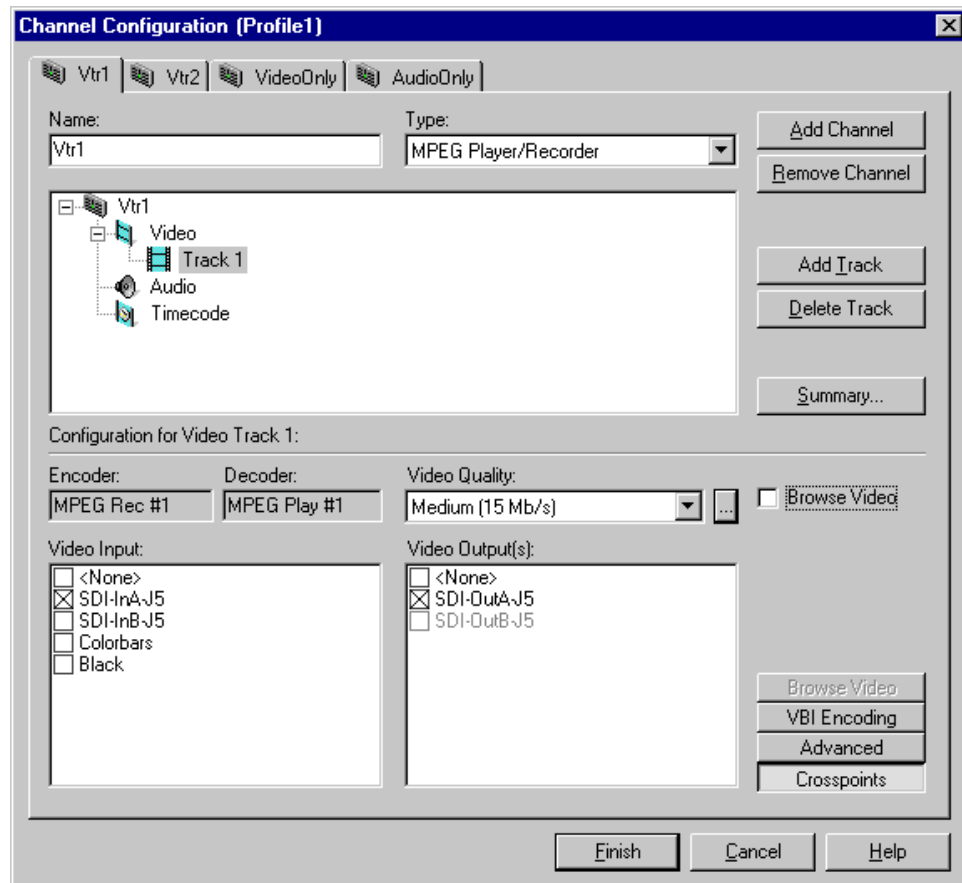

2. Click the tab for the channel you want to modify.
3. Click the Video icon (), then click the video track you want to modify.
4. Click the **Crosspoints** button, then select the video input and video outputs you want to use.

For information on why resources appear dimmed, red, or “in use”, refer to Chapter 4, “Why resources appear dimmed, red, or in use” page 90.

5. Click **Finish** to save your changes and close the Channel Configuration dialog box.

NOTE: *If the channel is currently in use by an application, it must be reselected within the application before your changes will take effect. Refer to the user manual for the Profile application you are using.*



Selecting video quality for a channel

You can manage storage capacity and video quality by adjusting the channel MPEG-2 compression settings. Using the Video Quality drop-down list, you can change compression settings by selecting one of the video quality presets provided (shown in the table), or you can define and select a custom preset. Selecting a preset determines the data rate, chrominance sampling method and group of pictures (GOP) structure used during recording.

Quality Preset	MPEG-1 Data rate in Mbps (Browse Video)	MPEG-2 Data rate in Mbps	Chrominance Sampling Method	Group of Pictures (GOP) ^a
Draft	.4	4	4:2:0	IBBPBBPBBPBBPBBP (default)
Low	.8	8		
Medium (default)	1.2	15	4:2:2	
High (VHS Quality, default for browse video)	1.5	24		
Custom 1 to 4	.3-1.5 in increments of .1	4-50 in increments of 4 (12 default)	4:2:2 (default) or 4:2:0	Choose from I, IP, IBP, IBBP, IBPB, IBBPBBP, IBPBPBPB, IBBPBBPBBP, IBBPBBPBBPBBP, and IBBPBBPBBPBBPBBP (default)

^a. Profile XP applications can play but not record clips using open GOP, however, 3rd party applications can be written for the Profile XP system that do both.

Guidelines for selecting Video Quality Presets

With the Profile XP Media Platform, you can improve picture quality for your available storage capacity by selecting chrominance sampling method and GOP length for a given video data rate.

The type of video and how it will be used largely determines the compression settings you should select. It is important to understand the type of material you will be broadcasting and select the appropriate compression settings.

Use the following guidelines when choosing one of the video quality presets or defining and selecting a custom preset. For more information on the relationship between picture quality and the type of video, data rate, chrominance sampling method, and GOP look for the white paper, *An Analysis of MPEG Encoding Techniques on Picture Quality* on the Grass Valley Group web site. You can also refer to commercially available books on video compression.

Guidelines for selecting video quality presets:

- **Data Rate** - Selecting the data rate tells the encoder how much data or how many bits to use to compress the picture. Generally set as high as possible to obtain the storage capacity needed. Also consider the following:
 - Sports footage (video containing lots of motion) requires significantly higher video data rates than an interview show.
 - Clips with lots of chrominance, typical of many commercials, require higher

data rates to maintain quality.

-Higher data rates should be used for any production work that requires multiple generations or when the material is subject to up-conversion to HDTV.

NOTE: *Information about Profile XP system storage capacities for different video data rates is located in Chapter 3, "Working with Profile XP storage systems" on page 58.*

- **Chrominance Sampling Method** - Options include 4:2:2 and 4:2:0. Consider the following guidelines:
 - Select 4:2:2 encoding whenever storage capacity allows it, especially when you know the video is subject to up-conversion to HDTV or is being used in a production environment where it will experience multiple generations.
 - For video not subject to up-conversion or multiple generations, 4:2:0 sampling can be used for slightly better picture quality below 10Mb/s since the reduction in chrominance information allows more detail in the luminance information. However, reducing chrominance information by half does impact picture quality in a video sequence with large chrominance variance.
- **GOP Length** - Determines the number and structure of I, P, and B frames. Since B frames contain 25% of the information of an I frame and a P frame contains about 50%, significant storage efficiencies can be realized with long GOP structures. In general then, lengthening the GOP structure allows operation at lower data rates for equivalent picture quality. Consider the following guidelines:
 - Choose the longest GOP structure possible as the storage benefits outweigh the picture quality improvements.
 - Use I frame only and short GOP structures for editing applications which need flexibility in performing insert edits.
 - Use I frame only for off speed play.



Selecting video quality settings for a channel

To select channel video quality:

1. Choose **Channel Configuration** in the Configuration Manual window. The Channel Configuration dialog box appears.

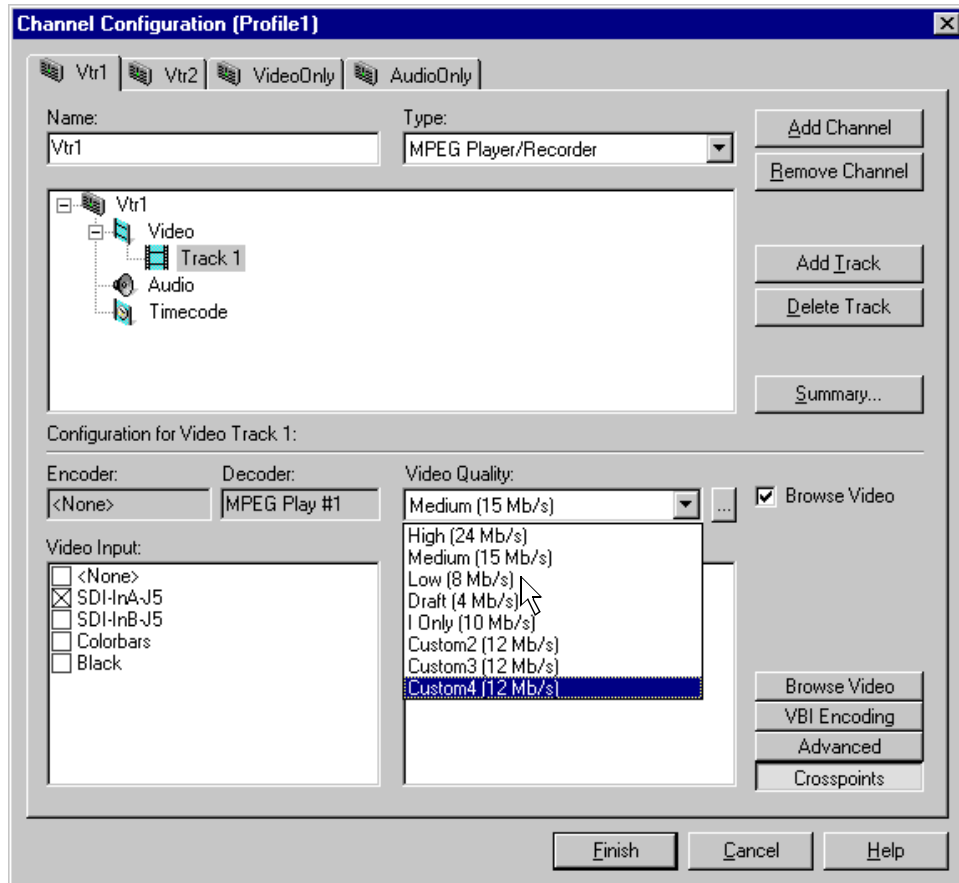

2. Select the tab for the channel you want to modify, then use the Video Quality drop-down list to select the video quality preset you want to use.

3. To view the properties for the video quality preset you select, click the Video Quality settings button () next to the Video Quality drop-down list.

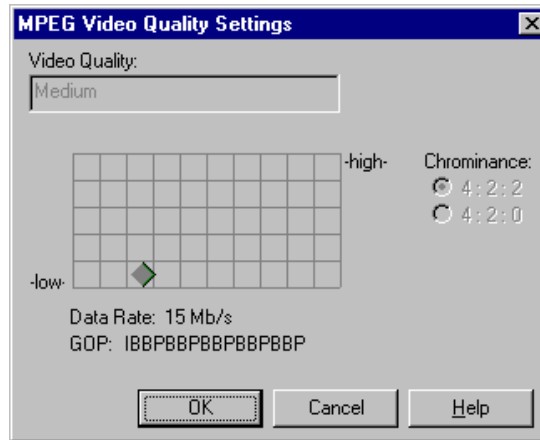

4. Click **Finish** to save your changes and close the Channel Configuration dialog box.

NOTE: *If the channel is currently in use by an application, it must be reselected within the application before your changes will take effect. Refer to the User Manual for the Profile application you are using.*

Selecting browse video quality settings for a channel

When browse video is enabled, you can make settings for the MPEG-1 video quality in much the same way as you do for the MPEG-2 video.

To select channel video quality:

1. Choose **Channel Configuration** in the Configuration Manual window. The Channel Configuration dialog box appears.
2. Select the tab for the channel you want to modify, then click the Browse Video button.



3. Use the Browse Video Quality drop-down list to select a browse video quality preset.

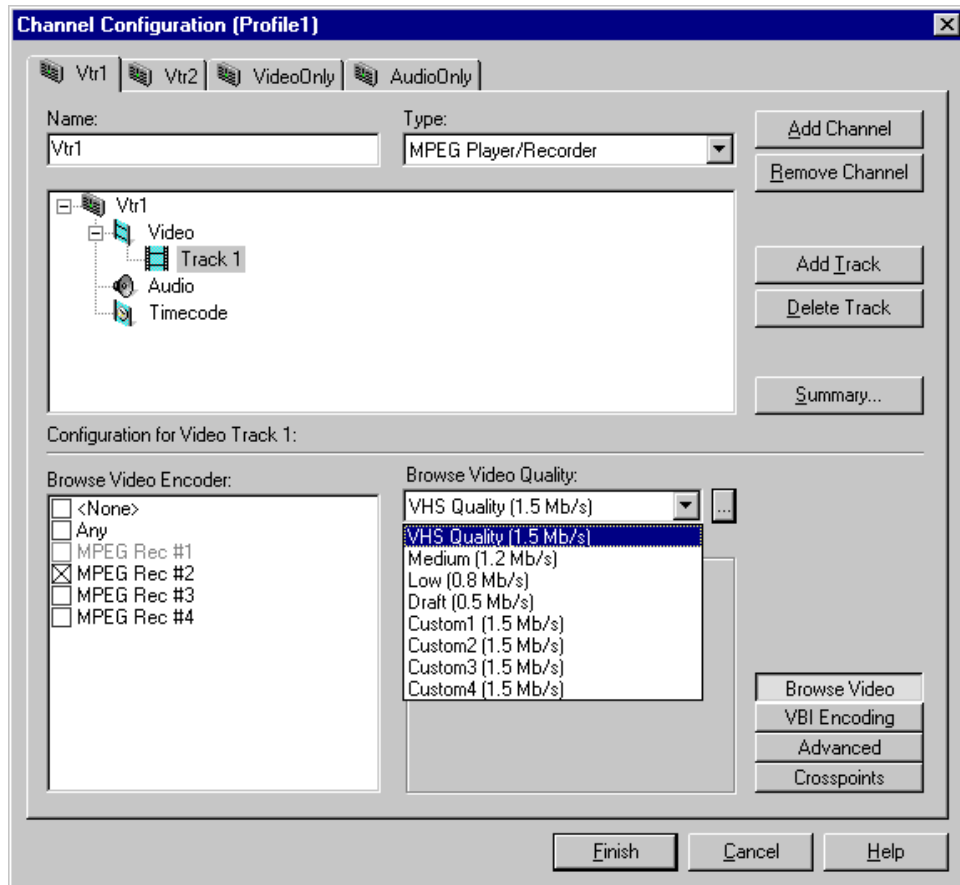

4. To view the properties for the video quality preset you select, click the Video Quality settings button () next to the Browse Video Quality drop-down list.

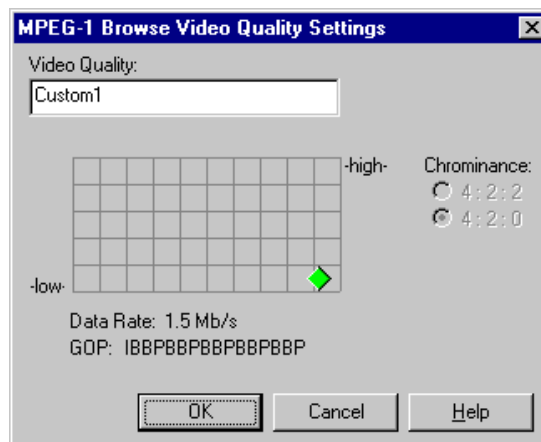

5. Click **Finish** to save your changes and close the Channel Configuration dialog box.

Defining and selecting a custom video quality preset

You can modify the custom presets provided in the Video Quality drop-down list. Using custom settings, you can more closely manage signal quality and record capacity by choosing the chrominance sampling method, group of picture length (GOP), and bit rate best suited for your application.

To modify the settings for a custom video quality preset:

1. Choose Channel Configuration in the Configuration Manager window. The Channel Configuration dialog box appears.
2. Click the tab for the channel you want to modify. If you want to modify a browse video setting, click the Browse Video button.
3. Select one of the custom presets in the Video Quality drop-down list.
4. Click the Video Quality Settings button (). The MPEG Video Quality Settings dialog box (on the left) or the MPEG-1 Browse Video Quality Settings dialog box (on the right) appears.

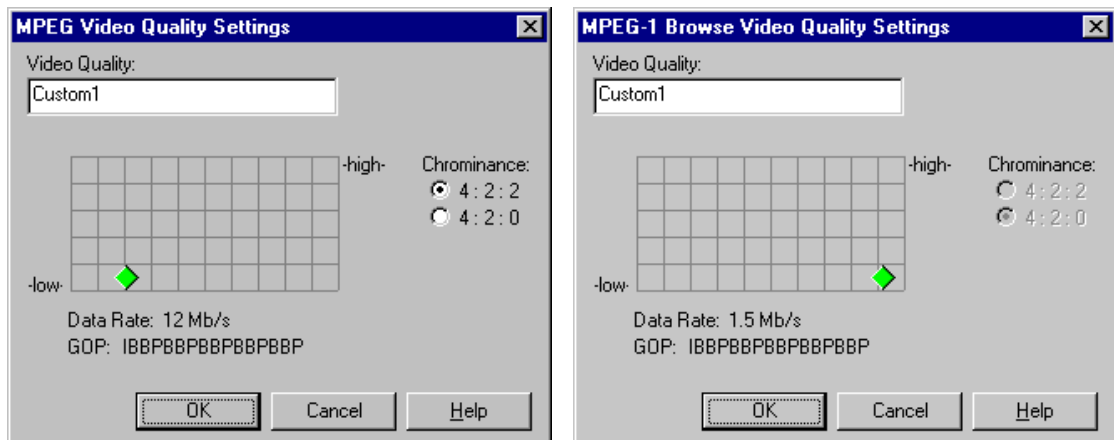

5. Click and drag the diamond on the grid to change the bit rate and group of pictures (GOP) settings, and click the button for the desired chrominance sampling (note that you cannot change the chrominance setting for browse video).

The settings used for the **High**, **Medium**, **Low**, and **Draft** presets can be used as reference points when you are making a custom setting.

You can change the preset name while in the dialog box.

6. Click **OK** when your finished.
7. Click **Finish** to save your settings and close the Channel Configuration dialog box.

NOTE: *If the channel is currently in use by an application, it must be reselected within the application before your changes will take effect. Refer to the User Manual for the Profile application you are using..*



Recording VBI information uncompressed

The Profile XP Media Platform provides the ability to store up to 6 lines of uncompressed Vertical Blanking Interval (VBI) information along with your clips. This feature is desirable for uses such as closed captioning which would be seriously degraded by losses incurred at lower video compression data rates. However, storing VBI information in uncompressed form can add up to 3Mbs to your storage requirements.

Specifying lines of VBI information to store uncompressed involves using the Channel Configuration dialog box to select which lines the channel will treat as uncompressed data.

To select which VBI lines to record as uncompressed data:

1. Choose Channel Configuration in the Configuration Manager dialog box. The Channel Configuration dialog box appears.
2. Click the tab for the channel you want to modify, then the Video Track icon () in the configuration tree.

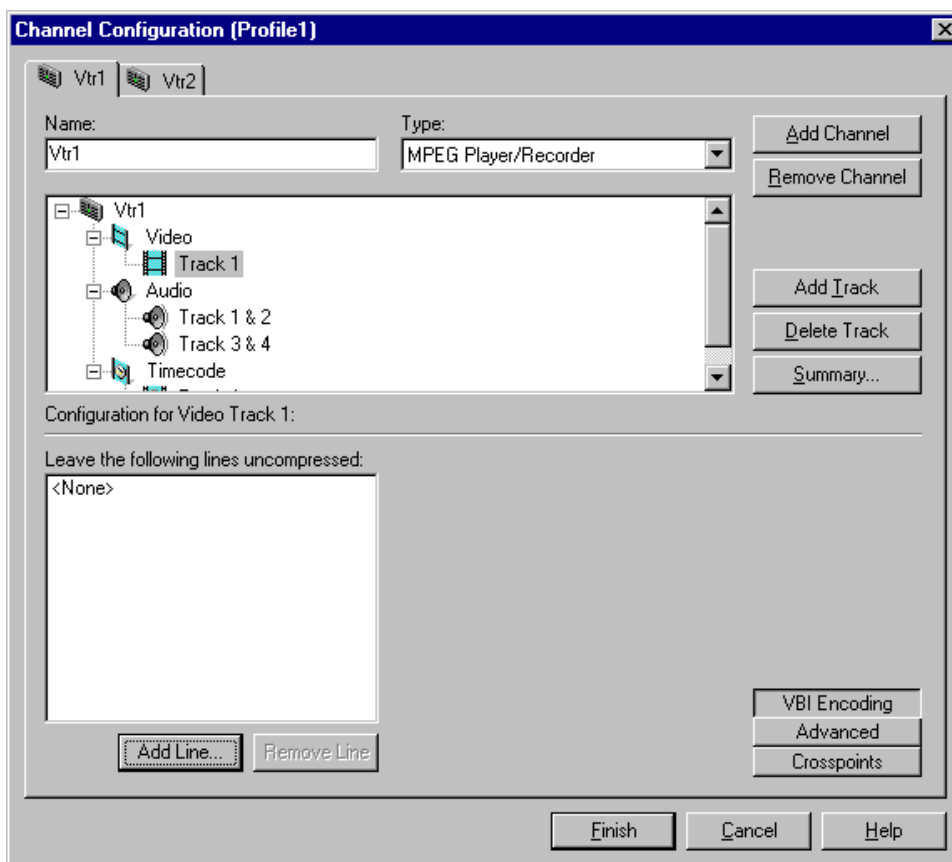

3. Click **VBI Encoding**. The lines treated as uncompressed data are listed.
4. To remove lines, select a line number, then click **Remove**.

5. To add lines to the uncompressed lines list:
 - a. Click **Add**. The Add VBI line dialog box appears.

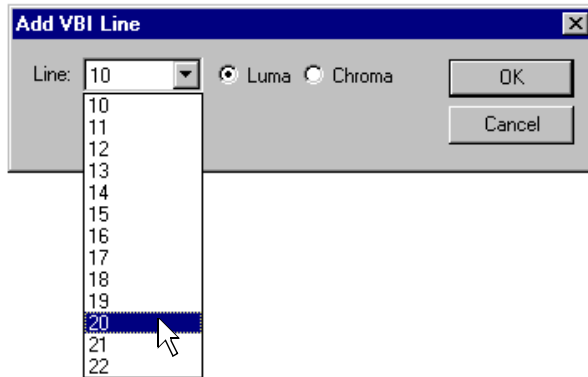

- b. Select a line number using the **Line** drop-down list.
 - c. Select whether to preserve **Luma** or **Chroma**. Preserving luma and chroma requires two lines of data.
 - d. Click **OK** to add the line to the list of uncompressed lines.
 - e. Repeat step a through step d to add other lines to the uncompressed lines list. You can add up to six lines.
6. Click **Finish** to save your changes.

NOTE: *If the channel is currently in use by an application, it must be reselected within the application before your changes will take effect. Refer to the chapter in the Profile XP User Manual for the Profile application you are using.*



Selecting the video still-play mode

The Profile XP Media Platform has two still-play modes for displaying video during freeze frame: Line Double and Interlaced. Line-Double is the default setting and uses the content of one field for both fields during still-play for a one field freeze. Interlaced mode displays two fields in still play mode for a two field freeze. With Interlaced, you may see some motion jitter in still-play. Line-Double eliminates motion jitter.

To select still-play mode:

1. Choose **Channel Configuration** in the Configuration Manager dialog box. The Channel Configuration dialog box appears.
2. Click the tab for the channel you want to modify.
3. Select the Video icon () in the configuration tree. The still-play mode controls appear at the bottom of the Channel Configuration dialog box.

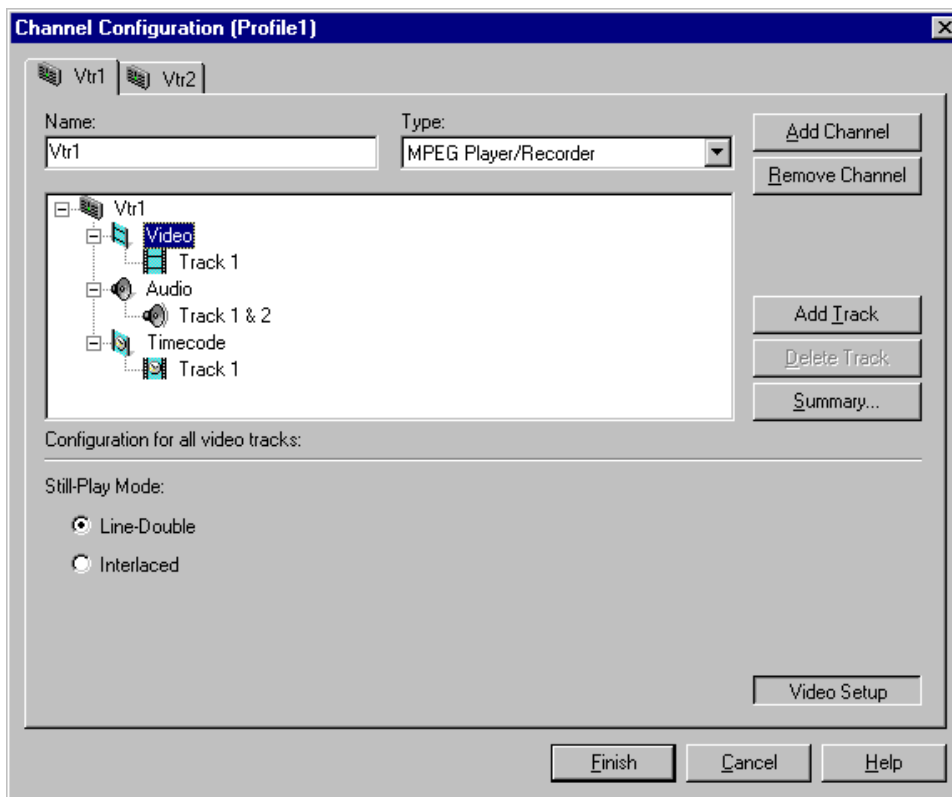

4. Select the still play mode you want to use.
5. Choose **Finish** to save your change and to close the Channel Configuration dialog box.

NOTE: *If the channel is currently in use by an application, it must be reselected within the application before your changes will take effect. Refer to the User Manual for the Profile application you are using.*

Viewing video input status

You can use Configuration Manager to check the status of the video input signal.

To check video input status:

1. Choose Video Input in the Configuration Manager window. The Video Input dialog box appears.

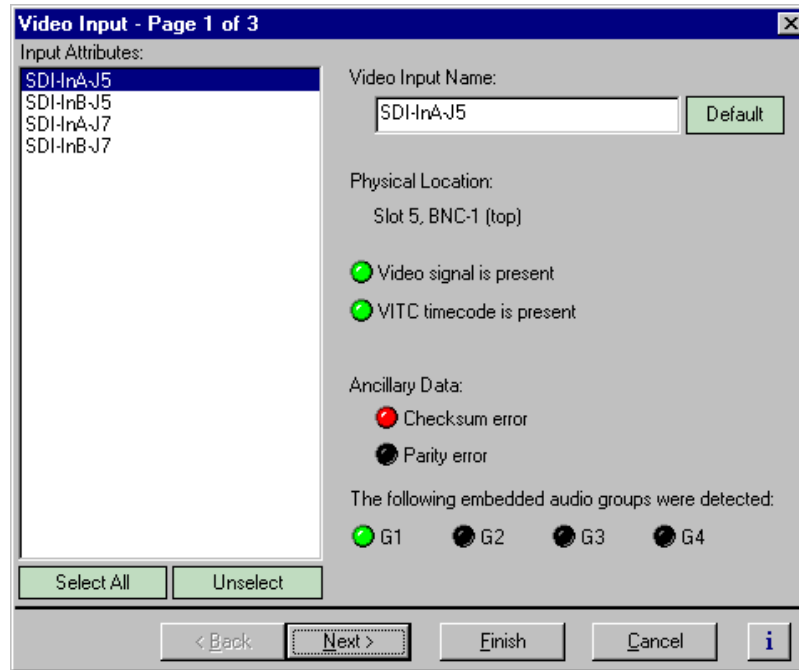

2. Select a video input from the Video Input list. The following table gives a description of the video input status indicators:

Status Indicators	Description
Embedded Audio Status	Indicates which embedded audio groups are present on the video input.
Video input status	Indicates the status of the video input signal.
VITC timecode status	Indicates the status of VITC timecode on the video input. May require setting up the VITC reader on page 2 of the Video Input dialog box.
Ancillary data status: Checksum and Parity	Indicates the status of the data extracted from the ancillary data space.



Modifying video input settings

You can modify the video input settings.

- You can select whether the input freezes or displays black when the video input signal is lost.
- You can select which lines of the vertical blanking interval will be recorded uncompressed.
- You can set up the VITC reader.

Setting up the VITC reader

All video inputs include VITC readers. A reader has two VITC detection modes: Automatic and Manual. When you select automatic detection, you can set the range of vertical interval lines scanned to find the VITC signal pair; lines 10 to 21 by default. Manual allows you to choose specific line numbers to detect the VITC signals. Automatic detection is the default setting. In manual VITC detection, you can specify the lines used to read VITC. Use manual detection when two sets of VITC are embedded in the video signal.

To set up the VITC reader:

1. Choose Video Input in the Configuration Manager window. The Video Input dialog box appears.
2. Click **Next** to navigate to Video Input page 2 of 3.

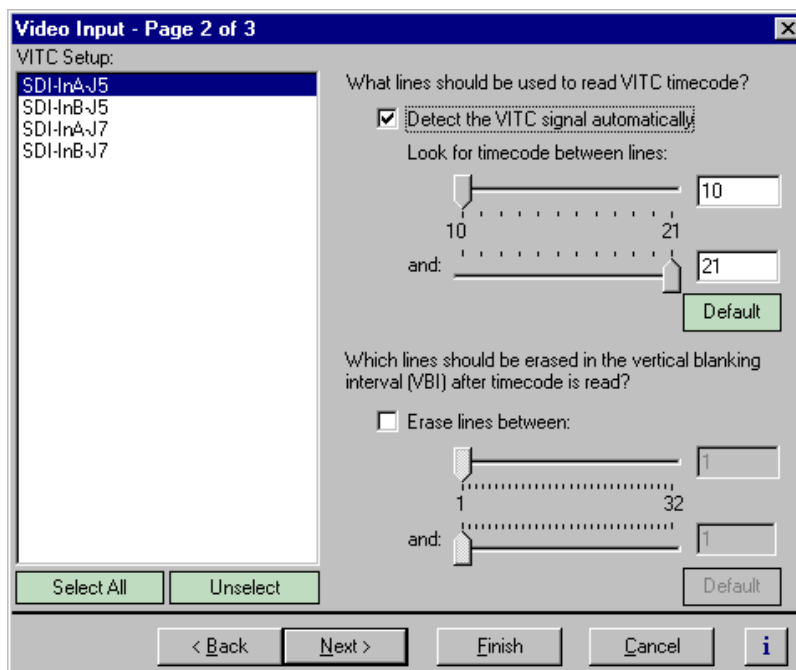

3. Select a video input from the list or click **Select All** to configure all video inputs at the same time.

4. Select one of the VITC timecode options as follows:

- Auto Detection - Select the **Detect the VITC signal automatically** check box, then enter the range of lines you want the system to search for VITC using the sliders.

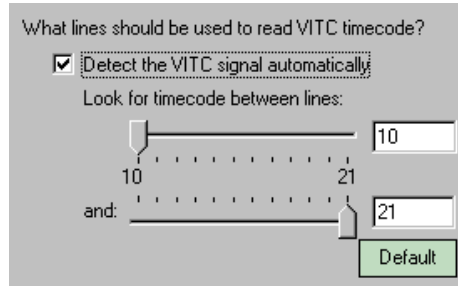

- Manual Detection - Clear the **Detect the VITC signal automatically** check box, then type or select the line numbers where the VITC pair can be found.

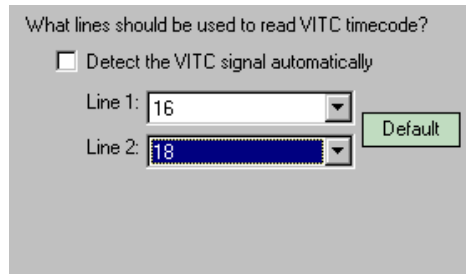

5. Click **Finish** to saving your settings.



Erasing video input VBI information

You can remove unwanted VBI information that may be present on video inputs so that the information is not recorded or fed through the system in E to E. You can select which VBI lines are erased by selecting the starting and ending line numbers between line 1 and line 32. Blanking occurs after VITC is read.

To blank lines in the vertical interval:

1. Choose **Video Input** in the Configuration Manager Window. The Video Input dialog box appears.
2. Click **Next** to navigate to Video Input page 2 of 3.

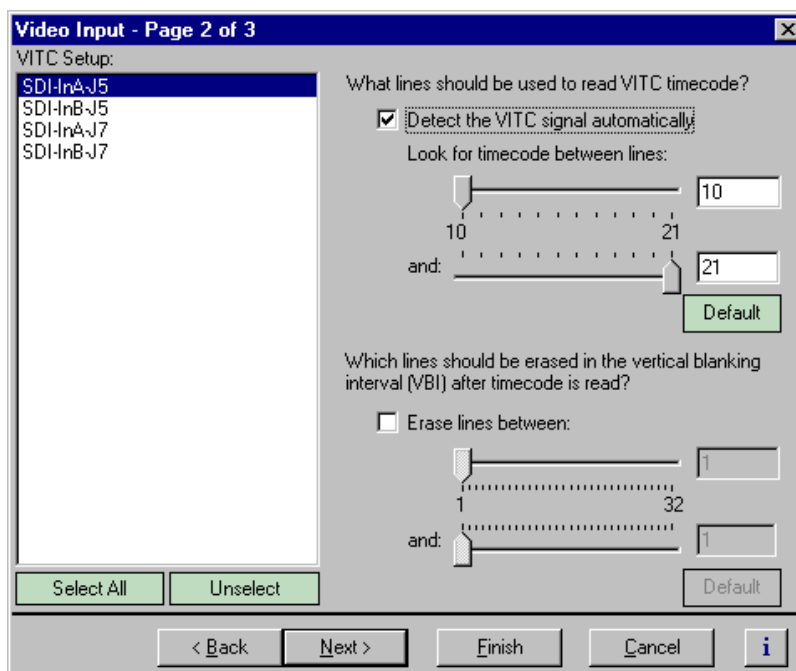

3. Select a video input from the list or click **Select All** to configure all the video inputs at the same time.

4. Perform one of the following:

- If you do not want to erase any lines, clear the **Erase lines between** check box.
- If you want to erase lines in the vertical interval, select the **Erase lines between** check box, then select the starting and ending lines numbers using the sliders.

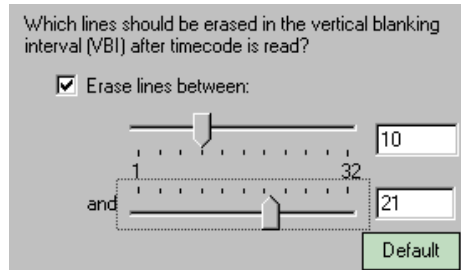

5. Click **Finish** to saving your settings.



Selecting freeze or black upon video input loss

You can select whether you want the Profile XP system to output black or freeze on the last frame of video when the video input signal is lost.

To configure setting for loss of video input:

1. Choose Video Input in the Configuration Manager window. The Video Input dialog box appears.
2. Click **Next** to navigate to Video Input page 3 of 3.

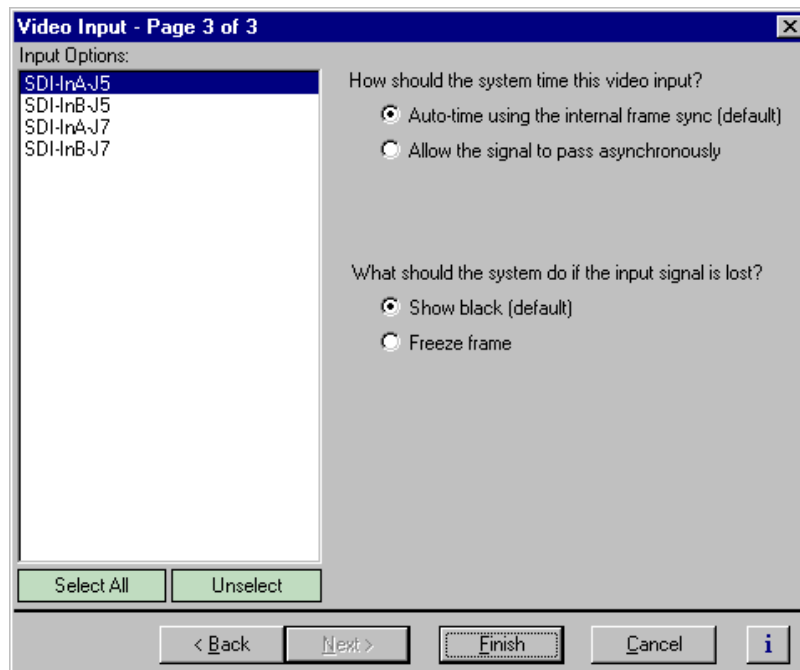

3. Select a video input from the list or click **Select All** to configure all video inputs at the same time.
4. Under “What should the system do if the input signal is lost?”, choose the option you want to use.
5. Choose **Finish** to saving your settings.

Modifying video output settings

Use Configuration Manager to change video output settings

- Set up the VITC generator
- Erase unwanted lines in the vertical blanking interval
- Erase the horizontal blanking interval
- Select whether the video output will freeze or display black when the video output is lost.

Setting up the VITC generator

All video outputs include VITC generators. You can select the line number used to insert the VITC signals.

To set up the VITC generator:

1. Choose **Video Output** in the Configuration Manager window. The Video Output dialog box appears.
2. Click **Next** to navigate to Video Output page 2 of 3.

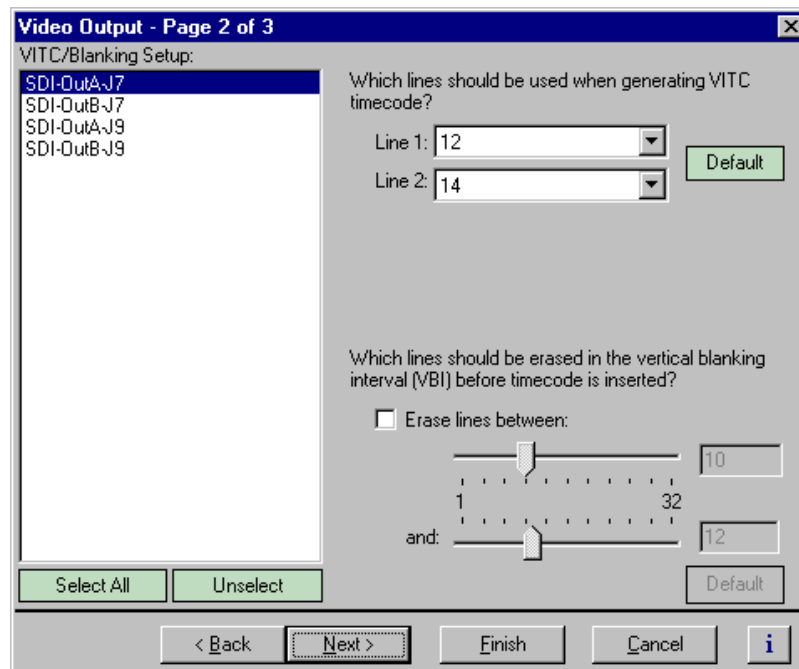

3. Select a video outputs from the list or click **Select All** to configure all video outputs at the same time.



4. Select the line numbers where the VITC pair should be generated using the **Line 1**, **Line 2** drop-down lists.

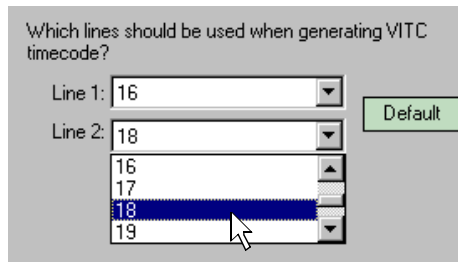

5. Click **Finish** to saving your settings.

Erasing video output VBI information

You can remove unwanted VBI information that may be present in a recorded video clip or on the output during E to E. You can select which VBI lines are erased by selecting the starting and ending line numbers between line 1 and line 32. Blanking occurs before VITC timecode is inserted.

To blank lines in the vertical interval:

1. Choose Video Output in the Configuration Manager Window. The Video Output dialog box appears.
2. Click **Next** to navigate to Video Output page 2 of 3.

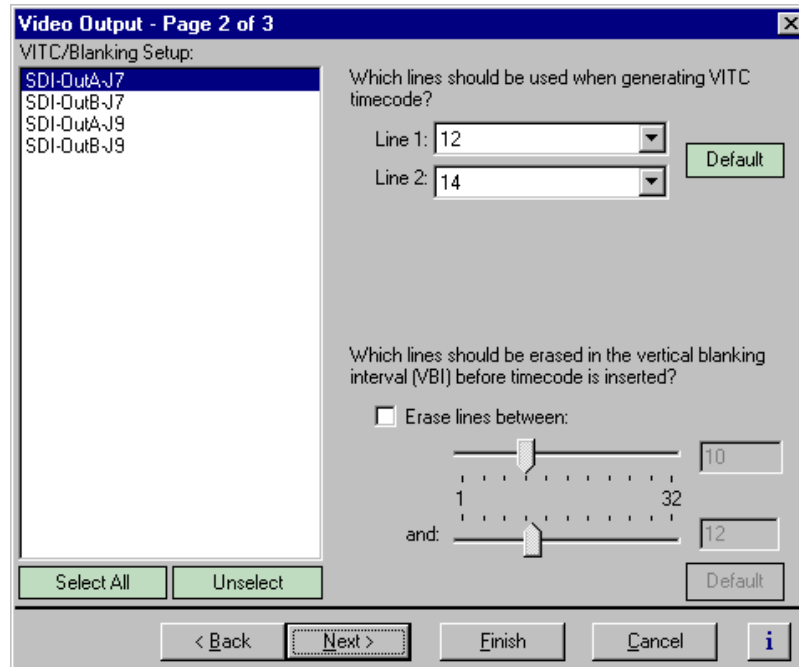



3. Select a video output from the list or click **Select All** to configure all the video outputs at the same time.
4. Perform one of the following:
 - If you do not want to erase any lines, clear the **Erase lines between** check box.
 - If you want to erase lines in the vertical interval, select the **Erase lines between** check box, then select the starting and ending lines numbers using the sliders.

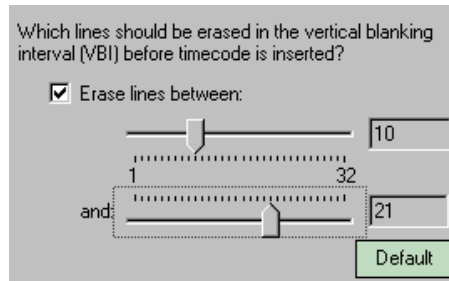

5. Click **Finish** to saving your settings.

Selecting freeze or black for video output signal loss

You can select whether you want the Profile XP system to display black or freeze on the last frame of video when the video output signal is lost.

To configure the setting for the loss of video output:

1. Choose Video Output in the Configuration Manager window. The Video Output dialog box appears.
2. Click **Next** to navigate to Video Output page 3 of 3.

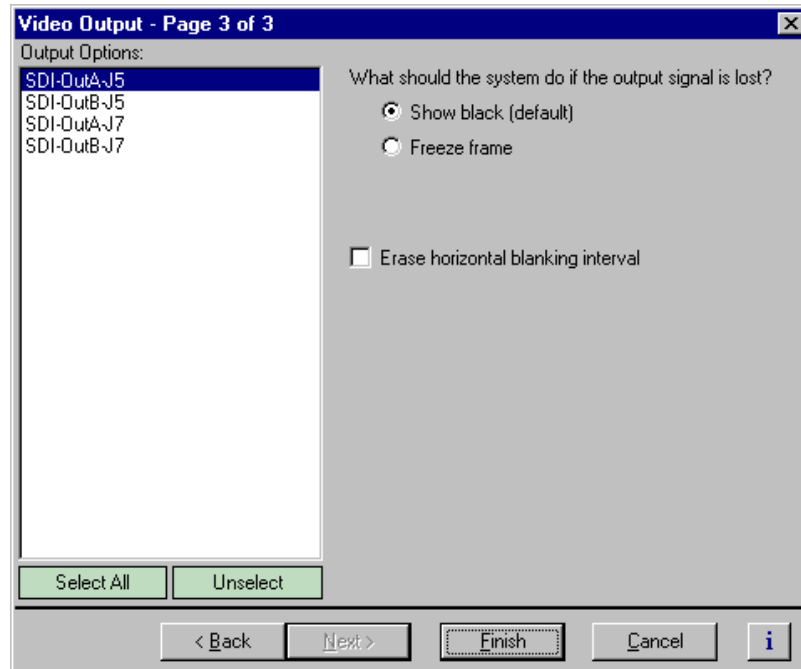

3. Select a video output from the list or click **Select All** to configure all the video outputs at the same time.
4. Select the output signal loss option you want to use.
5. Click **Finish** to saving your settings.



Erasing the horizontal blanking interval

You can configure a video output to erase the horizontal blanking interval. Use this feature to remove ancillary data such as Error Detection and Handling (EDH) information. Embedded audio present on the output is not effected.

To erase the horizontal blanking interval:

1. Choose Video Output in the Configuration Manager Window. The Video Output dialog box appears.
2. Click **Next** to navigate to Video Output page 3 of 3.

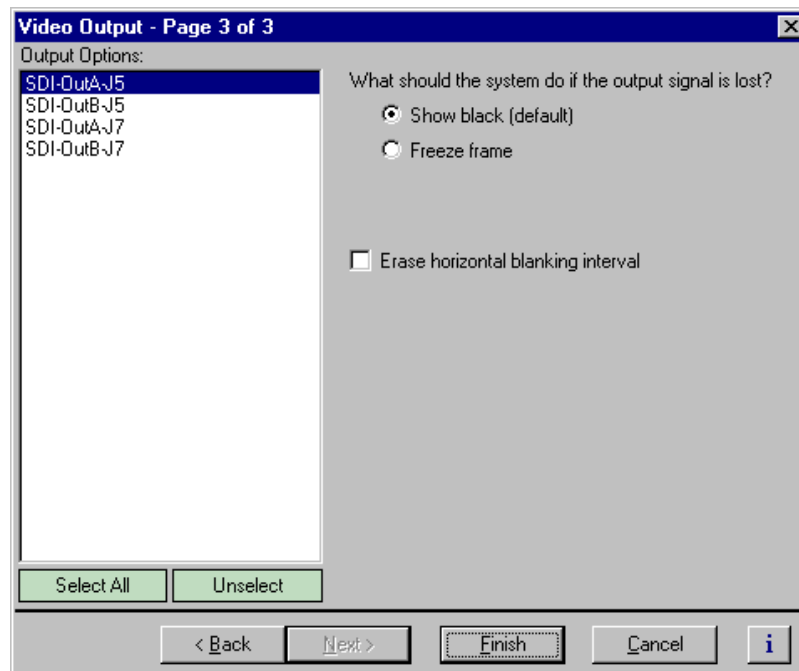

3. Select a video output from the list or click **Select All** to configure all the video outputs at the same time.
4. Select the **Erase horizontal blanking interval** check box.
5. Click **Finish** to saving your settings.

Renaming video I/Os in crosspoint lists

You can change the names of video inputs and outputs. This allows you to use more meaningful names for them in the Channel Configuration dialog box.

Renaming the video inputs

To rename the video input:

1. Choose Video Input in the Configuration Manager window. The Video Input dialog box appears.

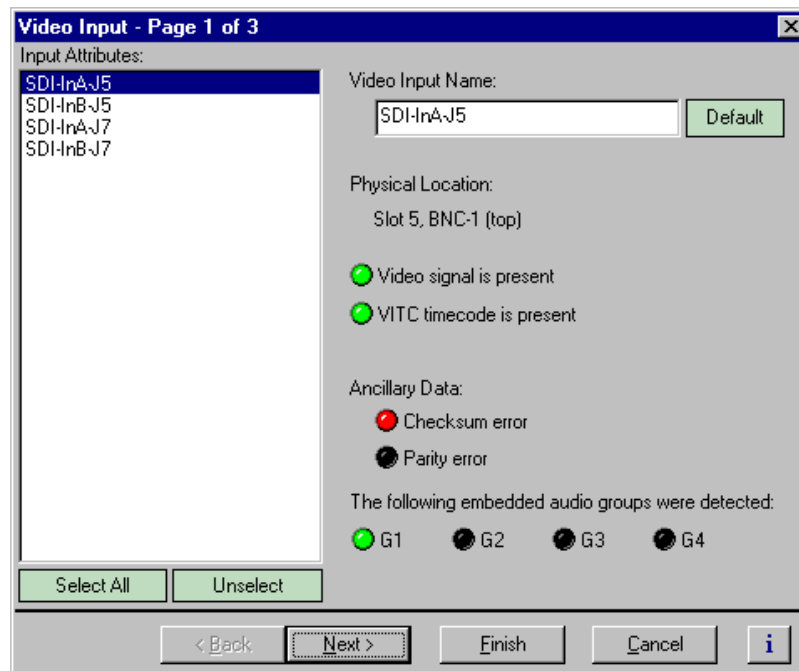

2. Select a video input in the Video Inputs list.
3. Enter a name for the video input in the **Video Input Name** box or click **Default** to restore the factory-default video input name.
4. Select another video input or click **Finish** to saving your settings.



Renaming the video outputs

To rename the video output:

1. Choose Video Output in the Configuration Manager window. The Video Output dialog box appears.

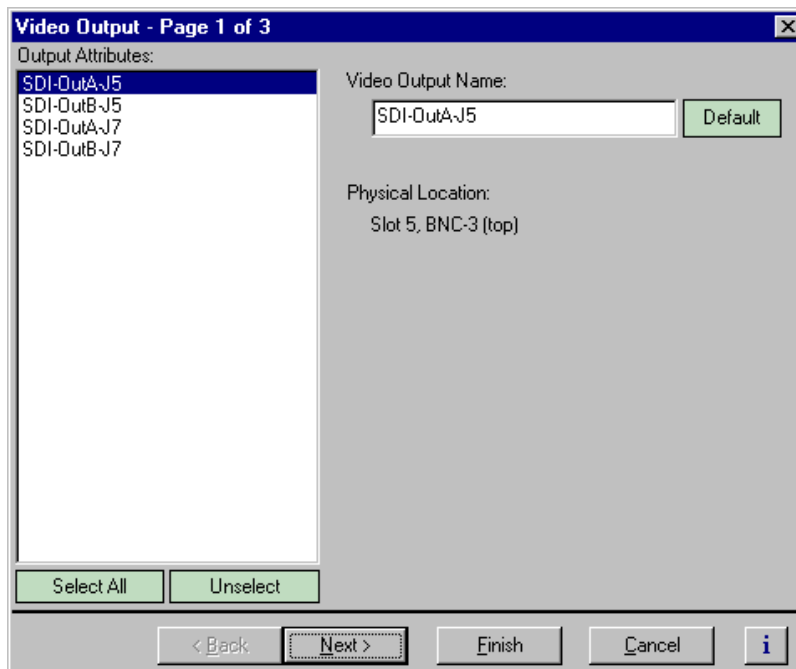

2. Select a video output in the Video Output list.
3. Enter a name for the video output in the **Video Output Name** box or click **Default** to restore the factory-default video output name.
4. Select another video output or click **Finish** to saving your settings.

Configuring the video monitor output

You can set up the text overlay and timecode burnin feature for the optional Video Monitor board. Setup includes entering screen text and selecting text size and color scheme best suited for your application.

Enabling or disabling dither on the Video Monitor output

The Video Monitor board truncates digital video data from 10 bits to 8 bits before converting it to analog. Using dither in this process reduces the effect of quantization noise on the Video Monitor output.

To enable dither:

1. Select **Video Monitor** in the Configuration Manager window. Page 1 of the Video Monitor dialog box appears.

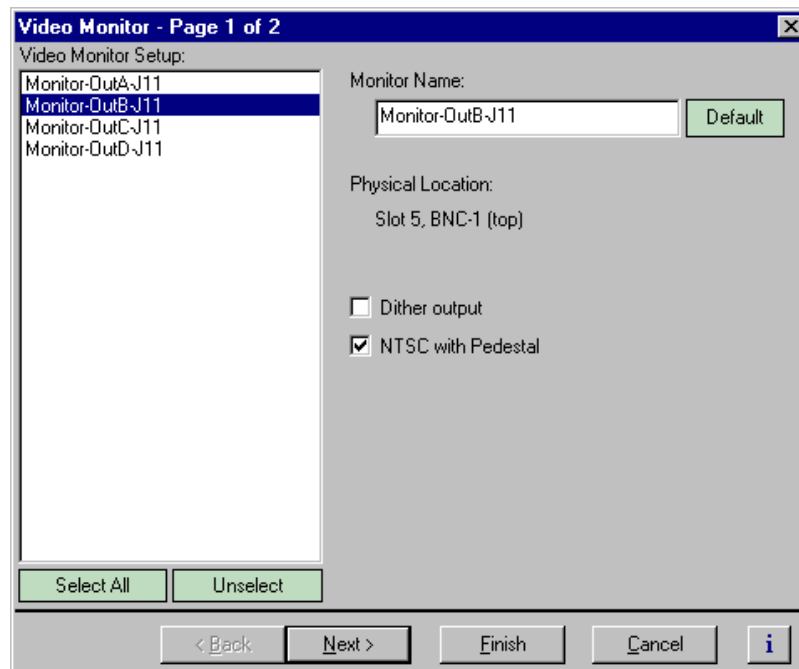

2. Choose a monitor output in the Video Monitor Setup list or click **Select All**.
3. Click the **Dither output** check box to enable dither for truncating 10 bit to 8 bit video.
4. Click **Finish** to saving your settings.



Enabling or disabling NTSC pedestal

When the Profile XP system is configured in the 525/60 standard, the Video Monitor board generates NTSC signals. You can select whether or not the NTSC output includes the 7.5 IRE pedestal. Use NTSC with Pedestal if your video monitors were calibrated using signals with 7.5 IRE setup.

To enable or disable NTSC pedestal:

1. Select Video Monitor in the Configuration Manager window. Page 1 for the Video Monitor dialog box appears.

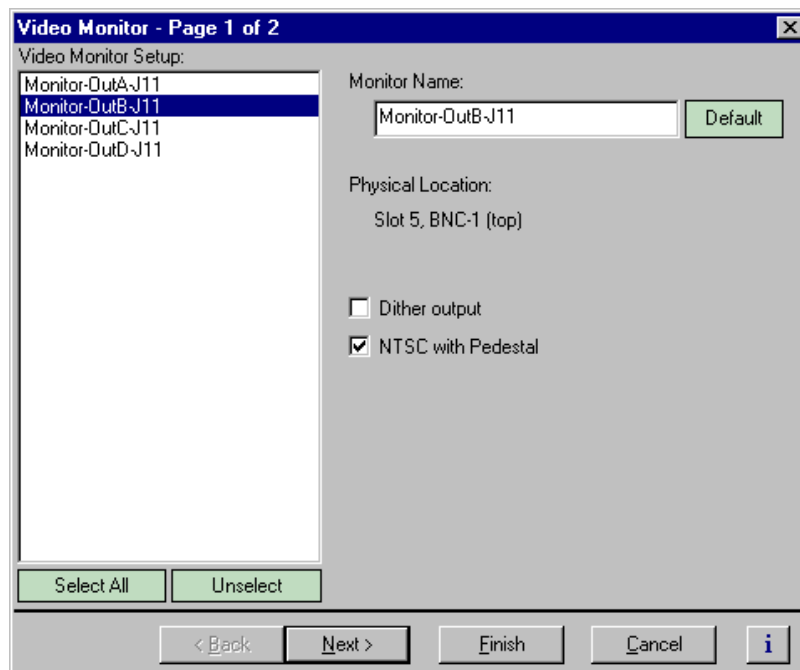

2. Choose a monitor output in the Video Monitor Setup list, or click **Select All**.
3. Use the check box to enable or disable the 7.5 IRE pedestal as required.
4. Click **Finish** to save your settings.

Configuring Text Overlay on the Video Monitor output

Use text overlay to generate characters on the Video Monitor outputs for source identification. Depending on whether you choose large or small text size, you can display the following:

Text Size	Number of Text lines	Maximum Characters per line
Large	6	21
Small	12	12

To configure text overlay:

1. Select **Video Monitor** in the Configuration Manager window. The Video Monitor dialog box appears.
2. Click **Next** to navigate to Video Monitor page 2 of 2.

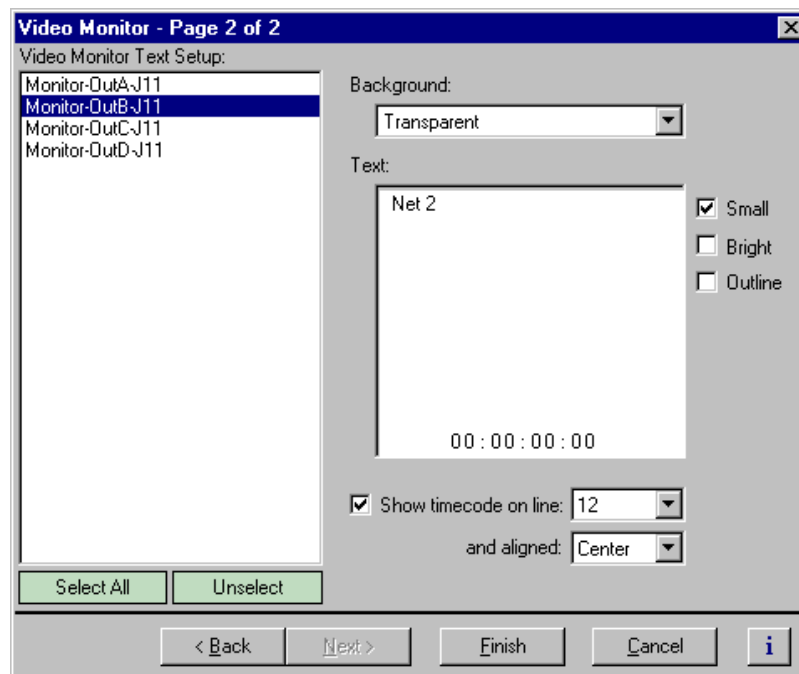

3. Choose a monitor output in the Video Monitor Setup list.
4. Select large or small text size, then click in the **Text** entry window and enter the text you want to display on the monitor output.

NOTE: Changes in text formatting also affect the timecode burnin.



5. Select the text options; **Bright** or **Outline**. You may want to experiment to discover which text options are the best suited for your application.
6. Select text background using the **Background** drop-down. Choose **Transparent** or **Opaque**.
7. Select another video monitor output to modify, or click **Finish** to saving your settings.

Enabling Video Monitor timecode burn-in

You can enable timecode burnin on the Video Monitor outputs. Once enabled, you must select a source of timecode for the Video Monitor output. To select the source of timecode source, refer to Chapter 7, “Selecting the video output as a timecode output for the channel,” on page 182.

To configure timecode burn-in:

1. Select **Video Monitor** in the Configuration Manager window. The Video Monitor dialog box appears.
2. Click **Next** to navigate to Video Monitor page 2 of 2.

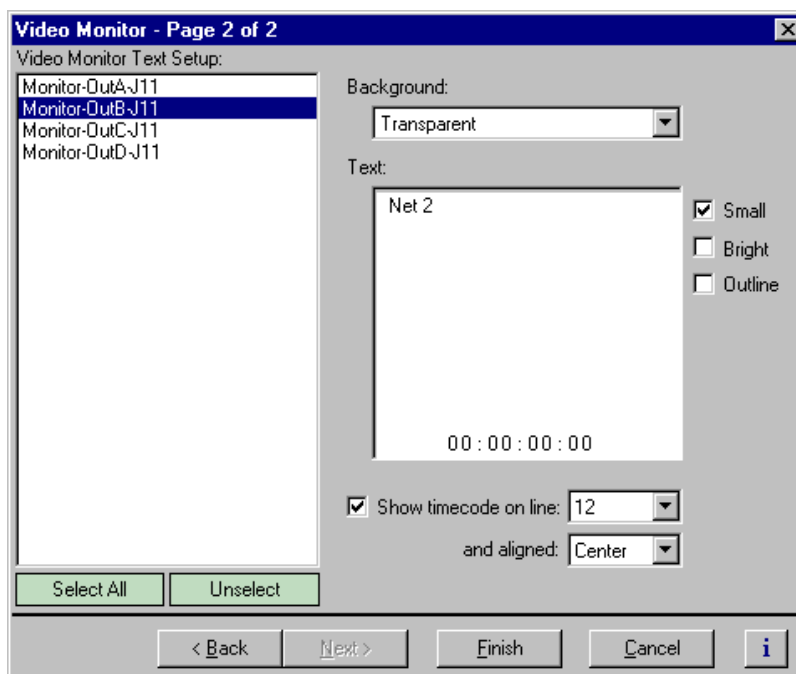

3. Choose a monitor output in the Video Monitor Setup list or click **Select All**.
4. Select the **Show Time Code** check box.

5. Select the text line number using the drop-down lists.

Twelve text lines are available for small text. Six lines are available for large text.

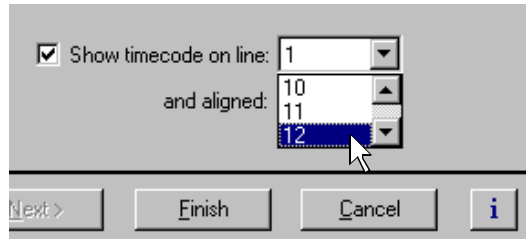

6. Select timecode alignment using the drop-down list.

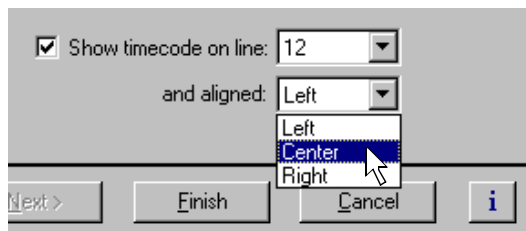

7. Select text formatting as desired. You may want to experiment with text formatting to see what looks best in your application.

Changes in timecode text formatting also effect the text overlay.

8. Select another video monitor output to modify, or click **Finish** to save your settings.

NOTE: To select the source of video timecode for the video monitor output timecode burn-in, refer to Chapter 7, “Selecting the video output as a timecode output for the channel,” on page 182.





Using multiple video tracks for one channel

You can assign multiple video tracks to a single channel. You can use this feature when working with key and fill. To play out all tracks simultaneously, you must be sure to play the clip on a play channel configured for at least the same number of video tracks.

To add a video track to a channel:

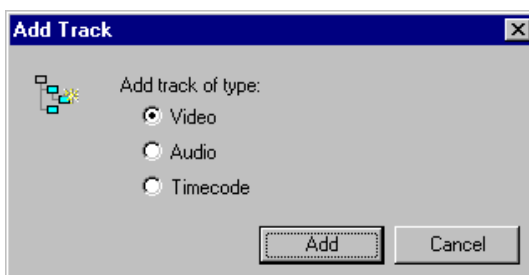
1. Select Channel Configuration in the Configuration Manager window. The Channel Configuration dialog box appears.
2. Click the tab for the channel you want to modify, then click **Add Track**. The Add Track dialog box appears



3. Select **Video**, then **Add**. The new video track icon () will appear in the configuration tree.

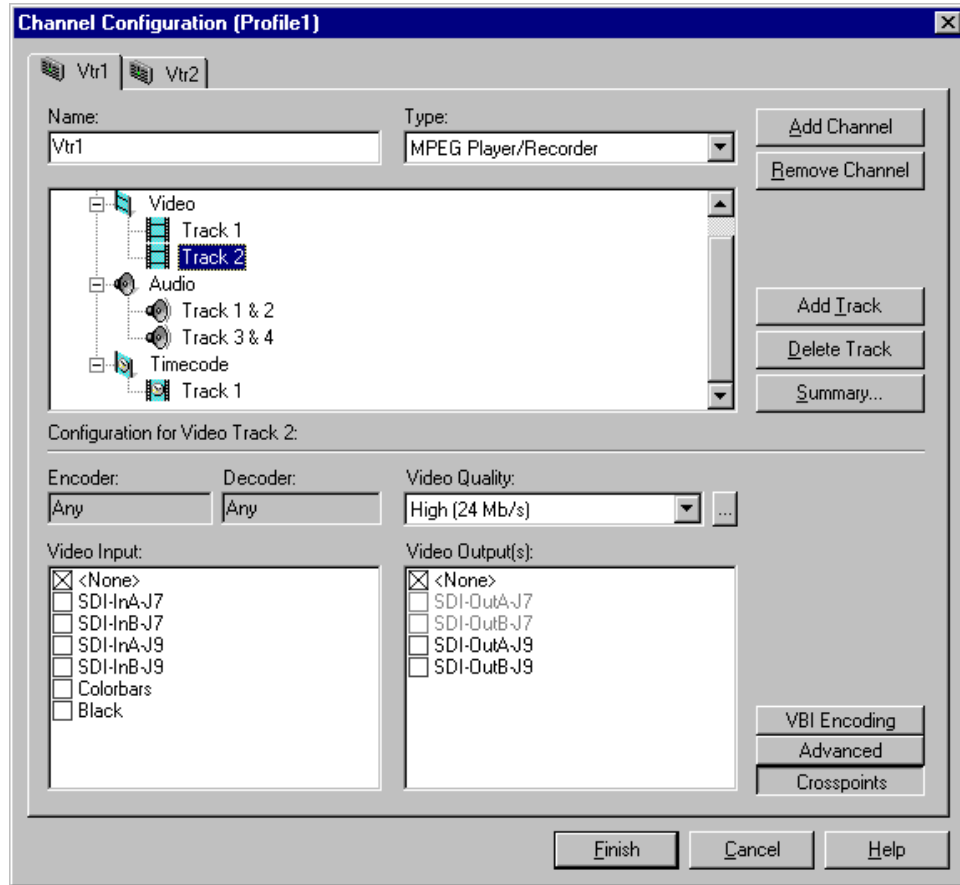

- Select a video quality preset for the new track using the video quality list box. All video quality settings are shown in the following table. See “Selecting video quality for a channel” on page 118 for guidelines on selecting video quality presets.

Quality Preset	Data rate in Mbps	Chrominance Sampling Method	Group of Pictures (GOP)
Draft	4	4:2:0	IBBPBBPBBPBBPBBP (default)
Low	8		
Medium (default)	15	4:2:2	
High	24		
Custom 1 to 4	4-50 in increments of 4 (12 default)	4:2:2 (default) or 4:2:0	Choose from I, IP, IBP, IBBP, IBPBP, IBPBBP, IBPBBPBBP, IBPBBPBBPBBP, IBPBBPBBPBBPBBP, and IBPBBPBBPBBPBBPBBP (default)



5. Click **Crosspoints**, then do one or both of the following:
 - a. For MPEG Recorder and MPEG Player/Recorder channel types, select a video input from the Video Input check boxes.

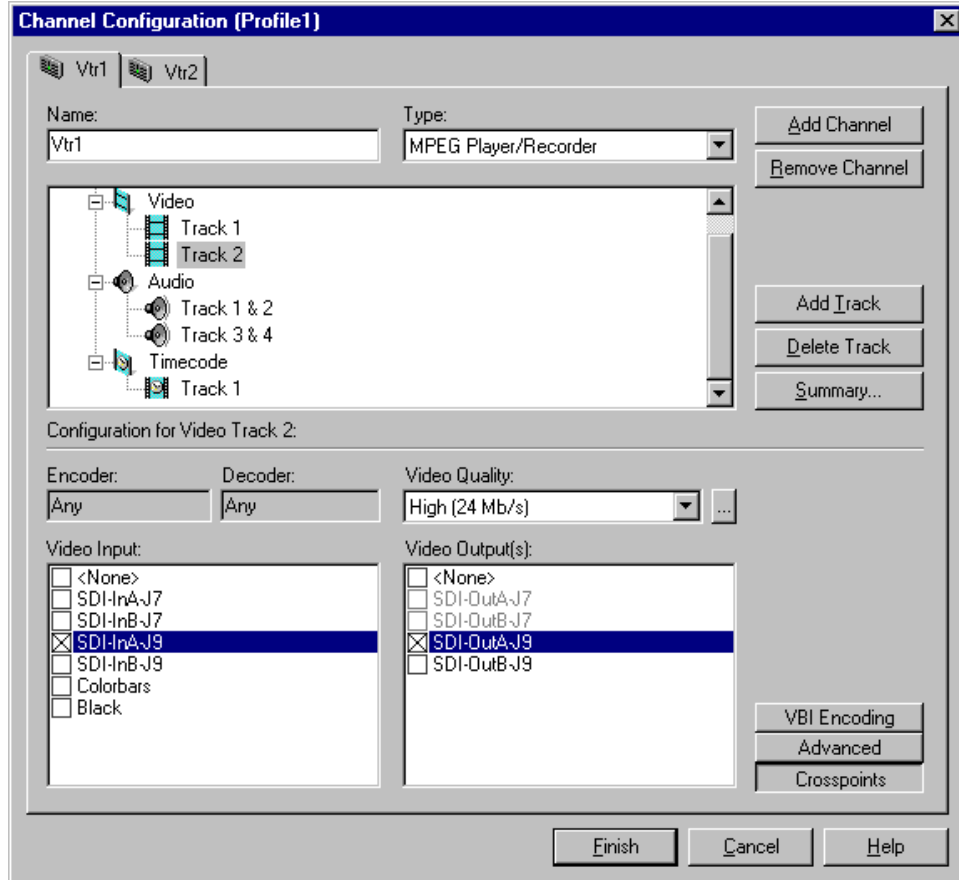

- b. For MPEG Player and MPEG Player/Recorder channels, select video outputs from the Video Output(s) check boxes.
3. Click **Finish** to save your changes and close the Channel Configuration dialog box.

Modifying a Channel: Audio Settings

You can customize audio settings for record or play channels. For example, you can change the number of audio tracks per channel or change the input or output audio format for a channel. This chapter describes how to modify your audio settings.

About Profile XP Audio

The Profile XP Media Platform supports from 16 to 32 channels of audio I/O and the following audio formats:

- Embedded audio (up to 8 channels per video I/O)
- AES/EBU (interface chassis required)
- Analog (interface chassis required)

Determining the number of audio channels available

The Profile XP Media Platform audio system is built around the Audio board. A Profile XP audio board provides 16 channels of audio I/O. A Profile XP may have up to 2 audio boards.



Determining the audio formats available

The Profile XP system can be configured to operate with analog, AES/EBU digital, and digital embedded (SMPTE 272M Level A) audio. An interface chassis is required for analog audio and AES/EBU digital audio as shown in the table. If you are using only embedded audio, no interface chassis is required.

NOTE: *Interface chassis must be connected to both Audio boards for operation with 32 channels of analog or AES/EBU digital audio.*

Audio Chassis Models ^a	Number of Analog Audio Channels	Number of AES/EBU Audio Channels	Comments
PAC216 (includes PACXLR breakout chassis)	16	16	The 16 audio channels on the Profile XP audio board are divided into eight audio pairs. You can assign the input for each audio pair to either the analog or digital inputs of the PAC216. For example, the input to channels 1 & 2 can be assigned to analog input 1 & 2 or digital input 1 & 2 on the PAC216. The audio output channels 1 to 16 are always assigned to both analog and digital outputs 1 to 16 on the PAC216.
XLR216	none	16	Provides digital audio interface using XLR connectors.
BNC216	none	16	Provides digital audio interface using BNC connectors.

^a. See Appendix C for detailed rear panel views of the audio interface chassis.

Adding or removing audio tracks

All audio configuration is done using audio channel pairs. Therefore, adding or removing audio tracks in the Channel Configuration dialog box adds or removes a pair of audio tracks.

After adding audio tracks you must select an audio channel pair to use for the tracks.

Removing audio tracks

To remove audio tracks:

1. Select Channel Configuration in the Configuration Manager window.
2. Select the tab for the channel you want to configure.
3. Select an audio **Track** pair under the Audio icon (🔊) in the configuration tree.

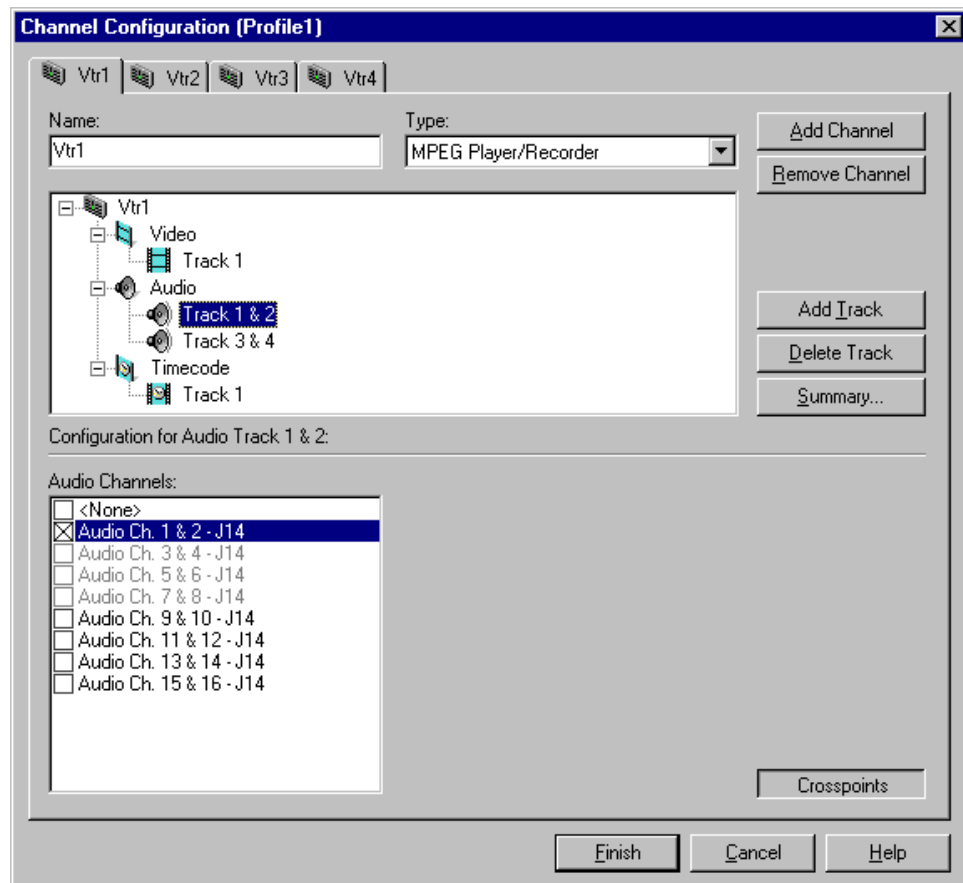

4. Click the **Delete Track** button in the configuration tree.
5. Click **Finish** to save your changes.



Adding audio tracks

To add audio tracks:

1. Select Channel Configuration in the Configuration Manager window.
2. Select the tab for the channel you want to configure.
3. Select Audio icon (🔊) in the configuration tree. The Audio Channels list appears at the bottom of the Channel Configuration dialog box.
4. Click the **Add Track** button. The Add Track dialog box that appears.

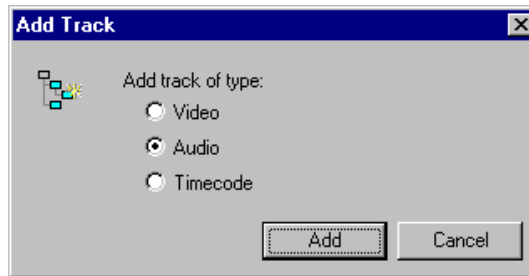

5. Select **Audio**, then click **Add**. The new audio track pair icon appears in the configuration tree.

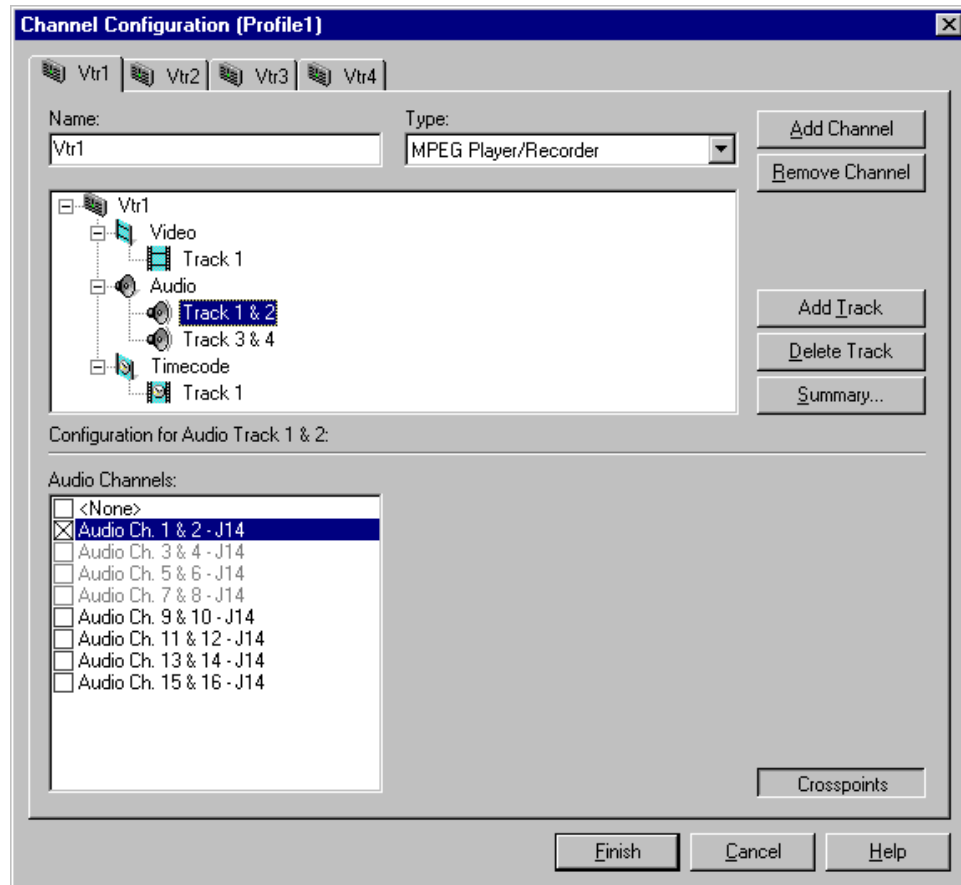

6. Use the check boxes in the Audio Channels list to assign an audio channel I/O pair. Refer to “Using the Channel Configuration dialog box” on page 87 for information on why some Audio Channels appear dimmed, red, or “in use”.

NOTE: You can verify the audio format of an audio channel pair. Refer to “Changing the audio I/O format” on page 155.



Selecting audio channels for an audio track

In order to record or play audio, you must assign audio channels to the audio tracks you add. After assigning audio channels you need to confirm the audio routing for the audio channel.

To select audio channels for each audio track:

1. Double click the Audio icon (🔊) to expand the configuration tree.
2. Select the audio Track icon in the configuration tree.

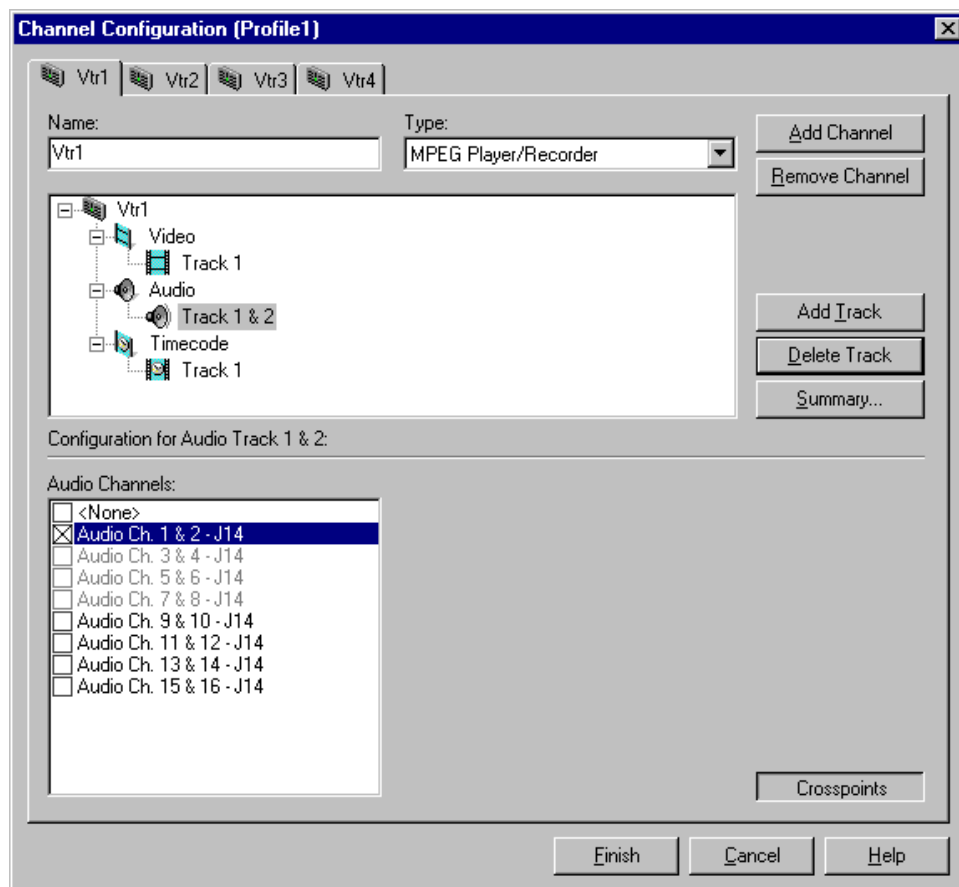

3. Select a pair of audio channels for each audio track by placing a check in the appropriate check box.

You can change the audio format for the audio channels using Configuration Manager. Refer to “Changing the audio I/O format” on page 155.

4. Click **Finish** to save your settings.

Changing the audio I/O format

This section describes how to select the audio I/O format you need for your system. The Profile XP system can be configured to operate with analog, AES/EBU digital, and digital embedded (SMPTE 272M Level A) audio.

An interface chassis is required for analog audio and AES/EBU digital audio (see “About Profile XP Audio” on page 149). If you are using only embedded audio, no interface chassis is required.

Select audio input format

To select audio input format:

1. Click **Audio Routing** in the Configuration Manager window. The Audio Input Routing dialog box appears.

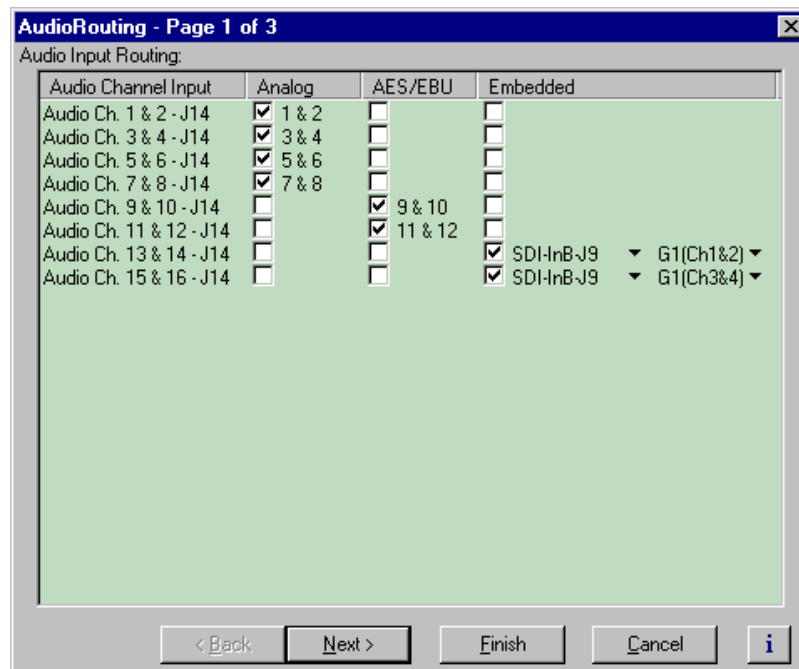

2. Select the audio input format for each audio channel pair.



3. If you selected embedded audio format, perform the following steps for each audio channel input pair requiring embedded audio:
 - a. Click the left-hand drop-down list arrow in the **Embedded** column for the channel pair you want to configure, and select a video input as shown.

NOTE: With one audio board, only the first 4 video inputs are selectable.

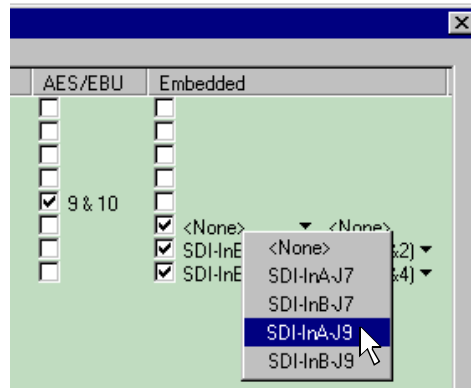

- b. Click the right-hand drop-down list arrow in the Embedded column for the channel pair you want to configure, and select an audio group and channel pair as shown.

NOTE: Up to two audio groups (8 audio channels) can be extracted from a single video input.

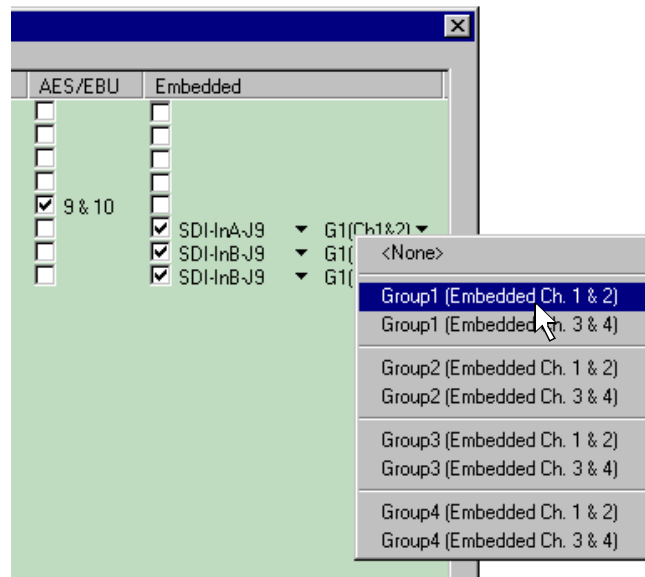

3. Click **Finish** to save your settings.

Select audio output format

There are no output routing selections to make if you are using Analog or AES/EBU audio. These formats are selected automatically when the system sees the audio interface attached.

If you are using embedded audio, you must make embedded audio selections as follows.

To select embedded audio output selections:

1. Click **Audio Routing** in the Configuration Manager window. The Audio Routing dialog box appears.
2. Click **Next** to navigate to Page 2 of the Audio Routing dialog box as shown.

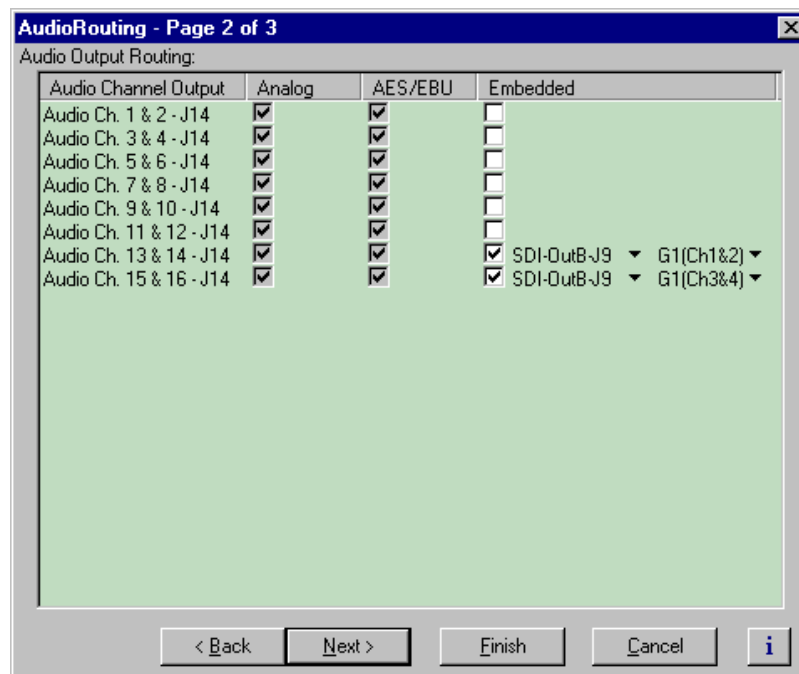

3. Select the check box in the **Embedded** column for all Profile XP audio channels that require embedded audio.



- Click the left-hand drop-down list arrow in the **Embedded** column for the channel pair you want to configure, and select a video output as shown.

NOTE: With one audio board, only the first 4 video outputs are selectable.

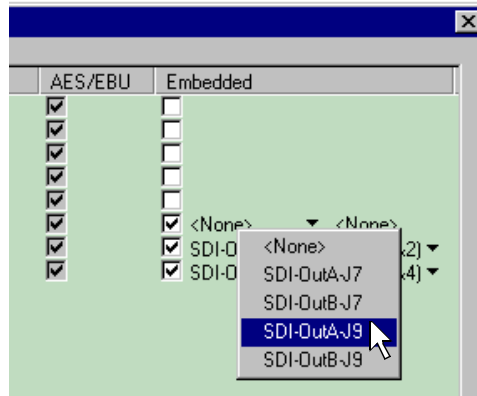

- Click the right-hand drop-down list arrow in the **Embedded** column for the channel pair you want to configure, and select an audio group and channel pair as shown.

NOTE: Up to two audio groups (8 audio channels) can be embedded on a single video output.

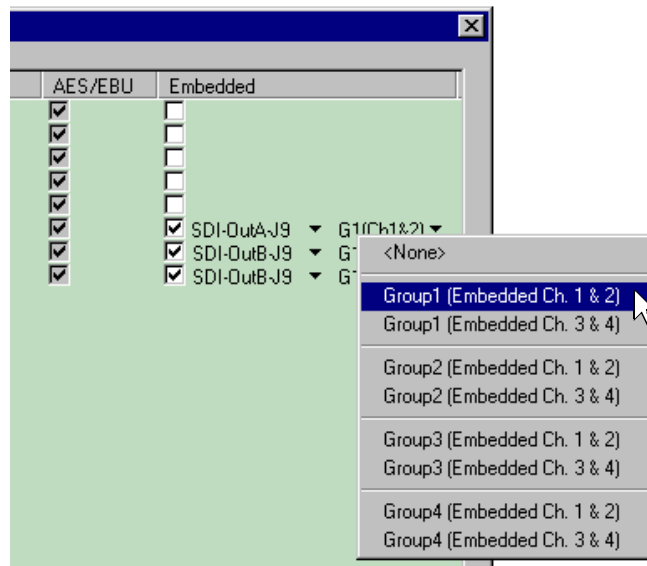

- Click **Finish** to save your settings.

Checking AES/EBU input status

The Audio Input dialog box in Configuration Manager allows you to check AES/EBU input status.

To view AES/EBU input status:

1. Click Audio Input in Configuration Manager. The Audio Input dialog box appears.
2. Click **Next** to navigate to Audio Input page 2.

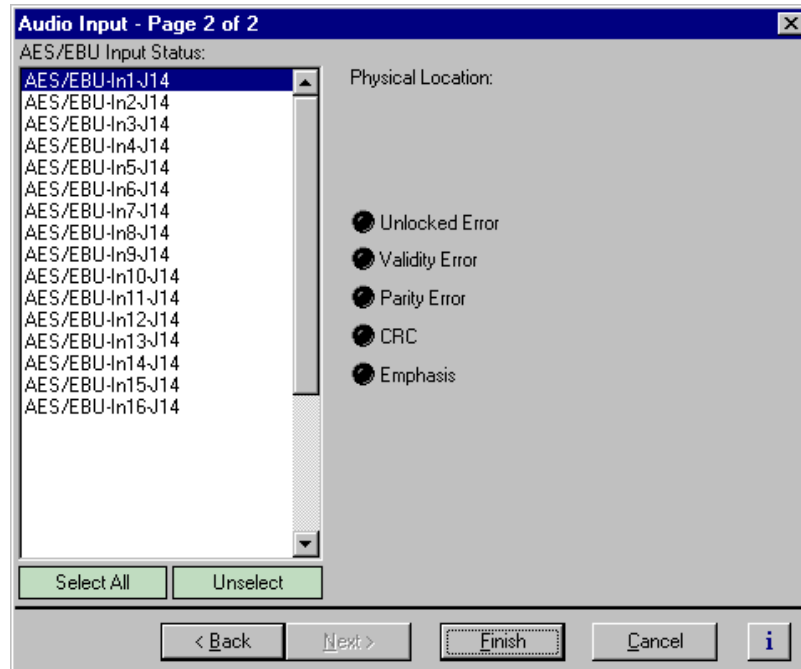

3. Select the AES/EBU pair. The following signal status is shown:

Indicator	Description
Unlocked Error	receiver locked
Validity Error	AES receiver validity
Parity Error	parity error
CRC	CRC subframe errors
Emphasis	detected emphasis

4. Click **Finish** or **Cancel**.



Selecting the audio clock reference

When using analog or AES/EBU audio, to ensure that audio is recorded synchronously the video signal, the audio clock reference selection is provided. By default, the audio clock reference is set to the system reference. This setting should not be altered unless the incoming video signal is asynchronous. When recording asynchronous video, you must select the video input as the audio clock reference, otherwise, audible clicks and pops will occur in the recorded audio signal.

To select the audio clock reference for an audio pair:

1. Select Audio Routing in the Configuration Manager window. Page 1 of the Audio Routing dialog box appears.
2. Click **Next** to navigate to Audio Routing page 3.

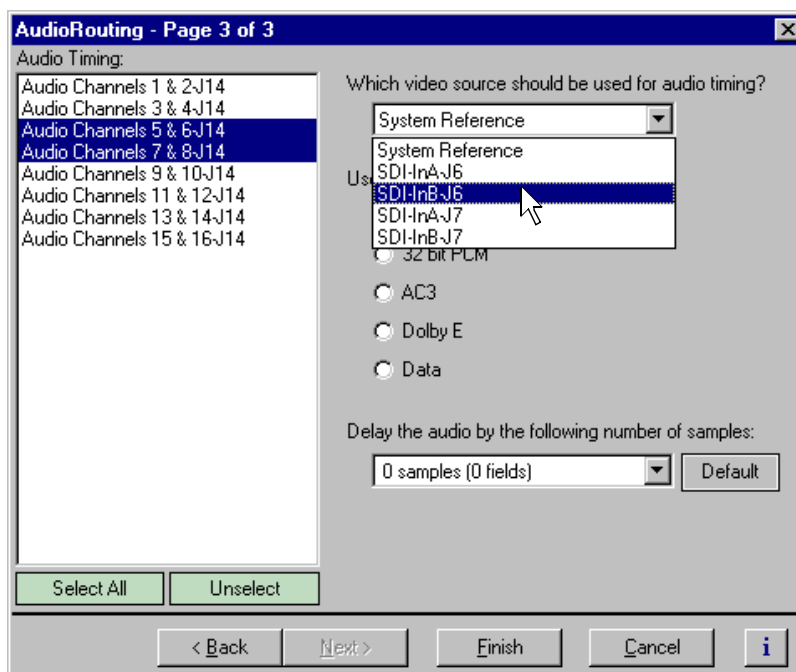

3. Select an audio input pair in the list.
4. Select a video input to use as audio clock reference using the drop-down list.
5. Repeat step 3 and step 4 as needed for other audio channel pairs.
6. Click **Finish** to save your settings.

Selecting incoming digital audio coding format

The Profile XP Media Platform provides a choice of compressed or uncompressed audio I/O formats which provide flexibility in managing the quality and storage needs of your system. The digital audio coding formats supported include:

- 16 bit or 24 bit PCM (PAC216 requires one of these)
- AC-3 (Dolby D)
- Dolby E
- Data

You must select the coding format for each audio channel I/O pair to meet the requirements of your system. For example, select Dolby E if your incoming audio is compressed using Dolby E. Selecting an audio coding format ensures the audio is processed and stored appropriately.

To select incoming digital audio coding format:

1. Select Audio Routing in the Configuration Manager window. The Audio Routing dialog box appears.
2. Click **Next** to navigate to Audio Routing page 3.

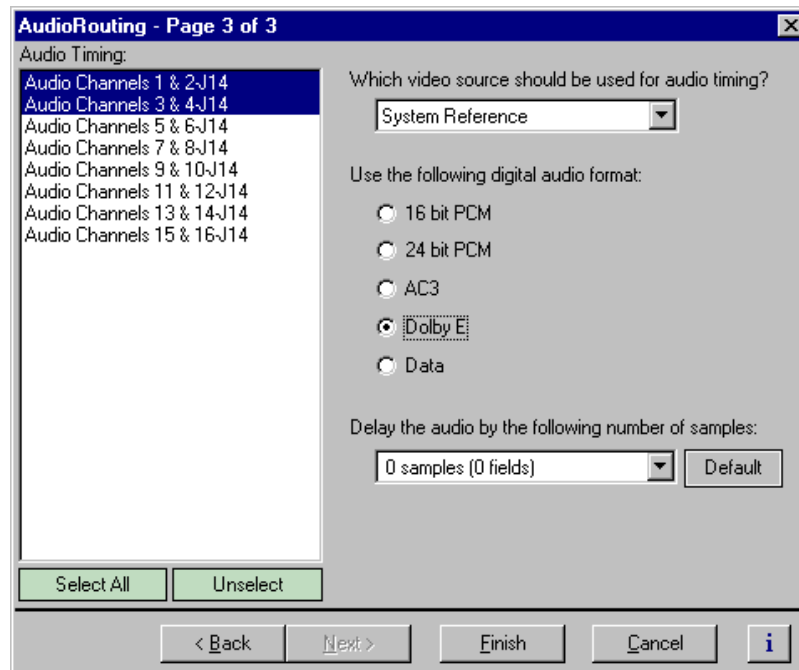

3. Select an audio pair from the list, or click **Select All**.
4. Select the audio storage format as required by your system, then click **Finish**.



Adjusting audio delay

You can adjust the fixed audio delay through the Profile XP system in order to meet system requirements. Audio delay adjustment range is from 0 to 2 fields. Adjust audio delay by selecting an audio delay preset or by selecting custom and entering the the number of audio samples of delay between 0 and 2 fields.

Selecting audio delay presets

To select fixed audio delay:

1. Select Audio Routing in the Configuration Manager window. The Audio Routing dialog box appears.
2. Click **Next** to navigate to Audio Routing page 3.

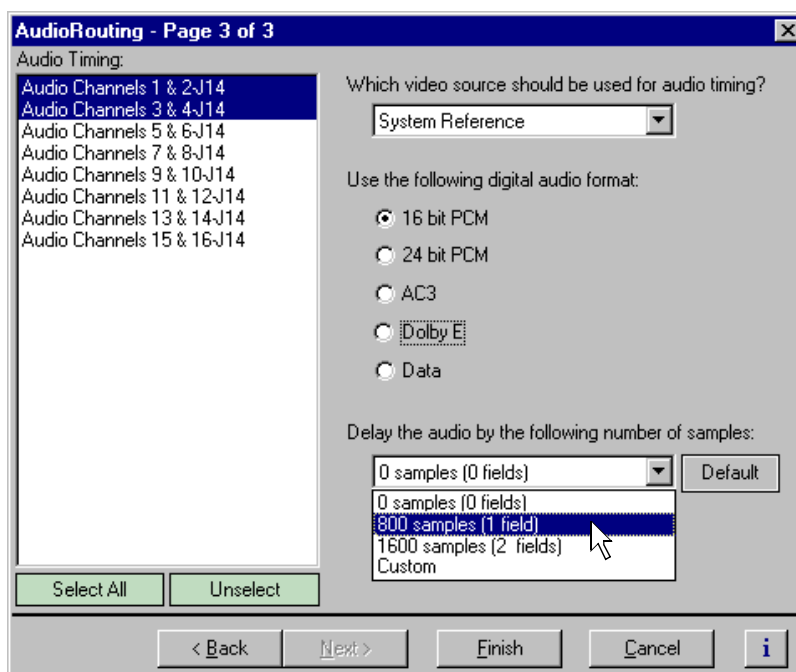

3. Select an audio pair from the list, or click **Select All**.
4. Select a fixed audio delay preset using the drop-down list.

Audio presets shown are for the 525 video standard. Presets for 625 video standard are 0 samples (0 fields), 960 samples (1 field), and 1020 samples (2 fields).

5. Click **Finish** to save your settings.

Selecting custom audio delay

To select custom audio delay:

1. Select Audio Routing in the Configuration Manager window. The Audio Routing dialog box appears.
2. Click **Next** to navigate to Audio Routing page 3.

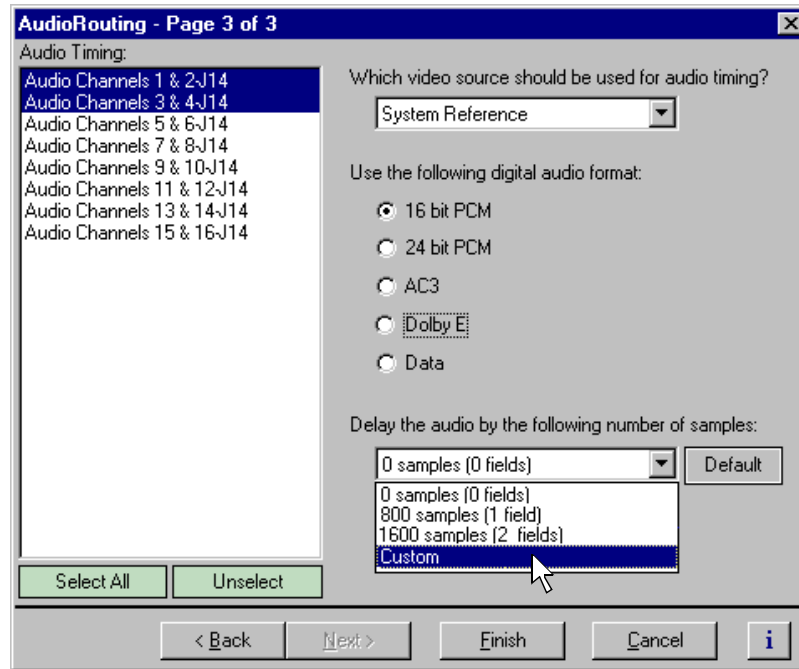

3. Select an audio pair from the list, or click **Select All**.
4. Select a **Custom** in the audio delay drop-down list. The audio samples edit box appears.

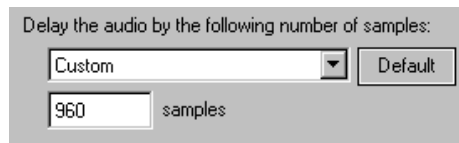

5. Enter the fixed audio delay in number of audio samples from 0 to 2 fields in the samples text box.

Audio Delay	525/60 Video Standard	625/50 Video Standard
1 field	800 samples	960 samples
2 fields	1600 samples	1920 samples

6. Click **Finish** to save your settings.



Adjusting analog audio input level

You can use the analog input gain adjustment to correct the analog audio input signal level. For instance, you can use the input gain adjustment to correct input audio level before recording the source signal.

To adjust analog audio input level:

1. Select Analog Audio Input in the Configuration Manager window.

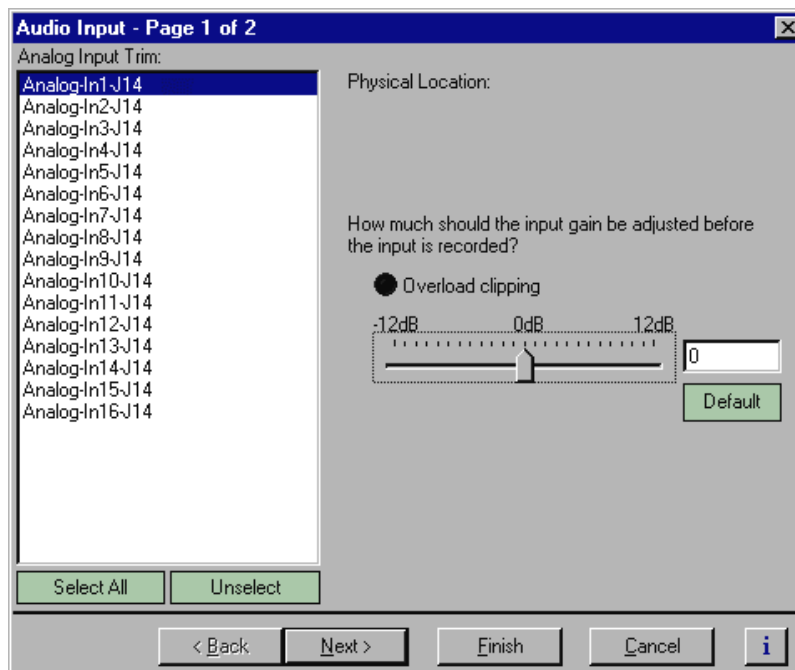

2. Select an audio input in the list to adjust or click **Select All** to adjust all inputs.
3. Use the slider in the Analog Audio Input dialog box to adjust input level.
Overload clipping indicates the audio level is greater than +23dbu.
4. Click **Finish**.

Adjusting analog audio output level

You can use the analog audio output level adjustment to correct analog audio signal level to meet your system requirements.

1. Select Analog Audio Output in the Configuration Manager window.
2. Select an audio output in the list to adjust or click **Select All** to adjust all inputs.
3. Use the slider in the Analog Audio Output dialog box to adjust the output level.
4. Click **Finish** to save your settings.

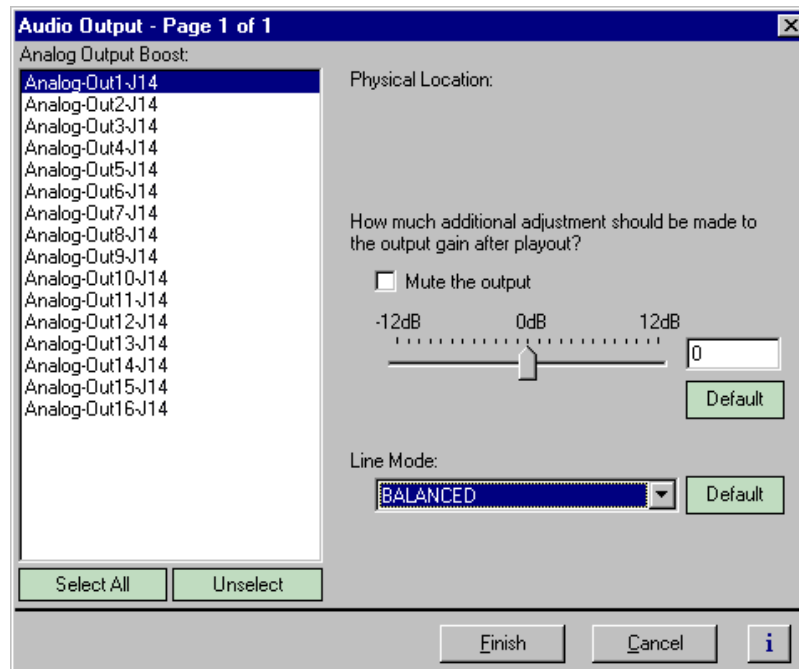



Muting analog audio outputs

You can mute analog audio outputs when they are not being used. Selecting mute disables the audio output in the PAC200 and reduces the risk of output noise occurring when audio inputs are not driven with an input signal.

To mute the analog audio output:

1. Select Audio Output in the Configuration Manager window. The Audio Output dialog box appears.
2. Select an audio output in the list to adjust, or click **Select All**.
3. Click the **Mute** check box to mute the output.
4. Click **Finish** to save your settings.

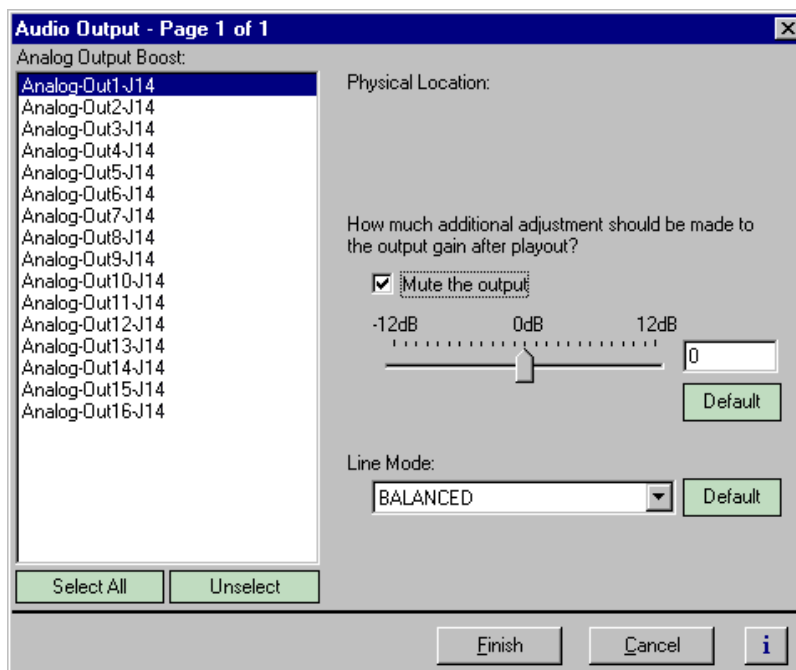

Selecting analog audio output line mode

You can select single ended or balanced line modes for the analog audio outputs.

To select analog audio line mode:

1. Select Audio Output in the Configuration Manager window.
2. Select an audio output in the list, or click **Select All**.
3. Select the Line Mode using the **Line Mode** drop-down list.
4. Click **Finish** to save your settings.

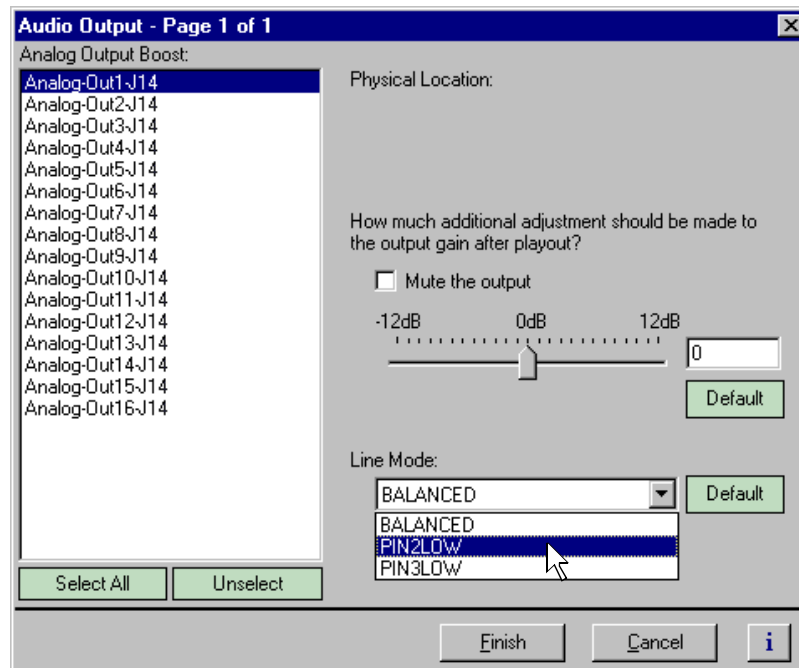



Selecting audio reference level

The audio reference level is used by Profile applications to scale audio level meters. Setting the audio reference level determines the absolute value at 0db.

To set the audio reference level, select Audio Reference Level in the Configuration Manager window, then select the audio reference level used at your facility.

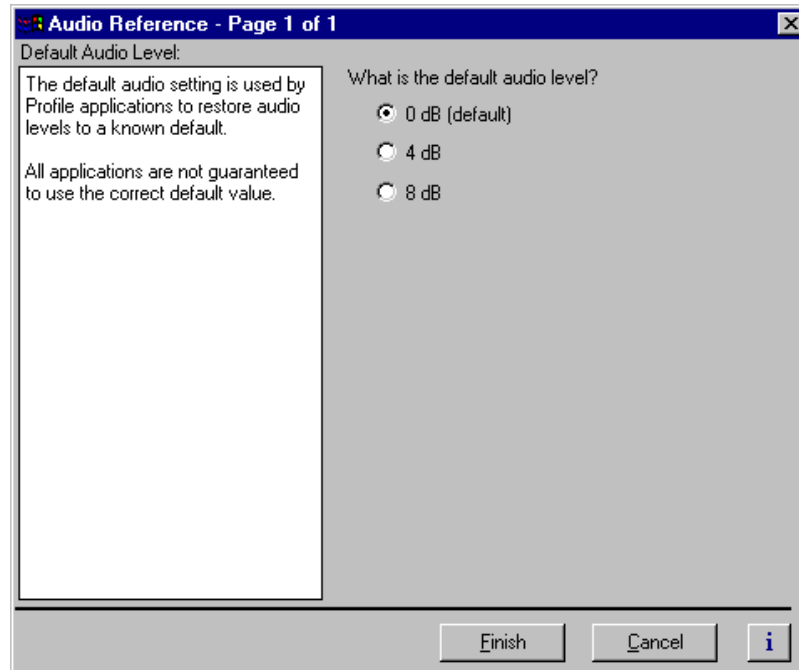

Changing how audio sounds during shuttle

You can change how the audio system plays audio during shuttle or off-speed play by changing the audio window size. The audio window is a segment of audio that is heard when you move through a clip at higher-than-play speed. You can specify the size of the window, and thus the amount of the audio that you hear, by selecting a number of fields.

To set the audio window size:

1. Select the Audio icon in the configuration tree.
2. Click the tab for the channel you want to modify.
3. Click the Audio icon (🔊).
4. Use the Audio Window Size drop-down list to select a field size from the three available choices: 5 fields, 10 fields (default), and 20 fields.
5. Click **Finish** to save changes.

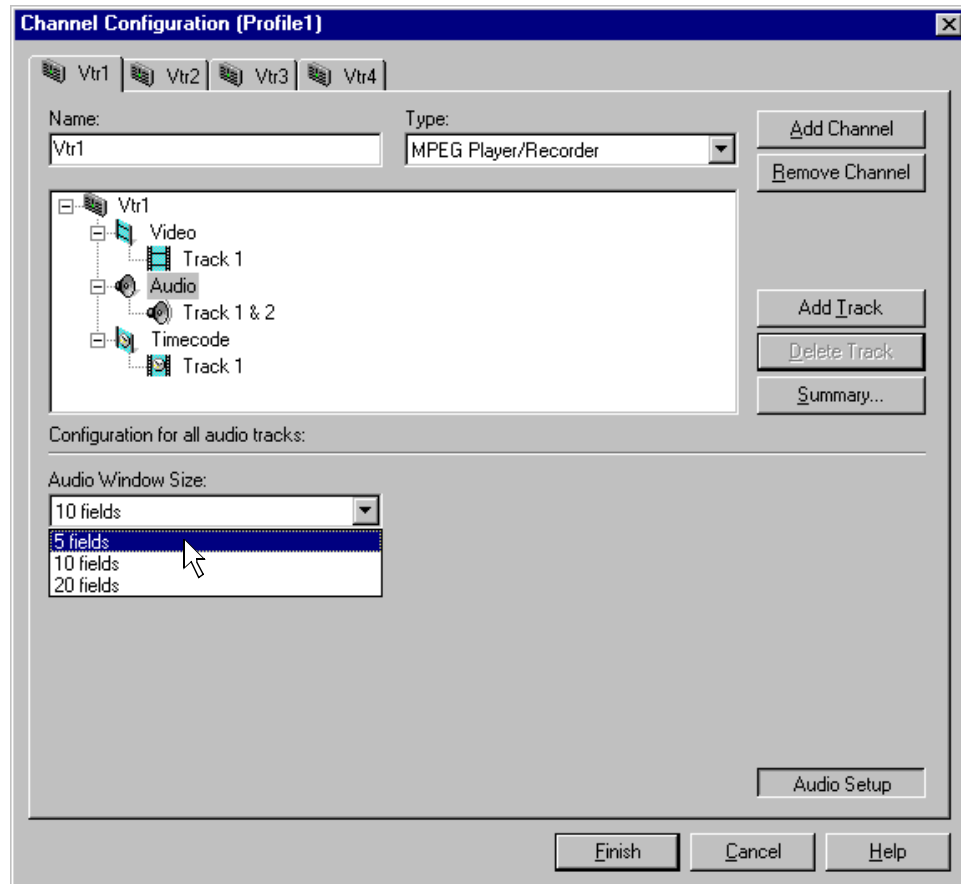



Chapter 6 Modifying a Channel: Audio Settings

Modifying a Channel: Timecode Settings

You can customize timecode settings for your record or play channels. For example, you can change the number of timecode tracks per channel or change the timecode source and destinations. This chapter describes how to modify your timecode settings.

About Profile XP series timecode

To record or play timecode, you must assign one or more timecode tracks to the channel using Configuration Manager. After adding a timecode track, you can choose the timecode source or destination for the track.

Timecode sources include one of four LTC inputs, internal timecode generators and VITC. VITC can be read on all video inputs including the system reference input.

Timecode outputs include one of four LTC outputs and VITC on any video output.



Using the internal timecode generators

Profile XP software provides a timecode generator for each Profile XP channel. The internal timecode generator appears as a source in the timecode input list for each channel. You can configure how the timecode generator runs, such as drop frame or non-drop frame, fixed or time of day. The timecode generators are referenced to the Applications Processor real-time clock.

Selecting the internal generator as a timecode source

To select internal generators as the source for timecode:

1. Select Channel Configuration in the Configuration Manager window.
2. Select the tab for the channel you want to configure.
3. Select a timecode **Track** under the Timecode icon () in the configuration tree, then click the **Crosspoints** button. The Timecode Input and Output check boxes appear at the bottom of the Channel Configuration dialog box.

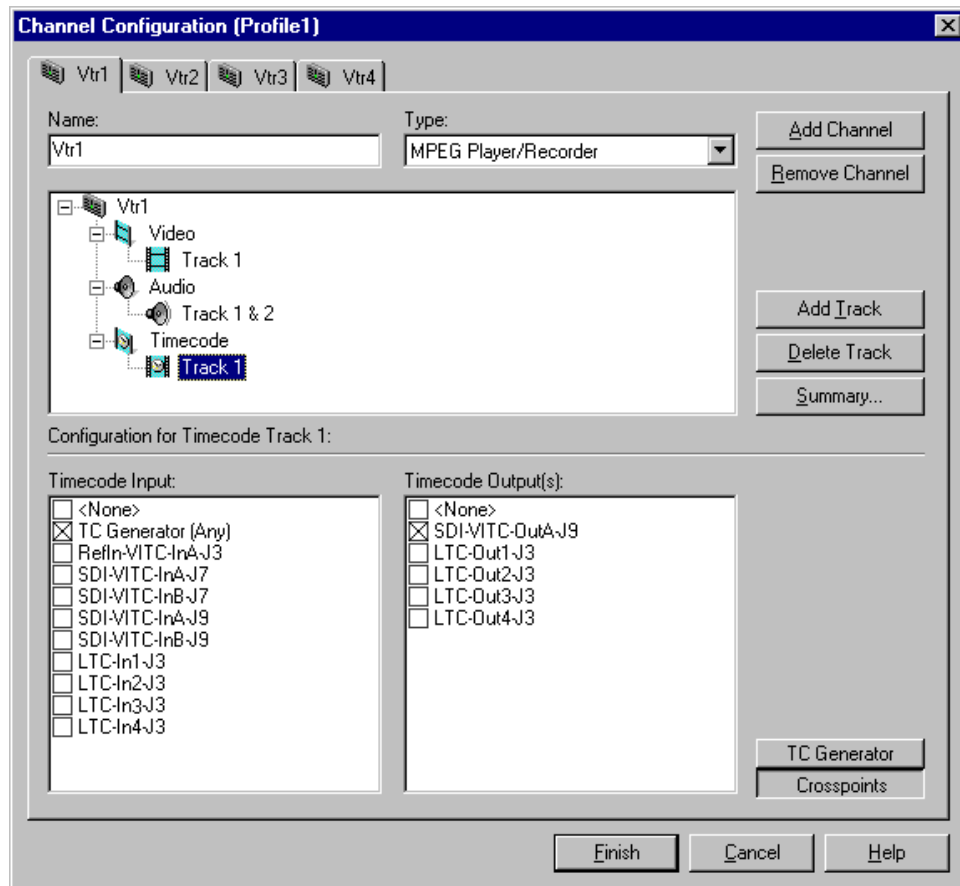

4. Select the **TC Generator** check box under Timecode Input list.
5. Proceed to “Setting up an internal timecode generator” on page 175 to set up the timecode generator or click **Finish** to save your settings and close the Channel Configuration dialog box.

Using the same TC generator multiple channels

To use the same timecode generator on two or more channels, you must use the **TC Generator** button on each channel tab to select the same timecode codec for each channel.

To select the same internal generator:

1. Select Channel Configuration in the Configuration Manager window.
2. Click the tab for the channel you want to configure.
3. Select a Timecode icon () in the configuration tree
4. Click the **Crosspoints** button, then select the **TC Generator** check box in the Timecode Input list. This enables the TC Generator button.

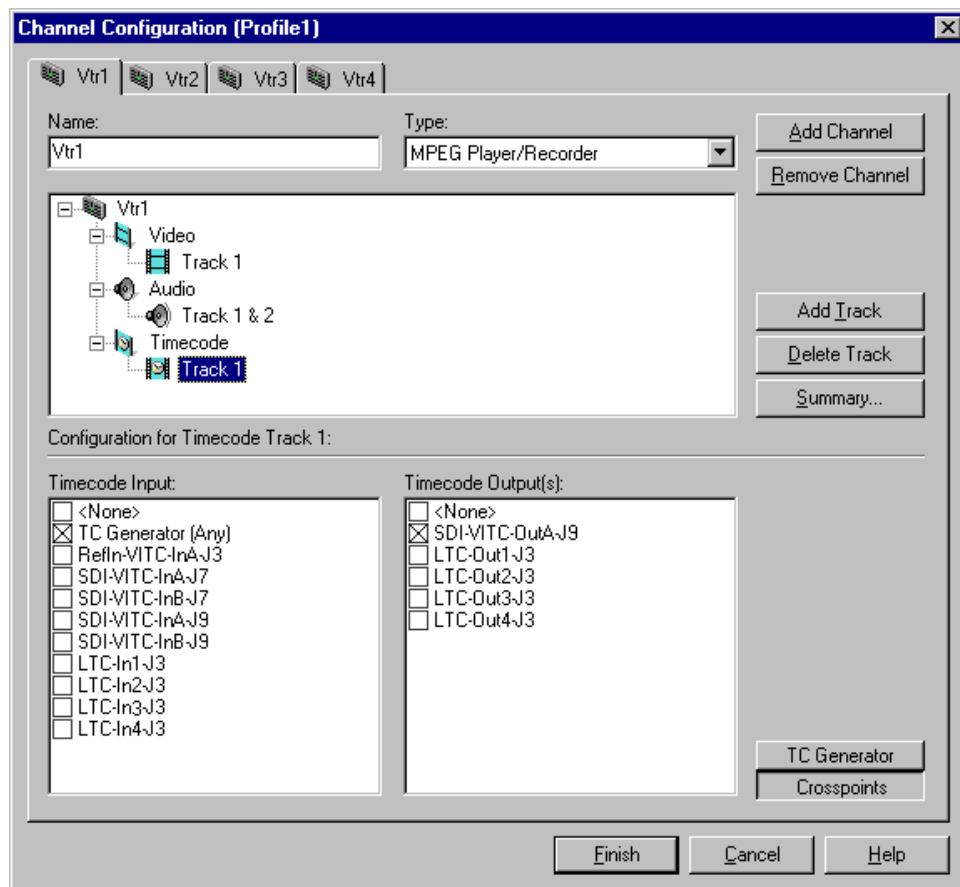



5. Click the **TC Generator** button, then select a TC Generator from the list.

NOTE: Do not select “Any”. Choose a specific timecode generator and then remember to use it for all subsequent channels you configure.

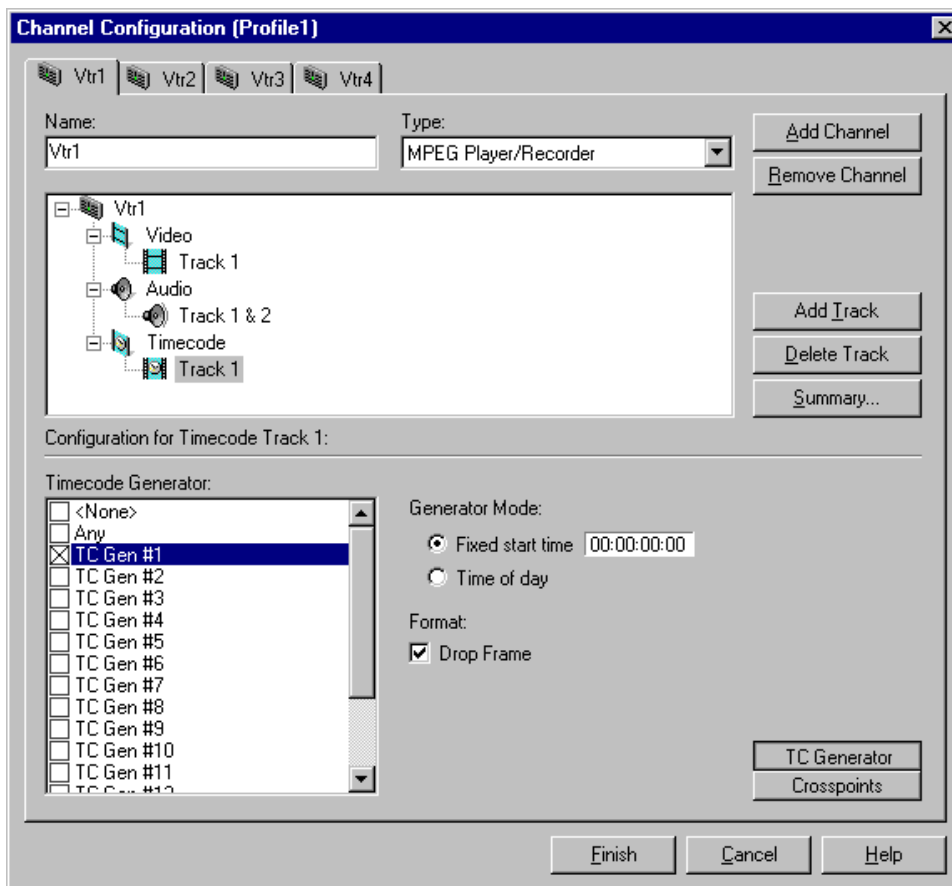

6. Repeat step 2 through step 5 for each channel that will use the same timecode generator.
7. Click **Finish** to save your settings and close the Channel Configuration dialog box. Refer to “Setting up an internal timecode generator” on page 175 to configure the timecode generator.

Setting up an internal timecode generator

When you select “TC Generator” as your timecode source, there are several other settings that you can make to the timecode generator. The controls for making these settings are available only when the timecode input is “TC Generator,” otherwise, the generator controls are dimmed.

Changes you make to the timecode generator apply only to the current channel unless you have selected the same time code generator for another channel (see “Using the same TC generator multiple channels” on page 173).

To change the timecode generator settings:

1. With a timecode Track selected in the configuration tree, click the **TC Generator** button. The timecode generator panel appears. The controls are dimmed except when “TC Generator” is the timecode input.

NOTE: Leave the Timecode Generator selection set to “Any” unless you are using the same generator for two or more channels. Refer to “Using the same TC generator multiple channels” on page 173.

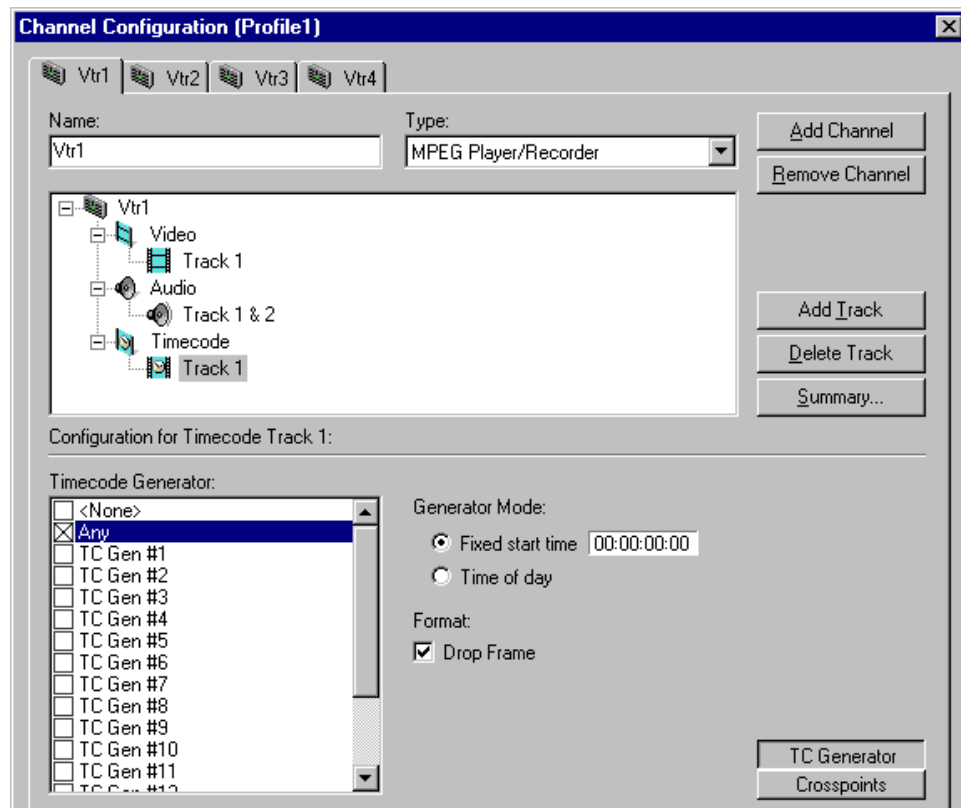

2. Choose a generator mode. You can start timecode using a fixed time or the time of day. Click **Time of Day** to use the Applications Processor Windows NT clock, or click **Fixed Start Time** to set a timecode value under Starting Value.



3. If you selected fixed time, you can use the default of **00:00:00:00** (Hours:Minutes:Seconds:Frames) under Starting Value or set a new fixed starting time. This setting takes effect the next time you click the **Record** button.

NOTE: *The Drop Frame control is hidden if your Profile system is configured for the 625 video standard.*

4. To choose drop frame, click on the **Drop Frame** check box. To compensate for the 29.97 frame rate in NTSC, drop-frame timecode synchronizes the rate with elapsed time. Drop-frame timecode drops two frames per minute, except on the tenth minute. PAL, on the other hand, has a constant rate of 25 frames per second and never requires drop-frame timecode.
5. Click **Finish** to save your settings and close the Channel Configuration dialog box.

Recording VITC

The system reference input and all video inputs have VITC readers. To record VITC, you must first select the reference input or a video input as a timecode source, then verify the VITC reader for the input is set up properly to read VITC.

Selecting a VITC input for a channel

To select VITC as the timecode source:

1. Select Channel Configuration in the Configuration Manager window.
2. Click the tab for the channel you want to configure.
3. Click on a timecode track in the configuration tree or click **Add Track** to add a new one.
4. Click the **Crosspoints** button, then select the VITC source in the Timecode Input list.

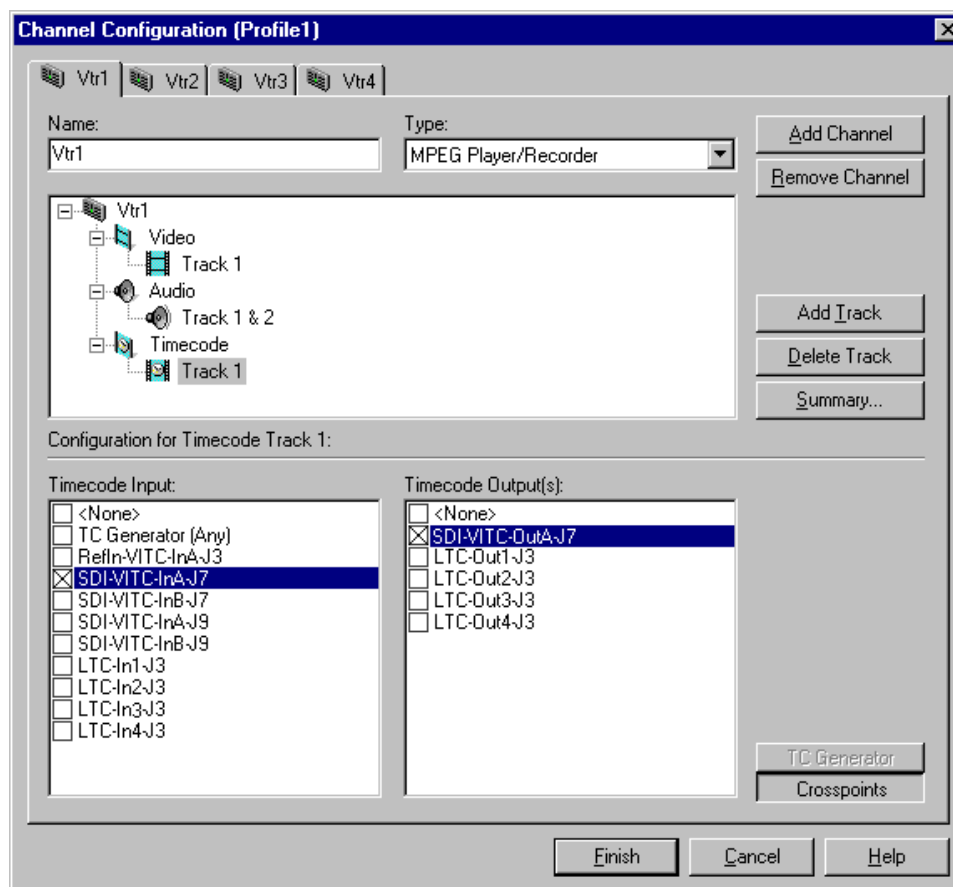

5. Click **Finish** to save your settings and close the Channel Configuration dialog box.
6. To set up the VITC reader for the VITC source you selected, refer to “Setting up the VITC reader on a Video Input” on page 178, or “Setting up the VITC reader on the Reference Input” on page 180.



Setting up the VITC reader on a Video Input

The VITC reader has two detection modes: Automatic and Manual. When you select automatic detection, you can set the range of vertical interval lines scanned to find the VITC signal pair; lines 10 to 21 by default. Manual allows you to choose specific line numbers to detect the VITC signals. Automatic detection is the default setting. Use automatic detection unless there are two sets of VITC on the input signal.

To set up the video input VITC reader:

1. Select Video Input in the Configuration Manager window. The Video Input dialog box appears.
2. Click **Next** to navigate to Video Input page 2 of 3.

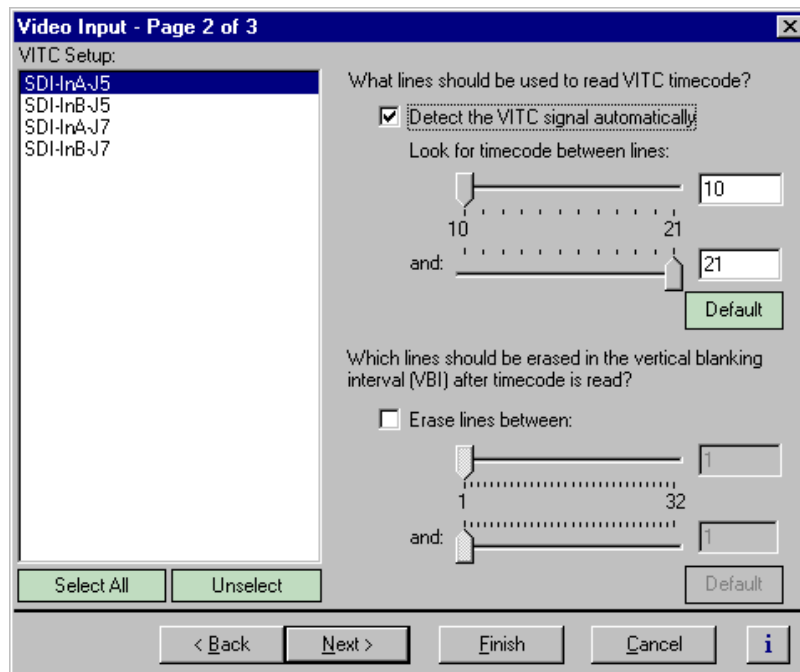

3. Select a video input from the list or click **Select All** to configure all video inputs at the same time.

4. Select one of the VITC timecode options as follows:

- Auto Detection - Select the **Detect the VITC signal automatically** check box, then type or select the range of lines you want the system to search for VITC.

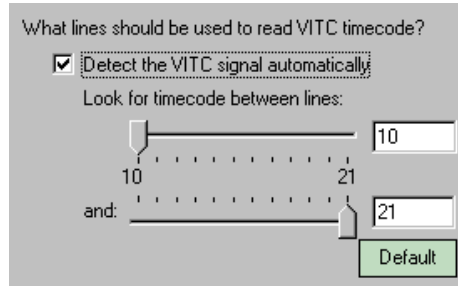

- Manual Detection - Clear the **Detect the VITC signal automatically** check box, then type or select the line numbers where the VITC pair can be found.

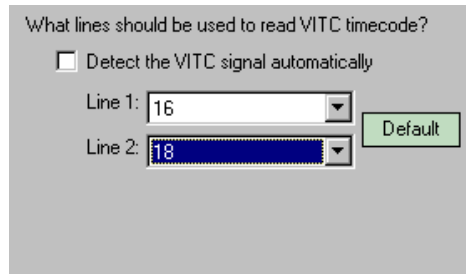

5. Click **Finish** to save your settings.



Setting up the VITC reader on the Reference Input

The VITC reader has two detection modes: Automatic and Manual. When you select automatic detection, you can set the range of vertical interval lines scanned to find the VITC signal pair; lines 10 to 21 by default. Manual allows you to choose specific line numbers to detect the VITC signals. Automatic detection is the default setting. Use automatic detection unless there are two sets of VITC on the input signal.

To set up the Reference Input VITC reader:

1. Select Video Timing in the Configuration Manager window. The Video Timing dialog box appears.
2. Click **Next** to navigate to Video Timing page 3 of 3.

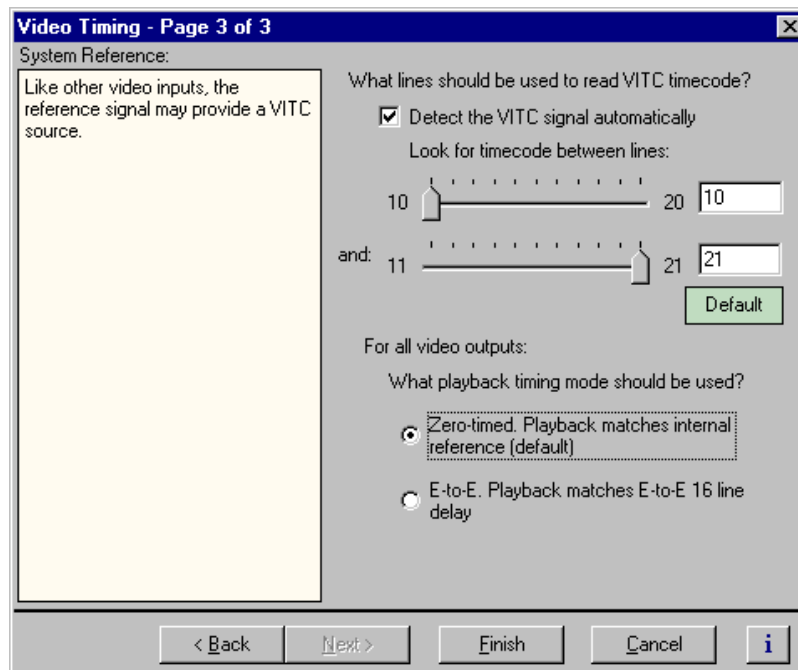

3. Select one of the VITC timecode options as follows:

- Auto Detection - Select the **Detect the VITC signal automatically** check box, then enter the range of lines you want the system to search for VITC using the sliders.

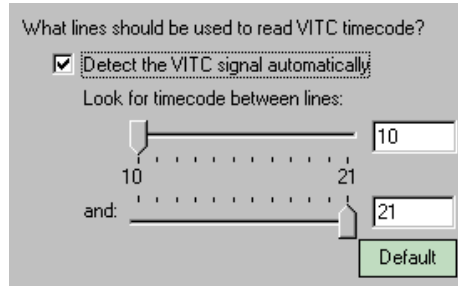

- Manual Detection - Clear the **Detect the VITC signal automatically** check box, then type or select the line numbers where the VITC pair can be found.

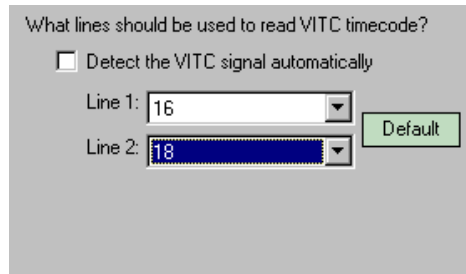

4. Click **Finish** to save your settings.



Generating VITC on a video output

To generate VITC on a video output, you must:

- Select the video output as a timecode output for the channel.
- Set up the VITC generator on the output for the correct vertical interval lines.

Selecting the video output as a timecode output for the channel

To select VITC as the timecode output:

1. Select Channel Configuration in the Configuration Manager window.
2. Click the tab for the channel you want to configure.
3. Click on a timecode track in the configuration tree or click **Add Track** to add a new one.

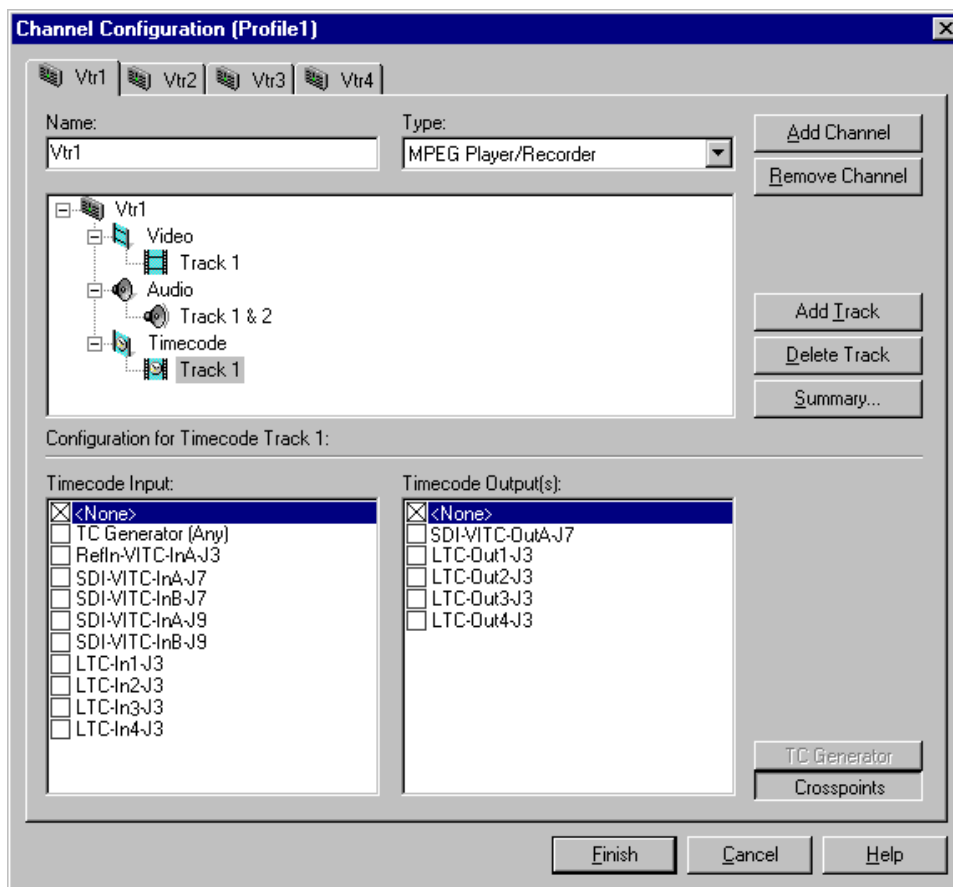

4. Select **SDI-VITC-Out** in the Timecode Output list.

NOTE: The video outputs listed in the Timecode Output list correspond to those assigned to the channel. For example, *SDI-VITC-OutA-J7* is listed in the following figure because *SDI-OutA-J7* is selected as the video output for the channel. If you change the video output for a channel, the Timecode Output list also changes.

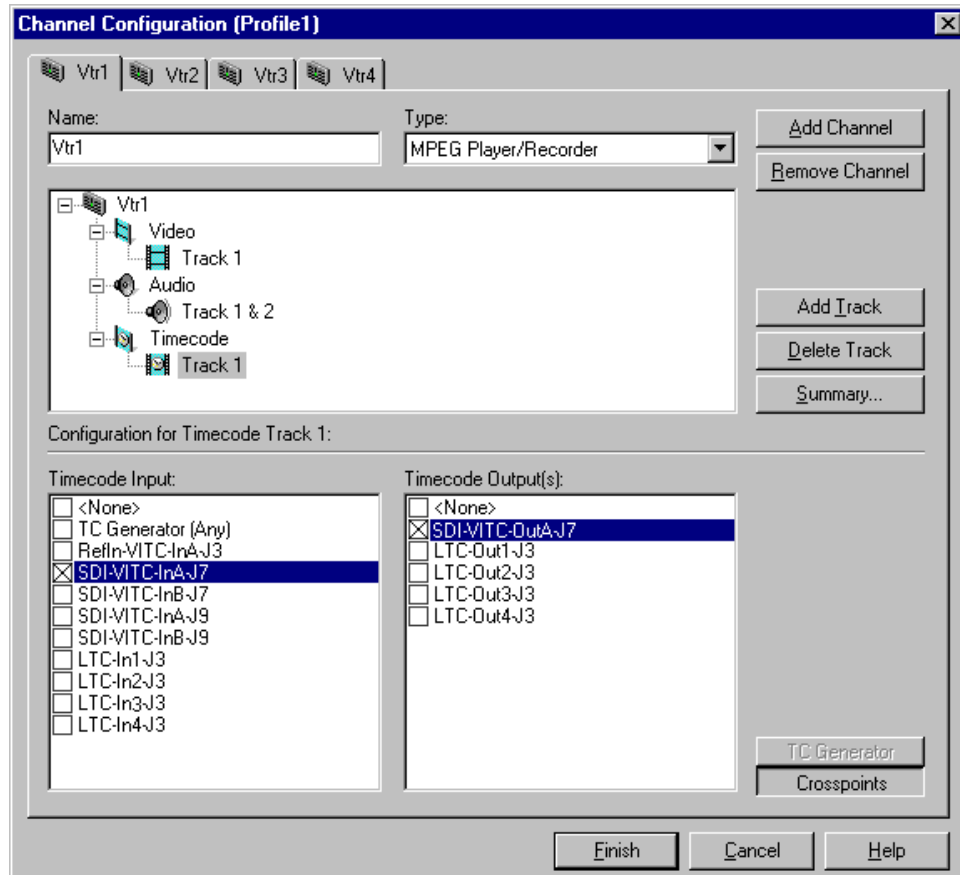

5. Click **Finish** to save your settings and close the Channel Configuration dialog box.



Setting up the VITC generator on a video output

To set up the VITC generator:

1. Choose Video Output in the Configuration Manager window. The Video Output dialog box appears.
2. Click **Next** to navigate to Video Output page 2 of 3.

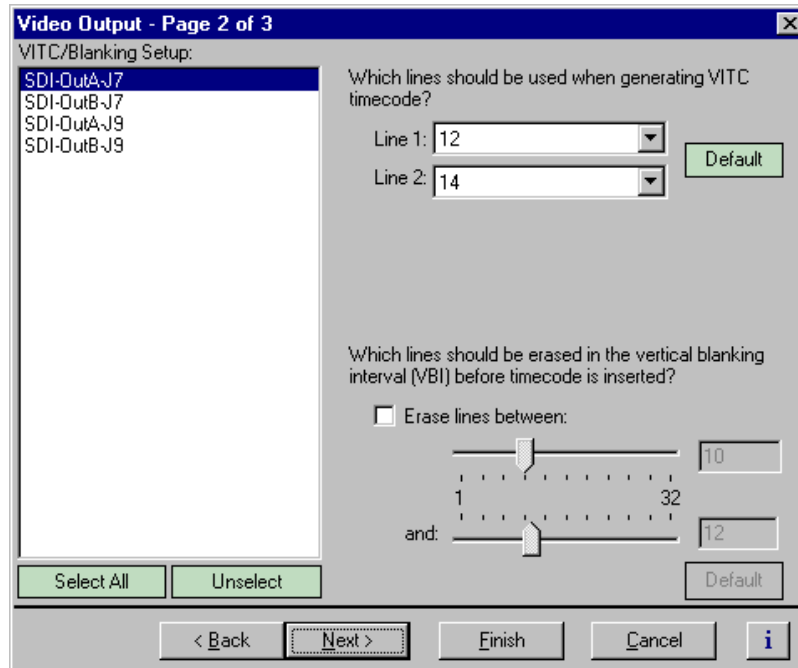

3. Select a video output from the list or click **Select All** to configure all video inputs at the same time.
6. Type or select the line numbers where the VITC signals should be generated using the **Line 1**, **Line 2** drop-down lists.

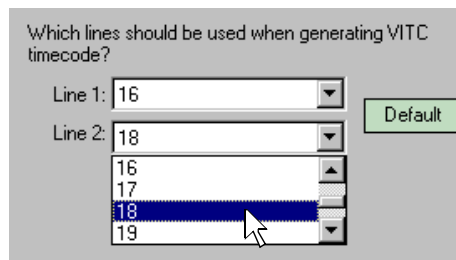

4. Click **Finish** save your settings.

Deleting unwanted VITC signals

You can remove unwanted VITC signals that may be present in a recorded video clip or on the output during E to E by selecting which VBI lines to erase. You can erase VBI lines by selecting the range of line numbers between line 1 to line 32. Blanking level is inserted in place of the VBI information. Lines are erased before VITC timecode is inserted.

To erase VITC lines:

1. Choose Video Output in the Configuration Manager Window. The Video Output dialog box appears.
2. Click **Next** to navigate to Video Output page 2 of 3.

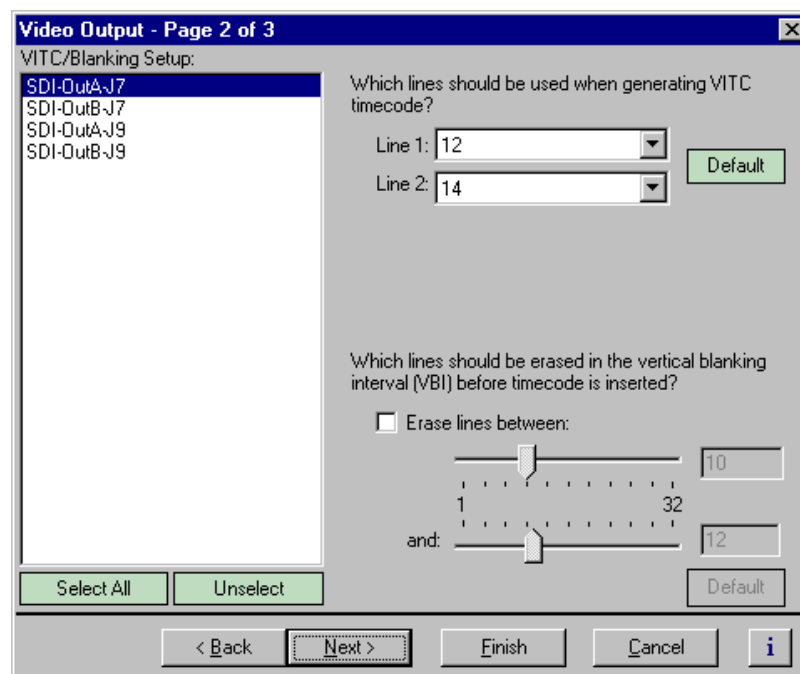

3. Select a video output from the list or click **Select All** to configure all the video outputs at the same time.



4. Perform one of the following:

- If you do not want to erase any lines, clear the **Erase lines between** check box.
- If you want to erase lines in the vertical interval, select the **Erase lines between** check box, then select the starting and ending line numbers using the sliders.

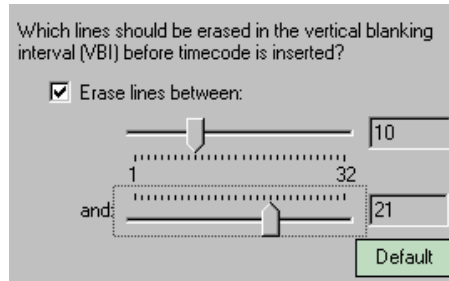

5. Click **Finish** to save your settings.

Recording or generating LTC

The Profile XP system provides four LTC inputs and outputs. Use Configuration Manager to setup a channel to record or output LTC.

To set up a channel to read or generate LTC:

1. Select Channel Configuration in the Configuration Manager window.
2. Click the tab for the channel you want to configure.
3. Click on a timecode track in the configuration tree or click **Add Track** to add a new one.
4. Click the **Crosspoints** button, then do one or both of the following:
 - Select one of the LTC inputs to use as the timecode source for the channel.
 - Select one of the LTC outputs to use as the timecode output for the channel.

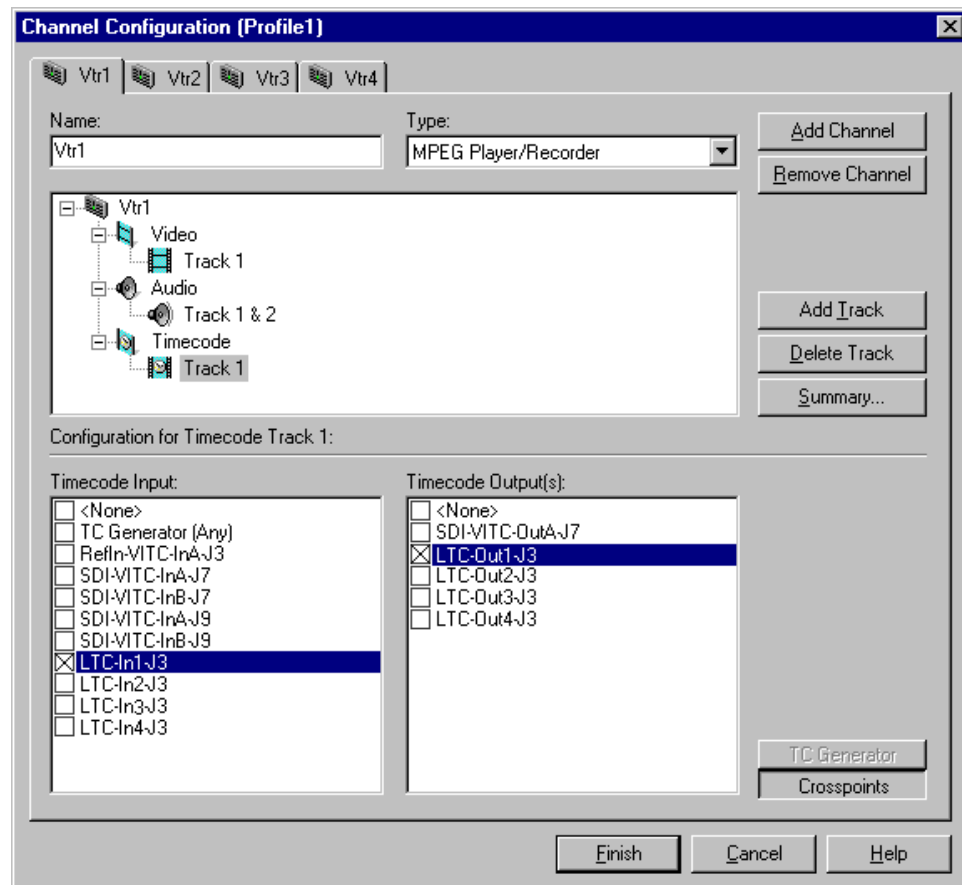

5. Click **Finish** to save your settings.



Select a timecode source for timecode burn-in

After enabling the timecode burn-in on the optional Video Monitor board, you must select a timecode source for the Video Monitor output using Channel Configuration dialog box. (For information on enabling the timecode burn-in, see “Enabling Video Monitor timecode burn-in” on page 144.)

To select timecode source for the Video Monitor burn-in:

1. Select Channel Configuration in the Configuration Manager window.
2. Click the tab for the channel you want to configure.
3. Click on a timecode track in the configuration tree, or click **Add Track** to add a new one.
4. Click the **Crosspoints** button, then select the Video Monitor output listed in the Timecode Output list.

NOTE: The Video Monitor is displayed in the Timecode Output list when it is assigned to the channel as a video output. For example, *MonitorTC-OutA-J11*, is listed in the following figure because *Monitor-OutA-J11* is selected as a video output for the channel. Refer to “Selecting the video I/Os used by a channel” on page 117 for instructions on selecting the video outputs for a channel.

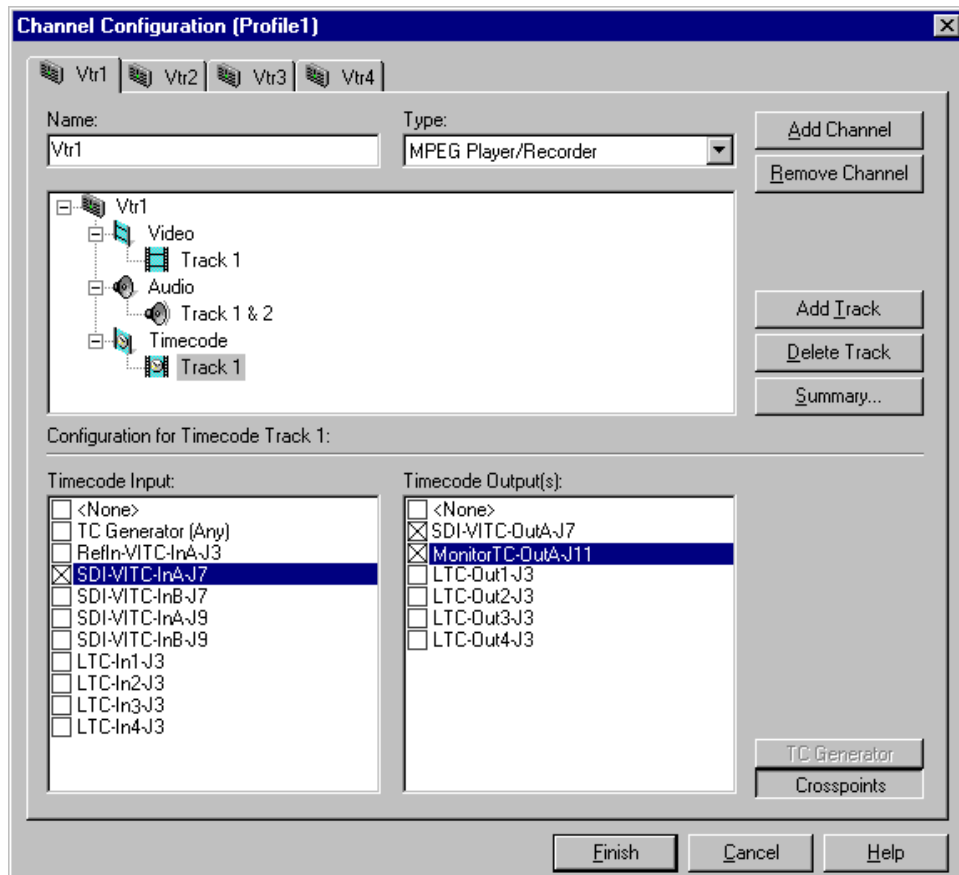

5. Click **Finish** to save your settings.

Controlling the Profile XP Remotely

Profile XP Series record and play channels can be controlled remotely through RS-422 control protocols or by remote applications over Ethernet. This chapter describes how to set up the Profile XP for the control mode you want to use.

Some third-party applications also support the General Purpose Interface (GPI). Refer to your vendor's documentation for instructions on using GPI triggers.

The Profile XP remote control capability is summarized in the following table:

Control Method	Application to Use	Control Protocols Available	Section in this chapter to use:
RS-422	VdrPanel	Louth Protocol Odetics Protocol BVW Protocol	"Setting up RS-422 remote control in VdrPanel" on page 190
RS-422	Prolink	Profile Protocol	"Setting up RS-422 remote control using Prolink" on page 193
Ethernet Network	Configuration Manager Tool Box Editor List Manager Media Manager TimeDelay	NA	"Running PortServer to enable remote operation" on page 195



Setting up RS-422 remote control in VdrPanel

After selecting record or play channels in VdrPanel, you can configure them for RS-422 remote control. The RS-422 protocols available in VdrPanel include:

- Louth Protocol
- Odetics Protocol
- BVW Protocol

Make RS-422 connections as described in the installation guide you received with your Profile XP Series system, then use the information in this section to select the control protocol and communications port you want to use.

To setup VdrPanel for RS-422 remote control:

1. Start VdrPanel using the desktop shortcut or by selecting **Start | Programs | Profile Applications | VdrPanel**. The VdrPanel window appears.

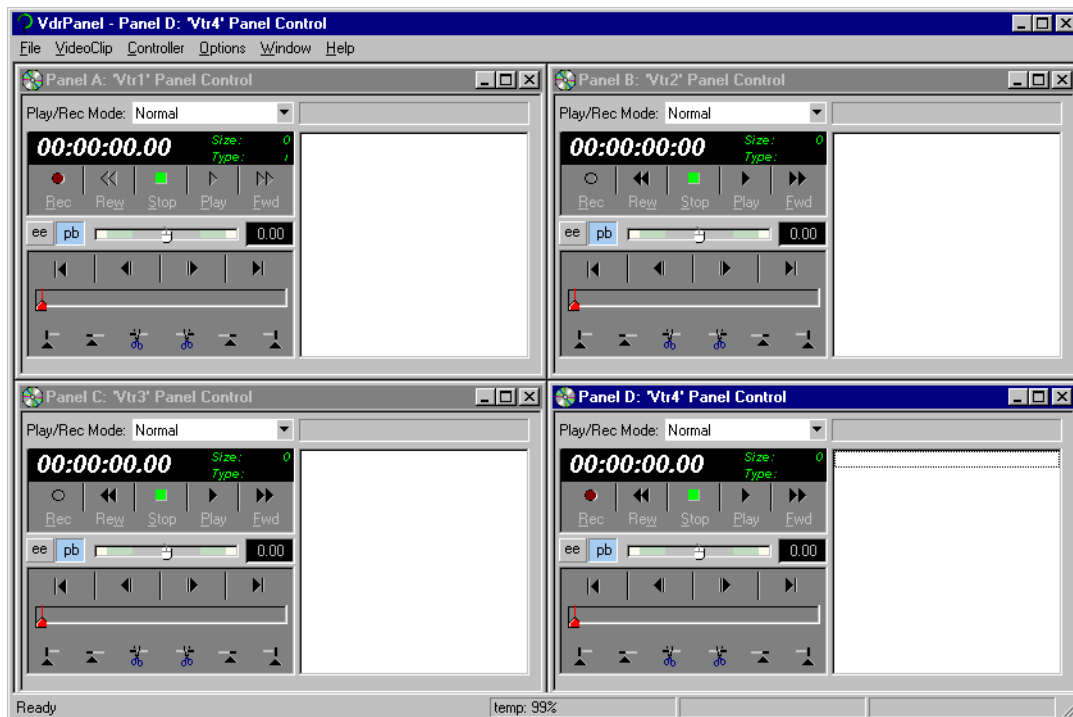

2. In VdrPanel, click in the panel you want to set up for remote control.

3. Choose **Controller | Configure** to open the Channel Configuration dialog box, then select a control protocol using the **Protocol** drop-down list as shown.

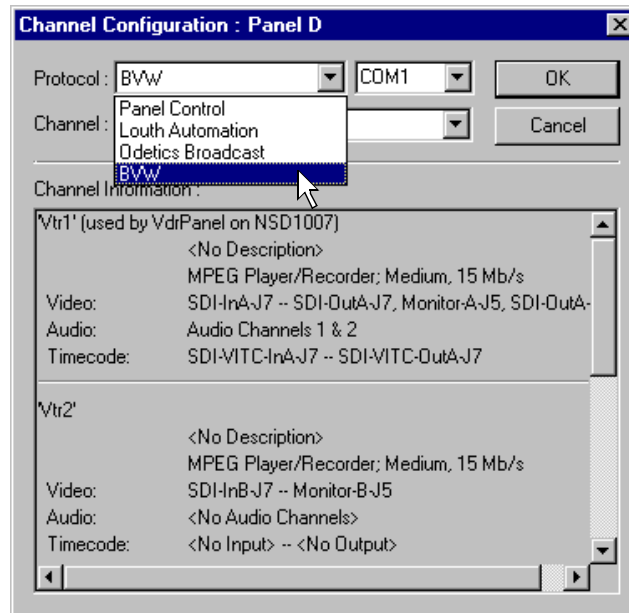

4. Select a serial port using the port select drop-down list as shown. COM1 and COM2 are RS-232 ports on the Profile XP rear panel. P1 through P8 are RS-422 ports on the I/O Panel.

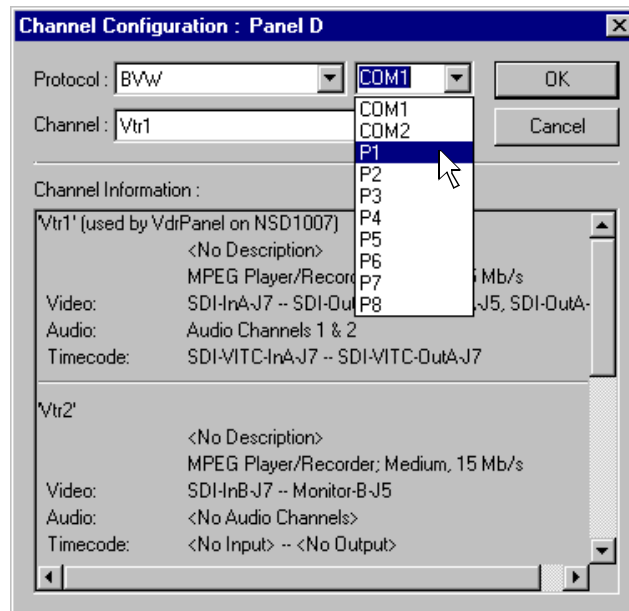



5. Click **OK** in the Channel Configuration dialog box.
6. Repeat step 2 through step 5 for the remaining panels.
7. Test the system using your automation controller.
8. Test the Profile XP remote control using your controller. Refer to Chapter 10, “Solving Common Setup Problems” for help if you have a problem.

Setting up RS-422 remote control using Prolink

Prolink is an application that monitors Profile protocol over the RS-422 communication ports, allowing you to control the Profile XP with devices that use Profile protocol.

Make RS-422 connections as described in the installation guide you received with your Profile XP system, then use the information in this section to set up Prolink and to learn more about the Prolink user interface.

How to set up Prolink

To set up Prolink:

1. Start Prolink using the shortcut on the desktop or by selecting **Start | Programs | Profile Applications | Prolink**. The port selection dialog box appears.
2. Select an RS-422 serial port in the port selection dialog box (P1-P8), then click **OK**. The Prolink window appears as shown.

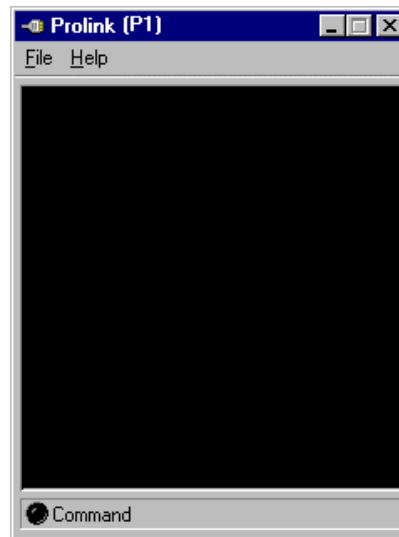

3. Repeat step 2, if required for your controller, for the remaining channels you want to operate using Profile protocol.

NOTE: Some control devices require one physical RS-422 port for each channel operated by the controller, while other controllers use only one RS-422 port to control all channels (up to 8 total) operated by the controller. Refer to your vendor's documentation for instructions.

4. Test the Profile XP system using your controller. See the following section for an overview of the Prolink communications window.

Refer to Chapter 10, "Solving Common Setup Problems" for help if you have a problem.



Overview of the Prolink communications window

The Prolink communications window is used to display information about the status of Profile XP system under control.

Status information displayed in the Prolink windows includes:

- ❶ **Channel Name** - A channel name is displayed when the controller or control application acquires channel resources using a predefined channel created in Profile Configuration Manager.
- ❷ **Connection Number** - A port number is displayed when the controller or control application acquires channel resources using the Profile API rather than using channels created in Profile Configuration Manager.
- ❸ **Channel or Port Status** - indicates transport status such as play, record, or idle.
- ❹ **Frame Count** - indicates the frame count of the current frame.
- ❺ **Clip Name** - shows the name of the clip currently loaded.
- ❻ **Communications Port Status** - indicates activity on the RS-422 port.

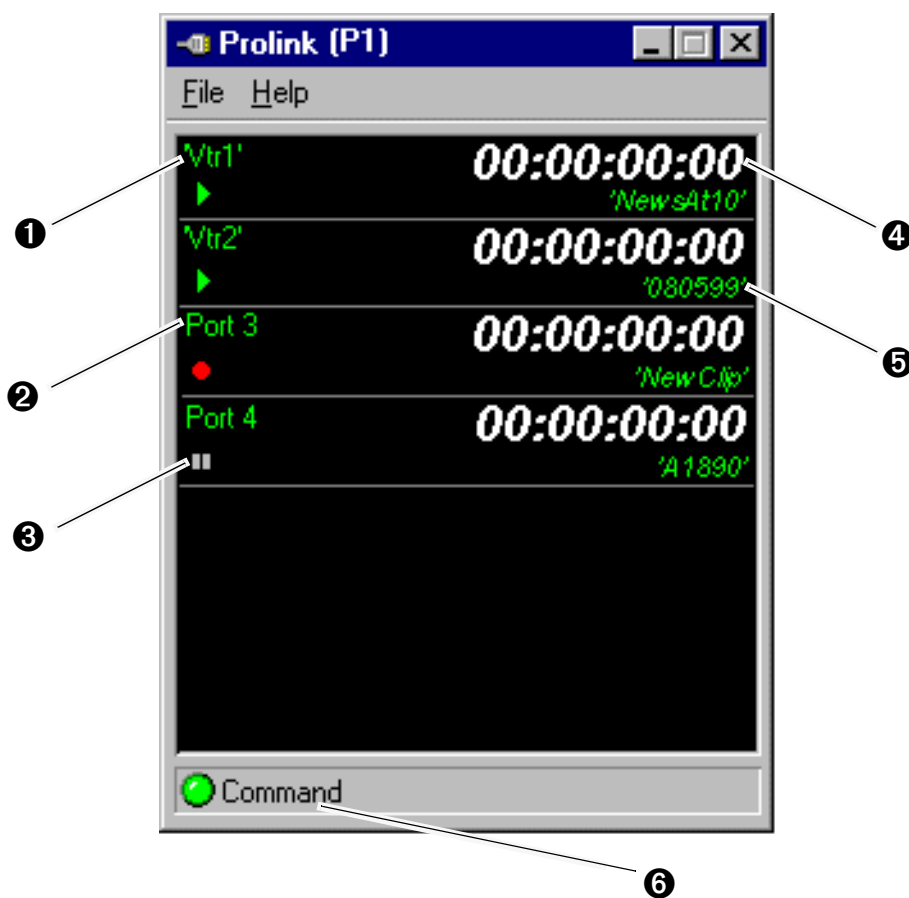

Running PortServer to enable remote operation

PortSever allows you to control a Profile XP remotely using Ethernet. If you want to control or configure the Profile XP over the Ethernet network from a remote system, or transfer media to or from a Profile XP system through the video network, you must have PortServer running on all remote Profile XP systems before performing these operations.

After starting PortServer, see the *Profile XP User Manual* for instructions on how to connect to a remote Profile XP system in the Profile application you are using.

To start PortServer to enable remote operation over Ethernet:

Start PortServer by double-click the PortServer desktop shortcut or choose **Start | Profile Applications | PortServer**.

The PortServer shortcut is set up to run minimized. Notice, the PortServer icon label on the taskbar dynamically displays the number of remote connections

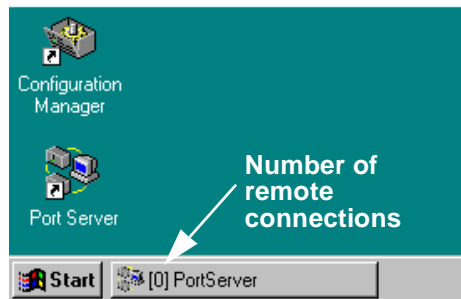

The Portserver window also displays the number of remote connections to the Profile XP system as well as other communications related messages.

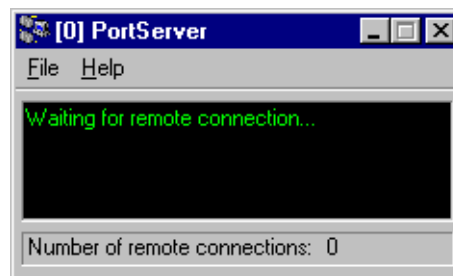

PortServer must be left running on all remote systems as long as remote access is needed.



Setting up a Simple Network

This chapter describes how to set up a simple network of Profile XP systems. Procedures are included for setting up the Windows NT network and both Profile video network options.

Sections in the chapter include:

- About Profile Networking
- Setting up a simple Windows NT network
- Setting up a simple video network: Fibre Channel
- Setting up a simple video network: Ethernet

About Profile Networking

Profile XP network interfaces include a standard Ethernet interface and optional video network interfaces which include a 1Gbps Fibre Channel interface and a 100BaseT Ethernet interface. Both video network options require the Windows NT network connection.

About Windows NT networking

All Profile XP systems include a 10/100BaseT Ethernet interface for Windows NT networking. Connecting the Profile XP to a network not only gives you access to all the standard Windows NT networking features, but also allows remote control and monitoring of your Profile XP system using an NT Workstation running Profile applications. The Windows NT Ethernet network connection is also required when using either the Fibre Channel or Ethernet video network options. Refer to the procedures in “Setting up a simple Windows NT network” on page 204, when you are ready to set up the Windows NT network.

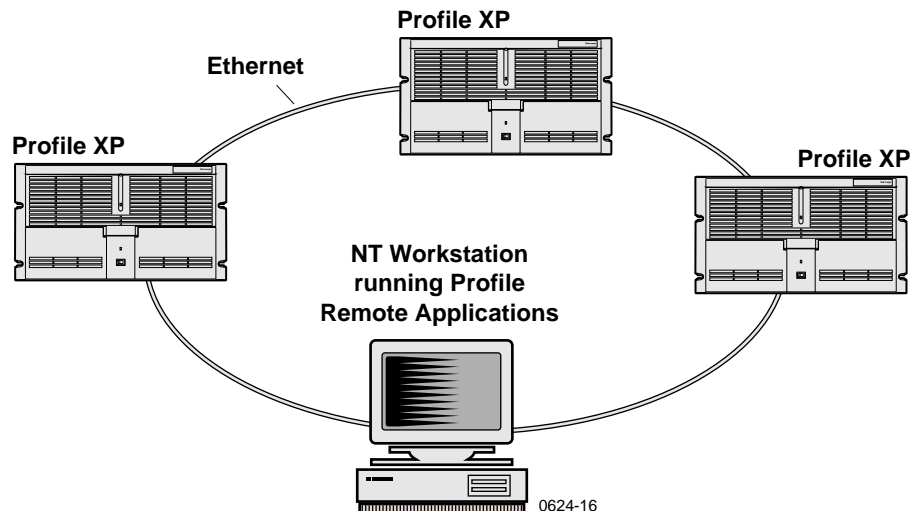



About the Fibre Channel video network option

The Fibre Channel video network actually relies on two separate networks: Fibre Channel and Ethernet. The Fibre Channel network is part of the Real-Time Processor subsystem which manages the flow of video data in and out of the system (refer to “High level block diagram” on page 28 in Chapter 1, *Introducing the Profile XP*). The Fibre Channel network provides the high speed connection between network devices.

The Ethernet network is part of the Windows NT computer system in the Profile XP and is used for control and transport of data associated with the discovery and identification of video clips within the system. This network can be either 10BaseT or 100BaseT Ethernet. Both networks use TCP/IP network protocol.

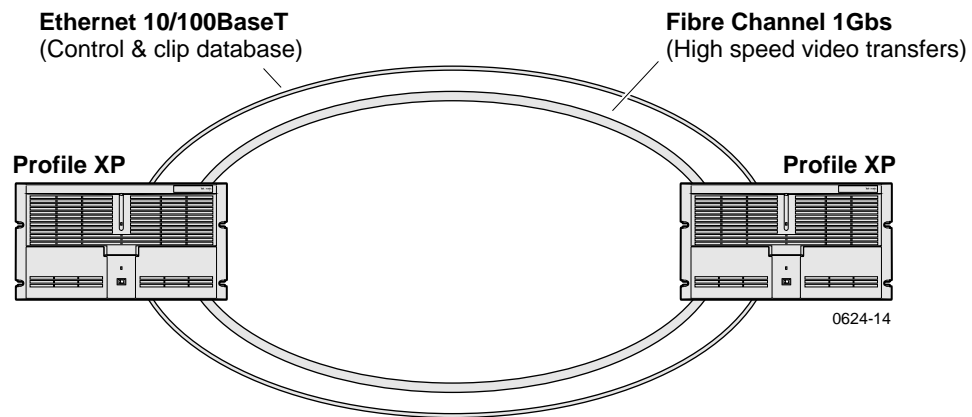

How's it connected together?

How the network is physically connected together refers to what is called the network topology or layout. The Ethernet and Fibre Channel network layouts can differ, so we'll talk about the Ethernet network first.

Ethernet network layout

You can connect your Profile XP systems together using an Ethernet hub or switch. An Ethernet hub is used in most simple Ethernet networks. The Profile XP system provides a 10/100BaseT Ethernet interface and uses a standard RJ-45 connector. Make sure the hub or switch you are using provides RJ-45 connectors.

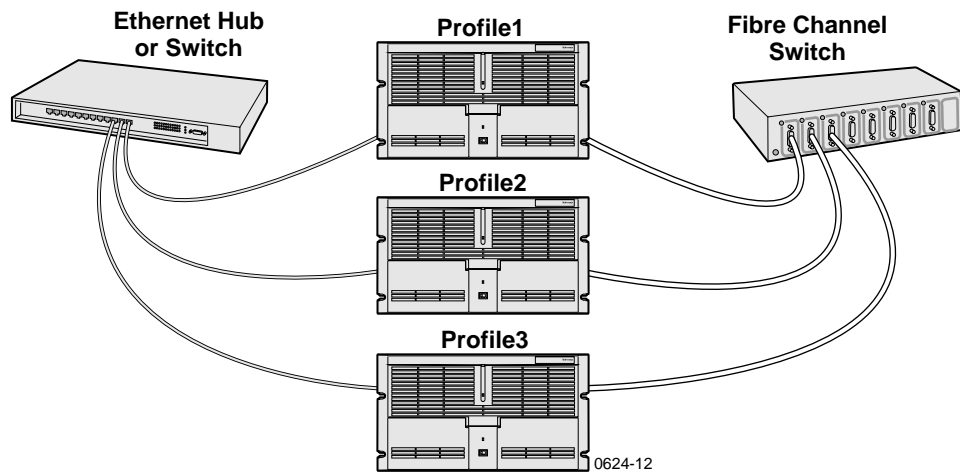

Fibre Channel network layout

Fibre Channel connections are provided by a Fibre Channel switch. Fibre Channel hubs are not supported. A Fibre Channel switch provides a full 1Gbps connection between devices on the network. Using a switch enables multicasting. Multicasting allows transfers of the same file from one to multiple (max of 8) Profile XP systems.



Choosing machine names and IP addresses for your Fibre Channel network

The default machine name for each Profile XP system is the unit serial number. You may want to change the name to something more meaningful, such as **Profile1** or **Profile2**.

The video network option also requires you to set up two IP addresses for each Profile XP unit, one for the Ethernet interface and the other for the Fibre Channel interface. A common mistake is to choose IP addresses for the Fibre Channel and Ethernet interfaces using the same network ID. This is wrong; the IP addresses for each network must be unique.

Here is an example of IP addresses for two Profile XP systems:

Computer Name: **Profile1**
Ethernet Address: **192.168.99.1**
FC Address: **192.168.100.1**

Computer Name: **Profile2**
Ethernet Address: **192.168.99.2**
FC Address: **192.168.100.2**

You can use these addresses if you want, but if you are connecting the Ethernet interface to an existing network, check with your system administrator for the correct names and IP addresses to use.

Use the table below to enter information you'll need when you configure your video network.

Machine Name	Ethernet IP Address	Fibre Channel IP Address

Refer to the procedures in "Setting up a simple video network: Fibre Channel" on page 208, when you to set up the Fibre Channel video network.

About the Ethernet video network option

The video network option actually relies on two separate Ethernet networks: the Windows NT Ethernet network interface which comes standard on all systems and the optional Ethernet video network interface.

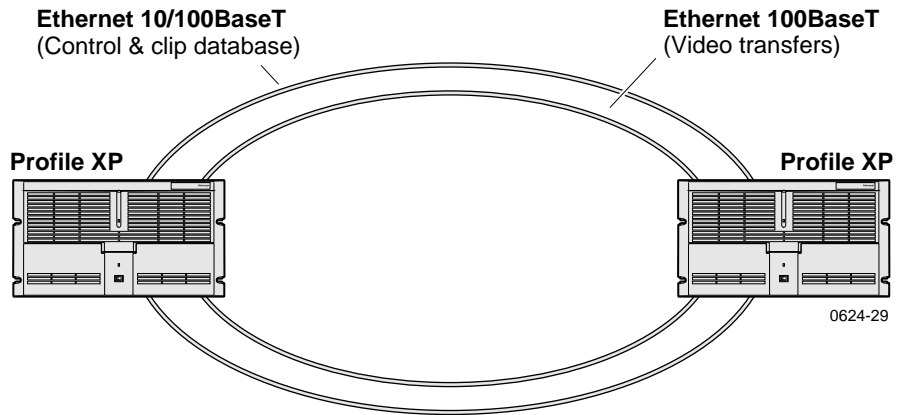

The Windows NT network is used for control and transport of data associated with the discovery and identification of video clips on the network. This network can be either 10BaseT or 100BaseT. The Ethernet video network interface option is used to transfer files over local area and wide area networks. Both networks use TCP/IP network protocol.

After configuring TCP/IP settings for both networks, the hardware can be connected using standard Ethernet hubs or switches. Both Ethernet network interfaces use standard RJ-45 connectors.

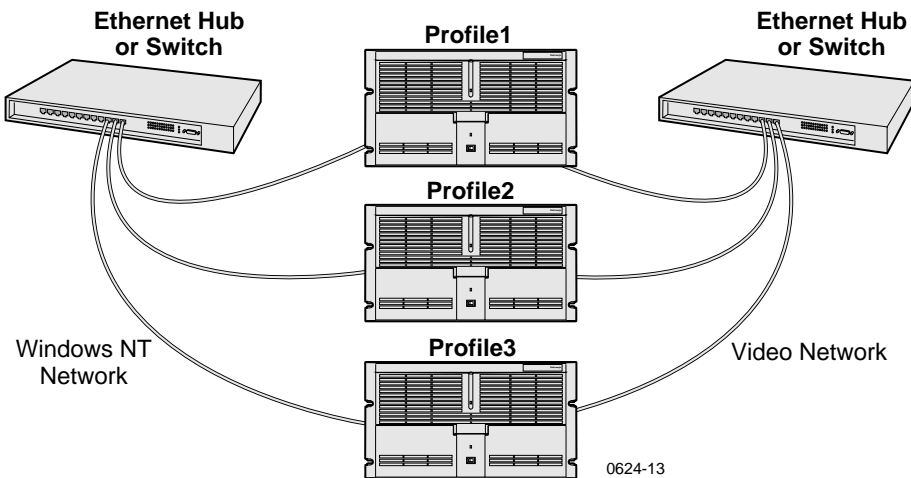



Choosing machine names and IP addresses for your Ethernet video network

The default machine name for each Profile XP system is the unit serial number. You may want to change the name to something more meaningful, such as **Profile1** or **Profile2**.

The video network option also requires you to set up two IP addresses for each Profile XP unit, one for the Windows NT Ethernet interface and the other for the Ethernet video network interface. A common mistake is to choose IP addresses for the Windows NT and video network interfaces using the same network ID. This is wrong; the IP addresses for each network must be unique.

Here is an example of IP addresses for two Profile XP systems:

Computer Name:	Profile1
Windows NT Ethernet interface IP Address:	192.168.99.1
Video Network Ethernet interface IP Address:	192.168.101.1
Computer Name:	Profile2
Windows NT Ethernet interface IP Address:	192.168.99.2
Video Network Ethernet interface IP Address:	192.168.101.2

You can use these addresses if you want, but if you are connecting either Ethernet interface to an existing network, check with your system administrator for the correct names and IP addresses to use.

Use the table below to enter information you'll need when you configure your networks.

Machine Name	Windows NT Ethernet Interface IP Address	Video Network Ethernet Interface IP Address

Refer to the procedures in "Setting up a simple video network: Ethernet" on page 218, when you to set up the Ethernet video network.

Simple Networks

Both the Windows NT network and the Profile video network can accommodate large local area networks and wide area networks which can require advanced computer systems expertise to design, install, and maintain. Setting up these kinds of networks is beyond the scope of this chapter. However, in many applications a simple network is all that's needed. For example, you may want a video network connection between the main and backup Profile XP systems, or perhaps you need a simple ethernet connection between a Profile XP system and a PC to run Profile applications remotely. This chapter was designed with these applications in mind.

Procedures in this chapter make these assumptions:

- For existing networks - If you are connecting to an existing local or wide area network, you will consult with the network administrator to obtain the information you need to set up each Profile XP on the network.
- For new networks - All network devices are connected to a hub or switch and are running Windows NT Workstation. If you are installing a server, for example Windows NT Server, you must consult the vendor documentation.

Whatever your networking need or level of expertise, Grass Valley Group can help you when you are ready to expand your network. More information about networking can be obtained from Grass Valley Group, your consultant, advisor, and commercially available books.

Profile XP systems with both video network options installed

The Profile XP supports installation of both the Fibre Channel and Ethernet video network options. This allows greater flexibility in how you move media within your system. You may choose to use Fibre Channel connectivity for local high speed transfers, while Ethernet provides transfer capability over commercially available networks.

When both a Fibre Channel and Ethernet video network connections exist between two Profile XP systems, the system software will always use the Fibre Channel network to perform the transfer request.

If you are setting up a Profile XP system with both network options installed, it is recommended you install and test one network, then set up and test the other. Refer to either of the following procedures when you are ready to get started.

- “Setting up a simple video network: Fibre Channel” on page 208
- “Setting up a simple video network: Ethernet” on page 218



Setting up a simple Windows NT network

The Windows NT operating system on all Profile XP systems comes pre-configured for connection to Ethernet using TCP/IP protocol on either 10BaseT or 100BaseT networks. The Profile XP Ethernet adapter is set up to auto-sense the correct network speed, so all you have to do is perform the following steps on each Profile XP system you'll be connecting to the network.

Steps to perform:

- Set machine name and IP address on each Profile XP system
- Power-off and connect proper cabling
- Power-on the hub or switch and configure if necessary
- Power-on and test each Profile XP system on the network

***NOTE:** If you are integrating your Profile XP into an existing local or wide area network, you may require more steps than those listed here. You must consult with the network administrator to obtain the information you need to configure the Profile XP for an existing network.*

Set machine name and IP address on each Profile XP system

Use these steps to set the machine name and IP address on each Profile XP system.

1. Set up the machine name as follows:
 - a. Log on as Administrator (see “Logging on Windows NT” on page 35).
 - b. Open the Control Panel by clicking **Start | Settings | Control Panel**.
 - c. Double-click **Network**.
 - d. On the Identification tab click the **Change** button.
 - e. In the Computer Name box enter a name for the Profile XP system. The default name for each Profile XP system is the unit serial number. You may want to use something more meaningful, such as **Profile1** or **Profile2**.
 - f. Click **OK** to close Computer Name dialog box.

7. Set up the IP address as follows:
 - a. In the Network dialog box click the **Protocols** tab.
 - b. Highlight **TCP/IP Protocol** and then click **Properties**.
 - c. Click the **IP Address** tab, then click **Specify IP Address**.
 - d. Enter an IP address for the Profile XP.
 - e. If you are not connecting to an existing network, you can choose any IP address you want. Here are some examples of IP addresses and names you could use:

Computer Name: **Profile1**
Ethernet Address: **192.168.99.1**

Computer Name: **Profile2**
Ethernet Address: **192.168.99.2**
 - f. Verify the Subnet Mask is set to 255.255.255.0.
 - g. Click **OK** to close the TCP/IP Properties dialog box, then click **OK** to close the Network dialog box.
 - h. When asked to reboot click **NO**, then close the **Control Panel**.
 - i. Shutdown Windows NT, then power-off the Profile XP when the message is displayed to do so.



Power-off and connect proper cabling

The Ethernet connector for Windows NT networking is an RJ-45 connector located on the rear panel as shown. Ethernet cables are provided with your Profile XP system. If these cables are not used, be sure to refer to Appendix B, “*Connector Pin-outs*” for cabling specifications and pinouts.

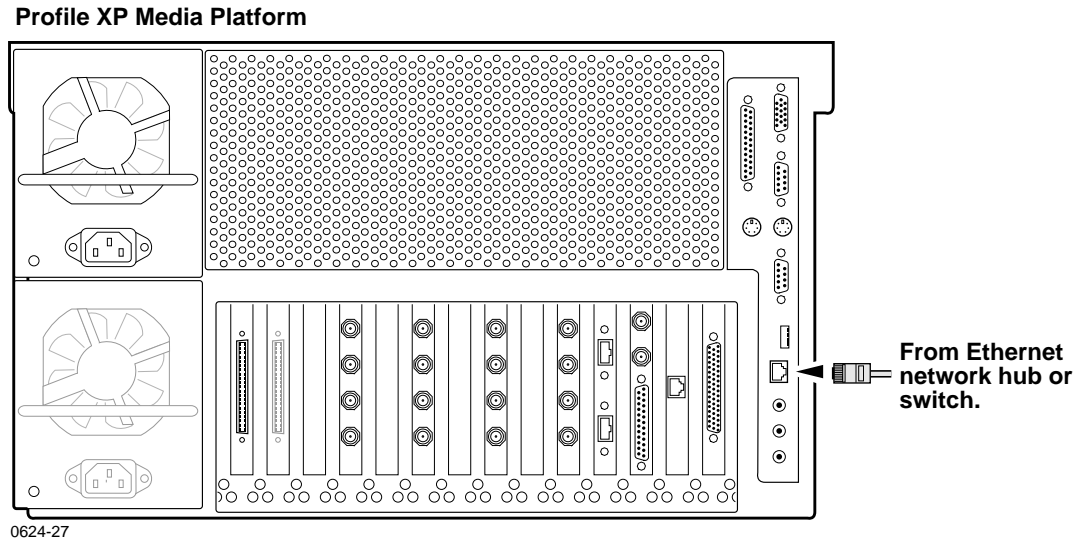

You can connect your Profile XP systems together using an Ethernet hub or switch. An Ethernet hub is used in most simple Ethernet networks.

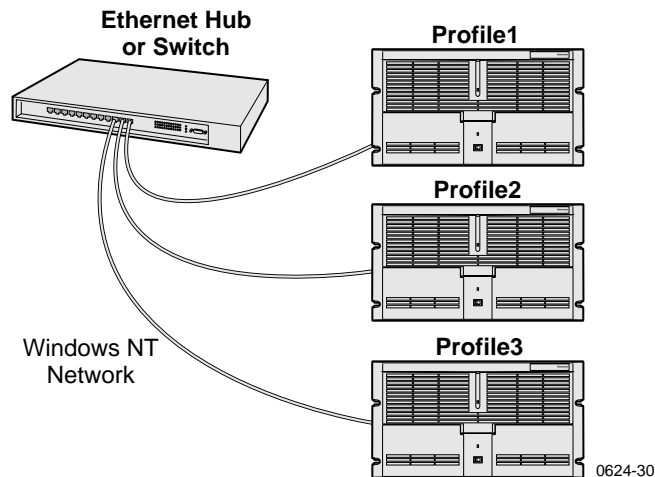

Power-on the hub or switch and configure if necessary

Refer to the your device's vendor documentation to power-on and configure as required.

Power-on and test each Profile XP system on the network

Use Network Neighborhood to test network configuration and connectivity.

To test the network:

1. Power-on two Profile XP systems.
2. Perform the following test on each Profile XP system:
 - a. On the desktop, click Network Neighborhood.
 - b. Verify that all systems on the network are listed. If the **Workgroup** icon appears, you may have to double-click the **Workgroup** icon.



3. Power-on the next Profile XP system and wait for it to initialize, then repeat step 2. Continue adding one system at a time until all Profile XP systems have been tested. You may have to refresh the Network Neighborhood window to see new systems displayed.

NOTE: *If you have a problem, refer to Chapter 10, "Solving Common Setup Problems", on page 229.*

Now that you have tested the network connections for all Profile XP systems, you are ready to use the Ethernet network. If you are setting up an optional video network, return to one of the following procedures:

“Setting up a simple video network: Fibre Channel” on page 208

“Setting up a simple video network: Ethernet” on page 218



Setting up a simple video network: Fibre Channel

The Fibre Channel video network option provides a 1Gbs Fibre Channel interface for high speed transfer of video clips among devices connected to the network. Network devices can include Profiles or Profile XP systems, near-on-line video servers, and video archive systems to name a few. Use the procedures in this section to set up your Profile XP systems on a Fibre Channel video network.

Here is a list of the steps you will perform:

- Set up the Windows NT Ethernet network
- Configure Fibre Channel network settings on each Profile XP
- Manually Edit the hosts file on each Profile XP
- Power-down and connect proper Fibre Channel cabling
- Power-on the switch and configure if necessary
- Test the Fibre Channel network using Media Manager

NOTE: To communicate across the network, all Fibre Channel machines should have Profile system software version 2.5 installed.

Set up the Windows NT Ethernet network

When setting up the Fibre Channel network, you must first set up the Windows NT Ethernet network. Use the procedure found on page 204, “Setting up a simple Windows NT network”, then continue with “Configure Fibre Channel network settings on each Profile XP” on page 209.

Configure Fibre Channel network settings on each Profile XP

After setting up the Windows NT network, you must configure the IP address and subnet mask for the Fibre Channel interface and choose the network options you want to use.

To configure the Fibre Channel network settings:

1. Open Configuration Manager using the desktop shortcut or by choosing **Start | Programs | Profile Applications | Configuration Manager**.
2. Choose **Network** in the Configuration Manager window. The Network dialog box appears.

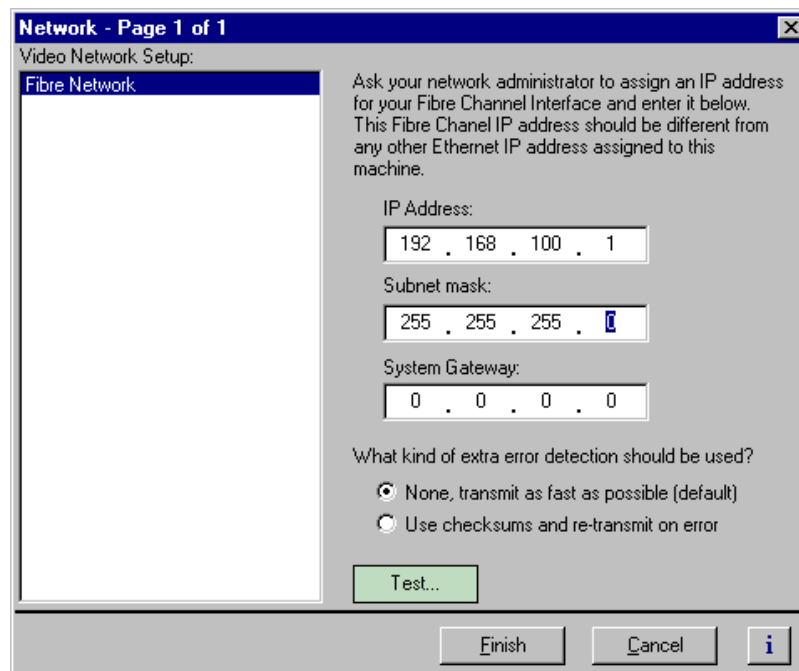

3. Enter the IP address and Subnet mask for the Fibre Channel interface.

NOTE: Be sure to read all the information about choosing IP addresses for the Fibre Channel video network option on page 200, “Choosing machine names and IP addresses for your Fibre Channel network”.

4. Enter the IP address for the system gateway if used.
5. Select the error detection options you want to use. Enabling extra error detection insures data transfer without corruption. Disabling extra error detection speeds up network transfers.
6. Click **Finish** to save your settings.



Manually Edit the *hosts* file on each Profile XP

NOTE: *Perform this step if you disabled Autohost file administration earlier.*

The *hosts* file is used by the video network to determine the Ethernet and Fibre Channel IP address of devices on the network when only a the device name is given. The steps that follow describe how to edit the *hosts* file located at `c:\winnt\system32\drivers\etc\hosts`. If you include the names and addresses of all the devices on the network, then you can copy the same file onto all the other Profile XP systems instead of editing the *hosts* file on each Profile XP system.

NOTE: *An alternative to manually editing the hosts file is to use the Autohosts file administration feature discussed earlier.*

To edit the *hosts* file manually:

1. Open the following file using Notepad or some other text editing application.

`c:\winnt\system32\drivers\etc\hosts`

2. The text format is simple. First type the Ethernet IP address, then use the TAB key or Space bar to insert a few spaces. Now type the machine name, such as **Profile1**. On the next line, type the IP address of the Fibre Channel interface of the same Profile XP followed by the machine name again, only this time, add the characters **_fc0**.

Here is an example:

```
192.168.99.1      Profile1
192.168.100.1Profile1_fc0
192.168.99.2Profile2
192.168.100.2Profile2_fc0
```

The following is shows the content of the default Windows NT *hosts* file with the new lines added. All lines beginning with a # are comments and can be ignored or deleted.

```
# Copyright (c) 1993-1995 Microsoft Corp.
#
# This is a sample HOSTS file used by Microsoft TCP/IP for Windows NT.
#
# This file contains the mappings of IP addresses to host names. Each
# entry should be kept on an individual line. The IP address should
# be placed in the first column followed by the corresponding host name.
# The IP address and the host name should be separated by at least one
# space.
#
# Additionally, comments (such as these) may be inserted on individual
# lines or following the machine name denoted by a '#' symbol.
#
# For example:
#
# 102.54.94.97 rhino.acme.com # source server
# 38.25.63.10 x.acme.com # x client host

127.0.0.1 localhost
192.168.99.1 Profile1
192.168.100.1 Profile1_fc0
192.168.99.2 Profile2
192.168.100.2 Profile_fc0
```

3. Save the file and exit the text editor.
4. Reboot your Profile XP unit.
5. Copy the new *hosts* file onto all the other machine to save you editing it again.



Power-down and connect proper Fibre Channel cabling

The Fibre Channel network interface uses a fiber optical connector located on the rear panel as shown. Fiber optic cables are provided with your Profile XP system. If these cables are not used, be sure to refer to Appendix B, “Connector Pin-outs”, for cabling specifications.

Connect the fiber optic cable between the Fibre Channel switch and the Profile XP network connectors as shown.

NOTE: Do not force the fiber optic plug into the Fibre Channel board connector as you may damage the connector, the plug, or both. Make certain the fiber surface is clean, free of dust or debris, before inserting the connector into the Fibre Channel board connector.

Profile XP Media Platform

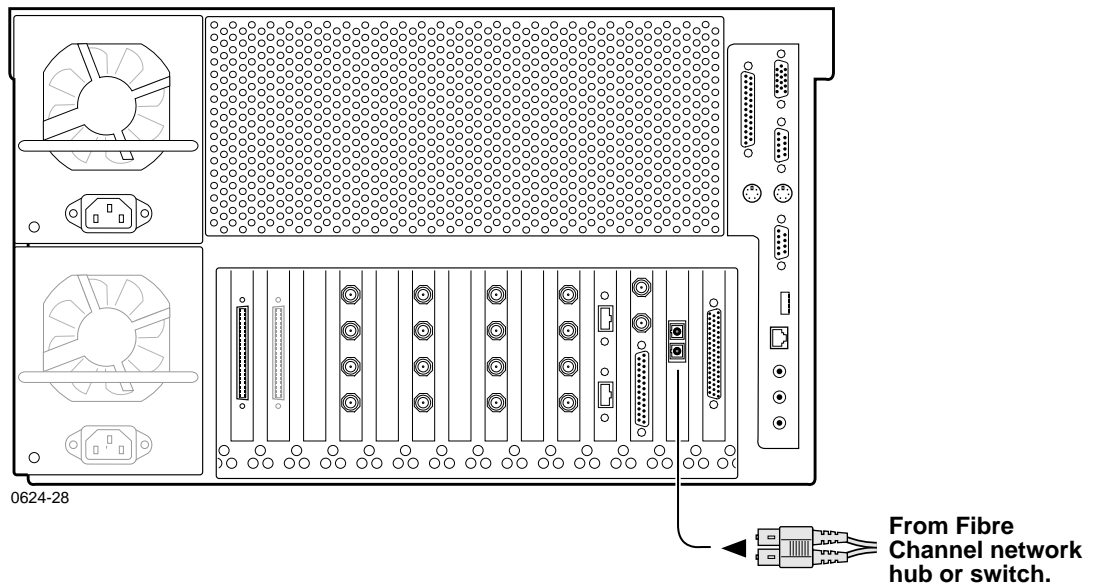

You can connect your Profile XP systems together using a Fibre Channel switch.

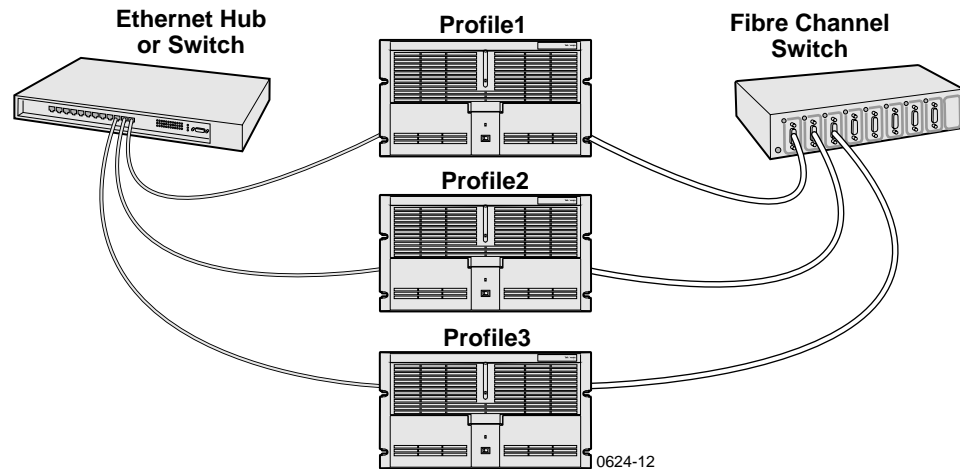

Power-on the switch and configure if necessary

Refer to the your device's vendor documentation to power-on and configure as required.

Test the Fibre Channel network using Media Manager

Use this procedure to perform a quick test of your video network setup with Media Manager. Media Manager allows you to have access to media stored anywhere on your network and provides tools for managing that media—such as explore, cut, copy, paste, delete and transfer. You can manage media stored locally on the disk array attached to the Profile XP system or on any Profile XP system connected to the network. You can also transfer media stored on any Profile XP system on your video network via the video network connection. For detailed information on using all the features of Media Manager, refer to the *Profile XP User Manual*.

This procedure tests the Fibre Channel network starting with only two Profile XP systems, then continues by adding one Profile XP system at a time until all systems are on and tested.

NOTE: *If you encounter a problem during any portion of this test procedure, refer to Chapter 10, "Solving Common Setup Problems", on page 229.*

To test the Fibre Channel video network:

1. Power-on two Profile XP systems.
2. Perform the following test on each Profile XP system:
 - a. Double-click on the Port Server icon. This starts the Fibre Channel communication tool. It must always be running on any machine where you are using Fibre Channel. If you want, you can place Port Server in StartUp folder and set it to run minimized. Make sure it's running on the other Profile machine, too.
 - b. Start Media Manager by double-clicking the shortcut on the desktop or by choosing **Start | Programs | Profile Applications | Media Manager**. The Media



Manager window appears.

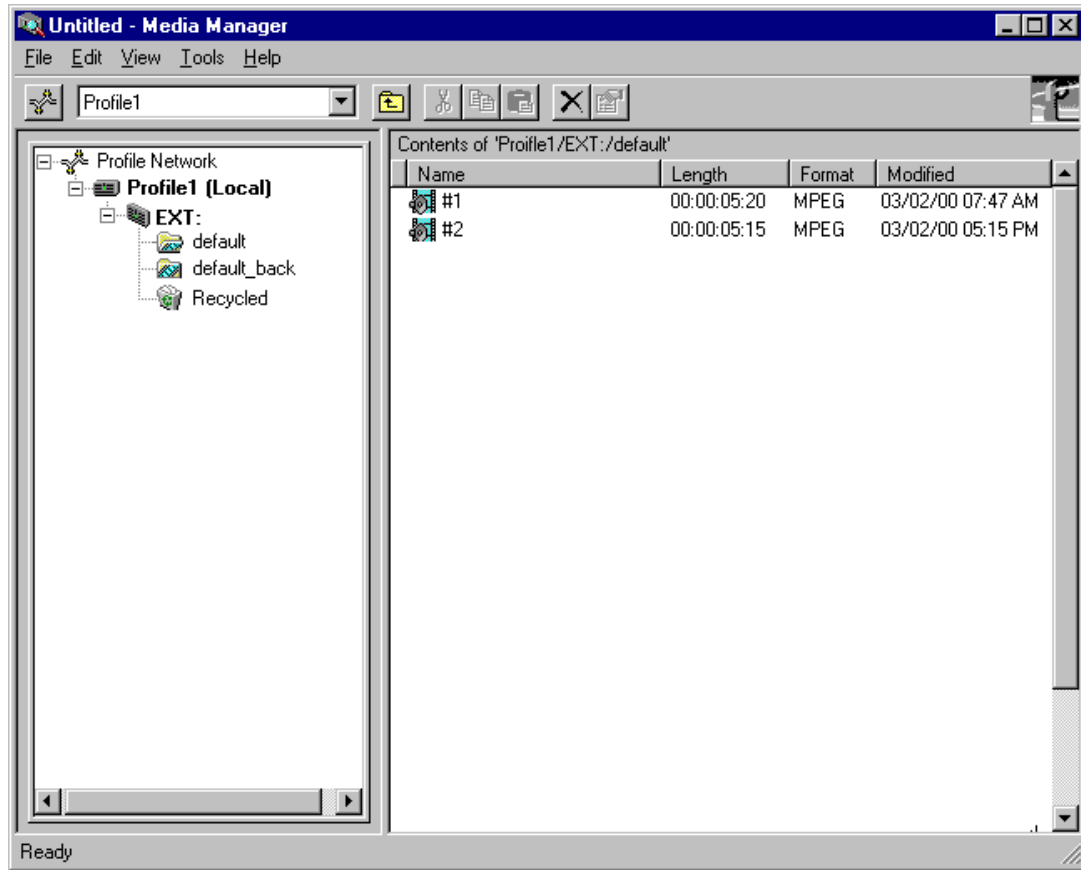

NOTE: You will not automatically see the other machine on the network. For example, if you are running Media Manager on Profile1 you will only see Profile1.

- c. Choose **File | Add/Remove Machine**. The Add/Remove Machine dialog box appears. The *Local* label follows the name of the current machine.

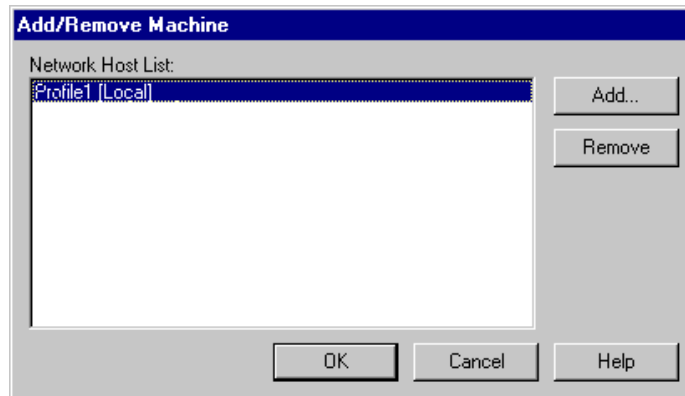

- d. Click **Add**. The Add Network Host dialog box appears.

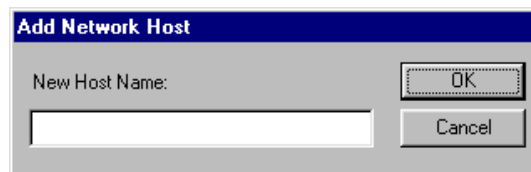

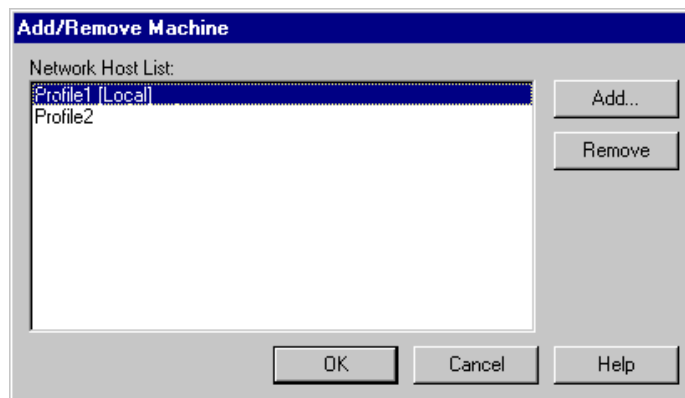

- e. Enter the name of the other machine in the New Host Name box (**Profile2** for example), then click **OK**. The new host name is added to the network host list as shown.

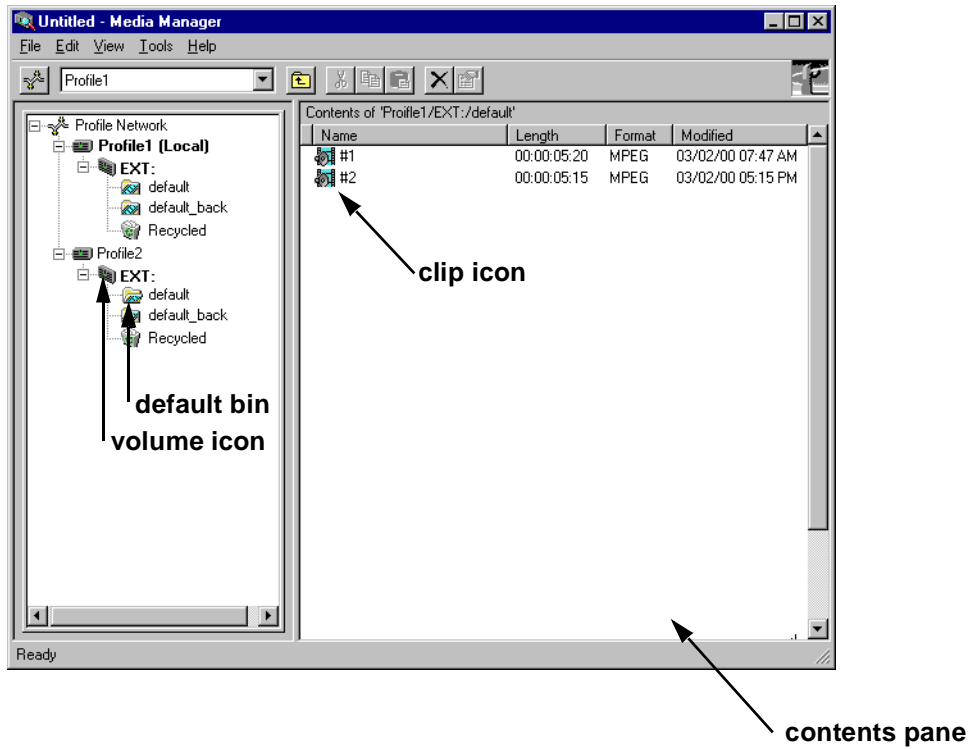

- f. Click **OK** to close the Add/Remove Machine window. The Connection Status message box appears showing the progress of new connection, then the Media Manager window reappears including the machine name just added.



7. Power-on the next Profile XP system and wait for it to initialize, then repeat step 2. Continue adding one system at a time until all Profile XP systems have been added to Media Manager.

8. Use the following steps to transfer a clip over the network.
 - a. Double click on the icon of another machine on the network.
 - b. Double click on the volume icon  (default name is “Ext”) in the same machine. A default bin should be displayed.
 - c. Double click on the icon of the local machine on the network and then the volume icon . If there are no clips on any machines, you can open VdrPanel and create some. (See *Profile XP User Manual* for VdrPanel information.)
 - d. Click and drag a clip to a bin on another machine. Dragging a clip to a different machine always results in a copy—the original clip is not deleted.
 - e. Repeat steps a through d until you have tested the network to your satisfaction.



NOTE: You can select the transfer monitor icon on the toolbar to open the transfer monitor and watch the progress of the network transfer.

Now that you have tested the network connections for all Profile XP systems, you are ready to use the video network.



Setting up a simple video network: Ethernet

The Ethernet video network option provides a 10/100BaseT Ethernet interface for transfer of video clips among devices connected to the network. Network devices can include other Profile XP systems, near-on-line video servers, and video archive systems to name a few. Use the procedures in this section to set up your Profile XP systems on a Ethernet video network.

Here is a list of the steps you will perform:

- Set up the Windows NT Ethernet network
- Configure the video network on each Profile XP: Ethernet
- Manually Edit the hosts file on each Profile XP
- Power-off and connect proper Ethernet cabling
- Power-on the hub or switch and configure if necessary
- Test the Ethernet video network using Media Manager

Set up the Windows NT Ethernet network

When installing the Ethernet video network option, you must first set up the Windows NT Ethernet network. Use the procedure found on page 204, “Setting up a simple Windows NT network”, then return to this page and continue with “Configure the video network on each Profile XP: Ethernet”.

Configure the video network on each Profile XP: Ethernet

After setting up the Windows NT network interface, you must configure the IP address and subnet mask for the video network Ethernet interface and choose the network options you want to use.

To configure the video network Ethernet settings:

1. Open Configuration Manager using the desktop shortcut or by choosing **Start | Programs | Profile Applications | Configuration Manager**.
2. Choose **Network** in the Configuration Manager window. The Network

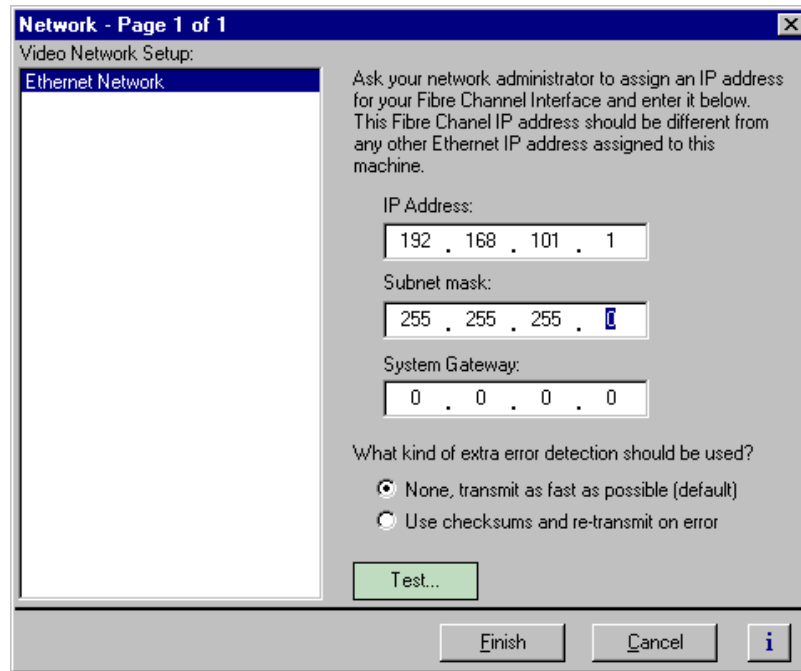

3. Enter the IP address and Subnet mask for the video network Ethernet interface.

NOTE: Be sure to read all the information about choosing IP addresses for the Fibre Channel video network option on page 202, “Choosing machine names and IP addresses for your Ethernet video network”.

4. Enter the IP address for the gateway if used.
5. Select the error detection options you want to use. Enabling extra error detection insures data transfer without corruption. Disabling extra error detection speeds up network transfers.
6. Click **Finish** to save your settings.



Manually Edit the *hosts* file on each Profile XP

NOTE: Perform this step if you disabled *Autohost file administration* earlier.

The *hosts* file is used by the video network to determine the IP address of devices on the network when only a the device name is given. The steps that follow describe how to edit the *hosts* file located at `c:\winnt\system32\drivers\etc\hosts`. If you include the names and addresses of all the devices on the network, then you can copy the same file onto all the other Profile XP systems instead of editing the *hosts* file on each Profile XP system.

NOTE: An alternative to manually editing the *hosts* file is to use the *Autohosts file administration* feature discussed earlier.

To update your *hosts* file manually:

1. Open the following file using Notepad or some other text editing application.

`c:\winnt\system32\drivers\etc\hosts`

2. The text format is simple. First type the Ethernet IP address, then use the TAB key or Space bar to insert a few spaces. Now type the machine name, such as **Profile1**. On the next line, type the IP address of the video network Ethernet interface of the same Profile XP followed by the machine name again, only this time, add the characters **_le**.

Here is an example:

```
192.168.99.1      Profile1
192.168.101.1Profile1_le
192.168.99.2Profile2
192.168.101.2Profile2_le
```

The following shows the content of the default Windows NT *hosts* file with the new lines added. All lines beginning with a # are comments and can be ignored or deleted.

```
# Copyright (c) 1993-1995 Microsoft Corp.
#
# This is a sample HOSTS file used by Microsoft TCP/IP for Windows NT.
#
# This file contains the mappings of IP addresses to host names. Each
# entry should be kept on an individual line. The IP address should
# be placed in the first column followed by the corresponding host name.
# The IP address and the host name should be separated by at least one
# space.
#
# Additionally, comments (such as these) may be inserted on individual
# lines or following the machine name denoted by a '#' symbol.
#
# For example:
#
#   102.54.94.97   rhino.acme.com   # source server
#   38.25.63.10   x.acme.com       # x client host

127.0.0.1        localhost
192.168.99.1     Profile1
192.168.101.1   Profile1_le
192.168.99.2    Profile2
192.168.101.2   Profile2_le
```

3. Save the file and exit the text editor.
4. Reboot your Profile XP unit.
5. Copy the new *hosts* file onto all the other machine to save you editing it again.



Power-off and connect proper Ethernet cabling

The Ethernet interface connector for the video network is located on the rear panel as shown. The video network option provides a standard RJ-45 connector.

Ethernet cables were provided with your Profile XP system. If these cables are not used, be sure to refer to Appendix B, “*Connector Pin-outs*” for cabling specifications and pinouts.

Profile XP Media Platform

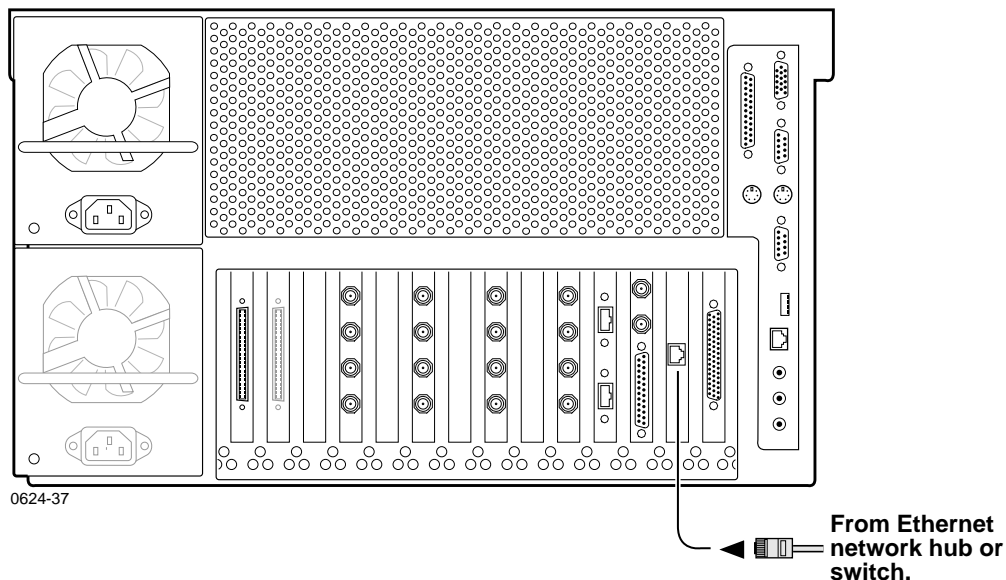

You can connect your Profile XP systems together using an Ethernet hub or switch. An Ethernet hub is used in most simple Ethernet networks. A switch is required for multicasting.

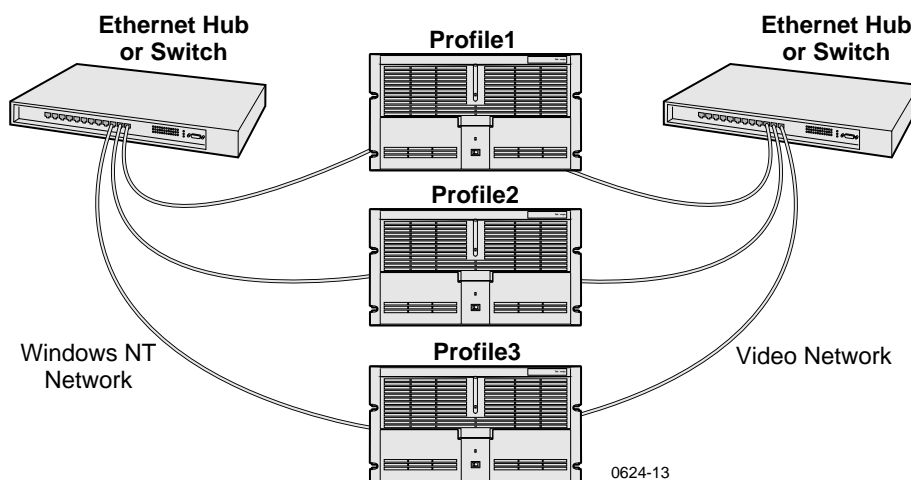

Power-on the hub or switch and configure if necessary

Refer to the your device's vendor documentation to power-on and configure as required.

Test the Ethernet video network using Media Manager

Use this procedure to perform a quick test of your video network setup with Media Manager. Media Manager allows you to have access to media stored anywhere on your network and provides tools for managing that media—such as explore, cut, copy, paste, delete and transfer. You can manage media stored locally on the disk array attached to the Profile XP system or on any Profile XP system connected to the network. You can also transfer media stored on any Profile XP system on your video network via the video network connection. For detailed information on using all the features of Media Manager, refer to the *Profile XP User Manual*.

This procedure tests the video network starting with only two Profile XP systems, then continues by adding one Profile XP system at a time until all systems are on and tested.

NOTE: If you encounter a problem during any portion of this test procedure, refer to Chapter 10, “Solving Common Setup Problems”, on page 229.

To test the video network:

1. Power-on two Profile XP systems.
2. Perform the following test on each Profile XP system:
 - a. Double-click on the Port Server icon. This starts the video network communication tool. It must always be running on any machine where you are using video network. If you want, you can place Port Server in StartUp folder and set it to run minimized. Make sure it's running on the other Profile machine, too.



- b. Start Media Manager by double-clicking the shortcut on the desktop or by choosing **Start | Programs | Profile Applications | Media Manager**. The Media Manager window appears.

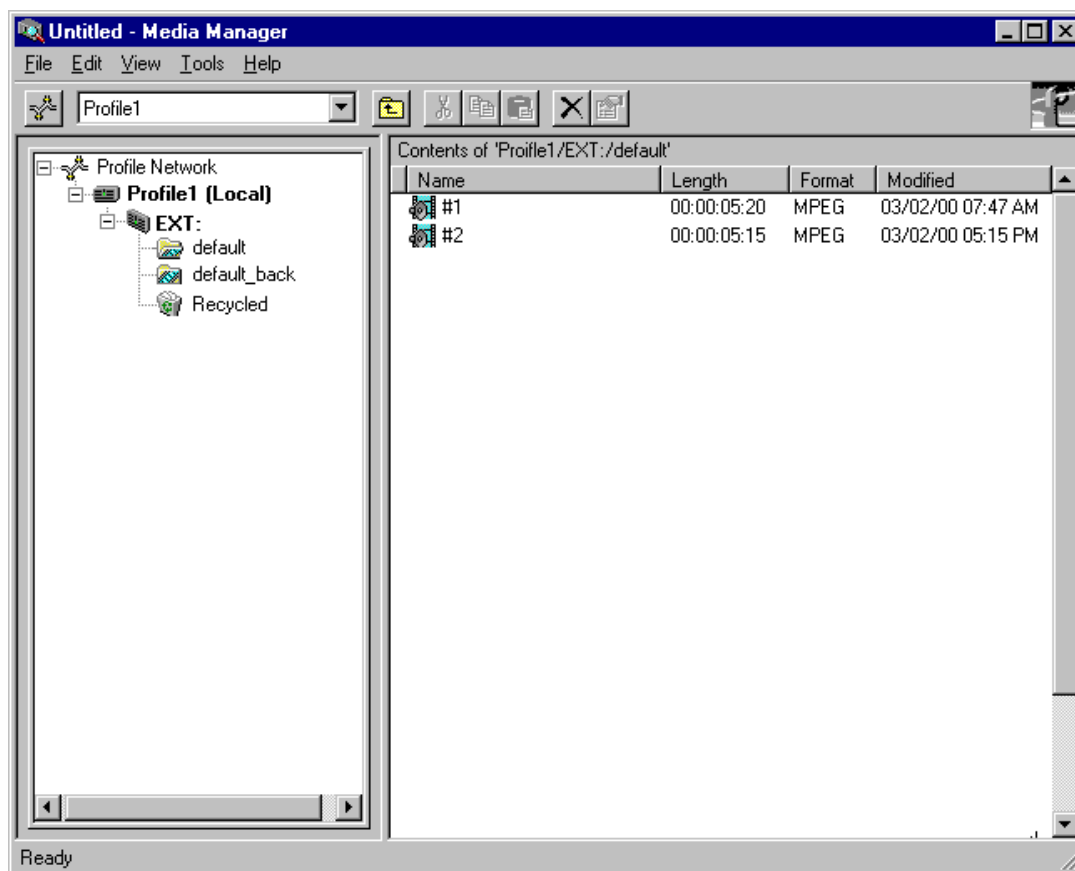

NOTE: You will not automatically see the other machine on the network. For example, if you are running Media Manager on Profile1 you will only see Profile1.

- c. Choose **File | Add/Remove Machine**. The Add/Remove Machine dialog box appears. The *Local* label follows the name of the current machine.

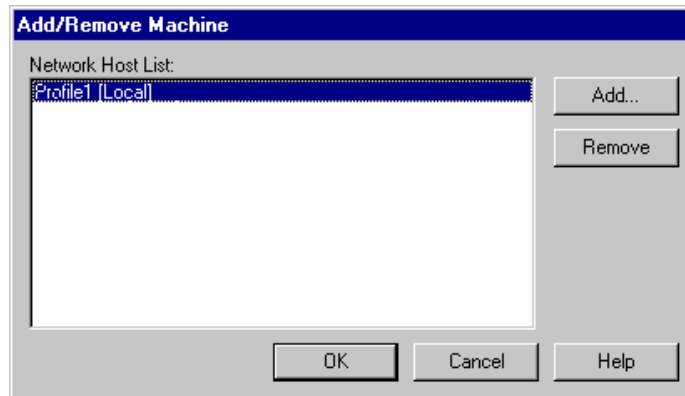

- d. Click **Add**. The Add Network Host dialog box appears.

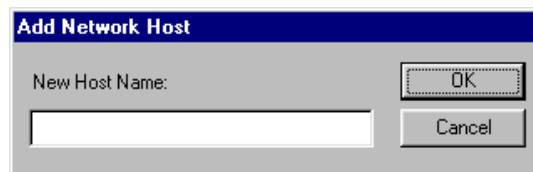

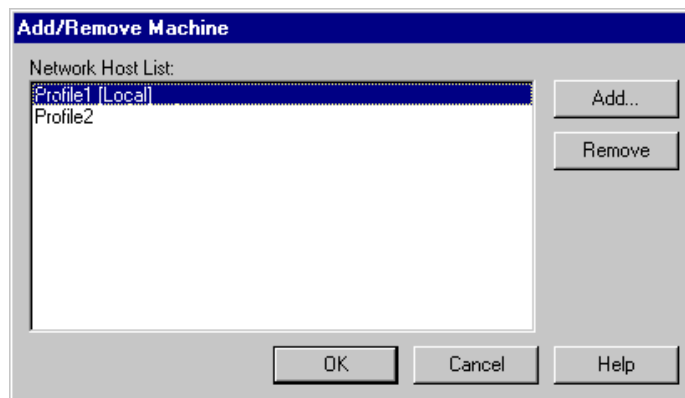

- e. Enter the name of the other machine in the New Host Name box (**Profile2** for example), then click **OK**. The new host name is added to the network host list as shown.

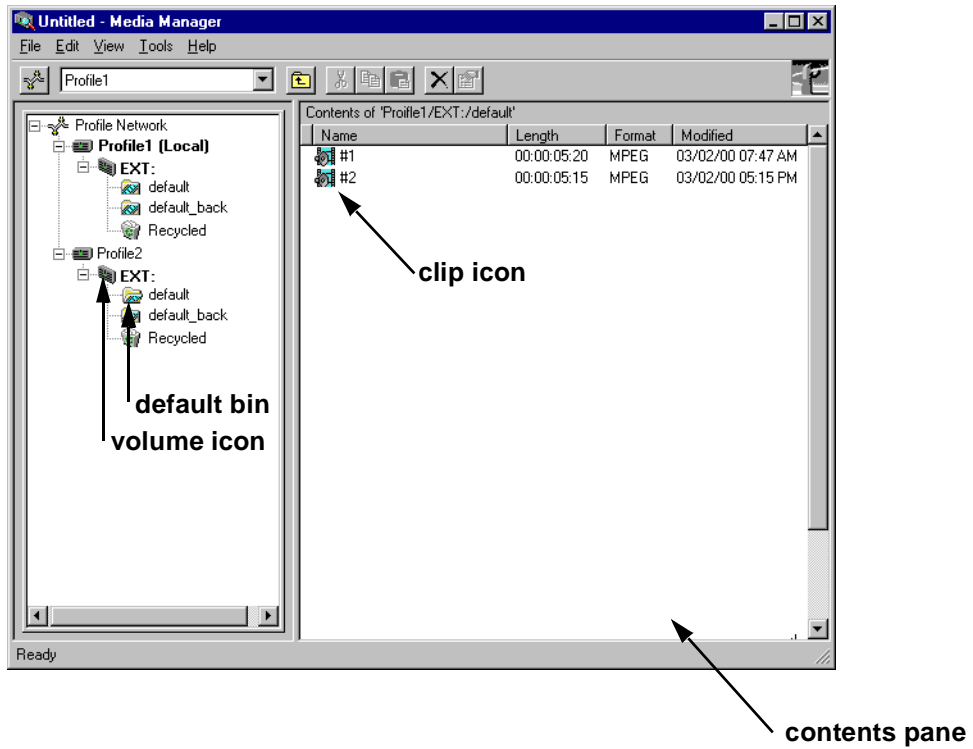

- f. Click **OK** to close the Add/Remove Machine window. The Connection Status message box appears showing the progress of new connection, then the Media Manager window reappears including the machine name just added.



7. Power-on the next Profile XP system and wait for it to initialize, then repeat step 2. Continue adding one system at a time until all Profile XP systems have been added to Media Manager.

8. Use the following steps to transfer a clip over the network.
 - a. Double click on the icon of another machine on the network.
 - b. Double click on the volume icon  (default name is “Ext”) in the same machine. A default bin should be displayed.
 - c. Double click on the icon of the local machine on the network and then the volume icon . If there are no clips on any machines, you can open VdrPanel and create some. (See *Profile XP User Manual* for VdrPanel information.)
 - d. Click and drag a clip to a bin on another machine. Dragging a clip to a different machine always results in a copy—the original clip is not deleted.
 - e. Repeat steps a through d until you have tested the network to your satisfaction.



NOTE: You can select the transfer monitor icon on the toolbar to open the transfer monitor and watch the progress of the network transfer.

Now that you have tested the network connections for all Profile XP systems, you are ready to use the video network.



Solving Common Setup Problems

This chapter provides help for solving some common setup problems that occur because Profile XP system features or signal requirements are not well understood. This chapter is organized by problem area with troubleshooting tables that provide symptom, probable cause, and corrective action.

If you do not solve your system problem using the information in this chapter, refer to the *Profile XP Service Manual* for more in-depth troubleshooting information. If all else fails, contact Grass Valley Support. Grass Valley Product Support contact information is located on page 14 of this manual.

Summary of setup problems

If you experience a problem setting up the Profile XP system, first check all external connections to make sure they are properly made, then refer to the list of problem areas in the following table. Begin on the page indicated to find help in solving your setup problem.

Problem Area	Begin on Page
Common record/play problems	230
Problems with video	231
Problems with audio	232
Problems with timecode	234
Storage system problems	236
Problems using Configuration Manager	237
Channel control problems	238
Common Ethernet network problems	239
Common Fibre Channel video network problems	240
Common Ethernet video network problems	245



Common record/play problems

This troubleshooting aid provides corrective action for some common record/play problems. Search the table for the problem you are experiencing, then try the corrective action. Some problems have more than one corrective action.

Problem	Possible Cause	Corrective Action
Application fails to select a channel or channels when it is started.	Resource conflict because a resource needed by the channel is already in use.	Check for resources that may be assigned to more than one channel and correct the problem. Refer to “Using the Warning symbol to find shared resources” on page 92. Also, make sure the Channel Configuration dialog box is closed before running the application or selecting channels.
The recorded clip contains colorbar.	The colorbar generator is selected as the channel input.	Select the desired video input as the channel source. Refer to “Selecting video quality and crosspoints” on page 98.
The recorded clip contains black or freeze frame.	Loss of input signal.	Verify that you have a valid input signal. Refer to “Viewing video input status” on page 127.
The channel output is black in E to E, but playback is fine.	Loss of input signal.	Verify that you have a valid input signal. Refer to “Viewing video input status” on page 127.
Channel output is always black.	The output you’re monitoring is not assigned to the channel.	Determine the video output assigned to the channel by referring to “Selecting video quality and crosspoints” on page 98, then verify cable connections.
Freeze frames or black frames during playback.	The number of record and play, channels operating simultaneously exceeds the system storage bandwidth.	Reduce the number of channels operating at the same time, or select a lower video quality preset for the record. Refer to “Guidelines for selecting Video Quality Presets” on page 118.

Problems with video

This troubleshooting aid provides corrective action for some common video problems. Search the table for the problem you are experiencing, then try the corrective action. Some problems have more than one corrective action.

Problem	Possible Cause(s)	Corrective Action
Video output distortion in playback and E to E.	Wrong video standard.	Verify system video standard is configured correctly. Refer to "Changing the system video standard" on page 116.
Horizontal aberrations free-running through the picture in Record mode (or E to E). Sometimes intermittent depending on the input signal selected.	Input frame sync set to "pass" when incoming signal is asynchronous.	Set frame sync to "Auto-time". Refer to "Options for timing asynchronous feeds" on page 114.
Continuous horizontal picture shift in Record mode (or E to E). Sometimes intermittent depending on the input signal selected.	Input frame sync set to "pass" when incoming signal is asynchronous.	Set frame sync to "Auto-time". Refer to "Options for timing asynchronous feeds" on page 114.
Playout timing is 16 lines delayed	Playout timing set to E to E timed output.	Change playout timing to "Zero-Timed" output. Refer to "Adjusting playout timing to match zero time" on page 108.
Vertical shift when switching between video input and playout.	Playout timing set to Zero-Timed output.	Change playout timing to "E to E-Timed" output. Refer to "Adjusting playout timing to match E to E timing" on page 110
Compression artifacts are present in the output.	Video quality setting is too low for your program material.	Select higher video quality preset (refer to "Guidelines for selecting Video Quality Presets" on page 118, or define your own video quality preset. Refer to "Defining and selecting a custom video quality preset" on page 123.



Problems with audio

This troubleshooting aid provides corrective action for some common audio problems. Search the table for the problem you are experiencing, then try the corrective action. Some problems have more than one corrective action.

Problem	Possible Cause(s)	Corrective Action
Clicking, popping, or interruptions in the audio signal.	Wrong clock reference selected when asynchronous video input is recorded.	Select the correct video input as the audio sample clock reference for the channel pair. "Selecting the audio clock reference" on page 160.
<i>AES/EBU or analog audio:</i> No audio I/O or the audio does not match the video.	You are using audio I/O connectors for audio channels not assigned to the video channel you are using.	Verify the audio channel pair(s) assigned to the channel you're using. Refer to "Selecting audio channels for an audio track" on page 154.
<i>AES/EBU or analog audio:</i> No audio I/O.	The incorrect audio input format is selected for the audio channels you are using.	Determine the audio channels assigned the channel by referring to "Selecting audio channels for an audio track" on page 154, then verify that the correct audio input format is selected. Refer to "Changing the audio I/O format" on page 155.
<i>Analog audio:</i> Audio is present on audio level meters in applications, but there is no audio output signal.	Analog audio out is muted.	Un-mute the audio output. Refer to "Muting analog audio outputs" on page 166.
<i>Analog audio:</i> Both E to E and playback audio output are distorted.	Audio input signal clipping caused by excessive audio input level or wrong input impedance setting. PAC216 input impedance is set to Hi-Z by default.	Check for input audio clipping, and reduce the input audio level using the input gain adjustment. Refer to "Adjusting analog audio input level" on page 164. Change input impedance to 600 ohms if required in your system.
<i>Analog audio:</i> Audio level is too low.	Analog input and output level can be adjusted in the Profile XP system user interface.	Adjust the input or output audio level as required. Refer to "Adjusting analog audio input level" on page 164 or "Adjusting analog audio output level" on page 165
<i>Embedded audio:</i> No audio input.	Wrong video source selected.	Select the correct video input. Refer to "Select audio input format" on page 155.
<i>Embedded audio:</i> No audio input.	Wrong audio group or channel pair selected.	Determine which audio group is being used in the video input signal by using "Viewing video input status" on page 127, then refer to "Select audio input format" on page 155.

Problem	Possible Cause(s)	Corrective Action
<i>Embedded audio:</i> No audio output.	Wrong video output selected.	Select the correct video output. Refer to “Select audio output format” on page 157.
<i>Embedded audio:</i> No audio output.	Incorrect audio group or channel pair selected for your system.	Verify which embedded audio group and channel pair are used in your system, then refer to “Select audio output format” on page 157.
Audio level meters do not display the correct reference level used in my system.	Incorrect reference level	Refer to “Selecting audio reference level” on page 168.
Distorted audio or no audio	Wrong incoming digital audio coding format selected.	Verify the input audio format is set correctly, refer to “Selecting incoming digital audio coding format” on page 161.



Problems with timecode

This troubleshooting aid provides corrective action for some common timecode problems. Search the table for the problem you are experiencing, then try the corrective action. Some problems have more than one corrective action. VITC Record

Problem	Possible Cause(s)	Corrective Action
VITC: Incorrect recorded timecode.	VITC reader is set to automatic and there are two sets of VITC in the VBI.	Use manual VITC detection and specify lines where VITC should be read. Refer to "Recording VITC" on page 177.
VITC: Incorrect or no recorded timecode.	The VITC reader is set to manual and there are two sets of VITC in the VBI and the wrong VITC lines may be specified.	Verify location of VITC signals and set up manual VITC detection accordingly. Refer to "Recording VITC" on page 177.
VITC: Can't read or record VITC.	VITC detection is set to manual and the wrong VITC lines are specified	Set VITC detect to Automatic or verify location of VITC signals and set up manual VITC detection accordingly. Refer to "Recording VITC" on page 177.
VITC: The VITC output I want to use is not listed in the Timecode Output list.	You have not assigned the corresponding video output to the channel.	Assign the video output you want to use to the channel. Refer to "Selecting the video I/Os used by a channel" on page 117
VITC: Incorrect VITC timecode on the video output.	There may be two sets of VITC on the video output and the external reader is reading the wrong timecode signal. Two VITC signals can occur when there is VITC on the video input or playback signal and at the same time, the video output is generating VITC.	Erase the VITC signal on the video output (refer to "Erasing video input VBI information" on page 130) or turn off the VITC generator on the output (refer to "Setting up the VITC generator on a video output" on page 184 and choose "Do not generate VITC").
VITC: Two sets of VITC signals are present on the output.	There may be two sets of VITC because there is VITC on the video input or playback signal and also the video output is generating VITC.	Erase the VITC signal on the video output (refer to "Deleting unwanted VITC signals" on page 185) or turn off the VITC generator on the output (refer to "Setting up the VITC generator on a video output" on page 184 and choose "Do not generate VITC").
Recorded timecode reads xx.xx.xx.xx.	No timecode source for the channel.	Select a timecode source. Refer to "Selecting timecode I/O for each timecode track" on page 104. This is normal in Profile Applications when there is no clip cued.

Problem	Possible Cause(s)	Corrective Action
<i>LTC:</i> No time code or incorrect time code.	The incorrect LTC input is assigned to the channel you're using.	Determine the LTC input assigned to the channel by referring to "Recording or generating LTC" on page 187, then modify if needed.
<i>LTC:</i> No time code or incorrect time code.	The LTC output you're monitoring is not assigned to the channel.	Determine the LTC output assigned to the channel by referring to "Recording or generating LTC" on page 187, then verify cable connections.
<i>Timecode Burn-in</i> Video Monitor timecode burn-in doesn't change.	The Video Monitor output is not selected as the timecode output for the channel.	Make sure the video monitor you are connected to is selected as a timecode output for the channel. Refer to "Select a timecode source for timecode burn-in" on page 188.



Storage system problems

This troubleshooting aid provides corrective action for some common storage system problems. Search the table for the problem you are experiencing, then try the corrective action. Some problems have more than one corrective action.

Problem	Possible Cause(s)	Corrective Action
No file system found message displayed at first time power-up of the Profile XP system.	No video file system.	If this is a first time start-up for the system, you must create a video file system. Create a video file system on the storage disks. Refer to Chapter 3, "Working with Profile XP storage systems".
No file system found message after a video file system has been created in the past.	All PFC 500s or PFC 500E systems are not powered on and initialized before the Profile XP system is powered on.	PFC 500 and/or one of the expansion chassis is not powered on and fully initialized. Refer to "Connecting storage: Using a single PFC 500" on page 61 or "Connecting storage: Using multiple PFC 500s" on page 64. If this does not help, you may have a hardware problem. Refer to the <i>Profile XP Service Manual</i> and PFC 500 Instruction Manual. Do not create a new file system until you have identified the problem. Making a new file system destroys all existing media.
Cannot "see" the disk system in disk utility.	Interface problem.	Check all cabling and that all systems are fully initialized. Refer to the <i>Profile XP Service Manual</i> , and the <i>PFC 500 Instruction Manual</i> .

Problems using Configuration Manager

This troubleshooting aid provides corrective action for some common problems when using Configuration Manager or the remote version of Configuration Manager included in NetCentral XP Enterprise. Search the table for the problem you are experiencing, then try the corrective action. Some problems have more than one corrective action.

Problem	Possible Cause(s)	Corrective Action
Configuration Manager does not display the effect of your crosspoint selections as you make them.	Another application is using the channel or a channel which uses one or more of the same resources.	Terminate the use of the channel by the application.
After using import or export the two Profile XP systems do not have the same configuration.	There may be hardware differences between the Profile XP systems which include circuit board locations in the motherboard.	Compare the hardware configurations of the two systems. Refer to "Viewing board location information" on page 47.
When attempting to connect to a remote system, the remote Profile XP system does not appear in the "Remote Host List".	No network connection.	Refer to "Common Ethernet network problems" on page 239.
Cannot connect to a remote machine after selecting it in the "Remote Host List".	PortServer not running on the remote machine.	Start PortServer on remote Profile XP system. Refer to "Running PortServer to enable remote operation" on page 195.
A message appears that states that Configuration Manager is already running.	Configuration Manager already running or some one is running Configuration Manager remotely.	Use the Configuration Manager already running or resolve the conflict with the remote user.
Can't start Configuration Manager locally.	Configuration Manager is already running or someone is connected remotely.	Use the session already running or terminate the remote session.



Channel control problems

This troubleshooting aid provides corrective action for some common control problems. Search the table for the problem you are experiencing, then try the corrective action. Some problems have more than one corrective action.

Problem	Possible Cause	Corrective Action
<i>VdrPanel RS-422 Control:</i> The Profile XP system fails to respond.	Incorrect protocol selected	Refer to “Setting up RS-422 remote control in VdrPanel” on page 190.
<i>VdrPanel RS-422 Control:</i> The Profile XP system fails to respond.	Controller connected to the wrong RS-422 port.	Check for proper connection.
<i>Prolink:</i> Cannot open channel.	<i>Channel names do not match those expected by the controller.</i>	<i>Define new channels or rename existing ones Refer to “Adding and configuring a new channel” on page 94 or “Entering channel name and description” on page 94.</i>
<i>Prolink:</i> Cannot open channel.	Controller connected to the wrong RS-422 port.	Check the title bar of the Prolink window and verify the RS-422 cable is connected to the correct physical port (P1-P8).
<i>Ethernet:</i> Cannot connect to a remote machine.	PortServer is not running on remote machine.	Start PortServer on remote machine. Refer to “Running PortServer to enable remote operation” on page 195.
<i>Ethernet:</i> When running an application remotely, you cannot find the Profile XP system listed in the Remote Host List.	The Profile XP system has a problem with the Ethernet connection.	Refer to “Common Ethernet network problems” on page 239.

Common Ethernet network problems

This troubleshooting aid provides corrective action for some common Ethernet network problems. Search the table for the problem you are experiencing, then try the corrective action. Some problems have more than one corrective action.

Problem	Possible Cause(s)	Corrective Action
Windows NT reports there is an IP address conflict.	Two or more Profile XP systems have the same Ethernet IP address.	Refer to the procedure "Set machine name and IP address on each Profile XP system" on page 204
Only the local Profile XP system is listed in Network Neighborhood.	Missing network connection.	Check that the port link indicator is lit on the hub or switch the Profile XP Ethernet cable is connected to. If not, make sure the network cable is properly connected, then refer to the <i>Profile XP Service Manual</i> for further corrective action.
No Profile XP systems are listed in the network neighborhood. Not even the local Profile XP system.	Some component of Windows NT Networking improperly installed.	Refer to the <i>Profile XP Service Manual</i> for help in solving the problem.
Profile XP systems do not immediately appear in Network Neighborhood, but are eventually displayed.	This is the normal operation of Network Neighborhood. The same applies when systems are switched off. It may be several minutes before refreshing the display removes the system from the list.	NA



Common Fibre Channel video network problems

This troubleshooting aid provides corrective action for some common Fibre Channel video network problems. Search the table for the problem you are experiencing, then try the corrective action. Some problems have more than one corrective action.

Problem	Possible Cause(s)	Corrective Action
Can't transfer files in Media Manager.	There may be an incorrect Fibre Channel name entry in the HOSTS file on the Profile XP system.	Verify all Ethernet and Fibre Channel entries in the HOSTS all systems. Make sure Fibre Channel names use _fc0, that is, zero and not the letter O. Refer to "Manually Edit the hosts file on each Profile XP" on page 210.
Can't transfer files in Media Manager.	No Fibre Channel connectivity.	Refer to "Testing the Fibre Channel Video network" on page 241.
In Media Manager, files transfer only one direction.	There may be an incorrect entry in the HOSTS file on the Profile XP systems.	Verify all Ethernet and Fibre Channel entries in the HOSTS file on both systems, refer to "Manually Edit the hosts file on each Profile XP" on page 210.
Media Manager can't find a Profile XP when you try to add it to the network hosts list.	PortServer is not running on the remote Profile XP system.	Start PortServer on the remote system, refer to "Running PortServer to enable remote operation" on page 195.
Media Manager can't find the Profile XP when you try to add it to the network hosts list.	Unable to resolve Ethernet name. There may be an incorrect Ethernet name entry in the HOSTS file.	Verify all Ethernet and Fibre Channel entries in the HOSTS file on both systems, refer to "Manually Edit the hosts file on each Profile XP" on page 210
Media Manager can't find a Profile XP when you try to add it to the network hosts list.	No Ethernet connectivity.	Refer to "Testing the Fibre Channel Video network" on page 241.

Testing the Fibre Channel Video network

Use this procedure to test your video network setup. Tests are included for the Ethernet and Fibre Channel networks.

Testing the Ethernet name resolution and connectivity

The Fibre Channel video network relies on Ethernet connectivity and name resolution. This procedure uses the *ping* command which requests a response from the named *Profile XP* system. If the remote system does not respond, you'll try *ping* using the IP address of the remote system. If the system responds, you have a name resolution problem. If there is no response, refer to the *Profile XP Service Manual* for help with solving problems with the Ethernet adapter or cabling.

To test the Ethernet network:

1. Open the Windows NT command prompt by selecting **Start | Programs | Command Prompt**.
2. Type *ping*, then the Ethernet name of one of the Profile XP systems on the network, then press **Enter**. For Example:

ping Profile1

If this command returns:

Pinging Profile1 with 32 bytes of data:

Reply from 192.168.99.100: bytes=32 time<10ms TTL=128

Reply from 192.168.99.100: bytes=32 time<10ms TTL=128

Reply from 192.168.99.100: bytes=32 time<10ms TTL=128

Reply from 192.168.99.100: bytes=32 time<10ms TTL=128

You have successfully resolved the name **Profile1** and you have Ethernet network connectivity.

If, however, the *ping* command returns:

Pinging Profile1 with 32 bytes of data:

Request timed out.

Request timed out.

Request timed out.

Request timed out.

There is a connectivity problem or the Ethernet IP address could not resolve properly. Continue with step 3.



3. Type *ping*, then, this time, use the IP address of one of the Profile XP systems on the network, then press **Enter**. For Example:

ping 192.168.99.100

If this command returns:

Pinging 192.168.99.100 with 32 bytes of data:

Reply from 192.168.99.100: bytes=32 time<10ms TTL=128

Reply from 192.168.99.100: bytes=32 time<10ms TTL=128

Reply from 192.168.99.100: bytes=32 time<10ms TTL=128

Reply from 192.168.99.100: bytes=32 time<10ms TTL=128

You have connectivity to the network, so there must be a name resolution problem for the IP address. You need to re-check your *HOSTS* file for accuracy. Refer to “Manually Edit the hosts file on each Profile XP” on page 210.

NOTE: You may want to re-boot to ensure that any changes have taken effect.

If, however, the *ping* command returns:

Pinging 192.168.99.100 with 32 bytes of data:

Request timed out.

Request timed out.

Request timed out.

Request timed out.

One or both of the Profile XP systems appears to have a network connectivity problem. Re-check the cabling and try again. If this does not solve the problem, refer to the *Profile XP Service Manual* for more help with solving Ethernet network problems.

4. Repeat step 2 on all Profile XP systems on the network, then proceed with “Testing Fibre Channel name resolution and connectivity” on page 243.

Testing Fibre Channel name resolution and connectivity

Use this procedure to test for Fibre Channel network connectivity and proper name resolution. This procedure uses the **Test** button in the Configuration Manager Network dialog box.

To verify name resolution and Fibre Channel connectivity:

1. Open Configuration Manager, then click **Network**.

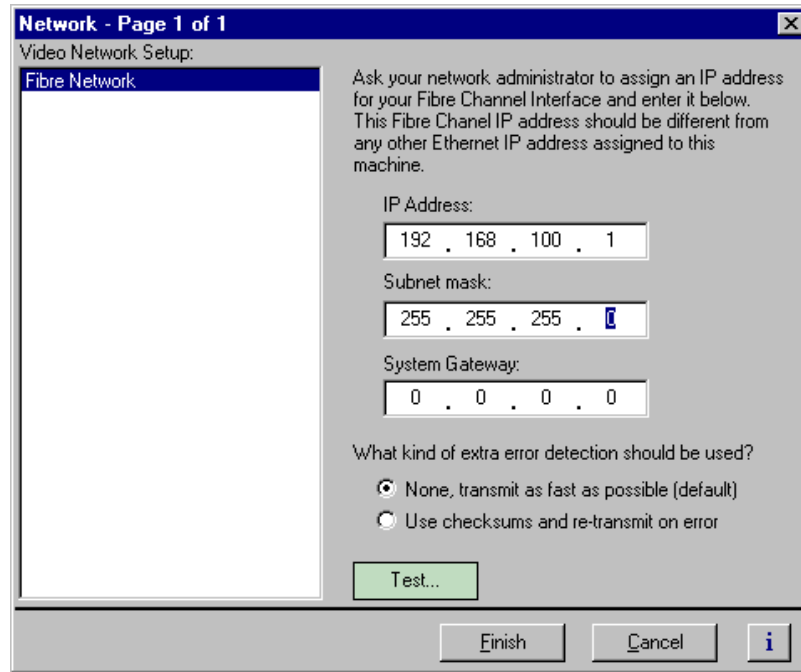

2. Click the **Test**.



3. In the Ping Window, select the **Ping the Interface** option.

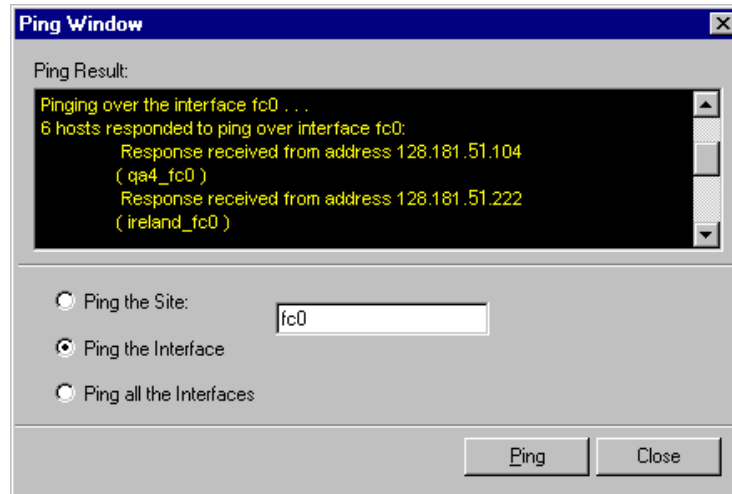

4. Type *fc0* in the text box, then click **Ping**. Make sure to enter a zero not an O. All Profile systems connected to Fibre Channel are asked to respond.

Wait for ping results.

5. Check the Ping Results window, then do one of the following:
 - a. If only the local system responded, there is a problem with the Fibre Channel network connectivity. Verify the Fibre Channel connections for all systems, then review all configuration steps under “Setting up a simple video network: Fibre Channel” on page 208. Repeat step 4. If there is still a problem, refer to the *Profile XP Service Manual*.
 - b. If all systems responded, but a Profile system name is missing or incorrect, there is an error in the HOSTS file. Refer to “Manually Edit the hosts file on each Profile XP” on page 210.

NOTE: You can use the “Ping the Site” option to ping a specific Profile system using its IP address or name, for example *Profile1_fc0*. Pinging by name requires the *HOSTS* file to be correct. Pinging by IP address does not require the *HOSTS* file.

Common Ethernet video network problems

This troubleshooting aid provides corrective action for some common Ethernet video network problems. Search the table for the problem you are experiencing, then try the corrective action. Some problems have more than one corrective action.

Problem	Possible Cause(s)	Corrective Action
Can't transfer files in Media Manager.	There may be an incorrect network name entry in the HOSTS file on the Profile XP system.	Verify all Windows NT Ethernet and video Ethernet entries in the HOSTS all systems. Make sure video Ethernet names use _le, that is, zero and not the letter O. Refer to "Manually Edit the hosts file on each Profile XP" on page 220.
Can't transfer files in Media Manager.	No video Ethernet connectivity.	Refer to "Testing the Ethernet Video network" on page 246.
In Media Manager, files transfer only one direction.	There may be an incorrect entry in the HOSTS file on the Profile XP systems.	Verify all Windows NT Ethernet and video Ethernet entries in the HOSTS file on both systems, refer to "Manually Edit the hosts file on each Profile XP" on page 220.
Media Manager can't find a Profile XP when you try to add it to the network hosts list.	PortServer is not running on the remote Profile XP system.	Start PortServer on the remote system, refer to "Running PortServer to enable remote operation" on page 195.
Media Manager can't find the Profile XP when you try to add it to the network hosts list.	Unable to resolve Windows NT Ethernet name. There may be an incorrect Windows NT Ethernet name entry in the HOSTS file.	Verify all Windows NT Ethernet and video Ethernet entries in the HOSTS file on both systems, refer to "Manually Edit the hosts file on each Profile XP" on page 220
Media Manager can't find a Profile XP when you try to add it to the network hosts list.	No Windows NT Ethernet connectivity.	Refer to "Testing the Ethernet Video network" on page 246.



Testing the Ethernet Video network

Use this procedure to test your video network setup. Tests are included for the Windows NT Ethernet and video Ethernet networks.

Testing the Windows NT Ethernet name resolution and connectivity

The video Ethernet video network relies on Windows NT Ethernet connectivity and name resolution. This procedure uses the *ping* command which requests a response from the named *Profile XP* system. If the remote system does not respond, you'll try *ping* using the IP address of the remote system. If the system responds, you have a name resolution problem. If there is no response, refer to the *Profile XP Service Manual* for help with solving problems with the Windows NT Ethernet adapter or cabling.

To test the Windows NT Ethernet network:

1. Open the Windows NT command prompt by selecting **Start | Programs | Command Prompt**.
2. Type *ping*, then the Windows NT Ethernet name of one of the Profile XP systems on the network, then press **Enter**. For Example:

ping Profile1

If this command returns:

Pinging Profile1 with 32 bytes of data:

Reply from 192.168.99.100: bytes=32 time<10ms TTL=128

Reply from 192.168.99.100: bytes=32 time<10ms TTL=128

Reply from 192.168.99.100: bytes=32 time<10ms TTL=128

Reply from 192.168.99.100: bytes=32 time<10ms TTL=128

You have successfully resolved the name **Profile1** and you have Windows NT Ethernet network connectivity.

If, however, the *ping* command returns:

Pinging Profile1 with 32 bytes of data:

Request timed out.

Request timed out.

Request timed out.

Request timed out.

There is a connectivity problem or the Windows NT Ethernet IP address could not resolve properly. Continue with step 3.

3. Type *ping*, then, this time, use the IP address of one of the Profile XP systems on the network, then press **Enter**. For Example:

ping 192.168.99.100

If this command returns:

Pinging 192.168.99.100 with 32 bytes of data:

Reply from 192.168.99.100: bytes=32 time<10ms TTL=128

Reply from 192.168.99.100: bytes=32 time<10ms TTL=128

Reply from 192.168.99.100: bytes=32 time<10ms TTL=128

Reply from 192.168.99.100: bytes=32 time<10ms TTL=128

You have connectivity to the network, so there must be a name resolution problem for the IP address. You need to re-check your *HOSTS* file for accuracy. Refer to “Manually Edit the hosts file on each Profile XP” on page 220.

If, however, the *ping* command returns:

Pinging 192.168.99.100 with 32 bytes of data:

Request timed out.

Request timed out.

Request timed out.

Request timed out.

One or both of the Profile XP systems appears to have a network connectivity problem. Re-check the cabling and try again. If this does not solve the problem, refer to the *Profile XP Service Manual* for more help with solving Windows NT Ethernet network problems.

4. Repeat step 2 for all Profile XP systems on the network, then proceed with “Testing video Ethernet name resolution and connectivity” on page 248.



Testing video Ethernet name resolution and connectivity

Use this procedure to test for video Ethernet network connectivity and proper name resolution. This procedure uses the **Test** button in the Configuration Manager Network dialog box.

To verify name resolution and video Ethernet network connectivity:

1. Open Configuration Manager, then click **Network**.

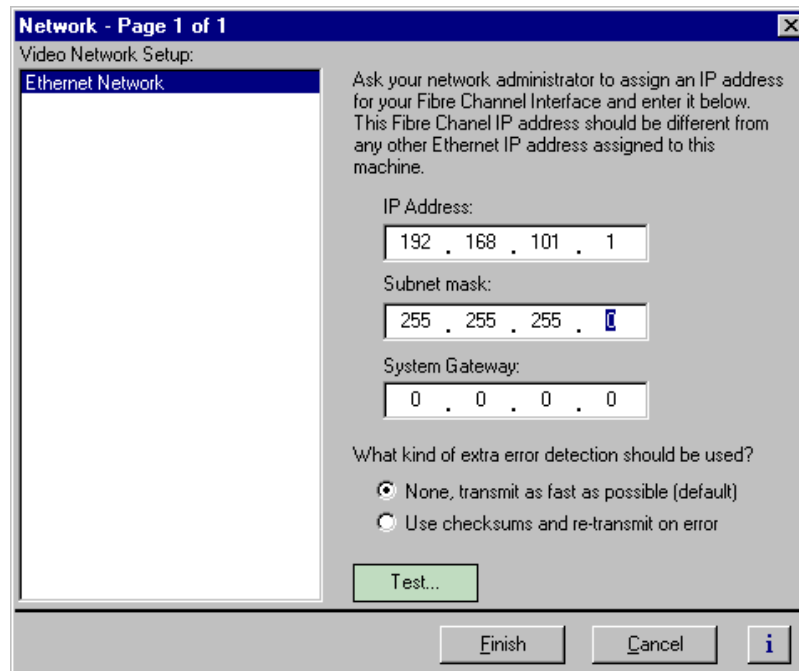

2. Click the **Test**.

3. In the Ping Window, select the **Ping the Interface** option.

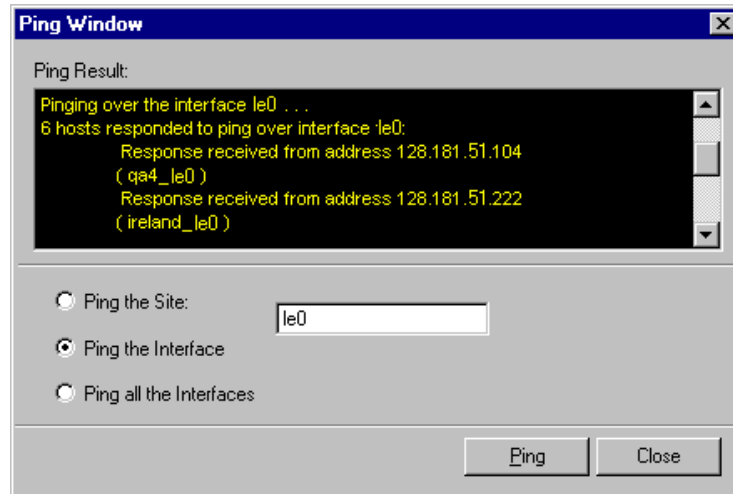

4. Type *le0* in the text box, then click **Ping**. Make sure to enter a zero not an O. All Profile systems are asked to respond.

Wait for ping results.

5. Check the Ping Results window, then do one of the following:
- If only the local system responded, there is a problem with the video Ethernet network connectivity. Verify the video Ethernet connections for all systems, then review all configuration steps under “Setting up a simple video network: Ethernet” on page 218. Repeat step 4. If there is still a problem, refer to the *Profile XP Service Manual*.
 - If all systems responded, but a Profile system name is missing or incorrect, there is an error in the HOSTS file. Refer to “Manually Edit the hosts file on each Profile XP” on page 220.

NOTE: You can use the “Ping the Site” option to ping a specific Profile system using its IP address or name, for example *Profile_le0*. Pinging by name requires the HOSTS file to be correct. Pinging the IP address does not require the HOSTS file.



Electrical and Environmental Specifications

General Information

This appendix provides tables of electrical specifications for the video and audio characteristics, as well as environmental criteria and power characteristics. The tables in this appendix make it easier to present the specifications in numerical values. The following terms apply to the Profile XP Media Platform characteristics and descriptions in the tables.

Specification: A document or a section of a document that lists and describes characteristics and performance requirements of equipment and certain program material.

Requirement (Performance Requirement): A statement that defines a characteristic, usually in limit form.

Supplemental Data: Statements that explain performance requirements or provide performance information. These are not considered to be statements of guaranteed performance and are not ordinarily supported by a performance check procedure.

Test Equipment

Grass Valley Group uses the following test equipment to verify the performance requirements listed in this chapter.

- Tektronix VM700A
- Signal Source (Video and Audio)
- Signal Generator
- Monitor



Electrical Specifications

The Performance Requirements listed in the Electrical Specifications apply over an ambient temperature range of +20.5 C to +30.5 C. The Performance Requirement tolerances listed in the Electrical Specification are doubled over the temperature range of 0 to +40.5 C, unless there is a specific exception.

Serial Digital Interface board (2In/2Out)

Characteristics	Description
Number of Inputs	<i>Supplemental Data:</i> Two component serial digital
Input Type	<i>Supplemental Data:</i> 75Ω terminated
Number of Outputs	<i>Supplemental Data:</i> Two component serial digital
Output Timing Range	<i>Requirement:</i> -21/2 H to +148 H <i>Supplemental Data:</i> Independent for each output <i>Supplemental Data:</i> Resolution; 74 ns
Digital Format	<i>Supplemental Data:</i> CCIR 601 Component 525/625 10 bit data, Scrambled NRZI; complies with SMPTE 259M and CCIR 656
Bit Rate	<i>Supplemental Data:</i> 270 Mb/s
Source Impedance	<i>Supplemental Data:</i> 75Ω
Return Loss	<i>Supplemental Data:</i> ≥15 dB from 5 MHz to 270 MHz
DC Offset	<i>Requirement:</i> 0 ±0.5V
Rise and Fall Times	<i>Requirement:</i> 400 - 1500ps; measured at the 20% and 80% amplitude points
Jitter	<i>Requirement:</i> ≤740 ps p-to-p
Input Level	<i>Supplemental Data:</i> 800 mV p-p ±10% <i>Supplemental Data:</i> Input voltages outside this range may cause reduced receiver performance
Serial Receiver Equalization Range	<i>Requirement:</i> Proper operation with up to 17 dB loss at 135 MHz using coaxial cable having $1/\sqrt{f}$ loss characteristics. 800 mV launch amplitude
Output Level	<i>Requirement:</i> 800 mV p-p ±10%

Serial Digital Interface board (4 Out)

Characteristics	Description
Number of Outputs	<i>Supplemental Data:</i> Four component serial digital
Output Timing Range	<i>Requirement:</i> -21/2 H to +148 H <i>Supplemental Data:</i> Independent for each output <i>Supplemental Data:</i> Resolution; 74 ns
Digital Format	<i>Supplemental Data:</i> CCIR 601 Component 525/625 10 bit data, Scrambled NRZI; complies with SMPTE 259M and CCIR 656
Bit Rate	<i>Supplemental Data:</i> 270 Mb/s
Source Impedance	<i>Supplemental Data:</i> 75 Ω
Return Loss	<i>Supplemental Data:</i> ≥ 15 dB from 5 MHz to 270 MHz
DC Offset	<i>Requirement:</i> 0 \pm 0.5V
Rise and Fall Times	<i>Requirement:</i> 400 - 1500ps; 20% to 80% amplitude slew rate
Jitter	<i>Requirement:</i> ≤ 740 ps pk-to-pk
Input Level	<i>Supplemental Data:</i> 800 mV p-p $\pm 10\%$ <i>Supplemental Data:</i> Input voltages outside this range may cause reduced receiver performance
Output Level	<i>Requirement:</i> 800 mV p-p $\pm 10\%$

Video Monitor

Characteristics ^a	Description
Number of Outputs	<i>Supplemental Data:</i> Four composite outputs
Output Timing Range	<i>Supplemental Data:</i> No output timing adjustments
Composite Analog Format	<i>Supplemental Data:</i> NTSC (with or without setup) or PAL
Source Impedance	<i>Supplemental Data:</i> 75 Ω
DC Offset	<i>Supplemental Data:</i> 0 V
Output Level	<i>Supplemental Data:</i> 1 V p-p

^a. The Video Monitor outputs are **not** broadcast quality. These outputs are for monitoring only.



Reference Genlock

Characteristics	Description
Color Field Detection, Based on SCH Phase	<i>Requirement:</i> Correct color framing for signals having an average SCH phase $\pm 40^\circ$; Lockup $\pm 10^\circ$ <i>Supplemental Data:</i> Once locked to color field, it will stay locked over a range of 0° to $\pm 90^\circ$
Burst Frequency Lock Range	<i>Requirement:</i> PAL, ± 10 Hz at subcarrier NTSC, ± 20 Hz at subcarrier
Signal Amplitude Lock Range	<i>Requirement:</i> Stays locked to +6 dB and -3 dB
Reference Genlock Input Return Loss	<i>Requirement:</i> ≥ 40 dB to 5 MHz

LTC Timecode

Characteristics	Description
Input	<i>Supplemental Data:</i> Longitudinal Time Code. AC coupled, differential input
Input Impedance	<i>Supplemental Data:</i> 20 k Ω .
Input Amplitude	<i>Supplemental Data:</i> 0.1 V p-p, differential, minimum
Maximum Input Voltage	<i>Supplemental Data:</i> 2.5 V p-p, differential, maximum

GPI I/O

Characteristics	Description
GPI Input	<i>Supplemental Data:</i> Inputs set to TTL level high. Compatible with 5 volts CMOS/TTL open collector or contact closures.
GPI Output	<i>Supplemental Data:</i> Outputs are open drain drivers. Max. voltage when outputs are open = 30V Max. current when outputs are closed = 200ma.

Analog Audio

Characteristics	Description
Through Gain	<i>Requirement:</i> 1 ±1 dB <i>Supplemental Data:</i> Non-mix mode each of four channels
Frequency Response	<i>Requirement:</i> 20 Hz to 20 kHz, with between +0.5 dB, -2 dB maximum deviation from flatness at 48 kHz sample rate
Input Impedance	<i>Supplemental Data:</i> 600 Ω or 20 kΩ each channel
Input/Output Signal Levels	<i>Supplemental Data:</i> Nominal Line Level: 0 dBu Nominal Peak Line Level: +9 dBu Digital Clipping: +18 dBu (16-bit quantization)
THD+N at 1020 Hz and 60 Hz	<i>Requirement:</i> -70 dBm (0.031%) at +9dBu input

Digital Audio

Characteristics	Description
Bit Rate	<i>Supplemental Data:</i> 270 Mb/S
Return Loss	<i>Supplemental Data:</i> 15 dB from 5 MHz to 270 MHz
Input Impedance	<i>Supplemental Data:</i> 75 Ω
Output Amplitude	<i>Requirement:</i> 800 mV p-p, ±80 mV.
Output DC Level	<i>Requirement:</i> 0 V, ±0.5 V
Output Rise and Fall Time	<i>Requirement:</i> 400 pS to 1000 pS between 20% and 80%
Jitter	<i>Requirement:</i> ≤ either 0.2ui or 720 pS p-p



Profile XP System Power Specifications

Profile XP system power specifications are shown in the following table.

Characteristics	Safety Rating	Supplemental Data
Mains Voltage Steady State Amplitude	100-240V _{RMS}	87-264 V _{RMS}
Mains Frequency Range	60-50Hz	47-63Hz
Mains Steady State Current ^a	7A max @ 100 V _{RMS} 3A max @ 240 V _{RMS}	5A max @ 120 V _{RMS}
Mains Inrush Current ^a		70A @ 240 V _{RMS} , max 35A @ 120 V _{RMS} , max
Supply Type		Single Phase
Supply Connection		Detachable cord set (IEC320 filtered inlet connector)
Efficiency		>70%
Power Output Rating		430 W maximum
Thermal Output		21000BTU/h max (assuming max configuration)

^a. Per power supply.

PAC 216 Power Requirements

The following table lists the power requirements for the PAC216 audio chassis.

Characteristic	Specification
Voltages/current from power supply	+5V, 1.9 A maximum
Typical Total Power	9.0 Watts typical
Maximum Heat Dissipation	32.42 BTU/hour (9.5 watts)

Environmental Criteria

The following table lists the environmental criteria for the Profile XP Media Platform, PFC500, and the PAC216.

Characteristics	Description
Operating Temperature	<i>Requirement:</i> 10° to 40°C
Storage Temperature	<i>Requirement:</i> -40° to 65°C
Operating Altitude	<i>Requirement:</i> To 10,000 feet <i>Supplemental Data:</i> IEC 950 compliant to 2000 meters
Storage Altitude	<i>Requirement:</i> To 40,000 feet
Mechanical Shock	<i>Supplemental Data:</i> Class 5 (30G) Tektronix 062-2858-00 RevB
Random Vibration	<i>Requirement:</i> Operational: Class 6 Tektronix 062-2858-00 RevB <i>Requirement:</i> Non-Operational: Class 5 Tektronix 062-2858-00 RevB
Transportation	<i>Requirement:</i> Tektronix 062-9527-00
Equipment Type	<i>Supplemental Data:</i> Information Technology
Equipment Class	<i>Supplemental Data:</i> Class 1
Installation Category	<i>Requirement:</i> Category II Local level mains, appliances, portable equipment, etc.
Pollution Degree	<i>Requirement:</i> Level 2 operating environment, indoor use only.
Relative Humidity	<i>Requirement:</i> Operating 80% from +30° to +40°C Non-Operating 90% from +30° to +60°C Do not operate with visible moisture on the circuit boards



Appendix **B**

Connector Pin-outs

This appendix contains the pin-outs for the connectors used in the Profile XP and I/O Panel.

S-VGA connector

The Profile XP Media Platform S-VGA monitor connector is a high density 15-pin female connector.

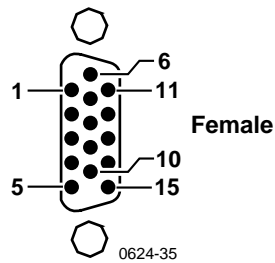

Pin #	Signal	Pin #	Signal	Pin #	Signal
1	Analog Red Output	6	Ground	11	not used
2	Analog Green Output	7	Ground	12	not used
3	Analog Blue Output	8	Ground	13	Horizontal Sync
4	not used	9	Fused Vcc	14	Vertical Sync
5	Ground	10	Ground	15	not used



RJ-45 Ethernet connector

The Profile XP has a Ethernet connector for Windows NT networking and another Ethernet connector on the optional Ethernet board for video networking. Both are 8-pin RJ-45 snap-in telephone-type connectors. Use Category 5 unshielded twisted pair cable. The pin-outs for both connectors are the same.

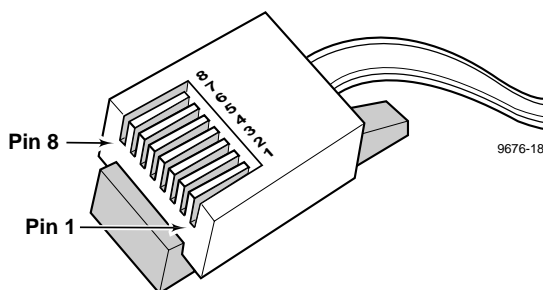

Pin #	Signal	Pin #	Signal
1	Transmit +	5	not used
2	Transmit -	6	Receive -
3	Receive +	7	not used
4	not used	8	not used

Parallel Port connector

The parallel port uses a 25-pin female connector located on the rear panel of the Profile XP Media Platform.

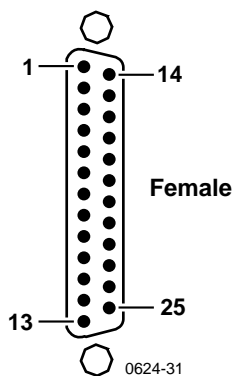

Pin	Signal	Pin	Signal
1	Strobe/	14	Auto Feed
2	Data bit (0)	15	Fault
3	Data bit (1)	16	Init
4	Data bit (2)	17	SLCT IN
5	Data bit (3)	18	Ground
6	Data bit (4)	19	Ground
7	Data bit (5)	20	Ground
8	Data bit (6)	21	Ground
9	Data bit (7)	22	Ground
10	ACK	23	Ground
11	Busy	24	Ground
12	Paper Error	25	Ground
13	Select		



RS-232 connectors

The Profile XP Media Platform has one 9-pin male RS-232 interface connector on the rear panel.

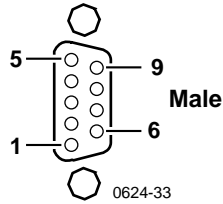

Pin #	Signal	Description
1	DCD	Received line Signal Detector
2	RXD	Received Data
3	TXD	Transmitted Data
4	DTR	Data Terminal Ready
5	GND	Ground
6	DSR	Data Set Ready
7	RTS	Request To Send
8	CTS	Clear To Send
9	CE	Ring Detect

I/O Panel RS-422 connectors

The Profile XP I/O Panel has eight 9-pin female connectors for RS-422 connections.

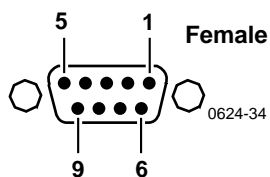

Pin #	Signal	Description
1	GND	Signal Ground
2	-TXD	Differential Transmit Data (low)
3	+RXD	Differential Receive Data (high)
4	GND	Signal Ground
5	NC	
6	GND	Signal Ground
7	+TXD	Differential Transmit Data (high)
8	-RXD	Differential Receive Data (low)
9	GND	Signal Ground



I/O Panel GPI connectors

The Profile XP Media Platform has two 25 pin female connectors mounted on the I/O Panel for General Purpose Interface (GPI) input and output connections.

GPI Input connector (on I/O Panel)

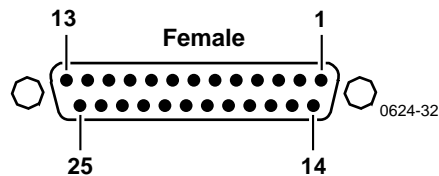

Pin	Signal	Pin	Signal
1	Signal Ground	14	GPI-In5
2	Signal Ground	15	Signal Ground
3	GPI-In1	16	Signal Ground
4	Signal Ground	17	GPI-In6
5	Signal Ground	18	Signal Ground
6	GPI-In2	19	Signal Ground
7	Signal Ground	20	GPI-In7
8	Signal Ground	21	Signal Ground
9	GPI-In3	22	Signal Ground
10	Signal Ground	23	GPI-In8
11	Signal Ground	24	Signal Ground
12	GPI-In4	25	Signal Ground
13	Signal Ground		

GPI output connector (on I/O Panel)

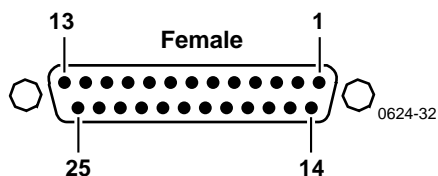

Pin	Signal	Pin	Signal
1	Signal Ground	14	GPI-In5
2	Signal Ground	15	Signal Ground
3	GPI-Out1	16	Signal Ground
4	Signal Ground	17	GPI-Out6
5	Signal Ground	18	Signal Ground
6	GPI-Out2	19	Signal Ground
7	Signal Ground	20	GPI-Out7
8	Signal Ground	21	Signal Ground
9	GPI-Out3	22	Signal Ground
10	Signal Ground	23	GPI-Out8
11	Signal Ground	24	Signal Ground
12	GPI-Out4	25	Signal Ground
13	Signal Ground		



I/O Panel LTC connectors

The I/O Panel provides four female XLR connectors for LTC In and four male XLR connectors for LTC Out.

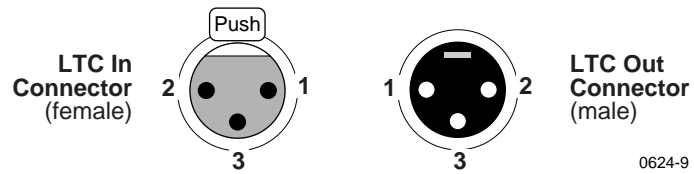

Pin #	LTC In	Pin #	LTC Out
1	Signal Ground	1	Signal Ground
2	(+)	2	(+)
3	(-)	3	(-)

Fibre Channel Disk board connectors

The Fibre Channel Disk board has two connectors labeled Port A and Port B. Both connectors have the same pin-out. The interconnect cable has a Amphenol Metagig connector on one end and DB-9 on the other. Pinouts for both ends of the cable are shown here along with the Fibre Channel cable specifications.

Metagig Connector Pinouts

Pin #	Mnemonic	Description
1	TXP H	Differential Transmit Data (high)
2	GND	Signal Ground
3	TXN L	Differential Transmit Data (low)
4	NC	
5	GND	Signal Ground
6	RXN L	Differential Receive Data (low)
7	Vcc	+5VDC
8	RXP H	Differential Receive Data (high)
9	GND	Signal Ground
10	GND	Signal Ground

DB-9 Connector Pinouts

Pin #	Mnemonic	Description
1	TXP H	Differential Transmit Data (high)
2	Vcc	+5VDC
3	GND	Signal Ground
4	key	
5	RXP H	Differential Receive Data (high)
6	TXN L	Differential Transmit Data (low)
7	GND	Signal Ground
8	GND	Signal Ground
9	RXN L	Differential Receive Data (low)

Fibre Channel Cable Specifications

The Fibre Channel cable specifications are as follows:

Cable type: Shielded, 75 ohm twin axial

Maximum length: 30 meters (98 feet) between PFC500 and Profile XP system;
 < or = 10m (33 feet) unequalized; >10 m (33 feet) equalized
 0.3 m (1 foot) min., 10m (33 feet) max. between PFC500 and PFC500E

Connector type: DB-9 on one end and Berg Metagig on the other.



Fibre Channel Network board connector

The Fibre Channel Network board has one fiber optic connector for connecting to Profile video networks. Connector and cable specifications are shown here.

Connector type: SC Duplex

Cable type: duplex zip cord, plenum grade

Fiber	Typical Length (meters)
50/125	300
62.5/125	500

Audio board connector

The Audio Board accepts 16 channels of digital audio input and provides 16 channels of digital audio output via a 80-pin connector on the rear panel. The cable to this connector is from the Profile Audio Chassis (PAC) or from the XLR/BNC 216 Digital Audio Breakout Box.

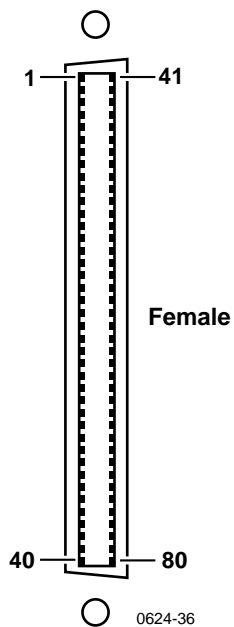



Appendix B Connector Pin-outs

Pin	Signal Description	Pin	Signal Description	Pin	Signal Description
1	Ch 1-2 AES Out (P)	28	nc	55	Ch 15-16 AES Out (P)
2	Ch 1-2 AES Out (N)	29	Ch 13-14 AES In (P)	56	Ch 15-16 AES Out (N)
3	Chassis Ground	30	Ch 13-14 AES In(N)	57	Ch 1-4 ADC Clock Out (P)
4	Chassis Ground	31	AES Reference In (P)	58	Ch 1-4 ADC Clock Out (N)
5	Ch 5-6 AES Out (P)	32	AES Reference In (N)	59	Ch 3-4 AES In (P)
6	Ch 5-6 AES Out (N)	33	AES Monitor Out (P)	60	Ch 3-4 AES In (N)
7	nc	34	AES Monitor Out (N)	61	Ch 5-8 ADC Clock Out (P)
8	nc	35	nc	62	Ch 5-8 ADC Clock Out (N)
9	Ch 9-10 AES Out (P)	36	nc	63	Ch 7-8 AES In (P)
10	Ch 9-10 AES Out (N)	37	UART Receive (P)	64	Ch 7-8 AES In (N)
11	nc	38	UART Receive (N)	65	Ch 9-12 ADC Clock Out (P)
12	nc	39	PAC Ready (P)	66	Ch 9-12 ADC Clock Out (N)
13	Ch 13-14 AES Out (P)	40	PAC Ready (N)	67	Ch 11-12 AES In (P)
14	Ch 13-14 AES Out (N)	41	nc	68	Ch 11-12 AES In (N)
15	nc	42	nc	69	Ch 13-16 ADC Clock Out (P)
16	nc	43	Ch 3-4 AES Out (P)	70	Ch 13-16 ADC Clock Out (N)
17	Ch 1-2 AES In (P)	44	Ch 3-4 AES Out (N)	71	Ch 15-16 AES In (P)
18	Ch 1-2 AES In (N)	45	nc	72	Ch 15-16 AES In (N)
19	nc	46	nc	73	Digital Ground
20	nc	47	Ch 7-8 AES Out (P)	74	Breakout Box Present Flag
21	Ch 5-6 AES In (P)	48	Ch 7-8 AES Out N)	75	UART Transmit (P)
22	Ch 5-6 AES In (N)	49	nc	76	UART Transmit (N)
23	nc	50	nc	77	Chassis Ground
24	nc	51	Ch 11-12 AES Out (P)	78	Chassis Ground
25	Ch 9-10 AES In (P)	52	Ch 11-12 AES Out (N)	79	PAC Reset (P)
26	Ch 9-10 AES In (N)	53	nc	80	PAC Reset (N)
27	nc	54	nc		

nc = no connection

Rack Mounting Information and Rear Panel Drawings

Rack mounting the Profile XP

The equipment for the Profile XP system installs in a standard 19-inch equipment rack. Rack slide tracks shipped with the Profile XP system and peripheral products allow them to slide in and out without having to remove them from the rack. If the rack does not already have rack slides installed, or if the slides are not correctly positioned, you will have to use those shipped with the Profile XP.

When planning the placement of equipment in your equipment rack, bear in mind the following:

- The Profile XP requires six inches (15.25 cm) of clearance behind the rear panel for to allow room for connectors and cable bends.
- Insure adequate air flow around the chassis to provide sufficient cooling. (Operating ambient temperature will affect the amount of air circulation required to keep the Profile XP within its temperature limitations.)
- Insure the rack is anchored to the floor so that it cannot tip over when the Profile XP is extended out of the rack.



Chassis dimensions for Profile XP and peripheral equipment

Use the following chassis dimension information when planning the placement of equipment in your equipment rack.

Item	Chassis Dimensions
Profile XP	Height: 10.45 in (26.54 cm) Width: 19 in (48.26 cm) Depth: 23.80 in (60.45 cm) from front rack ears to the rear panel 27.00 in (60.58 cm) from front of bezel to rear panel
PFC500 and PFC500E	Height: 6.07 in (5.41 cm) Width: 17.5 in (44.5 cm) Depth: 24.91 in (63.27 cm) front door to back of drive fan pack 23.79 in (60.43cm) chassis front to back of drive fan pack 22.54 in (57.25 cm) rail front to back of drive fan pack
PAC216	Height: 3.50 inches (8.89 centimeters) Width: 19.00 inches (48.26 centimeters) Depth: 19.00 inches (48.26 centimeters)
PACXLR Panel ^a	Height: 3.50 inches (8.89 centimeters) Width: 19.00 inches (48.26 centimeters) Depth: 3.25 inches (8.26 centimeters)
XLR216 Panel ^a	Height: 3.50 inches (8.89 centimeters) Width: 19.00 inches (48.26 centimeters) Depth: 3.25 inches (8.26 centimeters)
BNC216 Panel ^a	Height: 1.75 inches (4.45 centimeters) Width: 19.00 inches (48.26 centimeters) Depth: 3.25 inches (8.26 centimeters)
I/O Panel ^a	Height: 1.75 inches (4.45 centimeters) Width: 19.00 inches (48.26 centimeters) Depth: 2.00 inches (5.08 centimeters)

^a. These chassis are mounted in the rear of the rack.

Rack mount hardware shipped with the Profile XP system

Your Profile XP comes with rack mounting hardware as shown. The Profile XP and PAC216 are shipped with the chassis sections already attached.

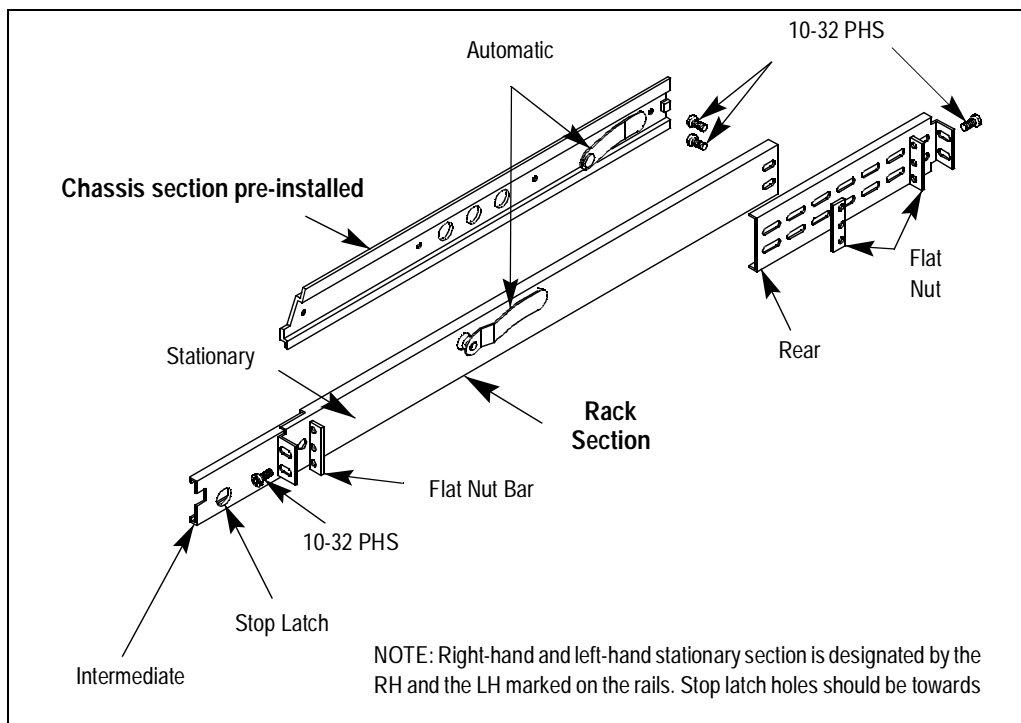

Rack mount hardware for the PFC500 Fibre Channel RAID system

For PFC500/E rack mounting information, refer to the *PFC500 Instruction Manual*.



Mounting the Rack Slides

Choose the proper set of rail mounting holes on the rack. Notice that the hole spacing can vary with the rack type. When mounting the slides in racks with EIA spacing, make sure that the slides are attached to the 0.5-inch spaced holes.

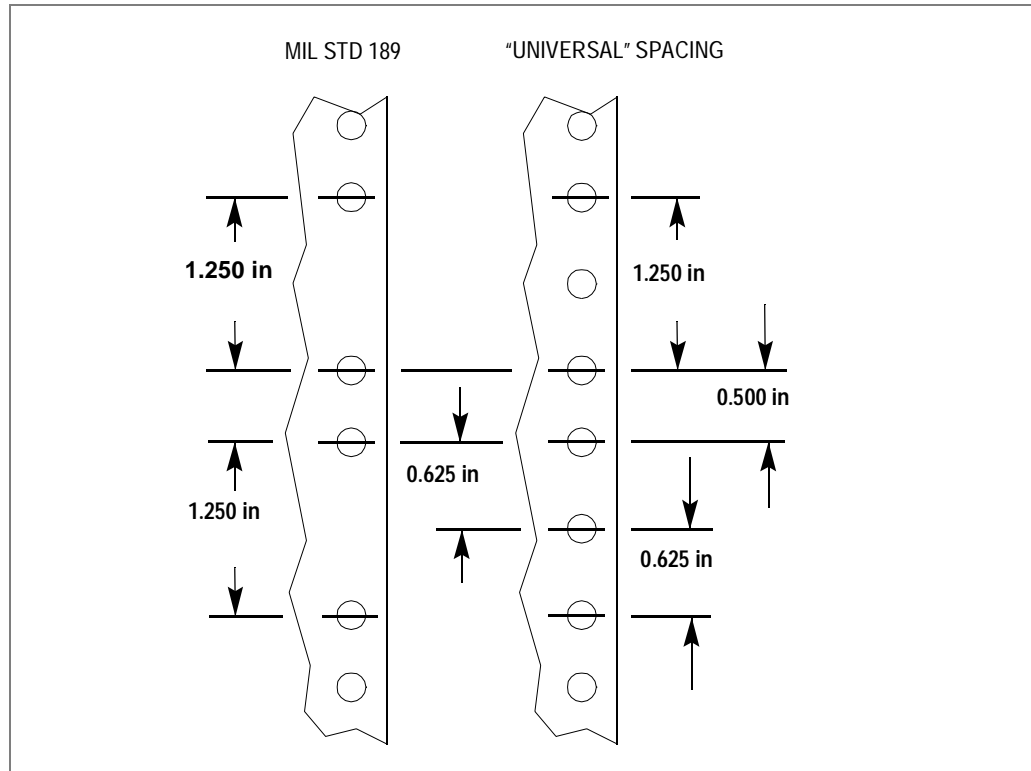

Front and rear rack rail mounting hardware is provided with the rack mount kit. Mount the rails using the enclosed hardware. Make sure the stationary sections are horizontally aligned and are level, as well as parallel to each other.

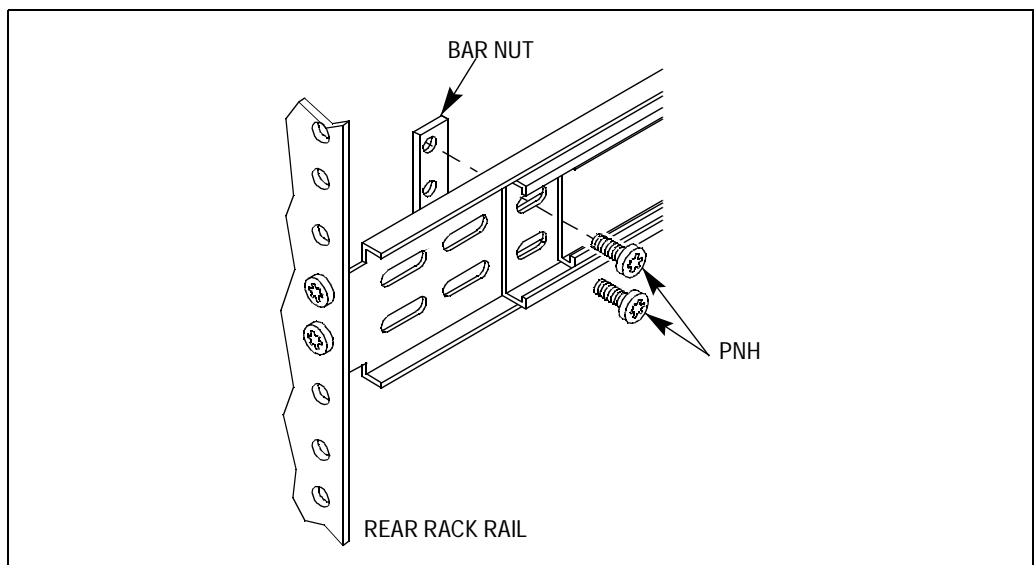
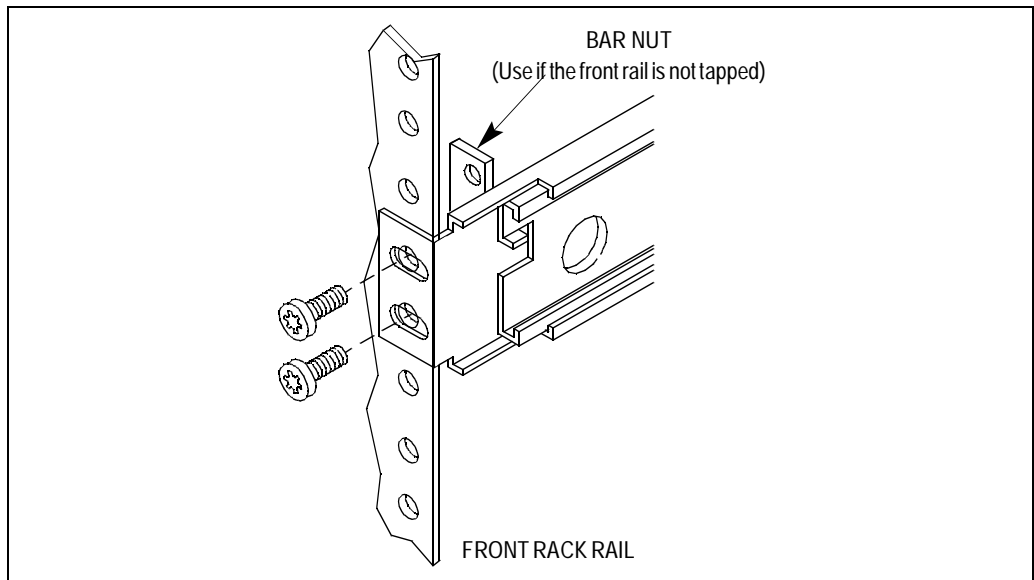



Installing the Profile XP on the rack mount rails

To install the Profile XP on the rack mount rails:

1. Pull the slide-out track section to the fully extended position.



WARNING: To prevent injury, two people are required to lift the Profile XP. It is too heavy for one person to install in the rack.



WARNING: To prevent serious injury, insure that the rack is anchored to the floor so that it cannot tip over when the Profile XP is extended out of the rack.

2. Insert the ends of the chassis sections into the slide-out sections.
3. Push the chassis toward the rack until the chassis sections lock into the intermediate sections.
4. Press the stop latches in the intermediate sections and push the chassis toward the rack until the latches snap into their holes.

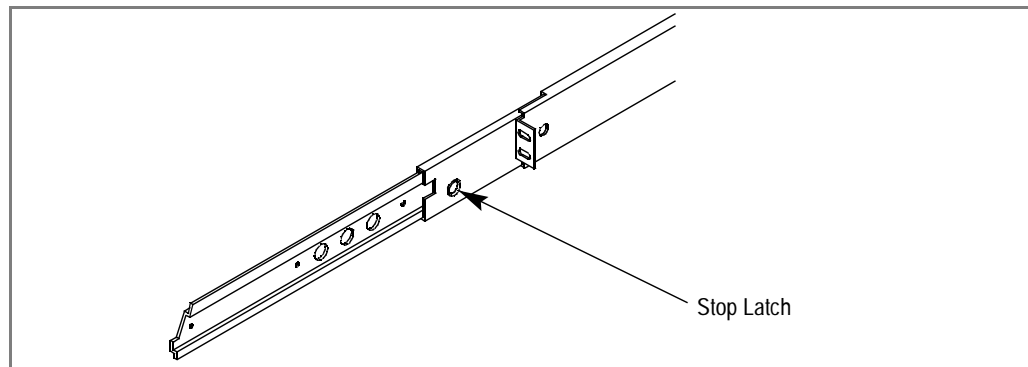

5. Again, press the stop latches and push the cabinet fully into the rack.
6. Insert and tighten the front panel retaining screws.

Making Rack Slide Adjustments

After installation, binding may occur if the slide tracks are not properly adjusted. To adjust the tracks:

1. Slide the chassis out approximately 10 inches.
2. Slightly loosen the mounting screws holding the tracks to the front of the rails and allow the tracks to seek an unbound position.
3. Tighten the mounting screws and check the tracks for smooth operation by sliding the chassis in and out of the rack several times.
4. Tighten the front panel retaining screws once the cabinet is in place within the rack to complete the installation.

Mounting Panels and Audio Chassis

Refer to the information that follows when mounting panels and the Profile XP audio chassis:

- The I/O Panel is 1 RU high with the mounting holes spaced 1.250 inches (3.175 cm) apart.
- The XLR216 is 2 RUs high with holes spaced 3.000 inches (7.62 cm) apart.
- The BNC216 is 1 RU high with the mounting holes spaced 1.250 inches (3.175 cm) apart.
- The PAC216 audio chassis is 2 RU high with holes spaced 3.00 inches (7.62 cm) apart.

The I/O Panel, XLR216 and BNC216 panels mount at the back of the rack with four pan head screws. Ensure that there is room to make cable connections and mount in any order which allows connection to the Profile XP system.



Rear Panel Drawings

Profile XP Media Platform Chassis

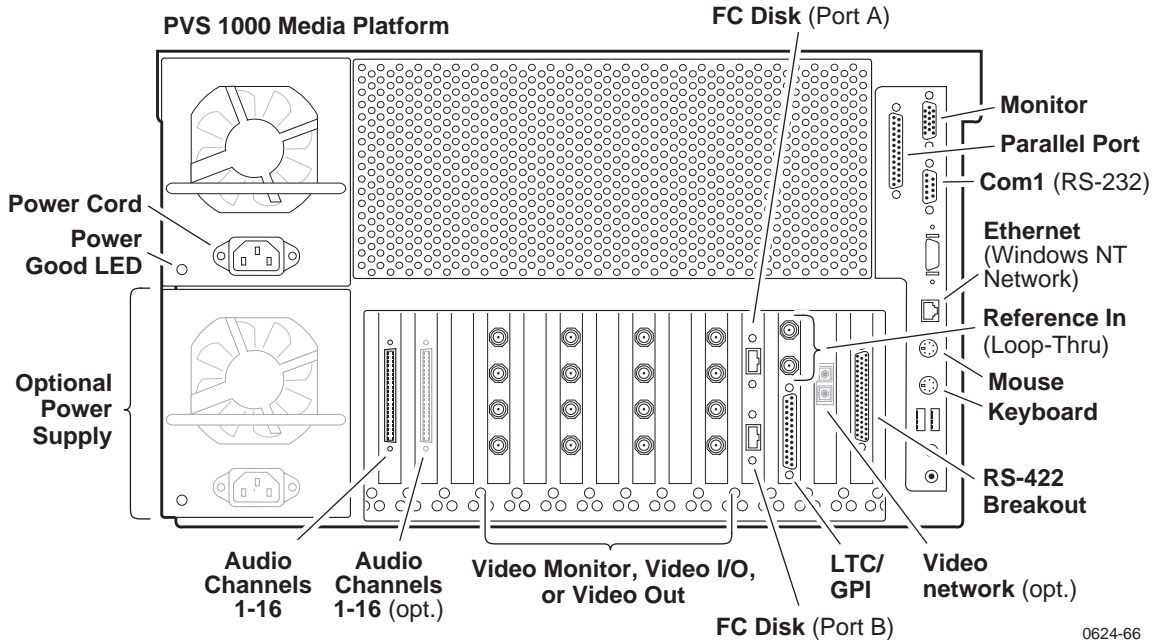

XLR216 and BNC216 AES/EBU Breakout Panels

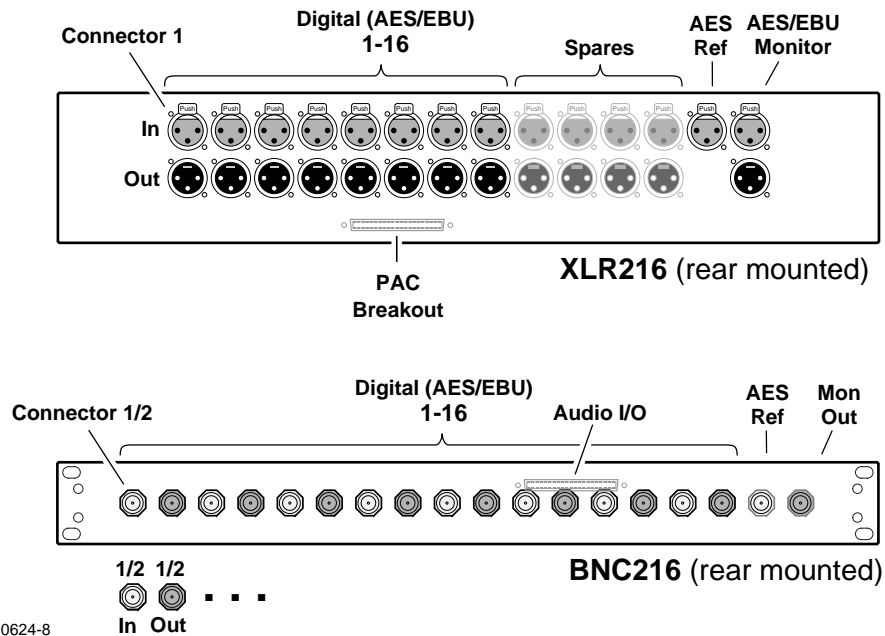

PAC216 Profile Audio Chassis

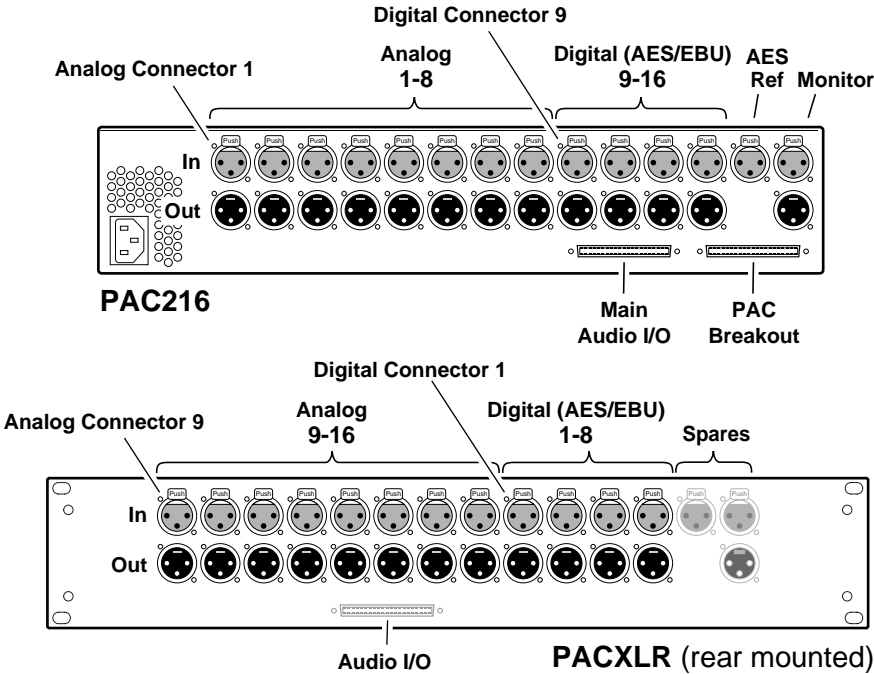

0624-7

I/O Panel

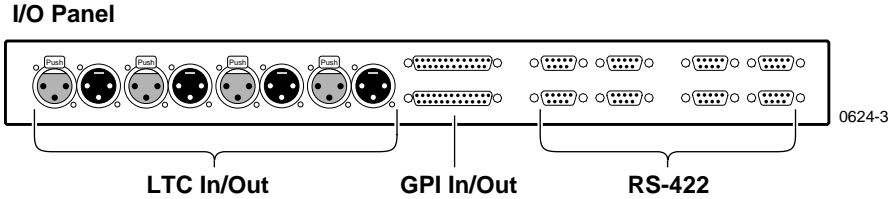

0624-3



PFC500 Fibre Channel RAID Chassis

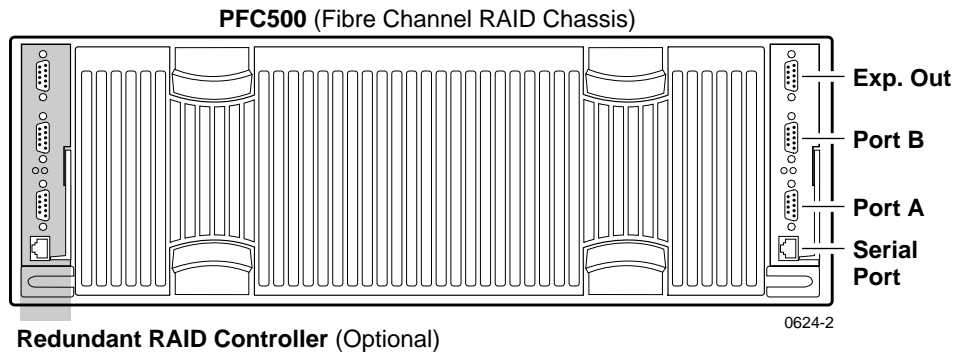

PFC500E Expansion Chassis

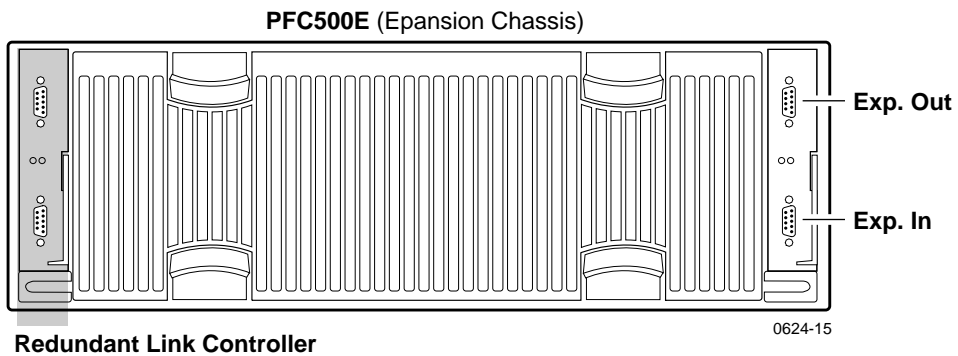

Index

A

- AC-3 161
- accessories 24
- adding channels 94
- AES/EBU audio I/O
 - input status, checking 159
 - selecting 155
- AES/EBU Breakout Panels
 - BNC216 150
 - XLR216 150
- analog audio
 - input level adjustment 164
 - output level adjustment 165
 - output line mode, selecting 167
 - output muting 166
- analog audio, selecting 155
- Applications Subsystem 28, 31
- asynchronous feeds in E to E 114
- asynchronous feeds, timing options 114
- audio
 - 16 bit 161
 - 24 bit 161
 - about 149
 - analog audio line mode, selecting 167
 - analog input level, adjusting 164
 - analog output level, adjusting 165
 - clock reference
 - about 160
 - selecting 160
 - coding format
 - about 161
 - selecting 161
 - common setup problems 232
 - delay, adjusting
 - using custom settings 163
 - using presets 162
 - I/O formats available 150
 - I/O formats, selecting 155
 - interface chassis 150
 - muting, analog output 166

- number of channels 149
- output format, selecting 157
- reference level, selecting 168
- shuttle mode, how audio sounds 169
- tracks

- adding or removing 151

Audio board

- description 32

Audio board connector 269

audio channels

- selecting 103

audio hardware settings

- setting the audio window size 169
- shuttle mode 169

audio I/O

- see* audio

audio tracks

- audio channels, selecting 151, 154

audio vs. video delay 114

audio window size, setting 169

audio, Overload clipping 164

automatic logon 35, 36

B

bind 69

block diagram, board level 30

BNC216 AES/EBU Breakout Panel 150

- rear panel drawing 278

browse video

- enabling 100

- selecting quality 121

C

Canadian Certified AC Adapter 17

Canadian Certified Power Cords 17

Canadian EMC Notice of Compliance 17

certification 18

Channel Configuration

- Warning symbol 92

Channel Configuration dialog box

- (in use), resources shown 90

- dimmed text 90

- red text 90



channels

- about channels 87
 - adding 94
 - audio channel pairs, selecting 103
 - audio tracks, adding or removing 151
 - default settings 25
 - default settings for channels you add 89
 - description text box 94
 - importing and exporting settings 51
 - maximum number of 89
 - multiple video tracks, adding 146
 - removing 105
 - renaming 94
 - restoring channel settings 48, 49
 - restoring defaults 50
 - saving channel settings 48
 - selecting video I/Os 117
 - summary dialog box 93
 - timecode I/O
 - internal generators, selecting 172
 - LTC selecting 187
 - VITC input, selecting 177
 - VITC output, selecting 182
 - type, selecting 96
 - video quality, selecting 98
 - VITC generator setup 184
 - VITC input, selecting 177
 - working with 89
- chassis address
- about 64
- chassis dimensions
- peripheral equipment 272
 - Profile XP 272
- chrominance sampling method 118
- chrominance sampling method, guidelines for
- selecting 119
- clipping, audio 164
- common setup problems
- audio 232
 - channel control problems 238
 - Ethernnet video network 245
 - Fibre Channel network 240
 - playing/recording 230
 - timecode 234
 - using Configuration Manager 237

- video 231
 - Windows NT network 239
- Configuration Manager
- common setup problems 237
 - remote configuration 55
 - tour of 40
- configurations, factory installed 25
- configuring storage, *see* PFC 500
- connecting PFC500 61, 64
- connector pin-outs
- Audio board
 - connector 269
 - Ethernet connector 260
 - Fibre Channel disk connector 267
 - Fibre Channel network connector 268
 - GPI connector pinouts 264
 - LTC connector, I/O Panel 266
 - Parallel Port connector 261
 - RS-232 connector 262
 - RS-422 connector, I/O Panel 263
 - S-VGA connector 259
- creating new channels 94
- crosspoints, video renaming 139, 140

D

- data rate,
- see* video quality
- delay, in E to E 107
- description, channel 94
- dimmed text, resources displayed in 90
- Disk Utility 69
- Dolby D 161
- drop-frame timecode, timecode generator
- setting 176
- Dupli-disk
- controls and indicators 22

E

- E to E delay 107, 113
- E to E timed mode 107, 110
- electrical specifications 252
 - analog audio 255
 - digital audio 255
 - GPI I/O 254
 - LTC I/O 254

- PAC216 power requirements 256
- Profile XP power specifications 256
- Reference Genlock 254
- Serial Digital I/O 252
- Serial Digital Output 253
- Video Monitor 253
- embedded audio I/O
 - input status 127
 - selecting 155
- EN55022 Class A Warning 17
- environmental criteria 257
- Error Detection Handling (EDH),
 - removing 138
- Ethernet
 - hubs and switches 199, 201, 206, 207
- Ethernet connector 260
- Ethernet switch 223
- Ethernet video network
 - cabling, connecting 222
 - common setup problems 245
 - entering network settings 218
 - HOSTS file, editing 220
 - installing 218
 - testing, using Media Manager 223
- expanding storage 70, 83
- exporting
 - channel settings 51
 - hardware settings 51
- F**
- failover, RAID Controller 58
- FCC Emission Control 17
- FCC Emission Limits 18
- Fiber Channel video network
 - common setup problems 240
- Fibre Channel Disk board, description 33
- Fibre Channel disk cable specifications
 - Fibre Channel disk cable 267
- Fibre Channel Loop
 - address ID, about 64
- Fibre Channel network cable
 - specifications 268
- Fibre Channel switch 199, 213
- Fibre Channel video network
 - available bandwidth 60
- cabling, connecting 212
- entering network settings 209
- HOSTS file, editing 210
- installing 208
- IP address, choosing 200
- machine name, choosing 200
- testing with Media Manager 213
- troubleshooting 241
- Fixed Start Time, timecode generator
 - setting 175
- frame sync 113
 - audio delay 114
 - E to E delay 114
- front panel description 20, 21, 22
- G**
- general information, specifications 251
- General Purpose Interface (GPI) 189
- General Safety Summary 15
- GOP 118, 119
- GPI connector pin-outs 264
- GPI trigger 189
- H**
- hardware settings
 - importing and exporting 51
 - restoring 49
 - restoring defaults 50
 - saving 48
- high level block diagram 28
- horizontal blanking, erasing 138
- hot spare drives 75
- I**
- I,B,and P frames 119
- I/O Panel
 - rear panel drawing 279
- identify 85
- importing
 - channel settings 51
 - hardware settings 51
- injury precautions 15
- interlaced mode 126
- internal frame sync 114
- internal timecode generator settings 175
- Introduction 19



IP address
 Ethernet video network 202
 Fibre Channel video network 200
 NT Ethernet network 205

L

Laser Compliance 17
 FCC Emission Limits 18
 Laser Safety 18
 Laser Safety Requirements 17

Laser Safety 18
Laser Safety Requirements 17

line double 126

logging on 35
 automatic logon 35
 logon as Administrator 35
 logon as Profile user 36

Louth protocol 190

LTC
 selecting 187

LTC connector, I/O Panel 266

LUNs, about 69

M

Media Manager 223
 testing Fibre Channel video network 213
 testing the Ethernet Video network 223

models, summary of 25

muting, analog output 166

N

NetCentral XP Enterprise 55

network
 about Profile networking 197
 about transfers 27
 both video network options installed 203
 Ethernet video network
 about 201
 cabling, connecting 222
 entering network settings 218
 HOSTS file, editing 220
 installing 218
 IP address, choosing 202
 machine name 202

Fibre Channel video network
 about 198
 cabling 212
 entering network settings 209
 HOSTS file, editing 210
 installing 208
 IP address, choosing 200
 machine name, choosing 200
 testing with Media Manager 213
 troubleshooting 241

Ping Window
 testing Ethernet video network 249
 testing the Fibre Channel network 244

simple networks, about 203

Windows NT network
 about 197
 cabling 206
 common setup problems 239
 installing 204
 IP address, choosing 204
 machine name 204

O

Odetics protocol
 BVW protocol 190

P

PAC216 Audio Chassis
 about 150
 power requirements 256
 rear panel drawing
 rear panel drawing
 PAC216 Audio Chassis 279

parallel connector, pinouts 261

PFC500 33
 about configuring storage 69
 addressing requirements 64
 chassis address 64
 common setup problems 236
 configuring storage 69
 configuring to include hot spare drives 75
 configuring without hot spares drives 71
 connecting 61, 64
 expanding storage 70, 83
 Fibre Channel Loop address 64

- introduction 57
 - locating disk modules that make up a LUN 85
 - maximum video data rate 60
 - rear panel drawing 280
 - storage capacity 58
 - PFC500E Expansion chassis
 - rear panel drawing 280
 - player channels, about 96
 - player/recorder channels, about 96
 - playing
 - common setup problems 230
 - PortServer 195
 - common setup problems 238
 - power specifications 256
 - product damage precautions 15
 - Profile protocol 193
 - Profile XP
 - logging on Windows NT 35
 - starting the system 34
 - Profile XP rear panel drawing 278
 - Profile XP system overview 28
 - Prolink 193
 - window, described 194
- R**
- rack mounting
 - audio chassis 277
 - chassis dimensions 272
 - I/O Panel 277
 - Profile XP system 271, 276
 - rack slide adjustments 276
 - RAID-3 LUNs 69
 - Real Time Subsystem 31
 - Real Time System 28
 - rear panel drawing
 - I/O Panel 279
 - PFC500 280
 - PFC500E Expansion chassis 280
 - rear panel drawings
 - Profile XP chassis 278
 - XLR216 & BNC216 Breakout panels 278
 - rear panel view 23
 - recorder channels, about 96
 - recording asynchronous feeds 114
 - recording, common setup problems 230
 - red text, resources displayed in 90
 - redundant RAID controller 58
 - redundant system disk 22
 - reference input 180
 - VITC reader 180
 - reference input, system 112
 - reference input, VITC reader setup 180
 - reference level, audio 168
 - remote applications 195
 - remote configuration 55
 - remote control
 - Ethernet 189, 195
 - Prolink, using 189, 193
 - RS-422 protocols 189
 - BVW 190
 - Louth 190
 - Odetics 190
 - Profile protocol 193
 - removing channels 105
 - renaming channels 94
 - renaming video inputs 139
 - renaming video outputs 140
 - resource conflicts 92
 - restoring
 - channels settings 48
 - hardware settings 48
 - system settings 48
 - RS232 connector pinouts 262
 - RS-422
 - BVW protocol 190
 - Louth protocol 190
 - Odetics protocol 190
 - Profile protocol 193
 - remote control protocols 189
 - RS-422 board, description 31
 - RS-422 connector, I/O Panel
 - connector pin-outs 263



S

- safety terms and symbols 16
- saving
 - channel settings 48
 - hardware settings 48
 - system settings 48
- selecting
 - timecode I/O 104
- selecting browse video quality 121
- selecting channel type 96
- setup, on video monitor 142
- shutdown (turning power off) 37
- signal loss
 - video input 132
 - video output 137
- specifications 251
 - electrical 252
 - environmental 257
 - Fibre Channel disk cable 267
- standard accessories 24
- still-play mode 126
- Storage
 - common setup problems 236
 - storage capacity 58
- Summary dialog box 93
- summary dialog boxes
 - about 45
 - show or hide 46
- S-VGA connector 259
- switch, Fibre Channel 199
- switching between video inputs and decoder outputs 107, 113
- System Bandwidth 60
- system reference offset, adjusting 112
- system settings
 - importing and exporting 51
 - restoring 49
 - restoring defaults 48, 50
 - saving 48

T

- test equipment 251
- text overlay, on video monitor 143
- timecode
 - about 171

- common setup problems 234
- internal generators, selecting 172
- timecode generators, settings 175
- timecode burn-in, video monitor 144
- timing,
 - see* video input timing and video output timing

Tool Tips 91

- troubleshooting
 - Ethernet video network 246
 - Fibre Channel video network setup problems 241

U

- unbound LUNs
 - unbind 70
- uncompressed VBI information 124

V

- VBI
 - blanking lines on video input 130
 - erasing lines on video output 135
 - recording lines uncompressed 124
- video data rate, maximum 60
- video file system
 - about 70
- video files system
 - volume name 70
- video input
 - erasing VBI lines 130
 - input signal status 127
 - loss of signal 132
 - modifying hardware settings 128
 - timing
 - autotiming synchronous feeds 113
 - timing asynchronous feeds 114
- VITC
 - reader setup 128
- video monitor 141
 - enabling dither 141
 - NTSC pedestal 142
 - text overlay, enabling 143
 - timecode burn-in 144
 - time-code burn-in, selecting a timecode source 188

- video output
 - crosspoints 117
 - erasing VBI lines 135
 - modifying settings 133
 - removing ancillary data 138
 - signal loss 137
 - timing 107
 - E to E timed mode 110
 - system reference, adjusting 112
 - zero timed mode 108
 - VITC generator setup 133
 - video output timing, adjusting 107, 110
 - video quality 118
 - defining custom presets 123
 - presets, guidelines for selecting 118
 - see also* storage capacity
 - selecting 98, 120, 147
 - VBI uncompressed 124
 - video compression 26
 - video standard, changing 116
 - video tracks, adding 146
 - video, common setup problems 231
 - viewing
 - board location information 47
 - board status 47
 - channel summary dialog box 93
 - hardware settings summary 45
 - hardware version numbers 47
 - VITC
 - common setup problems 234
 - deleting unwanted VITC signals 185
 - generating VITC on a video output 182
 - generator setup 133, 184
 - input status 127
 - reader setup 128, 180
 - recording 177
 - volume name, changing 70, 80
- X**
- XLR216 audio breakout box 150
 - rear panel drawing 278
- Z**
- Zero timed mode 107

