

Profile XP PVS1100

MEDIA PLATFORM FOR STANDARD DEFINITION

Installation Guide

SOFTWARE VERSION 5.4

071-8287-00
FEBRUARY 2004

the most watched worldwide

Copyright

Copyright © 2004 Thomson Broadcast and Media Solutions, Inc. All rights reserved. Printed in the United States of America.

This document may not be copied in whole or in part, or otherwise reproduced except as specifically permitted under U.S. copyright law, without the prior written consent of Thomson Broadcast and Media Solutions, Inc., P.O. Box 59900, Nevada City, California 95959-7900

Trademarks

Grass Valley, Profile, and Profile XP are either registered trademarks or trademarks of Thomson Broadcast and Media Solutions, Inc. in the United States and/or other countries. Other trademarks used in this document are either registered trademarks or trademarks of the manufacturers or vendors of the associated products. Thomson Broadcast and Media Solutions, Inc. products are covered by U.S. and foreign patents, issued and pending. Additional information regarding Thomson Broadcast and Media Solutions, Inc. trademarks and other proprietary rights may be found at www.thomsongrassvalley.com.

Disclaimer

Product options and specifications subject to change without notice. The information in this manual is furnished for informational use only, is subject to change without notice, and should not be construed as a commitment by Thomson Broadcast and Media Solutions, Inc. Thomson Broadcast and Media Solutions, Inc. assumes no responsibility or liability for any errors or inaccuracies that may appear in this publication.

U.S. Government Restricted Rights Legend

Use, duplication, or disclosure by the United States Government is subject to restrictions as set forth in subparagraph (c)(1)(ii) of the Rights in Technical Data and Computer Software clause at DFARS 252.277-7013 or in subparagraph c(1) and (2) of the Commercial Computer Software Restricted Rights clause at FAR 52.227-19, as applicable. Manufacturer is Thomson Broadcast and Media Solutions, Inc., P.O. Box 59900, Nevada City, California 95959-7900 U.S.A.

Revision Status

Rev Date	Description
July 13, 2001	Initial release of the PVS1100 Installation Guide 071-8116-00.
June 17, 2002	Updated to include support for the PFR500/E RAID storage Chassis and new Disk Utility. 071-8116-01.
September 18, 2002	Updated to support Profile XP system software version 5.1. 071-8192-00.
July 21, 2003	Updated to support Profile XP system software version 5.2. 071-8252-00
february 23, 2004	Updated to support Profile XP system software version 5.4, PFR600 and PFR700 RAID storage. 071-8287-00

Before getting started

This installation guide provides step-by-step instructions for installing the PVS1100 Media Platform using factory default settings. After installing the PVS 1100 using this installation guide, you can refer to the *Profile XP System Guide* to customize system settings for your installation.

For Grass Valley Customer Support information, refer to page 47 of this Installation Guide.

About channels and factory default configuration

Profile applications use channels to control disk recording and playback. A channel defines a grouping of Profile XP video, audio, and timecode resources and is identified by a unique name. Profile XP software supports three channel types: Recorder channel, Player channel, or Player/Recorder channel. For more information on channel types and creating or modifying channels, refer the *Profile XP System Guide*.

Your PVS 1100 is shipped with default DVCPRO 25 video processing and DVCPRO 25 Player/Recorder channels. These default channels are named Vtr1, Vtr2, Vtr3 and so on. The following table describes the video and audio connections you'll make for each channel. On the pages that follow, you'll find specifics about the type and number of default channels in your system, and their video and audio I/O connections.

Default channel type	Video I/O connections	Audio connections ^a	Timecode I/O
Player/Recorder	1 SDI video input 1 SDI video output 1 analog monitor ^b	2, 4, or 8 audio I/Os	Uses the internal timecode generator. Recorded timecode is used to generate VITC on the SDI video output

^a. The number of audio I/Os is determined by your PVS 1100 Series model and the number of Audio boards installed.

^b. Available if the optional Video Monitor board is installed.

Rack-mounting the PVS1100 Series Chassis

This procedure assumes you have already rack-mounted the PVS 1100, Fibre Channel RAID Chassis, I/O Panel, and audio interface option as required. For rack-mounting information, see Appendix C, "Rack Mounting Information and Rear Panel Drawings" in the *Profile XP System Guide*.



Referring to Related Documentation

This manual is part of a full set of support documentation for the Profile XP Media Platform. The following illustrates how to use the Profile XP documentation depending on the task you are performing.

Path for the Installer

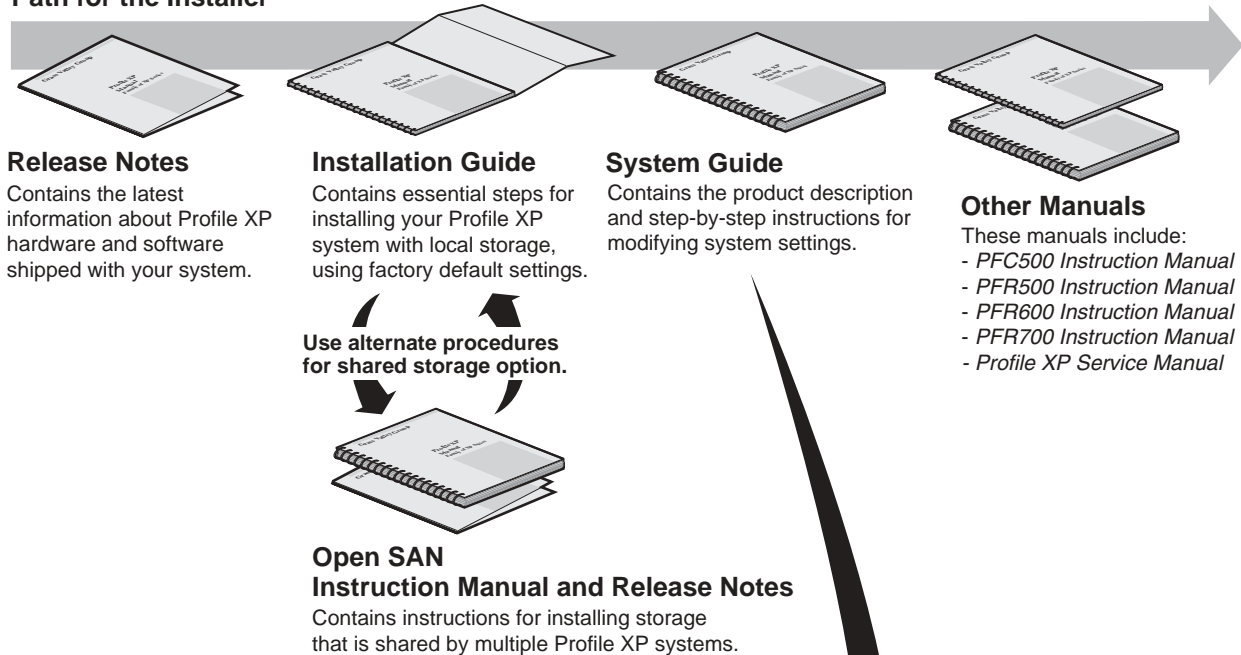

Path for the Operator

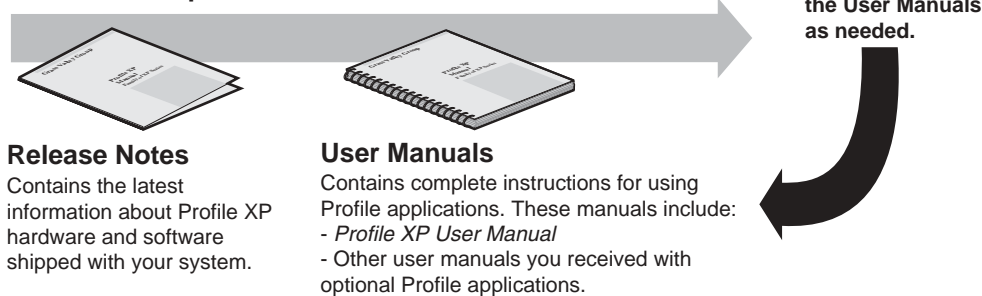

Referring to Safety Summaries



WARNING: Be sure to review all safety precautions listed in the Profile XP System Guide in order to avoid personal injury and prevent damage to this product and its peripheral products.

Checking standard PVS1100 Series accessories

Your PVS 1100 Series Media Platform is shipped with several standard accessories as shown in the table. Locate the accessories you need for your installation and proceed.

Standard PVS1100 Accessories	
Keyboard and Mouse	Ethernet Cable
I/O Panel and interface cable	Windows NT Software Disk and Documentation
Rack-mount slides	Profile XP Software CD-ROM and Release Notes

System power-off and reboot procedure

When you power-off or reboot your Profile XP Platform and RAID storage system, you must follow the proper sequence as described in the following procedure.

NOTE: *If your Profile XP Media Platform is part of an Open SAN, disregard this procedure, and refer to the instructions in the Open SAN Instruction Manual for shutting down the Open SAN.*

1. Power-off the RAID storage system by powering-off the RAID Controller chassis prior to, or at the same time as the RAID Expansion chassis.



CAUTION: *You must always power off the PFR500 RAID Controller chassis prior to, or at the same time as the PFR500E Expansion Chassis. Failure to do so may force some LUNs offline. This will cause loss of access to the media file system when the system is powered on again. Refer to the Profile XP System Guide for instructions on how to recover from improper power-off sequence.*

2. Wait approximately 30 seconds for the disk drives to spin down, then power-on all RAID Expansion chassis, then all RAID Controller chassis. Always power-on the RAID Expansion chassis prior to, or at the same time as the RAID Controller chassis.
3. Wait for RAID storage initialization, as follows:
 - **PFR 700 RAID Storage systems** - Wait until all disk access LEDs are steady — approximately 4 minutes. The controller READY LED must be ON, the front Power LED must be ON, and the front Service LED must be OFF. (Refer to the *PFR 700 Instruction Manual* to interpret other disk access LED or status LED behavior.)
 - **PFR 600 RAID Storage systems** - Wait until all disk access LEDs are steady green— approximately 4 minutes. The rear panel 7-segment LED displays the chassis address. (Refer to the *PFR 600 Instruction Manual* to interpret other disk access LED or 7-segment LED behavior.)
 - **PFR 500 RAID Storage systems** - Wait until all disk access LEDs are steady green— approximately 4 minutes. The rear panel 7-segment LED displays the chassis address and the HOST RDY light is on. (Refer to the *PFR 500 Instruction Manual* to interpret other disk access LED or 7-segment LED behavior.)



- **PFC500 RAID Storage systems** - Wait until the System Check LED is off and all disk access LEDs are steady green— approximately 2 minutes. (Refer to the *PFC500 Instruction Manual* to interpret other front panel LED behavior.)
4. On the Profile XP Media Platform, shut down and restart the Windows operating system. Wait for auto-logon as described in “Start your PVS 1100 system” on page 17.

1 Set up system hardware and connect video

Set up the system hardware as shown in this diagram, then locate your PVS 1100 Series model under Default Video Connections. Use the color coding to make the video I/O connections for the Recorder/Player channels.

PVS1100 Media Platform

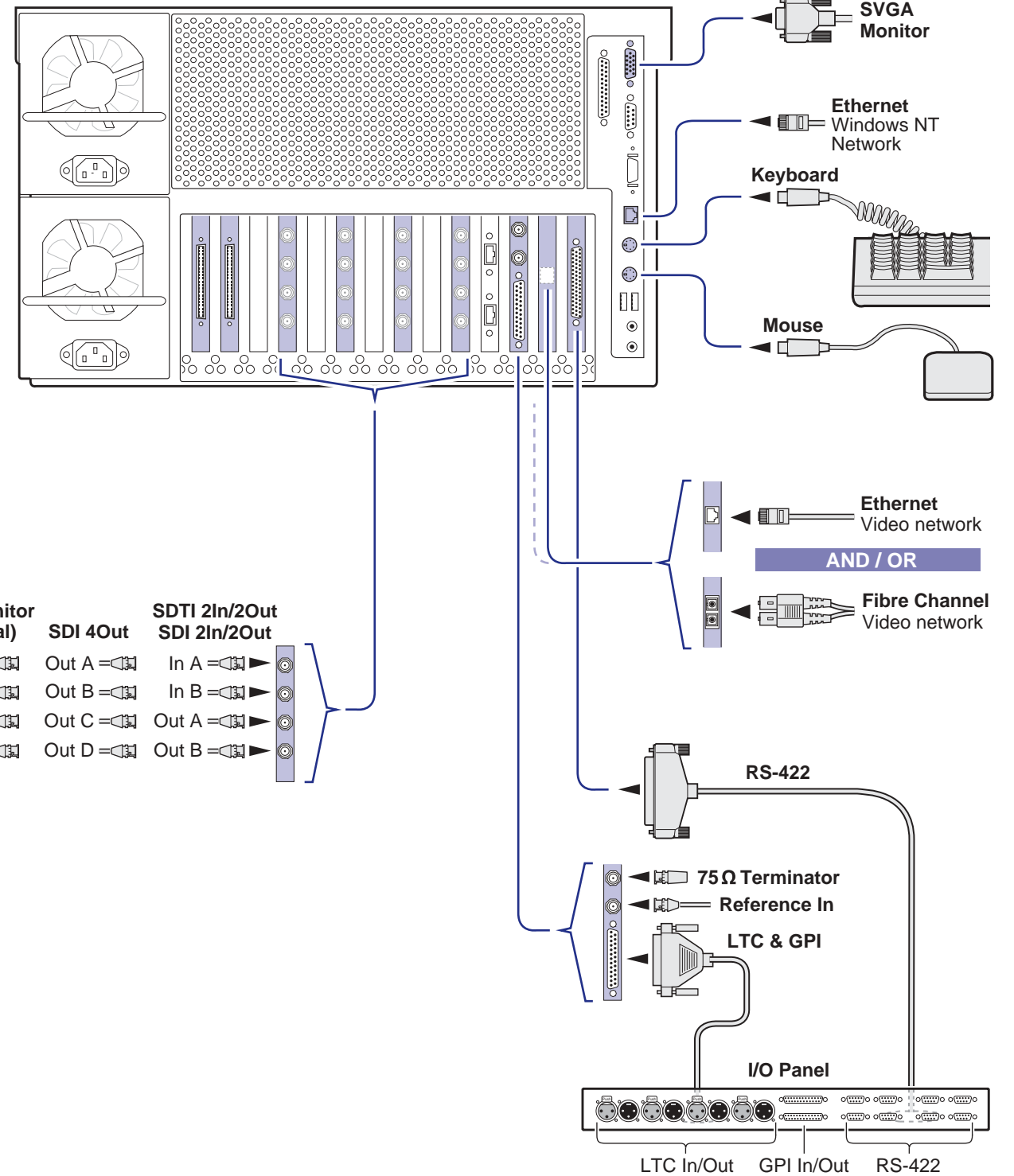

Default Video Connections

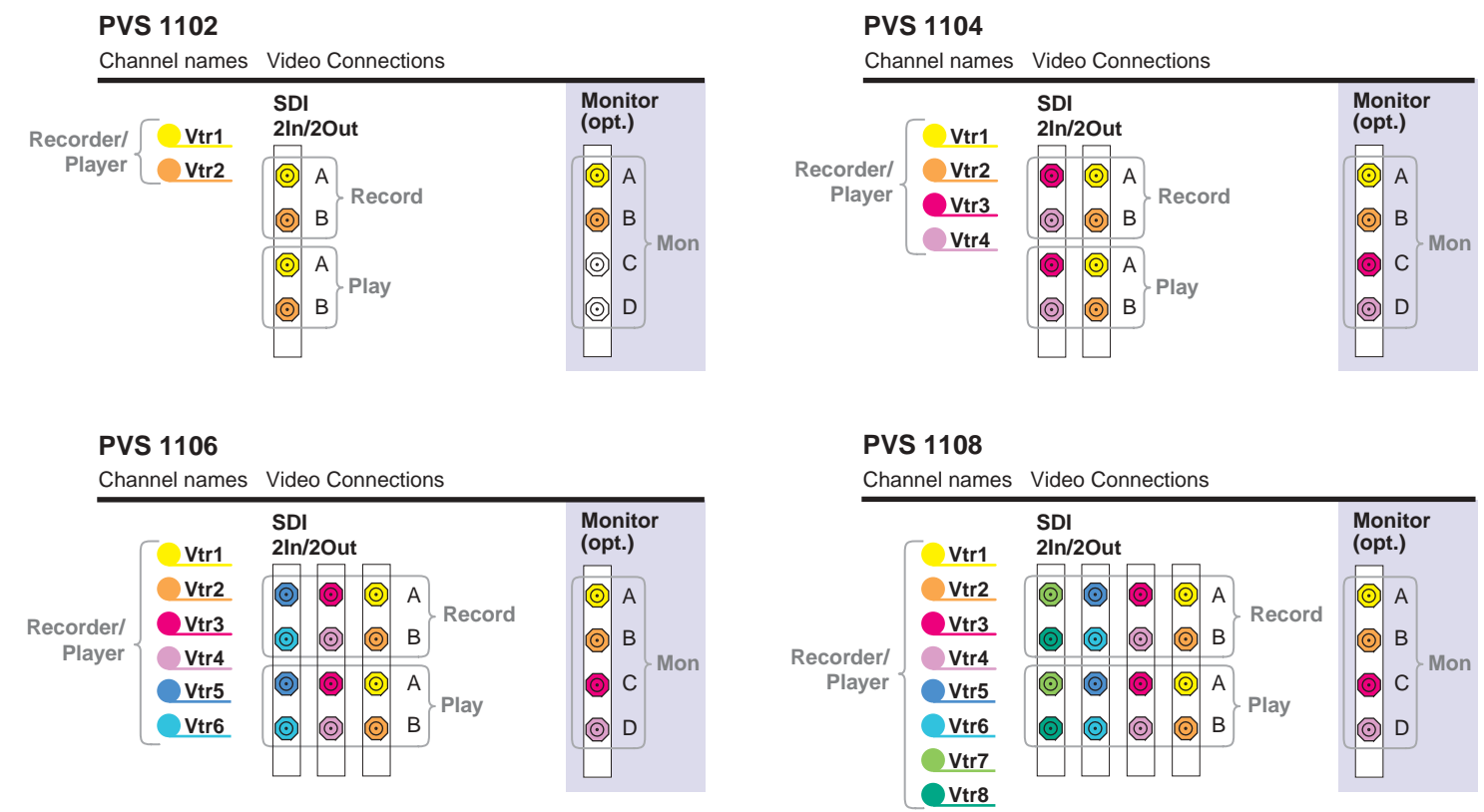

Available for all PVS 1100 Series models.
No factory default SDTI channels defined.

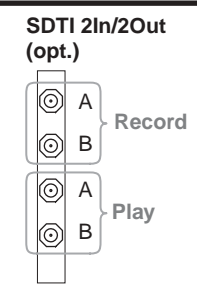

- Notes:
- Video I/Os are assigned beginning with Vtr1 and the board in the lowest numbered board slot.
 - Video Monitor outputs are assigned in the same fashion except to the recorder channels only.
 - Video Monitor outputs are not available for SDTI inputs.
 - SDTI connections are not given default channel assignments.
- Refer to the Profile XP System Guide for information about defining SDTI channels.

2 Connect audio (PVS1102, PVS1104 Only)

Determine if your PVS1100 series system has one or two audio boards installed as shown on this diagram, then use the color coding to determine the audio I/O connections for each video channel.

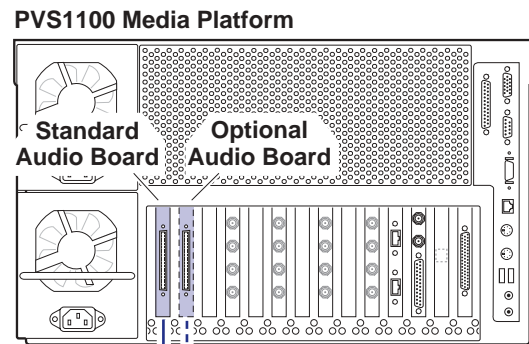

Channel Names	Audio I/O Assignments
---------------	-----------------------

Vtr1	1 - 4
Vtr2	5 - 8
Vtr3	9 - 12
Vtr4	13 - 16

Unassigned in PVS 1102

Channel Names	Audio I/O Assignments
---------------	-----------------------

Vtr1	1 - 8	} Opt. Bd
Vtr2	9 - 16	
Vtr3	1 - 8	} Std. Bd (Unassigned in PVS 1102)
Vtr4	9 - 16	

Audio I/O Connections: One Audio Board Installed

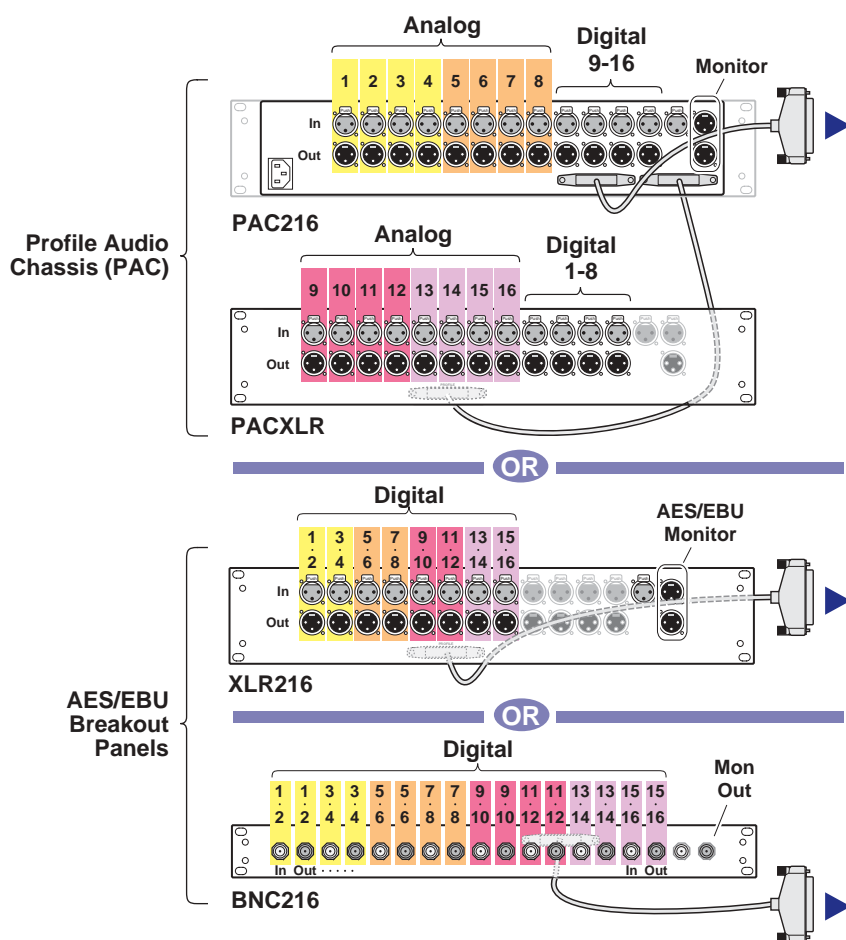

OR

Audio I/O Connections: Two Audio Boards Installed

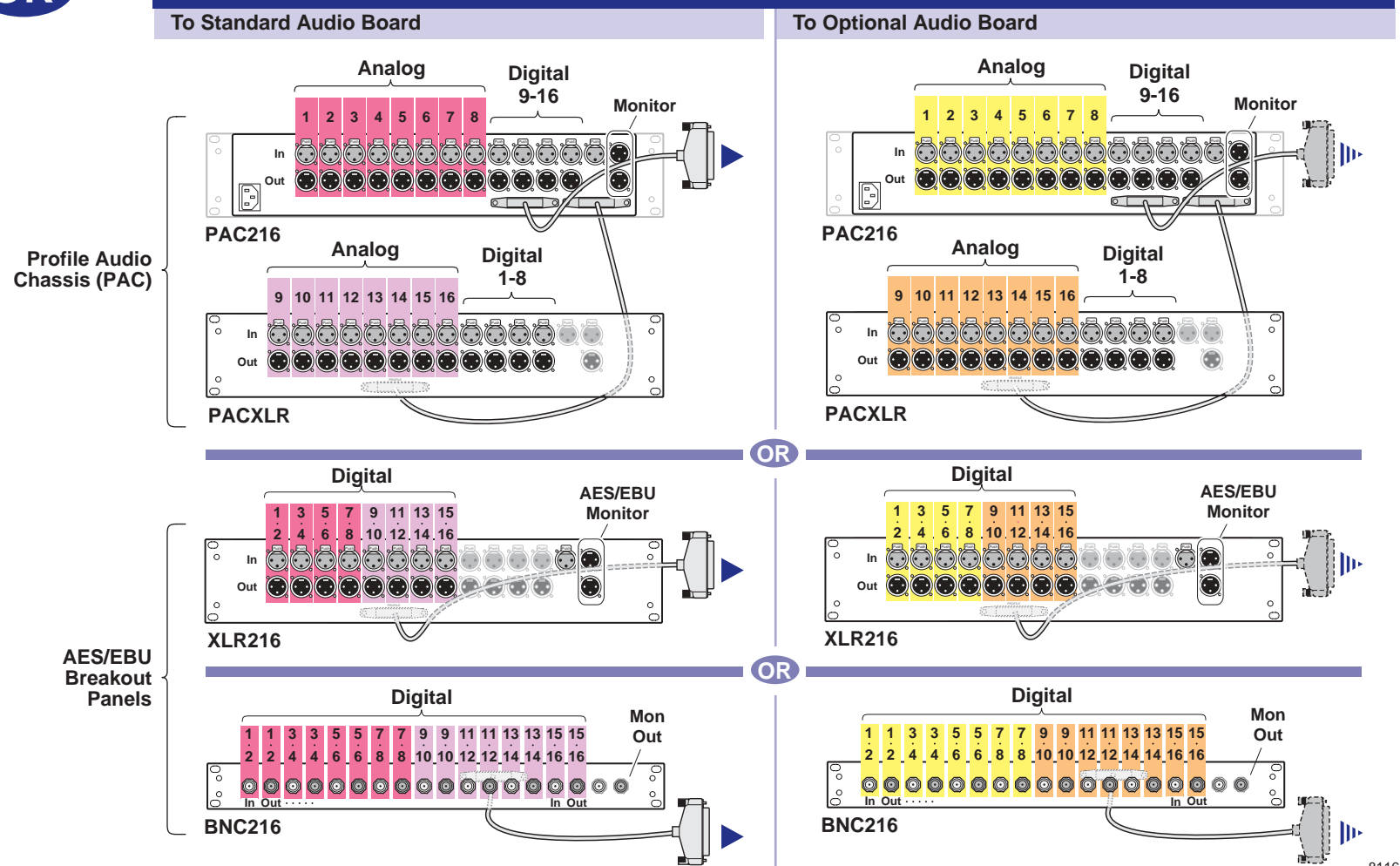

8116-2

2 Connect audio (Except PVS1102, PVS1104)

Determine if your PVS1100 series system has one or two audio boards installed as shown on this diagram, then use the color coding to determine the audio I/O connections for each video channel.

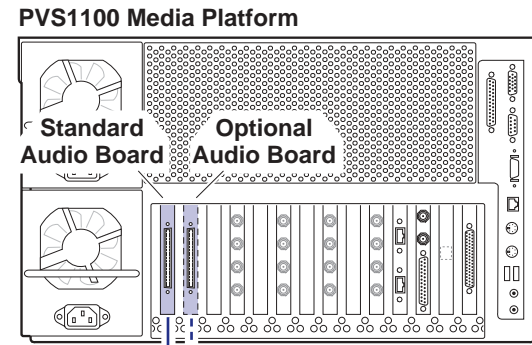

Channel Names	Audio I/O Assignments
---------------	-----------------------

Vtr1	1 - 2
Vtr2	3 - 4
Vtr3	5 - 6
Vtr4	7 - 8
Vtr5	9 - 10
Vtr6	11 - 12
Vtr7	13 - 14
Vtr8	15 - 16

Unassigned in PVS 1106

Channel Names	Audio I/O Assignments
---------------	-----------------------

Vtr1	1 - 4
Vtr2	5 - 8
Vtr3	9 - 12
Vtr4	13 - 16
Vtr5	1 - 4
Vtr6	5 - 8
Vtr7	9 - 12
Vtr8	13 - 16

Opt. Bd
Std. Bd
Unassigned in PVS 1106

Audio I/O Connections: One Audio Board Installed

OR

Audio I/O Connections: Two Audio Boards Installed

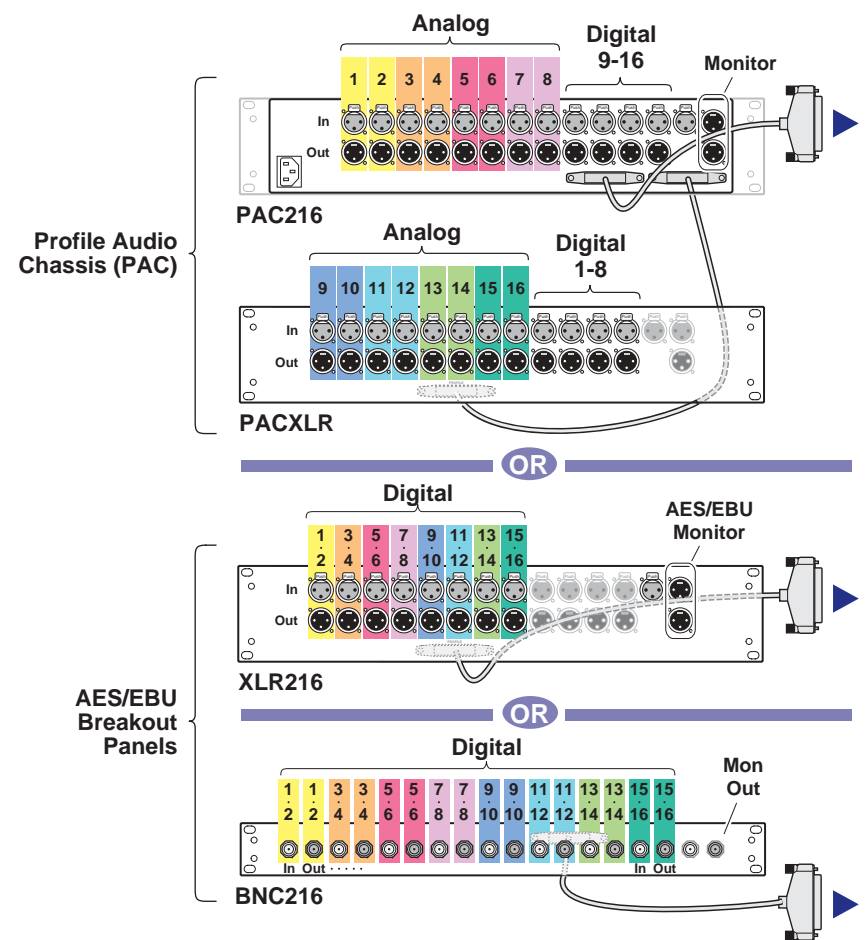

To Standard Audio Board To Optional Audio Board

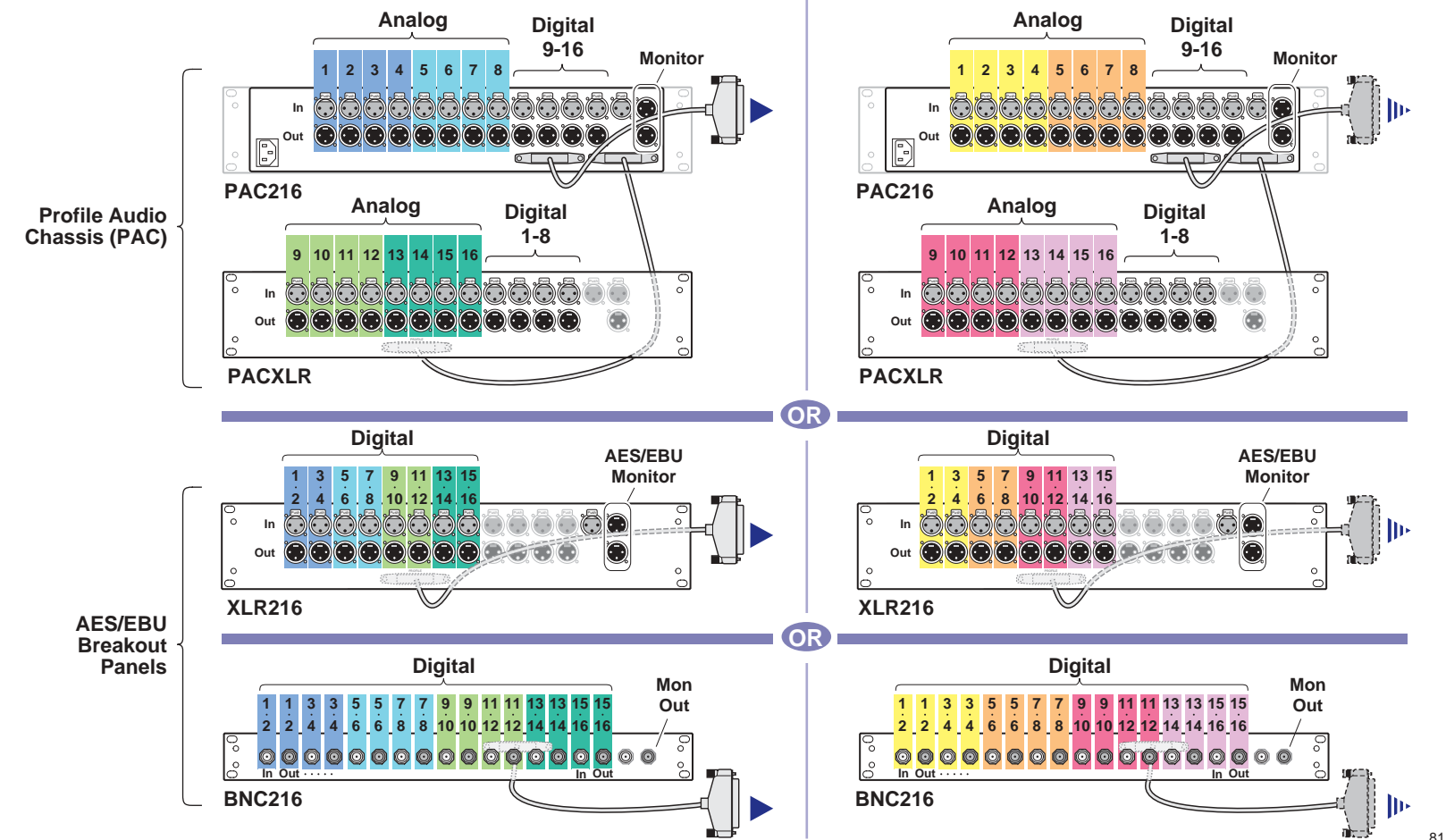

IMPORTANT: If you are installing your PVS1100 as part of an Open SAN, do not perform this RAID storage setup. Instead, follow the instructions in the Open SAN Instruction Manual for setting up RAID storage.

3 Set up RAID Storage: PFC500/E (Local storage only)

Use this diagram to set up the PFC500 Fibre Channel RAID Chassis and the PFC500E Expansion Chassis (if used).

1 Set chassis addresses on all PFR 500E Expansion Chassis.

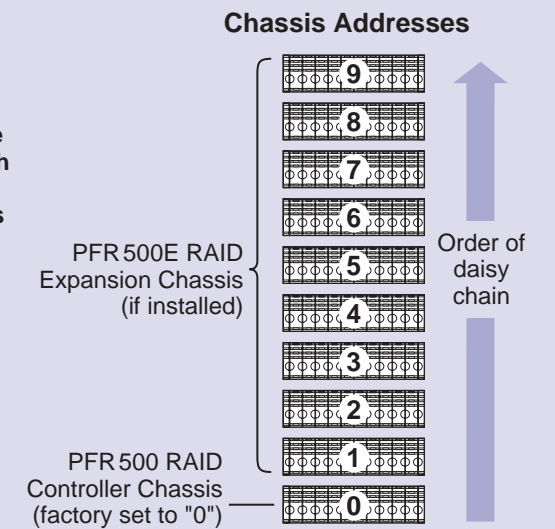
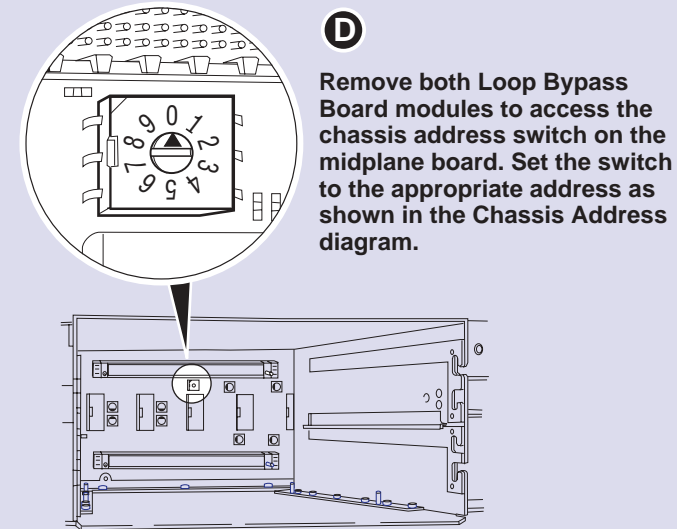
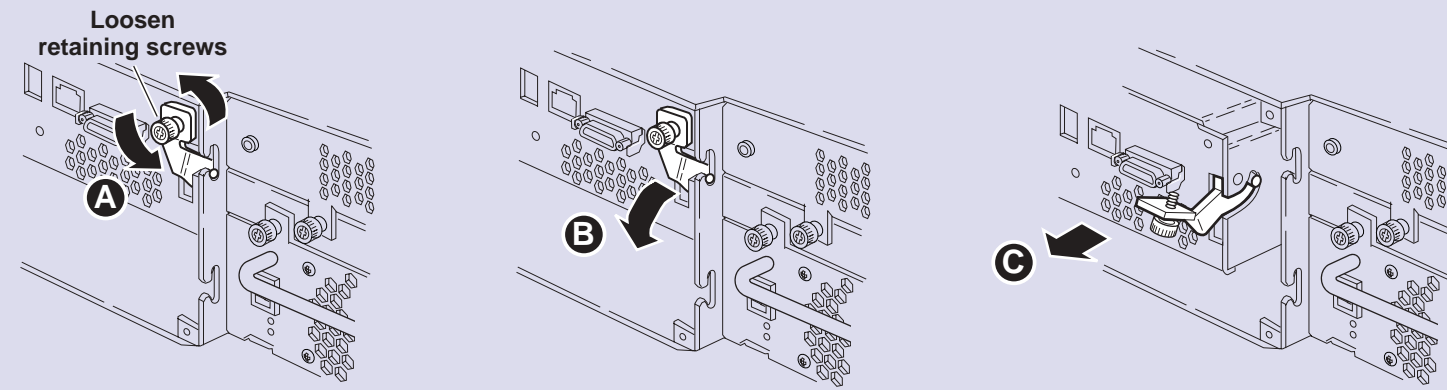

2 Install all SFPs and GBICs provided so that you can connect Fibre Channel cabling as shown.

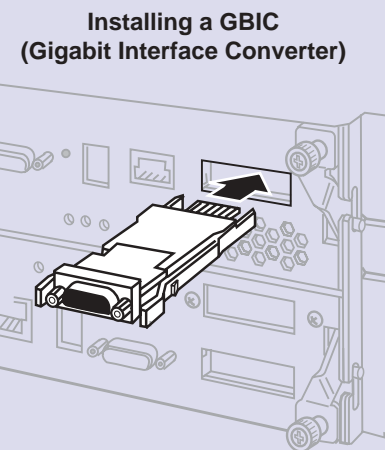
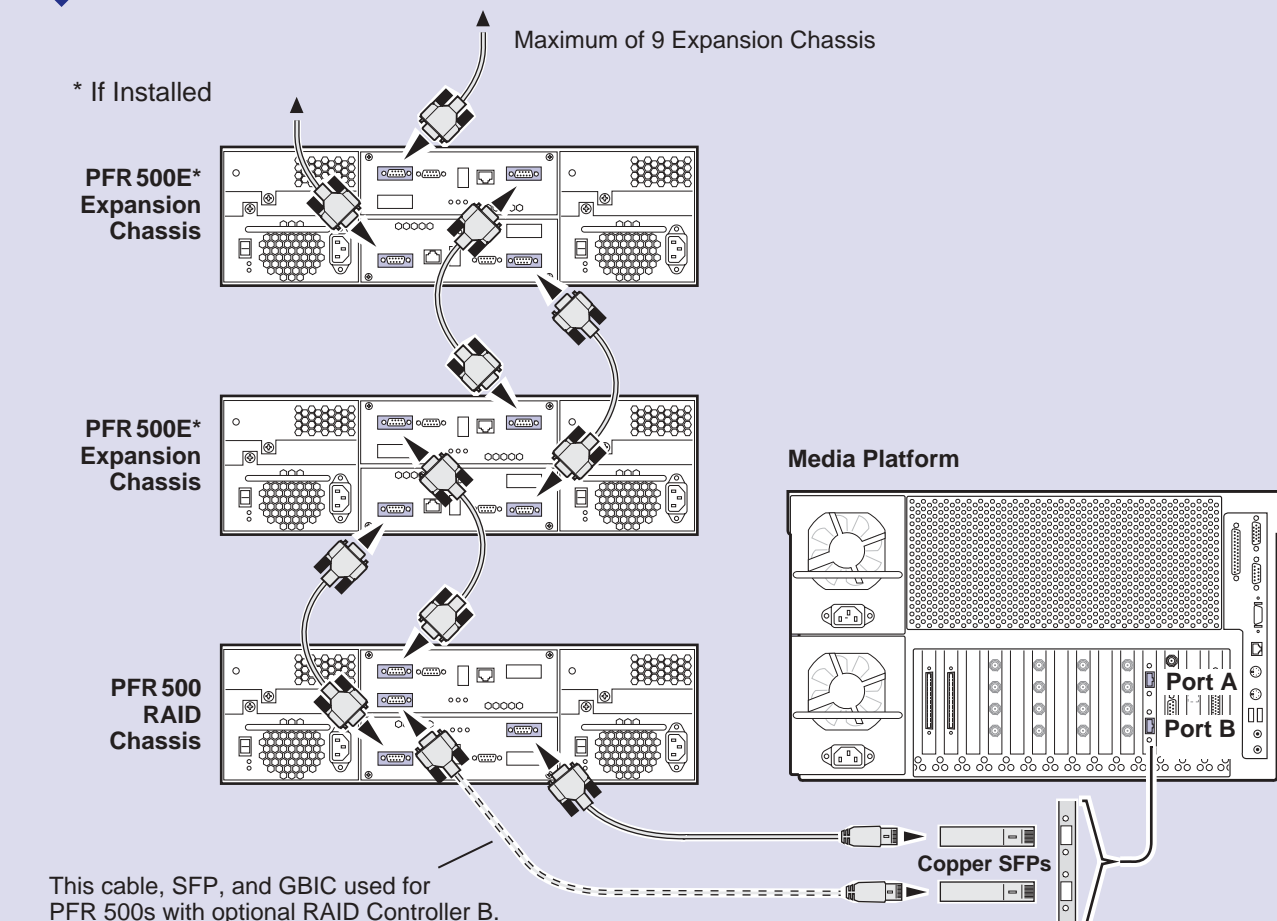

3a Set up the RAID Storage: PFR 500/E (Local storage only)

Use this diagram to set up the PFR 500/E chassis addresses and to connect Fibre Channel cabling, then proceed to step 3b on the next page.

IMPORTANT: If you are installing your PVS1100 as part of an Open SAN, do not perform this RAID storage setup. Instead, follow the instructions in the Open SAN Instruction Manual for setting up RAID storage.

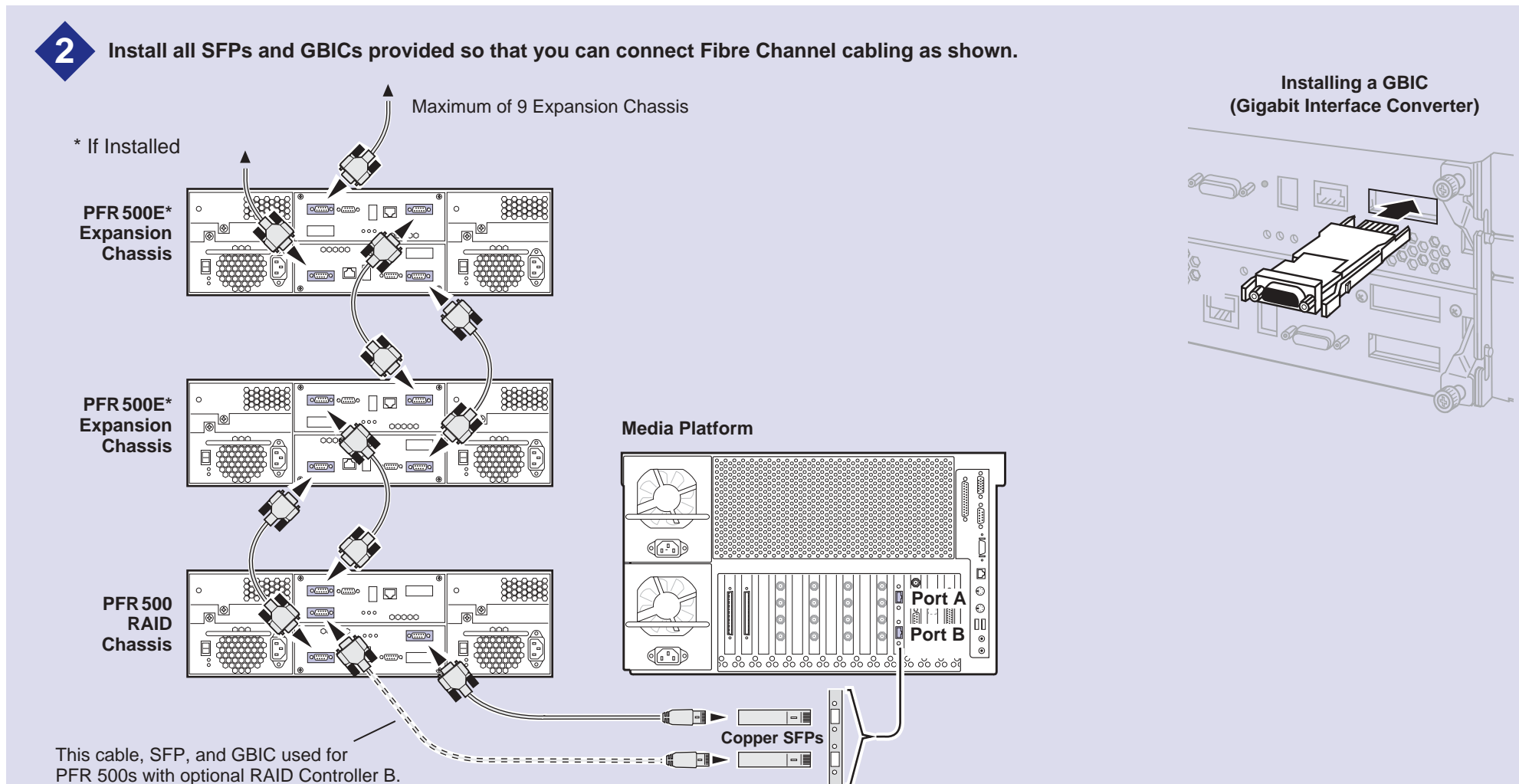
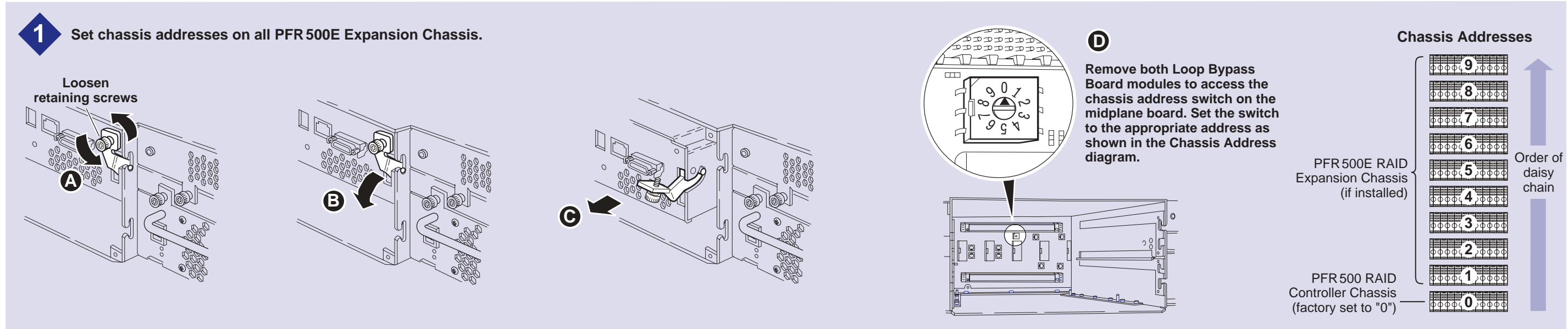

IMPORTANT: If you are installing your PVS1100 as part of an Open SAN, do not perform this RAID storage setup. Instead, follow the instructions in the Open SAN Instruction Manual for setting up RAID storage.

3b Set up RAID Storage: PFR500/E (Local storage only)

Use this diagram to connect Ethernet and serial interface cabling required for monitoring the PFR500/E with NetCentral Lite or NetCentral Manager.

3 Install ethernet cabling and switch or hub as shown.

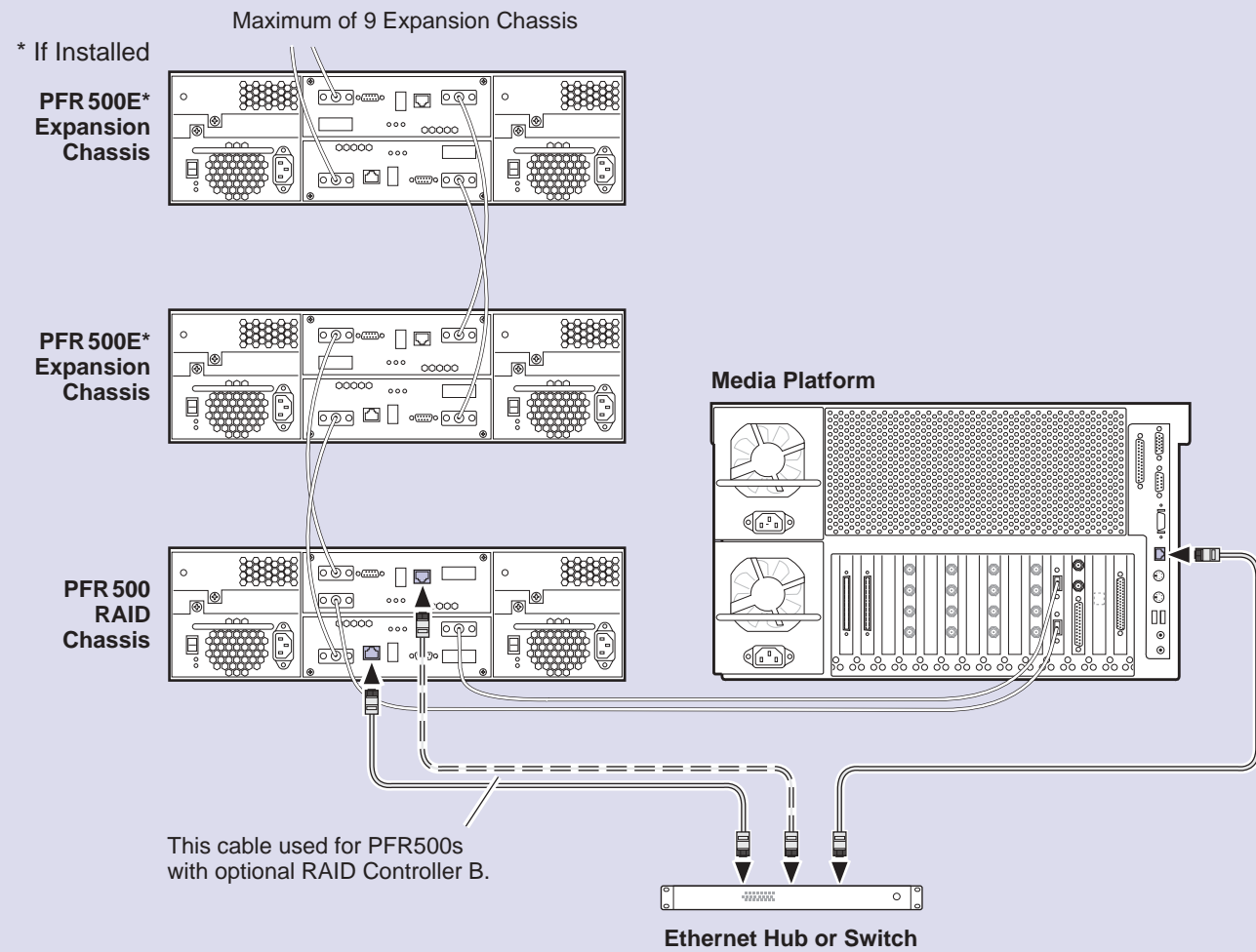

4 Install serial cabling as shown.

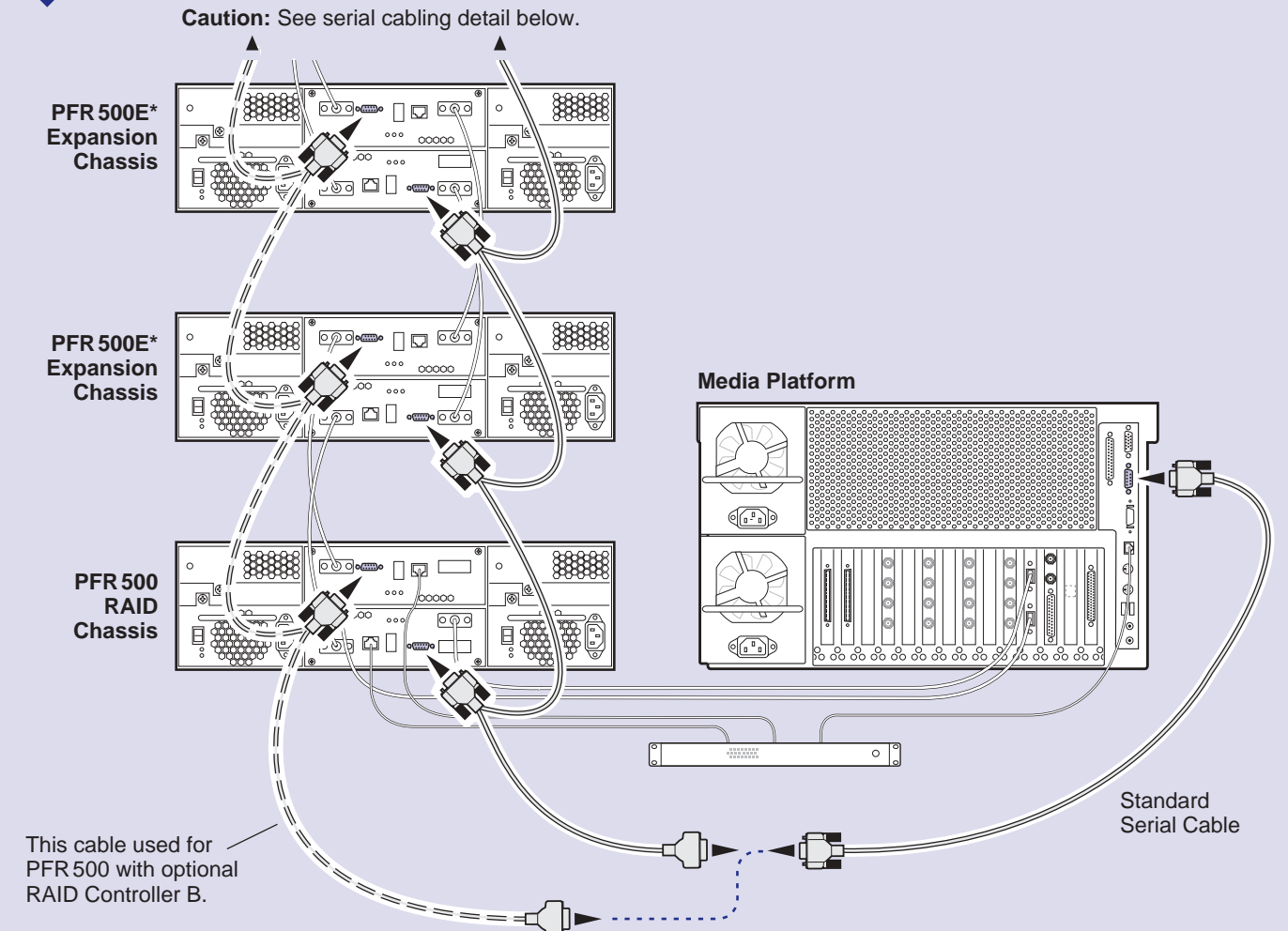

5 Connect power cords, and turn on power as shown. You must power-up the PFR500E Expansion chassis prior to, or at the same time as the PFR500 RAID Controller chassis. Verify power-up as shown.

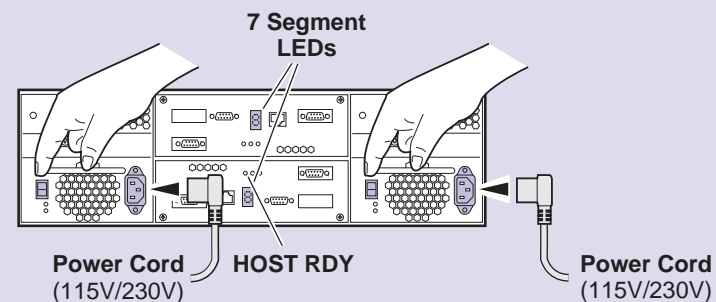

Power-up Verification

- Rear panel "7 Segment LED" displays the chassis address as set in step 1.
- All disk drive LEDs are green after approximately 3 minutes.
- All HOST RDY LEDs are green after approximately 3 minutes.
- Refer to the *PFR500 Instruction Manual* if there is a problem.

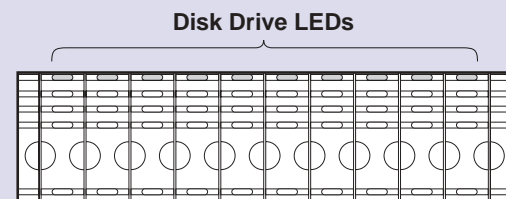

After RAID Controller A is configured, the standard serial cable will be moved to this connector to configure RAID Controller B, if installed.

Serial Cabling Detail (Applies to primary and redundant cabling)

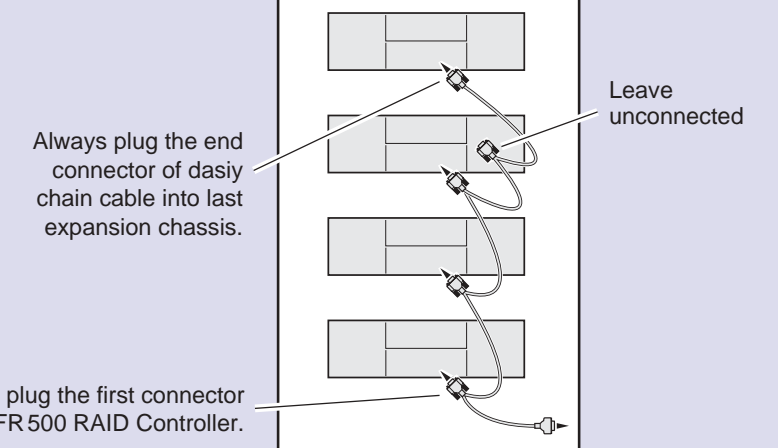

3c Set up the RAID Storage: PFR 600/E (Local storage only)

Use this diagram to set up the PFR 600/E chassis addresses and to connect Fibre Channel cabling, then proceed to step 3d on the next page.

IMPORTANT: If you are installing your PVS1100 as part of an Open SAN, do not perform this RAID storage setup. Instead, follow the instructions in the Open SAN Instruction Manual for setting up RAID storage.

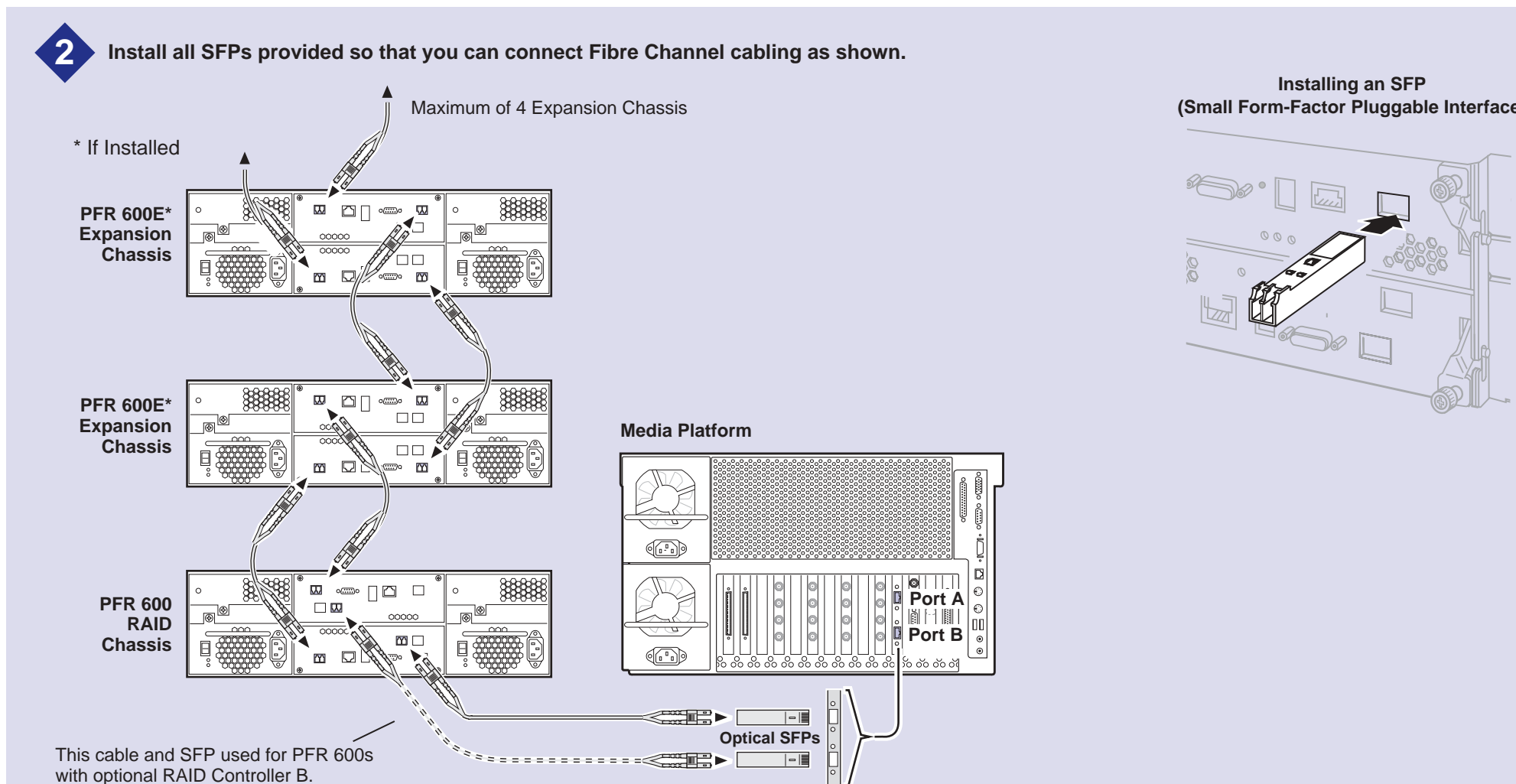
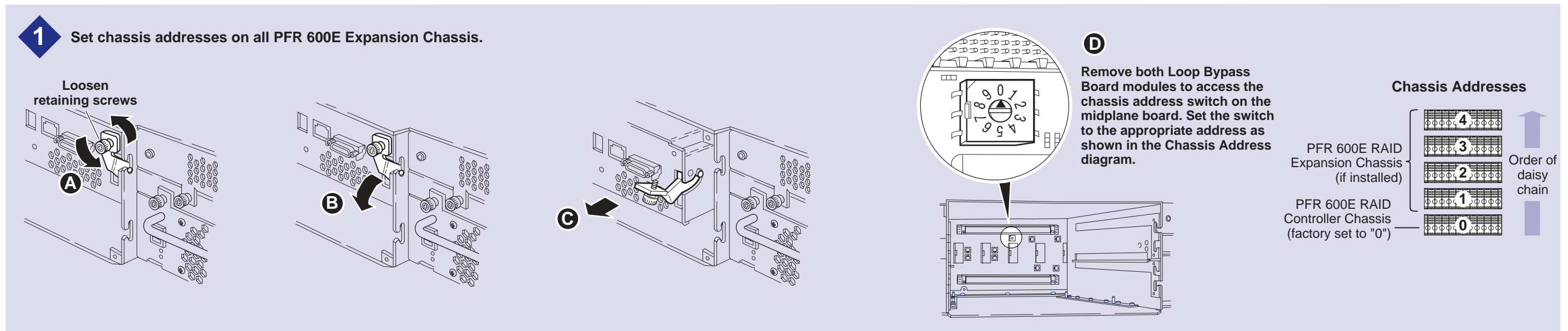

IMPORTANT: If you are installing your PVS1100 as part of an Open SAN, do not perform this RAID storage setup. Instead, follow the instructions in the Open SAN Instruction Manual for setting up RAID storage.

3d Set up RAID Storage: PFR 600/E (Local storage only)

Use this diagram to connect Ethernet and serial interface cabling required for monitoring the PFR 600/E with NetCentral Lite or NetCentral Manager.

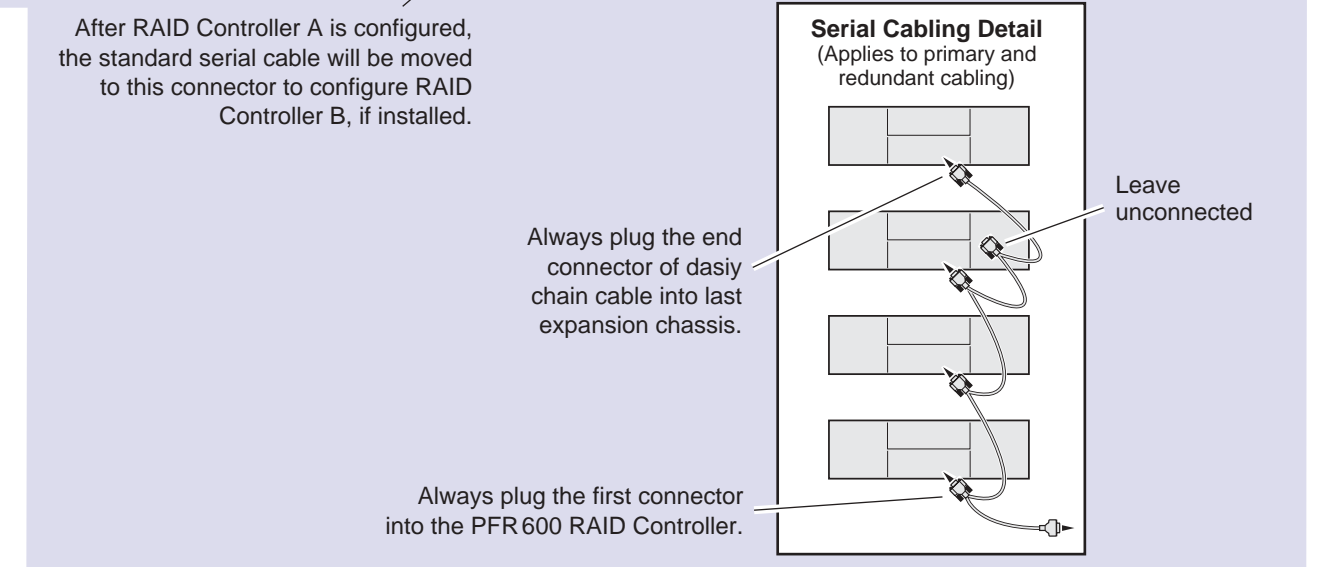
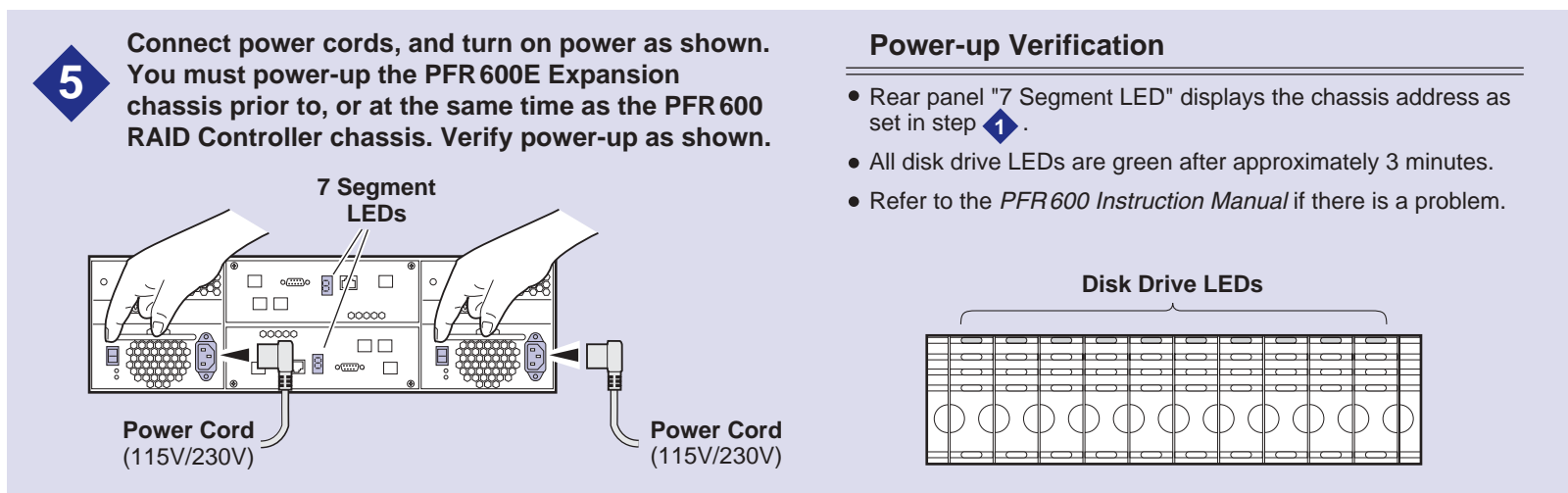
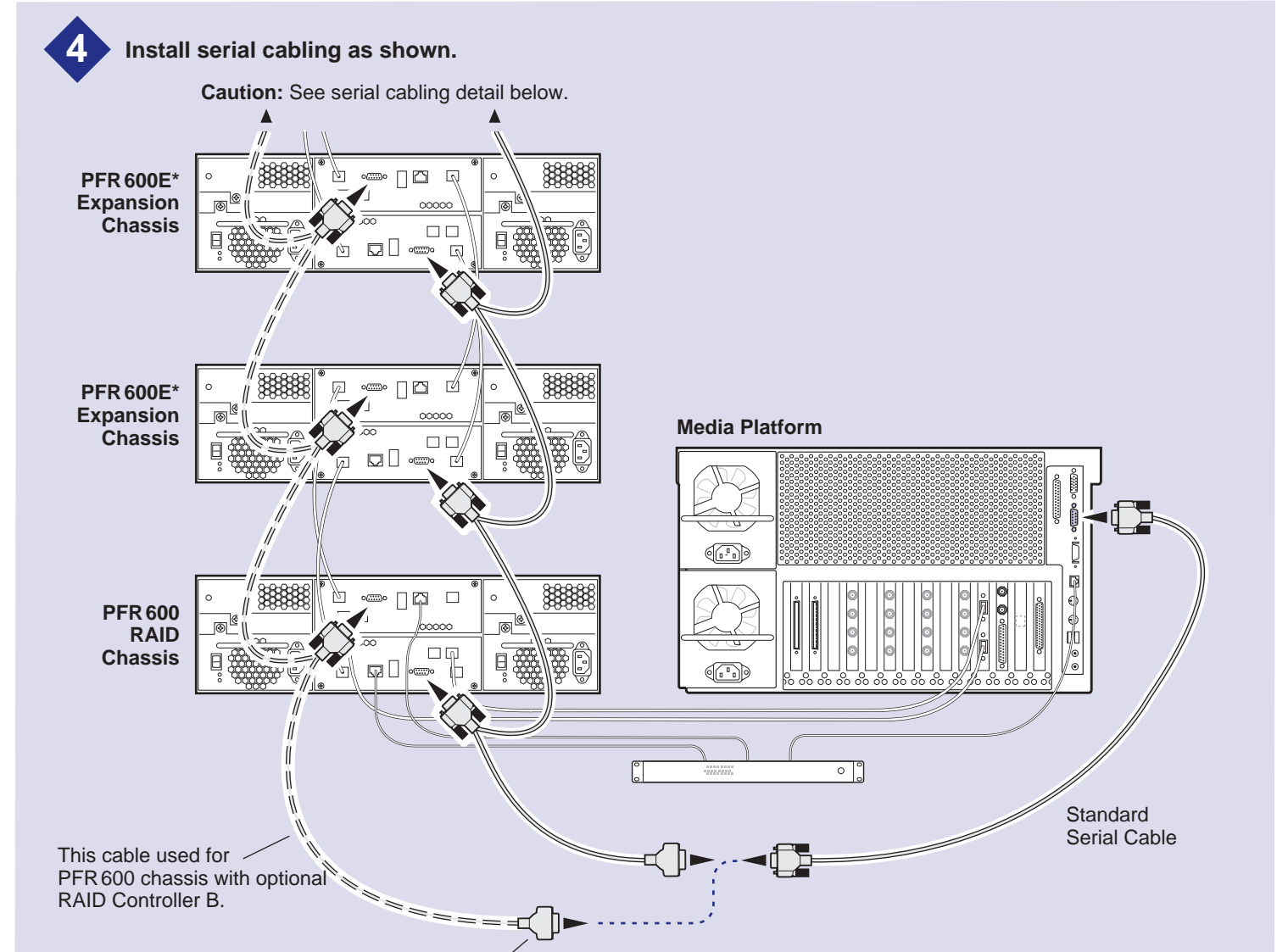
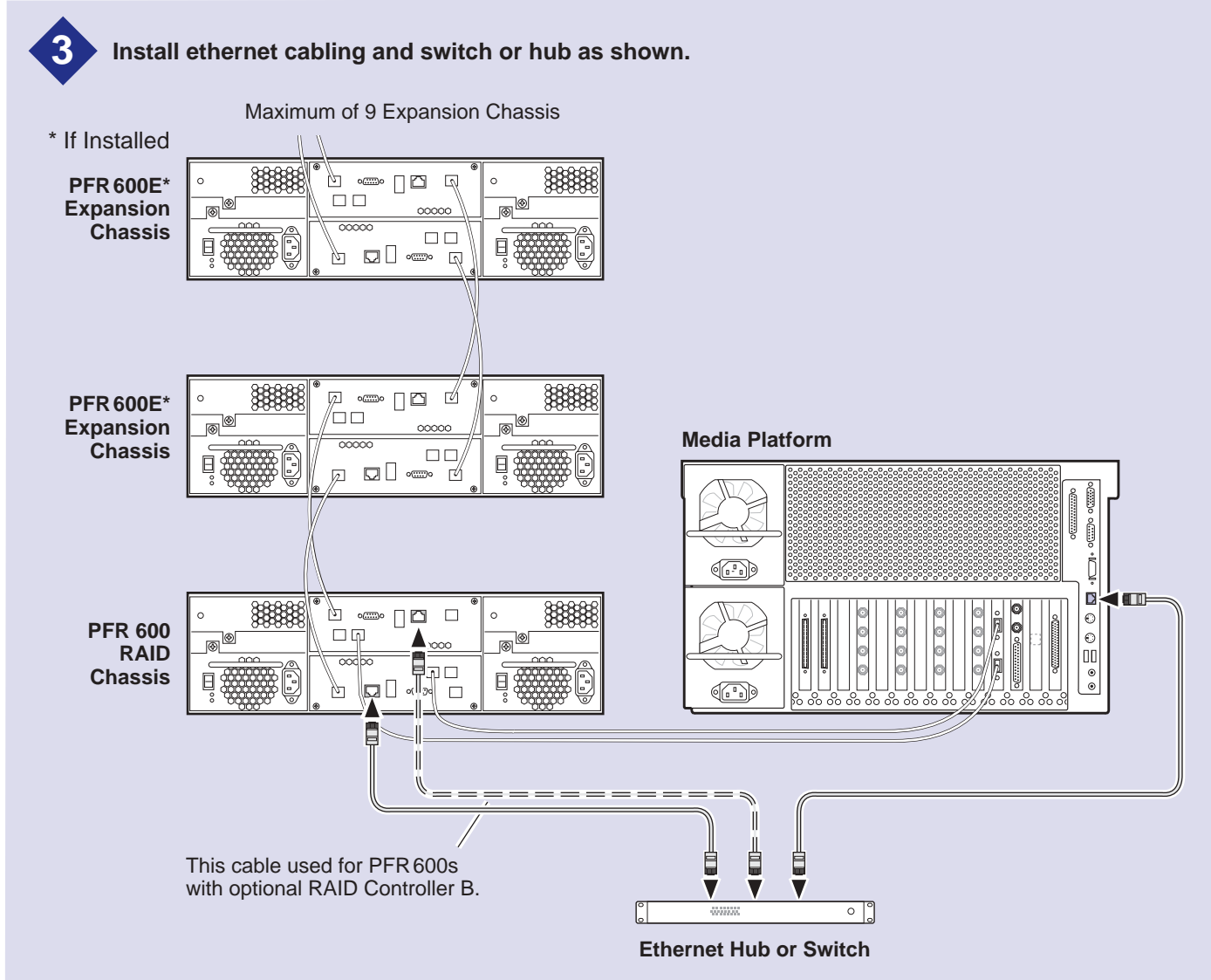

3e Set up the RAID Storage: PFR 700/E (Local storage only)

Use this diagram to set up the PFR 700/E Fibre Channel addresses and to connect Fibre Channel, Ethernet, and diagnostic cabling.

IMPORTANT: If you are installing your PVS1100 as part of an Open SAN, do not perform this RAID storage setup. Instead, follow the instructions in the Open SAN Instruction Manual for setting up RAID storage.

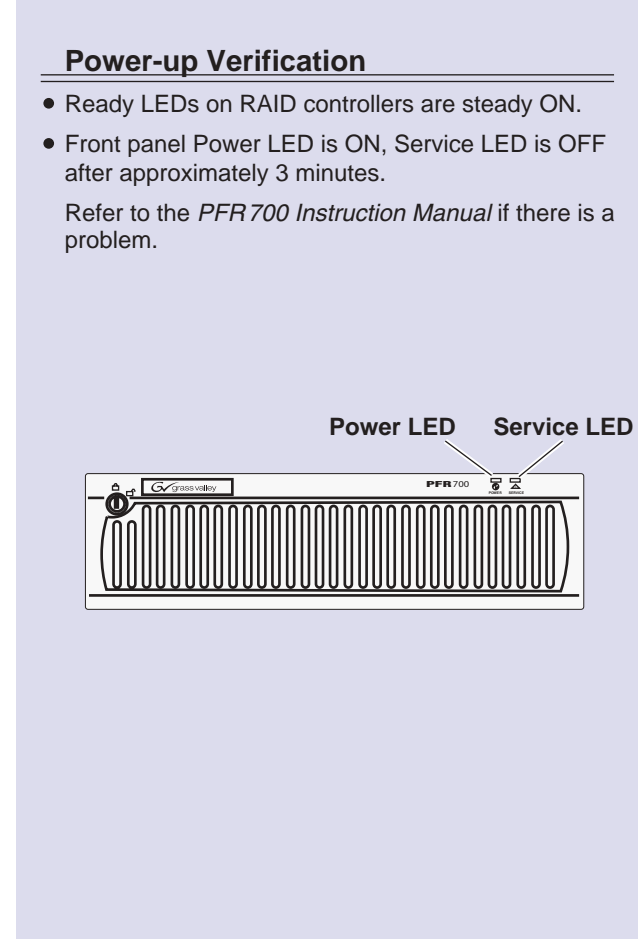
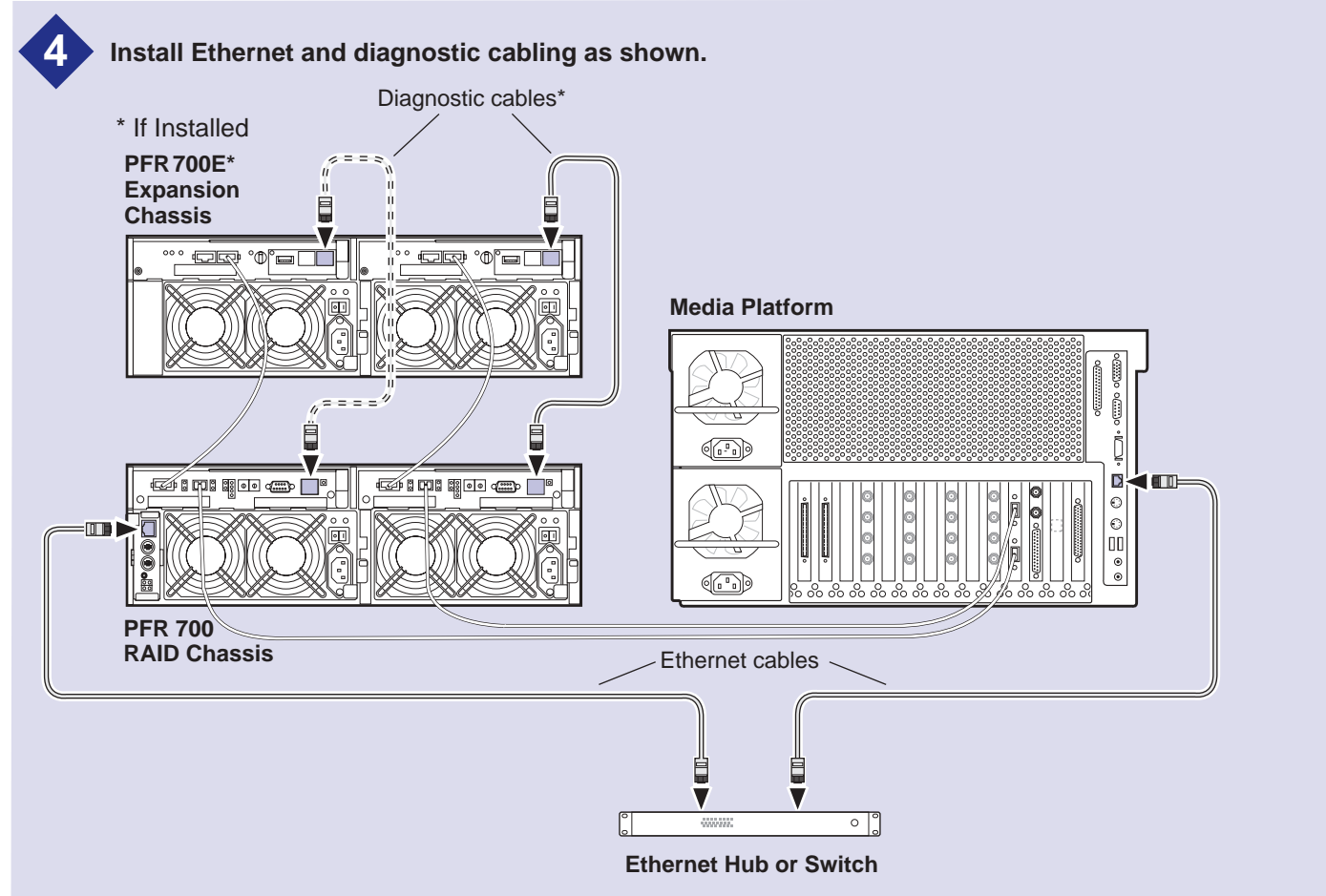
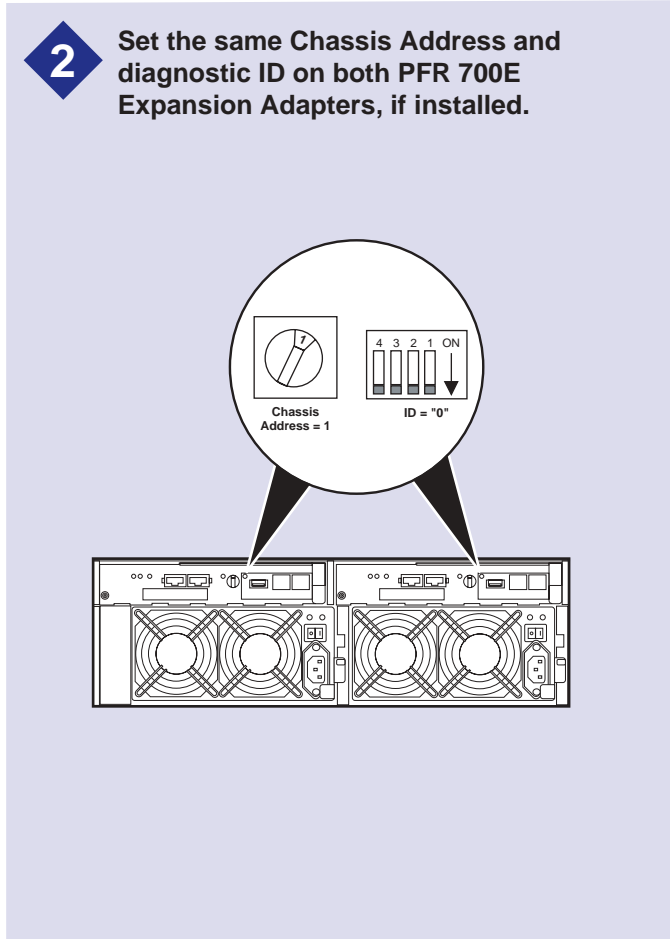
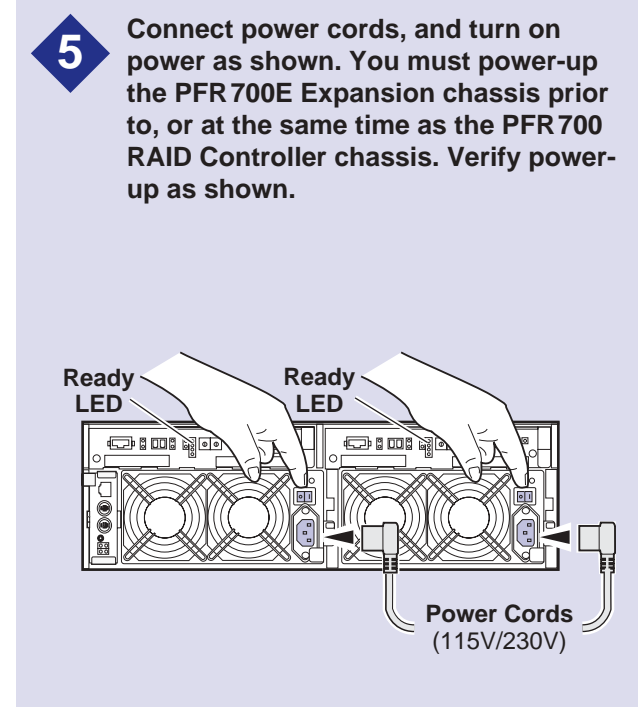
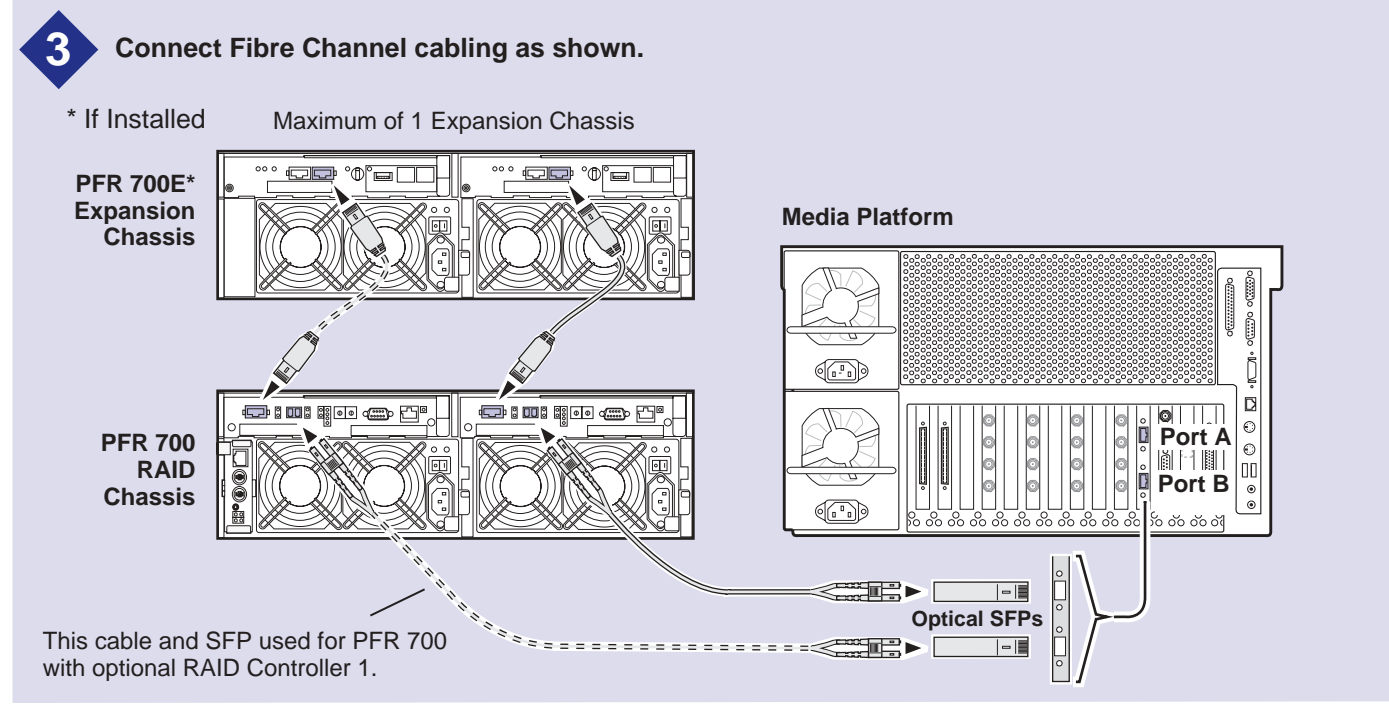
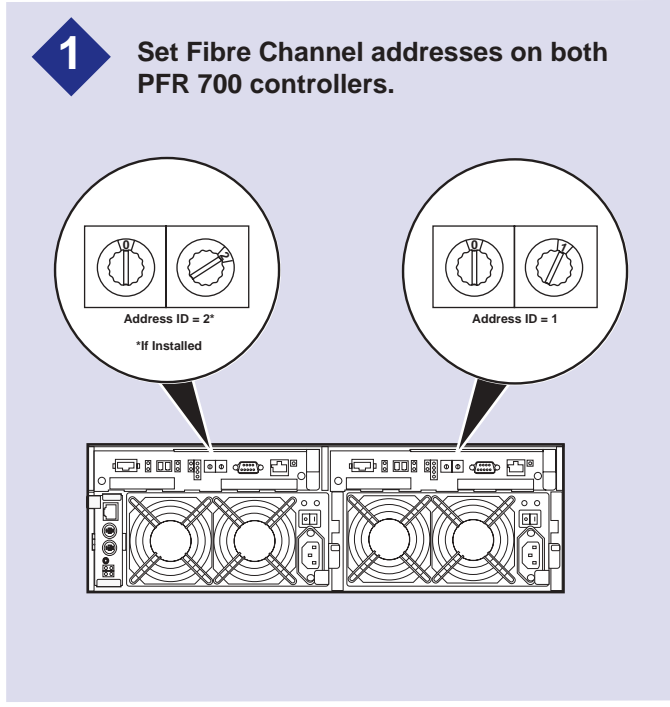

4 Start your PVS1100 system

IMPORTANT: If you are installing your PVS1100 as part of an Open SAN, disregard this step. Instead, follow the instructions in the Open SAN Instruction Manual for starting your PVS1100 system.

To start your system:

1. Connect power cords to the PVS 1100 and all peripheral devices.

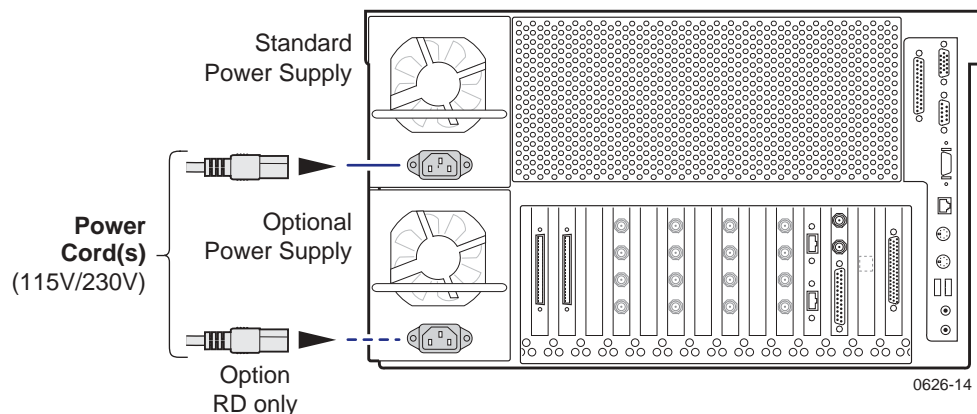

2. Turn on power to all peripheral devices connected to the PVS 1100.

NOTE: Do not power-on the PVS1100 until the RAID storage system is fully initialized. Refer to RAID storage power-up verification steps on pages 10-15.

3. Turn on the PVS 1100 using the front panel standby switch, and wait for Windows NT to initialize and perform auto-login. The Windows NT desktop will appear after successful auto-login.

During initialization, the Profile XP system software checks the RAID storage system for a video file system. Since at first power-up one is not found, an error message may be displayed regarding loss of the video file system.

Proceed with the next procedure to create a new video file system.

IMPORTANT: You must use the proper power-off sequence when turning off or rebooting the Profile XP Platform and RAID storage system. Refer to “System power-off and reboot procedure” on page 5.



Start your PVS1100 system

5 Create a video file system

IMPORTANT: If you are installing your PVS1100 as part of an Open SAN, disregard this step. Instead, follow the instructions in the Open SAN Instruction Manual for starting your PVS1100 system.

Before you can use your PVS 1100 system, you must create a video file system on the Fibre Channel RAID Chassis using the Disk Utility.

NOTE: If you want to configure some drives as hot spare drives, do not perform this procedure. Instead, perform the procedures found in Chapter 3 of the Profile XP System Guide in the section titled “Configuring RAID storage using GVG Disk Utility”, then proceed with the next procedure in this guide.

To create a video file system:

1. Start Configuration Manager using the desktop shortcut or by selecting **Start | Programs | Profile Applications | Configuration Manager**. The Configuration Manager dialog box appears.

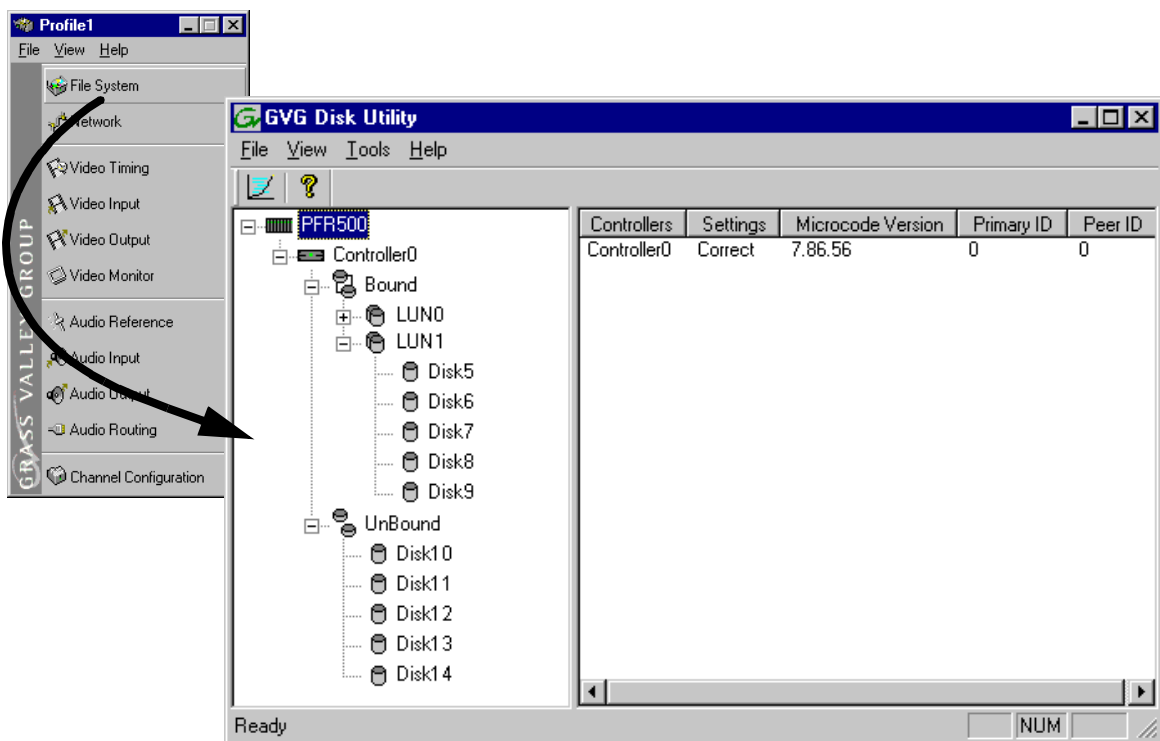

2. Click **File System** to start the GVG Disk Utility.



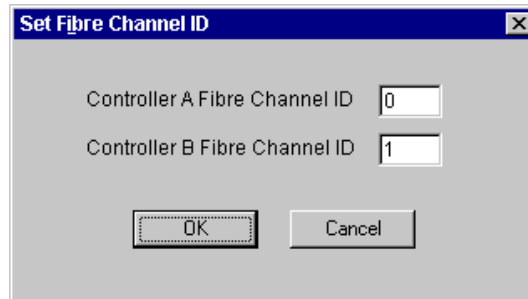

3. If you are configuring a PFR 500 or PFR 600 storage system, perform the following steps to set the Fibre Channel ID, otherwise, proceed to step 4.
 - a. Expand the tree view and right-click the **Controller0** icon under PFR 500 or PFR 600, then select **Set Fibre Channel ID** in the context menu.

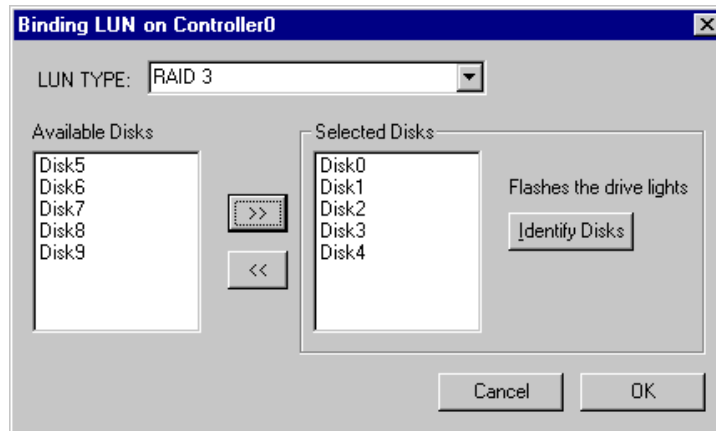

- b. In the Set Fibre Channel ID dialog box, enter IDs as shown, then click **OK**.
 - c. Click **OK** in the Operation Successful dialog box.
 - d. Cycle the power on the RAID Controller chassis. Leave the power off for about 30 seconds before powering on again. You can leave the Expansion chassis powered on during this time.
 - e. After the RAID Controller chassis has finished initializing, restart the Windows NT operating system on the Profile XP Platform.
 - f. Start Configuration Manager using the desktop shortcut or by selecting **Start | Programs | Profile Applications | Configuration Manager**.
 - g. In Configuration Manager dialog box appears. click **File System** to start the GVG Disk Utility.
 4. Expand the tree view and identify bound LUNs and unbound disks by their placement in the hierarchy of the tree view.
 5. If there are unbound LUNs displayed in the tree view, you must perform the following steps, otherwise, proceed to step 6.
 - a. To bind unbound disks, right-click the **Unbound** node for a controller, then select **Bind LUNs** in the context menu. Peer controllers that share the same set of disks are automatically selected as a pair.

The Binding LUN... dialog box opens showing all unbound disks for the controller listed in the Available Disk list.



- b. Select RAID 3 using the LUN TYPE drop-down box.
- c. Select five contiguous disks, then click the add button  to add them to the Selected Disks list. (TIP: Use 'shift-click' to select disks.)
- d. Click **OK** to close the Binding LUN... dialog box and begin the binding process. The Progress Report dialog box opens, showing the status of the binding process.
- e. Repeat step a through step d for all unbound disks on all remaining controllers displayed in the tree view.

NOTE: PFR500 and PFR600 controllers take less than a minute to bind a LUN, but can bind only one LUN at a time. You must wait until binding is completed before binding the next LUN. PFC500 and PFR700 controllers can take several hours to bind a LUN, but allow multiple binding processes at the same time.

- f. Upon 100% completion, click **Close** in Progress Report window.

NOTE: Do not proceed until all LUNs are finished binding.

- g. Restart the Windows NT operating system on the Profile XP Platform.
 - h. Start Configuration Manager using the desktop shortcut or by selecting **Start | Programs | Profile Applications | Configuration Manager**.
 - i. In Configuration Manager, click **File System** to start the GVG Disk Utility.
6. In the GVG Disk Utility main menu, click **Tools | Make File System**. The File System wizard appears.

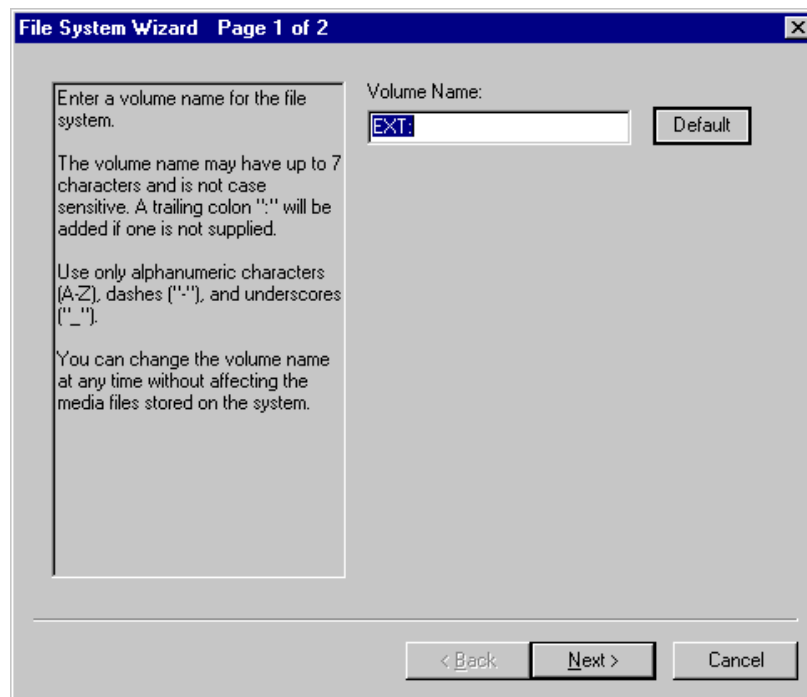

7. Enter a volume name or accept the default name, then click **Next**.

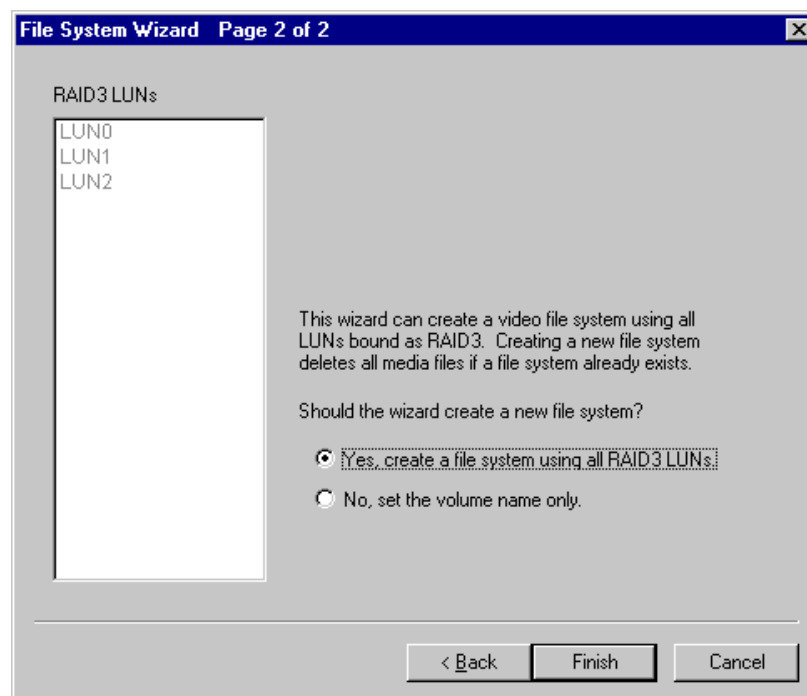

8. Select **Yes, create a file system using all RAID3 LUNs**, then click **Finish**.
9. Click **OK**, in the warning message box. The Progress Report window appears showing the create file system task status.

10. Upon 100% completion, click **Close** in Progress Report window.
11. When the reboot message appears, click **OK**, then restart the Windows NT operating system on the Profile XP Platform.
12. Continue with the next procedure in this guide.



6 Set up PFR 500 or PFR 600 network settings

This procedure explains how to modify factory default PFR500 or PFR600 network and SNMP settings for monitoring with NetCentral Lite or NetCentral Manager. This step is not required for PFC500 RAID storage systems.

NOTE: *Disregard this step if you are connecting one Profile XP Platform and PFC500 RAID storage system to a network using factory default network settings. Proceed to “Start NetCentral Lite monitoring software” on page 33.*

PFR500 or PFR600 network is set up using a console program accessed through the serial port on the RAID Controller and Hyperterminal, running on the Profile XP system. Both RAID controllers must be configured if the optional RAID Controller B is installed. Refer to the *Profile XP Service Manual* for information on using NetCentral Lite.

Modifying network and SNMP settings on RAID Controller A

This procedure assumes the PFR500 or PFR600 is cabled and powered-up as shown on page 11 and page 12 or page 13 and page 14.

To configure PFR500 or PFR600 network and SNMP settings:

1. Start a Hyperterminal session using the following steps:
 - a. Click **Start | Programs | Accessories | Hyperterminal | HyperTerminal**.
 - b. In the Connection Description dialog box, type `pfr`, then click **OK**.
 - c. In the Connect To dialog box, click **OK**.
 - d. In the Com1 Properties dialog box, click **Restore Defaults**, then click **OK**. (9600, 8 bits, parity none, stop bit 1, flow control none) A flashing cursor appears in the terminal window.
2. Use the instructions in the following table to modify RAID controller settings.



>>> **CAUTION: Use only the PFR500 and PFR600 commands specified in this procedure. Modifying some system parameters may render your RAID chassis inoperable.**

Instructions	Text entered and displayed in terminal window
<p>Press Enter to receive the command prompt, then type <code>reboot</code>, and press Enter.</p> <p>NOTE: If you fail to receive the command prompt, check cabling and verify Hyper Terminal setup. Try cycling the power on the RAID Controller chassis. You can leave the Expansion chassis on. The boot screen should appear.</p>	<pre>Ciprico# reboot</pre>
<p>The boot screen appears. After default settings are displayed, press any key within 10 sec, otherwise, the RAID controller will initialize and display a command prompt.</p> <p>NOTE: If you miss the 10 second window, type <code>reboot</code> again when the command prompt appears, then press Enter, or try cycling the power on the RAID Controller chassis. You can leave the Expansion chassis on. The boot screen should appear.</p>	<pre>Rebooting now - this will kill this shell. Ciprico Web Manager Copyright Ciprico Inc. 2000 ----- NETWORK INTERFACE PARAMETERS: IP address on LAN is 192.168.0.11 LAN interface's subnet mask is 255.255.255.0 COMMUNICATION PARAMETERS: Serial channels will use a baud rate of 9600 HARDWARE PARAMETERS: This board's MAC Address is 0:20:46:11:14:23 APPLICATION PARAMETERS: Boot Ciprico Network Server Mail and SNMP notification will occur for Hardware changes, Warnings, and Critical events. SNMP TRAP CONFIGURATION: TRAP COMMUNITY NAME 'public' TRAP MANAGER #1 IP Address 192.168.0.10 After board is reset, start-up code will wait 10 seconds ----- To change any of this, press any key within 10 seconds.</pre>
<p>Press Enter to modify settings.</p>	<pre>(M)odify any of this or (C)ontinue? [M]</pre>
<p>Press Enter to configure a LAN interface.</p>	<pre>For each of the following questions, you can press <Return> to select the value shown in braces, or you can enter a new value. NETWORK INTERFACE PARAMETERS: Do you want a LAN interface? [Y]</pre>

Instructions	Text entered and displayed in terminal window
Type the IP address for this RAID Controller, then press Enter . NOTE: RAID Controller A and the optional RAID Controller B must use different IP addresses. Also, the subnet must match the Profile XP subnet unless a gateway is used.	IP address(0.0.0.0 = RARP, 255.255.255.255 = DHCP/BOOTP)? [192.168.0.11] <enter your IP address>
Type the subnet mask value, then press Enter .	Subnet mask for LAN (0 for none)? [255.255.255.0] 255.255.255.0
If a gateway is used, type y, then press Enter , to provide a Gateway address, otherwise, just press Enter to continue.	Should there be a default gateway for packet routing? [N]
Press Enter to accept defaults.	COMMUNICATION PARAMETERS: Baud rate for serial channels [9600]
Press Enter to accept defaults.	APPLICATION PARAMETERS: Boot Choices: [1]Factory Flash Loader or [2]Ciprico Network Server Your Choice (1 or 2)? [2]
Type 1, then press Enter . [NOTE: The default value may appear different than shown here.]	Mail and SNMP notification level: 1 (most verbose) through 5 (off)? [2] 1
Press Enter .	Modify User Password? [N]
Type y, then press Enter .	Modify SNMP Trap Information? [N] y
Type public, then press Enter .	Trap Community Name? [] public
Type the Profile XP IP address, then press Enter. Add additional trap destinations, if needed (up to four total), or press Enter a number of times to advance to the next step— Modify SNMP MIB Communities. NOTE: You can enter the factory default IP address for your Profile XP system (192.168.0.10) unless you are modifying it for an existing network.	You may enter up to 4 Hosts to receive Traps sent by this device Enter Trap Manager #1 IP Address? [0.0.0.0] 192.168.0.10 Enter Trap Manager #2 IP Address? [0.0.0.0] Enter Trap Manager #3 IP Address? [0.0.0.0] Enter Trap Manager #4 IP Address? [0.0.0.0]
Press Enter .	Modify SNMP MIB Communities? [N]
Press Enter .	Modify Mail parameters? [N]



Set up PFR500 or PFR600 network settings

Instructions	Text entered and displayed in terminal window
Press Enter to accept defaults. NOTE: Default value may appear different than shown here.	How long (in seconds) should CPU delay before starting up? [10]
RAID controller configuration is displayed showing your settings.	NETWORK INTERFACE PARAMETERS: IP address on LAN is 192.168.0.11 LAN interface's subnet mask is 255.255.255.0 COMMUNICATION PARAMETERS: Serial channels will use a baud rate of 9600 HARDWARE PARAMETERS: This board's MAC Address is 0:20:46:11:14:23 APPLICATION PARAMETERS: Boot Ciprico Network Server Mail and SNMP notification will occur for Hardware changes, Warnings, and Critical events. SNMP TRAP CONFIGURATION: TRAP COMMUNITY NAME 'public' TRAP MANAGER #1 IP Address 192.168.0.10 After board is reset, start-up code will wait 10 seconds
Type c , then press Enter .	(M)odify any of this or (C)ontinue? [M] c
Wait for non-volatile storage update.	Updating non-volatile storage. This may take a while...Done
Wait for initialization. NOTE: If the network cable is not connected, the console stops at the message "Waiting for Ethernet Link...". If you cannot connect network cabling at this time, cycle the power on the PFR500 Controller chassis, then continue with this procedure.	Initializing Enclosure Services Interface.....Done

Instructions	Text entered and displayed in terminal window
<p>Wait for reboot, plus 10 seconds, to allow the Enclosure Services Interface initialization to start.</p>	<pre>Rebooting now for new system parameters to take effect Ciprico Web Manager Copyright Ciprico Inc. 2000 ----- NETWORK INTERFACE PARAMETERS: IP address on LAN is 192.168.0.11 LAN interface's subnet mask is 255.255.255.0 COMMUNICATION PARAMETERS: Serial channels will use a baud rate of 9600 HARDWARE PARAMETERS: This board's MAC Address is 0:20:46:11:15:81 APPLICATION PARAMETERS: Boot Ciprico Network Server Mail and SNMP notification will occur for Warnings and Critical events. SNMP TRAP CONFIGURATION: TRAP COMMUNITY NAME 'public' TRAP MANAGER #1 IP Address 192.168.0.10 After board is reset, start-up code will wait 10 seconds ----- To change any of this, press any key within 10 seconds</pre>
<p>Wait for initialization, then proceed to step 3 of this procedure.</p> <p>NOTE: If the network cable is not connected, the console stops at the message "Waiting for Ethernet Link...". If you cannot connect network cabling at this time, cycle the power on the RAID Controller chassis, then proceed to step 3 following this table. You will not be able to monitor your RAID chassis with NetCentral, or update its firmware.</p>	<pre>Initializing Enclosure Services Interface.....Done Started Monitor Started SNMP Agent Started FTP Flash Loader Started Web Server Started Telnet Server ***** * Ciprico Web Manager Network Server * * Revision: 2.3.7 * * Compiled: 01/23/02 00:28:24 CST * ***** Ciprico#</pre>

3. If the optional RAID Controller B is installed, perform the following steps, otherwise, proceed to step 4.
 - a. Move the standard serial cable connector to the daisy chain cable connected to RAID Controller B.
 - b. Repeat the instructions for modifying network and SNMP settings in step 2 of this procedure.
4. Exit Hyperterminal.

Now that the RAID controller network and SNMP settings are configured, you can proceed to "Start NetCentral Lite monitoring software" on page 33.



7

Set up PFR 700 network settings

This procedure explains how to modify factory default PFR 700 network and SNMP settings for monitoring with NetCentral Lite or NetCentral Manager. This step is not required for PFC 500 RAID storage systems.

NOTE: *Disregard this step if you are connecting one Profile XP Platform and PFC 500 RAID storage system to a network using factory default network settings. Proceed to “Start NetCentral Lite monitoring software” on page 33.*

Refer to the *Profile XP Service Manual* for information on using NetCentral Lite.

Configuring PFR 700 network and SNMP settings

Network and SNMP settings are set and stored on the LAN card. Therefore the PFR 700 RAID chassis, including its one or two RAID controllers, is a single networked device. This is different than other PFR series RAID devices in which each controller is a networked device.

You can use the GVG Disk Utility to configure the following settings for the PFR 700 RAID chassis:

- IP address
- Subnet mask
- Gateway Address
- SNMP trap destinations

To configure these settings, do the following:

1. In the GVG Disk Utility, right-click the icon for a PFR 700 controller and select **Set Network Properties**. The Controller Network Settings dialog box opens.



Controller Network Settings

Network Configuration

IP Address: 10 . 16 . 38 . 157

Subnet Mask: 255 . 255 . 252 . 0

Gateway Address: 10 . 16 . 36 . 1

SNMP Configuration

Trap Address 1: 10 . 16 . 38 . 143

Trap Address 2: 10 . 16 . 38 . 51

Trap Address 3: 0 . 0 . 0 . 0

OK Cancel

2. Enter network settings for the RAID chassis.
3. For each SNMP manager to which you want to send SNMP trap messages, enter the IP address of the PC hosting the manager. If you are monitoring the PFR 700/E with your NetCentral Lite on your Profile XP Media Platform, enter its IP address. If you are monitoring the PFR 700/E with NetCentral, enter the IP address of the NetCentral server (NetCentral 4.x and higher) or NetCentral monitoring station (NetCentral 3.x and lower).
4. Click **OK** to save settings and close.

Now that the RAID controller network and SNMP settings are configured, you can proceed to “Start NetCentral Lite monitoring software” on page 33.

8 Start NetCentral Lite monitoring software

NetCentral Lite monitoring software is installed and preconfigured to run on your Profile XP Media Platform to monitor system status. Using NetCentral Lite, you can check status information for all major subsystems in the Profile XP Media Platform and receive alert messages when a subsystem is operating at reduced capacity or is no longer functioning.



Since the Profile XP network and SNMP settings are preconfigured at the factory, you can start NetCentral now to begin monitoring your Profile XP's subsystems.

NOTE: *If you are connecting your Profile XP system to a network, and need to reconfigure network settings, you must refer to the NetCentral Lite setup instructions in the Profile XP Service Manual to reconfigure SNMP settings.*

Starting NetCentral Lite on the Profile XP system

Use the following steps to start NetCentral Lite and begin monitoring the Profile XP Media Platform.

To start NetCentral Lite:

1. Click **Start | Programs | NetCentral | NetCentral Lite**. After NetCentral Lite starts, the NetCentral icon  is displayed in the system tray of your Windows task bar. The moving block in the icon provides visual confirmation that the system is operational, using these colors to indicate device status level:
Green = Normal; Red = Warning; Red = Alarm/Dead or Off-line
2. Double click the NetCentral icon  in the system tray to display the NetCentral window. Refer to the *Profile XP Service Manual* for information on using NetCentral Lite monitoring software.

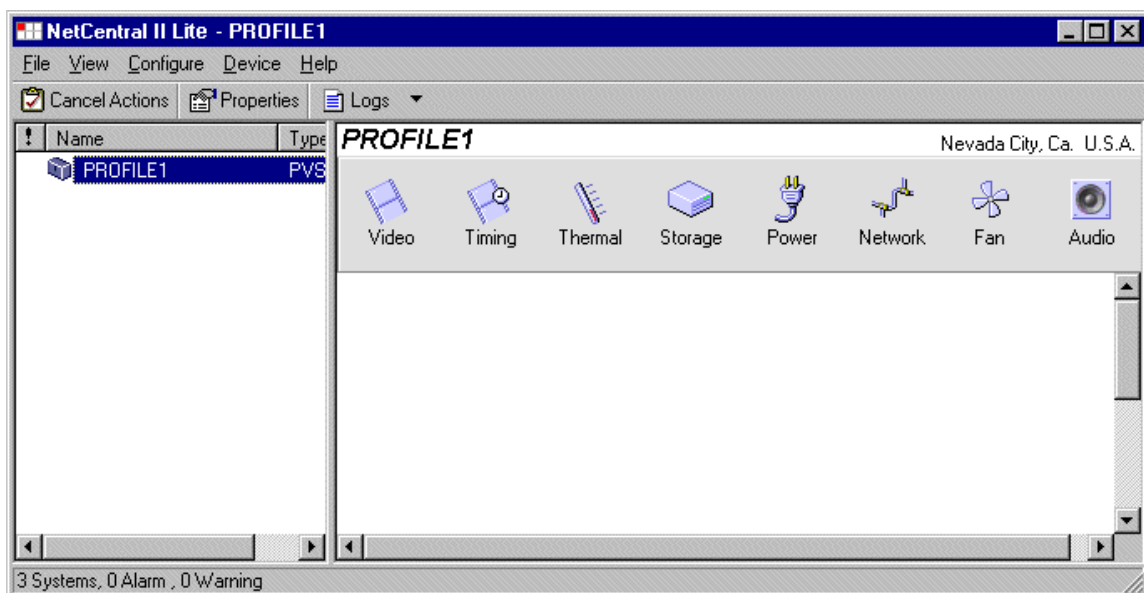



Adding the PFR 500, PFR 600 or PFR 700 RAID storage device

This procedure explains how to add the PFR 500, PFR 600 PFR 700 Fibre Channel RAID Chassis to the NetCentral device list. This step is required in order to monitor the RAID chassis.

NOTE: This step is not required for the PFC500 Fibre Channel RAID Chassis since it is monitored in-band through the Profile XP Fibre Channel connection.

To add the PFR 500, PFR 600 PFR 700 RAID storage chassis to the device list:

1. In the NetCentral main menu, click **File | Add Device**.
2. In the Add Device dialog box, enter the IP address or host name for RAID Controller A, then click **OK**. You can use the following default address if you have not modified network settings: controller A = 192.168.0.11.

NetCentral contacts RAID Controller A, and adds it to the device list. The RAID Controller is labeled using the controller IP address or the host name if network name resolution is setup for the Profile XP system. (Refer to “Setting up a simple network” in the *Profile XP System Guide*.)

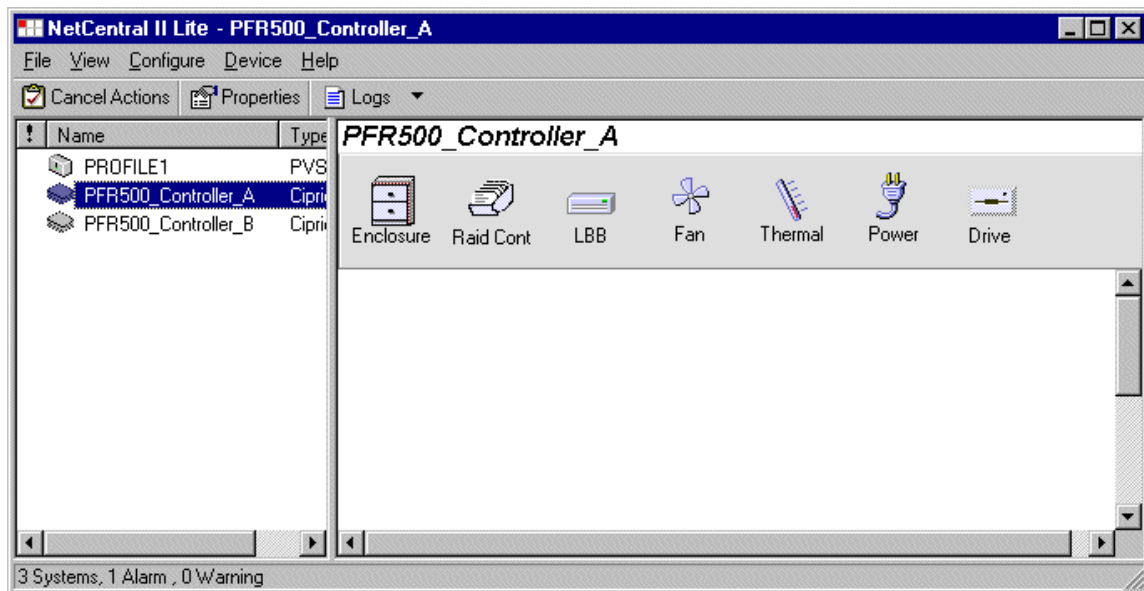

3. Repeat step 1 and step 2 for RAID Controller B, if installed. You can use the following default address if you have not modified network settings: controller B = 192.168.0.12.
4. Refer to the *Profile XP Service Manual* for information on using NetCentral Lite monitoring software.

9 Select audio I/O format

You must select the audio I/O format for the audio channels assigned to the default video channels.

The PVS 1100 supports three audio I/O formats: AES/EBU, embedded audio (SMPTE 272M Level A), and analog audio formats. An interface chassis is required for analog audio and AES/EBU digital audio. If you are using only embedded audio, no interface chassis is required.

Select audio input format

To select audio input format:

1. Click **Audio Routing** in the Configuration Manager window. The Audio Input Routing dialog box appears.

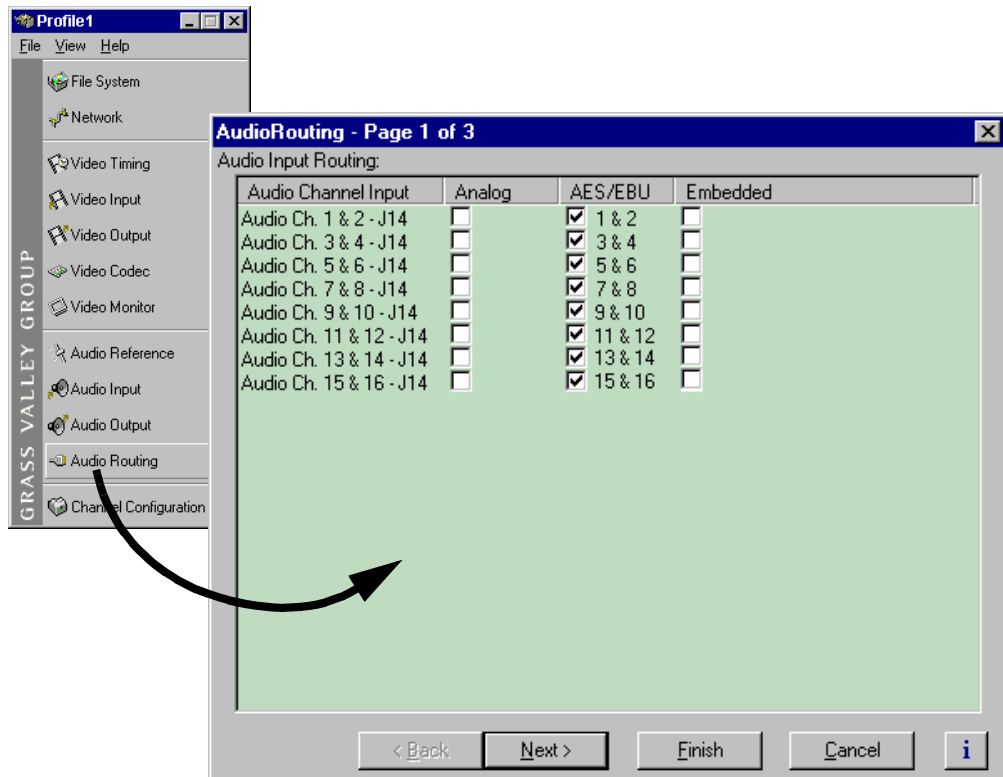

2. Select the audio input format for each PVS 1100 audio channel pair.



3. If you selected embedded audio format, perform the following steps for each audio channel input pair requiring embedded audio:
 - a. Click the left-hand drop-down list arrow in the Embedded column for the channel pair you want to configure, and select a video input as shown.

NOTE: With one audio board, only the first 4 video inputs are selectable.

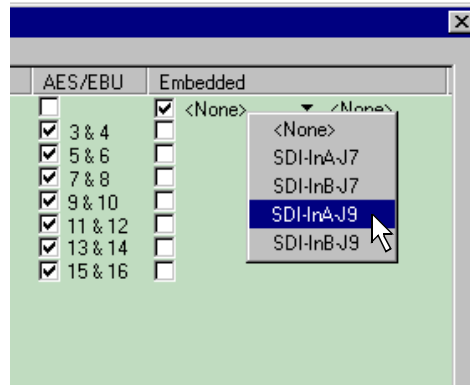

- b. Click the right-hand drop-down list arrow in the Embedded column for the channel pair you want to configure, and select an audio group and channel pair as shown.

NOTE: Up to two audio groups (8 audio channels) can be extracted from a single video input.

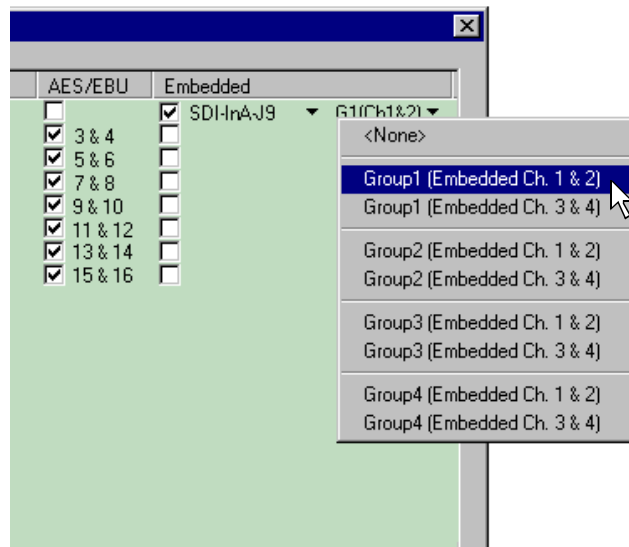

Select audio output format

To select audio output format:

1. Click **Next** to navigate to Page 2 of the Audio Output Routing dialog box as shown.

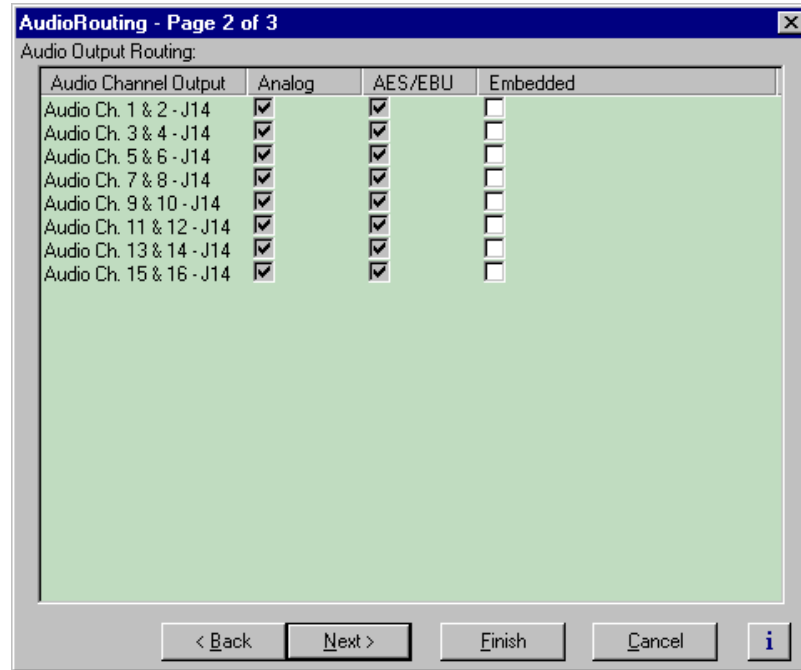

2. For AES/EBU or Analog audio, no selection is required. These audio formats are selected automatically when the system sees the audio interface is attached.
3. Select embedded audio output using the following steps:
 - a. For embedded audio, select the **Embedded** check box for each audio channel pair that require embedded audio.
 - b. Click the left-hand drop-down list arrow in the **Embedded** column for the channel pair you want to configure, and select a video output as shown.

NOTE: With one audio board, only the first 4 video outputs are selectable.

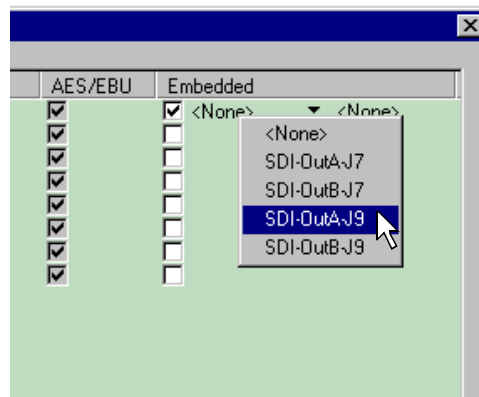



- c. Click the right-hand drop-down list arrow in the **Embedded** column for the channel pair you want to configure, and select an audio group and channel pair as shown.

NOTE: Up to two audio groups (8 audio channels) can be embedded on a single video output. With one audio board, only the first 4 video outputs are selectable, since embedded audio can only be allocated by groups of 4 channels. With two audio boards, up to 8 video outputs are selectable. In some cases (two audio boards and either three 2In/2Out boards or one 2In/2Out and one 4Out board), you may have to select embedded audio outputs first, then select the audio inputs for each audio board to be able to select all the desired embedded outputs.

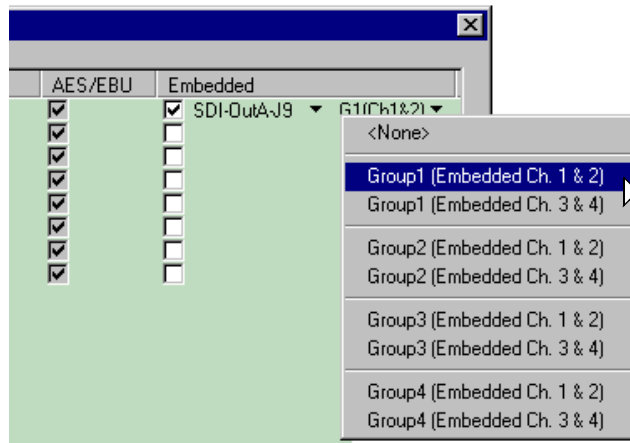

4. Click **Finish** to save your settings.
5. Continue with the next procedure in this guide to test your system setup.

10 Test your system setup using VdrPanel

In this step, you will use VdrPanel in local control to test the record and play channels. This procedure assumes you have video and audio signals connected to the inputs of all record channels and have a way of monitoring the video, audio, and timecode outputs.

In systems without record channels you must use the video network to transfer a clip from another Profile. (See “Using Media Manager” in the *Profile XP User Manual*).

To test PVS1100 channels using VdrPanel:

1. Start VdrPanel using the desktop shortcut or by selecting **Start | Programs | Profile Applications | VdrPanel**. The VdrPanel window appears.

NOTE: The first time VdrPanel runs, a panel opens for each default record and play channel. The number of default channels depends on your PVS1100 model. Refer to “Default Video Connections” on page 7.

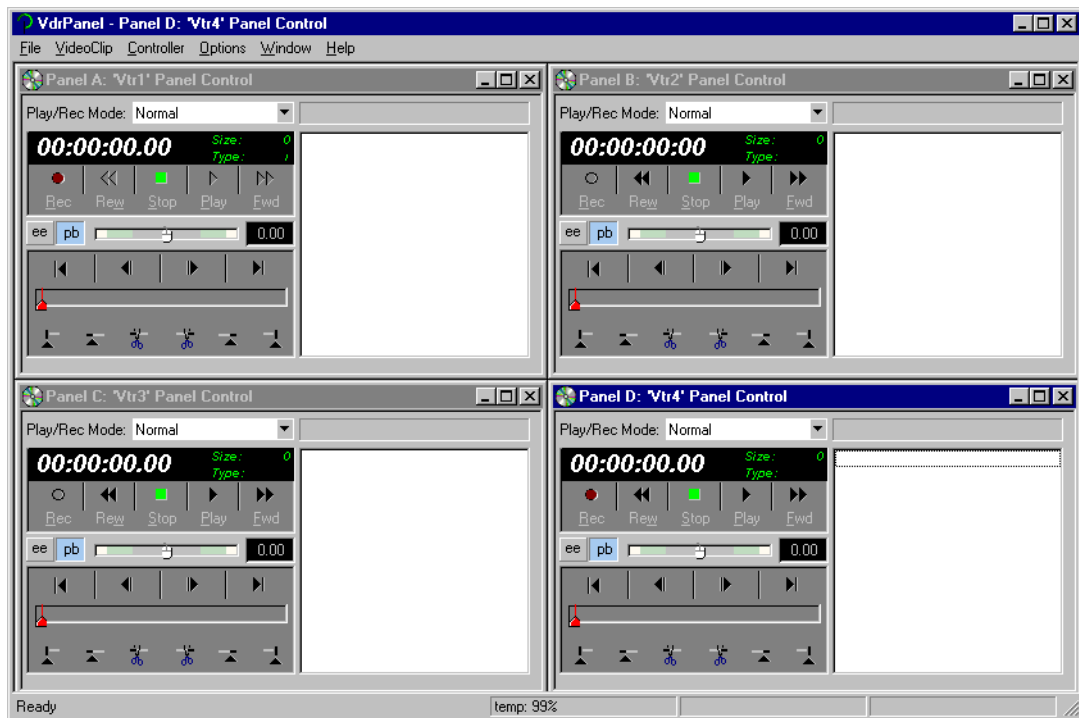

2. Record a short clip, a few seconds in duration as follows:
 - a. Click the **Record** button in the panel for a record channel. Recording starts. The **Size** display indicates compressed frame sizes during record as timecode advances in the Timecode display.
 - b. Click the **Stop** button to end the recording. Notice the clip name in the clip list is #1.



3. Load and play a clip on each Play Channel as follows:
 - a. Click anywhere in the panel for a Play Channel.
 - b. Select **VideoClip | Load Clip** to open the Load Clip dialog box.
 - c. Select clip #1 in the clip list, then click **OK** to load the clip.
 - d. Click **Play** and verify that video, audio are present at the channel outputs. If you have a problem, refer to the Chapter 10, "Solving Common Setup Problems" in the *Profile XP System Guide*.
4. Use steps 2 and 3 to test all record and play channels.
5. Continue with the next procedure in this guide to adjust video timing.

11 Adjust video output timing

All playback channels are zero timed by default. However, video output timing adjustment is provided to meet downstream timing requirements if needed. In this procedure you will load a clip and verify the output timing for each play channel.

To adjust video output timing:

1. In VdrPanel, load and playback a clip as follows:
 - a. Click anywhere in the panel for the first Play Channel.
 - b. Select **Video Clip | Load Clip** to open the Load Clip dialog box.
 - c. Select a clip to load, then click **OK**.

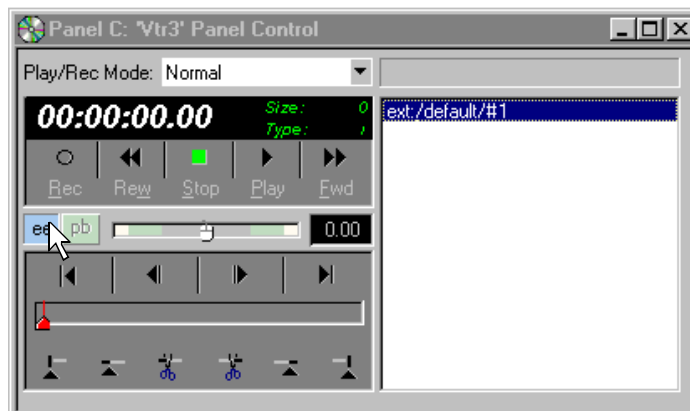

- d. Click the **ee** (**ee**) button in the panel.
 - e. Repeat step a through step d for all Play channels.



2. Select **Video Timing** in the Configuration Manager window. Page 1 of the Video Timing dialog box appears.
3. Click **Next** to navigate to page 2 of 3.

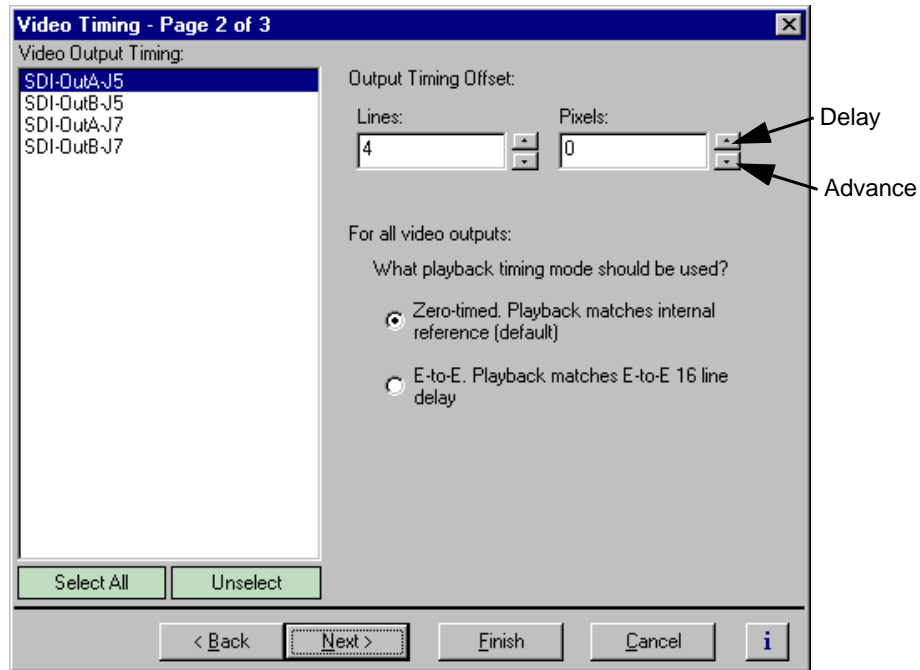

4. Select the video output from the list, then adjust the video output timing with the timing controls.

NOTE: Use the **Select All** button to enter the same offset for all video outputs.

5. Repeat step 4 for each video output.
6. Click **Finish** to save you settings.
7. Continue with the next procedure in this guide to select RS-422 control protocol.

12 Select an RS-422 control protocol

PVS 1100 remote control protocols are shown in the table. Follow the procedure indicated for the remote control protocol you want to use. If you are not using RS-422 control, you can skip this step

Protocols Available	Application to Use	Procedure to Follow
VDCP Control Odetics Protocol BVW Protocol	VdrPanel	Setting up RS-422 remote control in VdrPanel
Profile Protocol	Prolink	Setting up RS-422 remote control using Prolink (Profile protocol)

NOTE: Some third-party applications also support the General Purpose Interface (GPI). Refer to your vendor's documentation for instructions on using GPI triggers.

Setting up RS-422 remote control in VdrPanel

To setup a VdrPanel for remote control:

1. If VdrPanel is not already running, start it using the desktop shortcut or by selecting **Start | Programs | Profile Applications | VdrPanel**. The VdrPanel window appears.
2. In VdrPanel, click in the panel you want to set up for remote control.
3. Choose **Controller | Configure** to open the Channel Configuration dialog box, then select a control protocol using the **Protocol** drop-down list as shown.





4. Select a serial port using the port select drop-down list as shown. COM1 and COM2 are RS-232 ports on the PVS 1100 rear panel. P1 through P8 are RS-422 ports on the I/O Panel.

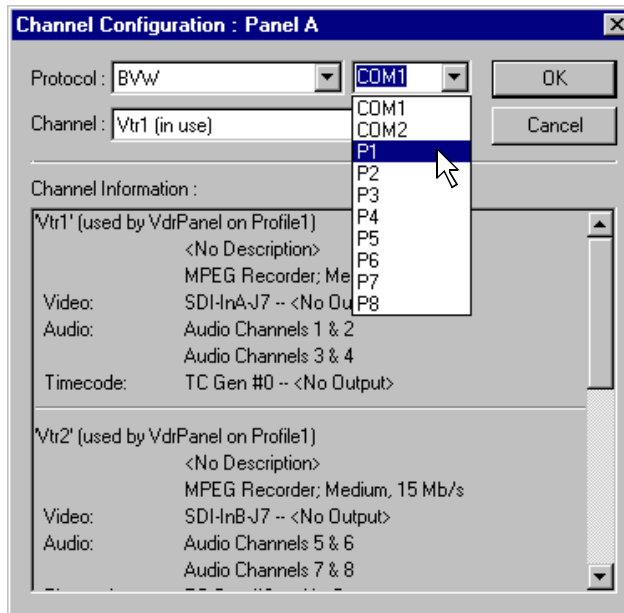

5. Click **OK** in the Channel Configuration dialog box.
6. Repeat step 2 through step 5 for the remaining panels.
7. Test the system using your automation controller.

This completes all the procedures in this *Installation Guide*. Refer to the *Profile XP System Guide* for more information on customizing settings for your application.

Setting up RS-422 remote control using Prolink (Profile protocol)

Use this procedure to start and set up Prolink to control the PVS 1100 using Profile protocol.

1. Close VdrPanel if you used it earlier to test your record and play channels.
2. Open Prolink using the shortcut on the desktop or by selecting **Start | Programs | Profile Applications | Prolink**.
3. Select an RS-422 serial port, then click **Select**. The Prolink window appears.

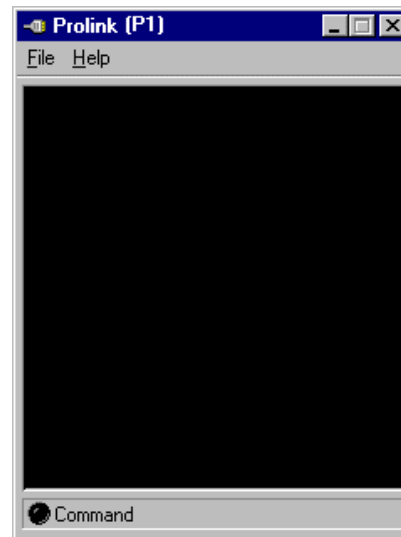
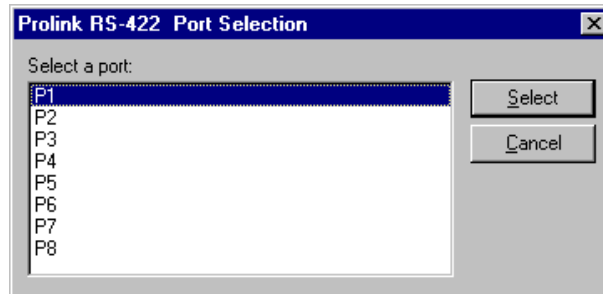

4. Test the PVS 1100 system using your controller.
5. Repeat steps 2-4 for the number of control ports you need to control the PVS 1100 using Profile protocol.

NOTE: For more information on the Prolink user interface see Chapter 8, "Controlling the Profile XP Remotely" in the Profile XP System Guide.

This completes all the procedures in this *Installation Guide*. Refer to the *Profile XP System Guide* for more information on customizing settings for your application.



Select an RS-422 control protocol

Grass Valley Product Support

To get technical assistance, check on the status of problems, or report new problems, contact Grass Valley Product Support via e-mail, the Web, or by phone or fax.

Web Technical Support

To access support information on the Web, visit the product support Web page on the Grass Valley Web site. You can download software or find solutions to problems by searching our Frequently Asked Questions (FAQ) database.

World Wide Web: <http://www.thomsongrassvalley.com/support/>

Technical Support E-mail Address: gvgtechsupport@thomson.net

Phone Support

Use the following information to contact product support by phone during business hours. Afterhours phone support is available for warranty and contract customers.

United States	(800) 547-8949 (Toll Free)	France	+33 (1) 34 20 77 77
Latin America	(800) 547-8949 (Toll Free)	Germany	+49 6155 870 606
Eastern Europe	+49 6155 870 606	Greece	+33 (1) 34 20 77 77
Southern Europe	+33 (1) 34 20 77 77	Hong Kong	+852 2531 3058
Middle East	+33 (1) 34 20 77 77	Italy	+39 06 8720351
Australia	+61 3 9721 3737	Netherlands	+31 35 6238421
Belgium	+32 2 3349031	Poland	+49 6155 870 606
Brazil	+55 11 5509 3440	Russia	+49 6155 870 606
Canada	(800) 547-8949 (Toll Free)	Singapore	+656379 1390
China	+86 106615 9450	Spain	+ 34 91 512 03 50
Denmark	+45 45968800	Sweden	+46 87680705
Dubai	+ 971 4 299 64 40	Switzerland	+41 (1) 487 80 02
Finland	+35 9 68284600	UK	+44 870 903 2022

Authorized Support Representative

A local authorized support representative may be available in your country. To locate the support representative for your country, visit the product support Web page on the Grass Valley Web site.

Profile Users Group

You can connect with other Profile XP Media Platform users to ask questions or share advice, tips, and hints. Send e-mail to profile-users@thomson.net to join the community and benefit from the experience of others.

