



KAYENNE/KARRERA/ GV KORONA

GV K-FRAME XP

Video Production Center

User Manual

VERSION 15.0

076159301-AA

2020-10-12

www.grassvalley.com

Patent Information

This product may be protected by one or more patents.

For further information, please visit: www.grassvalley.com/patents/

Copyright and Trademark Notice

Grass Valley®, GV® and the Grass Valley logo and/or any of the Grass Valley products listed in this document are trademarks or registered trademarks of GVBB Holdings SARL, Grass Valley USA, LLC, or one of its affiliates or subsidiaries. All other intellectual property rights are owned by GVBB Holdings SARL, Grass Valley USA, LLC, or one of its affiliates or subsidiaries. All third party intellectual property rights (including logos or icons) remain the property of their respective owners.

Copyright © 2020 GVBB Holdings SARL and Grass Valley USA, LLC. All rights reserved.

Specifications are subject to change without notice.

Terms and Conditions

Please read the following terms and conditions carefully. By using the GV K-Frame XP documentation, you agree to the following terms and conditions.

Grass Valley hereby grants permission and license to owners of the GV K-Frame XP to use their product manuals for their own internal business use. Manuals for Grass Valley products may not be reproduced or transmitted in any form or by any means, electronic or mechanical, including photocopying and recording, for any purpose unless specifically authorized in writing by Grass Valley.

A Grass Valley manual may have been revised to reflect changes made to the product during its manufacturing life. Thus, different versions of a manual may exist for any given product. Care should be taken to ensure that one obtains the proper manual version for a specific product serial number.

Information in this document is subject to change without notice and does not represent a commitment on the part of Grass Valley.

Warranty information is available from the Legal Terms and Conditions section of Grass Valley's website (www.grassvalley.com).

Title	Kayenne/Karrera/GV Korona User Manual
Part Number	076159301-AA
Revision	2020-10-12

toc

Table of Contents

Patent Information	ii
Copyright and Trademark Notice.....	ii
1 Introduction	xvii
Overview.....	xvii
Features.....	xvii
General	xvii
K-Frame Standard Frame	xviii
K-Frame Compact Frame	xix
K-Frame Compact S-series Frame	xix
K-Frame V-series Frame.....	xix
GV K-Frame X Standard Frame	xx
GV K-Frame XP Compact Frame.....	xx
K-Frame Control Surfaces	xx
Kayenne Control Surface	xx
Flat or Curved Control Panel Orientation	xxii
Control Panel Stripes	xxii
Touch Screen Menu Panel	xxii
Basic Single Suite Kayenne Panel System	xxiii
Multiple Suite Kayenne Panel System Example	xxiii
Karrera Control Surface	xxv
Basic Single Suite Karrera Panel System	xxvi
GV Korona Control Surfaces.....	xxvii
Basic Single Suite GV Korona Panel System Example.....	xxvii
Multiple Suites and Control Surfaces Example	xxvii
Supported Control Protocols	xxviii
2 Documentation & Media	17
About this Manual.....	17
Standard Documentation Set	17
Other Documentation	17
Video Tutorials & Training	18
3 Panel Preferences	19
Panel Preference Settings.....	19
About Control Panel Default Button Mapping	19
Map Control Panel Source Select Buttons	21
Assign a Control Panel Color Scheme	21
Assign Control Panel Source Colors	22
Map Remote Aux Panel Sources to the Control Panel	24

Map Remote Aux Panel Delegation Buttons (Logical Mapping).....25

4 Suite Preferences 27

Suite Preference Settings27
 About Suite Resources.....27
 Aux Bus Transitions.....27
 About Suite Signal Type—HDR Mode27
 About Re-Entry29
 About Source Patching29
 Engineering Names, Eng IDs, and Logical IDs31
 Alternative Source Names31
 Multiple Suites and Source Names31
 Source Name Display Hierarchy31
 Source Patching and Effects Portability.....32
 Patch Engineering and Fixed Sources to Logical IDs33
 Patch a Key Input from Another Source34
 About Default Keyframe35
 About the Preview Prefs Menu.....36
 About File Operations37
 Introduction38
 About the File Ops Menus39
 GV Switcher File Type Extensions40
 About Show Files.....41
 About the File Ops, All Files Menu.....46
 Save User Setups47
 Load User Setups.....48
 Save Source Tables or Source Rules49
 Load Source Tables or Source Rules50
 About Register-Based File Ops Menus.....50
 Save Eng Setups.....54
 Load User Setups.....54

5 Video Mix/Effects 57

M/Es and Keyers.....57
 Chroma Key.....58
 Chroma Key Auto Setup58
 Manual Chroma Key Adjustments.....58
 Primary Suppression.....59
 Extra Chroma Key Controls60
 Configure Auto Setup61
 Reshape a Chroma Key Using Auto Setup62
 Adjust Chroma Key Controls62
 Apply Chroma Key Secondary Color Suppression63
 Generate Background Mattes65
 Split a Key.....66
 Set Keyer Priority67
 Transition Between Different Keyer Priorities67
 About Key Store.....68

Set a Pattern Mix	70
Source Memory	71
About Acquiring DPMs	74
Acquire an M/E Resource for eDPM	75
Release/Acquire DPM Resources between eDPMs/iDPMs	75
Enable/Delegate DPM Channels	76
Enable iDPMs on a Karrera Control Panel	77
Delegate eDPM Channels	77
Enable a 2D DPM on a Keyer	77
Enable DPMs from the Menu	77
iDPMs	78
2D DPMs	79
Kayenne (only) Parameter and Soft Knob Controls	79
DPM Source and Target Space Explained	80
Tally and DPMs	80
DPM Transform Menu	80
Enable DPM Transforms in the Menu	80
DPM Global Channel Assignments	80
Key Off Control	82
Easy Cube Control	83
Transform Controls	83
Crop Controls	83
Reverse Controls	83
Path Controls	83
Clear Transforms	84
Border Menu	84
DPM Borderline Menu	84
Shadow Controls	85
iDPM Shadow Crop Controls	85
Glow Pane Controls	85
Glow Color	86
Glow Path Control Pane	86
iDPM/2D DPM Film Look Menus	87
iDPM Kurl Menu	87
Kurl Position/Size Modulation Mode	87
Modulation Pane	87
Mod Type Pane	88
Pattern Pane	88
Page Turn/Roll Mode	88
Page Turn Pane	89
Show Sides Pane	89
Ripple Mode	89
Slits Mode	90
Sphere Mode	90
DPM Splits Mirrors Menu	91
Splits Pane	91
Splits & Mirrors Modifiers Pane	91
DPM Defocus Menu	91
Defocus Pane	91
NAM Matte Pane	92

DPM Lighting Menu	92
Shadow Control Pane	92
Light Type Pane	92
Light Type	93
Light Control Pane	93
Lighting Path Controls.....	94
Lighting with Page Turn/Roll Effects	94
Lighting and Post Transform Space	94
Output Recursive Menu.....	94
Output Recursive Presets	94
Output Recursive Modes.....	94
Motion Decay Mode.....	95
Freeze Mode	95
Montage Mode.....	96
Trails Mode	97
DPM Global Channel Control Over Multiple M/Es	98
Set Up a DPM Secondary Global Channel.....	99
Adjust iDPM/2D DPM Border Edges	99
iDPM/2D DPM Border Color.....	99
Adjust iDPM/2D DPM Border Edges	100
eDPMs	100
eDPM and Effects.....	100
eDPM Partitioning.....	101
eDPM Definable Sub-levels	102
Assign Sources	103
Button Mapping eDPMs to an M/E	104
eDPM Mode Menus	104
eDPM Effects Menus.....	104
eDPM Category Menus	104
File Ops Menu.....	105
E-MEM & Timeline Menu.....	105
Source Ops Menu	106
Picture Menu.....	106

6 Switcher Control 109

Basic E-MEM Operations	109
Time Value Entry	109
Learning E-MEM Registers from the Control Panel	110
Learn a Register in the Current Bank	110
Learn a Register to a Different Bank	110
Copying E-MEM Timeline Information with Get and Put.....	110
Recalling E-MEM Registers from the Control Panel.....	111
GV Korona E-MEM Run from the Control Panel	111
Clearing E-MEM Registers.....	112
Running an E-MEM Effect with Auto Run	113
Learn a Sequence of E-MEM Registers	113
Play a Sequence of E-MEM Registers:.....	113
Break a Sequence:.....	113
Advanced E-MEM Operations: Partial Keyframe/Define E-MEM Settings	114

Macros	114
About Multiple Macros and Player Groups.....	115
Macro Control Menu	116
Macro Recording	117
Macro Playback	118
About Playing a Macro from the Control Menu (Important)	118
Macro Attachments	118
“Disabled” is the Default for the Macro Attachable Control Panel Preference..	119
Macro Attachments and Importing Show Files.....	119
Kayenne Macro Operations	119
Record a Macro.....	120
Insert a Macro Delay	120
Insert a Macro User Pause.....	121
Playback a Macro Register	122
Pre-Attach a Macro	122
Post-Attach a Macro	122
Attach Multiple Macros to the Same Button	122
Delete a Macro Attachment.....	123
Append to a Macro	123
Karrera Macro Operations.....	123
Macro Control Button Group.....	123
Macro Button Function Summary	124
Record a Macro.....	124
Insert a Macro Delay	124
Insert a Macro User Pause.....	125
Recall a Macro Register from the Master E-MEM	126
Pre-Attach a Macro	126
Post-Attach a Macro	126
Attach Multiple Macros to the Same Button	126
Remove a Macro Attachment	126
Append to a Macro	127
GV Korona Macro Operations	127
Status Display in Macro Mode.....	127
Record a Macro.....	128
Insert a Macro Delay	128
Insert a Macro User Pause.....	128
Run a Macro.....	129
Pre-Attach a Macro	130
Post-Attach a Macro	130
Attach Multiple Macros to the Same Button	130
Remove a Macro Attachment	130
Append to a Macro	131
Performing Macro Operations from the Menu	131
Recording a Macro	131
Enter a Macro Panel Name	132
Insert a Macro Delay	132
Insert a Macro User Pause from the Catalog Menu	133
Insert a Macro User Pause from the Macro Editor	134
Learn a Run From Pause E-MEM Command.....	135
Learn a Select E-MEM Command.....	136

Attaching a Macro	137
Playing an Attached Macro	137
Appending to a Macro	137
Appending a Macro to Another Macro in the Menu	138
Saving Macro Registers	138
Loading Macro Registers	138
Macros for Multiple Copies or Swaps	138
Macros and E-MEMs	139
E-MEM Recalls in a Macro	139
Learn a Run From Pause E-MEM Command	140
Learn a Select E-MEM Command	141
Source Select Button Row Mode Delegation	141
Delegate a Switcher Mode to a Source Select Button Row	142
Source Select Button Row to Aux Mode Delegation	142
Panel Memory and P-MEM Registers	143
Learn a Kayenne P-MEM Register	143
Recall a Kayenne P-MEM Register	144
Learn a Karrera/GV Korona P-MEM Register	144
Recall a Karrera/GV Korona P-MEM Register	144
Panel Memory Default Setting	144
GV Korona M/E Background Button Row Delegation	145
Change Background Buses with Panel Memes	146
Source Rules	146
Create a Source Rules Pattern	147
Store a Source Rules Pattern	147
Apply a Source Rules Pattern to other Sources	148
Source Rules Hold	148
Bus Linking	148
Bus Linking Examples	148
Bus Linking Menu	149
Bus Linking Source Substitution Tables	150
Linked Source Buttons	150
Configuring a Source Table with Source Substitutions	151
Storing (Copying) Source Table Substitutions to another Source Table	151
Changing Source Tables for a Bus Link	152
Source Table File Operations	152
Linking Buses one-to-one	152
Creating Parallel Bus Links	153
Creating Cascading Bus Links	154
Bus Linking Rules and Restrictions	155
Bus Linking Management	156
7 Switching Basics	157
Basic Switcher Control Surfaces	157
Kayenne Control Panel Overview	157
Setting Panel Saver Mode	158
Module Overview	159
Transition Module	159
Local E-MEM Module	162

Master E-MEM Module	164
Multi-Function Module	165
Source Select Module	167
Local Aux Module	171
System Bar	172
Device Control Module	174
Kayenne Delegation	176
Automatic Delegation	177
Menu Panel and Touch Screen Overview	179
Touch Screen	179
Menu Selection	179
Soft Knobs	180
Data Pads and Touch Buttons	180
GV Korona Menu and Joystick Control	181
Menu Screen Organization and Components	181
History Mode	184
Favorites Mode	185
Creating a Last Menu Assignment in Favorites Mode	186
Quick Tabs	186
Delegation Group	187
Parameter Control Area	188
Numeric Keypad	188
Alphanumeric Keypad	189
Scrolling Lists	189
Menu and Panel Interactions	190
Transitions	191
Wipes	191
Kayenne Transition Module	192
Perform a Mix Through Video Transition	194
Aux Bus Transitions	195
Trans Lock Button	196
Setting Wipe Transition Parameters	197
Allocating Resources and Setting up the Transition	197
Perform Aux Bus Transitions	198

8 Device Control 199

About Device Control	199
About Menu Application Device Control	199
Enables Menu	200
Timeline Events Menu	200
ChyronHego® Click Effects PRIME® and LyricX®	203
About ChyronHego® Click Effects and Lyric Workflow and Layering	204
Control Menu	205
Event List Menu	206
Clip Loading	209
Clip Directory (AMP Protocol)	209
Timeline Event Information and Work Buffer Values	210
Prepare the External Device for Control	210
Control an External Device (Example)	211

Control an External Device Using Timeline Events and E-MEM.	212
Play a Video and Key Pair of Sources in Sync from an External Device.	213
Load a Clip to Play On Air Later with Auto Start	213
Build an Event List	214
About E-MEM Control of External Devices	215
RossTalk XPression Device Control	216
Configure an External Device for XPression Control	217
Take XPression IDs from an External Device	217
Using Extended GFX XPression Controls.	218
Fire XPression GPI Sets.	219
Kayenne Device Control from the Control Panel	220
System Bar	221
Local Aux Module	221
About Multi-Function Module Device Control	223
Device Control Module	228
About Gangs	229
About Q-MEMs.	230
Learn a Q-MEM Register with a Single Device.	231
Learning a Q-MEM Register with Multiple Devices	231
Learning Additional Devices	232
Learn Device Associations (only) into a Register	232
Learning Clips for Devices without Affecting Letter Button Associations.	233
About Cues and Ganging	233
Status Display	233
Karrera Device Control.	234
Device Control with GV Korona	235
Select the Device to Control	236
Delegate a Source for Device Control	236
Router Interface Operation	237
Features	238
Menu Panel Router Interface Operation	238
Change the Router Source of a Switcher Source	239
Router Indexing	240
Add Router Indexing to Shows Created with Earlier Versions.	240
Router Control of Aux Buses	241
Control Aux Bus Source Selections from a Router	241
About R-MEM (Router Memory Registers)	242
Features	242
R-MEM Menu Operation	242
R-MEM Menu.	243
Learn an R-MEM Register	243
Recall an R-MEM Register	243
About E-MEM Control of R-MEM	244
R-MEM Disk Storage	244
R-MEM Enable Control and Auto Recall.	244
E-MEM Prefs Assignment	245
Learn R-MEMs from the Control Panel	245
Change R-MEM on an Existing E-MEM Register	246
Loading R-MEM Registers.	247
About Empty R-MEM Keyframes	247

Camera Control with Ethernet Camera Tally	247
Camera Operations.....	248
Ethernet Camera Tally Operations.....	248
About Scene Files	249
About Newton Modular Control	250
Installation on GV Switcher	250
Newton Controls Configuration.....	250
External Device Newton Menu Description.....	252
About the Delegation Pvw Bus.....	252
About Input Selection	252
About the Setup Selector	252
Newton Channel Information.....	253

9 Advanced Operations.....255

About Effect Editing with E-MEM & Timeline.....	255
Inserting a Keyframe.....	255
Inserting a Keyframe With Insert After.....	255
Insert on a Keyframe With Insert Before	256
Insert After or Insert Before on a Keyframe	257
Insert a Keyframe on the Path.....	257
Build an Effect By Inserting a Keyframe on the Path	257
Deleting a Keyframe.....	258
About Keyframe Durations.....	259
Change Duration for a New Keyframe	259
Modify an Existing Keyframe Duration	260
Restore KF Duration Default to the Keypad	260
About Effect Duration Editing.....	260
Edit Effect Durations from the Control Panel.....	260
Edit Effect Durations from the Menu	261
About Editing Effect Durations of Individual Levels	261
About E-MEM Modify All Operations	262
Perform a Modify All Operation	263
About E-MEM Learn Auto Recall	263
Update E-MEM Register Header Information.....	263
Set the Enable Groups Associated with Auto Recall	264
Set the Effect Dissolve Rate for Auto Recall.....	264
Change Path Control Values in an Effect.....	264
General Curve Tips	265
Cutting and Pasting Path Values	266
Controlling Smooth Path Windup.....	266
E-MEM Transitions.....	266
Build Background E-MEM Transitions.....	267
Building Keyer E-MEM Transitions.....	268
Changing the Length of an E-MEM Transition	268
Preventing Elements from Transitioning in E-MEMs.....	269
Return to Normal Technique	269
About Source Holds in Effects.....	269
Set a Source Hold in a New Effect	269
Set a Source Hold in an Existing Effect.....	270

About Reusing Effects	271
About E-MEM and Macro Interaction	272
About E-MEM Prefs Macro Sub-level Assignment	272
Preventing Assigned Macros from Running	273
Add a Macro to an E-MEM	273
Partial Keyframing	274
Excluding Sub-Levels in a Level	274
Rules and Options for Excluding Sub-levels	276
About Define E-MEM	276
Make E-MEM Sub-levels Definable to Other Levels	277
Enable Definable Sub-levels	278
About Moving Currently Defined Sub-levels	279
About E-M/EM Enables Tab	279
About Assignable Sub-levels	280
About Definable Sub-levels	281
About Effects Editing in the E-MEM Enables Tab	281
Enable E-MEM Levels from the E-MEM Enables Tab	281
About Additive Keyers	282
Enable an Additive Keyer in the Menu	282
About Super Additive	283
About Additive Keyer and the Control Panel	284
About Macro Builder	284
About Macro Line Editing	286
Build a New Macro with Macro Builder	287
Edit Macro Builder Created Macros	288
Insert a Macro Delay	289
Insert External Device Control Commands in Macros	290
Create a New Complex Macro	290
About Copying and Editing Complex Macros	290
Edit Values	291
About the Frame Simulator and Macro Editing/Building	293
Set the Line Rate for the Frame Simulator	293
About Offline Macro Editing with the Frame Simulator	294
Configure the Frame Simulator	294
Configure the GV Switcher Menu	294
About Transition Chaining	295
About Key Chaining	296
Creating a Key Chain	296
Key Chaining on a Single M/E	297
Key Chaining Across M/Es	298
Background Transition Chaining	300
About M/E Split Mode	301
M/E Split Mode in the Menu	301
Partition (Split) an M/E	302
M/E Split Mode from the Control Panel	303
Local E-MEM in Split Mode (Kayenne/Karrera)	304
Master E-MEM in Split Mode	304
Split M/Es and E-MEM Control	304
M/E Copy in Split Mode	304
Partition Boundaries	304

E-MEM Level Assignments in Split Mode	305
Partition Boundary Control	305
Split Layered Mode.....	306
Partition Sync Mode	307
Create Primary and Secondary M/Es (Dual Feed).....	308
Multiple Feeds	309
Including Source Substitutions.....	309
About Corner Pinning	309
Corner Adjust Limits.....	310
Corner Pinning and Cropping.....	310
Corner Pinning Menus.....	311
Create a Corner Pinning Effect (Example).....	312
Corner Pinning from the Kayenne Control Panel.....	314
2D DPM Edge Pinning	316
Create an Edge Pinning Effect (Example)	317
Adjust a 2D DPM Image with Edge Pinning Pan and Scan.....	319
Set Edge Pinning with the Kayenne Multi-Function Module.....	320
Pan and Scan a 2D DPM Image with the Kayenne Multi-Function Module	321
About Copy/Swap.....	322
Copy Swap Menus.....	322
Copy Swap M/E Menu	324
Copy Swap Wipes Menu	324
Copy One Transition Wipe to Another.....	325
Copy a Key wipe to a Key wipe.....	325
Copying Between Transition and Key Wipes	326
Copy a Transition Wipe to a Keyer Wipe (and Vice Versa).....	326
Copy an eDPM Wipe.....	326
Copy Swap Mattes Menu	327
Copy Swap Keyer Menu	328
Copy Swap Macro Menu	328
Copy Swap Timeline Menu	330
Copy a Timeline with Copy/Swap	331
Copy/Swap with the Multi-Function Module	332
Copy an M/E	332
Swap M/Es	332
Copy a Keyer	333
Copy e-DPMs.....	333
Swap e-DPM Channels.....	333
About Image Store Options.....	334
Supported Image Formats.....	334
Image Store Memory	334
Image Store Images Menus	334
Image Store Quick Tabs.....	335
Image Store Stills	335
Configure Image Store Resources	336
Release/Acquire Image Store Memory Between Suites.....	336
Map Image Store Input Delegates.....	337
Capture a Still from Input Video.....	338
Create a Split Key for a Still Store Still.....	339
Create an Image Store Still with another Video (Not Key).....	340

Still Playback from the Menu	341
Modify a Still	342
Set Freeze Mode	342
Kayenne Image Store Device Control.....	342
Kayenne System Bar Control	343
Image Store Movies Option	344
GV K-Frame XP Image Store Movie Lengths	344
Image Store Movie Storage Capacity	346
Image Store Movies Feature Configuration	347
License the Image Store Option.....	348
Movie Playback from the Menu Application	348
Movie Playback with the System Bar	348
E-MEM Keyframe Triggers for Image Store Movies	349
Load a Movie	349
Create an E-MEM Keyframe Trigger	349
Create an E-MEM Trigger Cue	350
Record a Movie.....	350
Name a Movie.....	351
Select a Thumbnail	351
Trim a Movie	352
Split an Image Store Movie	352
Join Image Store Movies and Stills	352
Image Store Build Edit	353
Copy a Movie with Build Edit.....	356
Build a Movie Using a Key and Video from Different Movies	356
Build a Movie With Video from One Channel as the Key for Another.....	357
Offset an Image Store Key/Cut Signal with Build Edit.....	357
Creating a Sequenced Movie	358
Create a Still Sequenced Movie	358
Image Store Record Modes	359
Create a Movie from Continuously Streaming Video with Loop Mode	360
Create a Movie including a Delay with Delay Line Mode	360
Image Store Library.....	361
Swap Images.....	362
Move Images.....	362
Conversion Requirements for Transferring External Image Files	362
Image Store Still File Formats	362
Image Store Movie File Formats.....	362
Importing Kalypso File Types	362
Transfer Files	364
Backup & Restore.....	365
Manual Backup.....	365
Schedule a Backup	366
Restore Cache from the Local Drive	367
About Image ReStore.....	367
Image ReStore Button Functions.....	367
.....Enable Image ReStore	368
Editing Files in Image ReStore.....	368
Configure a Networked PC for Image Store File Sharing Windows	368
Create an Images Directory and Configure it for Sharing	368

Set Network and Sharing Settings.....	369
ClipStore	369
Summit/Solo Software Version.....	369
Control Panel Operation	371
ClipStore Menu Operations	371
Load a ClipStore Clip	372
Clip Search	373
Playback a Clip	373
Clip Cueing and Playback Controls.....	374
Recording Clips	376
Mark a ClipStore thumbnail.....	379
ClipStore Trim and Remove.....	379
Make Sub-clips from the Current Clip	380
Split One Clip into Two Sub-Clips	381
Cut Editing while Recording	381
Build Editing	382
Editing a Video Clip with Build Edit.....	384
Adding a New Audio Element with Build Edit.....	385
File Operations.....	388
Creating a Shared Folder for External USB Disk Drives.....	390
Device Control	390
Glossary	391
Index.....	399
Contact Us	407

1 Introduction

Overview

The Grass Valley K-Frame family of multi-format digital production switchers provides powerful, ground-breaking features designed to meet the widest range of requirements for live studio, mobile, and post-production applications.

The following Video Processors are the heart of the system, providing extensive video switching and signal processing capabilities:

- Standard
- Compact
- S-series
- V-series
- GV K-Frame X
- GV K-Frame XP

This functionality is controlled using any Control Panel with any Video Processor Frame:

- Kayenne control surface,
- Karrera control surface,
- GV Korona control surface,
- the Soft Panel (KSP option), and/or
- the Menu application running on a PC (Menu on PC).

In addition, the system supports direct control of external devices (DDR, Servers) and bi-directional control to and from routing and automation systems.

Features

General

- Fully digital 10-bit 4:2:2 video switcher including 4K, HDR (HLG and PQ), 1080p, and 2160p support:
 - SDI—1080p level-A or level-B
 - IP I/O—1080p level-A
 - IP I/—2160p (GV K-Frame XP)
- Optional smart I/O modules provide up/down/cross-conversion when licensed with SetDef and MatchDef.
- The K-FRM-IO-10GE IP I/O board for the K-Frame video processing engine offers Video-Over-IP connectivity for all K-Frame Video Production Switchers, using either uncompressed SMPTE 2022-6 or 4K 1-wire compressed IP.

- 4K UHD processed using 2SI (2 Sample Interleave) or SDQS (Square Division Quad Split).
- Integrated Macro Builder/Editor allows users to edit macros online or offline on a PC running the menu application.
- Optional DoubleTake™ (split M/E mode) effectively increases the number of M/Es and adds flexibility to Suites operation while FlexiKey™ programmable clean feed mode supports separately programmable configurations of keyers from four M/E outputs.
- FlexiKey™ programmable clean feed mode supports separately programmable configurations of keyers from four M/E outputs.
- Aux bus transitions for dissolves and wipes on aux bus outputs.
- Interfaces with Grass Valley routers supporting Native Protocol.
- Optional Integrated Image Store capable of delivering up to 32 GB and 64GB storage of Stills (3,000/6,000 images) or “Movies” (a total of 50 seconds or 1 minute 40 seconds) of 1080p video.
- LDK Series and LDX Series camera control with Ethernet tally via Connect Gateway.
- Optional integrated external ClipStore provides multiple channels of video/key pairs for up to 10+ hours of nonvolatile video/key/audio clip content.
- 999 macros with many ways to recall macros from the Control Panel.
- 1,000 E-MEM registers with Define E-MEM for fine control in creation and editing of effects.
- Optional M/E Previewer provides a method to check and monitor any input to an M/E.
- VDCP Ethernet connection for stadium applications.
- Ethernet tally connection for integration with external tally systems.
- Optional RGB color correction on M/E buses and aux bus outputs.
- Source Rules:
 - Links keyers to sources.
 - Settings for On/Off/Left Alone on every M/E.
 - Full look-ahead preview of rules.
- Hot-swappable, front/rear removable modules and power supplies.
- Optional multiple Multiviewer capability with 5 pre-configured layouts (maximum 14 panes per layout) with On-Air and Preview tally.

K-Frame Standard Frame

- Up to 192 inputs and 96 outputs.
- Up to 9 M/Es, accessible across two suites—by using DoubleTake this may be increased to 18 virtual M/Es.
- Every M/E has six keyers with standard keying modes including Chroma Key, a pool of floating 3D iDPMs, and two frame stores per keyer—the Controller M/E cannot use floating 3D iDPMs.
- 2D-DPMs (resizers) on every keyer, with 6 pairs per M/E so iDPMs can be utilized for more complex effects.
- The Controller M/E has a complement of 6 full keyers with Chroma Key and 2D-DPMs.

- Up to 16 iDPMs (Integrated Digital Picture Manipulators), assigned as either floating iDPMs or within an eDPM at user's discretion.

K-Frame Compact Frame

- Up to 80 inputs and 48 outputs.
- Up to 5 M/Es, accessible across two suites, increased to 10 virtual M/Es by using DoubleTake.
- Every M/E has six keyers with standard keying modes including Chroma Key, two frame stores per keyer—every keyer except for Controller M/E can use the pool of floating 3D iDPMs.
- 2D-DPMs (resizers) on every keyer.
- The Controller M/E has a complement of 6 full keyers with Chroma Key and 2D-DPMs.
- Up to 8 iDPMs (Integrated Digital Picture Manipulators), assigned as either floating iDPMs or within an eDPM at user's discretion.
- K-Frame Compact S-series Frame (Differences)
- Up to 6 M/Es, accessible across two suites, increased to 12 virtual M/Es by using DoubleTake.
- Every M/E has four keyers with standard keying modes including Chroma Key and every keyer can use the pool of floating 3D iDPMs (Key Stores are not available).
- 2D-DPMs (resizers) on every keyer.
- Two built-in multiviewers with five pre-configured layouts (maximum 14 panes per layout) and On-Air/Preview tally.

K-Frame Compact S-series Frame

- Up to 80 inputs and 48 outputs.
- Up to 6 M/Es, accessible across two suites, increased to 12 virtual M/Es by using DoubleTake.
- Every M/E has four keyers with standard keying modes including Chroma Key—every keyer can use the pool of floating 3D iDPMs.
- 2D-DPMs (resizers) on every keyer, with 4 Video/Key pairs per M/E.
- The Controller M/E has a complement of 6 full keyers with Chroma Key and 2D-DPMs.
- Up to 8 iDPMs (Integrated Digital Picture Manipulators), assigned as either floating iDPMs or within an eDPM at user's discretion.
- Two Built-in multiviewers with five pre-configured layouts (maximum 14 panes per layout) with On-Air and Preview tally.

K-Frame V-series Frame

- Up to 32 SDI inputs and 16 SDI outputs.
- Up to four Media Port inputs and two Media Port outputs.
- Up to 3 M/Es plus 2 VPEs, accessible across two suites, increased to 10 virtual M/Es by using DoubleTake.

- Every M/E and VPE has four keyers with standard keying modes including Chroma Key—every keyer can use the pool of floating 3D iDPMs.
- 2D-DPMs (resizers) on every keyer, with 4 Video/Key pairs per M/E and VPE.
- Up to 4 iDPMs (Integrated Digital Picture Manipulators), assigned as either floating iDPMs or within an eDPM at user's discretion.
- Two Built-in multiviewers with five pre-configured layouts (maximum 14 panes per layout) with On-Air and Preview tally.

GV K-Frame X Standard Frame

- Up to 192 inputs and 96 outputs.
- Up to 9 M/Es, accessible across two suites—by using DoubleTake this may be increased to 18 virtual M/Es.
- Every M/E has six keyers with standard keying modes including Chroma Key, two frame stores per keyer—every keyer except for Controller M/E can use the pool of floating 3D iDPMs.
- 2D-DPMs (resizers) on every keyer, with 6 Video/Key pairs per M/E so iDPMs can be utilized for more complex effects.
- The Controller M/E has a complement of 6 full keyers with Chroma Key and 2D-DPMs.
- Up to 16 iDPMs (Integrated Digital Picture Manipulators), assigned as either floating iDPMs or within an eDPM at user's discretion.

GV K-Frame XP Compact Frame

- Up to 80 inputs and 40 outputs.
- Up to 9 M/Es, accessible across two suites—by using DoubleTake this may be increased to 18 virtual M/Es.
- Every M/E has six keyers with standard keying modes including Chroma Key, two frame stores per keyer—every keyer except for Controller M/E can use the pool of floating 3D iDPMs.
- 2D-DPMs (resizers) on every keyer with Pivot and Perspective, with 6 Video/Key pairs per M/E so DPMs can be utilized for more complex effects.
- The Controller M/E has a complement of 6 full keyers with Chroma Key and 2D-DPMs.
- Up to 16 iDPMs (Integrated Digital Picture Manipulators), assigned as either floating iDPMs or within an eDPM at user's discretion.

K-Frame Control Surfaces

Kayenne Control Surface

A Kayenne control surface typically consists of a Control Panel, a Menu Panel with an included articulated support arm, a Panel Control Unit (PCU) frame, and optional Satellite

Panels. This control surface has an innovative modular design. Representative Kayenne control surfaces are shown in the following illustrations.

4-ME 35 Control Panel

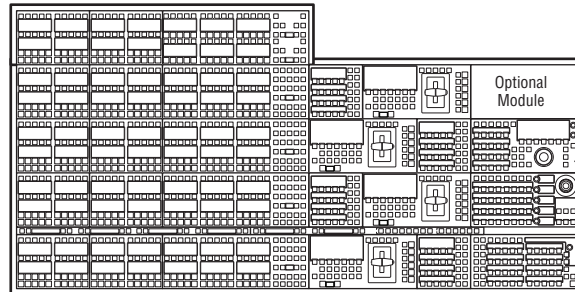

Menu Panel

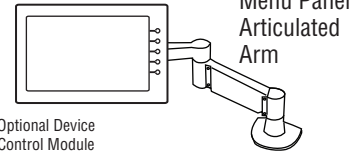

Optional Device Control Module

Panel Control Unit (PCU)

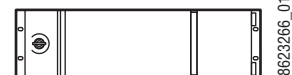

3-ME 35 Control Panel

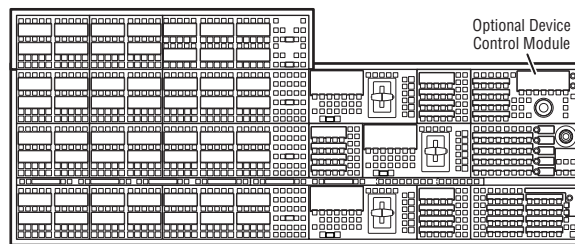

Menu Panel

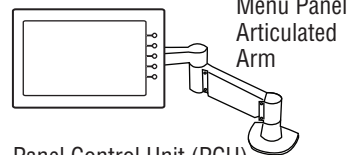

Panel Control Unit (PCU)



2-ME 25 Control Panel

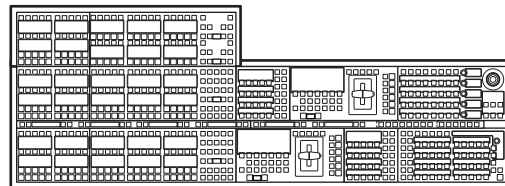

Menu Panel

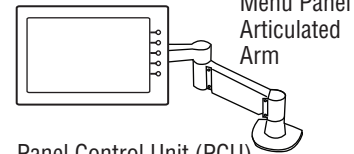

Panel Control Unit (PCU)



1-ME 15 Control Panel

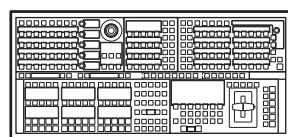

Menu Panel

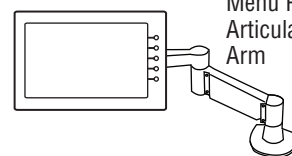

Panel Control Unit (PCU)



The modular design and use of a separate PCU supports the hot-replacement of individual Control Panel components, if necessary, while the rest of the system remains operational.

CAUTION: Do not connect or disconnect the PCU to Control Panel cables while the system is powered on.

Flat or Curved Control Panel Orientation

The main Kayenne Control Panel supports different physical orientations. Besides a conventional flat surface, a special support design permits a curved working surface, where the M/Es progressively tilt for improved ergonomics.

Curved Control Panel Assembly

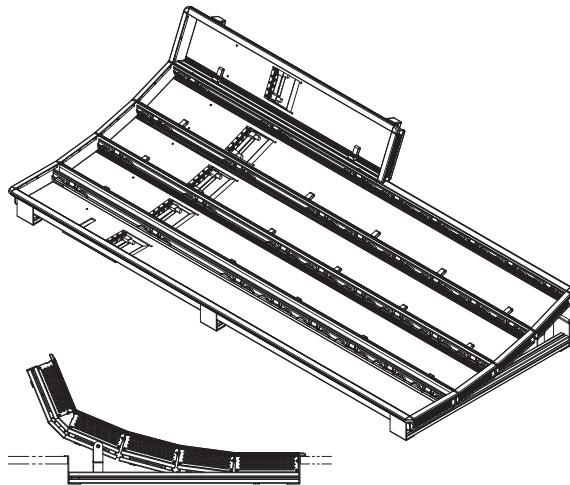

Flat Control Panel Assembly

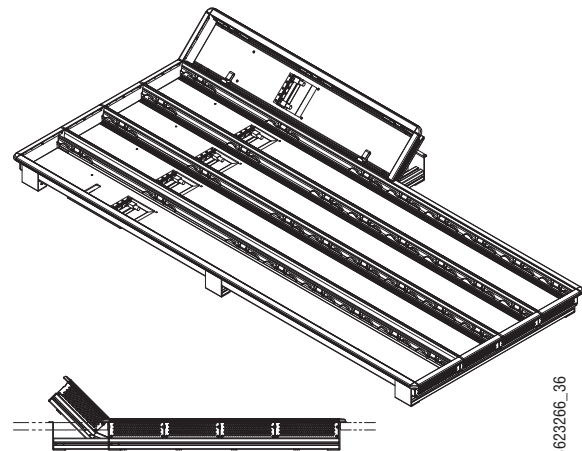

8623266_36

Control Panel Stripes

The main Kayenne Control Panel is organized into from one to five Stripes. Each Stripe consists of a tray and its complement of drop-in modules. An M/E Stripe has a module for Source Selection, Transition, and individual E-MEM control. Additional Master E-MEM, Machine Control, Multi-Function, and Local Aux modules are populated to complete the control surface functionality.

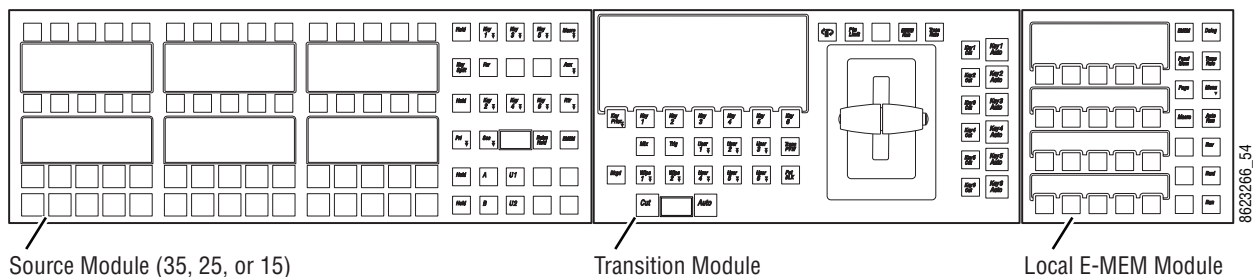

8623266_54

Touch Screen Menu Panel

Each Kayenne control surface includes a Menu Panel that features a wide format 15 in. touch screen display. An articulated arm is also included, offering a wide variety of installation options. The Menu Panel has a standard VESA-75 hole pattern and M4 threads, compatible with this and many other mounting devices.

The Menu Panel has four USB ports, two on the right side edge of the panel and two on the back for keyboard and mouse (wired or wireless are supported).

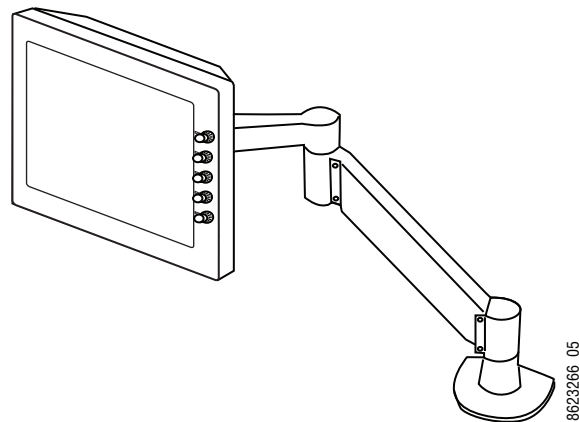

Basic Single Suite Kayenne Panel System

A basic K-Frame system consists of a Control Panel, a Menu application running on a touch screen Menu Panel, and a Video Processor Frame. The Control Panel and Menu application make up a control surface associated with that frame. The Kayenne Control Panel and Menu Panel have associated active electronics housed in the Panel Control Unit (PCU).

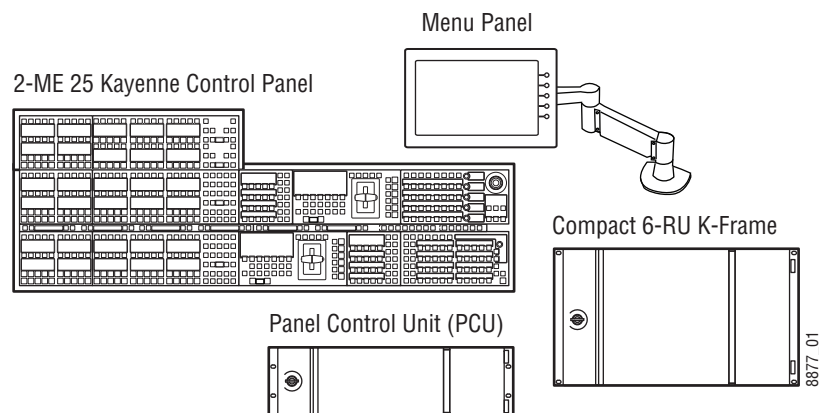

Multiple Suite Kayenne Panel System Example

A K-Frame system can be subdivided into two suites, if desired, each of which can have two control surfaces (Surface A and Surface B). Each surface has its own set of Panel Preferences for configuration of the control panel behavior and independent macro systems to allow for independent building and running of macros by each operator at the control surface.

Hardware resources in the Video Processor Frame can be assigned to an individual suite during configuration, essentially creating two separate switchers sharing one frame.

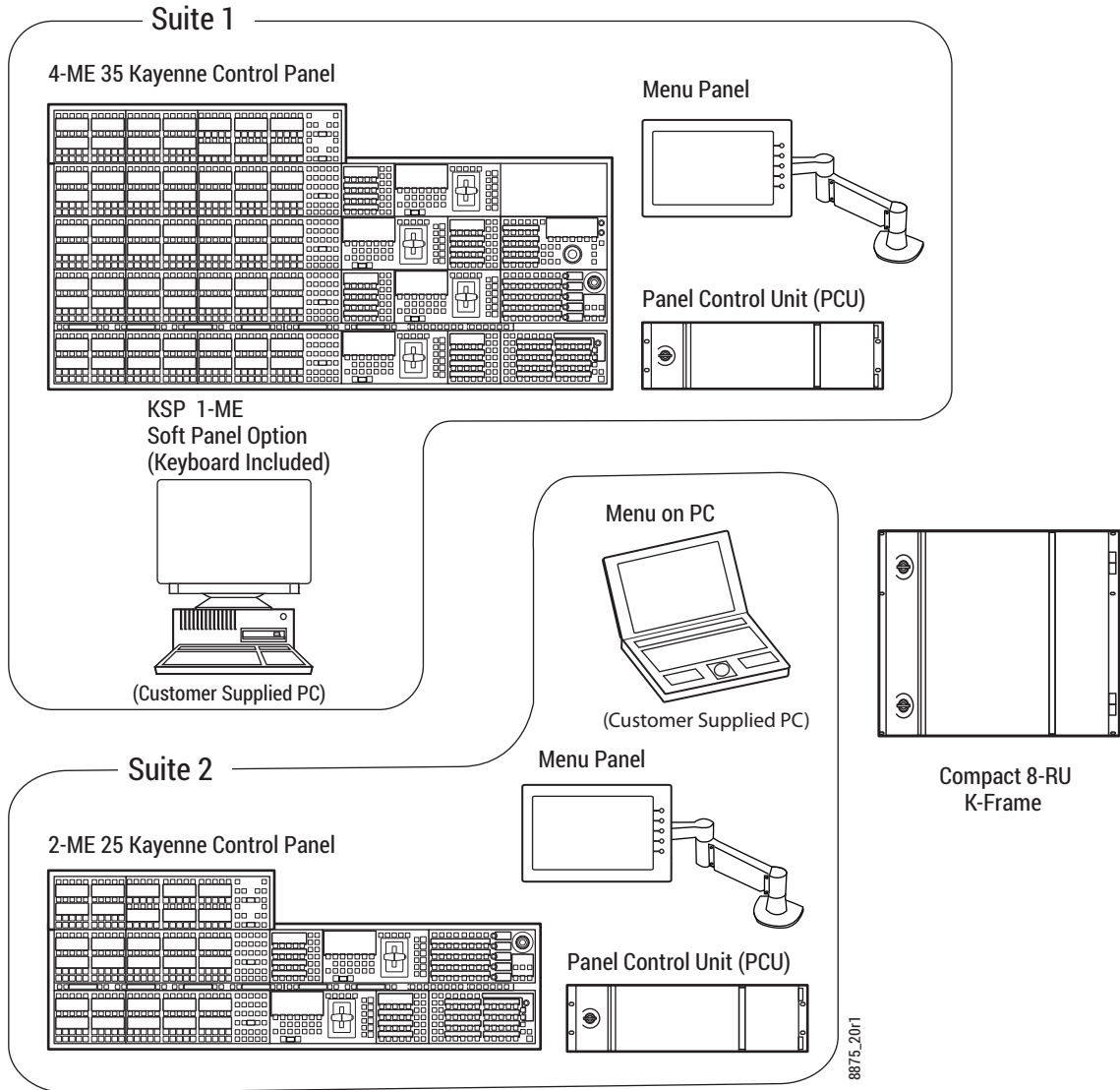

Karrera Control Surface

A Karrera control surface typically consists of a Control Panel and a Menu application. Representative Karrera control surfaces are shown in the following illustrations.

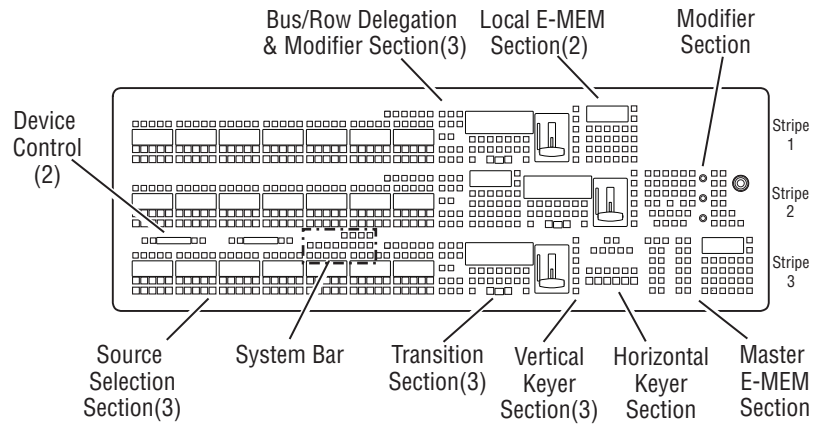

Karrera 2-ME 25 Control Panel

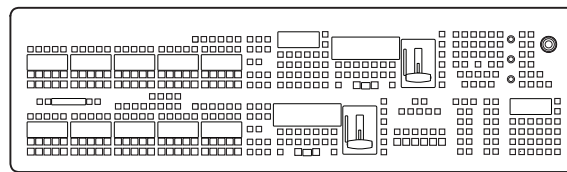

Karrera Menu on PC



(Customer Supplied PC) 8623266_03_Krr

Touch Screen Menu Option

A hardware Karrera Menu Panel is available as an option, which features a wide format 15 in. touch screen display. An articulated arm is also included, offering a wide variety of installation options.

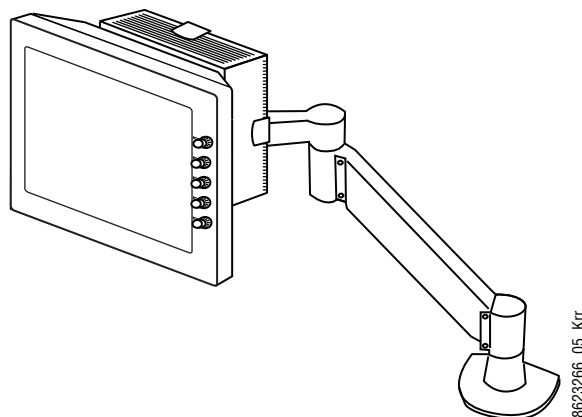

8623266_05_Krr

The Menu Panel has a standard VESA-75 hole pattern and M4 threads, compatible with this and many other mounting devices. The Menu Panel also has four USB ports, two on the right side edge of the panel and two on the back for keyboard and mouse (wired or wireless are supported).

A fanless PC, running Windows OS, is available which mounts behind the Menu Panel.

Basic Single Suite Karrera Panel System

A basic Karrera K-Frame system consists of a Control Panel, a Menu application running on a PC, and a Video Processor Frame. The Control Panel and Menu application make up a control surface associated with that frame.

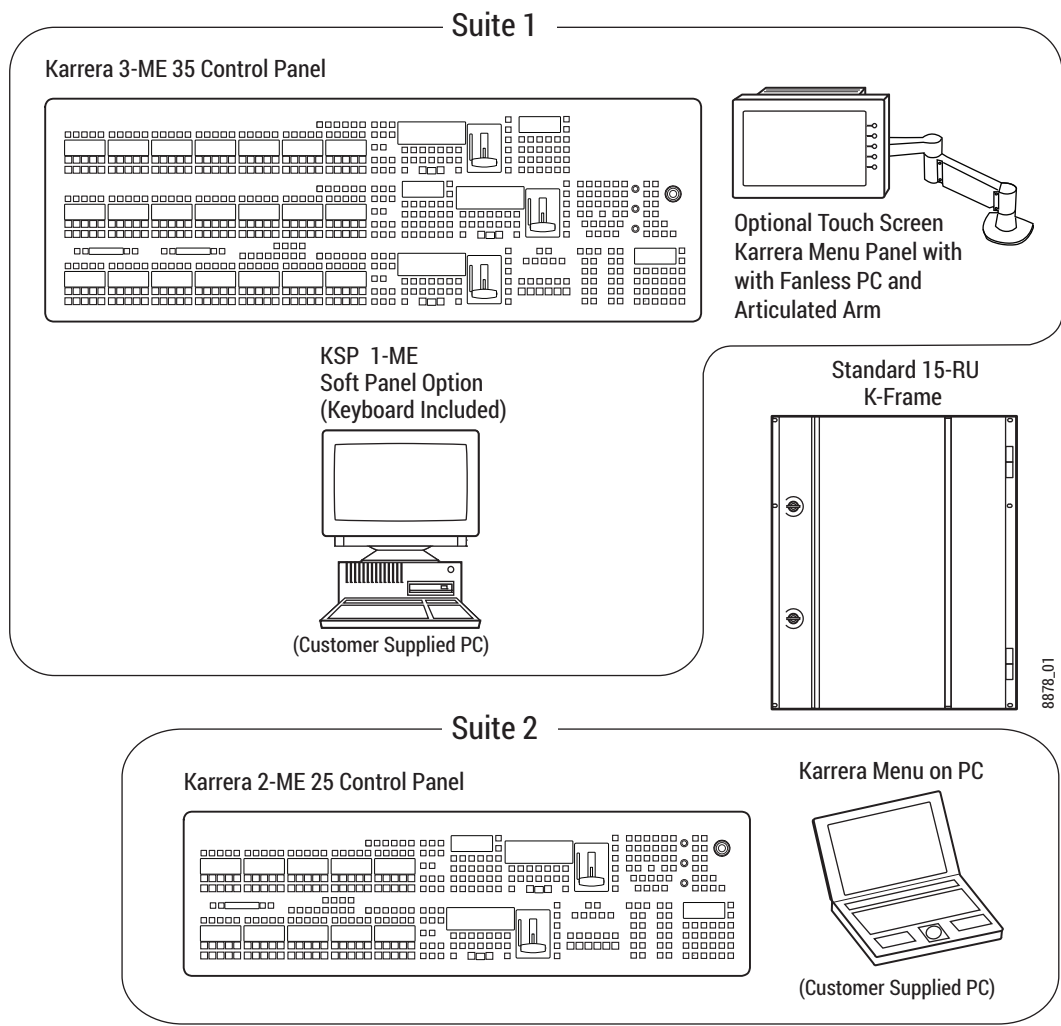

GV Korona Control Surfaces

A GV Korona control surface consists of a Control Panel with Source Select, Transition, Delegation, and Master/Local E-MEM areas, and a built-in multi-touch display with menu system.



Basic Single Suite GV Korona Panel System Example

GV Korona 2-M/E 20 Control Panel

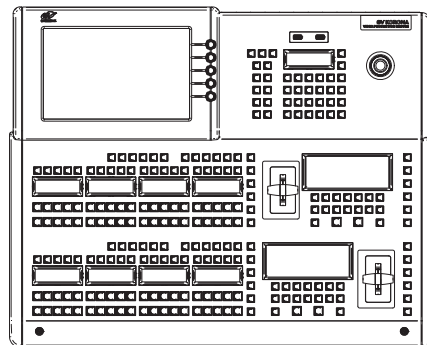

K-Frame V-series 3-RU

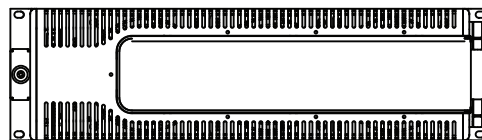

6600_0411

Multiple Suites and Control Surfaces Example

Any K-Frame Kayenne, Karrera, or GV Korona Control Panel can be configured with any K-Frame Video Processor. The K-Frame system can be subdivided into two suites and each suite can have up to two control surfaces. Hardware resources in the Video Processor Frame can be assigned to an individual suite during configuration, essentially creating two

separate switchers sharing one Frame. See the K-Frame Installation & Service Manual for suite configuration information.

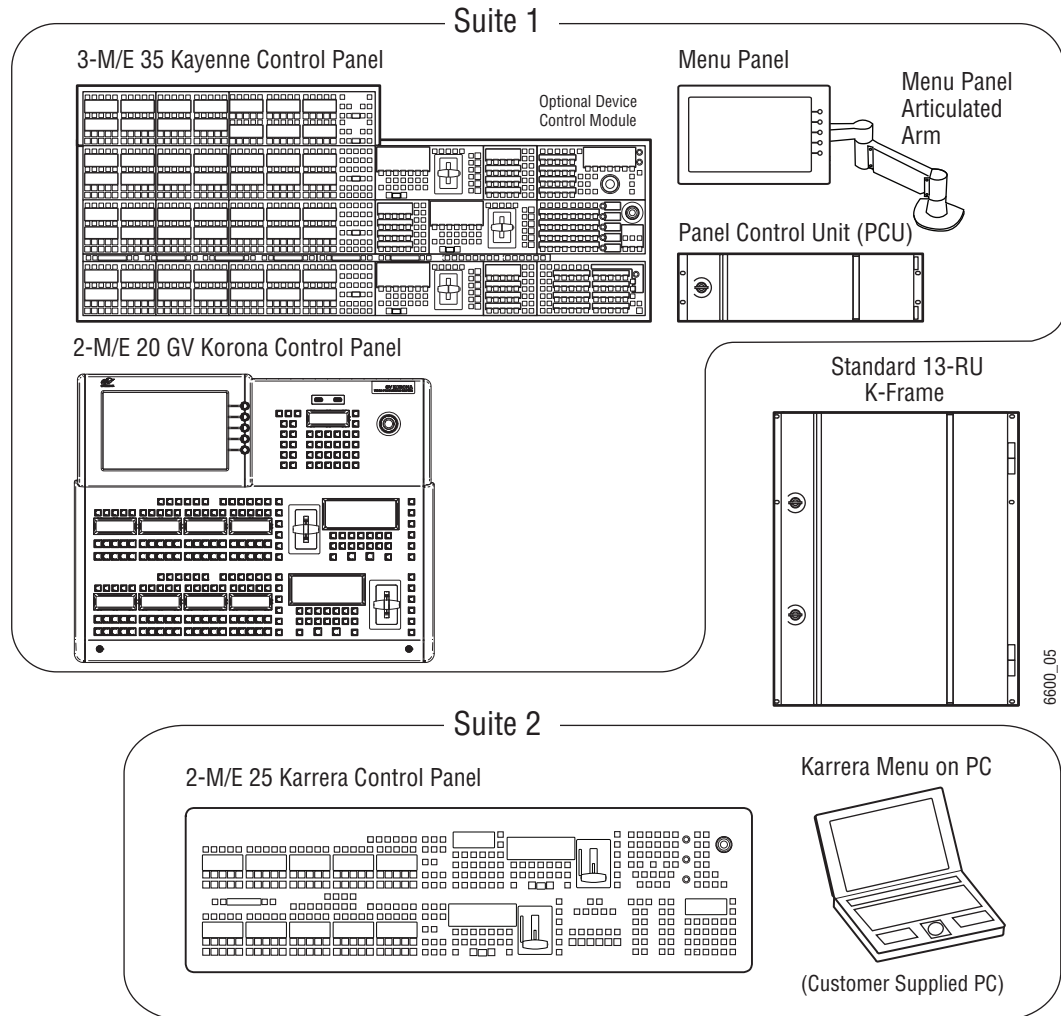

Supported Control Protocols

- PBus II
- GPI Inputs and Outputs
- Serial BVW-75 for VTR control
- Odetics protocol for VTR control
- AMP (advanced media protocol) for Profile PVS, Profile XP Media Platform, K2, M-Series, Turbo iDDR, and T2 iDDR systems over Ethernet
- Grass Valley Native Protocol for routers/routing control systems (Trinix/Trinix NXT, Venus™, Triton™, and third-party routers; Jupiter NV9000 and NV920, and Encore router control systems)
- Tally (contact closure)

- K-Frame Ethernet Tally protocol
- Ethernet CPL to control Grass Valley external remote AUX Panels
- Grass Valley Editor protocol
- SNMP system monitoring
- Serial and Ethernet VDCP
- LDK Series & LDX Series™ camera control with Ethernet tally via Connect Gateway

Documentation & Media



About this Manual

The GV K-Frame XP User Manuals are designed for operators of Video Production Center systems.

Documentation Libraries can be found at www.grassvalley.com.

Standard Documentation Set

The standard documentation set consists of a:

- *User Manual,*
- *Installation & Service Manual,*
- *Installation Planning Guides,*
- *Release Notes, and*
- *Release Notes Addendum.*

The *GV K-Frame XP User Manuals* contains background information about the Video Production Center, and describes operating procedures. This manual can be used while learning, and for enhancing your basic knowledge of the system.

The *Installation & Service Manuals* contains information about installing, configuring, and maintaining the system.

The *Installation & Planning Guides* contain information about preparing your site for power, installation, and cabling.

The *Release Notes* contain information about new features and system enhancements for a specific software version, and also includes software installation procedures. Always check the release notes for your current system software before you begin operating your system.

The *Release Notes Addenda* contain corrected and known issues about the system software.

Other Documentation

The *Switcher Products Protocols Manual* is available for developers and software engineers to use to design interfaces to the GV K-Frame XP systems.

The Ethernet Tally is a proprietary protocol that provides all of the switcher status information required to calculate the Tally state of the switcher. The Ethernet Tally Software Development Kit (SDK) is available to approved vendors who need to interface with the Ethernet Tally system. Contact Grass Valley Product Management for more information on this SDK.

The *KSP Graphical User Interface Instruction Manual* provides information, requirements, and instructions for operating the 1-M/E switcher Soft Panel GUI on a touch screen or regular PC, including the optional customized keyboard.

The *Switcher Concepts Manual* provides an overview of switcher operation and describes basic switcher fundamentals.

Video Tutorials & Training



Grass Valley Video Production Center switcher video tutorials and training can be found in Support | Documentation Libraries at www.grassvalley.com and on YouTube.

3 Panel Preferences

Panel Preference Settings

Panel Preference settings define the Control Panel delegation, appearance, and behavior. You can customize Panel Preferences to best fit your workflow.

About Control Panel Default Button Mapping

Video inputs are mapped to Source Selection and Local Aux Bus Control Panel buttons. Default mapping includes one-to-one logical input mappings, for example inputs labeled 1-28 to Source Select buttons 1-28 (on a 35 button panel) or Aux 1- Aux 96 with a Local Aux panel (Kayenne/Karrera).

There are four default M/E outputs delegated for reentry (as inputs) per shifted row (1st row M1 A - M4 A, 2nd row M1 C - M4 C, etc.), 2nd and 3rd Shift Levels, and Delegation buttons.

Note: Default button mappings can be restored by clearing NV Memory.

Button mappings can be changed in the Button Mapping menu and saved in the User Setups, Panel Prefs menu. The same source can be mapped to one or many buttons. Button mapping is also used to assign Aux buses to delegation buttons, referred to as "Aux Delegate Mapping".

Operators often map groups of sources together, like cameras, character generators, Image Store and ClipStore Channels, and other kinds of like sources. An operator might setup the source buttons in the order they plan to switch a show.

Button Mapping Menu Overview

Select **User Setups**, **Panel Prefs**, **Button Mapping** to access the menu.

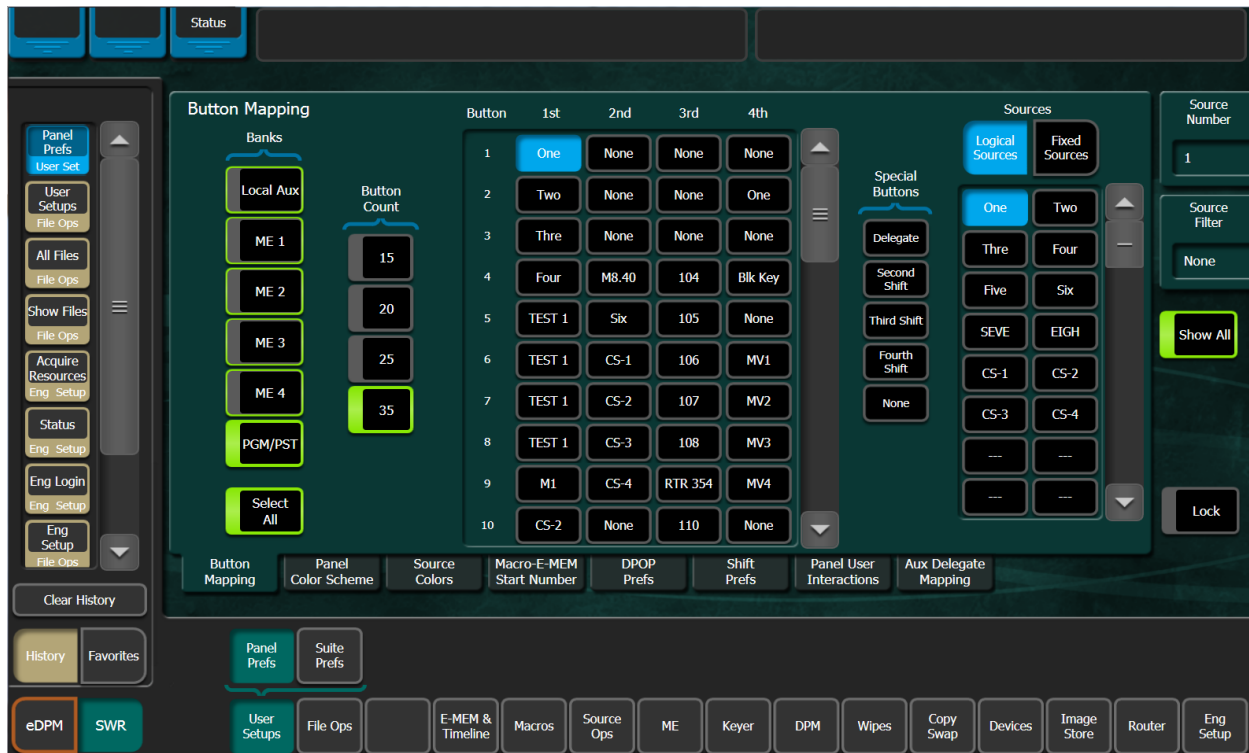

Button functions:

- Bank toggle buttons are used to select one, several, or all M/Es and/or Local Aux buses (includes the **Select All** button). Logical/Fixed sources can be assigned to any enabled Bank buttons in the Banks button row.
- Button Count buttons (**15**, **20**, **25**, and **35**) are used to select the button count for the Control Panel. For example if the menu has not been associated with a Control Panel or if using a 15 or 25 button Control Panel with a 35 button Aux Panel (Kayenne/Karrera), the button count can be selected manually (this selection is automatic if a panel has been associated in the **Associated Panel** data pad, in the Eng Setup, Node Settings, Frame Suite Nodes & ID menu). The Source Select button scrolling list allows you to select a source select button to assign a source from the Logical/Fixed Sources list.

Special Buttons:

- **Delegate** button is used to assign the Keyer and Bus Row delegations to source select buttons.
- **Second Shift**, **Third Shift**, and **Fourth Shift** buttons are used to assign those shift levels to source select buttons.
- **None** Removes the mapping of the highlighted source select button.

When a Special Button is selected as a mapped source for a Source Select button, that assignment will be given to each shift level of that bus; each can be changed individually afterward.

The Logical/Fixed Sources area:

- **Sources** scrolling list—used to locate assignable sources. You can choose from Logical or Fixed Sources
- **Source Number** data pad—displays a data entry pop-up when selected and is used to assign a Logical source number to a source select button
- **Source Filter** data pad—displays a data entry pop-up when selected and is used to perform alpha-numeric, case sensitive searches of Logical or Fixed sources
- **Show All** button—displays all sources in the scrolling list
- **Lock** button—locks the scrolling list; helpful for selecting multiple adjacent sources

Map Control Panel Source Select Buttons

In this example, a source will be delegated to the source select button for the PGM/PST bank. The process is the same for the Local Aux bank.

TIP: Define the Control Panel source select button mapping Source Names in the Eng Setup, Source Definition menu before continuing.

- 1 Select **User Setups, Panel Prefs, Button Mapping**.
- 2 Select the **PGM/PST** Bank button (notice the **Select All** button is now available).
When multiple banks are selected, the source delegation will be applied to the same button on each bank, including the Local Aux.
- 3 In the Sources pane, center of the menu, select a source data pad.
- 4 Select a Logical or Fixed source in the right-hand pane.
Result: As the button mappings change, the new source names will appear on the source name displays of the source selection buttons on the Control Panel and/or Local Aux.

Assign a Control Panel Color Scheme

Panel Color Scheme selections are applied to the M/Es, Keyers, and Delegation Control Panel buttons (not sources). You can change a Control Panel system color scheme from the default.

Note: The five User Colors are shared between the Source Colors and Panel Color Scheme menus.

Set all system colors:

- 1 Select **User Setups, Panel Prefs, Panel Color Scheme**.

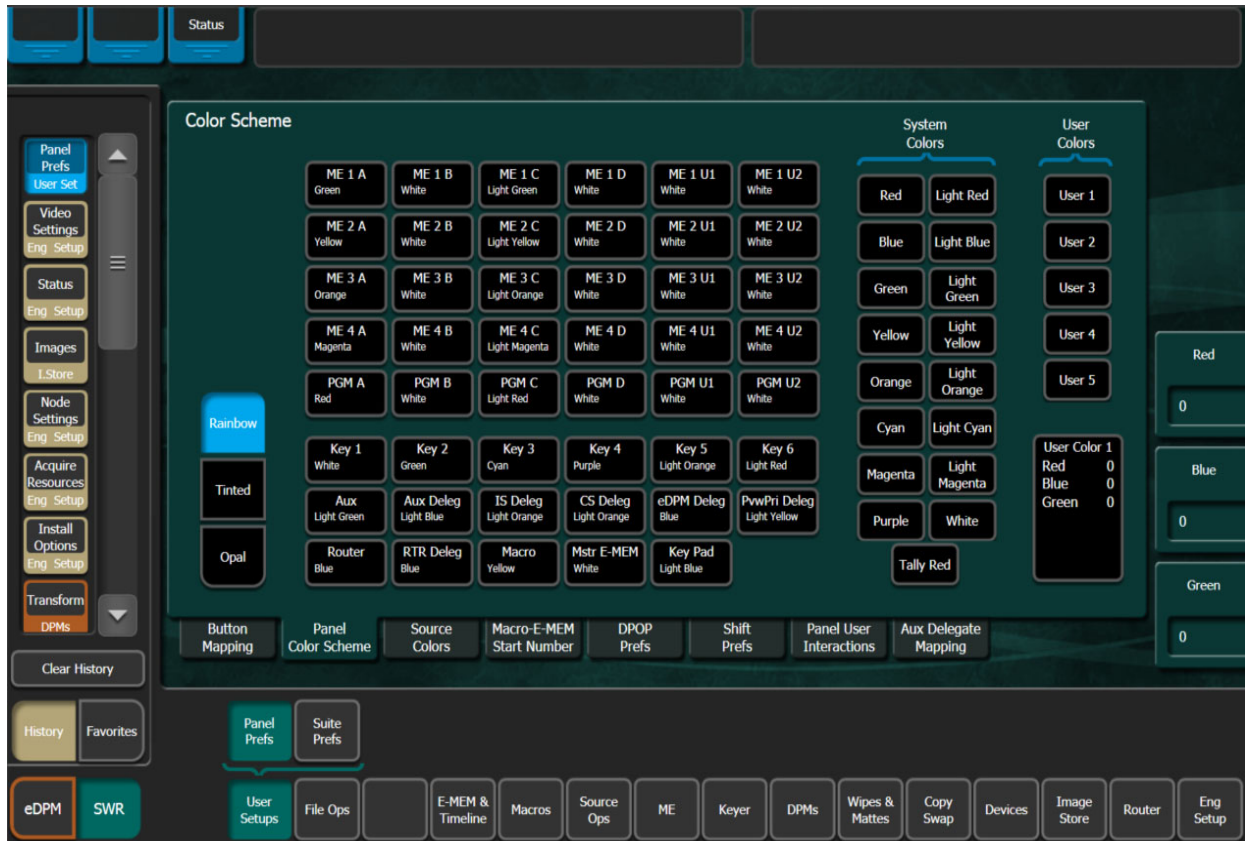

- 2 From the Color Scheme button list, left, select the **Rainbow**, **Tinted**, or **Opal** buttons.
- 3 Save the Panel Color Scheme settings in the File Ops, User Setups menu.

Set delegation button colors:

- 1 Select delegation buttons in the center pane.
- 2 From the System Colors or User Color (if defined, see [Define User Colors](#)) button list, select a color.
- 3 If a user color is selected, you can adjust the RGB color by using the Menu Panel knobs or clicking in the data pad and entering a value in the pop-up keypad.
- 4 Save the Panel Color Scheme settings in the File Ops, User Setups menu.

Assign Control Panel Source Colors

Source Colors take priority over Panel Color Scheme settings.

Note: The five User Color button settings are shared between the Source Colors and Panel Color Scheme menus.

1 Select **User Setups, Panel Prefs, Source Colors**.

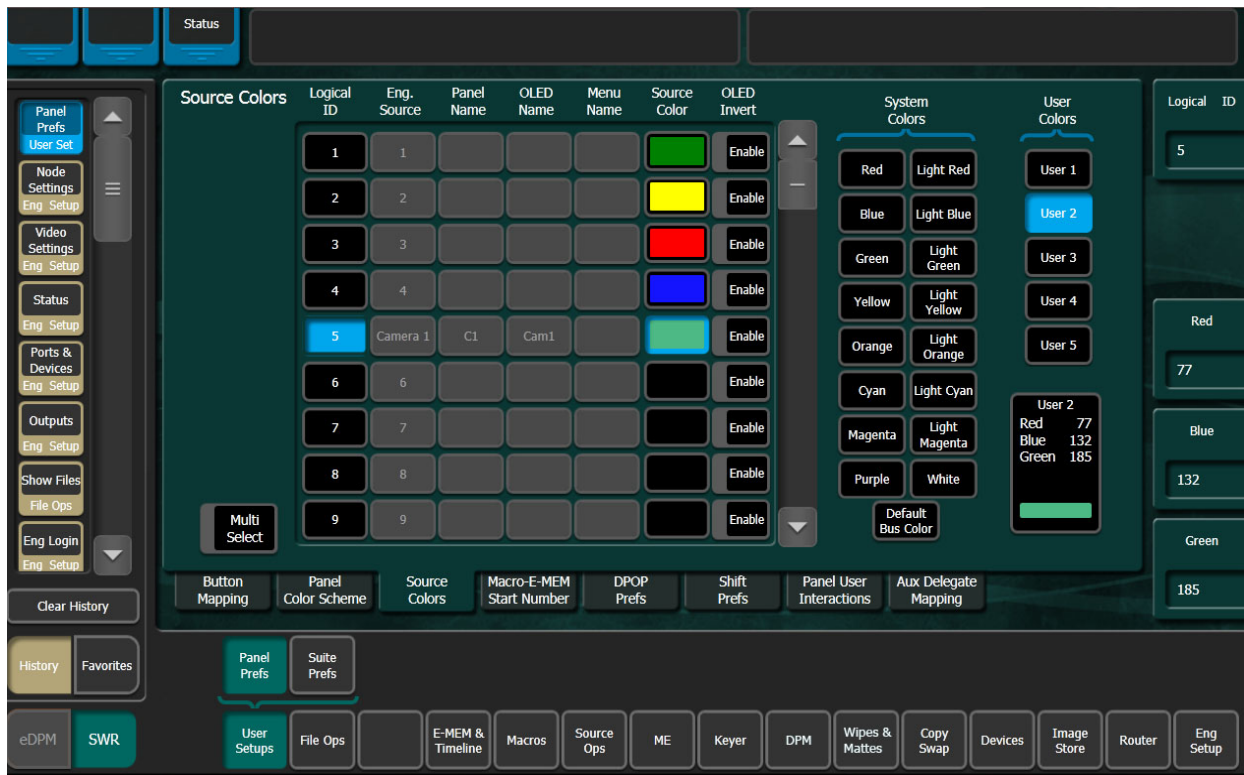

- 2 Select the Logical ID of the desired source.
- 3 Select the desired color in the System Colors or User Colors pane (see [Define User Colors](#)).

Note: Use the **Default Bus Color** button in the System Colors pane to return to the Panel Color Scheme default.

- 4 Optionally, you can select the **Enable** button in the OLED Invert column of the center pane to display dark text over a colored background for the Source Select button (default is colored text over a dark background).

Define User Colors

The five User Color buttons allow you to create custom colors for Source (Source Colors menu) and Delegation (Panel Color Scheme menu) buttons.

Note: The five User Color button settings are shared between the Source Colors and Panel Color Scheme menus.

- 1 Select **User Setups, Panel Prefs, Source Colors** (or **Panel Color Scheme**).
- 2 Select a User Colors button **User 1 - User 5**.

- 3 Adjust the User Color button settings by turning the Red, Blue, and Green Menu Panel knobs or by selecting their data pads and entering a value in the pop-up keypad (right side of menu).
- 4 Repeat for each User Color button.

Map Remote Aux Panel Sources to the Control Panel

The Remote Aux Panel Server Ethernet IP is set to the Video Processor Frame of the GV Switcher system, see the *Kayenne/Karrera/GV Korona* Installation & Service Manual for more information.

- 1 Select **Eng Setup, Node Settings, Remote Aux Button Map**.



- 2 Select an individual Remote Aux Panel by selecting its button in the left pane or select the Multi Select button for group selection of the Node Settings menu.
- 3 Select the Aux source button in the central pane.
- 4 Select the source in the right pane.

Map Remote Aux Panel Delegation Buttons (Logical Mapping)

You can map Remote Aux buses to Panel Delegation buttons to make them available as sources to the Control Panel. When multiple Remote Aux Panels are selected, changing one button's mapping changes the button mapping for all selected Remote Aux Panels. When multiple Remote Aux Panels are selected, changing one button's mapping changes the button mapping for all the selected Remote Aux Panels.

- 1 Select **Eng Setup, Node Settings, Remote Aux Logical Map**.



- 2 In the Panel Delegation area, select a Remote Aux Panel button.
- 3 In the Logical Aux Buses area, select an Aux Bus delegation button.
- 4 Save the Aux Map settings in the **File Ops, Eng Setup** menu.

Panel Preferences

Map Remote Aux Panel Delegation Buttons (Logical Mapping)

4 Suite Preferences

Suite Preference Settings

Suite Preferences define the Video Frame settings for the switcher system. You can customize the Suite Preferences for each suite. Some Suite Preference settings are described in the Advanced section ([Advanced Operations](#), on page 255), along with operations, including E-MEM, Re-Entry, GPI Inputs, Image Store, and Transition Chaining.

About Suite Resources

The Suite Resources menu allows you to allocate resources for Aux bus transitions, set Suite Signal Type parameters, and enable/disable Re-Entry.

Aux Bus Transitions

See [Aux Bus Transitions](#), on page 195.

About Suite Signal Type—HDR Mode

GV K-Frame XP systems transmit Payload ID parameter values based on the Frame Operating Mode unless an HDR Mode is selected. When in an HDR mode, all outputs for the current suite will transmit the HDR Payload ID parameter values.

Note: GV K-Frame XP systems transmit HDR Payload ID parameter values only, signals are not converted.

The following HDR modes are supported:

- SDR—Standard HD (Frame Operating Mode Payload ID)
- S-Log3—Gamma curve
- PQ—Perceptual Quantization
- HLG—Hybrid Log-Gamma

Default settings

- HDR Mode—SDR
- Color Space—Rec 709
- Bit Depth—10-Bit

HDR Payload ID Specifications

Suite Signal Type Specifications

Transmission	Recommendation	Description
HDR: Rec BT2100	ITU-R BT.2100-2 (07/2018) (HLG, PQ)	Image parameter values for high dynamic range television for use in production and international programme exchange
Colorimetry: Rec BT2020	ITU-R BT.2020-2 (10/2015)	Parameter values for ultra-high definition television systems for production and international programme exchange
Colorimetry: Rec BT709	ITU-R BT.709-6 (06/2015)	Parameter values for the HDTV standards for production and international programme exchange

PID Specifications

SMPTE	Description
ST 352:2013	Payload Identification Codes for Serial Digital Interfaces, base line
ST 292-1:2018	1.5 Gb/s Signal/Data Serial Interface, define 1080i, 1080p, 1080 psf—720p does NOT support HDR
ST 425-1:2017	Source Image Format and Ancillary Data Mapping for the 3 Gb/s Serial Interface, 1080p Level A
ST 372:2017	Dual Link 1.5 Gb/s Digital Interface for 1920 × 1080 and 2048 × 1080 Picture Formats, 1080p Level B

Set the HDR Payload ID

Set the Suite Signal Type in the User Setups, Suite Prefs, Suite Resources menu to modify the Payload ID parameter values to match the source video's HDR Mode, Color Space, and Bit Depth. Selecting an HDR Payload ID (S-Log3, PQ, HLG) sets all outputs for the current suite to transmit the HDR Payload ID parameter values, not that of the Frame Operating mode (SDR).

Note: GV K-Frame XP systems transmit HDR Payload ID parameter values only, signals are not converted.

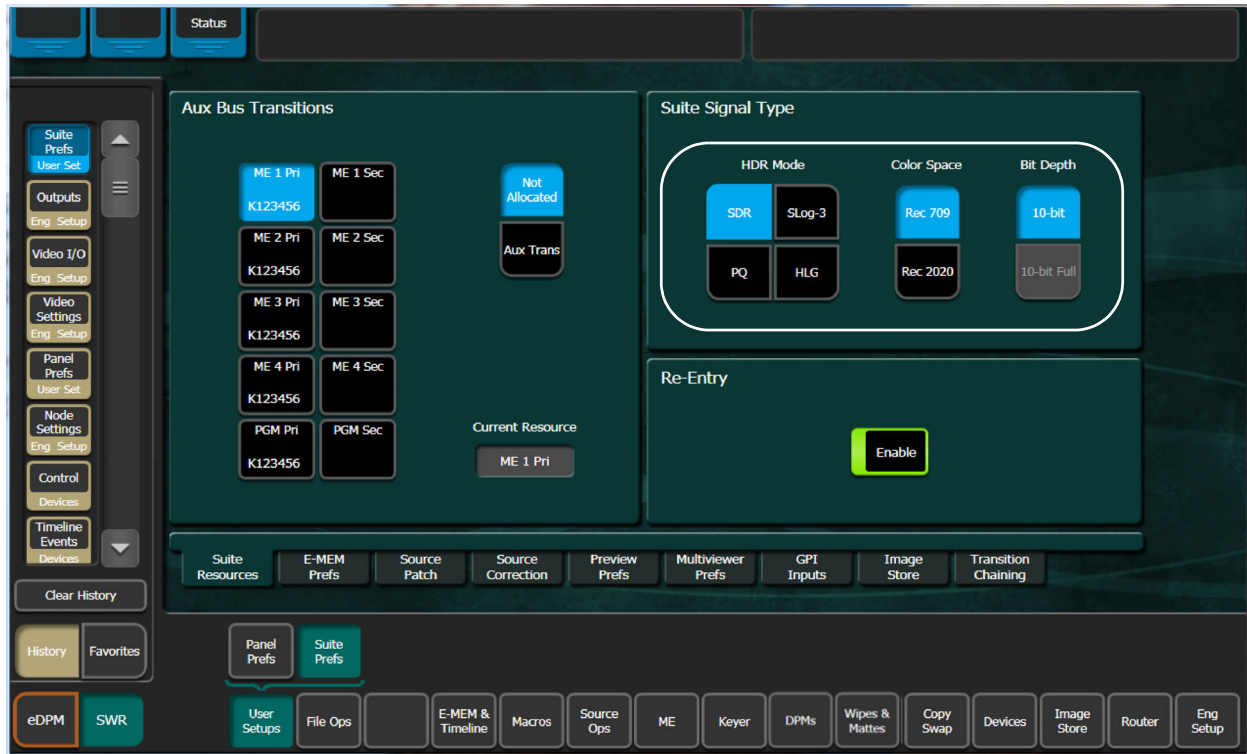

About Re-Entry

Re-entry permits the switcher to select the output of one M/E for use as an input source to another M/E. The signals are routed internally.

A Grass Valley switcher system supports M/E re-entry in any order. For example, an output of ME-2 can be sent to ME-1, and an output of ME-1 can be sent to ME-3. Infinite looping re-entry (for example, ME-1 sent to ME-2 and ME-2 sent back to ME 1) is allowed but should only be done carefully

About Source Patching

Facility engineers need to know the exact routing of all the video signals connecting all the devices they are responsible for. These engineers need to be able to identify video signals in a way that will help them connect devices properly. Production personnel, on the other hand, are interested in the content they work with for their shows, and are generally not concerned about which individual device or routing path is used to make those signals available. They just need a way to identify the content and access it when they need it. To support these differing needs, two source naming mechanisms are available on GV Switcher systems; Engineering Source ID and Logical ID.

By default, engineering source IDs are mapped one-to-one with logical IDs but Source Patching can be used to quickly set up production elements for use in a different facility. For example, a show's effects, DDR clips, and other recorded material may have been built in one production truck with one set of devices, but the next show is scheduled for a different truck. Previously, to use effects in the other truck the Technical Director (TD) would need to edit the engineering source definitions in the new truck so they exactly matched the old truck. By remapping the engineering sources of the devices in the new truck to the logical sources used to build the effects, all the effects can be used without having to edit them. Source Patching can also be used to quickly swap out a defective device during a show without having to reconfigure the engineering sources. In this case logical names seen by the production personnel would be identical for that content, even though the actual device playing the material changed.

Note: Source Patching is the bridge between engineering sources and logical sources. Both TD and EIC should make reference to the Source Patch menu when resolving source issues. The mechanism is similar in concept to a physical patch panel. Effects and all source selections are based on logical sources. Tally and associations with external devices are based on engineering sources.

The Source Patch menu scrolling list has more Logical IDs than physical inputs. These can be used to permit alternative processing of the same incoming signal. For example, the same camera input can be assigned to two Logical IDs, and one of these Logical sources can be given a Source Rule that can be cut on Key 5, and the other be given a Source Rule that cuts on Key 6. Selecting these different versions of that same source would automatically apply or clear the keys, as needed.

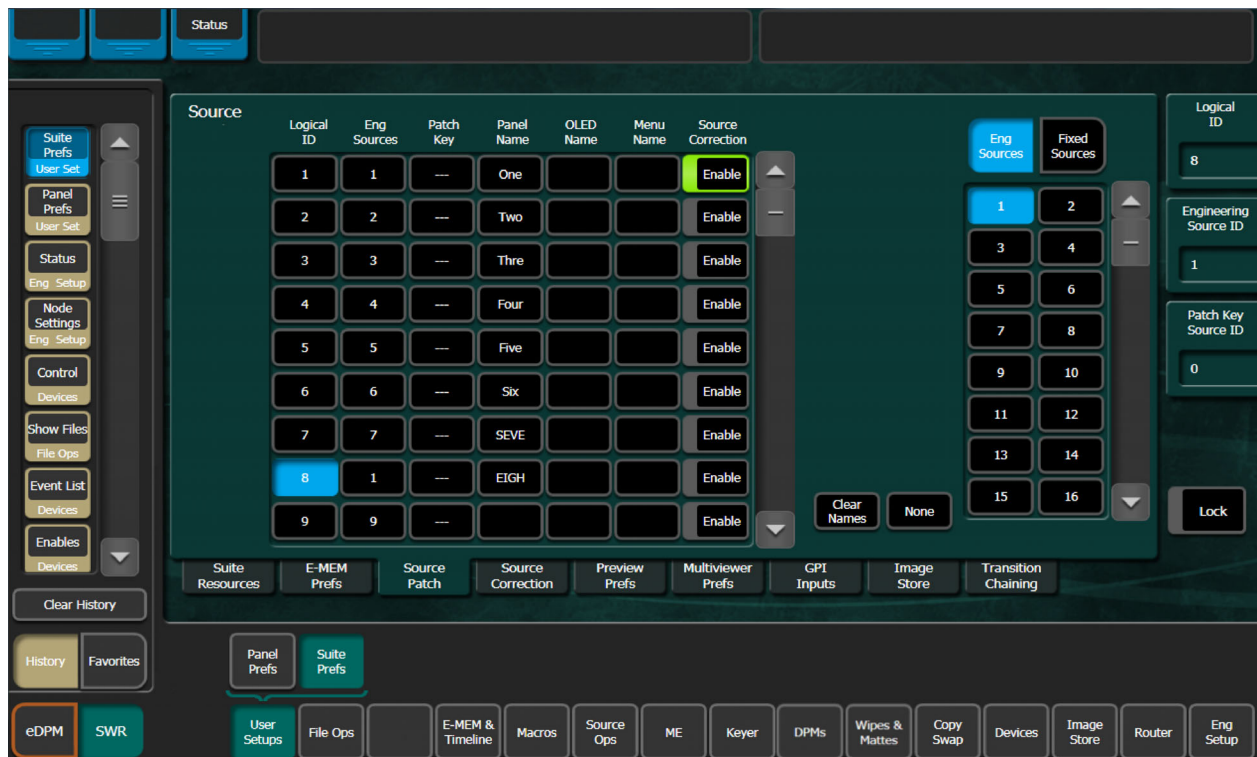

Engineering Names, Eng IDs, and Logical IDs

Engineering names are intended to identify a source as it applies to a specific facility. In a truck, for example, cameras may be hard wired to the production switcher and might be given Engineering names 1, 2, and 3. Names like Patch 14 or Rtr 5 may be used for inputs that are patched or routed. Engineering names are entered in the Eng Setup Source Definition menu, as described above. Engineering source IDs are numeric only, and are available on data pads and scroll knobs for quick selection. The GV Switcher system also has logical IDs, that can be used for source patching, as explained later.

Alternative Source Names

Alternative names can be assigned to sources for the convenience of production personnel. For example, you may give the cameras menu names that include the operator (C1 Bob, C2 Phil, and C3 Bill), but remove the operator names from the OLED names to show C1, C2, and C3 in larger characters. These alternative names are entered in the Source Patch menu.

The Source Patch menu has three editable columns for defining up to three alternative names:

A **Panel Name** is limited to four characters, to fit the space available on the Control Panel's Transition Area. This name is only displayed on the Control Panel.

An **OLED Name** appears only on the Source Name Displays on the Control Panel. Up to eight characters are displayed.

A **Menu Name** is limited to eight characters, and appears on all the GV Switcher menu application screens except Engineering Setup menus, which always display engineering IDs or names.

Multiple Suites and Source Names

Different sets of these alternative source names are defined for each GV Switcher suite. Ensure the GV Switcher Menu Application you are using is logged into the correct suite (Eng Setup, Eng Login). The same set of engineering names will be used by both suites, however.

Source Name Display Hierarchy

If a source's engineering name is left blank, the Eng ID number will be used. If no alternative names are defined for that source, then that Eng ID number will appear on all the GV Switcher system displays.

If an engineering name has been entered (see the *Kayenne/Karrera/GV Korona Installation & Service Manual*) then the engineering name will be displayed on all the system displays, including menus. Engineering names will be truncated to the character limits of the display, starting with the first character.

For alternative names entered in the User Setups, Suite Prefs, Source Patch menu, the following rules apply:

For the three editable columns: **Panel Name**, **OLED Name**, and **Menu Name**, if any of the three are left blank for that source, the first name to the left appears in that display on the system (if all three are left blank, the name in the Eng. Source Column is displayed). For example, if an alternative name is entered in the OLED Name column for a source and the other two columns remain blank, the Menu Name takes the OLED Name (OLED Name being first to the left of the Menu Name) but the Panel Name takes the Eng. Source column's name (first name to its left). If names are entered in all three alternative name columns, each area of the system displays the name entered in each column of the Source Patch menu.

Logical ID	Eng Sources	Patch Key	Panel Name	OLED Name	Menu Name	Source Correction
1	1	1	ONE			Enable
2	2	2	TWO			Enable
3	3	3	THRE			Enable
4	4	4	FOUR			Enable
5	Camera 1	---	C1	Cam1		Enable
6	CS-1	---	[CS1	[CS1		Enable
7	CS-2	---				Enable
8	CS-3	---				Enable
9	CS-4	---				Enable

It is a good practice to create the least number of names possible. This ensures consistency in the various displays and reduces the time needed to enter and edit names. If you can create short engineering names that work for both the production and engineering staff, complete naming consistency is assured. However, this level of simplicity is probably only feasible at a fixed installation where all the shows use the same source names. When multiple names are created, try to keep the first four characters unique, and make different names for the same source similar for ease of recognition.

Source Patching and Effects Portability

Source patching makes it possible to build effects on a GV Switcher system in one facility or truck, and then use those effects on a different system at another facility that has different Engineering source configurations. Building a Source Patch table prior to effects creation simplifies the migration of effects between facilities.

Plan out the sources you will use for a show, even ones that may not exist on the system where you are creating the effects. Build a list of Logical sources in the Source Patch menu without regard to the currently associated Engineering sources. After the list is built, map one of the facility's existing Engineering sources to each Logical source. If physical devices don't exist for some planned sources, substitute a dummy Engineering source. You can then build your effects and verify that they run properly. When you are satisfied with the effects, save the Suite Prefs and E-MEM effects you have created to USB Memory Stick. At the new facility, load these files into that GV Switcher system. Do not load the Eng Setups of

one facility into the other, as this will overwrite that facility's existing Engineering configuration.

Once the Suite Prefs and effects are loaded at the new facility, go to the Source Patch menu and map the appropriate Engineering sources of the new facility to the original list of Logical sources. Your effects should now run as previously designed without having to edit or rebuild them. When satisfied the effects run correctly at the new facility, save that Suite Prefs under a different name for use the next time you use this facility. Do not overwrite the original Suite Prefs, as you will need it when you return to the original facility.

Patch Engineering and Fixed Sources to Logical IDs

- 1 Select User Setup, Suite Prefs, Source Patch.

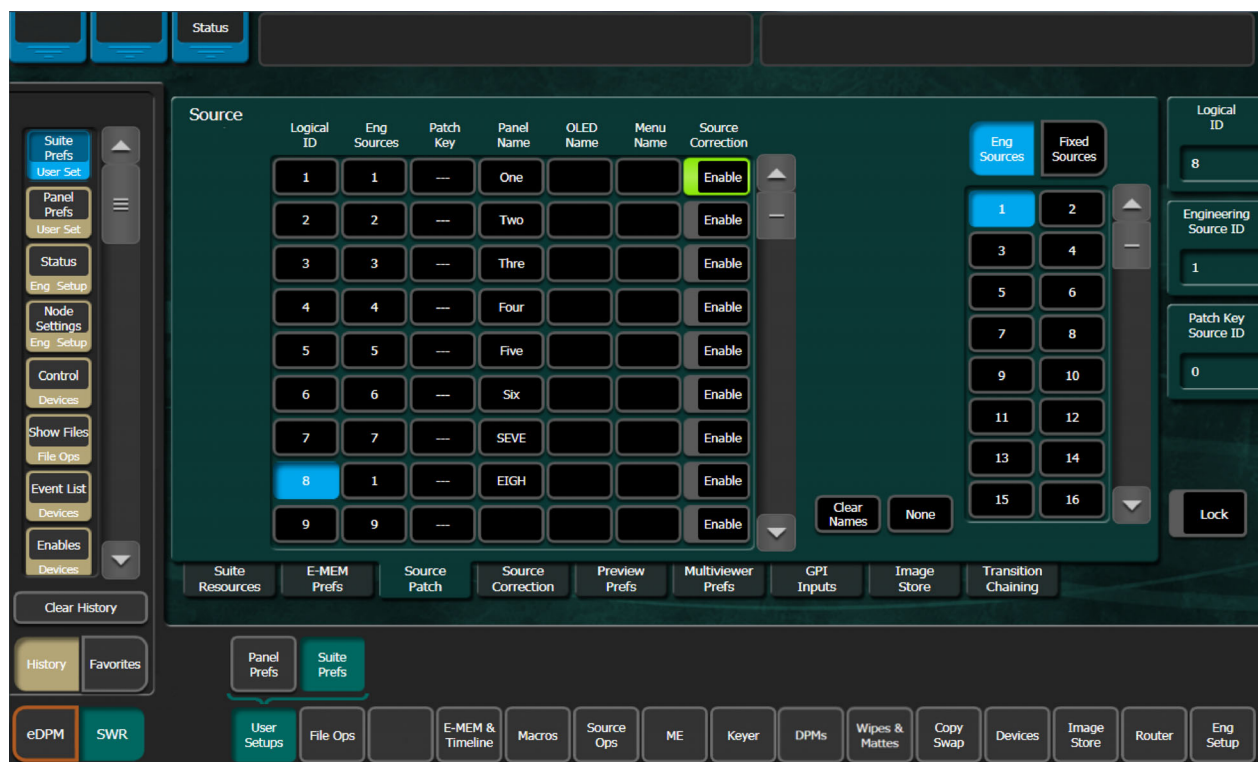

- 2 Select the Eng Sources/Fixed Sources button to select a source type.
- 3 Select the Logical ID of the source you wish to change by either:
 - Selecting the Logical ID data pad and entering the Logical ID number, or
 - Scrolling through the Source Names list with the scroll bar. This scrolls the list without changing the current selection. When the desired source appears on the menu, select its Logical ID button to select it. Use the **Lock** button to lock the scroll bar.
- 4 Give sources alternative names in the Source Patch menu in the following ways:
 - Panel Name —Source will appear in the Transition and Multi-Function displays with this name,

- OLED Name (SND Name column)—Source Name Display will appear in mapped M/E/PGM PST Source Select and the Multi-Function displays with this name,
- Menu Name (Menu Name column)—Source will appear with this name in the menus only.

To change the source patching, select an Engineering/Fixed source to be associated with the currently selected Logical source with the Engineering Source data pad or by scrolling the Engineering Source IDs Button pane.

Enable Source Correction on any Source (Globally)

Using Source Corrections, in the User Setups, Source Patch menu (or the Source Corrections menu), you can enable source correction for a patched Engineering to Logical source. The source correction is global; anywhere the patched source is mapped on the switcher. Source Correction is saved as part of File Ops, User Setups, Suite Prefs and can be included/excluded.

Note: Enabled Source Correction on a source is not supported by E-MEM, however patching a source on an M/E, from the Source Corrections menu is supported.

- 1 Choose the source and enable Source Correction:
 - a In the User Setups, Suite Prefs, Source Patch menu, select the Enable button to the right of the desired Source Patch row, or
 - b In the Source Correction menu, select the Logical Name data pad and enter the Logical ID in the pop-up keypad then turn on the Source Correction Enable button.
- 2 Adjust the parameters for Video Processing and RGB Color Correction in the Source Correction menu.

Note: The same Engineering source can have Source Correction enabled or disabled by patching the source to a different logical ID.

Patch a Key Input from Another Source

You can patch a key from a different source using Patch Key.

- 1 Select **User Setup, Suite Prefs, Source Patch**.
- 2 Select the data entry pad in the Patch Key column for the Logical ID you wish to patch a key from a different source.
- 3 Select the Eng or Fixed source in the Sources scrolling list containing the key you wish to patch (LOGO KEY in the example) or press the Patch Key Source ID data pad and enter the Source ID number for the key you wish to patch, and press **Enter**.

The key signal for Logical ID 19 (LOGO KEY) is now paired with the Logical ID 16 (RED VID) video signal.

Example: There are three shows with three different video sources over the same key signal, in this case the station logo. The three logos are defined as RED LOGO, BLU LOGO, and GRN LOGO in the menus and as RLGO, BLGO, and GLGO in the Panel Name which will be displayed on the OLEDs of the keyer source select buttons when assigned to the Control Panel.

About Default Keyframe

Default Keyframe settings are applied when an empty register is recalled and when the **CWB** (Clear Working Buffer) button is pressed in the Master E-MEM (**EMEM Edit**, **CWB** button) of the Control Panel.

- **SPOP (Single Press)** clears the working buffer of enabled levels to Default Keyframe, however it does not clear the source memory.
- **DPOP (Double Press)** clears the working buffer of enabled levels to Default Keyframe and clears the source memory to the default settings for sources selected on enabled levels.

The Default Keyframe menu is used to learn the current Control Panel state to the system's Default Keyframe (and to set the Default Keyframe back to factory settings). Individual settings for each M/E are stored in the Default Keyframe, so different states can be saved for different M/Es, if desired.

Note: Individual Default Keyframe settings are saved for each GV Switcher M/E.

Learn a Default Keyframe

1 Select **User Setups, Suite Prefs, E-MEM Prefs.**

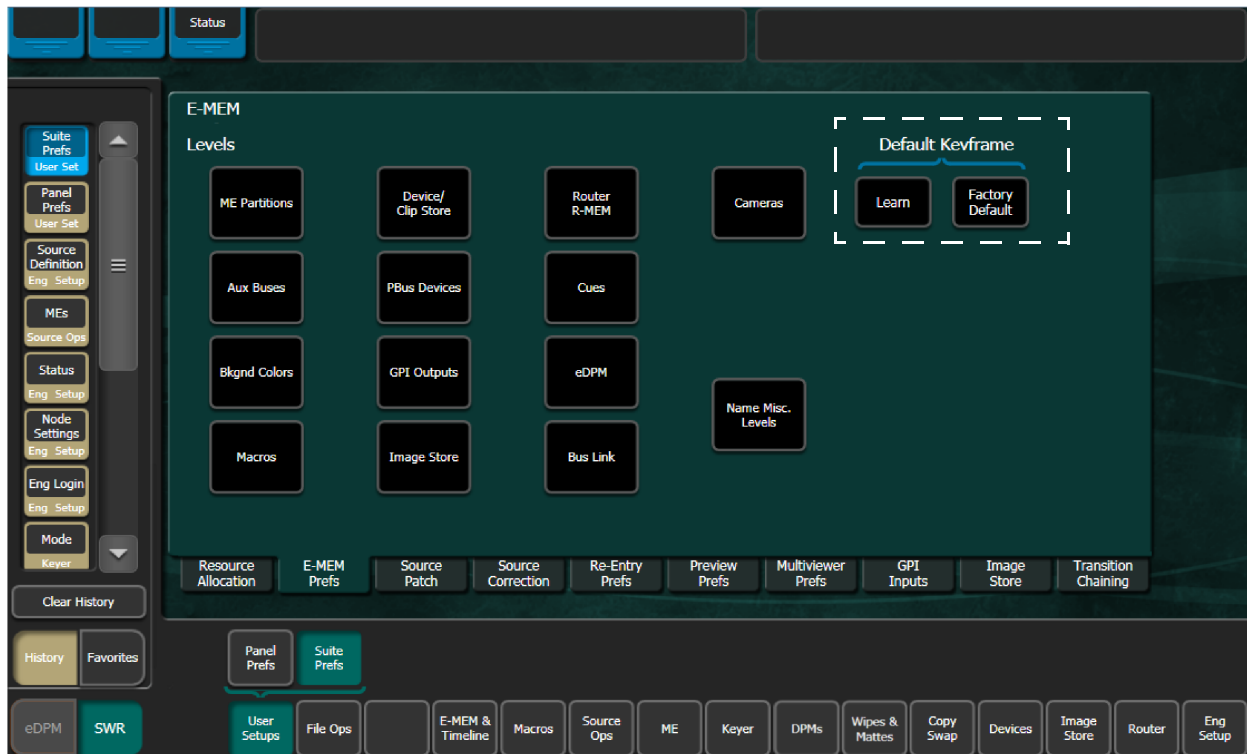

- 2 Setup the Control Panel to the desired state.
- 3 Press the **Learn** button in the Default Keyframe pane.

Note: Individual Default Keyframe settings are saved for each M/E.

- 4 Save your learned Default Keyframe settings in the File Ops, E-MEM menu.
 - Pressing the **Factory Default** button overwrites the Default Keyframe with factory defaults.

About the Preview Prefs Menu

Preview displays on the Preview Prefs menu can be adjusted by the user, including Safe Area borders, Crosshairs, and the selection of optional multi-image M/E Viewer layouts.

Preview Prefs buttons on the left, select the M/E or Switched Preview that will be affected by the settings on the right. Each M/E has Primary and Secondary Preview parameters for

Safe Area and Crosshairs, and an M/E Viewer layout. Switched Preview has a single set of parameters for Safe Area and Crosshairs.

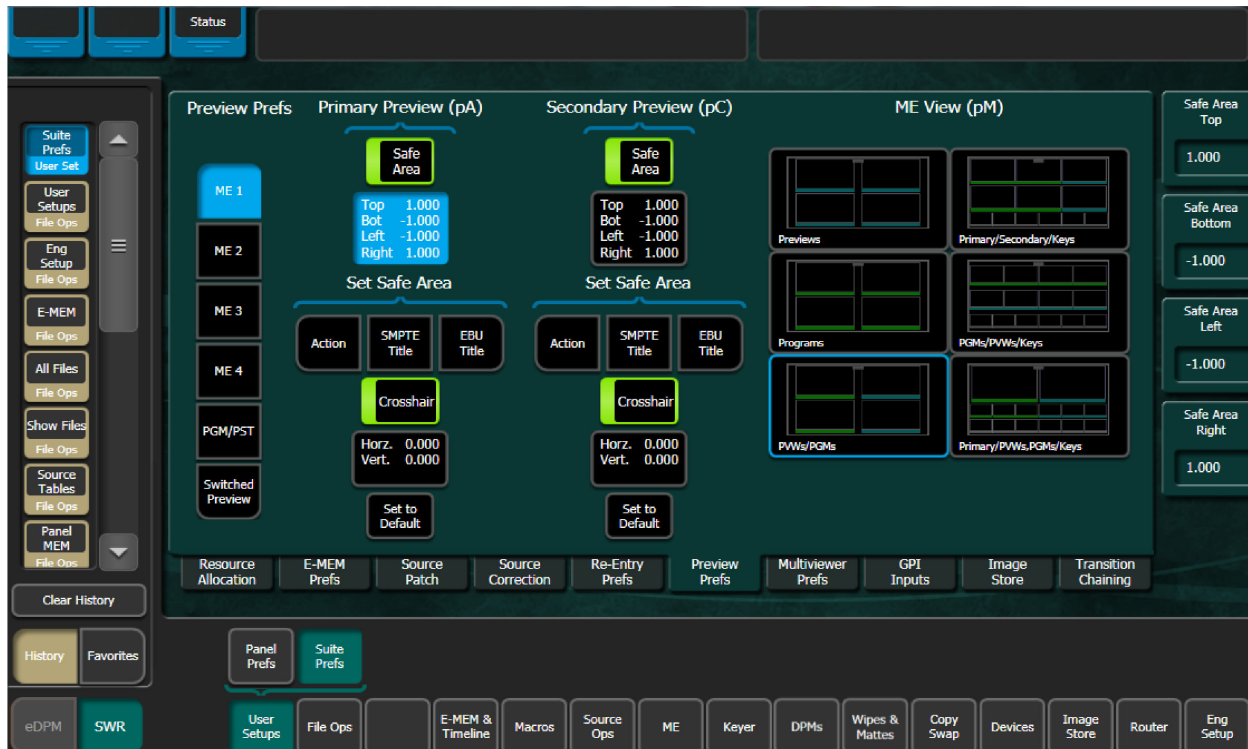

Safe Area

- The **Safe Area** button, when enabled, activates the Safe Area border display for the selected preview.
- The **Set Safe Area** data pad displays knob controls on the right used to move the Safe Area borders.
- The **Action**, **SMPTTE Title**, **EBU Title** buttons set the safe area borders to those standards.

Crosshair

- The **Crosshair** button, when enabled, displays a Crosshair for the selected preview.
- The **Crosshair** data pad displays knob controls on the right used to adjust the position of the Crosshair.
- The **Set to Default** restores the default center position for the Crosshair.

About File Operations

The Switcher menu file browser allows you browse through folders on the local Menu Panel hard disk, the GV Switcher Video Processor Frame, and the entire network file hierarchy of mapped drives. In the File Operation menus, you can:

- Navigate through the Frame User Directory on the Video Processor (System Storage menu tab) and access the Menu Panel and all mapped network drives including USB Memory Sticks (Remote Storage menu tab),

- Save and Load Show, User Setup, Panel Memory, E-MEM, Macro, Source Rules, Cues, e-DPM, R-MEM, and Eng Setup files,
- Organize collections of files as Shows,
- Sort files by name, type and in reverse alphabetical order,
- Create new folders,
- Copy/Paste, and Delete files,
- Rename files and folders, and
- Select multiple files.

Introduction

Switcher system files are saved to the location that has been navigated to with the browser, creating copies of the information currently in use by the system. Files are copied from one location to another without affecting the current operation. File information is loaded to the switcher system RAM, and this immediately affects system operation and resources.

Drive Access

File Operation menus can access directories located on the Compact Flash in the Video Processor Frame (System Storage) and the Menu Panel hard drive. Local and network drives mapped on the Menu Panel's Windows system are also accessible (Remote Storage). Standard Windows functionality automatically maps all local drives during startup. Mapping network drives to a drive letter using Windows Explorer allows mapped drives to appear in the file hierarchy.

File Storage Organization

The file browser gives you great flexibility for choosing and creating storage locations for your files. Any number of folders can be created in various locations. File folders and the files themselves can be named in any manner. To prevent accidentally saving and loading incorrect files, your facility should establish file storage and naming conventions and follow them consistently.

The engineer in charge should create default Panel and Suite Prefs files that are not to be modified by anyone, and shared by everyone. These can provide a known starting point for users when they build their own preference files.

Experienced users may want to create their own sets of preference files and save only critical ones in the Frame User directory. Other files can be loaded using the browser from any directory or be placed on a personal USB Memory Stick.

Use the Show feature to manage groups of files routinely used together for a particular production.

Save important files to the Menu Panel hard drive and a USB Memory Stick for backup, clearly label each (perhaps including the date), and store them in a safe place.

About the File Ops Menus

Each File Ops menu category (Show Files, All Files, User Setups, etc.) has a Utilities Pane, with buttons to perform Copy, Paste, Delete and Create Folder operations and a Multi-Select toggle button.



Copy and Paste Files

- 1 Navigate to the System or Remote Storage menu tab directory containing the file to be copied, using the Top Directory, Up Directory, and Open Selected (or double-touch/click the file icon) buttons.
- 2 Select the file(s) to be copied (choose the Multi-Select button for multiple files)
- 3 Select the **Copy** button. A new pane with its own scroll bar will appear to the right. Top, Up, and Open navigation buttons will also appear for the right-hand pane. Files can only be pasted to the new right-hand pane. The Delete, Create Folder, and Rename functions apply to the left-hand pane only, and are inactive during a Copy/Paste operation.
- 4 Navigate the right-hand pane to the desired directory, using its navigation buttons.
- 5 Select the **Paste** button. A message indicating the file is being copied will be displayed, and when finished the right-hand pane will close.

Note: Use clear naming conventions and logical directory structures when creating folders and renaming files so you can reliably reload the correct versions of these files when you need them.

Delete Files

- 1 Navigate to the directory containing the file(s) to be deleted, using the Top Directory, Up Directory, and Open Selected (or double-touch/click on the file icon) buttons.
- 2 Select the file icon(s) to highlight it.
- 3 Select the **Delete** button.

Create a Folder

- 1 Select the **Create Folder** button.
- 2 Enter the folder name in the pop-up keyboard and select **Enter**.

Rename Files

- 1 Navigate to the directory containing the file to be renamed, using the **Top Directory**, **Up Directory**, and **Open Selected** (or double-touch/click on the file icon) buttons.
- 2 Select the file icon to highlight it (only one file can be renamed at a time).
- 3 Select the **Rename** button.
- 4 Enter the new file name in the pop-up keyboard and select **Enter**.

GV Switcher File Type Extensions

Switcher files are named by the user when saved. The name appears below the icon.

GV Switcher System File Extensions

Icon Example	File Type	Extension
	Panel Prefs	.GVC .GVF .GVJ
	Suite Prefs	.GVS .GVZ
	Eng Setup	.GVE .GVH. .GVN
	E-MEM Register	.GVR
	R-MEM Register	.GVY
	Panel Memory Register	.PMEM
	Cues Register	.GVB
	e-DPM Register	.GVI
	Image Store	.EIF
	Macro Register	.GVG
	Source Rules	.GVL
	Show Folders	.GVV

The extension is added to the file automatically when saved, but is not displayed as part of the file name itself. To prevent confusion, do not try to add an extension to the file name when saving files.

File icons not generated by the switcher show the file name with extension, and display the extension letters in the icon.

About Show Files

A Show is a special collection of GV switcher files that can be managed as a group. You can create and load a show file that contains all of your switcher preferences and settings or you may want to customize your show by loading some and not others. Both can be accomplished from the Show Files menu.

Show File Buttons

- **Create Show:** opens a create show pane. In this pane you enter the name of the Show (select the **Show Name** data pad), and if you choose, disable or enable switcher preferences and settings and choose a range of registers that will be included in the Show file.
- **Load Show:** immediately loads all the files in the currently selected show into the GV Switcher system. This operation will overwrite the existing preferences and settings that are currently being used. While the current work buffer and video outputs will not be affected, other aspects of system operation (source mapping, source name displays, available effects, etc.) will change depending on what files are being loaded.

Note: Verify that the Show includes/excludes the desired preferences and settings before loading, especially if the system is currently on-air.

- **Choose Load:** brings up a pane that allows you to see what files are contained in the Show, and select which preferences and settings to load. Buttons for switcher areas not present are grayed out. By default all the switcher area preferences and settings saved as part of the show are selected for load.
- Specify the preferences, settings, and register ranges, then select the **Load** button.
- **Clear and Replace:** removes and all preferences, settings, and ranges so you can limit what is loaded into the Show file so it is not a cumulative load/overwrite.
- **Select All:** (toggle) button selects or deselects all the available preferences and settings.
- **Create:** saves the show into the currently selected directory. A pop-up panel displays the status of each preference and setting as the Show file is created.
- **Update Show:** brings up a pane that allows you to select specific preferences and settings within a show to update and specify each and enter register ranges where applicable. Selecting the **Update** button completes the operation.

Note: A best practice is to set register ranges to all each time there is an update (e.g. E-MEM 0-999, Macro 1-999, etc.), this will ensure that new registers are included.

Create a Show File

1 Select **File Ops**, **Show Files**.



CAUTION: : The Eng Setup button (lower right of menu) is off by default because ports and server IPs are unique. Transferring Show files from one location to another (including suites) requires careful planning to prevent interruption.

- 2 Select the **Create Show** button in the Show Create & Load pane.
- 3 Select the **Show Name** data pad, type a name for the Show file in the pop-up keyboard, and select **Enter**.
- 4 Optionally, configure the show granularity:
 - a In the Create Show pane, select the buttons to enable or disable preferences and settings; a highlighted green border means that area of the system will be included in the new show.
 - b Select a register data pad and enter values using the pop-up keypad.

TIP: Use the register data pads left of the load granularity buttons to enter a series or range of registers as part of the load (the default is all).

Note: A best practice is to set register ranges all each time there is an update (e.g. E-MEM 0-999, Macro 1-999, etc.), this will ensure that new registers are included.

- 5 Select the **Create** button in the Create Show pane.

Result: The Show file is created with the selected file types and appears in the directory.

Load a Show File

You can include or exclude areas of the system when loading a show using the Show Create & Load menu pane. Including an area will change the state of that part of the system to the loaded state.

- 1 Select **File Ops, Show Files**.

CAUTION: : The Eng Setup button (lower right of menu) is off by default because ports and server IPs are unique. Transferring Show files from one location to another (including suites) requires careful planning to prevent interruption.

- 2 Select a Show file to load from the System or Remote Storage menu tab (left side of menu) and select it.
- 3 Load the show:
 - a To load the Show file as is, select the **Load Show** button in the Show Create & Load pane.
 - b To load only selected areas, select the **Choose Load** button to bring up the Create Show pane that allows you to see what areas are included in the Show, and enable or disable the buttons; a highlighted green border means that area of the system will be included when the show is loaded.
- 4 For register-based features, you can enter an exact range; select the register data pad (left of each button) and enter a series or range of registers to be included in the Show file (the default is all).

Note: A best practice is to set register ranges to all each time there is an update (e.g. E-MEM 0-999, Macro 1-999, etc.), this will ensure that new registers are included.

- 5 Select the **Create** button in the Create Show pane to load the Show file (not the Load Show button as this will load the entire Show file without your selections).

Load a Show from the Show Load History

Shows that have been loaded, are displayed in the Show Load History pane on the right side of the Show Files menu. The list of previously loaded shows are displayed (until the **Clear History** button is selected). The "Last Show Load" reflects the date and time that the top item in history, was loaded—in the current menu.

- 1 Select **File Ops, Show Files**.
- 2 Select a previously loaded show from the Show Load History scrolling list on the right.

The selected show file is automatically displayed in the left-hand directory pane.

- 3 Select the **Load Show** button.

Note: A pink highlighted load list item means a full show, otherwise it is a partial show.

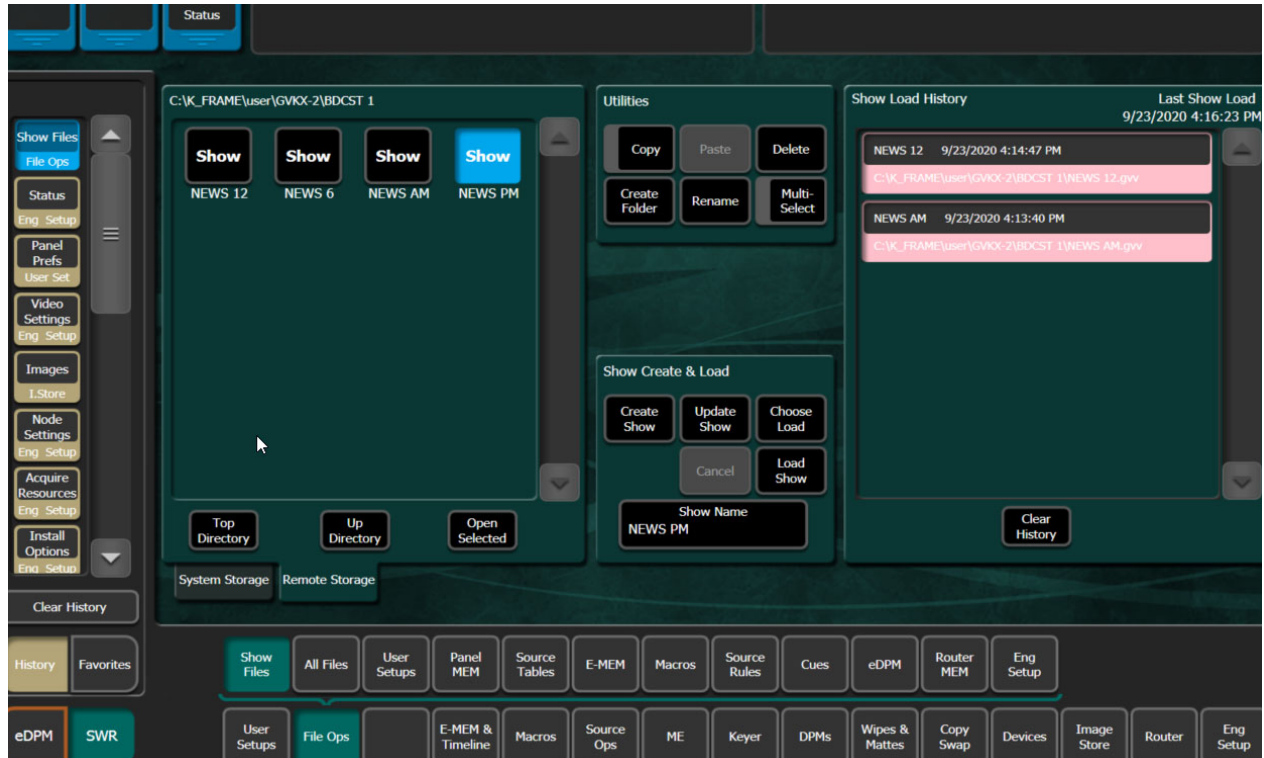

Update a Show File

1 Select **File Ops**, **Show Files**.



CAUTION: : The Eng Setup button (lower right of menu) is off by default because ports and server IPs are unique. Transferring Show files from one location to another (including suites) requires careful planning to prevent interruption.

- 2 Select the Show file from the System or Remote Storage menu tab (left side of menu).
- 3 Select the **Update Show** button in the Show Create & Load pane to bring up the Create Show pane that allows you to see what preferences and settings are enabled.
- 4 Optionally, in the Create Show pane, enable or disable preferences and settings or you can enable the **Select All** button (e-DPM is an option, if not installed the button will be inactive).
- 5 To change the registers loaded, select the register data pad (left of each button) and enter a series or range of registers to be included in the Show file (the default is all).

Note: A best practice is to set register ranges to all each time there is an update (e.g. E-MEM 0-999, Macro 1-999, etc.), this will ensure that new registers are included.

- 6 Select the **Update** button in the Update Show pane.

About the File Ops, All Files Menu

The File Ops, All Files menu is used to quickly sort and locate files by using the **Sort By Type**, **Sort By Name**, and **Reverse Order** (reorders the current sort to ascending or descending) buttons and manage all files types in the System and Remote Storage menu tab directories. Use the Utilities pane buttons to perform file operations.

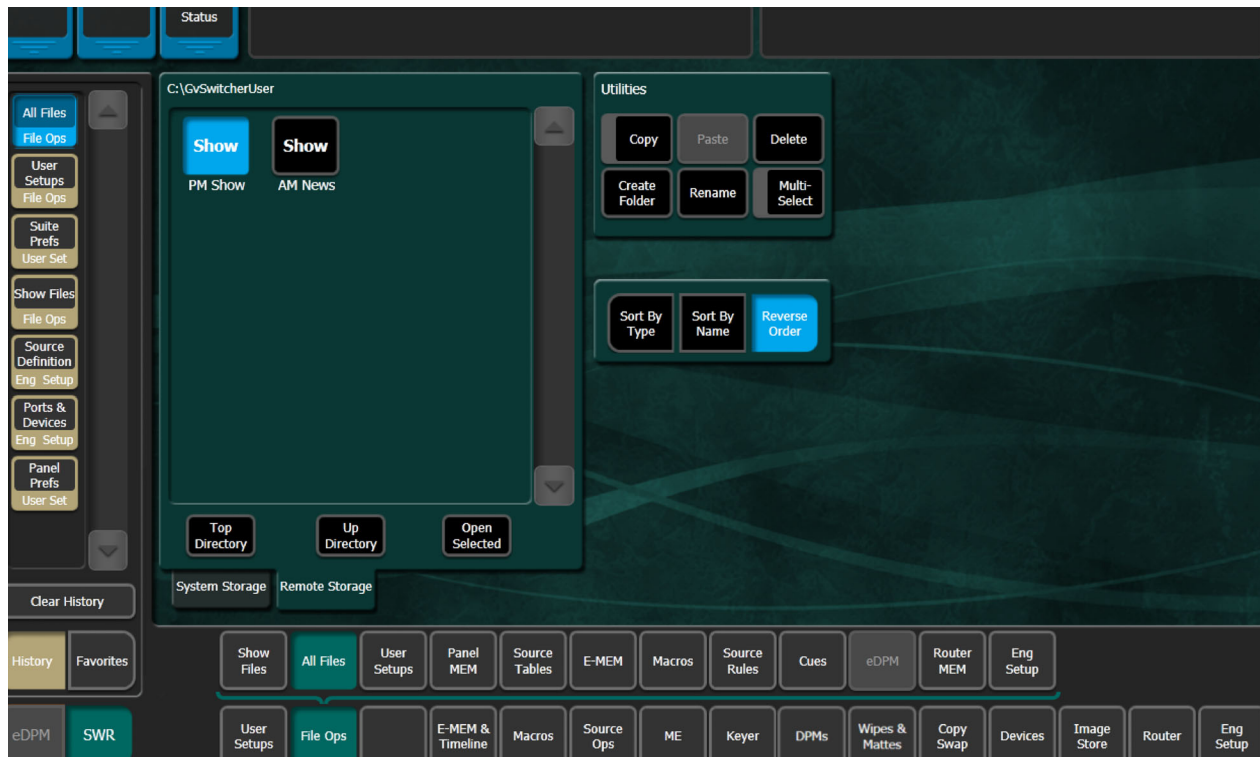

Save User Setups

Selecting a User Setup file in the System or Remote Storage menu tab and selecting **Save** overwrites the file.

- 1 Select **File Ops, User Setups**.

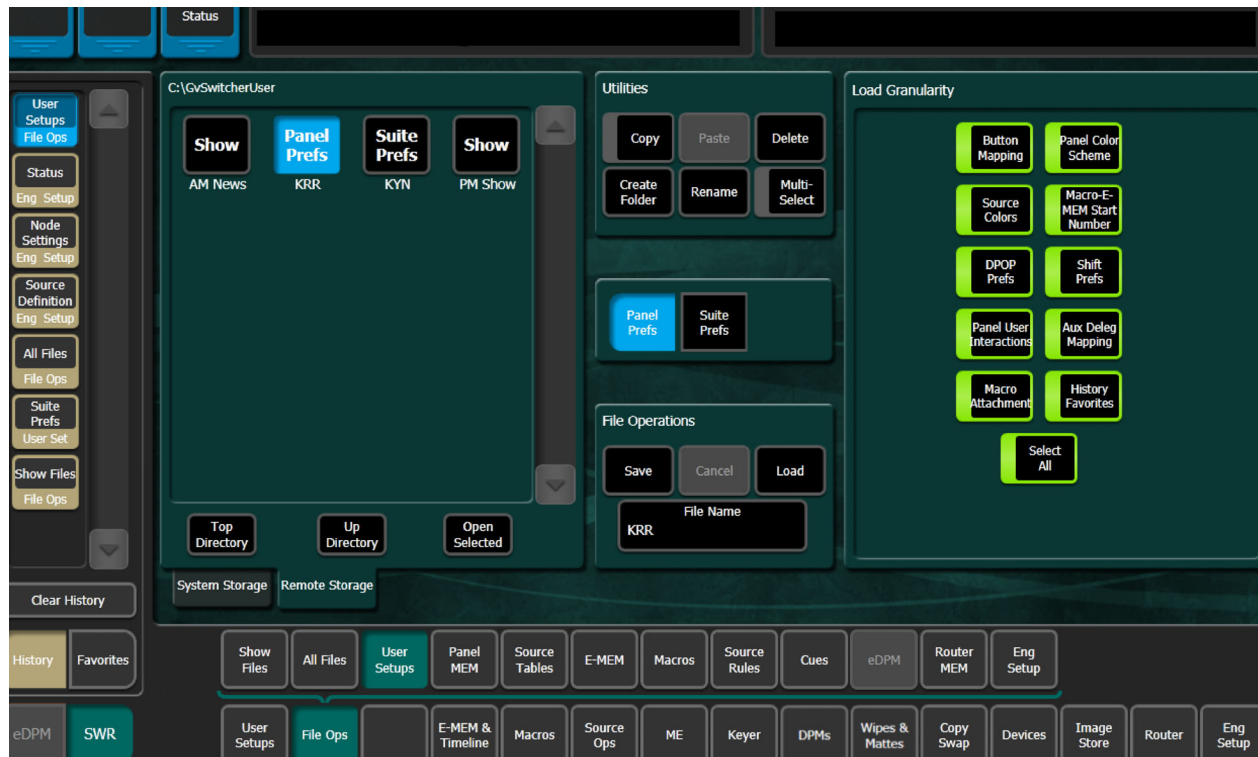

- 2 Select **Panel Prefs** or **Suite Prefs** button.
- 3 In the System or Remote Storage menu tab (left side of menu), navigate to the folder you want the User Setup to be saved.
- 4 Optionally, enable or disable preferences and settings or enable the **Select All** button in the Load Granularity pane.
- 5 Select the **Save** button in the File Operations pane.

Load User Setups

- 1 Select **File Ops, User Setups**.

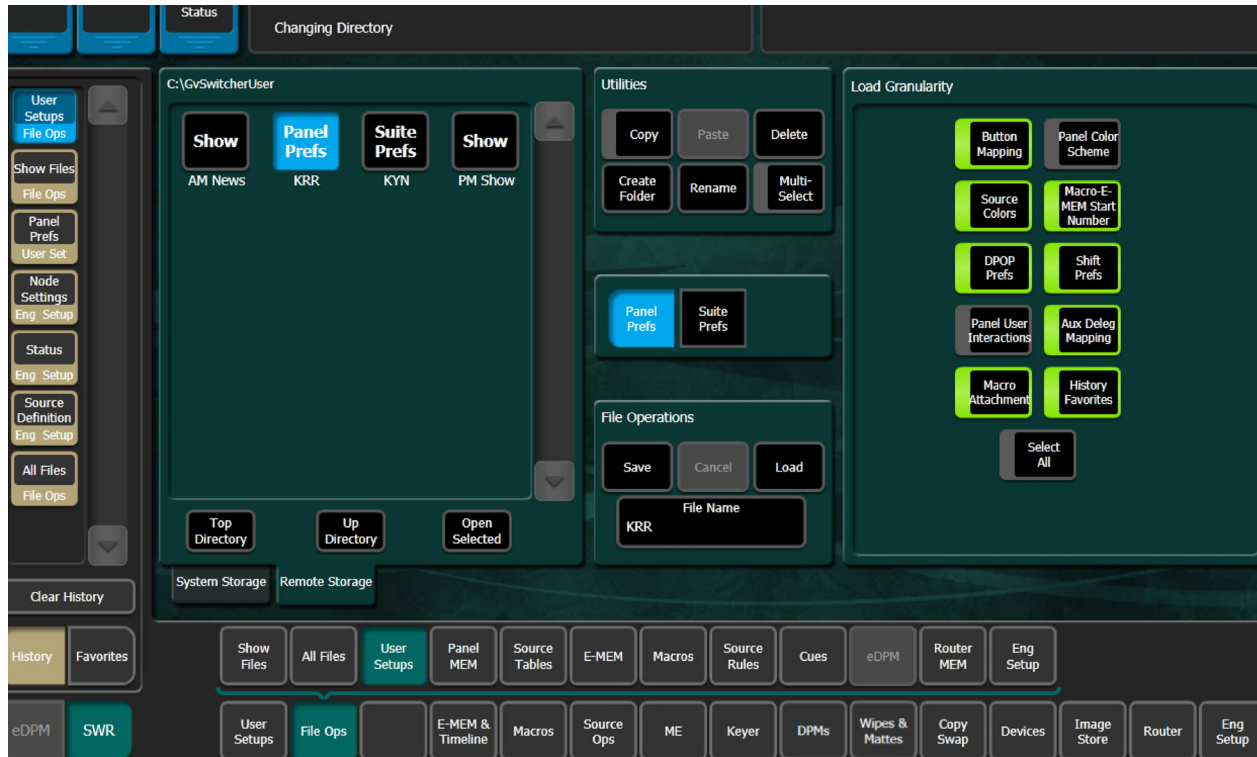

- 2 Select **Panel Prefs** or **Suite Prefs** button.
- 3 In the System or Remote Storage menu tab (left side of menu), select a **Panel Prefs** or **Suite Prefs** file.
- 4 Optionally, enable or disable preferences and settings or enable the **Select All** button in the Load Granularity pane.
- 5 Select the **Load** button.

CAUTION: : The Load button immediately replaces configurations the system is currently using with the selected preferences and settings. When setups are loaded, significant changes to system operations are possible.

Save Source Tables or Source Rules

Save operations for the Source Tables and Source Rules menus are identical. Saving Source Tables will be described in this example.

Note: Selecting a Source Rules or Source Tables file in the System or Remote Storage menu tab and selecting **Save** overwrites the file.

- 1 Select, **File Ops, Source Tables**.

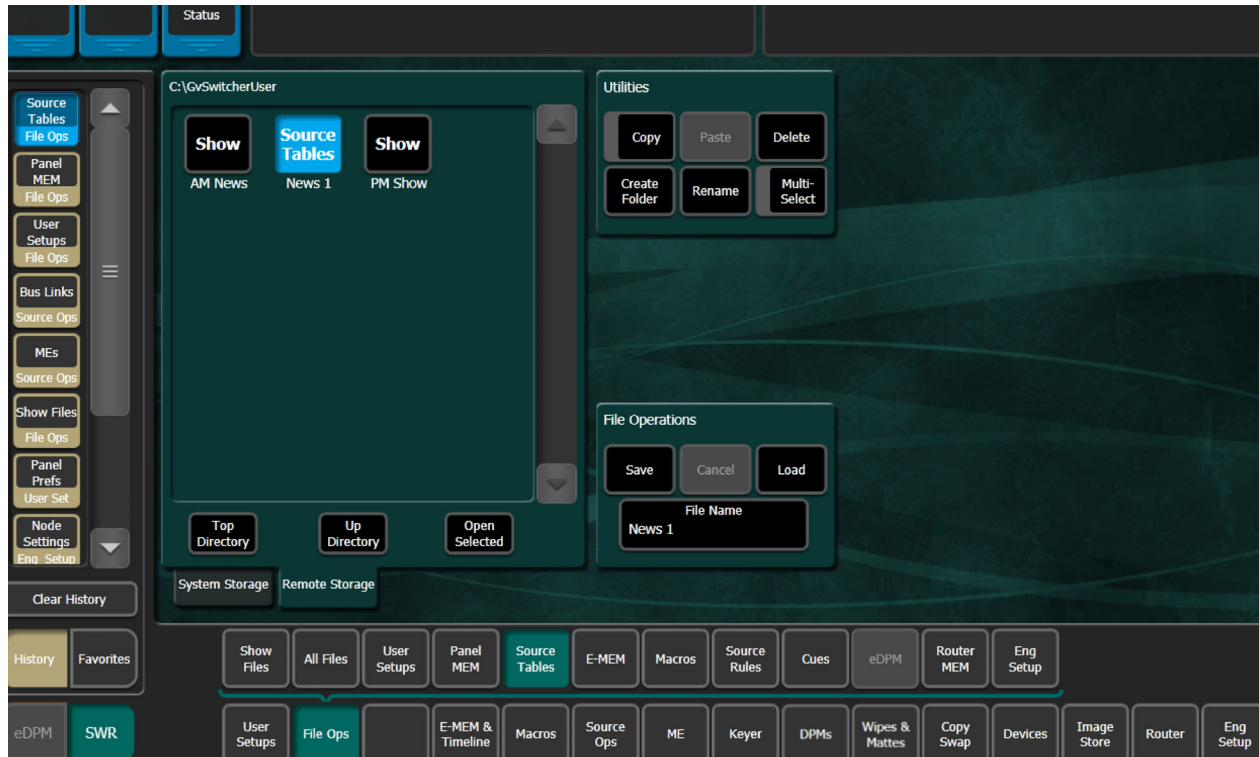

- 2 In the System or Remote Storage menu tab (left side of menu), navigate to the folder you want the Source Tables file to be saved.
- 3 Select the **Save** button in the File Operations pane.

Load Source Tables or Source Rules

Load operations for the Source Tables and Source Rules menus are identical. Loading Source Tables will be described in this example.

- 1 Select, **File Ops, Source Tables**.

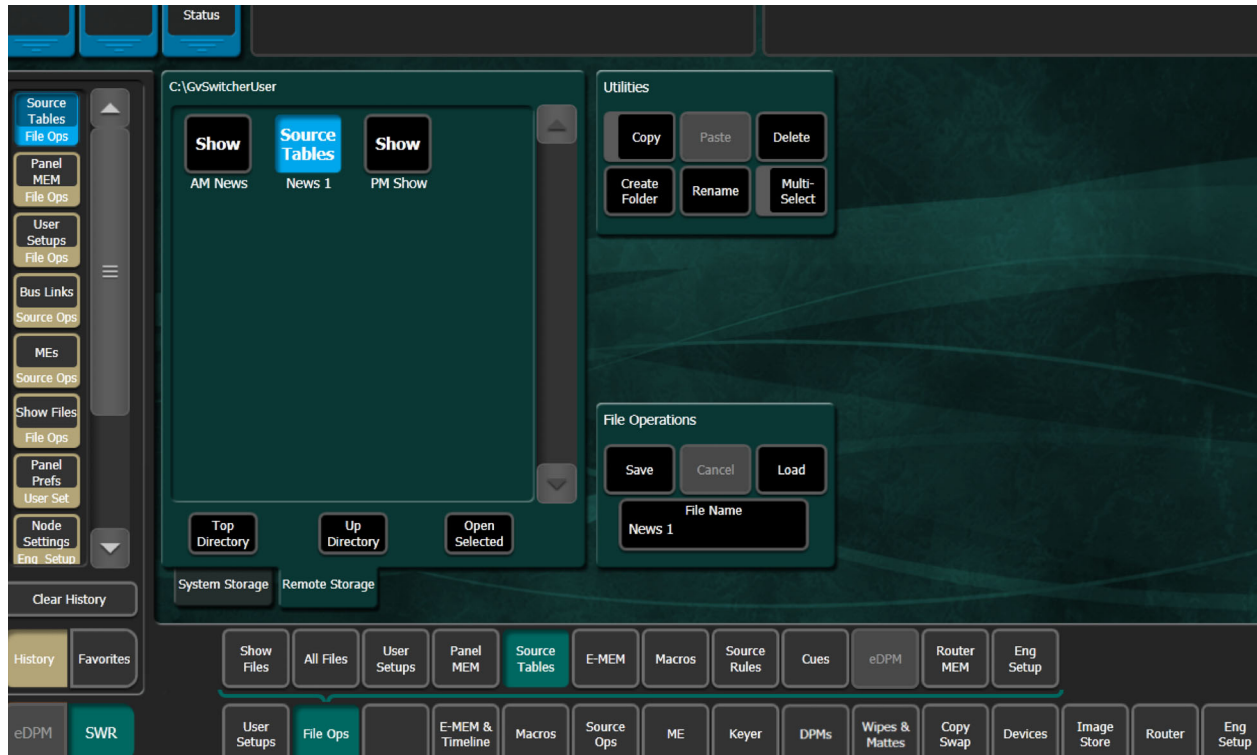

- 2 In the System or Remote Storage menu tab (left side of menu), navigate to the Source Tables file you want to load.
- 3 Select the **Load** button in the File Operations pane.

About Register-Based File Ops Menus

File operations for the Panel MEM, E-MEM, Macros, Cues, and Router MEM register-based menus, are nearly identical, the difference being the number of registers, for example the E-MEM menu has 1000 register files while the Macro menu has 999, and Router MEM has 100, and so on. Keep this in mind when entering registers.

Buttons in the Utilities pane and most of the File Operations pane buttons are the same as all the File Ops menu (see [About the File Ops Menus](#)), however, the Register function buttons in the center of the menu and others in the File Operations pane, are unique to register-based menus:

Register files are named by their bank and register number. For example, the filename for E-MEM register 5 in Bank 2 would appear as EMEM25. File names consist of the bank and register appended with.GVR. It is important that these files retain these names, as the number determines which register will receive the data when loaded. In fact, register files

saved locally to the Frame C: drive cannot be renamed. If you try to rename an E-MEM file on the Frame C: drive an error message will appear in the message area. If for some reason an E-MEM file needs to be renamed, copy it to a local drive and rename it.

Each menu is similar to the other File Ops menus with the System and Remote Storage menu tabs on the left and the same navigation and action buttons in the center.

Register pane buttons:

- **All**—all registers are loaded.
- **Enter Reg(s)**—when selected, displays a Registers (s) data pad allowing you to enter serial registers or an exact range of registers, for example 2-4,6,8-9 using the **Next (,)** and **Thru (-)** buttons.

Note: Excluding empty registers reduces load times.

- **Select Reg(s)**—allows you to select one or multiple (using the **Multi-Select** Utilities button) E-MEM registers from the System or Remote Storage menu tab directories.
- **Start Register**—when enabled, allows you to start one or a multiple registers at any register number. Subsequent registers will be offset from the Start Register value.

Save Files in Register-Based Menus

Save operations for the Panel MEM, E-MEM, Macros, Cues, and Router MEM menus are identical. Saving E-MEM files will be described in this example.

Note: Selecting a register file in the System or Remote Storage menu tab and selecting **Save** overwrites the file.

1 Select, **File Ops**, **E-MEM**.

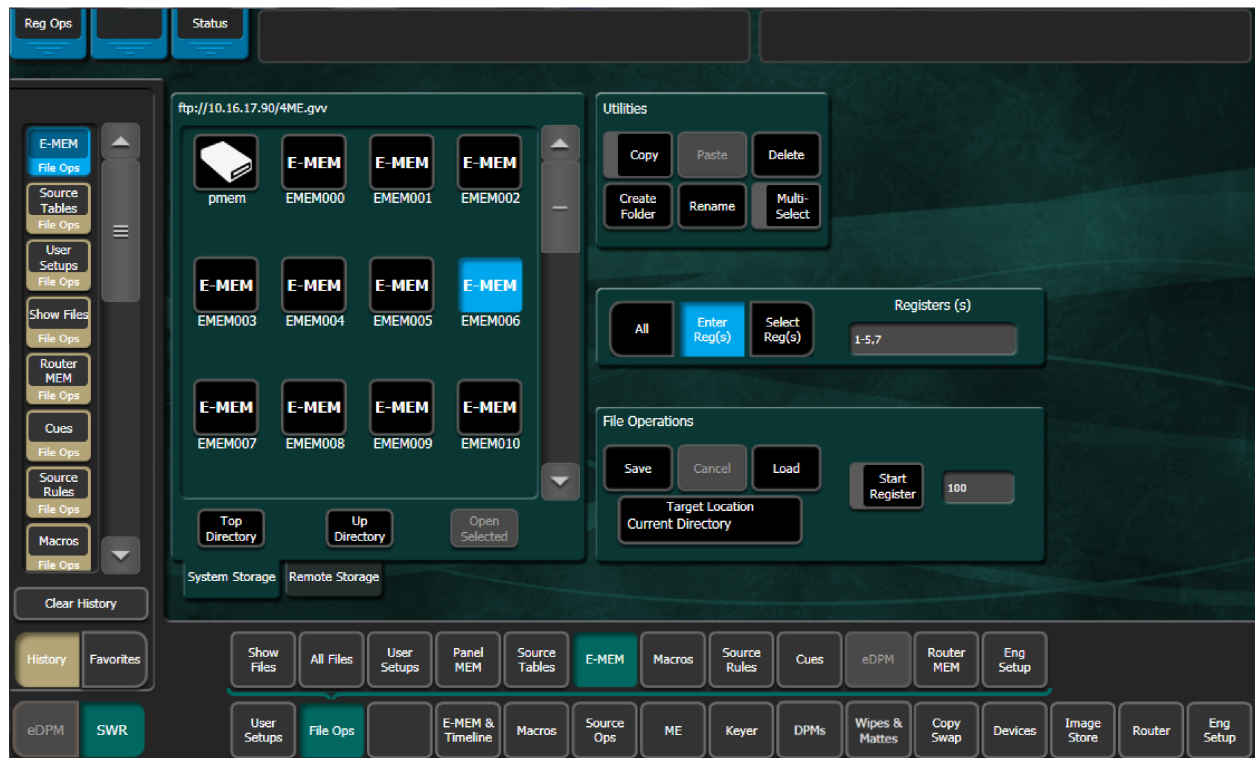

- 2 In the System or Remote Storage menu tab (left side of menu), navigate to the folder you want the registers to be saved.
- 3 Select **All** or enter specific registers or a range of registers and/or a start register.
- 4 Select the **Save** button in the File Operations pane.

Load E-MEM Registers

Load operations for the Panel MEM, E-MEM, Macros, Cues, and Router MEM menus are identical. Loading E-MEM registers will be described in this example.

- 1 Select, **File Ops, E-MEM**.

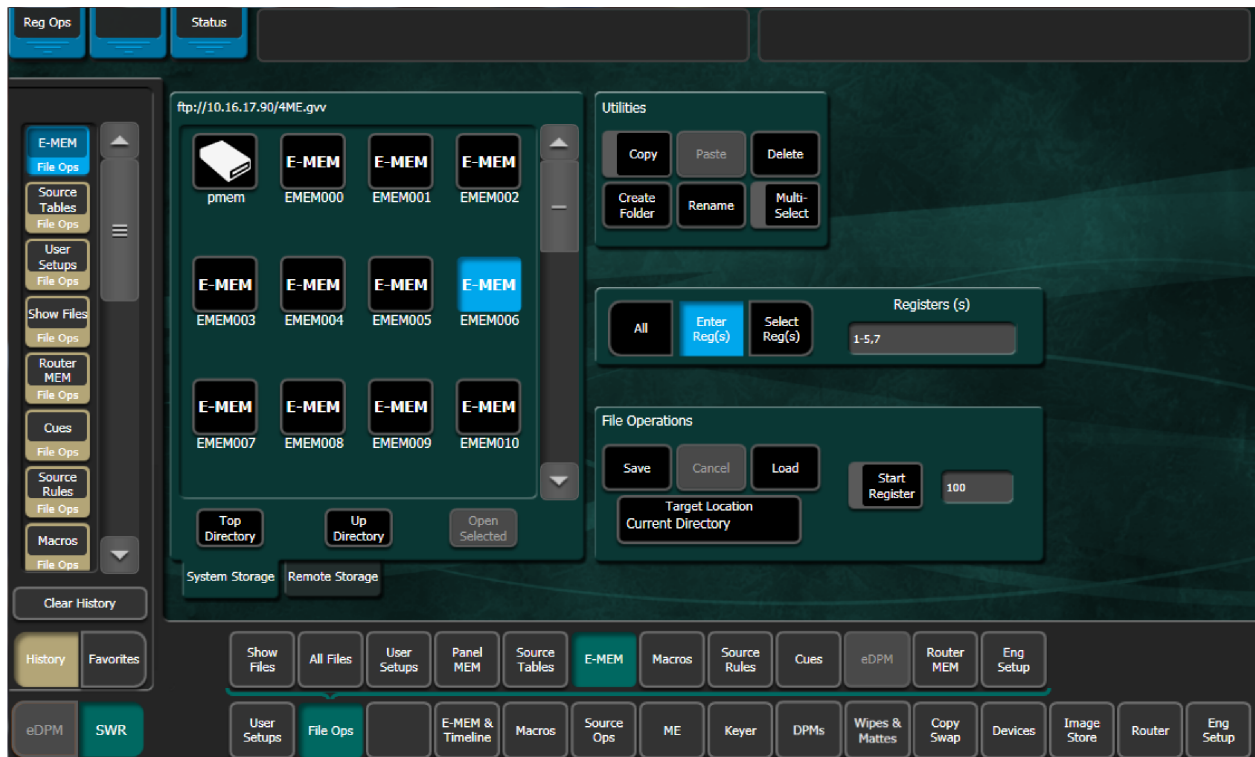

- 2 In the System or Remote Storage menu tab (left side of menu), navigate to the folder containing the registers to be loaded.
- 3 Select **All** or enter specific registers or a range of registers and/or a start register.
- 4 Select the **Load** button in the File Operations pane.

Load Registers with an Offset

Use the **Start Register** button and data pad in the register-based File Ops menus to load registers with an offset for the Panel MEM, E-MEM, Macros, Cues, and Router MEM menus. Loading E-MEM registers with an offset will be described in this example.

- 1 Select, **File Ops, E-MEM**.
- 2 In the System or Remote Storage menu tab (left side of menu), navigate to the folder containing the registers to be loaded.
- 3 Select one or more registers using the **Multi-Select** button in the Utilities pane.
- 4 Select the **Start Register** button in the File Operations pane and enter a register number in the pop-up keypad, and select **Enter**.
- 5 Turn on the **Start Register** button (highlighted green border) to enable the E-MEM register offset.

Save Eng Setups

Note: Selecting an Eng Setup file in the System or Remote Storage menu tab and selecting **Save** overwrites the file.

1 Select **File Ops, Eng Setups**.

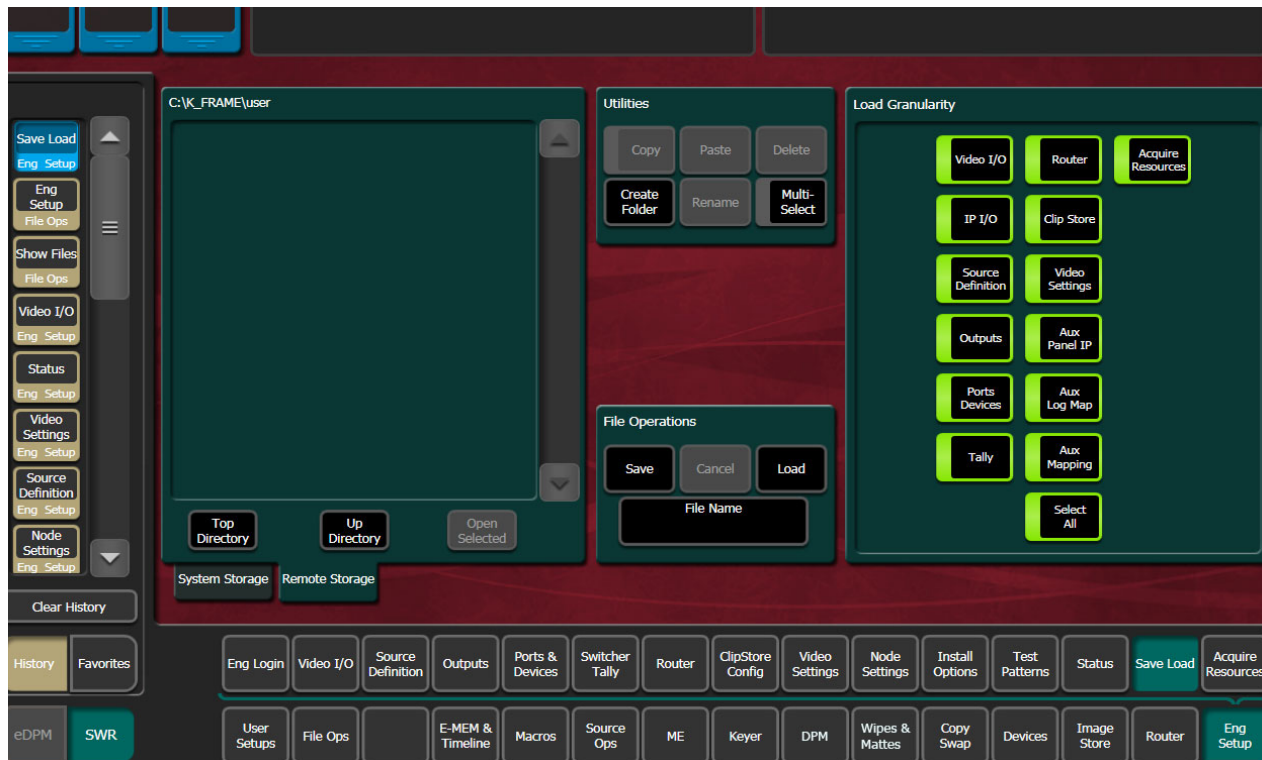

- 2 In the System or Remote Storage menu tab (left side of menu), navigate to the folder you want the Engineering Setup to be saved.
 - a In the Load Granularity pane, enable or disable preferences and settings, or, enable the **Select All** button.
 - b Select the **Save** button in the File Operations pane.

Load User Setups

1 Select **File Ops, User Setups**.

2 Select **Panel Prefs** or **Suite Prefs** button.

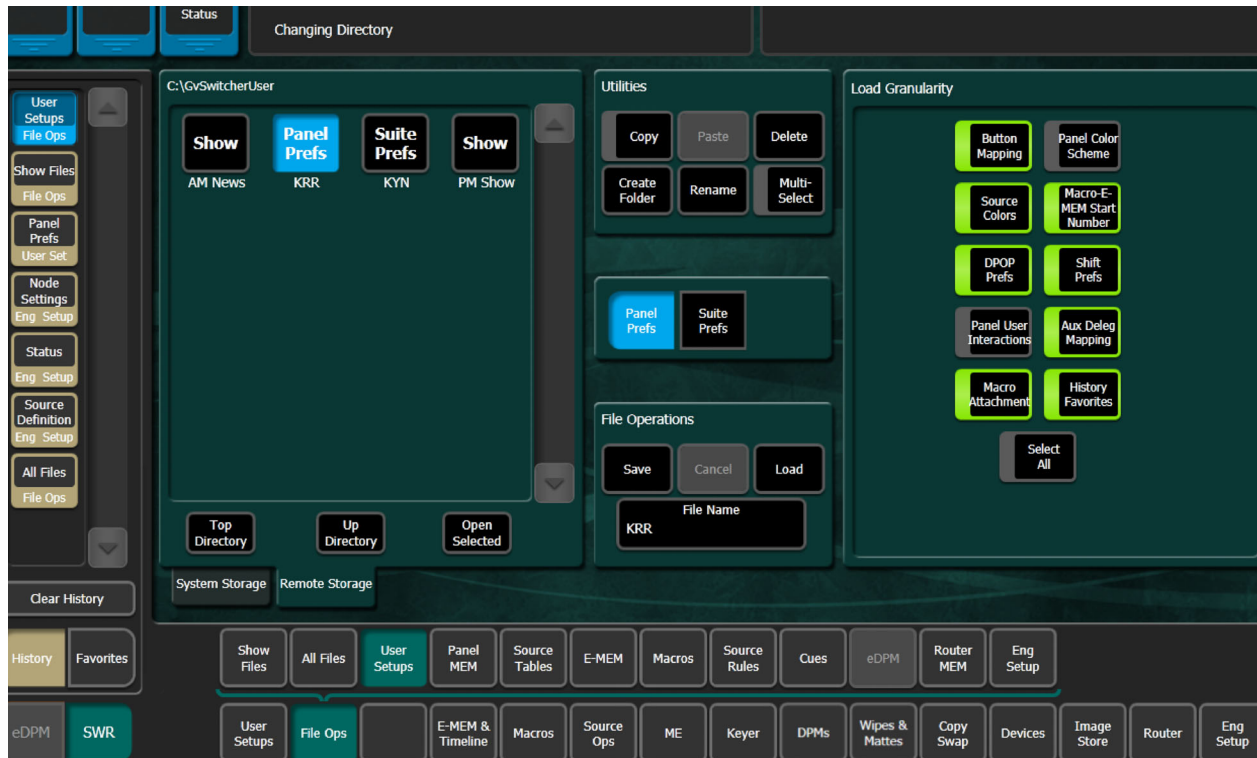

- 3 In the System or Remote Storage menu tab (left side of menu), select a **Panel Prefs** or **Suite Prefs** file.
- 4 Optionally, select either the **Panel Prefs** or **Suite Prefs** button in the center menu pane and in the Load Granularity pane, enable or disable preferences and settings that will be loaded as part of the user setups.
- 5 Select the **Load** button.

CAUTION: : The Load button immediately replaces information the system is currently using with the selected preferences and settings. When setups are loaded, significant changes to system operations are possible.

5 Video Mix/Effects

M/Es and Keyers

A GV K-Frame XP M/E is a subsystem of a video production switcher that can create a composite of two or more pictures. An M/E includes multiple source selection buses and provides transition (mix and wipe) and keying capabilities on the selected signals.

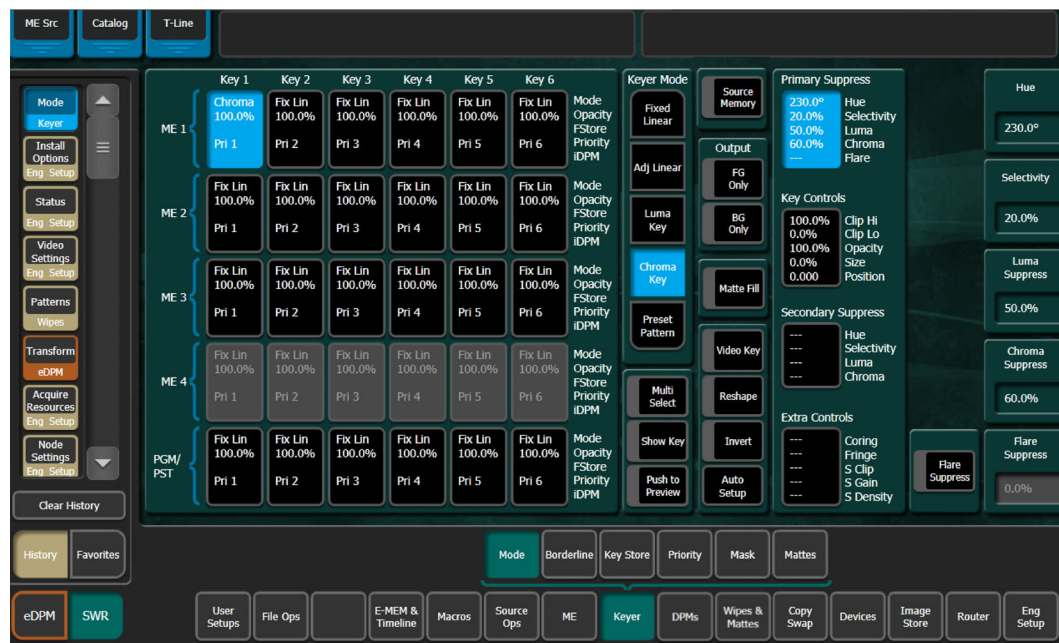

Six Keyer System Example

Keyers are used to insert part of one picture into another to create a composite picture. Keying involves three signals:

- background,
- key cut, used to specify where to cut a hole in the background, and
- key fill, used to fill the hole in the background. The fill can be an incoming video signal or it can be an internally generated matte.

A separate key cut input signal is not necessarily required for keying. For example, a self key (also called a video key) uses the same input signal for both key cut and key fill.

The GV Switcher system supports the following types of keys:

- Linear Key (fixed and adjustable)
- Luminance Key
- Preset Pattern
- Chroma Key (option)

The GV Switcher system also supports self keys and split keys.

Chroma Key

The GV Switcher system features the chroma keyers option with powerful controls. These controls offer subtle adjustments to allow successful keying of difficult subject matter (fine hair, smoke, translucent objects, etc.), and to overcome some problems resulting from imperfect chroma key set coloring or lighting. The GV Switcher chroma key also has an Auto Setup feature that can create an excellent chroma key under most circumstances without the need for manual adjustment.

The following information provides more detailed instructions on how to set up a chroma key using the Auto Setup feature and use the manual controls in the Keyer menu.

Chroma Key Auto Setup

The first step of setting up most chroma keys is to use Auto Setup. Auto Setup automates the first steps to achieving a chroma key. Auto Setup performs the following:

- Calculates primary suppression Hue and Luminance.
- Sets primary suppression Selectivity and Chroma to defaults.
- Calculates Clip Low, and sets Clip Hi to default.
- Sets all the secondary suppression values to duplicate the primary suppression values, but turns secondary suppression off.
- Changes Opacity temporarily to 100% to permit an accurate backing color sample, and then returns it to its original setting.
- Sets Key Position and Size values to default (0).

Two different Auto Setup algorithms are available, one for well designed and lighted sets (**Reshape** off), and the other for more challenging sets (**Reshape** on). Depending on individual circumstances, additional manual adjustments may be required after you use Auto Setup.

After an Auto Setup has been initiated, you can cancel it by pressing the **Auto Setup** button again, but the chroma key will retain the default settings imposed.

Manual Chroma Key Adjustments

If the Auto Setup of the hue fails to provide a suitable chroma key, additional controls are available in the Keyer, Mode menu for fine tuning the key. Chroma key manual set up consists of choosing the best set of compromises to provide adequate detail and color fidelity to meet your needs. While using this menu you need to view the chroma key scene on a monitor. A vectorscope and waveform monitor can also be very useful when setting up a chroma key. During set up you need to focus your attention on particular areas of the foreground, background, and/or composite. The areas you look at will change depending on the individual controls being used. The **FG Only** and **BG Only** menu buttons can be used to remove extraneous picture information, allowing you to view only those areas of the composite.

Chroma key set up procedures follow a recommended order, as indicated by the numbered steps displayed on the menu. However, requirements can vary depending on each

individual scene. You may need to go back to earlier steps and readjust previous settings to optimize the key. Understanding what the chroma key controls do will help you decide what adjustments are required for your individual situation.

Primary Suppression

Primary suppression is the most critical chroma key parameter, and the easiest to set. Auto Setup should take care of this, but manual adjustments in the Keyer, Mode menu can be made if desired. If primary suppression is set wrong, however, it will be impossible to achieve a good chroma key with the other controls.



Six Keyer System Example

Primary Suppression should be set while looking at the foreground. Ideally the backing color will appear as a small dot on the vector scope and a perfectly flat line on the waveform display, but this never occurs due to set lighting variations, shadows, etc. This means you will need to pick the best suppression for the overall look of the key.

You can select the stage 1 **Pri Suppress** data pad, if necessary, to activate these controls and adjust Hue, Selectivity, Chroma, and Luma primary suppression to eliminate the backing color.

- **Hue** can be set accurately with Auto Setup. Hue should center on the primary color of the backing area of the foreground scene. Depending on where **Luma** and **Chroma** primary suppression are set, adjusting Hue may not make any noticeable change on the scene. Chroma suppression should be preset to 100% and Luma set to 0%. Hue can then be tuned to remove the backing color.
- **Selectivity** may need to be increased if there are colors in the foreground image that are being suppressed. Selectivity should be set as low as possible without including colors that should not be suppressed. For example, when keying on green, a greenish yellow shirt might be affected by the suppression. If so, adjust the selectivity high enough to reject that color. Too high a selectivity is one of the classic causes of a noisy key. If the foreground subject is stationary, consider using a force mask instead of increasing selectivity.
- **Chroma** suppression can be set accurately with Auto Setup. To adjust, increase Chroma suppression and observe the backing color dot on the vector scope move toward the center. You want to center it exactly, so no chroma exists in the backing area. 100%

chroma suppression is the correct setting for all chroma keys. At this point, you will probably see a line through the center of the vector scope. With increased selectivity, this line will become an arc.

- **Luma** suppression adjustments may be necessary if shading is visible in the backing area with **FG Only** selected, or if the shading adversely affects the background image. Primary Luma suppression is hardly ever desired when Reshape is on. To adjust, increase Luma suppression and observe the backing color move toward black. You want to make the backing color just black. Increasing this control too much will make the chroma key hard and noisy. When not enough, highlights will be added to the background. Note that incomplete luminance suppression is not necessarily bad. The highlights added to the background will match the shading on the backing wall, adding natural shadows and perhaps eliminating the need to add artificial shadows.
- All the above adjustments may need to be revisited later.

Another potential artifact of chroma keying is a tinting of the overall foreground subject due to lighting splash from the backing color or lens flare. **Flare Suppression** adds a small amount of color to the entire foreground image to cancel the splash or flare. Typically less than 2% of the backing color is needed to neutralize the flare.

Extra Chroma Key Controls

Additional chroma key controls are available by selecting the stage 4 **Extra Controls** data pad. Coring, fringe, and shadow controls can be individually activated by selecting the labeled buttons.

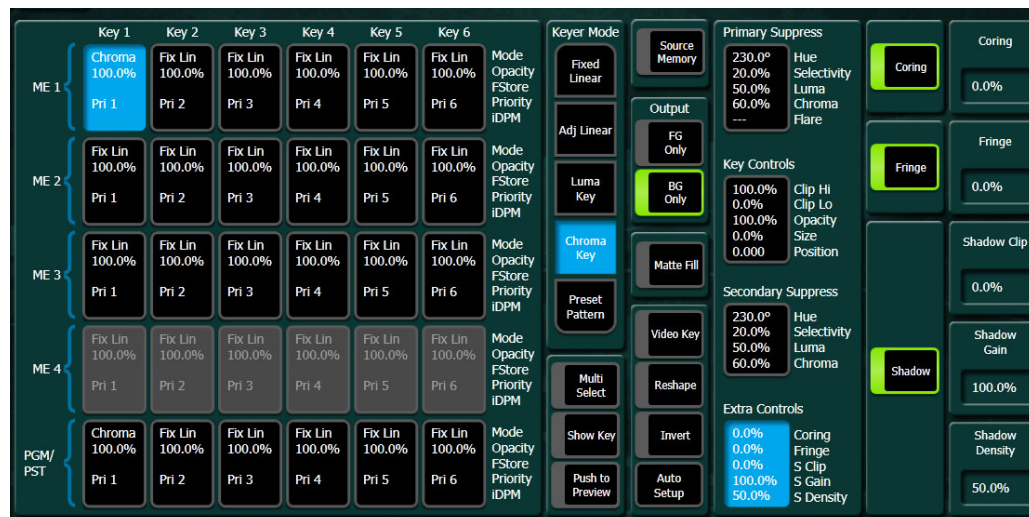

Six Keyer System Example

Coring replaces any pixels in the luminance signal after primary suppression that are below the adjustable threshold with black. This eliminates noise resulting from incomplete suppression. While coring can improve some keys, it can easily be over done. Coring thresholds much above black will affect dark grays that are actually part of the foreground subject, making the chroma key composite look unnatural.

Fringe is used to restore color to the gray portions of the foreground color resulting from secondary suppression adjustments. This control is only active when secondary suppression is on.

Shdw provides controls of shadows that fall on the backing. **Shadow Clip** and **Shadow Gain** allow selecting the range of the luminance portion of the foreground that produces a shadow. **Shadow Density** is an opacity control for the shadow and adjusts how much shadow is added to the background.

Setting Up a Chroma Key

Configure Auto Setup

- 1 Press one of the keyer transition buttons on the Control Panel (for example **Key 1**) on an M/E to delegate the keyer you wish to use.
- 2 Choose the selected keyer's key bus that has the chroma key source and the chroma key backing color.
- 3 Select the CHR as the key type in the Multi-Function Module (source memory may automatically select this key type).
- 4 Choose the source on the A bus that will be used to replace the backing color of the chroma key source.
- 5 Go to the Keyer menu either by double pressing a keyer transition button on the Control Panel (for example **Key 1**) or selecting **Keyer, Mode** on the menu and make sure **Reshape** is off for the keyer you are using.



- 6 Press the **Auto Setup** button on the Control Panel or select it in the menu. Preview for that M/E will now display the chroma key source with a superimposed cursor. The cursor actually represents a box of 16 x 16 pixels.
- 7 Use the joystick to position the cursor on the backing color. Select a darker area, if one exists, to optimize the backing color suppression.

- 8 Press the button on top of the joystick. The chroma key will be set up automatically using the average of the colors selected by the cursor box. Because Reshape was off, fine edges of the key will be preserved.
- 9 If this chroma key is acceptable, you are done. If set, lighting, or other conditions prevent the result from being acceptable, you need to decide whether to adjust the chroma key manually or use Auto Setup with Reshape.
 - Manual adjustment permits retention of fine edge detail (see the *Switcher Concepts Manual* for more information). In particular, if there are problems with translucent areas (hair, smoke) secondary suppression controls can be useful.
 - Auto Setup with Reshape produces a chroma key with harder edges, but accommodates wider set variations (see below).

Reshape a Chroma Key Using Auto Setup

If the set is lit unevenly or has other problems, Reshape is available to help solve the problem. A better alternative, if time permits, is to adjust the lighting on the set to even out the backing color. This may improve the key so that Reshape is not needed.

- 1 If you decide you must use Reshape, follow the Auto Setup procedure in [Configure Auto Setup](#), on page 61 but select Reshape in the Keyer menu to turn it on (its green indicator will illuminate). After selecting the backing color area and selecting the top button on the joystick, the chroma key will be set up with coarser values better able to handle set variations.
- 2 If this chroma key is acceptable, you are done. If you are still not satisfied, you can fine tune the chroma key using manual adjustments.

Adjust Chroma Key Controls

The purpose in adjusting **Clip Hi** and **Clip Low** is to cause the proper hole to be cut in the background. All areas of the backing color should be full background while all areas of the foreground should make the background completely invisible. The easiest way to do this is to observe the key signal while making your adjustments.

The smaller the difference between **Clip Hi** and **Clip Low**, the higher the keyer gain. High gain amplifies noise present in the transition between transparent and opaque. The correct setting is with Clip Hi and Clip Lo set to just barely achieve opacity and transparency, respectively.

- 1 Select the stage 2 **Key Controls** data pad to activate these controls. You can now manually adjust keyer clipping controls.

- 2 Select **Show Key** in the Keyer menu and look at the M/E preview output on a picture and waveform monitor.

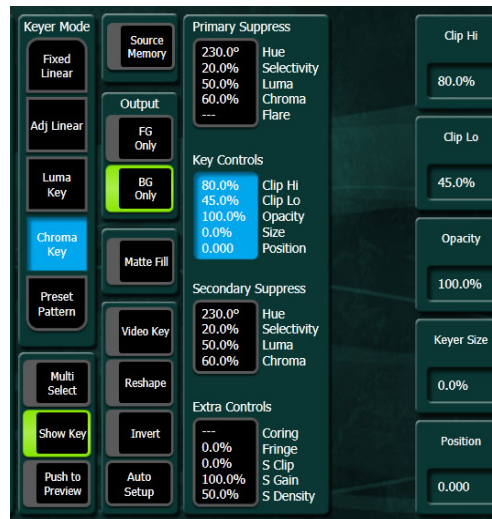

- 3 Adjust **Clip Hi** so that all areas of the foreground objects are white. If Clip Hi is set too low (too far clockwise), much of the translucent areas will be forced to be fully opaque, hardening the key and darkening the transition area between background and foreground.
- 4 **Clip Low** can be set accurately with Auto Setup. Adjust Clip Low so that all areas of the backing color are black. If Clip Low is set too high (too far counter-clockwise), translucent areas will be forced fully translucent, hardening the key.

Note: When adjusting clip levels, remember that areas on the edge of the foreground subject should show as shades of gray. Gray indicates areas of translucency, which is desirable in chroma keying.

- 5 Check the final results with **Show Key** off and the chroma keyer in normal mode (**FG Only** turned off). Note that incorrect adjustments can create a hard, noisy key.
- 6 If the chroma key now looks good, you are done. If dark edges are present, there may be too much primary **Luma** suppression or **Clip Hi** or **Clip Low** may be set improperly. If adjusting these parameters fails to solve the problem, you should consider activating the Reshape feature.

Apply Chroma Key Secondary Color Suppression

Secondary color suppression is intended to improve the color of translucent areas (e.g., glass or smoke) or fine detail near the edge of a foreground subject (e.g., hair). These areas can be take on some of the backing color. Much less secondary suppression will be needed than is used for primary suppression, because the foreground color is only partially corrupted by the backing color. Because there is a mixture of backing color and foreground color, the secondary suppression Hue and the direction (Angle) will be different from primary suppression. Primary suppression removes the backing color, while secondary suppression corrects the color in translucent areas.

Note: If Reshape has been applied, it is unlikely enough edge detail will remain to use secondary color suppression.

- 1 Select the stage 3 **Sec Suppress** data pad and then select the **Secondary Suppress** button to activate this feature.



- 2 Adjust secondary suppression **Hue** and **Selectivity** so that the translucent area is affected, but opaque areas of the foreground are not. The final hue will lie somewhere between the backing color (primary suppression hue) and the uncorrupted foreground color.
 - When making this adjustment, it is helpful to turn the secondary **Chroma Suppression** to maximum, and the secondary **Suppression Angle** to produce an unnatural color in the affected area. This makes the changes to secondary suppression more obvious.
 - Selectivity should be kept as wide as possible. You should only narrow selectivity (increase its value) if you cannot avoid changing opaque areas of the foreground.
- 3 Adjust the secondary **Angle** so that changing secondary **Chroma** suppression moves the color in the desired direction. You are trying to match the color of the translucent areas to an opaque (uncorrupted) area of the foreground subject.
- 4 Decrease secondary **Chroma** suppression for the best match between corrupted (translucent) and uncorrupted (opaque) areas. Interaction between secondary suppression Angle and Chroma suppression may require repeating these adjustments.
- 5 Increase secondary **Luma** suppression to balance lightness of the translucent and opaque areas.
- 6 Repeat secondary suppression Angle, Chroma suppression and Luma suppression for best results.

Generate Background Mattes

Background matte generators create colors and washes. These can be used, for example, as the backgrounds for keys.

Background mattes cannot use the wipe pattern generators available to keyer and wipe mattes, and cannot use Utility video as a wipe source. Instead background mattes employ a simple dedicated wipe generator that creates a single, straight line.

Background matte control is available from the Control Panel (Modifier area, **Matt** button in the Home menu) and from the Keyer, Matte menu, which provides additional background parameter controls.

- 1 Go to the Mattes menu by pressing **Keyer, Mattes**.

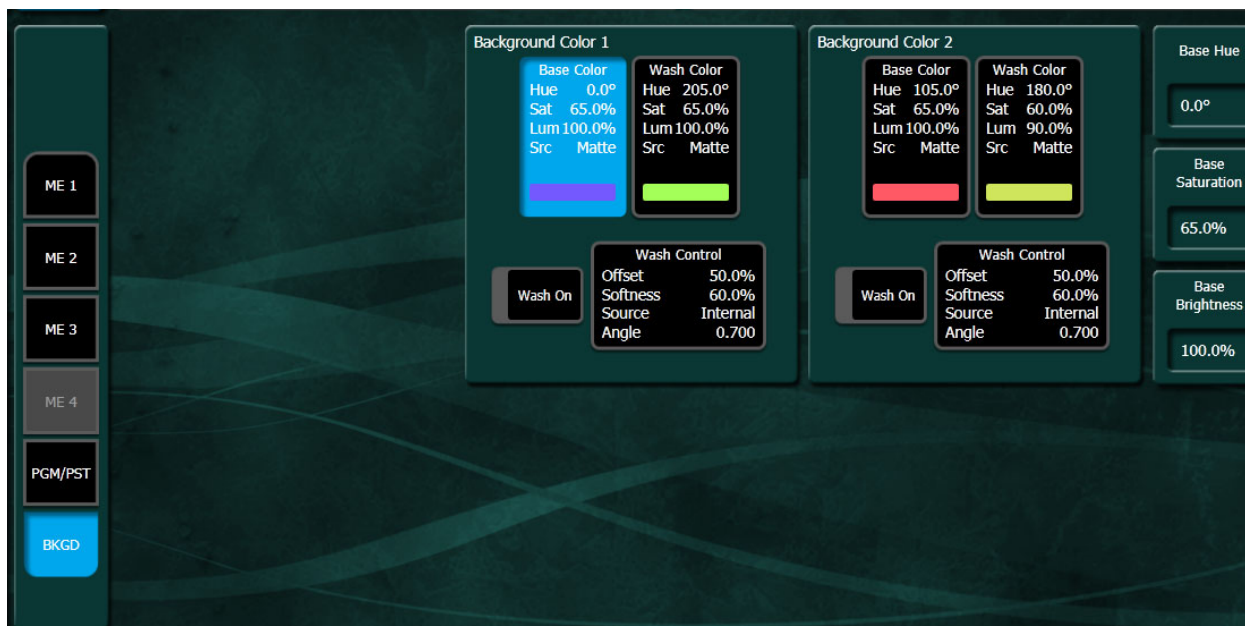

- 2 Select the **BKGD** button.
- 3 If not already selected, select the **Base Color** data pad of the desired Background (1 or 2). Use the top three soft knobs to adjust **Base Hue**, **Base Saturation**, and **Base Brightness** of the base fill color.
- 4 Select the **Wash On** button at the bottom so its indicator illuminates to create a wash matte.
- 5 Select the **Wash Control** data pad to bring up Offset, Softness, and Rotate soft knob controls. If necessary, use the Offset and Softness knobs to make the wash edge visible on the screen. You can also turn on the Rotate button, and then adjust the angle of the edge using the Rotate soft knob.
- 6 Select the **Wash Color** data pad to delegate the soft knobs on the right to adjust **Wash Hue**, **Wash Saturation**, and **Wash Brightness** of the wash fill color.

Because all background matte parameters are keyframeable, you can build effects with constantly changing backgrounds using multiple keyframes.

Split a Key

Sometimes you may wish to use the key cut signal of one source with the key fill or video signal of another source. For example, you may have a Character Generator creating matte filled characters, but wish to use a different signal to fill the characters. A split key is used to accomplish this.

Note: On GV Switcher systems, the Source Select buses by default tally the key fill signal.

A split key can be created three different ways:

- Configure a source in the Eng Setup/Source Destination menu that uses different video for cut than for fill. That split key will initially be used whenever that engineering source is selected. See the *Kayenne/Karrera/GV Korona Installation and Service Manual* for more information.
- Setup a key patch (an implicit split key). This split key is used whenever that logical source is selected, and adds operational flexibility (see [Patch a Key Input from Another Source](#), on page 34).
- Setup an explicit split key using the Source Ops menu. This split key is used only at the time it has been set. Selecting a different source, then returning to that formerly split source removes the split key.

To create an explicit split key:

- 1 Select **Source Ops, MEs**.



- 2 Select an ME button (left).
- 3 Select the Cut signal data pad for the Keyer you wish to split (highlights blue).
- 4 Select a source from the scrolling Source List (right) and select that source.

The ME Status display in the Transition area shows the source names of any key cut signals.

Note: Split Key will be shown in the Modifier area Control Panel Display.

Set Keyer Priority

The GV Switcher system has four or six keyers per M/E so complex stacking is possible. Keys can be placed between other keys, using key priority.

Note: You can also apply the following to the Keyer Secondary Priority Stack when an M/E is in Split Mode.

1 Select **Keyer, Priority.**

The screenshot displays the ME Status interface. On the left, a grid shows keyer status for ME 1, ME 2, ME 3, ME 4, and PGM/PST. Each keyer has six keys (Key 1 to Key 6) with their respective source names and 100.0% opacity. The 'Fix Lin' keys are highlighted in blue. To the right, the 'ME 1 Keyer Primary Priority Stack' and 'ME 1 Keyer Secondary Priority Stack' are shown. Each stack has a 'Current' and 'Next' column. The Primary stack shows keys K1 through K6 in order P1 through P6. The Secondary stack shows keys K1 through K6 in order P1 through P6. The 'Move Up' button is highlighted in blue.

- 2 If not already set up, turn on the desired keys and arrange them so they overlap, observing the Program monitor. This will make the changes in key priority visible. For demonstration purposes, you can use four preset pattern keys.
- 3 Select the keyer you wish to move in the stack in the Current column, then use the **Top**, **Move Up**, **Move Down**, and **Bottom** buttons on the left to place the key in the desired location. The key priority order changes immediately, as a cut.

Transition Between Different Keyer Priorities

Key priority transitions use a Current priority stack and a Next priority stack. The transition occurs between the two stacks.

Note: You can also apply the following to the Keyer Secondary Priority Stack when an M/E is in Split Mode.

- 1 Press the **Key Prior** Transition Element button on the Control Panel.
- 2 If not already set up, turn on the desired keys and arrange them so they overlap, observing the Program monitor. This will make the changes in key priority visible. For demonstration purposes, you can use four preset pattern keys.
- 3 Delegate that M/E for preview in the Preview button group on the System Bar. This shows the end result of the transition (the Next priority).
- 4 Go to the Keyer, Priority menu by pressing **Keyer, Priority** on the Control Panel or selecting **Keyer, Priority** in the menu.
- 5 The current stack in the menu is automatically set to what is currently being output. You can change the Current priority stacking order if desired, as described in [Transition Between Different Keyer Priorities](#), on page 67.
- 6 Set up the Next priority stacking order, selecting the keyers in the Next column and then using the **Top, Move Up, Move Down, and Bottom** buttons. The new stack will be visible on the preview monitor.

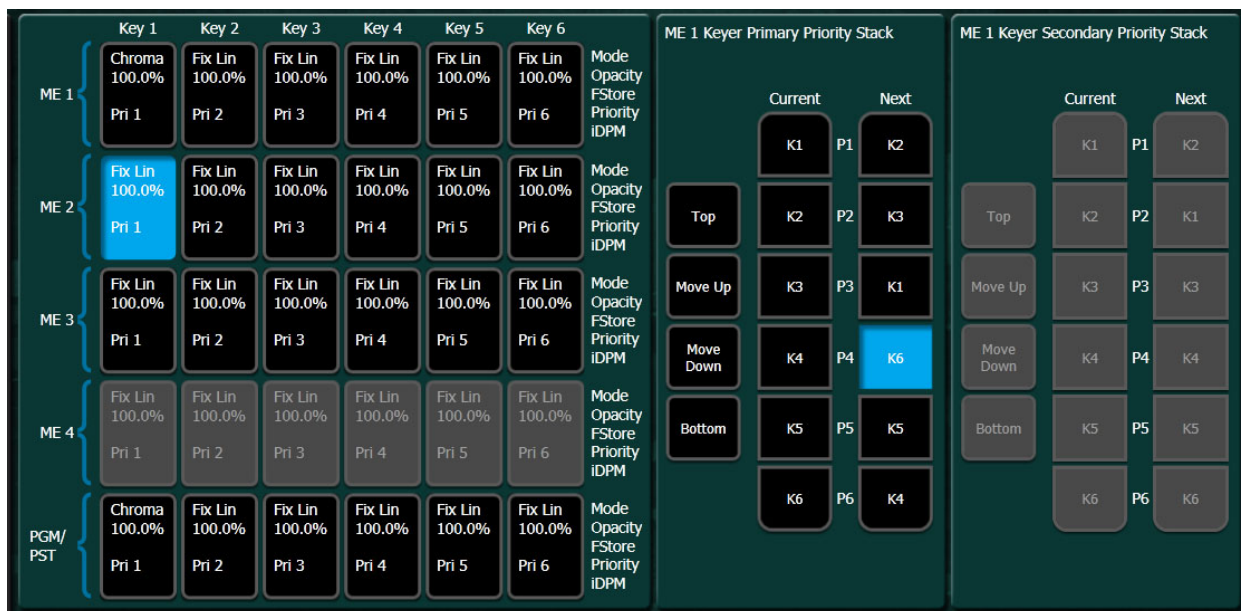

- 7 Select the type of transition, using the **Mix, Wipe 1, or Wipe 2** transition buttons on the Control Panel. If you selected a wipe, go to the Wipes menu by double pressing one of the **Wipe** buttons, and then select the pattern and any modifiers to be used with the wipe.
- 8 Move the lever arm or press the **Auto** button in the Transition area to perform the key priority transition. The transition is shown on the Program monitor.

About Key Store

Key Store is available on six-keyer systems only. Each keyer can store two frames of memory; each frame containing both Keyer Video (fill) and Key (cut), that together create the Key Store.

Each Key Store can save the use of other switcher resources. For example instead of using an Image Store channel or another keyer, you could store a station ID or a replay graphic (still) for a sports show in a Key Store and switch the image within the keyer.

In the Keyer, Key Store menu, each Store has two frames, Frame Store 1 and Frame Store 2. Each can 'Grab', 'Store', and 'Use' a still image for a key source. So in addition to Live video, you have up to two fill/cut images that can be interchanged on any full keyer source.

- The **Show Key** button—Shows the cut signal for the selected Key Store source.
- The **Push to Preview** button—Shows the current Key Store image on Preview.

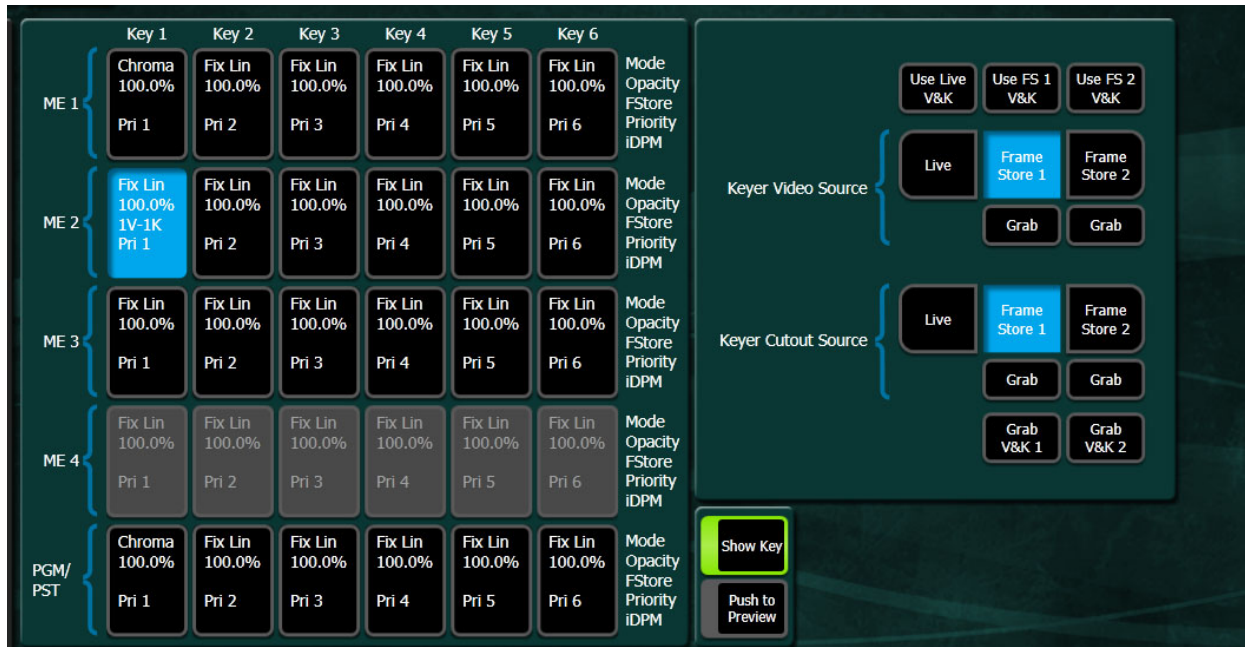

The fill and cut from Live, Frame Store 1, and Frame Store 2 pages can be used in any combination, for example you can use the fill from Keyer Video Source, Frame Store 1 with the cut from Keyer Cutout Source, Frame Store 2. You can even use the Live video from the Keyer Video Source and the cut from Keyer Cutout Source, Frame Store 1.

On power cycle or reboot, Key Stores will have to be reloaded with the correct video. They default to black keyed with black which will not show up on a monitor.

Key Store is E-MEMable and keyframeable.

Keystore and 1080sf Mode

There are no odd fields in 1080sf mode, therefore to grab a Keystore image while running in 1080sf mode, you must set the Field Dominance mode in the Eng Setup, Video Settings menu, Command Processing pane, to either *Any Field* or *Even field*.

Grabbing a Key Store Image

The keyer settings are defined in the Eng Setup, Source Definition menu where for example you can set a key to a Linear or Shaped Video. You will need to define these parameters when creating a Key Store, if not defined the key will be full raster white.

You can 'Grab' both a video and key frame simultaneously by selecting either the **Grab V&K 1** or **Grab V&K 2** button, located below each Frame Store page, or you can select a Grab button for any of the four Video/Cutout Frame Stores.

Once you grab fill and key images in Key Store, they are available for the selected key source.

Grab a Keystore image:

- 1 Select **Keyer, Keystore.**

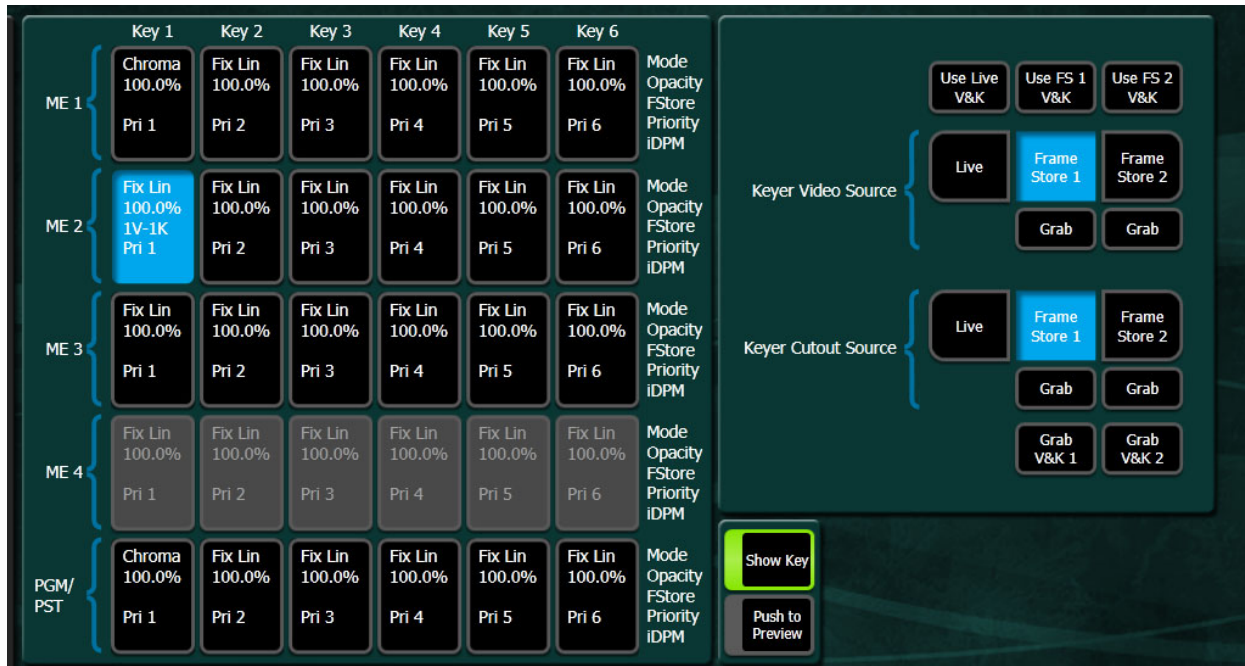

- 2 Select a keyer for the Key Store.
- 3 Select either the **Use Live V&K**, **Use FS 1 V&K**, or **Use FS2 V&K** to select the Video and Key source image, or
 - a Select the Keyer Video Source for the fill.
 - b Select the Keyer Cutout Source for the key cut.

Set a Pattern Mix

You can combine the complex wipe pattern generators (P1 and P2), to create a wide variety of customized wipes.

- 1 Double press the **Wipe 1** button in the Transition area. This selects Wipe 1 as the next transition type, and also opens the Wipes menu with PRI Wipe 1 delegated for control.

- 2 Select the P1 pattern to be used by selecting the **Wipe Pattern** button between the **Pattern Mix** and **Generator/Border** data pads, and then selecting one of the displayed patterns in the Pattern tab on the right.

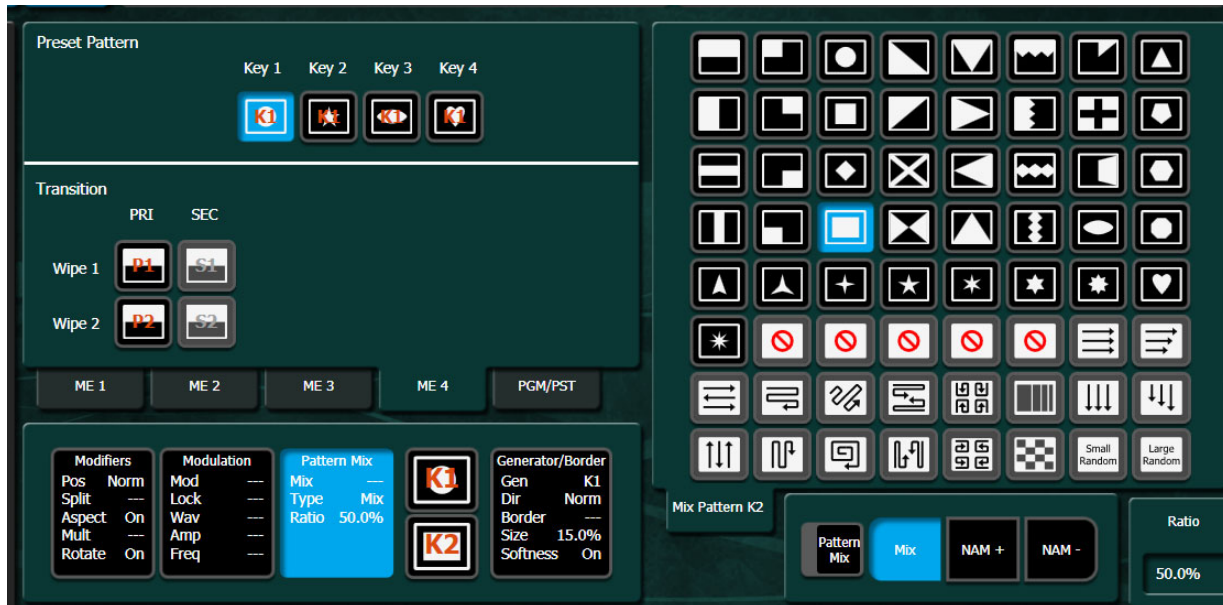

- 3 Select the **Pattern Mix** data pad, this switches the Pattern tab on the right to the other generator; in this case P2 (to select the base wipe pattern again, select the **Wipe Pattern** button).
- 4 Select the **Mix** data pad located below the Pattern tab. Additional control buttons will appear at the bottom of the menu.
- 5 Delegate that M/E for preview in the System Bar.
- 6 Press the **Trans PVW** button in the Transition area, and move the lever arm part way. This will display the P1 pattern on preview.
- 7 Select the delegation button in the Pri Wipe 1 column to delegate the menu to control the Pri Wipe 1 pattern generator.
- 8 Select the **Pattern Mix** button so its indicator illuminates. The preview monitor will now show the combined Mix 1 and Mix 2 pattern.
- 9 You can select the type of pattern mix with the Mix type buttons (**Mix**, **NAM +**, **NAM -**). The NAM buttons are used for And or Or pattern mixing.
- 10 You can also adjust the amount each wipe pattern contributes to the mix with the **Ratio** control. At 50%, each pattern contributes equally. At 25%, the other pattern contributes only 25% to the final pattern.

Source Memory

Source Memory is a GV K-Frame XP system feature that can be used to retain keyer settings for each source on each keyer bus. Source Memory permits the operator to, for example, hot cut from one source to another on that keyer bus and automatically restore different settings learned for each keyer source.

Source Memory settings for a keyer source are only applied when that source is selected on that keyer bus. Selecting on that keyer bus a different source that does not have learned Source Memory will restore the previous keyer settings.

Source Memory keying settings include:

- Keyer Mode settings, including Preset Pattern and Chroma
- Keyer Mask settings
- Keyer and Wipes Mattes settings
- M/E Video Proc settings (Keyer sources only)
- M/E RGB Color Correct (Keyer sources only)
- Wipes settings (Keyer sources only)

Source Memory settings are explicitly learned and deleted, using the **Source Memory** button.

The following are NOT affected by Source Memory:

- Split keys
- Keyer Borderline settings
- Keystore settings
- Background sources
- Aux sources

Learn Source Memory for a Keyer

- 1 Select a source on a keyer bus and setup the keyer with the desired settings, using the Control Panel and/or menus.
- 2 Go to the Keyer/Mode menu and select the keyer whose settings you want to save to that keyer source's Source Memory.
- 3 Select the **Source Memory** button. The Source Memory window appears (selecting **Cancel** exits the Source Memory window without making any changes).

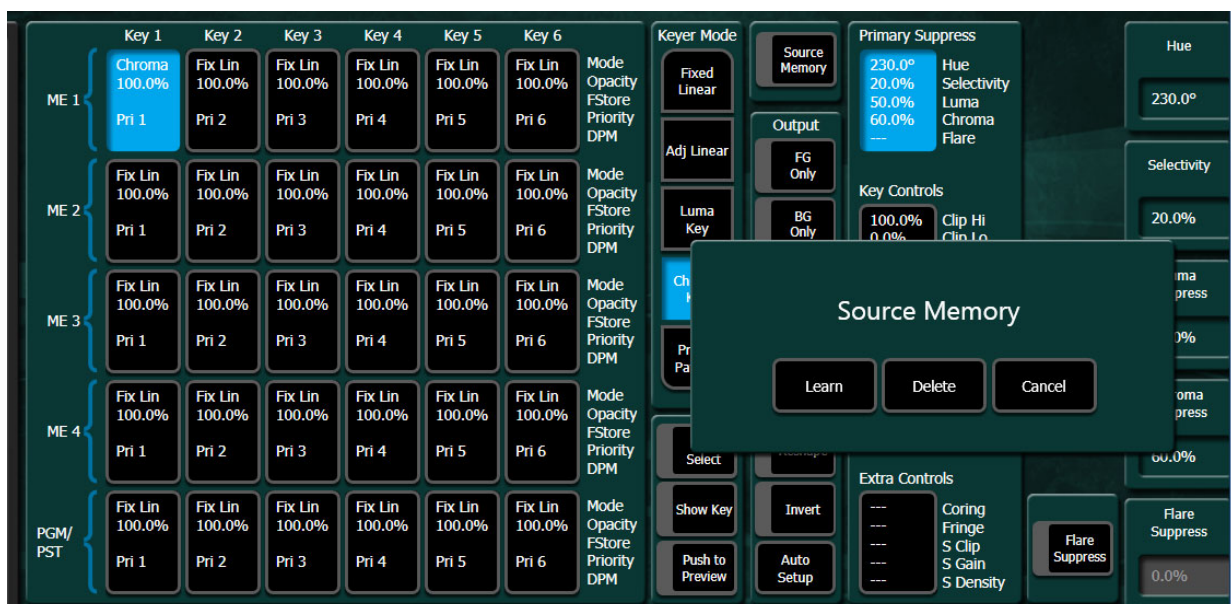

- 4 Select the Learn button. The settings are saved for that keyer source on that M/E's keyer bus, and will be applied whenever that source is selected on that M/E's keyer bus.

When a keyer source with settings saved to Source Memory is selected on a keyer bus, the **Source Memory** button is highlighted when that keyer is selected in the Keyer Mode menu.

Delete Source Memory from a Keyer

- 1 Select a keyer source with learned Source Memory on a keyer bus, using the Control Panel and/or Source Ops menu.
- 2 Select Keyer, Mode in the menu, and select that keyer. The **Source Memory** button will be illuminated.
- 3 Select the **Source Memory** button. The Source Memory window appears.

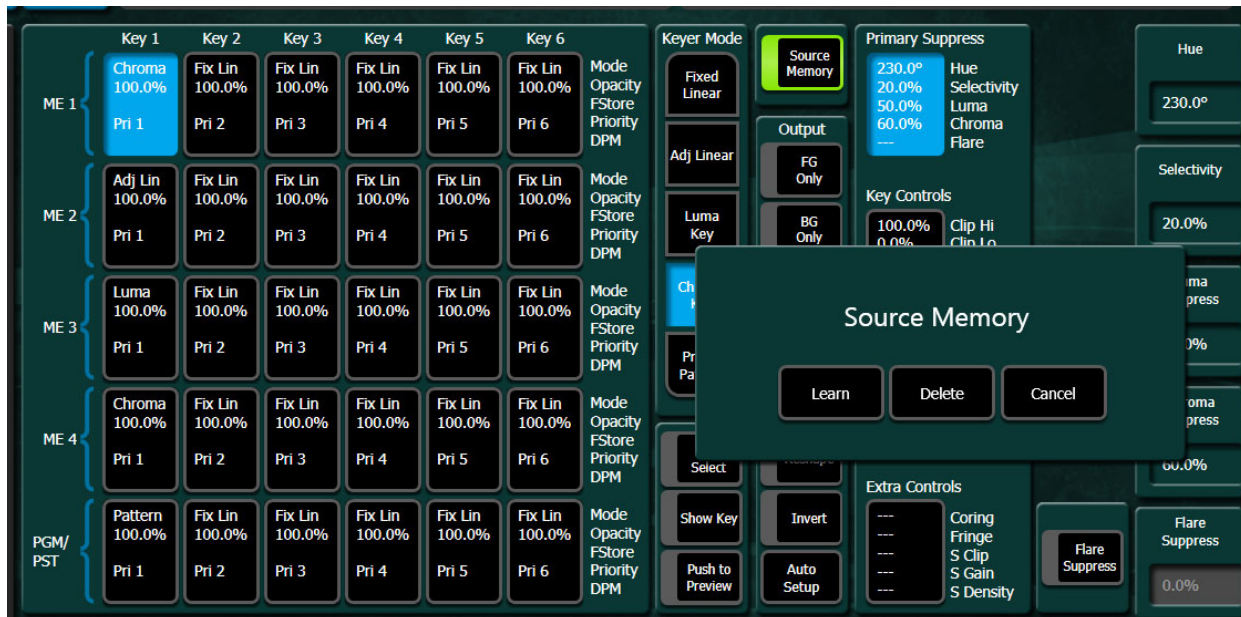

- 4 Select the **Delete** button. The Source Memory delete options window appears.

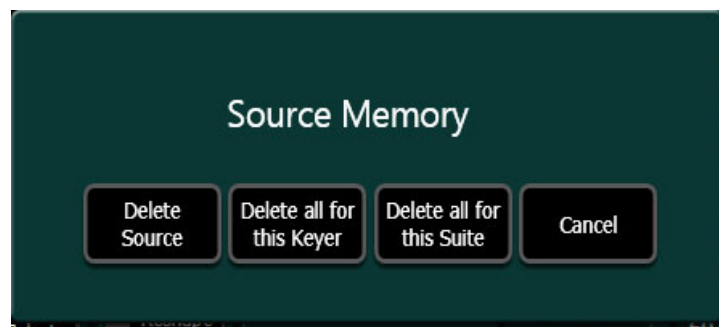

- 5 Select one of the following Source Memory delete options:

- **Delete Source** - Removes Source Memory from only that keyer source on that M/E's keyer bus, restoring the previous keyer setting.
- **Delete all for this Keyer** - Removes Source Memory from all the keyer sources on that M/E's keyer bus, restoring the previous keyer setting.
- **Delete all for this Suite** - Clears all the settings for all the keyers on all the M/E buses to default, and removes Source Memory from all the keyers.
- **Cancel** - Exits the Source Memory window without making any changes.

Learn Source Memory from the Control Panel

In addition to the GV Switcher menu, Source Memory can be saved from the Select Module on the Control Panel.

- 1 Press a Keyer bus source button on the Source Select Module.
- 2 Select keyer settings; Preset Pattern, Chroma, keyer mask, wipe, etc.
- 3 Press and hold a Source Select Keyer delegate button (for example Key 1) for the M/E.
- 4 Press the **EMEM** button on the Source Select Module.

Result: Settings for the selected keyer source are learned in Source Memory and a horizontal line appears through the selected source's OLED indicating Source Memory has been learned.

Changes to keyer source settings with Source Memory learned do not auto-update. If you make a change, you must repeat the steps above to learn Source Memory.

Source Memory can only be deleted from the GV Switcher menu. Go to the Keyer, Mode menu.

Keystores each have Source Memory.

About Acquiring DPMs

iDPMs and eDPMs are currently available on all GV K-Frame XP systems with a license. 2D-DPMs are standard on all systems.

iDPMs and eDPMs are floating resources available to any full M/E (not available to the Controller M/E (ME-CT)). The number of licensed iDPMs in a suite appear in the Logical Resources of the Eng Setup, Acquire Resources menu, in the **DPM Chns** data pad. eDPM resources must be allocated.

Note: 2D DPMs are available on all M/Es including the Controller M/E and eDPM.

To move resources between suites, refer to the *Kayenne/Karrera/GV Korona Installation & Service Manual*.

Acquire an M/E Resource for eDPM

A full M/E is used as an eDPM logical resource so that M/E will be unavailable until released.

- 1 Select **Eng Setup, Acquire Resource**.

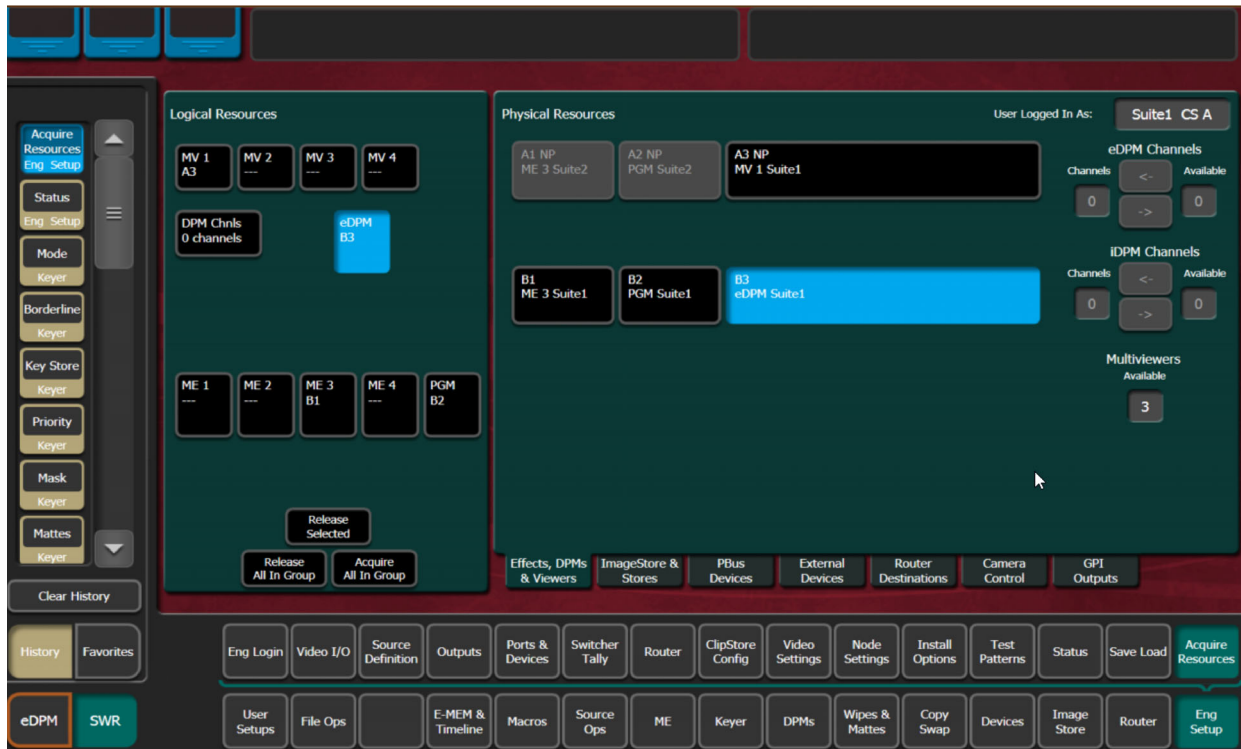

- 2 Select the **eDPM** button in the Logical Resources pane.
- 3 Select a full M/E resource in the Physical Resources pane.

Release/Acquire DPM Resources between eDPMs/iDPMs

- 1 Select **Eng Setup, Acquire Resource**.
- 2 In the Physical Resources pane, release and/or acquire available DPM resources:

- a In the Logical Resources pane, turn on the **DPM Chns** button.



- b Release channels by moving them from **Channels** to **Available** (up to six for acquisition by eDPM) using the -> (Right Arrow) buttons in the **eDPM/iDPM** Channels acquisition groups.
- c Acquire available DPMs using the <- (Left Arrow) buttons.

Enable/Delegate DPM Channels

DPMs acquired by a suite can be assigned to keyers for creating effects and taking them to air (for DPM suite acquisition, see *Kayenne/Karrera/GV Korona Installation & Service Manual*).

Enable DPMs on the Kayenne Control Panel

- 1 From the Kayenne Control Panel, in the MFM (Multi-Function Module) Home menu, press an **ME** button.
- 2 Press a Key button 1-6 or hold and press for multiple channel control.
- 3 Press the **iDPM** button.

Delegate eDPM Channels

- 1 From the Kayenne Control Panel, in the MFM (Multi-Function Module) Home menu, press the **eDPM** button.

Note: The acquired eDPM channels are delegated to the keyer row, displayed in cyan (blue). Once delegated, eDPM channels are always enabled.

- 2 Press a channel button or hold and press for multiple channel control.

Enable a 2D DPM on a Keyer

- 1 From the Kayenne Control Panel, in the MFM (Multi-Function Module) Home menu, press an **ME** button.
- 2 Press a Key button 1-6 or hold and press for multiple channel control.
- 3 Press the **2DPM** button.

Enable iDPMs on a Karrera Control Panel

- 1 From the Karrera Control Panel, in the Modifier Area press an **ME** button.
- 2 Press a Key button 1-6 or hold and press for multiple channel control.
- 3 Press the **iDPM On** button.

Delegate eDPM Channels

- 1 From the Karrera Control Panel, in the Modifier Area, press the **eDPM** button.
- 2 The acquired eDPM channels are available in the keyer row, displayed in cyan (blue); when delegated, eDPM channels are always enabled.
- 3 Press a channel button or hold and press to select multiple eDPM channels.

Enable a 2D DPM on a Keyer

- 1 From the Karrera Control Panel, in the Modifier Area, press an ME button.
- 2 Press a Key button; 1, 2, 3, etc., or hold and press for multiple channel control.
- 3 Press the **2DPM On** button.

Enable DPMs from the Menu

For DPMs, double-select the keyer/channel to delegate the DPM:

- iDPM— select iDPM, Transform, Keyers iDPM tab and double-select one or more keyer buttons.

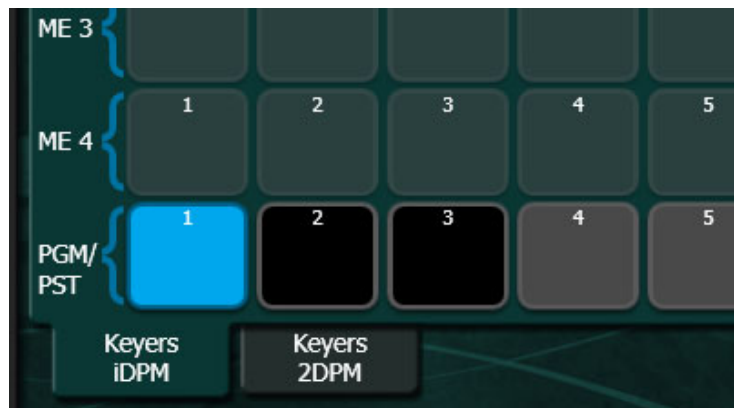

- 2D DPM—select **iDPM, Transform, Keyers 2DPM** tab and double-select one or more keyer buttons.

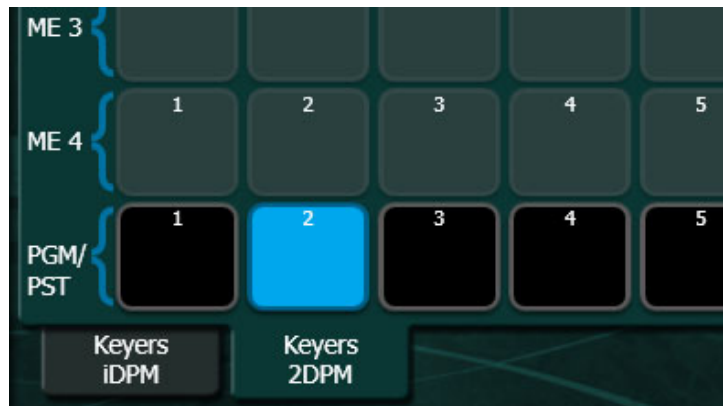

- eDPM—select **eDPM, Transform, eDPM, Channel DPM** tab and double-select one or more eDPM Channel buttons.

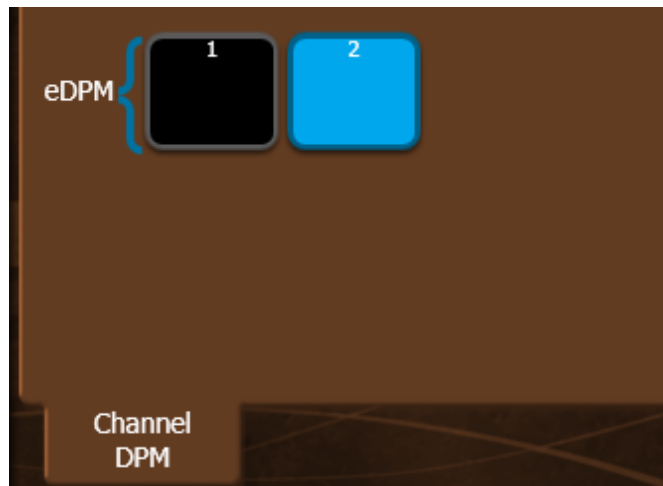

iDPMs

Share iDPMs/eDPMs from a pool of up to 16 physical DPMs (four DPMs per dual M/E board). DPMs are licensed in pairs.

Kayenne provides two DPM options:

- iDPM—Full DPM including transform engine for complex effect manipulation, up to 16 iDPMs can be licensed in pairs,
- eDPM—Up to six channels of DPM used inside the eDPM system which uses a separate control system and allows effects to be taken to air on any M/E as a single source.

2D DPMs

There are six 2D DPMs per M/E, including the Controller M/E and eDPM. Each can be sized, scaled, and moved along X and Y axis. 2D DPMs match the iDPM positioning of Post Transform control.

Kayenne (only) Parameter and Soft Knob Controls

When any of the MFM positioning parameter buttons are pressed, the soft knobs and joystick buttons are delegated for control of that parameter.

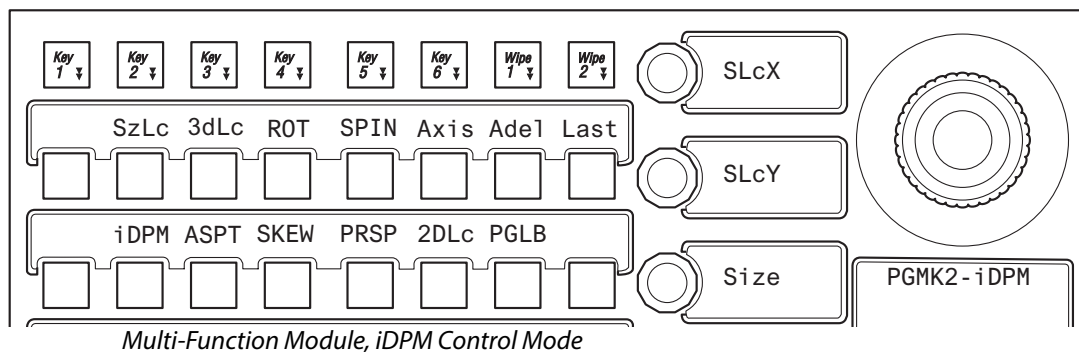

- SzLc—Size Locate (within 3D space)

Note: The X and Y axis modifiers are changing the same as the X and Y values for 3dLc.

- 3dLc—X, Y, and Z 3D Locate
- ROT—Rotate
- SPIN—Spin
- Axis—Locate Axis
- ASPT—Aspect
- SKEW—Skew
- PRSP—Perspective
- 2DLc—Post Transform (X, Y, and Z locate in 2D space)

The PGLB (Primary Global) and SGLB (Secondary Global) buttons available in the iDPM Mode in the MFM, activate keys delegated to Primary and Secondary Global Channels (iDPM Keyer delegations can only be made in the Menu Panel).

Note: The SGLB button is available in split M/E mode.

For the CROP, SHAD, FILM, and FRZ buttons, DELG must be pressed below each to delegate the MFM to those functions (not available for 2D DPMs).

DPM Source and Target Space Explained

Source space refers to a key moving along the X, Y, and Z axes of the partition global channel while *Target* space refers to the key moving along the X, Y, and Z axes of the monitor (refer to the *Switcher Concepts Manual* on grassvalley.com for a complete description).

Tally and DPMs

Tally is available only for DPMs that are on-screen. For example if a DPM is flown in from off-screen with an E-MEM, tally is off until the DPM is on-screen.

DPM Transform Menu

A DPM activated in a keyer can be controlled with the Transform menu. The Transform menu allows you to select the keyer or Global channel to control (delegation), select the desired type of transform control, and then adjust the parameters associated with the chosen control using the soft knobs or a pop-up keypad. The menu is accessed by selecting iDPM, Transform.

The Joystick (X, Y, Z, Size) can be controlled from the menu with the soft knobs or keypad entry.

Enable DPM Transforms in the Menu

The Transform menu contains a data pad matrix in the upper left for delegation. Data pads for keyers with DPMs assigned will be active. Inactive keyers will be grayed out. Select an active data pad to delegate the menu to control keyers, or to control a Global Channel (see [DPM Global Channel Assignments](#)). The keyer data pads themselves indicate whether Crop is enabled, Global Assignment is on, and if the Key Signal is off.

DPM Global Channel Assignments

The Primary Global and Secondary Global Channels are assigned in the iDPM, Transform menu, however the Secondary Global channel requires configuration in the M/E, Mode menu (see [Set Up a DPM Secondary Global Channel](#), on page 99).

When a keyer is assigned to a Global Channel, it is also affected by transforms of that Global Channel, permitting the easy creation of complicated multi-channel moves. Multiple keyers can be assigned to a Global channel, allowing coordinated moves of all the assigned keyers.

A keyer is associated with the Global channel by delegating the keyer, then selecting the Global modifier button in the ME/Keyer matrix on the upper left side of the Transform menu so it is illuminated. Using the Multi select button, more than one keyer can be selected at a time. The first keyer matrix button selected with the Global channel turns blue while subsequent buttons are outlined in blue when selected.

Some functions (Crop, Reverse, Skew, Aspect, and Post Transform) are inactive for these Global Channels so they are grayed out. Global Channel assignment information will appear in the ME/Keyer data pad (PRI Glb /SEC Glb).

Any transform type is applied across all keyers when they are assigned as global, i.e. Locate, Rotate, Spin, and Perspective.

Note: Keyer transform modifiers, i.e. Shadow, Splits & Mirrors, Output Recursives, etc., are available on a channel by channel basis and are independent from Global Transforms.

If for example you created an effect with three keyers assigned to DPM channels on an M/E, and selected those keyers and applied a Spin transform, all three keyers would spin independently around their own axis simultaneously. But if however you wanted all three to spin around one global axis, you could apply a Global channel to each of the three keyers

for that M/E, select those keys, and apply a Spin transform. All three keys would spin around the global axis.

Independent Axis Rotation

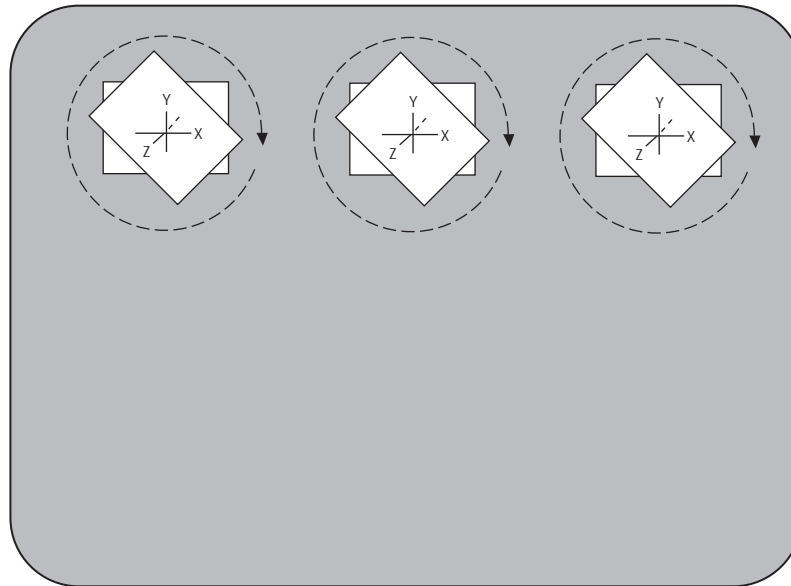

Global Channel Axis Rotation

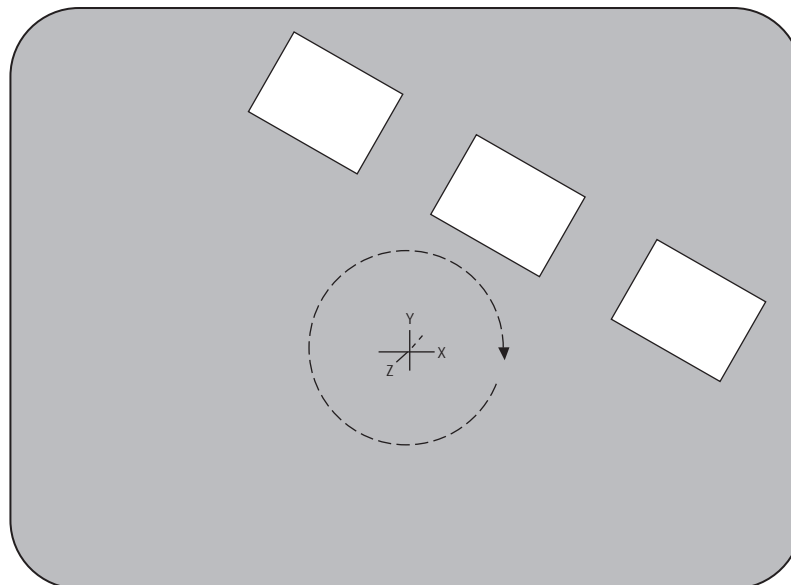

8623267_24

Spin Transform

Key Off Control

The Key Off button in the iDPM, Transform menu is used to turn off the key signal processing for the delegated keyer, resulting in a full raster image. For example, suppose

you want to fly a graphic that is normally accompanied by a key signal. Turning the key off forces the graphic to full raster, ignoring the key. The Key Off button is inactive for Global channels.

Easy Cube Control

When a channel is used to create a cube or slab, turning on the Easy Cube button iDPM, Transform menu automatically translates the delegated channel to the visible face of the shape as it is rotated in space.

Transform Controls

The Source and Target transform controls below the delegation matrix delegate what 3-D transformation will be controlled with the soft knobs or pop-up keypad entry. Selecting one of the transform buttons activates the soft knobs on the right side of the Menu Panel to control specific parameters of that transform and delegates the Path Control pane to that transform.

The transform controls are organized on the menu according to Source and Target space capabilities.

The Locate, Locate Axis, Target Rotate, and Spin transforms can be assigned to work in either source or target space with the select buttons at the lower-left of their pane. Selecting the Source button provides image adjustment using that channel's coordinate system for reference. Selecting the Target button provides image adjustment using the screen as the reference. Only one space button is selectable at a time.

Note: *Target Rotate* displays only Target Rotate transform parameter values, even when Source space is selected. The soft knobs still adjust either the Target or Source space rotation parameters, however.

Crop Controls

The Crop On button located in the Crop pane, right side of the iDPM, Transform menu, is used to activate the crop feature for the delegated keyer (this button is inactive for Global channels). The Crop Edge data pad delegates the soft knobs to control each side's cropping, while the Crop Softness data pad delegates edge softness control.

Reverse Controls

The Reverse controls are located to the left of the Crop pane, in the iDPM, Transform menu. The front and back sides of the transformed picture can be reversed vertically and/or horizontally with these controls.

Path Controls

The path control pane is located at the top-right of the iDPM, Transform menu. S Linear, Linear, and Curve interpolation select buttons are available. When Curve is selected, soft knob controls for Tension, Continuity, and Bias soft knob become available. You can also

turn off transform interpolation and hold each keyframe's values with the Path Hold select button.

Note: Use the Path controls in the E-MEM & Timeline menu to affect all DPM transform and effect modifiers. Path controls in the DPM menus are only used to adjust path parameters of individual values of a transform or effect modifiers.

All transforms except Spin apply the same path control to all that transform's parameters. Spin allows different paths to be specified for each axis of the transform. When Spin is selected, the X, Y, Z, and All select buttons are activated. The selected path will only be applied to the specified axis.

Clear Transforms

Two buttons located on the lower right side of the Enables pane of the iDPM, Transform menu are used to clear transform settings.

Clear X-Forms – Sets all transform parameters of the delegated keyer (or global channel) to Default Keyframe values. The transform parameters reside in the panels below the data pad delegation matrix and do not include Crop. Multi-Functions of other iDPM settings, i.e. Shadow, Kurl, and Lighting are not affected.

Clear All – Sets all transform parameters and all other menu settings, including Crop values, of the delegated keyer to Default Keyframe values.

Note: Corner Pinning is a function of i/eDPM and is an advanced operation. For operation information see [About Corner Pinning](#).

Border Menu

The DPM Border feature provides an independently controlled border for each licensed iDPM/eDPM, and 2D DPM. The borders are added "outside" of normal blanking. This means that when a border is added it does not crop into the original image so a border can be added to a full-sized image and it will not be visible until the image size is slightly reduced.

The following controls are provided from the menu for each DPM:

- Width and softness for border top, bottom, left and right side can be controlled independently or all together,
- Color (hue, saturation, and brightness),
- Choice of square or rounded border corners (including control of the curve tension, continuity, and bias), and
- S-Linear, Linear, Curve, and Path Hold.

DPM Borderline Menu

The Borderline menu is accessed by selecting DPM, Borderline.

Note: The Borderline menu is also available in the Keyer, Borderline menu which you would use if you did not have iDPM licenses.

Shadow Controls

The Shadow feature is turned on with the Shadow On button in the lower left pane. When turned on, soft knob controls become available on the right. Different soft knob controls appear, depending on which data pad has been selected in that pane. The current parameter names and values are displayed on each data pad.

- When Shadow is selected soft knobs for X Offset, Y Offset, Size, and Opacity are available.
- When Shadow Color is selected soft knobs for Hue, Saturation, and Brightness are available.

iDPM Shadow Crop Controls

The Crop controls in the Shadow pane are used to adjust shadow cropping and edge softness. The current parameter names and values are displayed on the data pads.

When Crop Follow Image is selected, crop values of the shadow match the crop values used for the primary image. Only shadow edge softness controls are active in this mode. When the Crop Softness data pad is selected soft knob controls for shadow edge softness are available (Top, Bottom, Left, and Right). The total softness of the shadow edges will be the softness of the shadow edge combined with any softness of the primary image.

When Separate Crop is selected, the edges of the shadow can be given crop values different from the primary image. Selecting the Crop Edge data pad delegates the soft knobs to control shadow edge cropping (Top, Bottom, Left, and Right).

Glow Pane Controls

Select the Glow data pad button to access the Glow controls in the Borderline menu.

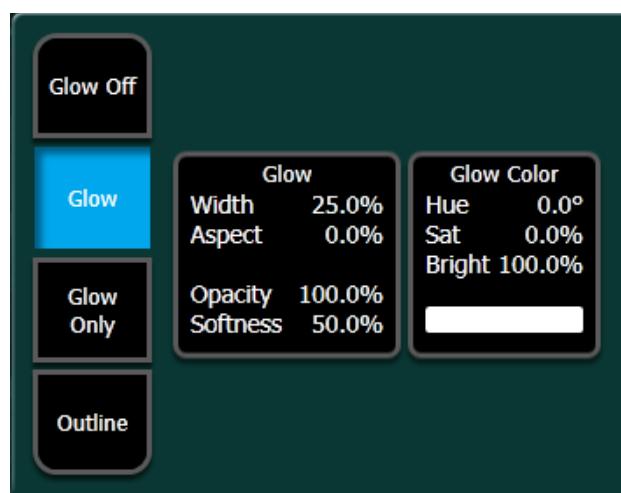

Glow adds a soft edged variable opacity border around keys, leaving the original keyed image unmodified, and is a standard feature available on all GV Switcher systems.

Off—The Glow effect is deactivated.

Glow—The Glow effect is applied around the keyed image which remains visible.

Full raster video must be resized or cropped for glow to be visible.

Glow Only—The glow effect is applied to the entire keyed area, replacing the original keyed image. Only the glow is shown.

Outline—The glow effect is shown around the keyed area, but the original keyed image is not shown. Only the border area of the glow is visible.

When the Glow pane is activated, knob controls for Glow Width, Aspect, Opacity, and Softness are available.

Note: The Glow Softness parameter value is shared with Shadow Softness. Adjusting either Glow or Shadow Softness will affect both Glow and Shadow Softness.

Glow Color

When the Glow Color pane is activated, knob controls for matte Hue, Saturation, and Brightness become available. An approximation of the color of the matte is shown at the bottom of the pane. Use these controls to adjust the color of the Glow.

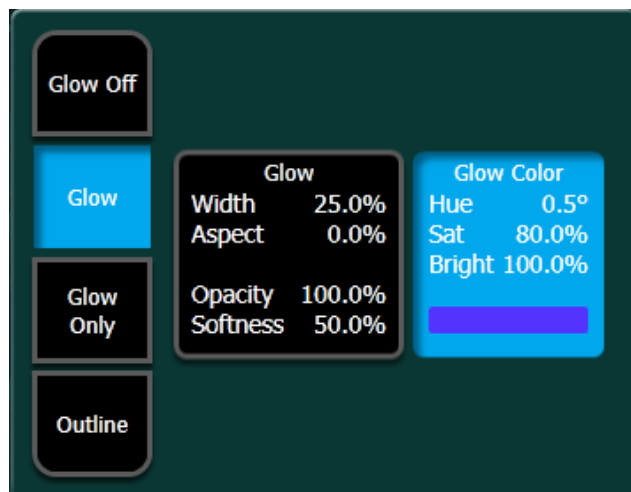

Glow Path Control Pane

Controls for glow path, using the standard Hold, S Linear, Linear, and Curve parameters, can be applied when the Adjust Path button is on (top right of Borderline menu).

iDPM/2D DPM Film Look Menus

With Film Look, you can create a flicker or strobe effect (similar to an old film run through a movie projector). The affect can be adjusted to the desired look by setting the interpolation (Frame, Field, or Adaptive for Video and Key), turning on Input Freeze and/or Strobe and adjusting those parameters with the soft knobs. Thresholds can also be adjusted for when working with cuts and artifacts.

iDPM Kurl Menu

The Kurl effects are grouped into modes, each of which has its own set of menu panes and related soft knob controls. To access the Kurl menu, select iDPM, Kurl.

The Kurl modes are:

- Position/Size Modulation,
- Page Turn/Roll,
- Ripple,
- Slits, and
- Sphere.

Only one set of Kurl mode parameters can be applied at a time. If you wish to use more than one mode of Kurl effects simultaneously on the same video (for example, size modulation of an effect), use multiple iDPMs with re-entry (for information about re-entry, see the Switcher Concepts Manual).

Kurl Position/Size Modulation Mode

Position and Size Modulation is an effect in which the source video is positioned or size-modulated through an additive process with either a single wave train, or two wave trains with the second wave at a right angle to the first. Each of the two wave trains (horizontal, vertical) may be selected independently from a set of modulation patterns.

Select the Pos/Size Mod Kurl Mode button to access the position and size modulation controls.

Modulation Pane

In the Modulation pane you select the wave train axis (Horizontal or Vertical) for which the rest of the menu controls will apply. The following Soft knob controls appear on the right for the selected axis:

- Amplitude—defines the modulation amplitude (the height of the pattern waves).
- Frequency—defines the modulation frequency and therefore the number of pattern cycles to appear across the source.
- Phase knobs—The Phase Lock button on the right controls whether the pattern is fixed (on) or moving (off). When Phase Lock is on, the Phase soft knob is available to control the static location of the phase of the pattern. When off, the Speed soft knob is available to adjust the speed of the pattern's motion. Negative values can be entered to reverse the direction of the motion.

- H/V Angle—defines the angle of the Position Modulation with respect to the source X and Y axes.

Mod Type Pane

With an axis selected, you select the type of modulation to be applied to that axis (Position Mod or Size Mod), or no modulation at all with the Mod Off button in the Modulation Mode pane. When the Vertical axis is selected, you can choose to have that axis' modulation values match the horizontal values with the Track Horiz button.

When Size Mod is selected in the Modulation Mode pane, the Size Mod Center data pad in the Modulation pane is active. When this data pad is selected soft knob controls for H Position, V Position, and H/V Angle are available.

Pattern Pane

The type of wave pattern to be applied to the selected axis and modulation type is selected in the Pattern pane.

- Cycle Limiting—activates the Cycles soft knob. This control can be used to limit the number of wave pattern cycles.
- Cycles + ve Only—selects only the positive portion of the wave cycle. Representative wave shapes.

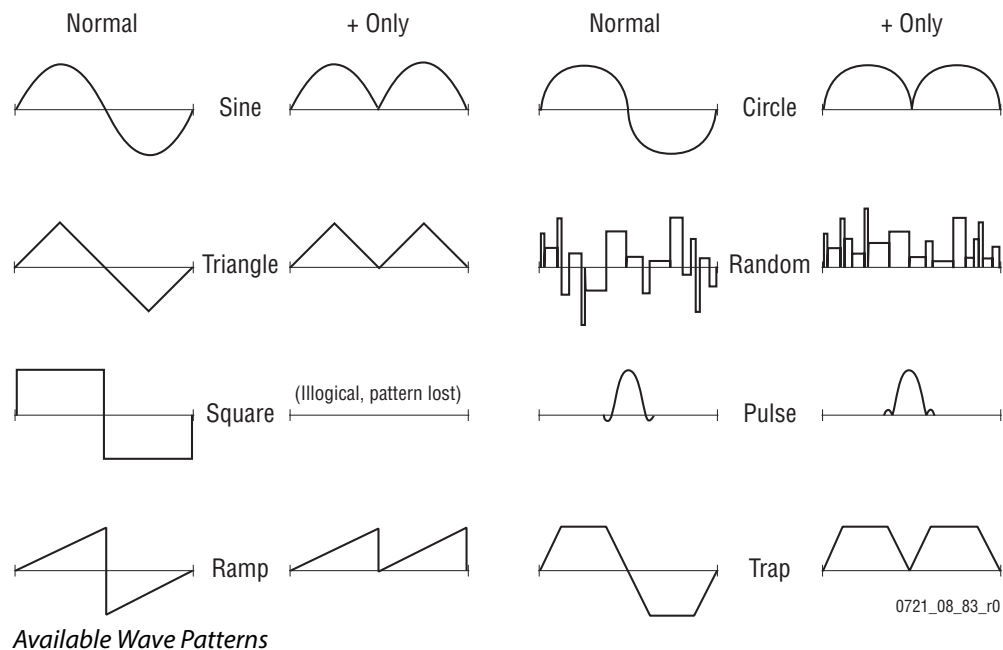

Page Turn/Roll Mode

Page Turn is a transition effect with the video being mapped to an original plane, a cylinder, and a final plane parallel to the original plane. Page Roll maps the video to an original plane and a cylinder. Page Turn and Roll are parallel projections to the target screen with no perspective.

Select the Page Turn/Roll Kurl Mode button to access the Page Turn and Roll controls.

Page Turn Pane

The page mode (Page Turn or Page Roll), and orientation of the fold (Fold Over or Fold Under the original plane) are selected in the Page Turn pane, bottom right of menu.

When the Page Fold data pad is selected, the following soft knob controls are available:

- Radius—adjusts the radius of the page turn cylinder affecting the sharpness of the curl.
- Angle—defines the orientation of the page turn cylinder with respect to the source X and Y axes, and specifies the direction of the turn.
- Offset—positions the page turn cylinder with respect to the source plane and, when interpolated between keyframes, causes the page to turn. The offset would typically change from one edge or corner of the source raster to the opposite edge or corner for the turn.

Show Sides Pane

Choices of what sides of the effect to display (Show Both, Show Front, Show Back) are available in the Show Sides pane. Selecting only a portion of the effect can be used for multi-pass effect creation.

When Back is Matte is selected, the back of the effect will be a matte color. The color of the matte can be changed by selecting the Back Color data pad to bring up soft knob controls for Hue, Saturation, and Brightness.

Split Axis Pane

Split page turn and roll effects are controlled with the Split Axis pane, bottom left of the menu. The effect can be split horizontally, vertically, or both ways using the labeled buttons (Horiz Split/Vertical Split).

Selecting the Split Axis Position data pad brings up Horizontal and Vertical soft knobs that control the location of the split.

Ripple Mode

Ripple is an effect in which the source video mapped to a plane is effectively distorted into and out of the target screen by a train of concentric waves. This is a parallel projection to the target screen with no perspective.

Select the Ripple Kurl Mode button to access the Ripple controls.

When the Modulation data pad is selected in the Ripple pane appears (lower left).

The Ripple soft knob controls and wave patterns are the same as Position/Size (except no H/V Angle control):

- Position/Aspect Data Pad—Soft knob controls are provided to control various attributes of the Ripple pattern:
- H Position—controls the horizontal position of the center of the ripple.
- V Position—controls the vertical position of the center of the ripple.

- Aspect—stretches the ripple horizontally or vertically.
- H/V Angle—adjusts the angle of the ripple, horizontally and vertically.

Slits Mode

Slits is an effect in which the source video is split into a number of parallel slits. The width of the slits may be uniform or random, and an angle may be specified. An offset function is provided which controls the amount of displacement of alternating slits in opposite directions (to cause a transition type effect).

Select the Slits Kurl Mode button to access the slits controls.

The Slits modulation soft knob controls and wave patterns are the same as Position/Size.

Selecting the Slits Controls data pad changes the Kurl menu to display Slits controls:

- Offset—sets the distance adjoining slits move away from each other. This can be used for transition effects, using a zero offset for the starting keyframe and an off the screen offset for the ending keyframe.
- # of Slits—defines the number of slits.
- Phase—determines the starting point or phase of the modulation to occur at the center point.
- Random—defines the degree of randomization of slit width.
- Angle—defines the angle of the slits with respect to the source X and Y axes.

Sphere Mode

Sphere is an effect in which the source video is mapped to the surface of a sphere. Controls are provided which change the aspect and size of the sphere, the point in source video to be mapped to the center of the front surface of the sphere, and the horizontal and vertical scaling of the source video to be mapped.

Select the Sphere Kurl Mode button to access the sphere controls.

The following soft knob controls are available:

- Size—defines the radius of the sphere before it is modified by Aspect.
- Aspect—scales the horizontal and vertical dimensions of the sphere.

When the Position/Wrap data pad is selected in the Sphere pane, the following soft knob controls are available:

- Horizontal Position—controls where the image is mapped onto the sphere by moving the image horizontally on the sphere's surface.
- Horizontal Wrap—controls how much of the image is mapped onto the sphere by compressing or stretching the image horizontally.
- Vertical Position—controls where the image is mapped onto the sphere by moving the image vertically on the sphere's surface.
- Vertical Wrap—controls how much of the image is mapped onto the sphere by compressing or stretching the image vertically.

DPM Splits Mirrors Menu

Located in the DPM, Splits & Mirrors menu, the Splits and Mirrors effect allows you to divide a picture horizontally and/or vertically, and create mirror images of the image along these axes.

Splits Pane

Select the **Splits On** button in the Splits Enable pane (bottom right) to bring up the Splits controls:

When the Splits button in the Splits data pad is selected, the following soft knob controls are available (values are displayed in screen units):

- Horizontal Center—controls the horizontal position of the split.
- Vertical Center—controls the vertical position of the split.
- Horizontal Separation—controls the amount of horizontal separation between the split images.
- Vertical Separation — controls the amount of vertical separation between the split images.
- All Separation—controls both horizontal and vertical separation simultaneously. This control is additive with the other separation controls, such that changing its values changes the H and V separation values.

When the Separate Sides data pad is selected, individual soft knob controls for separation are available. These controls allow movement of individual Top, Bottom, Left, and Right portions of the split image.

Splits & Mirrors Modifiers Pane

The Splits & Mirrors Modifiers pane has mirror and double image controls.

The mirror buttons replicate the side of a picture about the axis location to the opposite side. Mirror orientation is based on the picture's source space. It is possible to simultaneously reflect multiple sides by turning on the Mirror Top, Mirror Right, Mirror Left and Mirror Bottom buttons. The original picture for that side is always reflected. A side that has been mirrored to the opposite side will not be mirrored a second time.

When Double Image is on, the area of separation is filled by extending the interior sides of each half of the original split picture to the axis position. At large separation values the picture will be doubled about the axis. This control only has an effect when separation exists between the splits.

DPM Defocus Menu

Available in the DPM, Defocus menu, Defocus blurs the actual keyed image, and is available with the iDPM option.

Defocus Pane

- Defocus Off—The Defocus effect is deactivated.

- Defocus—The Defocus effect is applied to the original keyed image.
- Defocus NAM + —The defocused image is compared to the original image on a pixel by pixel basis, and the lighter (higher luminance) pixel of the two is used in the final image. Defocus NAM + can be used to simulate a fog filter type effect.
- Defocus NAM - —The defocused image is compared to the original image on a pixel by pixel basis, and the darker (lower luminance) pixel of the two is used in the final image.
- When the Defocus pane is activated, soft knob controls for Video Defocus, Video Aspect, and NAM Ratio are available.
- Video Defocus—adjusts the total amount of defocus applied to the image.
- Video Aspect—adjusts the percentage of defocus applied to the vertical and horizontal axes of the image.
- NAM Ratio—adjusts the level of luminance at which the Defocus effect will be applied to NAM pixels. This value applies to both NAM + and NAM - modes.

NAM Matte Pane

NAM Matte On button — When selected a matte color is applied to the selected NAM (lighter or darker) portion of the keyed image.

When the NAM Matte pane is activated, knob controls for matte Hue, Saturation, and Brightness become available. An approximation of the color of the matte is shown at the bottom of the pane.

DPM Lighting Menu

The Lighting menu provides four colored light sources positional in 3D space for each delegated keyer. Each light source can be a Point, Bar, or Plane. The apparent reflection of the light source simulates the physics of incident light falling on a surface, including specular effects and light falloff due to distance and geometry. The lighting parameters interact with one another, permitting the creation of subtle effects, and are keyframeable.

Some extremely low lighting values (particularly Light Softness) when used in combination with other lighting values can create visible artifacts (stair-step aliasing). Due to the intricate lighting parameter interactions, if these values were restricted to prevent all potential artifacts, other useful lighting effects would be impossible. For this reason, values that might cause aliasing are allowed. If a lighting effect looks bad, adjust the settings to correct its appearance.

Shadow Control Pane

The Shadow Control pane applies to all of the light sources for the delegated keyer and controls ambient lighting effects. You can control the color of the ambient lighting, and the amount of shadow falloff for the light sources. Soft knobs for Hue degrees, and Sat, Bright, and Shadow percentage are available when the data pad has been selected.

Light Type Pane

The four tabs (Light 1-4) in the Light Type pane delegate the menu to a particular light source.

The Light Type pane is used to turn on or off the delegated light source and provides various other controls of that light source. Soft knobs are activated when appropriate to control the various lighting parameters.

Light Type

- OFF—turns off the light source.
- Point—simulates a spotlight type of lighting effect that radiates light evenly in all directions.
- Bar—simulates lighting from a bar-shaped long, thin lighting source.
- Plane—simulates the glare that would be reflected from an image if a bright light were shined on it from infinity.

Light Control Pane

Position—Used with Point and Bar light sources to control the position of the point light, or the position of some point along the bar light, with respect to the X, Y and Z axes in 3D space.

Rotation—Used with Bar and Plane light sources to control the direction of the bar light, or the direction that the plane light faces along the X, Y and Z axes. Setting Rotation to 0 places the Plane light directly behind the viewer's head.

Appearance:

- Intensity—provides soft knob control of the overall reflectivity of the surface of the picture.
- Softness—control of softness of the edge of the light. 100% creates maximum softness, 0% gives a hard edge. At extremely small values some aliasing artifacts may appear.
- Gloss—provides soft knob control of how much light is scattered as it is reflected off the surface of the picture. At 100% the lighting acts like it is reflecting off of a mirror. At 0% the light acts like it is reflecting off of a frosted piece of glass.

Flare—When light reflects off a surface two lighting components result, the primary reflected light and a glare (flared halo) of scattered light. The Flare controls provide soft knobs to adjust this lighting component.

- Intensity—controls the amount of the flare light scattered off the surface.
- Ratio—controls the ratio between the primary light and the flare light. 100% is all primary light, 0% all flare light.

Independent Flare Intensity—allows independent control of the primary and flare components of the light. When Off, changing the value of one control will alter the appearance of the other component of the light. The actual values reported on the menu will not be different, but the changes will interact automatically to create the resulting image. When On, changing the values for one lighting component will not alter the appearance of the other component.

Light Color, Flare Color—provides soft knob controls of the Hue, Saturation, and Brightness of the Light or Flare lighting.

Lighting Path Controls

Path controls are available for Lighting parameters and provide soft knob control for Light Tension, Continuity, and Bias when the Curve button and Curved data pad are selected. A Path Hold button is also provided.

Lighting with Page Turn/Roll Effects

To use Lighting with Page Turn/Roll, you need to use one keyer for the Front side of the Page Turn and another keyer for the Back side. The same effect then needs to be loaded on both keyers, with one having only the Front selected in the Page Turn menu and the other having only the Back selected. The keyer priority will also need to be set appropriately to support fold over or under.

Lighting and Post Transform Space

The 3-D perspective of a lighting effect is not ignored for Post Transform moves. Lighting effects are not fixed to the surface of the Post Transform manipulated plane, but will shift during the move, just like an X or Y Locate move.

Output Recursive Menu

The Output Recursive menu is used to select the keyers you wish to control (delegation), the desired type of output recursive control, and then adjust the parameters associated with the chosen control using the soft knobs or pop-up keypads.

The menu is accessed by selecting iDPM, Output Recursive.

Output Recursive Presets

The Output Recursive system has a set of presets that can be selected to simplify creating effects with Output Recursive.

Rain, Wind, Smoke, Fire, Paint, and Erase effect buttons are provided.

Further adjustments can be made using the soft knobs and data pads available with the effects menu that is displayed (Trails, Montage, etc.):

- Rain—provides a vertical streaking of the image that resembles rain.
- Wind—provides trailing particles that resemble wind.
- Smoke—provides a dark gray, disintegrating trail that resembles smoke.
- Fire—provides a red, disintegrating flame effect.
- Paint—allows you to apply or “paint” the current image anywhere on the display using the joystick.
- Erase—allows you to erase the current effect using the joystick.

Output Recursive Modes

Select any of the four modes in the Output Recursive Mode pane to create keyer special effects. Each mode displays specific controls for parameters when selected.

Motion Decay Mode

Causes motion in the image to leave a blurred remnant in the area from which it was removed.

Appearance button—displays the “Pic” or Picture Decay value from the soft knob data pad.

Wind button—displays the Direction and Velocity (speed) values from the soft knob data pads.

Loop button:

- ON—starts the recursive effect
- OFF—stops the recursive effect and returns to live video

Keyframe Reset button — used to control when images are frozen, only available when the Keyframe mode button is selected as the Strobe Type.

- ON—A keyframe triggers a reset, followed by a new single strobe. It resets that loop by creating a new frozen image at each keyframe that has the Keyframe Reset button on.
- OFF—does not change the frozen image at each keyframe

Force Strobe—When an effect passes over or stops on a keyframe, a single strobe event is triggered. While the effect sits on a keyframe with keyframe-strobe on, no additional events are triggered. The “history” of the prior single event is discarded, and a single strobe is triggered again.

- ON — accumulates a field/frame of video within the Output Recursive loop.
- OFF — No action is taken.

Freeze Mode

Freeze is used to freeze and modify an image using the soft knobs for playback (soft knob parameters are also displayed in the Appearance data pad):

- Picture Decay—causes the frozen image in the Output Recursive to fade away evenly over time.
- Star Decay—causes random pixels of the frozen image in the Output Recursive to fade away over time.
- Period—defines the number of frames in a Strobe Cycle. Period is only available when Time is selected as the Strobe Type.
- On Time—sets the percentage of the period that the image is unfrozen. The default is 0.0%. On Time is only available when Time is selected as the Strobe Type.
- Strobe Type buttons—set the type of strobe effect that will cause the automatic freezing of the new image.
- None button—turns Strobe Off
- Time button—freezes a new image at an adjustable time interval (normal strobe)
- Keyframe button—freezes a new image at each keyframe
- Loop button
 - ON—starts the recursive effect
 - OFF—stops the recursive effect and returns to live video

- **Keyframe Reset button**—is used to control a frozen image. It is only available when the Keyframe mode button is selected as the Strobe Type.
 - **ON**—A keyframe triggers a reset, followed by a new single strobe. It resets that loop by creating a new frozen image at each keyframe that has the Keyframe Reset button on.
 - **OFF**—does not change the frozen image at each keyframe
- **Force Strobe button**—When an effect passes over or stops on a keyframe, a single strobe event is triggered. While the effect sits on a keyframe with keyframe-strobe on, no additional events are triggered. The “history” of the prior single event is discarded and a single strobe is triggered again.
 - **ON**—Accumulates a field/frame of video within the Output Recursive loop.
 - **OFF**—No action is taken.

Montage Mode

Creates a montage of still images.

Soft Knob Button Group:

- **Picture Decay**—causes the frozen image in the Output Recursive to fade away evenly over time.
- **Star Decay**—causes random pixels of the frozen image in the Output Recursive to fade away over time.

Strobe Timing:

- **Period**—defines the number of frames in a Strobe Cycle. Period is only available when Time is selected as the Strobe Type.
- **On Time**—sets the percentage of the period that the image is unfrozen. The default is 0.0%. On Time is only available when Time is selected as the Strobe Type.

Strobe Type buttons—set the type of strobe effect that will cause the automatic capture of the new image.

- **None**—turns Strobe Off
- **Time**—freezes a new image at an adjustable time interval (normal strobe)
- **Keyframe**—freezes a new image at each keyframe

Loop button:

- **ON**—starts the recursive effect
- **OFF**—stops the recursive effect and returns to live video

Keyframe Reset button—used to control when images are frozen. It is only available when the Keyframe mode button is selected as the Strobe Type.

- **ON**—A keyframe triggers a reset, followed by a new single strobe. It resets that loop by creating a new frozen image at each keyframe that has the Keyframe Reset button on.
- **OFF**—does not change the frozen image at each keyframe

Force Strobe button — When an effect passes over or stops on a keyframe, a single strobe event is triggered. While the effect sits on a keyframe with keyframe-strobe on, no additional events are triggered. The “history” of the prior single event is discarded, and a single strobe is triggered again.

- ON—accumulates a field/frame of video within the Output Recursive loop.
- OFF—No action is taken.

Mode buttons:

- Over—places the image over the remnant or “montage”.
- Under—places the image under the remnant.
- Erase—erases the image and remnant.
- Show Picture parameter button —
 - ON—(default) displays the live video image in addition to the still montage.
 - OFF—displays only the montage without the live video image.
- Matte Control buttons:
- None—No matte
- Matte—allows you to create a matte fill for the montage and activates the Hue, Saturation, and Brightness soft knobs for modifying the matte.
- Rainbow—allows you to create an alternating RGB rainbow matte fill for the montage and activates the Hue Speed, Saturation, and Brightness soft knobs for modifying the matte.
- Matte Parameter—activates the soft knobs for Hue (or Hue Speed for Rainbow Matte), Saturation, and Brightness and displays those values.

Trails Mode

Leaves a trail of partial images behind as the image is moved around the screen. A “wind blown” effect can be added to the images (decay settings can be adjusted to look like particles).

Soft Knob Button Group:

- Picture Decay—causes the frozen image in the Output Recursive to fade away evenly over time.
- Star Decay—causes random pixels of the frozen image in the Output Recursive to fade away over time.

Strobe Timing:

- Period—defines the number of frames in a Strobe Cycle. Period is only available when Time is selected as the Strobe Type.
- On Time—sets the percentage of the period that the image is unfrozen. The default is 0.0%. On Time is only available when Time is selected as the Strobe Type.

Appearance button—located bottom left of the menu, displays the “Pic” or Picture Decay value from the soft knob data pad.

Wind button—displays the Direction and Velocity (speed) values from the soft knob data pads.

Strobe Type buttons—set the type of strobe effect that will cause the automatic capture of the new image.

None button—turns Strobe Off.

Time button—freezes a new image at an adjustable time interval (normal strobe).

Keyframe button—freezes a new image at each keyframe.

Loop button:

- ON—starts the recursive effect.
- OFF—stops the recursive effect and returns to live video.

Keyframe Reset button — is used to control when images are frozen. It is only available when the Keyframe mode button is selected as the Strobe Type.

- ON—A keyframe triggers a reset, followed by a new single strobe. It resets that loop by creating a new frozen image at each keyframe that has the Keyframe Reset button on.
- OFF—does not change the frozen image at each keyframe

Force Strobe button—When an effect passes over or stops on a keyframe, a single strobe event is triggered. While the effect sits on a keyframe with keyframe-strobe on, no additional events are triggered. The “history” of the prior single event is discarded, and a single strobe is triggered again.

- ON—accumulates a field/frame of video within the Output Recursive loop.
- OFF—No action is taken.

Mode buttons:

- Over—places the image over the remnant or “montage”.
- Under—places the image under the remnant.
- Erase—erases the image and remnant.

Show Picture Parameter

- ON—(default) displays the live video image in addition to the still montage.
- OFF—displays only the montage without the live video image.

Matte Control buttons:

- None—No matte.
- Matte—allows you to create a matte fill for the montage and activates the Hue, Saturation, and Brightness soft knobs for modifying the matte.
- Rainbow—allows you to create an alternating RGB rainbow matte fill for the montage and activates the Hue Speed, Saturation, and Brightness soft knobs for modifying the matte.
- Matte Parameter—activates the soft knobs for Hue (or Hue Speed for Rainbow Matte), Saturation, and Brightness and displays those values.

DPM Global Channel Control Over Multiple M/Es

In the Menu Panel only, multiple M/E Global channels can be controlled. For example if three keys in PGM and three keys in M/E-3 are assigned to Global control, the two M/Es can be combined to control all six keys globally by selecting the PRI Global (or SEC Global if configured with Split M/E) button data pad for each M/E. All keys on PGM and M/E-3 execute the same transform.

Set Up a DPM Secondary Global Channel

By splitting the M/E into Primary and Secondary partitions, you can assign keyers in the Secondary Partition to global control just as with the Primary Partition. This allows you to create very complex effects on both outputs, including making keys on the Primary Partition visible on the Secondary Partition and vice versa.

The M/E partition must be split into Primary and Secondary before the Secondary Global channel can be assigned.

- 1 Select **ME, Mode** to access the Mode menu.
- 2 Select the ME button (far left) of the M/E you wish to split for Secondary iDPM Global channel assignment.
- 3 Select the **Split** button in the pane second from the left.
- 4 Select the keys you wish to assign to the Secondary Global Channel in the Secondary Assign pane.
- 5 Repeat Steps 2-4 for each M/E you wish to split and assign keyers to the Secondary Partition.
- 6 Select **iDPM, Transform**.
- 7 Activate the keyers assigned to the Secondary Partition by selecting the assigned M/E keyer button and selecting the **Global** toggle button to highlight it.

The ME keyer button displays SEC Glb to signify the keyers Secondary Global assignment.

Adjust iDPM/2D DPM Border Edges

Adjust the border edges together:

- 1 Select **DPM, Keyers iDPM** or **Keyers 2DPM, Border**.
- 2 Select an ME/Keyer data pad on the left side of the menu (or use the Multi select button for multiple keyers).

Note: DPMs selected for borders using the Multi select button will each have the same border values.

- 3 Turn on DPM Borders by selecting either the **Square Border** or **Round Border** button in the Border Enable menu pane.
- 4 Select a path type by selecting the **S-Linear**, **Linear**, or **Curve** data pads in the Border menu pane.
 - a If Curve is selected, the Tension, Continuity, and Bias can be adjusted using the soft knobs or pop-up keypads.
- 5 Select the **Width** or **Softness** data pads and use the **Size** or **Softness** soft knobs or pop-up keypads to adjust those values.

iDPM/2D DPM Border Color

Adjust the border color by selecting the Border Color Adjust data pad (the color value is displayed in the data pad) and then turning the Border Hue, Border Saturation, or Border Brightness soft knobs or using the pop-up keypads to adjust those values.

Note: Color is applied to the entire border, there is no independent control.

Adjust iDPM/2D DPM Border Edges

The width and softness of DPM Borders can be adjusted for each edge independently, using the soft knobs or pop-up keypads.

- 1 Select **DPM, Borders**.
- 2 In the iDPM (or eDPM in eDPM mode), Border menu, select the **Square Border** or **Round Border** button to enable Borders.
- 3 Select the **Separate Edges** button.
- 4 Select the **Width** or **Softness** data pad.
- 5 Use the **Border Size/Softness Top, Right, All, Left, or Bottom** soft knobs or pop-up keypads to adjust the edges independently of the others.

Note: The Border Size All/Softness All data pads allow you to adjust the relative values for size or softness of all edges simultaneously.

eDPMs

The GV Switcher eDPM option is like an external two channel DVE built into the switcher. Either of the outputs (eDA for the Primary Partition and eDC for the Secondary Partition) can be combined and composited for re-entry, allowing multiple eDPM Channels on one keyer. eDPM channels run on their own timelines which makes this feature very flexible.

Combining iDPMs with eDPMs can be very powerful. With the addition of eDPMs, you could:

- On the same M/E, create four iDPM transforms on Keyers 1-6 and then create two eDPM transforms (perhaps a graphic and a clock) and assign those transformed sources to Keyers 5 and 6,
- Map the M/E to a PGM PST source select button and have a composite of six DVEs on one source to take to air, then
- Assign the M/E source to one of the four keyers on PGM PST and key the composite of DPMs, or
- Apply an additional transform to the composite with a PGM PST iDPM on any of the first four keyers and transform the entire composite.

eDPM Channels assigned to the Primary Partition can be made visible in the Secondary and vice versa.

The GV Switcher eDPM option has similar menus and controls to the iDPM option.

eDPM and Effects

eDPM is completely separate from the rest of the Switcher Master E-MEM so you can recall and run effects from the eDPM independently, or, you can use the Master E-MEM timeline to recall and run the eDPM. This allows you to control the eDPM exactly as you would with

an external DPM. Also, you can have multiple E-MEM registers recalling the same eDPM effect.

The switcher timeline and the eDPM timeline can be different registers and have different lengths. If you run the timeline from the eDPM Timeline, it will run the effect as created in the eDPM or if you run it from the Master E-MEM timeline (Switcher mode), it will run until the Master E-MEM timeline is complete.

If your E-MEM effect in the Master E-MEM only has one keyframe, you must insert an additional keyframe to run the entire eDPM effect timeline.

Note: For E-MEMs learned using versions earlier than 2.0 to work properly, you must reconstruct a timeline for the proxy sub-levels to run. The proxy sub-level register has been created but is limited to a single keyframe.

Recalling and editing eDPM timelines from the Master E-MEM timeline is truly independent and does not effect the keyframes in the eDPM. Inserting keyframes in the Master E-MEM's eDPM sub-level timeline creates a keyframe which is a 'proxy' to drive the eDPM's timeline.

- When running an eDPM timeline from the Master E-MEM timeline, pauses on the eDPM side are ignored.
- Start delays on the Master (Switcher) side are executed before eDPM timeline.

eDPM Partitioning

The eDPM partition boundary is a sub-level in the eDPM Primary partition. The Select All, EDPM Pri and EDPM Sec, and PART buttons are used to enable/disable the partition settings and control the Channel settings in the Picture, Combiner menu.

Note: Unlike Master E-MEM Part level, the PART in eDPM is a sub-level of eDPM Primary and cannot be enabled unless eDPM Primary is also enabled.



In the Control Panel, the eDPM Primary and Secondary partitions are available via the eDPM Pri/eDPM Sec buttons in the Master E-MEM area.

Note: The PART button is provided in the E-MEM & Timeline menu so the eDPM Master E-MEM partition can be enabled/disabled.

eDPM Definable Sub-levels

The Master E-MEM eDPM sub-levels (eDPM Pri and eDPM Sec) can be configured as Definable (controlled) or Not Assigned in the User Setups, Suite Prefs, E-MEM Prefs, eDPM menu (see Define E-MEM on page 326 for information about defining/assigning E-MEM sub-levels).

The example shows the two defined eDPM sub-levels in the Master E-MEM Timeline for M/E-3.

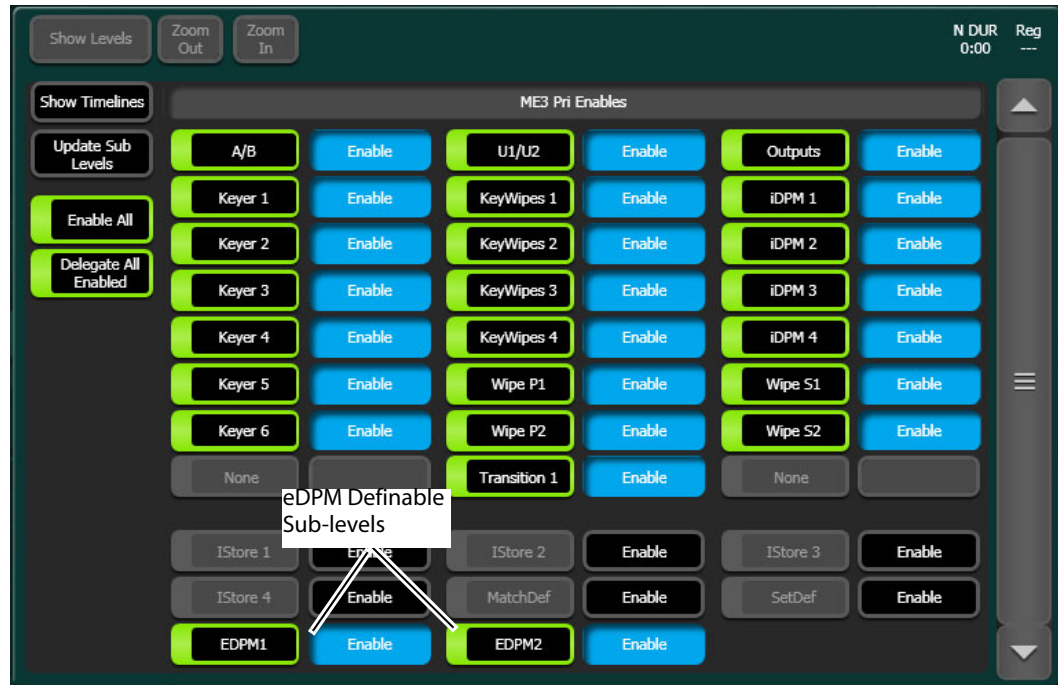

Using definable sub-Levels allows for the recall of eDPM effects from Local E-MEM. For example, effects created for M/E 1 can have the eDPM definable sub-levels and will then run eDPM effects.

Assign Sources

Assigning sources for eDPM transform is done in the eDPM Mode Source Ops, eDPM menu. To assign sources in the eDPM Mode Source Ops, eDPM menu (also available in the Switcher Source Ops menu):

- 1 In the menu, select **Source Ops, eDPM**.
- 2 Select the input channel button for the channel you wish to assign a source.
- 3 Scroll and select the source you wish to assign to the eDPM channel from the Sources scrolling list (right side of menu).

Note: If you select an eDPM Fill button first, then a source, the Cut and Fill signal for that channel will be the same. Select the Cut button to assign a different source for the Cut button (split key).

- 4 Repeat Steps 1 and 2 for up to four input sources for each eDPM channel.

Button Mapping eDPMs to an M/E

Map the eDPM outputs to the source select buttons on the M/Es in the User Setups, Panel Prefs, Button Mapping menu (see [Map Control Panel Source Select Buttons](#), on page 21).

Note: eDPM sources are identified as eDA and eDC and have a corresponding key (cut) signal already associated with those outputs, therefore the key signal outputs of the eDPM channels do not need to be mapped on the switcher for normal operations.

eDPM Mode Menus

Selecting the eDPM Mode button (bottom left) changes the menu to the eDPM Mode.

eDPM 2DPM Menu

When the 2D DPMs option is enabled, the eDPM Transform menu's Channel 2DPM tab will be active.

Enabling eDPM 2D DPMs

- 1 Select **eDPM, Transform**.
- 2 Select the Channel 2DPM tab.
- 3 Double click on an eDPM channel to enable 2D DPM on that channel.

eDPM Effects Menus

The eDPM, Transform menu is identical to the iDPM, Transform menu ([DPM Transform Menu](#), on page 80) in all ways except the ME/Keyer selection matrix (upper left pane) is replaced with the six channels of the eDPM, however the functionality is the same in regard to selecting channels and Global Channels.

The remainder of the eDPM effects menus operate the same as in the iDPM menu:

- Transform ([Transform Controls](#), on page 83)
- Border ([Border Menu](#), on page 84)
- Borderline ([DPM Borderline Menu](#), on page 84),
- Film Look ([iDPM/2D DPM Film Look Menus](#), on page 87),
- Kurl ([iDPM Kurl Menu](#), on page 87),
- Splits & Mirrors ([DPM Splits Mirrors Menu](#), on page 91),
- Defocus ([DPM Defocus Menu](#), on page 91)
- Lighting ([DPM Lighting Menu](#), on page 92), and
- Output Recursives ([Output Recursive Menu](#), on page 94).

eDPM Category Menus

The eDPM Mode category menus for the GV Switcher eDPM option operate independently from the Switcher Mode (there is access to eDPM menus in the Switcher Mode for convenience).

File Ops Menu

The eDPM File Ops menu allows you to create folders and save, load, and manage the 1000 eDPM register files and all files.

To access the eDPM File Ops menu, select **File Ops**, and either the **eDPM** or **All Files** menu button. The eDPM File menu controls are identical to the Switcher Mode file operations ([About File Operations](#), on page 37).

eDPM File Ops, eDPM Files Menu



E-MEM & Timeline Menu

The eDPM E-MEM & Timeline menu controls are identical to that of the Switcher Mode ([Basic E-MEM Operations](#), on page 109), including the advanced Partial Keyframing ([Partial Keyframing](#), on page 274) and Define E-MEM ([About Define E-MEM](#), on page 276) features.

Note: Define E-MEM for eDPM partitions are enabled in the E-MEM Prefs, ME Partition menu.

To access the eDPM Timeline Edit menu, select **E-MEM & Timeline, Timeline Edit**.

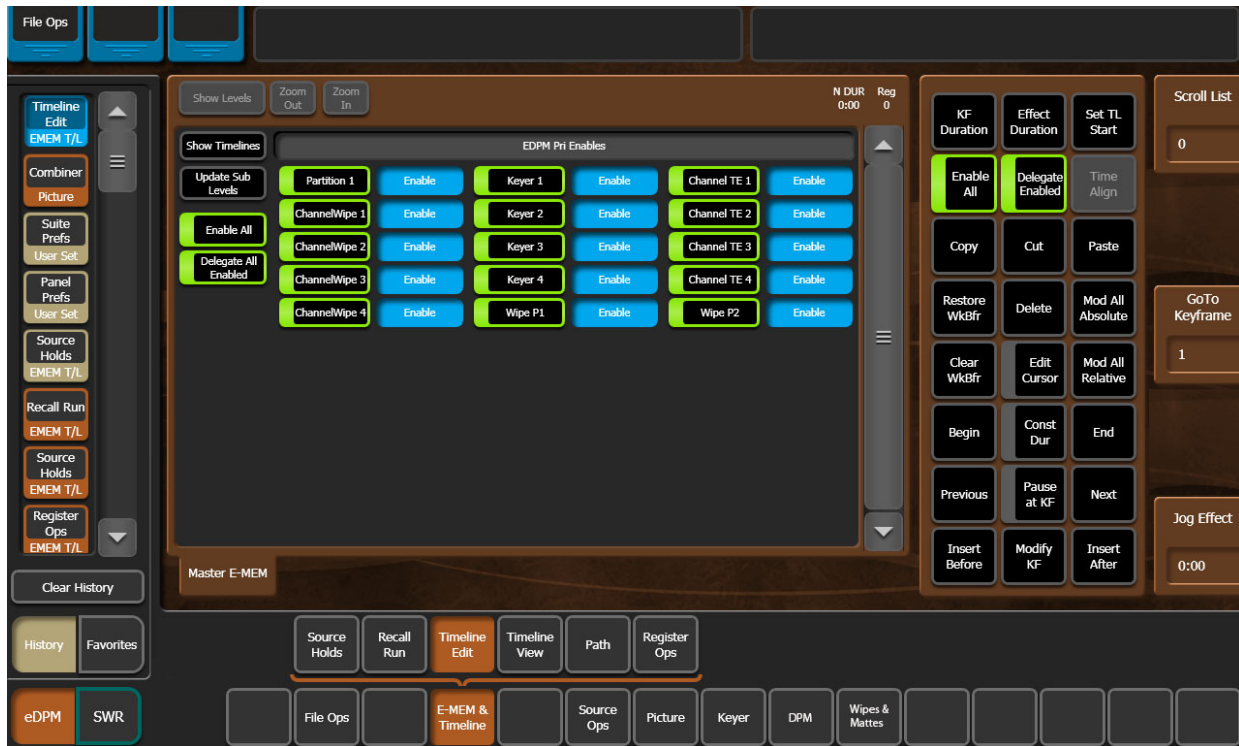

eDPM output channels have their own timelines, independent of the Switcher Mode.

Note: Editing (insert, modify keyframes, etc.) can only be performed in the eDPM Mode menus. You can only view the eDPM timelines in the Switcher Mode.

Source Ops Menu

The eDPM Source Ops menu provides Source Holds ([About Source Holds in Effects](#), on page 269) and Near and Far side (see the *Switcher Concepts Manual* at www.grassvalley.com for more information) source selection for eDPM Channels using the scrolling list with Lock button at the right of the menu.

Select **Source Ops, eDPM** to access the menu.

Picture Menu

The eDPM Picture menu provides controls for the Combiner, Video Processor, and RGB Color Correction functionality. The Video Processor and RGB Color Correction menu controls function identically to those in the Switcher Mode.

Combiner Menu

For eDPM, the Combiner assigns which channels will be controlled by the eDPM Secondary E-MEM system. eDPM channels can be made visible on both Primary and Secondary partitions.

The Primary Partition is made up of output eDA and eDC for the Secondary Partition. Also, as with iDPM, the eDPM channel on the Primary Partition can be made visible on the Secondary Partition and vice versa (see [Keyer Partition Visibility](#), on page 302).

Select **eDPM, Combiner** to access the menu.

The process for assigning a Global Channel to eDPMs is the same as assigning Global Channels to iDPMs (see [DPM Global Channel Assignments](#), on page 80).

6 Switcher Control

Basic E-MEM Operations

The E-MEM (Effects Memory) system provides a way of storing effects for later use. An effect defines parameter settings that determine how the selected video sources are processed. An E-MEM effect is *learned* into an effect register, and can then be *recalled* at a later time with a single button press. Effects can be edited after they have been learned, and effect data can also be saved to and loaded from disk.

The GV Switcher system has 1000 E-MEM registers organized into Pages and Banks. There are ten pages of ten banks with 100 E-MEM registers each, that can be learned and recalled from the menu or in the Local and Master E-MEM areas.

Register operations such as Learn and Recall can be performed in the current page and bank or changed before selecting the desired register.

Time Value Entry

Time values are input on the GV Switcher Control Panel Local E-MEM and Master E-MEM areas in seconds, frames, odd field format, using the • button the separator (indicated below as “•”) and pressing the hard button below “Enter” in the display to complete the entry:

(seconds), •, (frames), •, (field), Enter

The default time entry is in frames. For example, a time of 15 frames (one half second on 60 Hz systems) can be input simply by pressing:

15, Enter

Entries in seconds can be entered by adding one separator. For example, a time of 1 second is input by pressing:

1, •, Enter

An odd field is input by pressing 1 as the last entry. For example, a time of one second 15 frames and one field is input by pressing:

1, •, 15, •, 1, Enter

After an odd field has been entered, it is represented with an “f” in the E-MEM readout. For example, the completed time above appears as 1:15f. It is possible to enter values other than 1 as an odd field. The system will calculate and display the correct number frames and a single odd field.

To enter only fields, use two separators before the number. For example, a time of 30 fields (one half second on 60 Hz systems) is entered by typing:

•, •, 30, Enter

Pressing the • button first resets the effect duration to the Natural duration.

You can actually enter any combination of seconds, frames and fields. The GV Switcher system will do the conversion and display the result in seconds, frame, field format.

Decimal values for other non-time parameters are also input in the Master E-MEM area with the numeric keys, the **.** button for the decimal, and the Enter button to complete the entry. If a default value exists for an entry, it can be input without typing in a value by pressing:

., Enter

The GV Switcher Menu Panel also provides a select activated keypad for entering values directly into menus, using similar procedures.

Learning E-MEM Registers from the Control Panel

The current operational settings in the work buffer of a control surface Stripe in the Local E-MEM, or any number of Stripes in the Master E-MEM, can be learned into an E-MEM register. To learn more about E-MEMs, work buffers, and registers, see the *Switcher Concepts Manual* at grassvalley.com.

Learn a Register in the Current Bank

To learn registers in the current bank from the Control Panel:

- 1 Create the effect.
- 2 Press the **LRN/Lrn** button.
- 3 Press the keypad number of the desired register.

Learn a Register to a Different Bank

- 1 Create the effect.
- 2 Press the **LRN/Lrn** button.
- 3 Press the Page button (if necessary).
- 4 Press the button for the desired page: 0, 100-900.
- 5 Press the **BNK/Bank** button.
- 6 Press the button of the desired bank.
- 7 Press the keypad button of the desired E-MEM register.

Alternatively, you can perform the Page and Bank selections, press the **LRN/Lrn** button, then press the desired register button.

Copying E-MEM Timeline Information with Get and Put

The Put and Get feature buttons are provided in the Master E-MEM Module.

Perform a Put

The Put function allows you to copy the E-MEM Timeline information from the current E-MEM register to another E-MEM register.

- 1 Press the **EMEM Edit** button on the Master E-MEM Module.
- 2 Press the **Put** button, the Put menu is displayed.

- 3 Enter the target register number for the E-MEM you wish to put the current register's E-MEM Timeline information, and press **ENT/Enter**.

Note: Pressing the Put button then the Dot "." button will put the current register into the next available register.

Perform a Get

The Get function allows you to copy the E-MEM Timeline information from another E-MEM register to the current E-MEM register.

- 1 Press the **EMEM Edit** button on the Master E-MEM Module.
- 2 Press the **Get** button, the Get Register menu is displayed.
- 3 Enter the target register number for the E-MEM you wish to get the E-MEM Timeline information from, and press ENT/Enter).

Note: Pressing the Get button, Dot "." button, then ENT/Enter clears the current register. The Master E-MEM Module displays a "Clear current?" prompt after pressing the Get and Dot "." buttons. Press the ENT/Enter button should you wish to continue.

Recalling E-MEM Registers from the Control Panel

If recalling effects from the Master E-MEM area with Auto Recall off, you first need to specify which levels you wish to control with the Enable buttons in the E-MEM & Timeline, Register Ops menu.

To recall an E-MEM register, press the following:

- 1 **Page** button (if necessary).
- 2 Button for the desired page: 0, 100-900.
- 3 **BNK/Bank** button.
- 4 Button of the desired bank.
- 5 Keypad button of the desired E-MEM register.

Alternatively, you can perform the Bank, then Page selections, then press the desired register button.

GV Korona E-MEM Run from the Control Panel

A Local/Master E-MEM Run button (L-Run/M-Run) is available on the GV Korona Control Panel. When the top Source Select button row is delegated to E-MEM (by pressing the E-MEM delegation button) the right-most Source Select button is delegated as a Run button.

Local E-MEM is the default (L-Run is displayed in the OLED below the button).

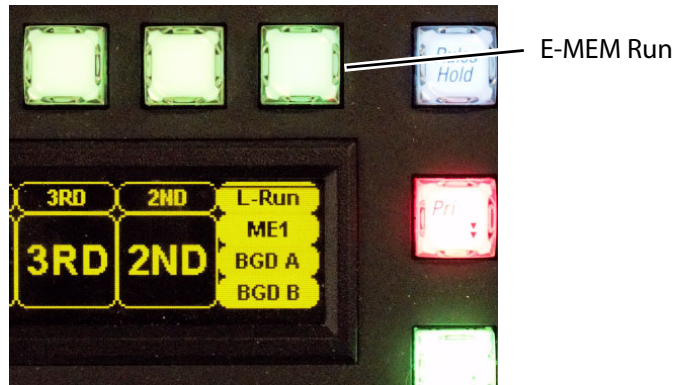

GV Korona E-MEM Run Button

Pressing and holding the E-MEM delegation button changes the delegation to Master E-MEM (button colors change and M-Run is displayed in the OLED below the right-most button). Press and hold again to return to Local E-MEM.

Press any E-MEM button in the delegated row then the Run button to run the Local or Master E-MEM.

Clearing E-MEM Registers

Both currently selected and different registers can be cleared from the E-MEM & Timeline, Register Ops menu.

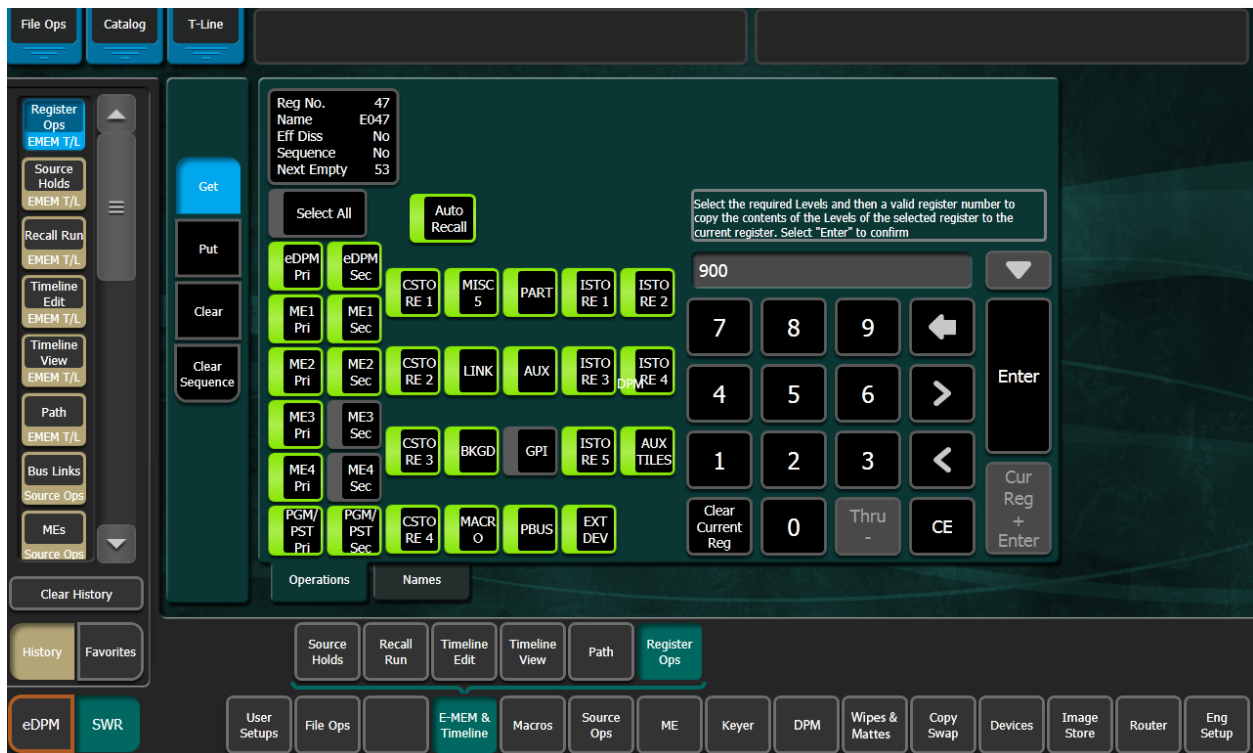

Clear the currently selected register:

- 1 Select the **Clear Current Reg** button, bottom left of the keypad (lower right of menu).

Clear a different register:

- 1 Select the **Clear** button (left side of menu).
- 2 Using the keypad, enter the register number to be cleared and select **Enter**.

Running an E-MEM Effect with Auto Run

Run an E-MEM with Auto Run off:

- 1 Recall the desired effect.
- 2 Press **Run**.

Run an E-MEM with Auto Run on:

- 1 Recall the desired effect—the effect will run as soon as it is recalled.

Learning E-MEM Sequences

Learn a Sequence of E-MEM Registers

- 1 Press **LRN/Lrn, SEQ/Seq**.
- 2 Press the **Page, Bank, and Register** number keypad buttons in the order you wish them to run. Delay time can be added at each register by pressing **Trans Rate** and entering a time value.
- 3 Press **LRN/Lrn**.

Play a Sequence of E-MEM Registers:

- 1 Press **SEQ/Seq**.

Press the **Page, Bank, and Register** number keypad buttons of the starting register.

Break a Sequence:

Press **LRN/Lrn, SEQ/Seq**.

Press the **Page, Bank, and Register** number keypad buttons of the ending register to end the sequence.

Press the same register button a second time.

Advanced E-MEM Operations: Partial Keyframe/Define E-MEM Settings

When using Partial Keyframing and/or Define E-MEM, learning registers will restore advanced settings back to default unless one of the following procedures are followed.

Before selecting an E-MEM register, to retain Partial Keyframing/Define E-MEM settings, either:

- 1 Hold down the **LRN/Lrn** button on the Local or Master E-MEM Module on the Control Panel
- 2 Select an E-MEM register (the Learn button turns blue indicating the advanced settings are retained),

-or-

- 1 Enable the **Learn Partial** mode button in the E-MEM & Timeline, Recall Run menu.

Macros

Macros provide a mechanism to record a series of actions and then play them back by pressing a single button. Macro steps specify commands sent to the Video Processor Frame, rather than simple button presses. Macros are fundamentally different from E-MEMs. E-MEMs store the complete state of a portion of the switcher (level and sub-level) into keyframes. For example, an E-MEM keyframe for M/E 1 captures all the source selections, keyer settings, transition type, wipe patterns, etc. for all the buses of M/E 1 at the time that keyframe was added to the E-MEM register. A macro, on the other hand, affects only the specific elements involved in the recording of that macro. For example, a macro can be recorded that sets up only the Preset bus with a particular source and selects a specific wipe pattern and transition rate. You can recall an E-MEM to put the M/E in a known state, and when you want to prepare that specific transition to just that source, simply play the macro. In this example, different macros can be recorded with different sources to allow rapid and reliable variations on the E-MEM effect that was originally recalled.

A macro can contain several steps. Macros are executed as quickly as possible in the order the steps are recorded. It is also possible to insert delays (including a User Pause), in a macro sequence during recording to accommodate external devices or allow for completion of internal system events.

Macros add enormous power and flexibility to the GV Switcher system. Simple tasks can be recorded into a macro quickly and easily for rapid and reliable playback. Complex series of actions can also be programmed into a macro, but careful planning is required to ensure the macro accomplishes its intended actions for all the conditions under which it may be played back.

Note: Macro attachments are saved and loaded with Panel Prefs. One set of attachments exists for each control surface. Be sure the Panel Prefs you load are compatible with the Macro registers you are currently using, to avoid accidentally running incorrect attached Macros.

About Multiple Macros and Player Groups

GV K-Frame XP systems support multiple macros that allows you to run up to five macros at once, in each of four macro groups, per suite. The four macro player groups are:

- GPI,
- E-MEM,
- CS B (Control Surface B), and
- CS A (Control Surface A).

Control Surfaces

There are two Control Surfaces in a suite; CS A (Control Surface A) and CS B (Control Surface B). Up to five macros can be run concurrently from each control surface macro player group. Pressing a button with a macro register delegated or attached:

- Plays a stopped macro,
- Stops a running macro, or
- Resumes a paused macro.

Macros run from one control surface can also be controlled from the other, for example:

- A macro run from CS A can be stopped by pressing a macro button with the same macro register delegated or attached on CS B, and vice versa.
- A macro run from CS B with a User Pause can be resumed by pressing a button with the same macro register delegated or attached on CS A, and vice versa.

GPIs

GPIs are configured to run macros in the User Setups, Suite Prefs, GPIs menu. GPIs can run, stop, or resume up to five macros per suite ([Macro Control Menu](#)).

Note: Unlike Control Surfaces A and B and E-MEM macro player groups, GPIs only run or resume paused macros associated with the GPI Input.

E-MEM

Up to five macros can be run from E-MEM simultaneously, per suite ([Macro Control Menu](#)). Macro in E-MEM is configured in the Macros, Catalog menu. There are two E-MEM functions: *Run From Pause* and *Select*. A "Run From Pause" command ([Learn a Run From Pause E-MEM Command](#)) can be added to an E-MEM to resume a User Pause in a macro. The *Select* feature ([Learn a Select E-MEM Command](#)) starts the macro from the beginning, regardless if it is paused or stopped.

Macro Control Menu

The Macro Control Menu and Control Panel are part of the *Control Surface*. There are four macro player control surface groups displayed in the Control Menu: GPI, E-MEM, CS B and CS A with five macro players each, for a total of 20 macros displayed. The Macro Control menu displays the status of the five players in each group. From the Macro Control menu, you can stop or resume a paused macro from any group. For information about playing macros, see ([About Playing a Macro from the Control Menu \(Important\)](#)).

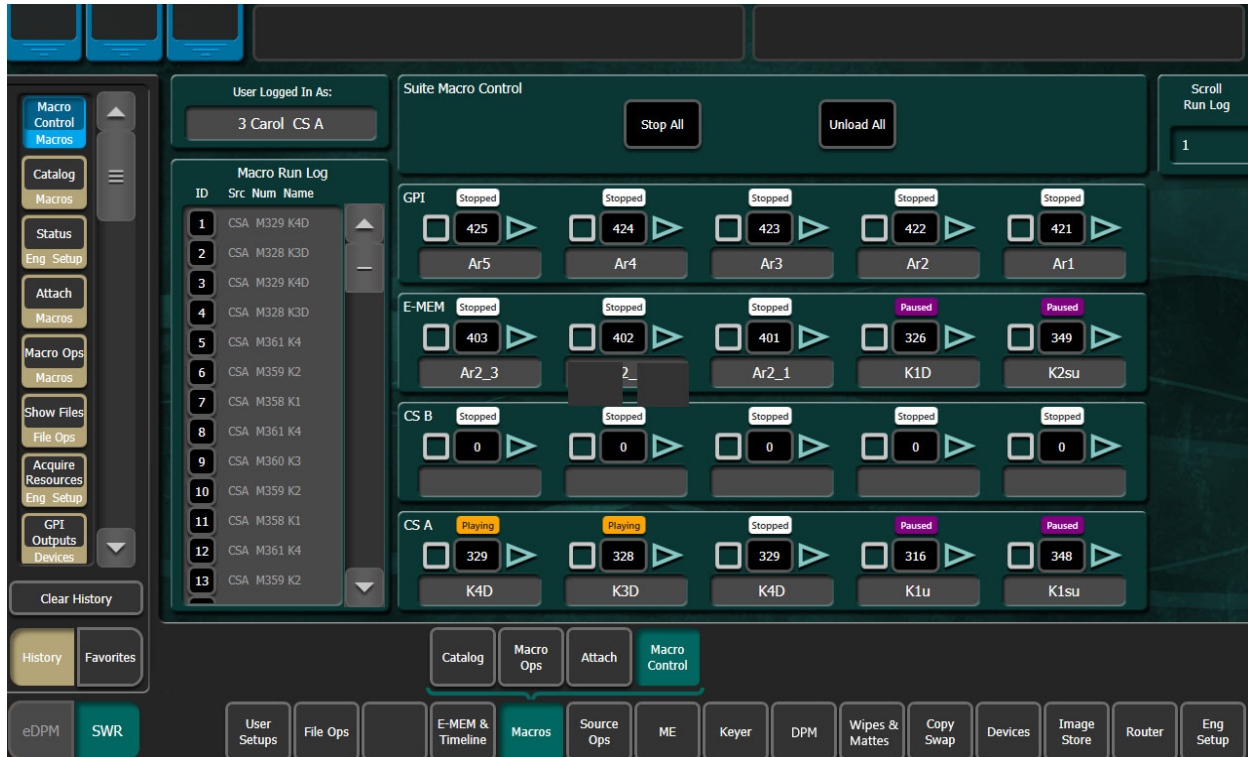

For all groups:

- The latest macro played from the menu will be displayed in the far left player of the control surface you are logged into and
- Previously run macros will shift to the right when the latest macro is run so only the last five macros are displayed.

Macro Control Menu Buttons and Data Pads

Menu Pane	Button/Label	Description
User Logged In As:	User Logged In As:	Suite, Suite Name, and Control Surface logged into in the Eng Login menu
Macro Run Log	Macro Run Log	Scrolling list of the last 99 macros played
	ID	1-99 of the last played macros, last played first
	Src	Macro player group: GPI, E-MEM, CS B, CS A
	Num	Macro register number
	Name	Macro name

Macro Control Menu Buttons and Data Pads

Menu Pane	Button/Label	Description
Suite Macro Control	Stop All	Stop all macro players
	Unload All	Unloads all macros from players (clears macro number)
Player Groups	GPI	<ul style="list-style-type: none"> • Status labels: Stopped (white), Playing (orange), Paused (purple) • Stop button (square) • Macro number • Play (right arrow) plays a macro or resumes a paused macro
	E-MEM	
	CS B	
	CS A	
Scroll Run Log	Scroll Run Log	Use Menu Panel soft knob to scroll or, Select data pad and enter 1-99 in Macro Run Log pop-up keypad

Macro Recording

Macros are recorded into macro registers. The GV Switcher system has 999 macro registers. The number of steps in any specific macro or the total number of macro steps across all macros is limited only by the amount of available memory in the Video Processor Frame.

The number of macros per configuration is determined by the size and number of Stripes in the GV Switcher system. The following is used to determine the total number:

- Stripes (1-4),
- Key row number (1-2),
- Shift level number (1-4), and
- Source button number (1-32).

For example:

4-M/E with 35 button rows:

- 2 key rows
- 4 shift levels
- 32 source buttons for macros

=999 macros (maximum supported) or,

2-M/E with 25 source button rows:

- 2-M/E
- 2 key rows
- 4 shift levels
- 22 source buttons for macros

=352 macros

Macro registers can be saved to disk and reloaded, making the total number of pre-made macros available to a GV Switcher system unlimited.

Macros apply to the point of use active during the macro recording. For example, recording a macro that turns on Matte Fill on M/E 1 Keyer 1 will affect M/E 1 Keyer 1 when it is played

back, regardless of what keyer the Control Panel happens to be delegated to when the macro is played.

Macros record triggers, not the result of a trigger. For example, a macro containing a Key Mix transition, when run, will trigger the key transition from its current state to the other state. If the keyer is on, it will mix off, and if off, it will mix on.

Macro Playback

Macros can be played back from the currently delegated Macro row of source select buttons on the Control Panel and Macros menus. Macros can also be attached to other panel buttons for playback.

Macros are low tally when a macro has been recorded and OFF when no content exists. When a macro is executed, the button turns high tally orange while playing with the macro button then remaining high tally to indicate it was the last macro run.

Macros can also be incorporated into E-MEMs and be executed when that E-MEM runs.

About Playing a Macro from the Control Menu (Important)

It is important to understand that because the menu is part of the control surface, when a macro is played from the Macro Control menu, it is actually played from the control surface you are logged into (CS A or CS B). Selecting a Play button (right arrow) runs the macro from the control surface, not the macro player group in the menu (the right arrow will resume a paused macro from any player group).

For example, if you are logged in as Suite 1 CS A, selecting an E-MEM Player right arrow button for a “stopped” macro does not simulate a macro run from an E-MEM, it runs the macro using the CS A player. This is demonstrated by taking note of the macro number in the E-MEM player, then selecting an E-MEM Play arrow. The selected macro number from the E-MEM player will display in the first CS A player from the left in the Macro Control menu.

Macro Attachments

Attached macros each run one macro at a time, even with multiple attachments (pre-attached, attached, post-attached). Macro attachments are queued and play in order (*this is the only instance when macros are queued*).

Multiple macros can be attached to other Control Panel buttons. Attached macros can either augment the button’s normal function or replace it. A Pre Attach macro executes when the button is pressed, followed by the button’s normal action. A Post Attach macro executes after the button’s normal action. A Replace Attach macro substitutes the macro for the button’s normal action. Any combination of Pre, Post, or Replace Attach macros can be associated with the same button. This makes it possible to have a single button press play three separate macros though this is not a typical scenario.

Macro attachments to buttons without colors do not appear to flash when Pre-/Post-Attached macros are attached. To verify that a macro is or is not attached, see the Macros, Attach menu.

“Disabled” is the Default for the Macro Attachable Control Panel Preference

The ability to attach macros from the Control Panel (in addition to the menu) is provided by the Macro Attachable panel preference. Starting with version 9.1 of the GV switcher software, the default state for Macro Attachable is ‘disabled’ (enabled in earlier versions).

The Macro Attachable panel preference is controlled using the Macro Attachable button in the User Setups, Panel Prefs, Panel User Interactions menu.

Note: Macro Attachable is a Panel Preference and does not affect or limit macro functionality including macro attachment from the GV switcher Macros menu.

Macro Attachments and Importing Show Files

Shows created using versions earlier than 9.1 with Macro Attachable enabled will have the Macro Attachable panel preference disabled (the 9.1 or newer default) when imported. The show can be updated to the previous state by enabling the Macro Attachable button and saving the show.

Kayenne Macro Operations

The Macro Control Button group on the System Bar has six buttons. These controls are located above the PGM PST stripe, at the far right of the System Bar.

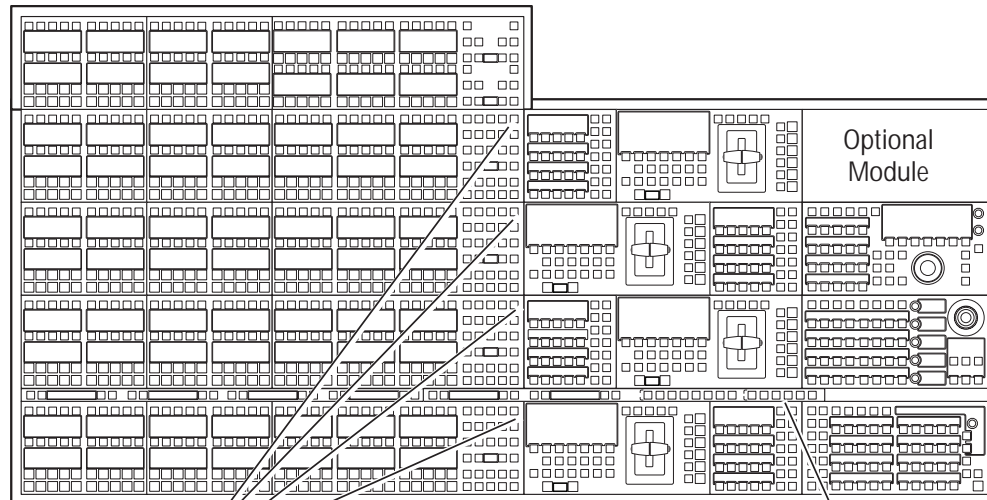

Macro
(One Per Source
Select Module)



Kayenne Control Panel Macro Buttons

8623267_04

Macro Button Function Summary

The Macro button on the Control Panel (one per Source Select Module), delegates keyer source select button Rows 1 and 2 for macro operations and reports that macro mode is active (MCR appears in the bus display). To delegate one bus row for macro operations, press and hold down the Macro button, then press a bus delegation button for the row to be delegated. MCRO appears in the bus display reporting that the row is active for macro operations. Macro names, when displayed, will also appear on the bus row(s).

The Rec button activates or terminates macro Record mode. In this mode, you select the macro register into which you wish to record, using the delegated keyer row, perform the desired actions, and then finish the recording by either pressing the Rec button again or pressing the newly recorded macro register button.

During a macro recording, time delays can be inserted into macros. The Insert Delay button activates macro Insert Delay mode. In this mode the macro delegated M/E's source name displays show time durations which can be selected by pressing the corresponding keyer buttons.

The Delete button activates macro Delete mode. When delete mode is on, pressing a macro button deletes the macro associated with that button.

When macro mode is on, pressing the Repl Attach button activates attach mode. You then select the macro register of the desired pre-defined macro and press the button to which you wish to attach that macro.

The Show Attach button activates a mode that low tally blinks Control Panel buttons that have macros attached.

The Attach Enable button enables and disables all macro button attachments globally. When on, pressing Control Panel buttons with macros attached will run those macros. When off, macros can only be played back by activating macro mode and pressing the macro register buttons, or with the Macro menu.

Record a Macro

- 1 Turn on Macro record mode by pressing the **Rec** button.
- 2 Press the macro row button of the desired macro register. Use the Shift button to access shifted macro registers.
- 3 Perform the steps you wish recorded into the macro, in the order they are to be performed, using the Control Panel and/or the menus.
- 4 Complete the recording by pressing the **Rec** button, or pressing the keyer row **Macro** button.

Insert a Macro Delay

The 2nd Shift button (3rd and 4th are undefined for this function) splits the time interval selection between fields (upper key row) and seconds (lower key row). Multiple selections can be made to insert longer delays in both fields and seconds.

- 1 While recording a macro, press the **Insert Delay** button.
- 2 Press the keyer source select button of the desired delay time.

Insert a Macro User Pause

The Macro User Pause is part of the Insert Delay feature. A press of the USER button in the Source Select Module inserts the User Pause during the macro recording process. When the macro is run, it will pause and must be manually resumed (the macro is considered running when paused, not stopped).

- 1 Press the **Rec** button.
- 2 Press the **Macro** button on the right side of the Source Select module to delegate the module.
- 3 Press a macro delegated button to start recording.
- 4 Perform any actions to be recorded as part of the macro before inserting the User Pause.
- 5 Press **Insert Delay**.

Result: **USER** is displayed in the source select OLED, third button from the right.

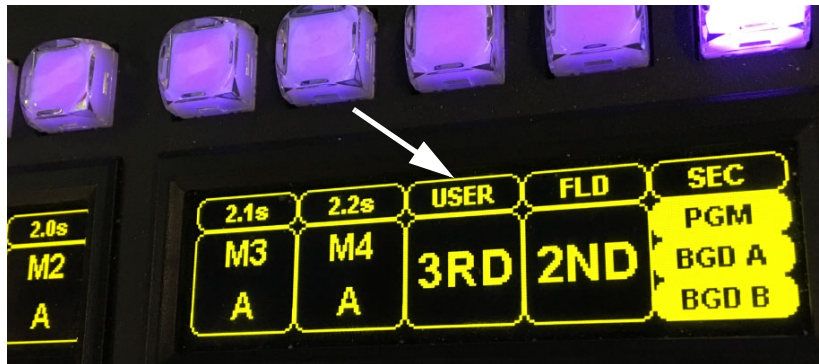

Control Panel Macro USER Button in Macro Delegation

- 6 Press **USER** to insert a User Pause.
- 7 If desired, perform any additional actions to be recorded.
- 8 Press the **Rec** button again to stop the recording.
- 9 Run the macro.

Result: Any Control Panel button associated with the running macro will tally purple indicating the User Pause.

- 10 Press any purple tallied button to resume.

Result: Once completed, the macro button high tallies the macro color.

Resuming a Paused Macro

Buttons delegated to macros or with macros attached in a paused state, tally purple. Press the purple tallied button to resume the macro.

Note: Stopped macros tally the macro color, running macros tally orange. Pressing a button with a running macro delegated or attached, stops the macro (pressing it again starts the macro from the beginning).

Playback a Macro Register

- 1 Turn on Macro mode with the Macro button. If not already on, you may also want to press the **Show Attach** button to display the macro names on the source name displays.
- 2 Select the macro to be played.
 - a On the Control Panel, press the keyer button of the desired macro register. The Shift button accesses shifted macros (2nd, 3rd, and 4th).
 - b In the Macro menu, select the macro register button of the desired macro register, then select the Play button.

Pre-Attach a Macro

A pre-attached macro means the macro will execute before the mapped function of the button. Generally, you can attach macros to any bus row, Key, or Transition buttons, however some Control Panel buttons are not supported to prevent operational conflicts.

- 1 Delegate the bus rows to Macro by pressing the **Macro** button (see [Kayenne Control Panel Macro Buttons](#)).
- 2 Press and hold the Macro bus row button with the recorded Macro.
- 3 Press the Control Panel button to which the macro will be attached (if Show Attach is on, the panel button will flash).

Post-Attach a Macro

A post-attached macro means the macro will execute after the mapped function of the button. Generally, you can attach macros to any bus row, Key, or Transition buttons, however some Control Panel buttons are not supported to prevent operational conflicts.

- 1 Delegate the bus rows to Macro by pressing the Macro button (see [Kayenne Control Panel Macro Buttons](#)).
- 2 Press the Control Panel button to which the macro will be attached.
- 3 Press and hold the Macro bus row button with the recorded Macro (if Show Attach is on, the newly defined macro button will flash).

Note: Macros attach to physical buttons, not to the delegated target of that button. This means, for example, if you attach a macro to the Chroma Key button, pressing that button runs the macro regardless of which keyer the Transition area has been delegated to control.

Attach Multiple Macros to the Same Button

Up to three macros (one of each type, Pre, Post, and Replace) can be attached to the same button.

- 1 Select an attach mode.
- 2 Select the macro register of the additional macro.
- 3 Press the button to which you wish to attach the additional macro.

Delete a Macro Attachment

Delete one or multiple macros from the Control Panel or remove all attachments using the menu.

- 1 Enable Delete Macro:
 - a GV Korona—Tap MAC then tap and hold the **Delete** button in the TFT Status Display.
 - b Kayenne and Karrera—Press and hold the **Delete** button on the System Bar; Macro buttons high tally.
- 2 While holding the **Delete** button, press and hold a Control Panel button with macro attachments —continue to hold **Delete** and press and hold additional Control Panel buttons to delete multiple macro attachments.

Remove all attachments:

- 1 Select **Macros, Attach** in the menu.
- 2 Select **Remove All Attachments** in the Macro Control pane (top, center).

Append to a Macro

- 1 Turn on Macro append mode by holding down the Record button for a full second. The button will turn blue and blink slowly until a macro is selected.
- 2 Press the macro register button on the delegated keyer row of an existing macro to which you wish to append additional steps. The Record button will remain colored blue and blink fast, indicating a Macro is being recorded.
- 3 Perform the additional steps using the Control Panel and/or the menus.
- 4 Complete the append by pressing the blinking Record button, or pressing the blinking keyer row macro register button.

Karrera Macro Operations

Macro Control Button Group

The Macro Control Button group on the System Bar area has eight buttons. These controls are located above the PGM PST stripe, at the far right of the System Bar area. Pressing the Macro Ctrl (Control) button delegates the buttons for macros. The eight buttons from left to right are:

- Att Enable—Attach Enable,
- Show—Show Attached Macros,
- Pre—Pre-Attach Macro,
- Replace—Replace Macro,
- Post—Post-Attach Macro,
- Delete—Delete Macro,
- Ins Delay—Insert Delay in Macro, and
- Record—Record Macro.

Karrera Control Panel Macro Buttons

Macro Button Function Summary

The Macro button on the Control Panel, (one per Source Select area) delegates keyer source select button Rows 1 and 2 for macro operations and reports that macro mode is active (MCR appears in the bus display). To delegate one bus row for macro operations, press and hold down the Macro button, then press a bus delegation button for the row to be delegated. MCRO appears in the bus display reporting that the row is active for macro operations. Macro names, when displayed, will also appear on the bus row(s).

For information about the Pre-Attached (Pre button), Post-Attached (Post button), and Replacing (Replace button) attached macros, see Macro Attachments on page 162.

The Att Enable button enables and disables all macro button attachments globally. When on, pressing Control Panel buttons with macros attached will run those macros. When off, macros can only be played back by activating macro mode and pressing the macro register buttons, or with the Macro menu.

The Show (Attach) button activates a mode that low tally blinks Control Panel buttons that have macros attached.

The Delete button activates macro Delete mode. When delete mode is on, pressing a macro button deletes the macro associated with that button.

When macro mode is on, pressing the Replace button activates attach mode. You then select the macro register of the desired pre-defined macro and press the button to which you wish to attach that macro.

During a macro recording, time delays can be inserted into macros. The Ins Delay button activates macro Insert Delay mode. In this mode the macro delegated M/E's source name displays show time durations which can be selected by pressing the corresponding keyer buttons.

The Record button activates or terminates macro Record mode. In this mode, you select the macro register into which you wish to record, using the delegated keyer row, perform the desired actions, and then finish the recording by either pressing the Record button again or pressing the newly recorded macro register button.

Record a Macro

- 1 Turn on Macro record mode by pressing the Record button.
- 2 Press the macro delegated row button of the desired macro register. Use the Shift button to access shifted macro registers.
- 3 Perform the steps you wish recorded into the macro, in the order they are to be performed, using the Control Panel and/or the menus.
- 4 Complete the recording by pressing the Record button, or pressing the keyer row macro button.

Insert a Macro Delay

While recording a macro, press the Ins Delay button then press the keyer source select button of the desired delay time. The 2nd Shift button (3rd and 4th are undefined for this

function) splits the time interval selection between fields (upper key row) and seconds (lower key row). Multiple selections can be made to insert longer delays in both fields and seconds.

Insert a Macro User Pause

The Macro User Pause is part of the Insert Delay feature. A press of the USER button in the Source Select Module inserts the User Pause during the macro recording process. When the macro is run, it will pause and must be manually resumed (the macro is considered running when paused, not stopped).

- 1 Press the **Macro Ctrl** button in the Delegation button row above of the Source Select module.
- 2 Press the **Rec** button.
- 3 Press the **Macro** button on the right side of the Source Select module to delegate the module.
- 4 Press a macro delegated button to start recording.
- 5 Perform any actions to be recorded as part of the macro before inserting the User Pause.
- 6 Press **Insert Delay**.

Result: **USER** is displayed in the source select OLED, third button from the right.

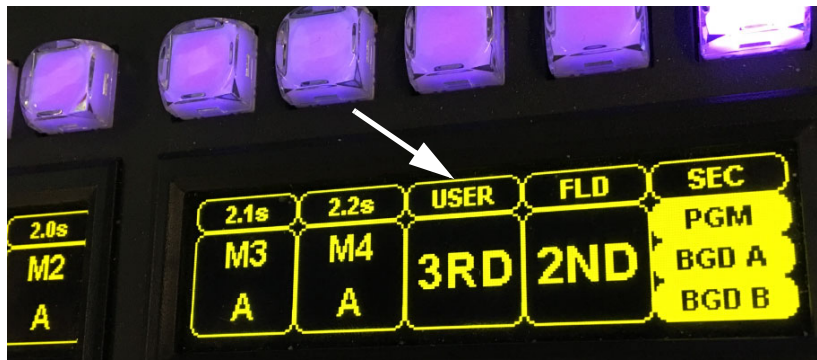

Control Panel Macro USER Button in Macro Delegation

- 7 Press **USER**, and if desired, perform any additional actions to be recorded.
- 8 Press the **Rec** button again to stop the recording.
- 9 Run the macro.
Result: Any Control Panel button associated with the running macro will tally purple indicating the User Pause.
- 10 Press any purple tallied button associated with the macro to resume.
Result: Once completed, the macro button high tallies the macro color (yellow is the default).

Resuming a Paused Macro

Buttons delegated to macros or with macros attached in a paused state, tally purple. Press the purple tallied button to resume the macro.

Note: Stopped macros tally the macro color, running macros tally orange. Pressing a button with a running macro delegated or attached, stops the macro (pressing it again starts the macro from the beginning).

Recall a Macro Register from the Master E-MEM

In the Master E-MEM area, press Menu, Macro (Lrn/CWB) select a register page button

- 1 Turn on Macro mode with the Macro button (if not already on, you may also want to press the Show (Attach) button to display the macro names on the source name displays).
- 2 Select the macro to be played
 - On the Control Panel, press the keyer button of the desired macro register. The **Shift** button accesses shifted macros (2nd, 3rd, and 4th).
 - From the Macro menu, select the Macro register button of the desired macro register, then select the **Play** button.

Pre-Attach a Macro

- 1 Delegate the bus rows to Macro by pressing the **Macro** button on the Control Panel.
- 2 Press and hold down a macro button for attachment in the Macro row.
- 3 Press a Control Panel button to which the macro will be attached (if **Show** (Attach) is on, the panel button will flash).

Post-Attach a Macro

- 1 Delegate the bus rows to Macro by pressing the Macro button on the Control Panel.
- 2 Press and hold down a Control Panel button for the attachment.
- 3 Press the macro button to be attached in the Macro row (if Show (Attach) is on, the newly defined macro button will flash until Show is turned off).

Note: Macros attach to physical buttons, not to the delegated target of that button. This means, for example, if you attach a macro to the Chroma Key button, pressing that button runs the macro regardless of which keyer the Transition area has been delegated to control.

Attach Multiple Macros to the Same Button

Up to three macros (one of each type) can be attached to the same button.

- 1 Select an attach mode.
- 2 Select the macro register of the additional macro.
- 3 Press the button to which you wish to attach the additional macro.

Remove a Macro Attachment

- 1 Press the Delete button on the System Bar.

- 2 Press the Show button so that panel buttons with macros attached blink low tally.
- 3 Without selecting a macro register, press the blinking button that has the attachment you wish to remove. The blinking button will turn off.
- 4 Press Show to turn off the mode.

To remove all macros, go to the Macros Attach menu and select Remove All Macros button (warning will appear to confirm remove all).

Append to a Macro

- 1 Turn on Macro append mode by holding down the Record button for a full second. The button will turn blue and blink slowly until a macro is selected.
- 2 Press the macro register button on the delegated keyer row of an existing macro to which you wish to append additional steps. The Record button will remain colored blue and blink fast, indicating a Macro is being recorded.
- 3 Perform the additional steps using the Control Panel and/or the menus.
- 4 Complete the append by pressing the blinking Record button, or pressing the blinking keyer row macro register button.

GV Korona Macro Operations

You can record, enable, append, and show the macro attachments on the Control Panel using the GV Korona Status Display. Use the GV switcher menu for the other macros functions, including pre-attach, post-attach, delete, etc.

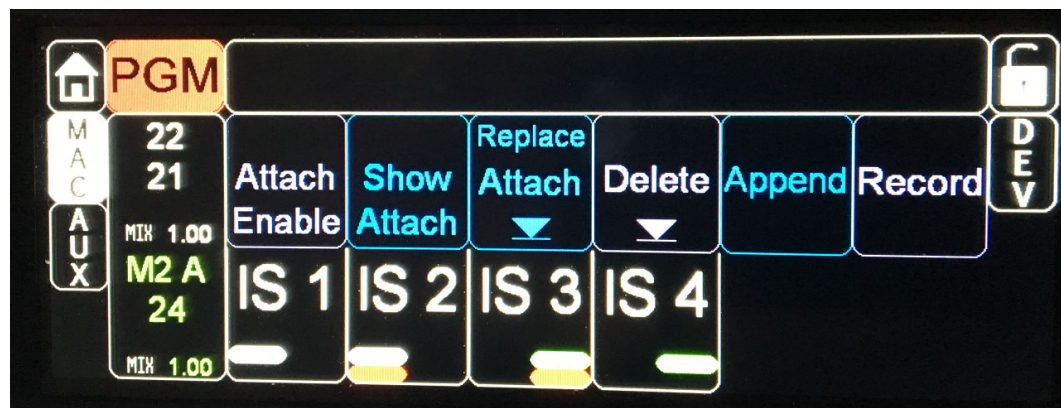

GV Korona Status Display in Macro Mode

Status Display in Macro Mode

The **Att Enable** button enables and disables all macro button attachments globally. When on, pressing Control Panel buttons with macros attached will run those macros. When off, macros can only be played back by activating macro mode and pressing the macro register buttons, or with the Macro menu.

The **Show Attach** button activates a mode that low tally blinks Control Panel buttons that have macros attached.

The **Record** button activates or terminates macro Record mode (**Stop Record**). In this mode, you select the macro register into which you wish to record, using the delegated keyer row, perform the desired actions, and then finish the recording by either pressing the **Stop Record** or pressing the newly recorded macro register button.

The **Append Macro** button allows you to append actions to an existing macro.

Record a Macro

Master E-MEM

- 1 In the Master E-MEM area located top right of the Control Panel, press the Page button to see the Macro option. Press the button under the Macro label to display the Macro registers and controls.
- 2 Touch the **MAC** button in the Status Display.
- 3 Touch the Record button.
- 4 Press a Macro register button in the Master E-MEM; the button flashes indicating the macro is recording.
- 5 Perform the steps you wish to record using the Control Panel and/or the menus.
- 6 Complete the recording by either selecting **Stop Record** in the Status Display or by pressing the Macro register button again.

Macro Delegated Row Buttons

- 1 Press the **Macro** button in the Delegation area located above the Source Select area of a Stripe; the button row above the OLEDs is now delegated to Macro.
- 2 Press the **Macro** button with which you want to associate the recorded macro.
- 3 Touch **Record** in the Status Display.
- 4 Perform the steps you wish to record using the Control Panel and/or the menus.
- 5 Complete the recording by either selecting **Stop Record** in the Status Display or by pressing the Macro button again.

Insert a Macro Delay

While recording a macro, press the Ins Delay button then press the keyer source select button of the desired delay time. The 2nd Shift button (3rd and 4th are undefined for this function) splits the time interval selection between fields (upper key row) and seconds (lower key row). Multiple selections can be made to insert longer delays in both fields and seconds.

Insert a Macro User Pause

- 1 Touch the **MAC** button in the Transition area status display.
- 2 Touch **Record**.
- 3 Press the **Macro** button in the Delegation row (above the OLEDs and top button row) of the Source Select area to delegate the button row.
- 4 Press a macro delegated button to start recording.

- 5 Perform any actions to be recorded as part of the macro before inserting the User Pause.
- 6 Touch **Insert Delay** in the status display.
Result: **USER** is displayed in the source select button OLED, third button from the right.

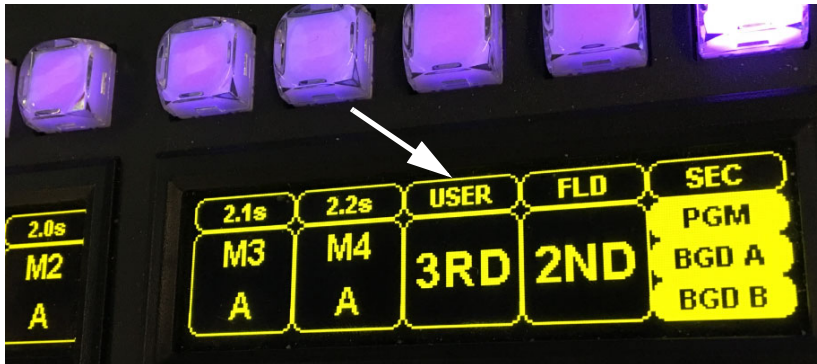

Control Panel Macro USER Button in Macro Delegation

- 7 Press the **USER** button, and if desired, perform any additional actions to be recorded.
- 8 Touch **Record Stop**.
- 9 Run the macro.
Result: Any Control Panel button associated with the running macro will tally purple indicating the User Pause.
- 10 Press the purple tallied button associated with the macro to resume.
Result: Once completed, the macro button high tallies the macro color (yellow is the default).

Resuming a Paused Macro

Buttons delegated to macros or with macros attached in a paused state, tally purple. Press the purple tallied button to resume the macro.

Note: Stopped macros tally the macro color, running macros tally orange. Pressing a button with a running macro delegated or attached, stops the macro (pressing it again starts the macro from the beginning).

Run a Macro

Note: Press the **Show Attach** button in the Status display to high tally buttons with macros attached on the Control Panel, including the Master E-MEM.

Run a Macro from a Delegated Row button:

- 1 Press the **Macro** button in the Delegation row above the Source Select Module.
- 2 Press a Macro button with an associated macro.

Run a Macro from the Master E-MEM Area:

- 1 Press **Menu, Macro (Lrn/CWB)**.
- 2 Use the Page and Bank buttons to navigate to the macro register.
- 3 Press the macro register button.

Run a Macro from the Menu:

- Select **Macros, Macro Ops** and select a Page, Bank, and Register.
- Select **Execute**.

Pre-Attach a Macro

- 1 Delegate the bus row to Macro by pressing the **Macro** button on the Control Panel.
- 2 Press and hold down a macro button for attachment in the Macro delegated row.
- 3 Press a Control Panel button to which the macro will be attached (if Show Attach is on, the panel button will flash).

Post-Attach a Macro

- 1 Delegate the bus row to Macro by pressing the **Macro** button on the Control Panel.
- 2 Press and hold down a Control Panel button for the attachment.
- 3 Press the macro button to be attached in the Macro delegated row (if Show Attach is on, the newly defined macro button will flash until Show Attach is turned off).

Note: Macros attach to physical buttons, not to the delegated target of that button. This means, for example, if you attach a macro to the Chroma Key button, pressing that button runs the macro regardless of which keyer the Transition area has been delegated to control.

Attach Multiple Macros to the Same Button

Up to three macros (one of each type: attached, pre-attached, and post-attached) can be attached to the same button.

- 1 Select an attach mode.
- 2 Select the macro register of the additional macro.
- 3 Press the button to which you wish to attach the additional macro.

Remove a Macro Attachment

- 1 Press the Delete button with the Status Display in Macro (MAC) mode.
- 2 Press the Show button so that panel buttons with macros attached flash.
- 3 Press the blinking button with the attachment. The blinking button will turn off indicating the attachment has been deleted.

To remove all macros, go to the Macros Attach menu and select the **Remove All Macros** button (warning will appear to confirm remove all).

Append to a Macro

- 1 Touch the MAC button in the Status Display and select the **Append** button.
- 2 Select a macro:
 - a Press a Macro delegated row button, or,
 - b Press **Page, Macro**, navigate to a macro register in the Master E-MEM area with an existing macro, and press the register button.
- 3 Perform the additional steps using the Control Panel and/or the menus.
- 4 Complete the recording by turning off the Append button or by pressing the macro button being recorded.

Performing Macro Operations from the Menu

Recording a Macro

- 1 Select **Macro, Catalog** in the menu.

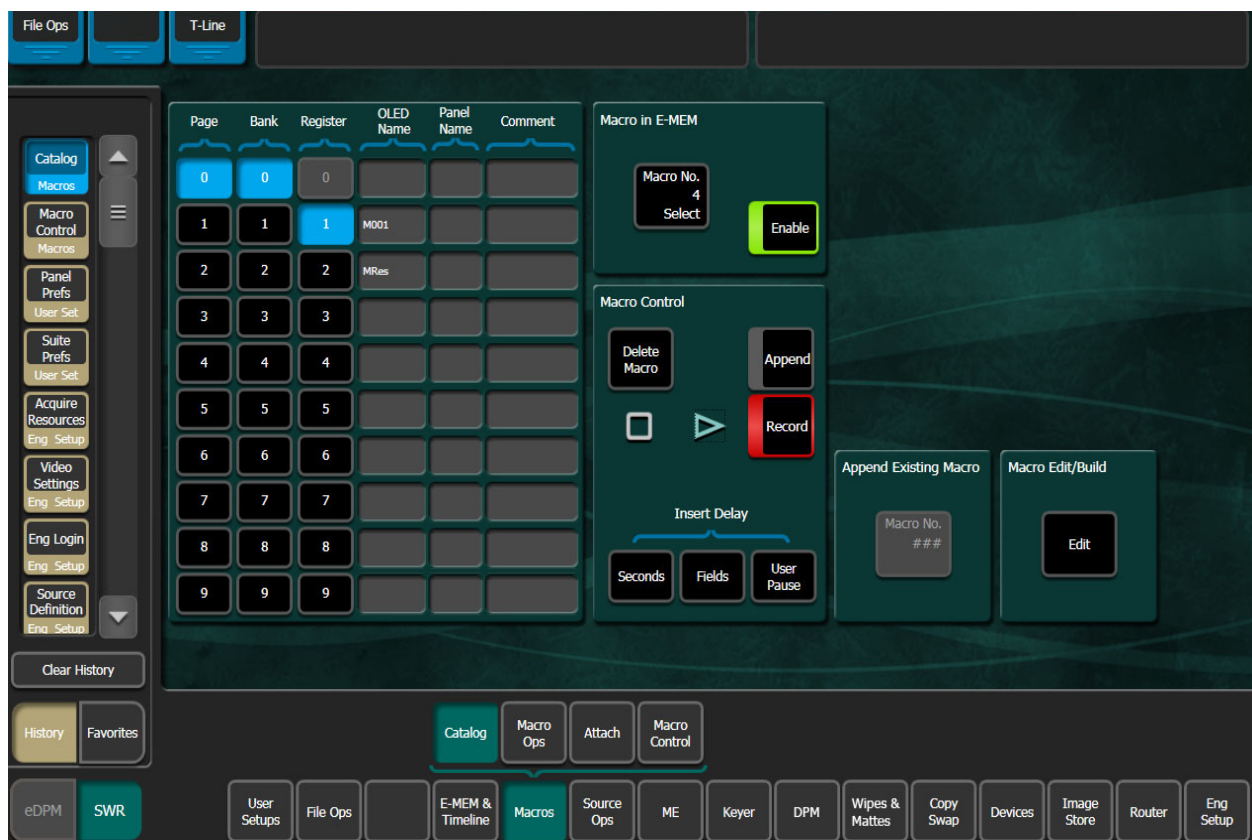

- 2 Select the Macro Register number button of the register you wish to record into, in the scrolling list.
- 3 Select the **Record** button.

- 4 Perform the steps you wish recorded into the macro, in the order they are to be performed, using the Control Panel and/or the menus.
- 5 Select the **Stop** button to end the macro recording.

You can name the macro either before you record it, or after by selecting the name data pad for that macro register to bring up a keypad.

Enter a Macro Panel Name

The "Panel Name" column is provided in the Macro Catalog menu's, Macro List pane; four characters maximum. GV Switcher displays that name in place of the Macro Register Number in the Local E-MEM area (when the Macro menu is delegated by pressing the Macro button in that M/E).

- 1 Select Macros, Catalog in the menu.
- 2 Select the Panel Name data pad next to the desired macro register.
- 3 Enter a four-character name in the pop-up keyboard, and select Enter.

Note: If there is no Panel Name entered, the Macro menu in the Local E-MEM Module will display the macro register number; it does not display the OLED name.

Insert a Macro Delay

- 1 Inserting a macro delay is done in the Macro Editor.
- 2 Select **Macros, Catalog**.
- 3 Select **Edit** in the Macro Edit/Build pane.
- 4 From the right-hand button pane, select **Insert Delay**.
- 5 Select the **Fields/Frames/Seconds** then the **Enter Delay** field to change the value from the default in the pop-up keypad.
- 6 Select **OK**.

Insert a Macro User Pause from the Catalog Menu

- 1 Select the **Macros, Catalog** menu.

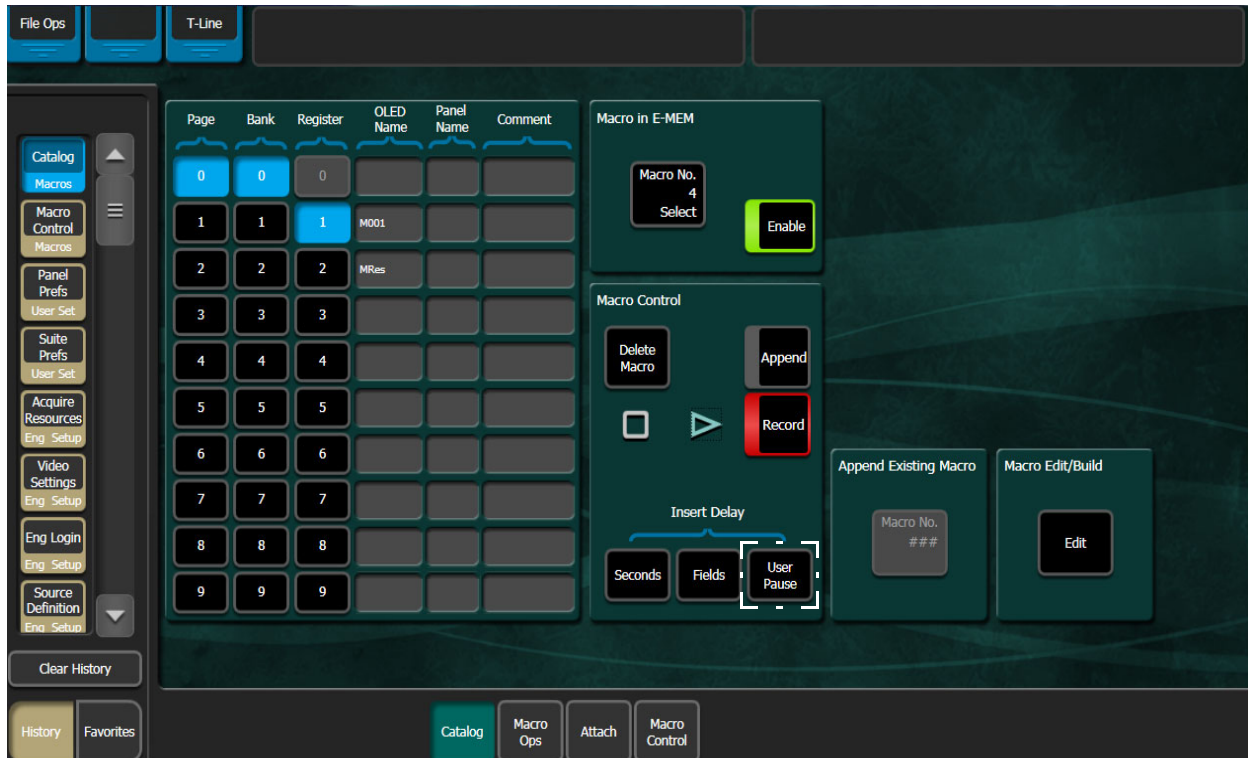

- 2 Enable the **Record** button and press the **Right Arrow** button to begin recording.
- 3 Select the **User Pause** button in the Insert Delay button group.

Switcher Control

Insert a Macro User Pause from the Macro Editor

Insert a Macro User Pause from the Macro Editor

A macro User Pause can be inserted and edited with Macro Editor. See the *Kayenne/Karrera/GV Korona User Manual* for Macro Editor operations.

- 1 Select **Macros, Catalog**.
- 2 In the Macro Edit/Build pane, select **Edit**.
- 3 Select **Insert Delay**.
- 4 In the Enter Delay pop-up menu, select **User Pause, OK**.

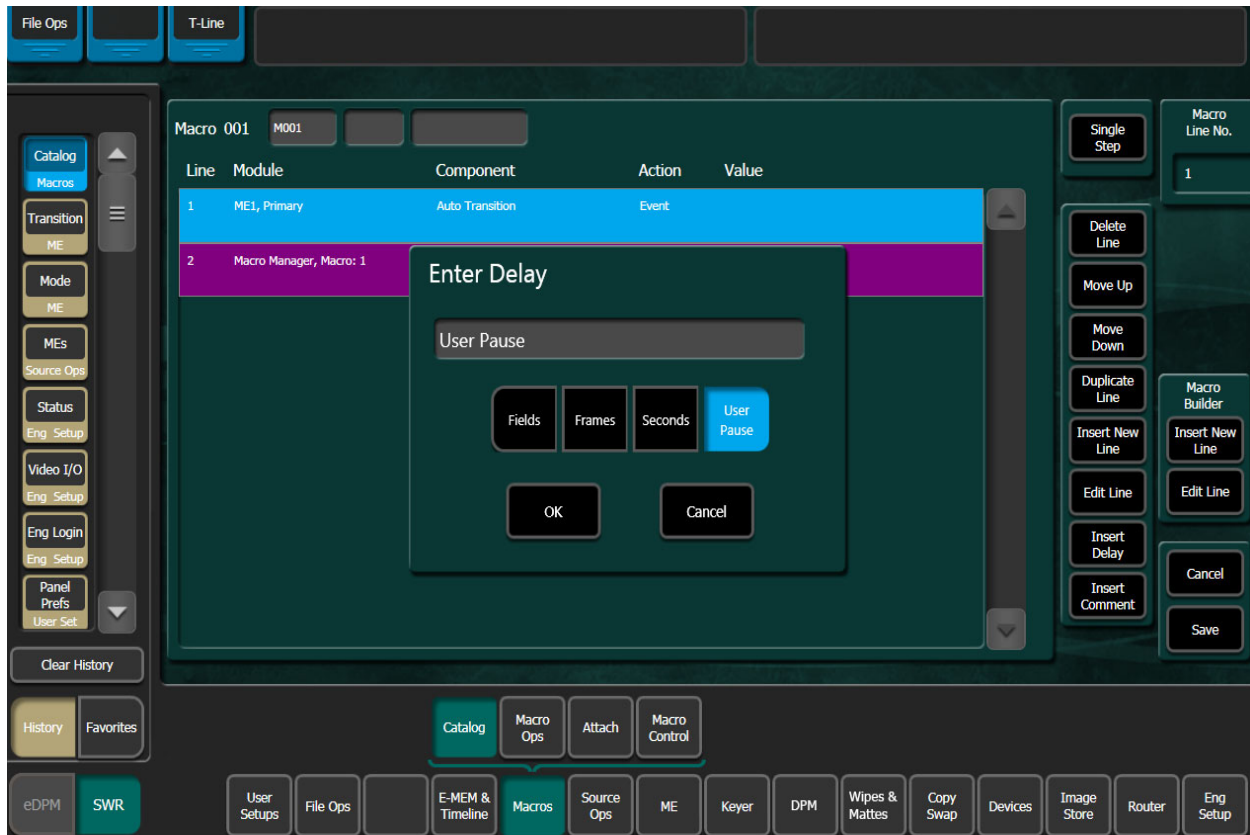

Learn a Run From Pause E-MEM Command

The *Run From Pause* command resumes a paused macro from E-MEM.

Note: Without a Run From Pause command learned, running an E-MEM with a paused macro associated will start the macro from the beginning.

- 1 Select **Macro, Catalog, Macro No.** in the Macro in E-MEM button pane.
- 2 Select the macro then **Run From Pause**.



Learn a Select E-MEM Command

The *Select* command stops a running macro and starts it at the beginning using E-MEM.

- 1 Select **Macro, Catalog, Macro No.** in the Macro in E-MEM button pane.
- 2 Select the macro then **Select**.



Attaching a Macro

1 Select **Macros, Attach**.

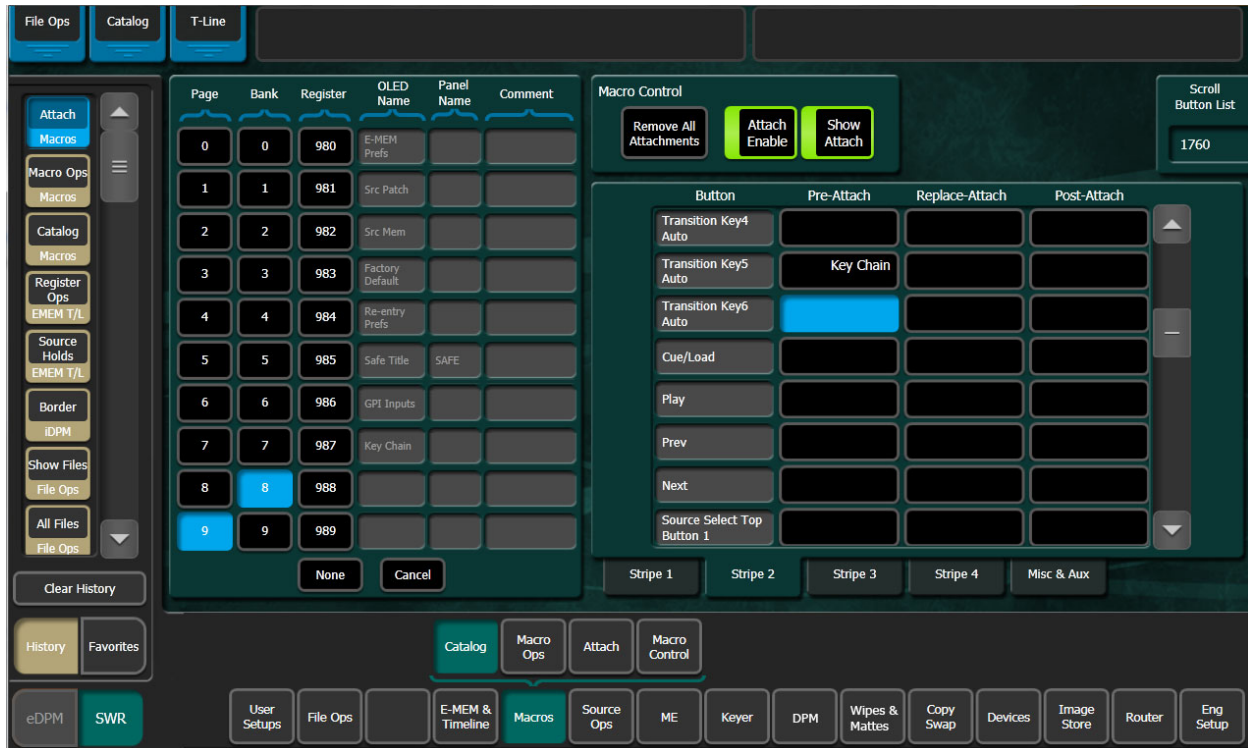

- 2 Select the button you wish to attach a macro to. You can either select the physical panel button while **Show Attach** mode is active, which will scroll to and blink that button on the Macros Attach menu, or you can use the menu to select the panel section and then scroll the Macro Attachments list to display the desired button.
- 3 Select the **Pre**, **Replace**, or **Post** parameter select button (upper right).
- 4 Select the menu button for the macro register to be attached.
- 5 If desired, name the macro by selecting the Name data pad and entering the name in the pop-up keyboard. Press **Enter**.

Playing an Attached Macro

- 1 Turn on the attachment playback feature by pressing the **Attach Enable** button so it is illuminated. You may also want to press the **Show Attach** button so that panel buttons with macros attached can be identified (they blink low tally).
- 2 Press the panel button that has the macro attached.

Appending to a Macro

- 1 Select **Macro, Catalog** in the menu.
- 2 Select the Macro Register number button of the register you wish to record additional steps into.

- 3 Select the **Append** button.
- 4 Perform the additional steps, using the Control Panel and/or the menus.
- 5 Select the Stop button to end the macro append.

Appending a Macro to Another Macro in the Menu

- 1 Go to the Macro Catalog menu (press **Macro, Catalog**).
- 2 Select the Macro Register number button of the register to which you wish to add the contents of another macro.
- 3 Select the **Macro #** data pad in the Append Existing Macro pane.
- 4 Select the macro you wish to append to the target macro in the pop-up, and select the **Do Append** button (or select the **Cancel** button if you wish to cancel the operation).

Note: The contents of the indicated macro will be appended to the originally selected macro. Only the current contents of the macro is appended to another macro. Deleting or changing the source macro will not change the behavior of the macro that has received its contents through an append.

Saving Macro Registers

- 1 Select **File Ops, Macro** in the menu.
- 2 Press the **Save** button in the File Operations pane.
- 3 Navigate to the folder (System Storage or Remote Storage tab) into which you wish to save the Macro files (left pane). You can create a new folder if you wish.
- 4 Select **All, Enter Reg(s)**, or the **Select Reg(s)** buttons (enter or select a range for the latter two).
- 5 Select the **Save** button.

Note: Only the macro registers themselves are saved with this procedure, not any macro attachments.

Loading Macro Registers

Macro registers are loaded by selecting the macro register file or a folder of macros and selecting the Load button in the File Ops, Macros menu.

Note: Only the macro registers themselves are saved with this procedure, not any macro attachments.

Macros for Multiple Copies or Swaps

When copying or swapping several settings in turn (copying an M/E to several other M/Es, for example) time may be required for one command to complete before the next command can be serviced. If you create a macro that performs multiple copy or swap operations, add a short delay after each operation to ensure each completes successfully.

For example, to copy M/E 1 to M/E 2 and then copy M/E 1 to M/E 3 with a macro, include a short delay after the M/E 1 to M/E 2 copy.

Macros and E-MEMs

Macros and E-MEMs can interact in two fundamentally different ways. A Macro can be created that recalls one or more E-MEMs, or an E-MEM can be programmed to execute one or more Macros. With care, operating both control mechanisms together can be extremely powerful. However, improper use can create infinite loops or other undesirable behavior. It is especially important that your GV Switcher system be loaded with the correct E-MEMs and Macros and is operating in the correct mode, or unpredictable system behavior will result from the mismatched E-MEMs and macros.

E-MEM Recalls in a Macro

The state of the Effects Dis and SEQ buttons are sent as part of each E-MEM recall command. When recording E-MEM recalls to a Macro, make sure these states are correct when you build the Macro. For example, if you want the E-MEM effect to automatically run as a Sequence, make sure that button is on when the E-MEM recall is recorded into the Macro.

Certain E-MEM commands that directly affect the work buffer require special field-rate processing. This ensures all necessary processing occurs once per field and is in sync with all the other changes occurring in that same field. Delays are needed for multiple time cursor changes (Next KF, Prev KF, Begin, End, Go To KF, Go To Time, and Rewind). If you wish to use two or more of these commands adjacent to each other in a macro, a delay of at least one frame between them is required for consistent system behavior.

Learn a Run From Pause E-MEM Command

The *Run From Pause* command resumes a paused macro from E-MEM.

Note: Without a Run From Pause command learned, running an E-MEM with a paused macro associated will start the macro from the beginning.

- 1 Select **Macro, Catalog, Macro No.** in the Macro in E-MEM button pane.
- 2 Select the macro then **Run From Pause**.



Learn a Select E-MEM Command

The *Select* command stops a running macro and starts it at the beginning using E-MEM.

- 1 Select **Macro, Catalog, Macro No.** in the Macro in E-MEM button pane.
- 2 Select the macro then **Select**.



Source Select Button Row Mode Delegation

Keyer, Background, E-MEM and Macro registers, and Utility buses can be delegated for control to a Source Select button row. On the Kayenne Control Panel, Aux bus and Router modes can also be delegated.

Source Select Button Row Mode Descriptions

Mode	Source Select Button Row Description
E-MEM	E-MEM registers are mapped
Macro	Macro registers are mapped
Keyer 1-6	Mapped sources used as keyer video/key
Backgrounds A,B,C,D	Mapped sources used as background video
Utility Buses U1, U2	Mapped keyer sources for wipe generators/custom border wash patterns

Additional Kayenne Control Panel Modes

Source Select Button Row Mode Descriptions

Mode	Source Select Button Row Description
Aux	Mapped aux bus inputs
Router	Router sources mapped alphabetically from router (use PREV/NEXT to change input source button delegation)

Delegate a Switcher Mode to a Source Select Button Row

Once a mode is delegated to a Source Select button row, it is fixed until changed. Button row delegations can be saved in Panel Memory (see [Panel Memory and P-MEM Registers](#), on page 143).

- 1 Hold down the **Fixed Delegation** source select button, top right (default), in the Source Select area on an M/E.

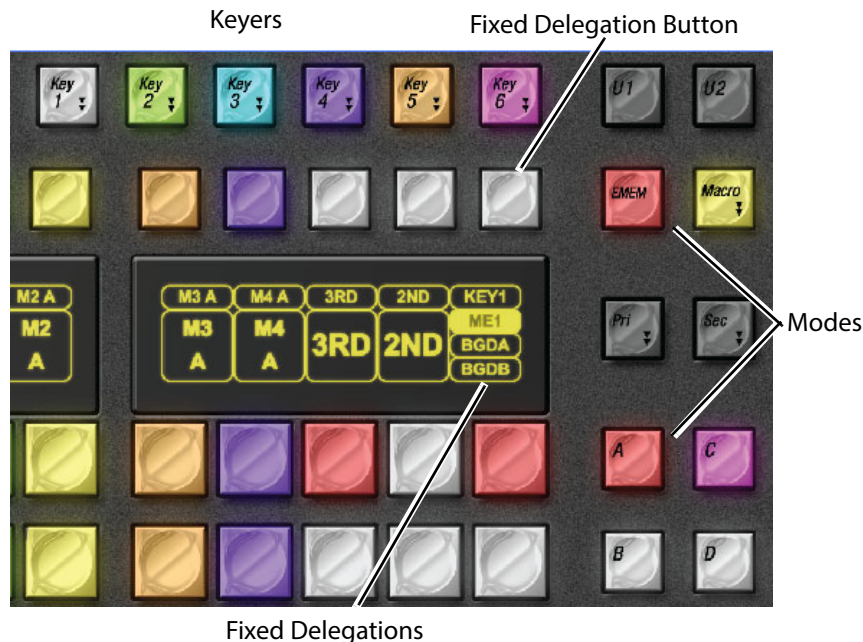

Source Select Area Example

- 2 Press a keyer or mode button.

Source Select Button Row to Aux Mode Delegation

Source Select button rows can be delegated to Aux outputs on the GV switcher Control Panels that can for example be assigned to monitors, ImageStore, ClipStore, etc.

Delegate a Kayenne Source Select Button Row to Aux Mode

- 1 Press and hold the Aux mode button and press a fixed Delegation button.
- 2 Select an Aux output.
- 3 Select an Aux source.

Delegate a Karrera Source Select Button Row to Aux Mode

- 1 Press the Aux button (high tallies blue).
- 2 Press an Aux output button; A/1 to A/19?.
- 3 Press a Source Select button with the desired source mapped.

Delegate a GV Korona Source Select Button Row to Aux Mode

- 1 Press and hold the Aux button (high tallies blue).
- 2 Press an Aux output button; A/1 to A/19?.
- 3 Press a Source Select button with the desired source mapped.

Panel Memory and P-MEM Registers

P-MEMs (Panel Memory Registers) store operational states or levels (also sub-levels for Kayenne) for Control Surface Stripes. You could for example, quickly change Source Select button row delegation ([Source Select Button Row Mode Delegation](#), on page 141) from Aux outputs to Macro registers with a P-MEM recall.

There are 99 P-MEM registers available, numbered from 1 to 99.

Note: P-MEM register 0 (zero) is not writable.

- P-MEMs learn Source Select button row mode delegations for:
- E-MEM registers,
- Macro registers,
- Shift levels, and

Additionally for Kayenne,

- Aux outputs and
- Router sources.

Note: Individual button selections are not saved in P-MEM registers, the first Source Select button in the row will be switched on when recalled.

Other states are learned including:

- Macro offsets and
- Stripe to M/E delegation.

Learn a Kayenne P-MEM Register

See [Switching Basics](#), on page 157 for more information about Local E-MEM register operations.

- 1 In the Local E-MEM Module of the Control Panel, press the **Panel Mem** button.
- 2 To enable/disable a stripe, press to toggle the Stripe buttons (STR 1-4 and Aux) positioned vertically on the right side of the Local E-MEM keypad.
- 3 Press **LRN**.

- 4 Press **0-9** in the keypad (or the dot button (.) to learn into the next available register) in the current bank or **BNK 0-9**, then **0-9**.

Example: Pressing **BNK,2,2** learns into P-MEM register 22.

Recall a Kayenne P-MEM Register

- 1 In the Local E-MEM Module of the Control Panel, press the Panel Mem button.
- 2 Press **0-9** in the keypad for the current bank or **BNK, 0-9, 0-9** for a different bank.

Learn a Karrera/GV Korona P-MEM Register

See [Switcher Control](#), on page 109 for more information about Local E-MEM register operations.

- 1 In the Local E-MEM area of the Control Panel, press **Menu, Panel Mem, Lrn**.
- 2 Stripe delegation to include or exclude Stripes as part of the P-MEM can be performed or skipped at this point. Keypad buttons 1 through 5 (5 for Aux) are toggle buttons; high tally is on. Enable or disable Stripes and/or press **Enter** to continue.
- 3 Press **0-9** in the keypad (or the dot button (.) to select the next available register) in the current bank, or, **Bank 0/4, 1/5, 2/6, 3/7** or **Bank** then **8** or **9**, then **0-9**.

Examples:

- Double-pressing **Bank 0/4** then pressing **2** learns into P-MEM register 42.
- Pressing **Bank,8,4**, learns into register 84.

Recall a Karrera/GV Korona P-MEM Register

- 1 In the Local E-MEM Module of the Control Panel, press **Menu, Panel Mem**.
- 2 Press **0-9** in the keypad (or the dot button (.) to select the next available register) in the current bank, or, **Bank 0/4, 1/5, 2/6, 3/7** or **Bank** then **8** or **9**, then **0-9**.

Panel Memory Default Setting

Recalling P-MEM register 0 (zero) on the Local E-MEM keypad returns selected stripes to their default configuration.

- Kayenne—Keyer 1, Keyer 2, Background A, Background B
- Karrera/GV Korona—Keyer 1, Background A, Background B

GV Korona M/E Background Button Row Delegation

There are four background buses available on GV Korona system M/Es, buses A, B, C, and D. You can switch between buses A and C for the Primary Source Select button row or between B and D for the Secondary Source Select button row.

To switch between buses:

- 1 For the Primary bus row, press and hold the Primary Delegation button and press the Pri or Sec button; Pri for bus A or Sec for bus C.
- 2 For the Secondary bus row, press and hold the Secondary Delegation button and press Pri for bus B or Sec for bus D.

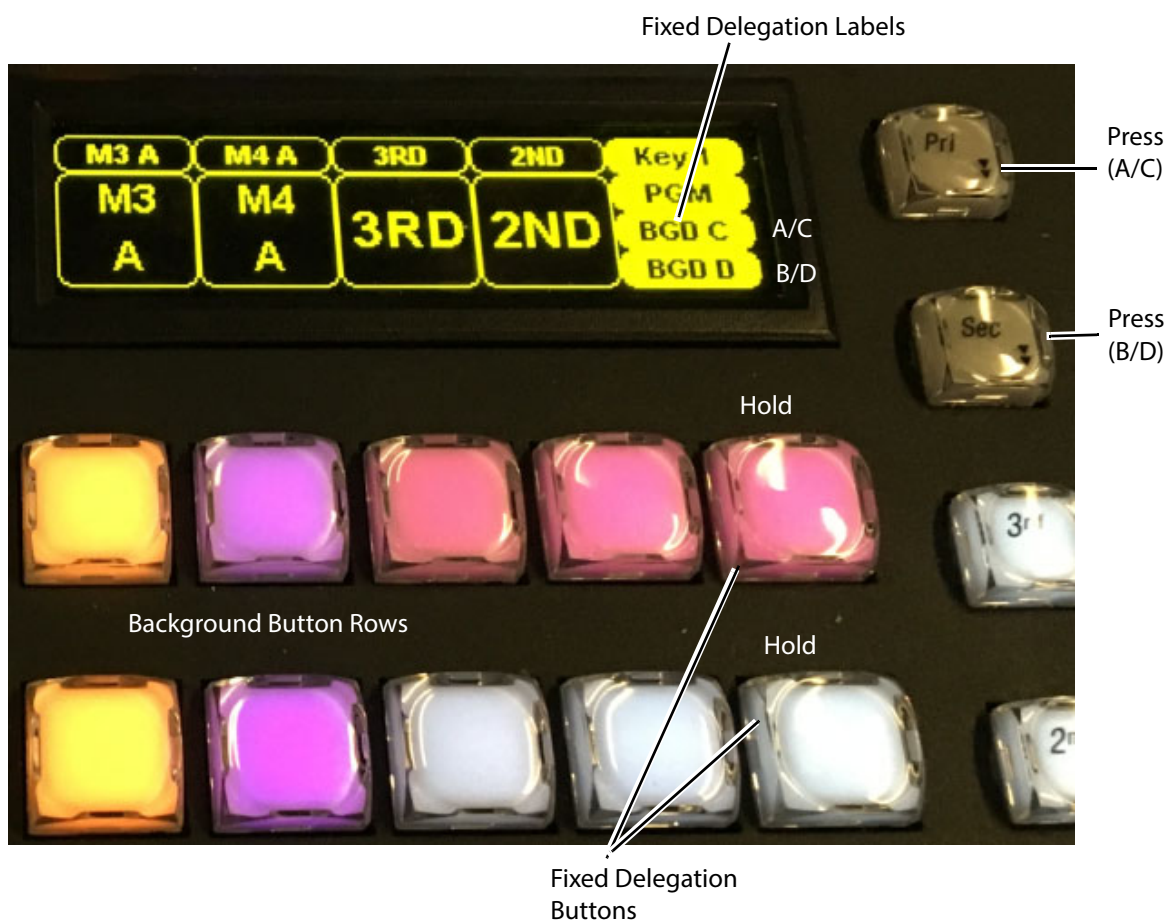

GV Korona Background Bus Button Row Delegation

If the Delegate buttons are not assigned, do one of the following:

- 1 Reset the default from the Control Panel.
 - a Press and hold the Pri button then press the Primary Delegation button, and/or
 - b Press and hold the Sec button then press the Secondary Delegate button.
 - c Recall Panel Mem 0 to reset the Control Panel to the default, including the Delegation buttons.

- 2 Assign the Delegate button from the menu.
 - a Select Panel Prefs, Button Mapping in the menu.
 - b Select a button to assign the Delegate.
 - c Select the Delegate button.

Change Background Buses with Panel Memos

Delegate buttons do not have to be assigned to the Source Select Module in order to change the Background bus row delegations (A/C, B/D). Once delegated, Panel Memos will include the Primary and Secondary Background bus row settings and can be recalled to change the Background bus delegations. The Background row Delegation buttons can then be used for sources or other assignments, see [Map Control Panel Source Select Buttons](#), on page 21.

Source Rules

Source Rules allow the user to associate Keyer states with sources. As a user cuts on the A Bus of an M/E, Keyers will be switched on/off or the state is maintained, depending on the source selected. In addition, sources selected on the B Bus (Preset) will affect the settings of the Next Transition buttons on the Transition Module which will be set up so that the desired Keyer status will result after the transition is performed. No user intervention is required, because Source Rules will have been applied logically. However, Source Rules are applied as sources are selected on the A or B Bus so it is possible to override or change the Next Transition settings in the Transition Module prior to the Next Transition.

For example, Source Rules may be set for studio cameras to ensure the station logo (bug) is always visible when On-Air, and a different logo is used with a helicopter camera when the "Heli-Cam" is cut to air. Should the director call to keep the studio camera logo over the helicopter, the operator can preset the Heli-Cam and then adjust the Next Transition buttons on the required effect.

Source Rules force keyers to be in one of three states: On, off, or As Is (the default), on a source by source basis. A pattern of Source Rules for selected sources can be setup, applied, named, and stored for later use.

Source Rules are saved as part of a Show file (unless deselected).

The Source ID, Source Name, and Keyer Source Rules status are displayed in the Source buttons. Source buttons are in the source button scrolling list. Keyer source rules status is as follows:

- A=As Is
- 1=On

- 0=off

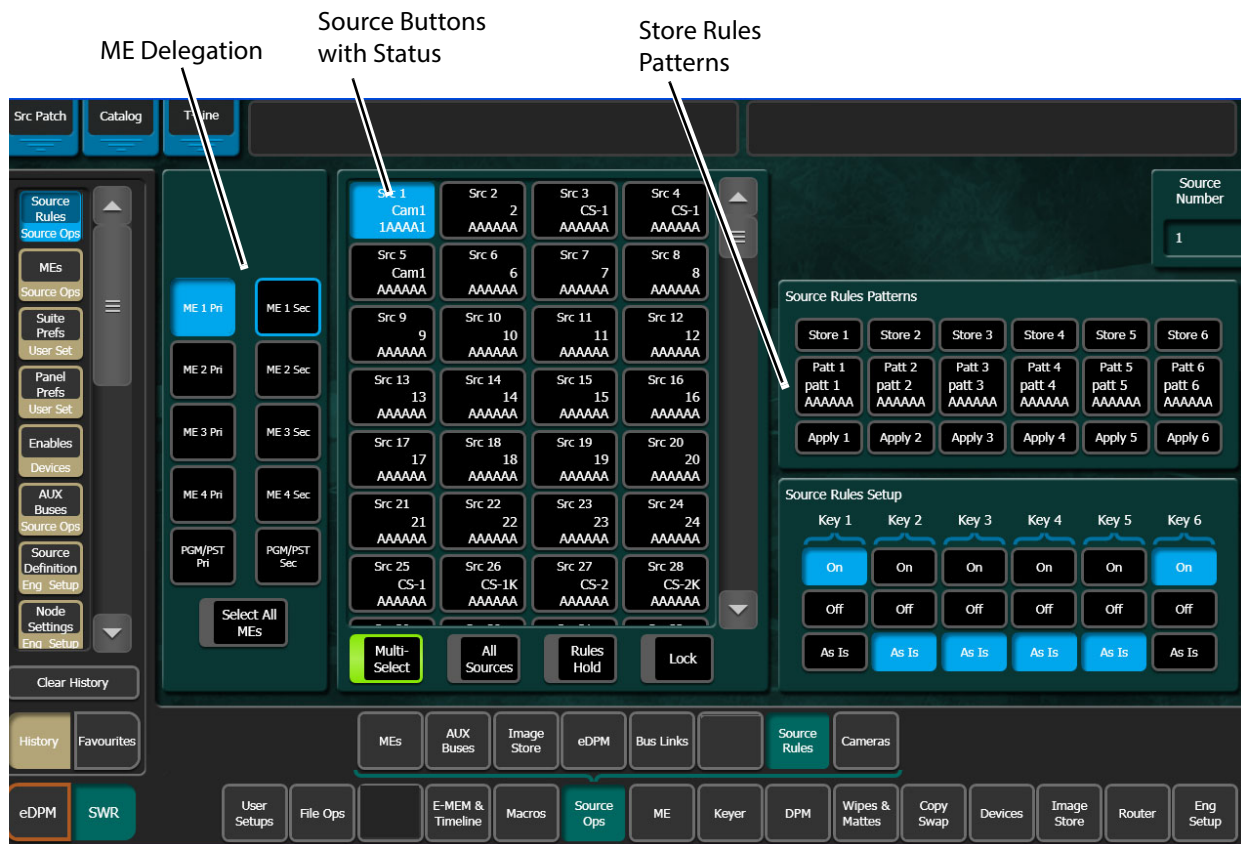

Create a Source Rules Pattern

- 1 Select the ME delegation buttons you wish to apply source rules to in the left-most menu pane.

Note: Multiple M/E selection is supported and a Select All M/Es button is provided at the bottom of the M/E selection menu pane.

- 2 Select the source buttons in the scrolling source list menu pane (multiple selection is supported), right of the ME delegation buttons, you wish to setup as a Source Rules Pattern.
- 3 Select the **On**, **Off**, or **As Is** Source Rules state buttons in the Source Rules Setup menu pane for each Keyer you wish to set the state.

Store a Source Rules Pattern

- 1 Select one of the Store **1-6** buttons to store the Source Rules Pattern.
- 2 To name the stored pattern, select the center **Patt 1-6** button to which you want to store the pattern in the Source Rules Patterns menu pane, and a keyboard will be displayed. Type the name and press **Enter**.

Apply a Source Rules Pattern to other Sources

Using the Apply buttons, Source Rules Patterns can be applied to any other source or set of sources.

- 1 Select the source buttons to which you want to apply the Source Rules Pattern.
- 2 Select one of the **Apply 1-6** buttons previously stored in the Source Rules Pattern menu pane.

Source Rules Hold

Rules Holds apply to each partition of a delegated M/E. Rules Holds can be applied by either selecting the Rules Hold button in the Source Ops, Source Rules menu or by pressing the Rules Hold button on the Source Select Module for the M/E or M/Es delegated to that Source Rule.

CAUTION: : Applying Rules Holds from the Source Select Module require you to press the Rules Hold buttons for each M/E (including both partitions for a Split M/E) delegated to that Source Rule.

Bus Linking

You can create single and multiple bus links, referred to as *Parallel* and *Cascading* links. Also, you can define and associate one of the 15 definable Source Substitution Tables to a bus (each bus link can be associated with any source table), and save bus links as part of an E-MEM. Bus links are E-MEMable and their enables are Keyframeable.

Bus Link is an E-MEM sub-level in the User Setups, Suite Prefs, E-MEM Prefs menu therefore all the features and controls of a GV Switcher sub-level apply.

Bus Linking Examples

A typical use of Bus Linking is to have the buses of one M/E follow the selections on another with a few source substitutions. For example, if there's a special camera only used for the primary customer's feed, a Linked bus used for a secondary customer's feed might select a wide shot whenever that camera was selected on the Controlling bus.

Another example is to prevent feedback when selecting a studio wide shot. Many modern sets include monitors, and these will typically be fed from an aux bus of the switcher with program output selected. When the wide shot camera is selected on PGM-PST A bus, the camera might pick up the monitor wall and generate video feedback. This can be prevented by associating all source selections on PGM-PST A except the wide shot camera to select PGM-PST A on the aux bus. The wide shot camera source is then associated to an alternative graphics source on the aux bus appropriate to the show.

Another possibility is to program the M/E 3 A row as an extension of the PGM-PST A bus for shows that need instant access to more than 32 sources without pressing the Shift button. In this case M/E 3 A is the Controlling bus and PGM-PST A is the Linked bus. In this scenario, the easiest way to set this up is to link the buses and map the sources one to one, then set the shift preference for M/E 3 A to Shifted. An alternative method is to map each source on M/E 3 A to a specific alternate source on PGM-PST A. Other M/E 3 buses could be linked for

additional extended selection. A third alternative is to map all sources on M/E 3 A to select M/E 3 A on PGM-PST A.

Bus Linking Menu

One-to-one (Single), one-to-many (Parallel), and one-to-one-to-one (Cascading) bus links can exist simultaneously in the Bus Links, Links Setup menu.

The Bus Links menu is divided into two tabs, the Links Setup menu and the Source Tables menu. The Links Setup menu has the Current Link pane (on the left) and the Table Setup menu (on the right).

Use the Bus Links menu to link, enable/disable, break, and choose the source table for bus links. (Standard Table All Sources 1-to-1 is the default Source Table.)

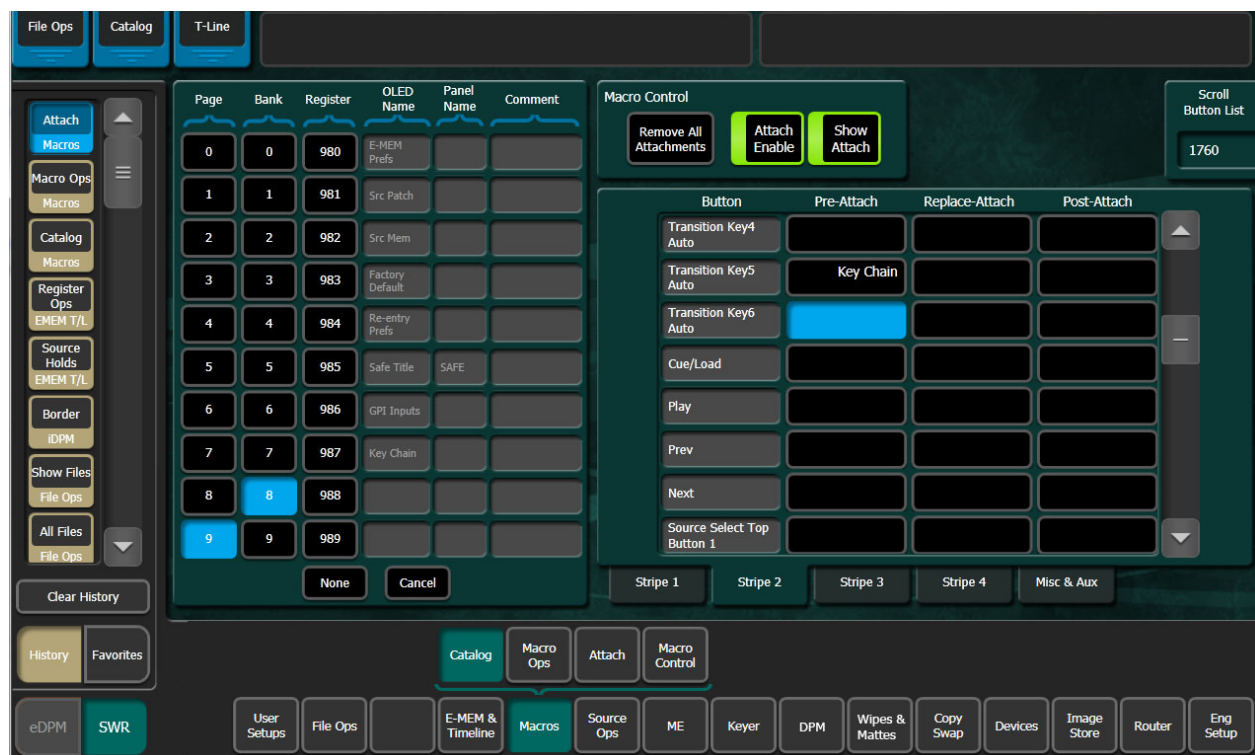

Selected Controller bus and Linked bus buttons turn blue when selected in the Current Link pane. In the menu example above, the Linked bus button PGM U2 is the selected button.

The Source Tables menu has the Source Tables pane (on the left) and the Table Setup pane (on the right). The Source Tables menu is used to select source substitutions within source tables and create a named relationship between the source table and the links to which they are assigned.

Give a source table a descriptive Source Table Name or rename a source table by selecting the Rename button.

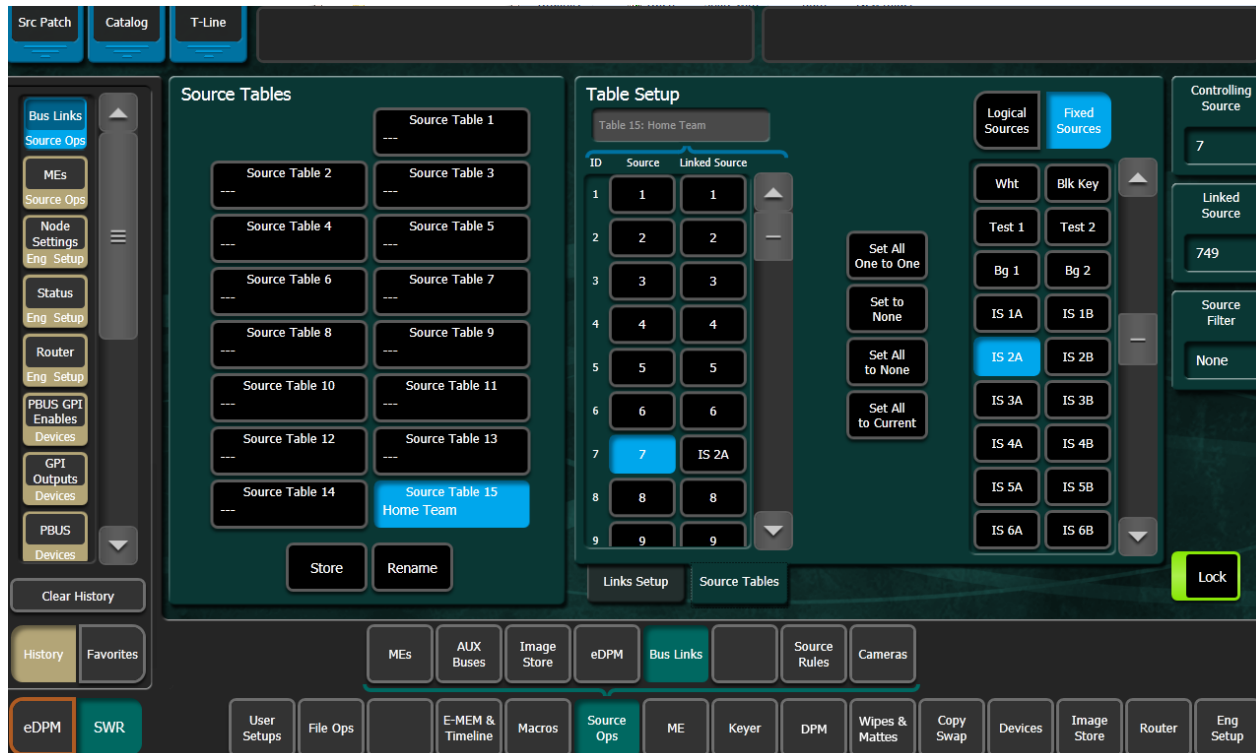

Bus Linking Source Substitution Tables

There are 15 configurable *Source Tables*. Each can be assigned to one, many, or all bus links once configured in the Source Tables menu.

A source table (or lookup table) can be configured and applied to every bus link. This frees up resources and allows a faster more efficient way of applying the same source substitutions to multiple bus links. Also, you are able to create named relationships between the source table and the bus links to which they are assigned.

The Standard Table All Sources 1-to-1 Source Table is the default. One of the other 15 configurable Source Tables can be assigned once configured.

Linked Source Buttons

Set All One to One—Sets all sources one-to-one.

Set to None—Sets selected source's Linked Source to none (blank).

Set All to None—Sets all Linked Sources to none (blank).

Set All to Current—Sets all Linked Sources to the currently selected Source (including none if defined).

Store button—Allows the current source table to be stored (copied) to another source table.

Configuring a Source Table with Source Substitutions

The default is one-to-one, i.e. Source 1, Linked Source 1, Source 2, Linked Source 2, etc. You can substitute the current Linked Source (Linked Source column) with any source from the scrolling Source List.

- 1 Select a source table in the Source Tables list.

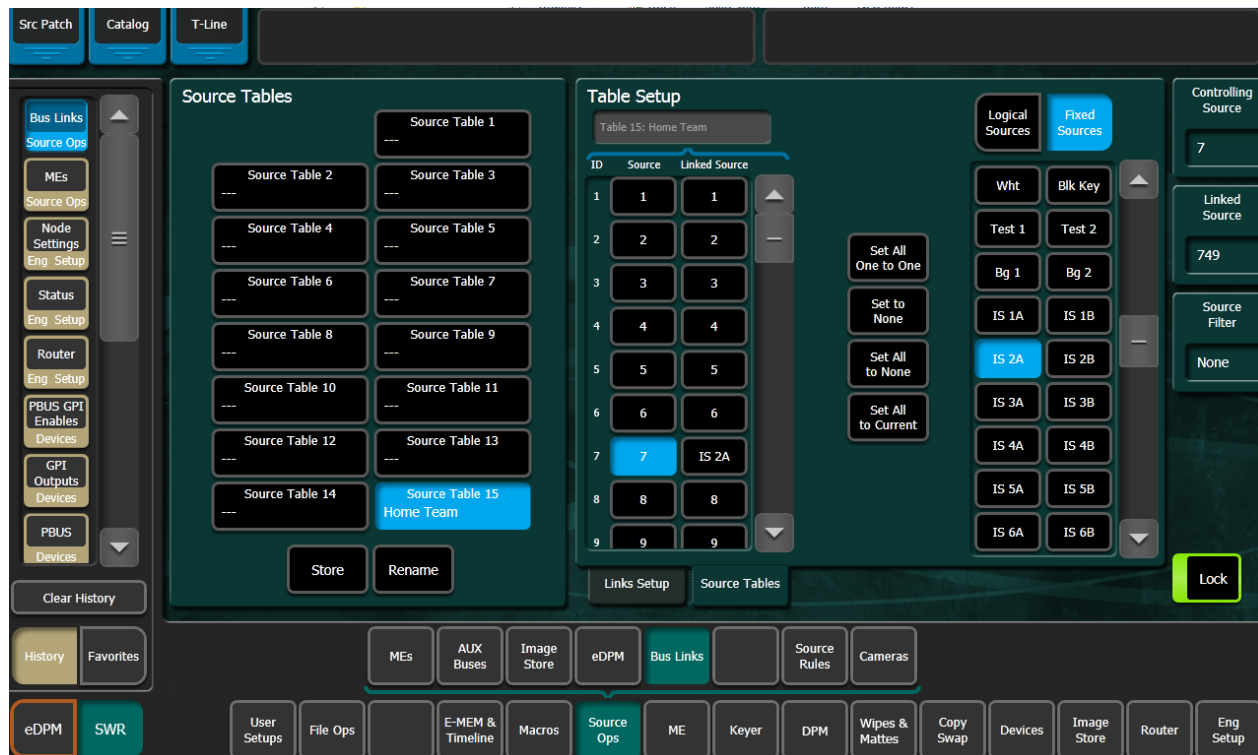

- 2 Rename the Source Table (recommended) by selecting a Source Table data pad, selecting the **Rename** button, and entering a new name.
- 3 Select a source in the Linked Source column of the Source/Link Source scrolling list the Table Setup pane.
- 4 Select the substitute source in the scrolling Source List.
- 5 Repeat the first two steps for all source substitutions.

Storing (Copying) Source Table Substitutions to another Source Table

Source Table configurations from one source table can be stored (copied) to another using the Store button.

- 1 Select the source table from the Source Tables scrolling list you wish to store (copy) from, to another source table.

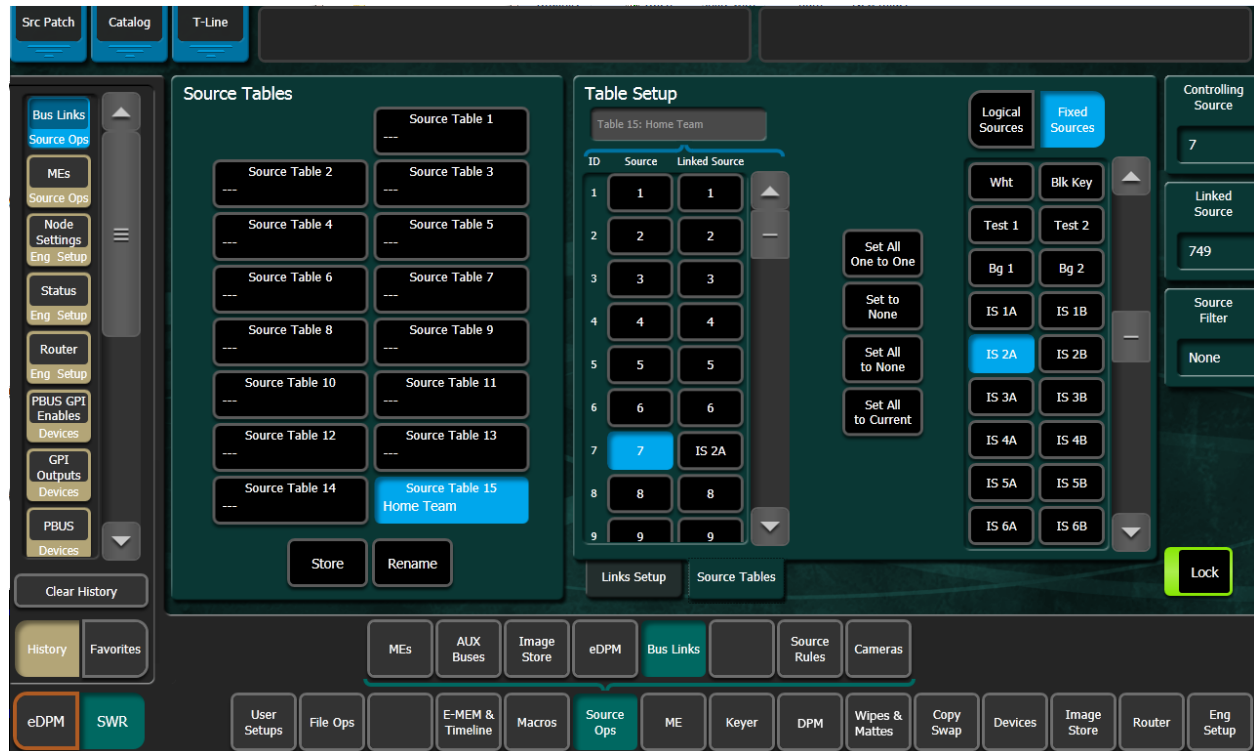

- 2 Select the **Store** button.
- 3 Select the source table you wish to store the configuration to (destination).

Changing Source Tables for a Bus Link

The Source Table is assigned to the bus link. Select the Linked bus data pad in the Link Setup menu, Current Link pane, to change the Source Table for that bus link. The Source Tables column becomes available. Select another source table for the bus link.

Source Table File Operations

Source Tables are part of GV Switcher file operations: File Ops, Source Tables menu. You can perform all the same file operations: copy, paste, save, load, etc., as with other File Ops menus. For more about File Operations, see [About File Operations](#), on page 37.

Linking Buses one-to-one

- 1 In the Links Setup menu, select the Controlling Bus data pad.
- 2 Select the M/E/Aux/eDPM menu tab.
- 3 Select the desired bus or eDPM input.
- 4 Select the **Linked Bus** data pad and repeat Steps 1-3.

The Link Setup menu displays the newly linked buses in the Current Link pane. The link is enabled and the Standard Source Table is selected as the default (Source Tables are grayed out).

You can disable or break the link using the Enable/Break buttons in the Current Link pane (the Enable button in the Table Setup pane will also enable/disable the selected link).

Creating Parallel Bus Links

Parallel Links allow the controlling bus to control more than one linked bus. In the example menu below, PGM A is the controlling bus and Aux 1, Aux 2, and M/E1 Key1, are all linked in parallel to PGM A.

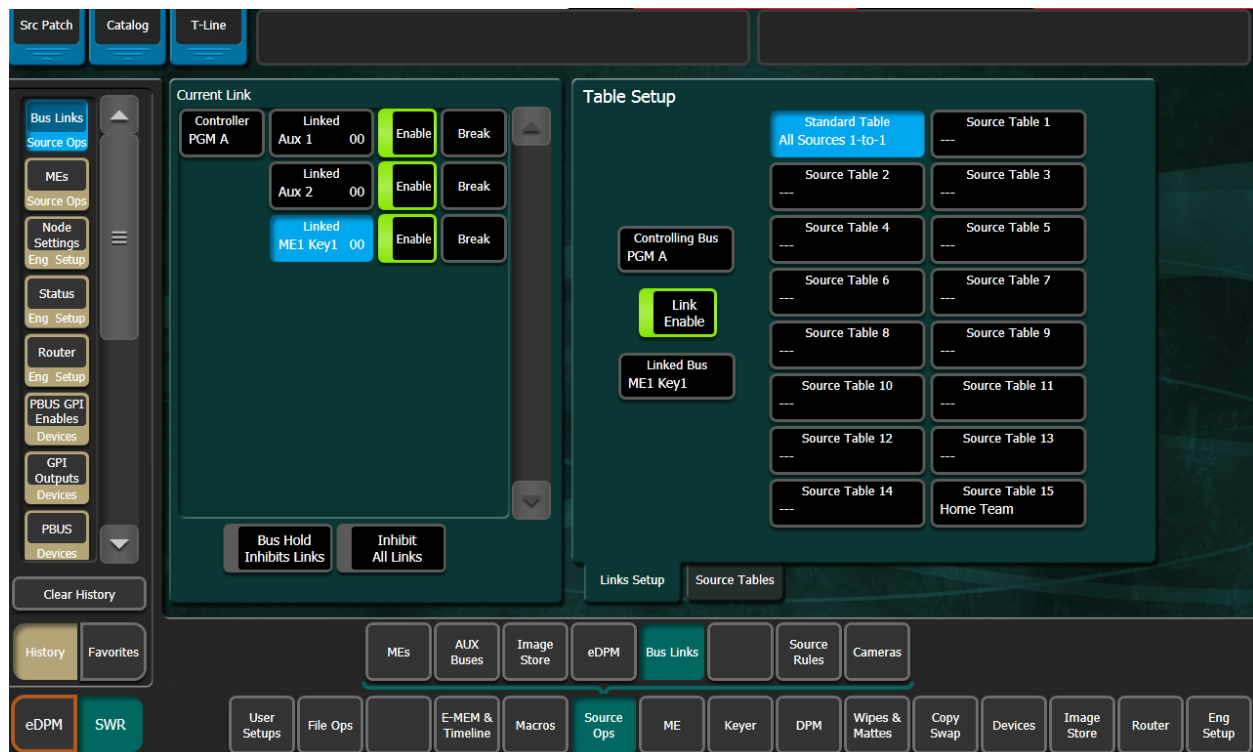

- 1 Select the **Controlling Bus** data pad in the Table Setup pane; the Controlling Bus selection menu is displayed.
- 2 Select the **M/E Buses, Aux Buses, or eDPM** Inputs tab and select the desired bus. The selected bus is displayed in the **Controlling Bus** data pad (in the example menu above, the selected bus is PGM A).
- 3 Select the **Linked Bus** data pad in the Table Setup pane; the Linked Bus selection menu is displayed.
- 4 Select the **M/E Buses, Aux Buses, or eDPM** Inputs tab and select the desired bus. The menu closes and returns to the Bus Links menu. The selected bus is displayed in the **Linked Bus** data pad.
- 5 Select the **Linked Bus** data pad again and select the next bus you wish to link to the controlling bus.

- 6 If desired, assign different source tables to the bus links:
 - a Select a **Linked Bus** data pad in the Current Link pane.
 - b Select a source table in the Table Setup pane.

Creating Cascading Bus Links

In Cascading Links, a controlling bus (A) has a linked bus (B) which in turn acts as the controlling bus for another linked bus (C), and so on. Changing a source on the controlling bus (A) will cause a change on both linked buses (B and C).

Example: In the menu example below, Controller PGM A controls Linked Aux 1, Linked Aux 1 is the controller for Linked Aux 2, and Linked Aux 2 is the controller for Linked Aux 3.

Button Color Definitions—The following applies for Cascading Links in the Current Link pane:

Black—Controller but not controlled: PGM A Bus is a controller but is not controlled so it is black in color.

Green—Controlled and controls: Aux 1 Bus and Aux 2 Bus although controllers, are also controlled so they are green in color.

Blue—Aux 3 Bus is controlled but is not a controller therefore it is blue.

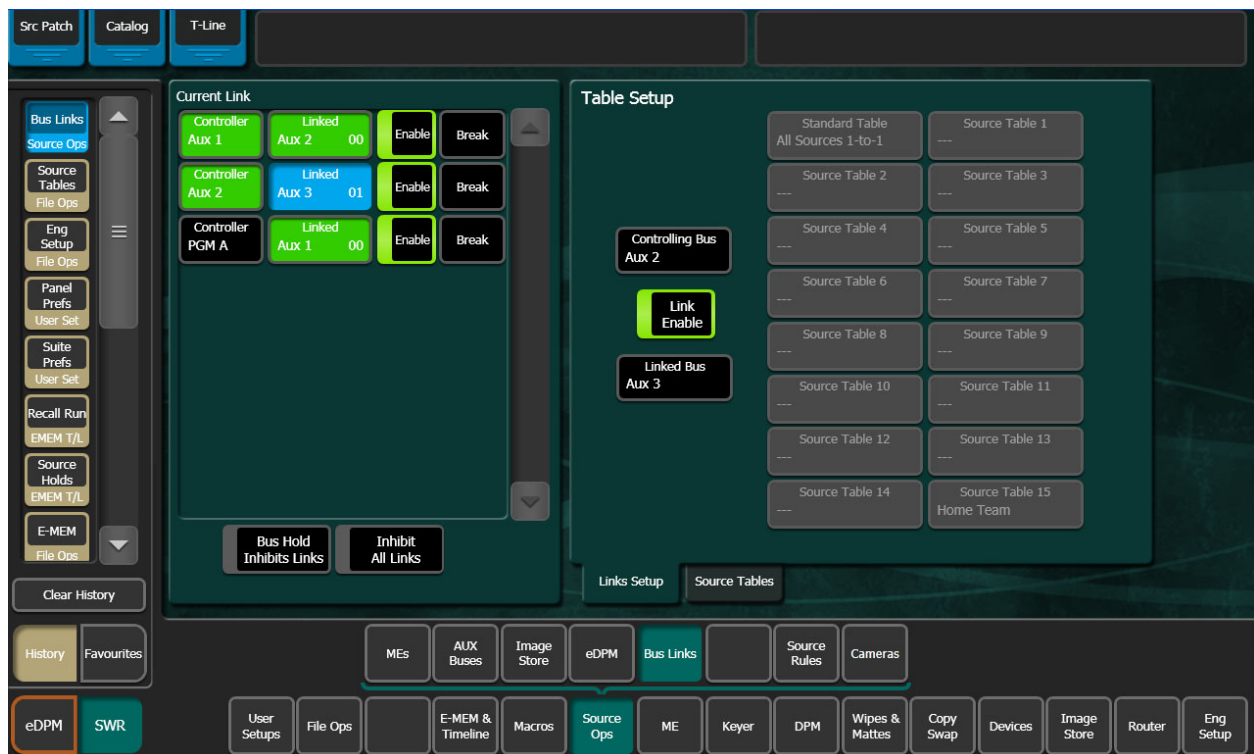

- 1 Select the **Controlling Bus** data pad in the Table Setup pane; the Controlling Bus selection menu is displayed.

- 2 Select the **M/E Buses, Aux Buses, or eDPM Inputs** tab and select the desired bus. The menu closes and returns to the Bus Links menu. The selected bus is displayed in the **Controlling Bus** data pad (in the menu example above, the selected bus is PGM A).
- 3 Select the **Linked Bus** data pad in the Table Setup pane; the Linked Bus selection menu is displayed.
- 4 Select the **ME Buses, Aux Buses, or eDPM Inputs** tab and select the desired bus. The menu closes and returns to the Bus Links menu. The selected bus is displayed in the **Linked Bus** data pad.
- 5 Select the **Controlling Bus** data pad again, in the Table Setup pane; the Controlling Bus selection menu is displayed. Select the same bus as is currently displayed in the **Linked Bus** data pad (your previous selection).
The linked bus is now also a controlling bus.
- 6 Select the **Linked Bus** data pad again in the Table Setup pane and select another linked bus.
Repeat this process for each controlling and linked bus you wish to add to the cascading links.
- 7 If desired, assign different source tables to the bus links:
 - a Select a **Linked Bus** data pad in the Current Link pane.
 - b Select a source table in the Table Setup pane.

Note: The Inhibit All Links button at the bottom of the Current Links pane must be off for the links to be active.

Bus Linking Rules and Restrictions

- The Switched Preview, Primary Preview, and Image Store input buses cannot be configured as Linked buses.
- An Aux bus associated with a DPM cannot be configured as a Controlling bus. However, these buses may be configured as Linked buses.
- Once the Bus Linking associations have been established and are enabled, selecting a source on a Controlling bus that is associated with a source on a Linked bus will make the Linked bus select its associated source.

Special operating rules:

- Source Override—Holding down a source select button on a Linked bus prevents that bus from changing its sources when Controlling bus source selections change.
- Bus Pair Rules—GV Switcher source selection buses can operate in pairs. M/E keyer buses operate in video fill/key cut mode. Aux buses can be configured in pairs, either as video fill/key cut or as video/video for external DPMs.

When a bus pair is involved in bus linking, the following rules apply:

- Key cut selections on video fill/key cut bus pairs does not affect the key cut source on a linked bus (split key cut selections don't link).
- The fill/A side of the Controlling bus is always sent to the fill/A side of the Linked bus.
- If the Controlling bus is in video/video mode, the B side selection will be sent to the Linked bus.

- If the Linked bus is in video-video mode, a B side source change from the Controlling bus will change the Linked bus's B side.

Note: A video-only bus behaves as if it is the A side of a bus pair.

Bus Linking Management

Individual bus links are enabled and disabled with the Link Enable button in the Controlling bus pane. When enabled, commands will be sent from the Controlling bus to the Linked bus, provided all links are not inhibited (see below). Link Enable is keyframeable.

Other controls on this menu can be used to manage bus links.

Bus Hold Inhibits Links – This control affects the behavior of the Control Panel Hold button for all Linked buses. When Bus Hold Inhibits Links is On and the Hold button on a Linked bus is also On, that Linked bus will ignore bus link commands and will not change sources when Controlling bus sources change. Note that the Hold button retains its existing functionality, keeping that bus from changing sources when an E-MEM register is recalled.

Inhibit All Links – Overrides all Link Enable settings to disable all active bus links. This does not change the individual Link Enable settings, however. Turning Disable All Links off will re-enable any bus links with Link Enable on.

7 Switching Basics

Basic Switcher Control Surfaces

A basic GV Switcher system may be equipped with a:

- Control Panel and Menu Panel or built-in touch screen,
- Control Panel and PC, or
- A KSP Soft Panel.

These separate control components make up a GV Switcher control surface. A control surface is typically used by a single operator. Interactions occur between the components of the control surface. For example, changing controls on the Control Panel can change the status of soft buttons on the Menu Panel, and vice versa. Remote Aux Panels are also available as an option. These remote panels are typically used by different operators at different locations.

The basic GV Switcher system is operated using button, knob, and lever controls on the Control Panel and Aux panels, touch screen and knob controls on the Menu Panel, keyboard on a touch screen (optional for KSP). Text and number entry is also possible via a standard PC computer keyboard. The Control Panel is used during live operation for fast, real time control. The Menu Panel, for Kayenne and Karrera and the built in touch screen for GV Korona are generally used in conjunction with the panel controls to set up effects and for system configuration. Effects can be saved for future recall, allowing fast and precise control of complex visual effects in real time.

The GV Switcher Video Production Center is an extremely powerful and flexible production tool, but also provides basic operations available on a typical production switcher.

Kayenne Control Panel Overview

The 4-M/E Kayenne Control Panel is designed for large scale live productions. Sources are selected in the Source Select Modules on the left side of each Stripe. Delegated controls for various Hold, Row Delegation, and M/E Bus selection are at the right of each Source Select Module.

Transition, Keying, Local/Master E-MEM, and device control selections are made on the following:

- KAYN-PNL-TRM - Transition Module
- KAYN-PNL-LEM - Local E-MEM Module
- KAYN-PNL-MEM - Master E-MEM Module
- KAYN-PNL-MFM - Multi-Function Module
- KAYN-PNL-SRC-35, 25, 15 - Source Select Module, available in 35, 25, and 15 button widths.

Note: 15 button widths are only available with 1-M/E Control Panels.

- KAYN-PNL-BAR-35 and KAYN-PNL-BAR-25 System Bar, available in two sizes to match various Control Panel widths.
- KAYN-PNL-DCM - Device Control Module, available as an option for 3 and 4-M/E panels and as a satellite panel module.

The Kayenne Control Panel is shipped in a default configuration, however module configuration can be customized. For more information about module configuration options, refer to the *Kayenne/Karrera/GV Korona Installation & Service Manual*.

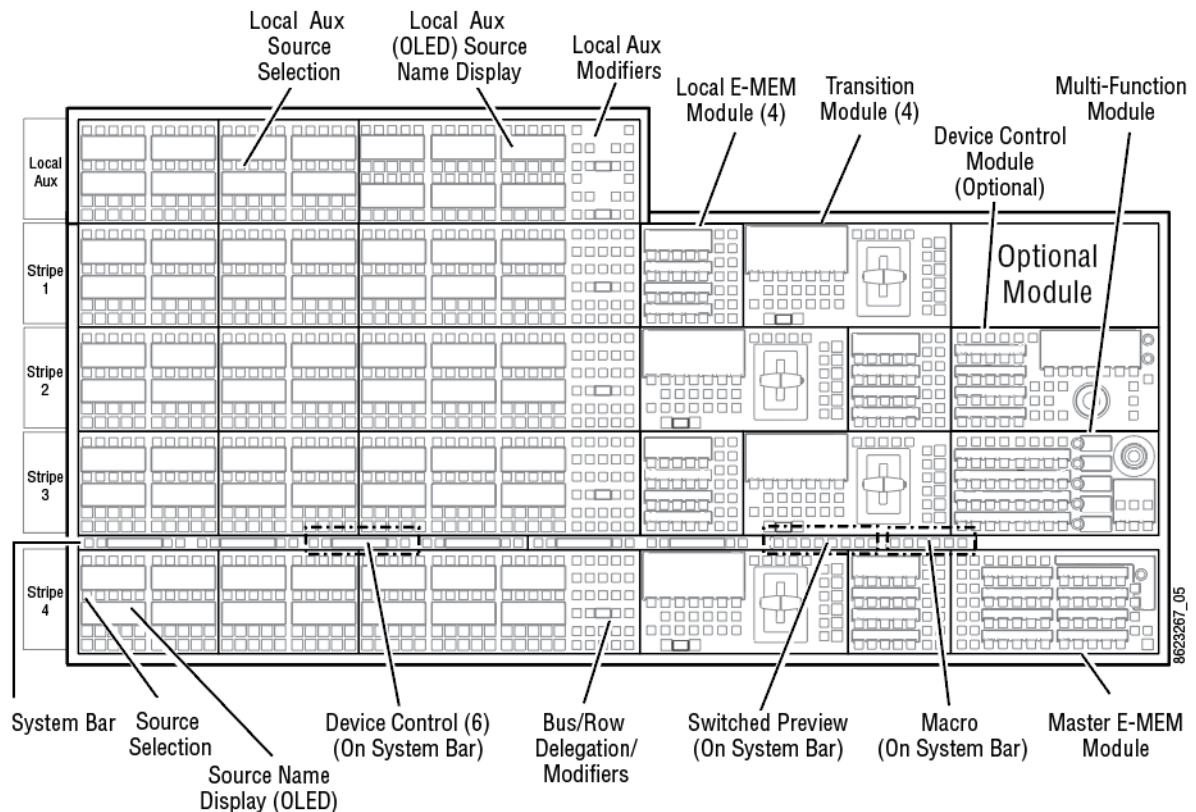

4-M/E Control Panel and Modules

Other Control Panel configurations are available for the Kayenne system, including 1-M/E, 2M/E, and 3-M/E.

Setting Panel Saver Mode

The Kayenne Control Panel will go into Panel Saver or “Sleep” mode, if no Control Panel buttons are pressed. The Control Panel goes into Panel Saver mode after 10 minutes of inactivity.

The Panel Saver mode for the Control Panel can be set to 10, 20, 30, or 60 Minutes (default is 10 minutes).

- 1 In the Multi-Function Module, from Home, press **Panel, Bri**.
- 2 Turn the bottom soft knob labeled **Panel Saver Delay, Minutes** to adjust the Panel Saver length.

Module Overview

An M/E Stripe has a module for source selection, transition, and individual E-MEM control. Additional Master E-MEM, Device Control (optional), Multi-Function, and Local Aux modules are populated to complete the control surface functionality. System operation information and procedures will be covered more thoroughly later in this chapter.

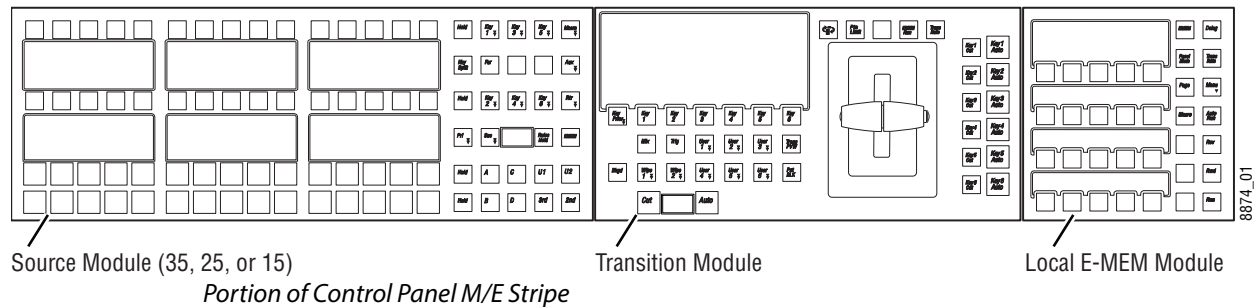

Transition Module

The Transition Module is organized into two control groups, the main transition controls, with status display and transition lever arm, and keyer transition controls. For information about using transitions, see [Transitions](#), on page 191.

Main Transition controls:

- Lever Arm—For manual transitions
- Status Display—Displays bus and keyer delegation and status
- Next Transition Element buttons
- Next Transition Type buttons
- Cut/Auto Transition buttons with Trans Rate display
- Transition Preview and Preset Black buttons

Keyer transition controls:

- K1-K6 (Keyer) Cut buttons

- K1-K6 Auto Transition buttons

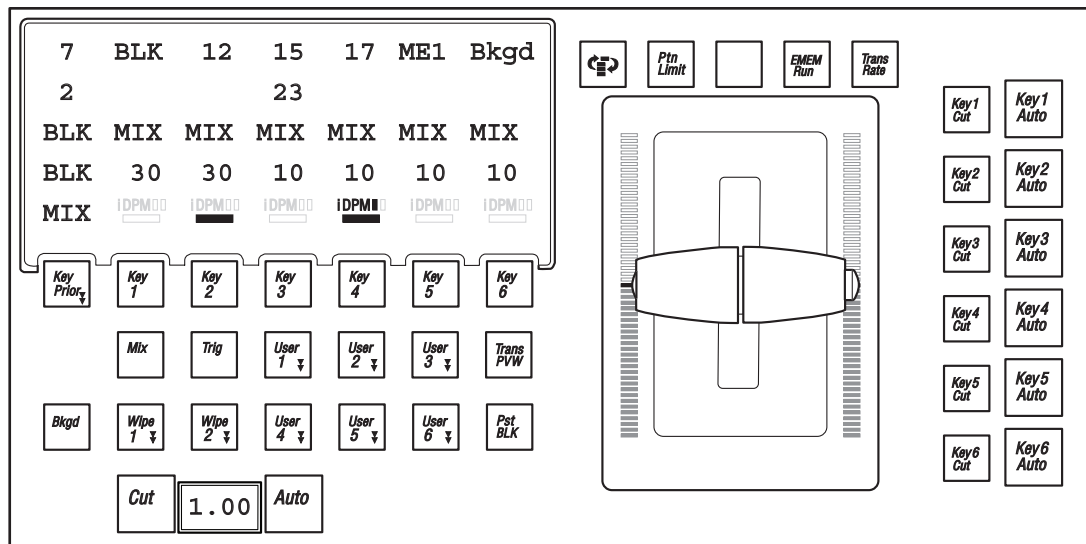

Transition Module Overview

Lever Arm and Bar Graphs

The Lever Arm is used to perform manual transitions, giving the same result as an Auto Transition and is generally used for manual control of the next selected transition. However, when the E-MEM Run button is enabled, the lever arm is delegated to controlling Local or Master E-MEMs.

When the Transition Module is delegated to running Local or Master E-MEMs, the scaling of the bar graph tracks the percentage of completion for the entire effect as the effect runs.

The Bar Graph shows the percentage of completion of the transition, per partition (Primary and Secondary). Manual transitions display bars, auto transitions are tracked with a single indicator, displaying from 0-100 percent showing the percentage complete of the current transition and the direction of movement required to complete the transition. The bar graph is not necessarily identical to the lever arm position. For example, when the Auto button is pressed, the bar graph will track the transition. For auto transitions, the bar graphs similarly track the percentage of completion of the transition (per partition in Split Mode).

The Lever Arm can be split into two separate arms to allow each partition to be transitioned separately (Primary and Secondary). To unlock the two lever arms, push the button in on the left arm. To lock, align the two sections and push the button in on the right.

Transition Module Status Display

The Transition Module Status Display has seven columns with four character rows plus one row with both BKGD bus text (column 1) and two rows of status indicators for keyers 1-6 or 1-4 (S-series).

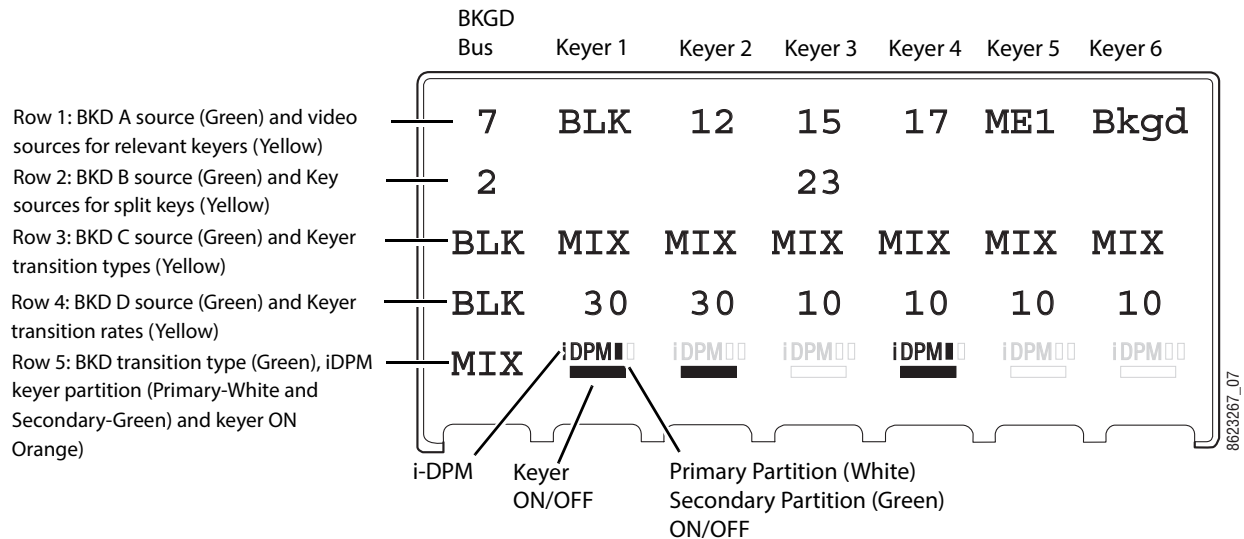

Transition Module Status Display Example

Additionally, when the Key Prior button (Keyer Priority) is pressed on the Transition Module, Row 4 changes from displaying transition rates to Keyer Priority for Keyers 1, 2, 3, etc. and shows the differences between the current and next priority stacks.

Function Buttons

The top button row, above the lever arm provides the following functions (from left to right):

Exchange ME  **Exchange ME** (button icon, left)—Toggle button for fast exchange (temporary delegation) of an M/E not delegated to a Stripe (see Exchange ME on page 275 for more information).

Pat Lim—Inactive.

EMEM Run—Runs an E-MEM from the Local or Master E-MEM Module.

- SPOP (single button push) of the EMEM Run button delegates the lever arm to control the local E-MEM.
- DPOP (double button push) of the EMEM Run button delegates the lever arm to control the Master E-MEM timeline.
- Pressing the E-MEM Run button again, exits the mode.

Trans Rate—Allows Auto and Key Mix 1-6 buttons having an associated transition rate to be altered, set, or queried. Once the Trans Rate button is selected, the associated buttons flash and the Local E-MEM Module changes to Trans Rate Mode for input. Pressing one of

the flashing buttons indicates that its transition rate is to be set. While holding down this button any of the other flashing buttons can be pressed for multiple selection.

Next Transition Buttons

The Next Transition Element buttons are located just below the status display: **BKGD**, **K1-K6**, and **Key Prior**.

The Next Transition Type buttons are located below the Next Transition Element buttons: **Mix**, **Wipe 1**, **Wipe 2**, and **User 1-User 6** (radio buttons). Selecting one turns the others off if a next transition element button is not held down.

Cut and Auto Buttons

The Cut and Auto buttons are located at the bottom, middle of the Transition Module.

- **Cut**—Executes a cut on the buses selected as being in the set of next transition elements.
- **Auto**—causes the selected next transition type to be executed with a Next Transition Duration.

A press and release of a Next Transition Element button high tallies the button and low tallies the others.

To multi-select next transition element buttons:

- Press more than one button at a time or,
- Press and hold down any of the eight transition element buttons and then select one or more of the remaining buttons.

The rule is that while any next transition button is held down, other next transition buttons can be added or removed from the next transition by toggling that button.

Additional Buttons

- **Trans PVW** (Transition Preview)—When a transition is performed in this mode, it occurs only on the LAP output. At completion of the transition, the Transition Preview is auto-canceled.
- Pressing the Trans PVW button causes the button to flash. Both the PGM and LAP outputs show the current PGM out stack.
- **Trig** (Trigger)—Inactive
- **PST Black** (Preset Black)—Pressing the **PST Black** button, then pressing the **Cut** button, **Auto** button, or using the lever arm, will delegate the first transition using Mix or Wipe to black.

Local E-MEM Module

The Local E-MEM Module is part of an ME Stripe and is organized into two sections, the mode area (left), with supporting buttons and status display, and two rows of function

buttons (right) for mode selection and effects control. For more information about using E-MEMs, see [Basic E-MEM Operations](#), on page 109.

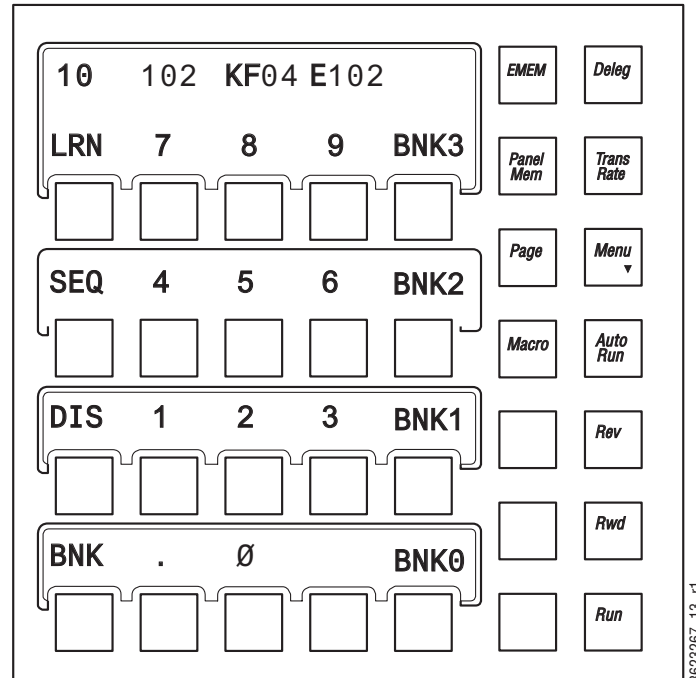

Local E-MEM Module Example

Bank buttons BNK 0 - BNK 3 in the Local E-MEM Modules (right side of keypad) provide faster access to banks. A single press of the button delegates to the bank indicated, a DPOP of the button takes you to the bank indicated + 4, e.g. one press for Bank 0, DPOP for Bank 4. The highest bank available is Bank 7 (DPOP of BNK 3 button). The buttons will be unlit for Banks 8 and 9. A DPOPed selection high tallies cyan (blue) color.

There are several modes available with the Local E-MEM module, accessed by pressing the following buttons:

- **EMEM**—Local M/E E-MEM recall and edit mode,
- **DELG**—Change M/E control on selected Stripes,
- **Panel Mem**—Learn and recall panel memory,
- **Trans Rate**—Set transition rates for M/E,
- **Macro**—20 Macro recalls can be set to any page using the Page button in this mode,
- **Dissolve Rate**—Press Learn, Dis, Trans Rate buttons

The Local E-MEM Module display shows specific information for each mode, for example if the Panel Mem button is pressed, Panel Memory information is displayed.

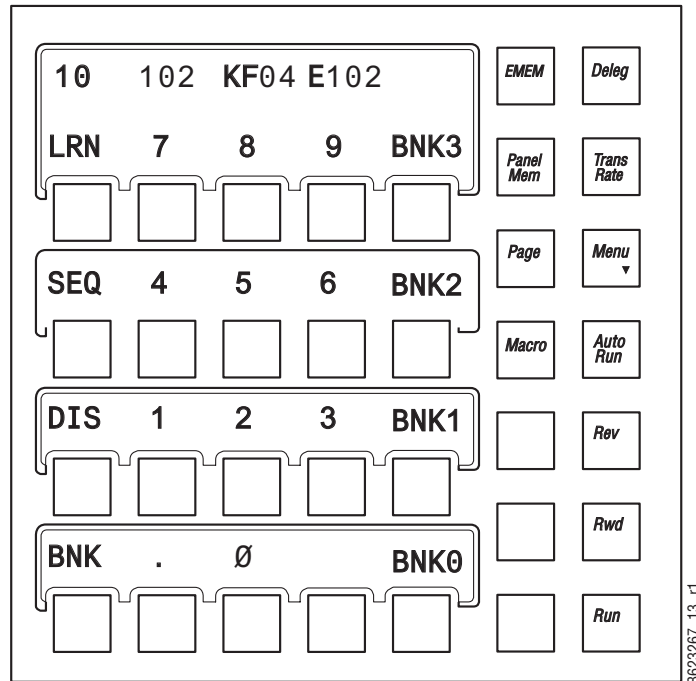

Local E-MEM Module—Panel Memory Example

Master E-MEM Module

The Master E-MEM Module is not part of a Stripe, it provides E-MEM control across the Control Panel and Local Aux Module. The Master E-MEM Module can control the entire Kayenne effects system, including e-DPM. The 19 Enable/Delegate buttons (MISC 1-8, PART, AUX, GPI, PBUS, IS 1-6, and EXT) are used to both enable and delegate, which is determined by the mode selection (Run control versus Edit).

The Bank buttons BNK 0 - BNK 3 have been placed in the Master E-MEM Module (right side of keypad) to provide faster access to banks. A single press of the button delegates to the bank indicated, a DPOP of the button takes you to the bank indicated + 4, e.g. one press for

Bank 0, DPOP for Bank 4. The highest bank available is Bank 7 (DPOP of BNK 3 button). The buttons will be unlit for Banks 8 and 9. A DPOPed selection high tallies cyan (blue) color.

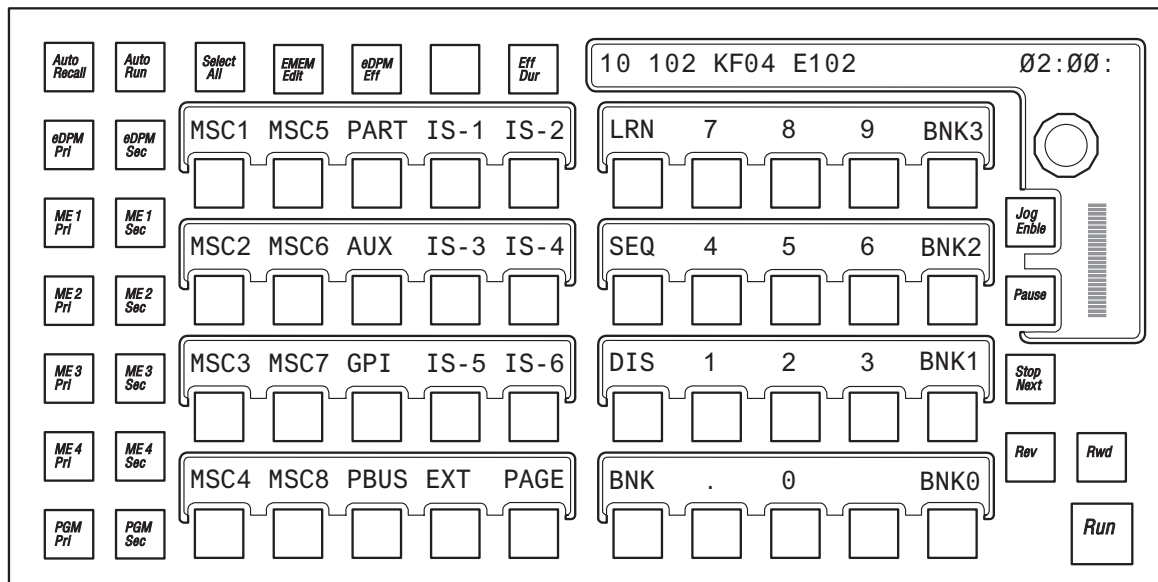

Master E-MEM Module Example

The following describes the Master E-MEM Module organization:

- Two rows of delegation buttons (left side),
- One row of Function and Mode buttons across the top (left),
- Jog Knob with LED (top right)—Rotating this knob clockwise advances through the effect. Rotating the knob counter-clockwise moves the effect position backwards. The degree of rotation advances the current effect position (time) proportional to the effect duration (not to keyframes). Two full rotations moves from one end of an effect to the other. The status display above the Jog Knob displays the current effect's position (M-SS-FF).
- Below the Jog Knob (right side) is the Bar Display that also shows the current effect position, and the REW and Run effects buttons.
- Just left of the Bar Display is the Jog Enable button (enables the Jog Knob) and the Pause, Stop Next, and Rew effects function buttons,
- In the center are the Level buttons with displays. The Level buttons have two modes:
 - Enables for run control and
 - Delegates for keyframe editing.

Multi-Function Module

The Multi-Function Module with positioner, delegates to the following functions:

- Keyer Modifiers,
- Mask Modifiers,
- Matte Modifiers,
- Wipes,

- e-DPM,
- i-DPM,
- Copy/Swap utilities,
- Device control, and
- Source Selection.

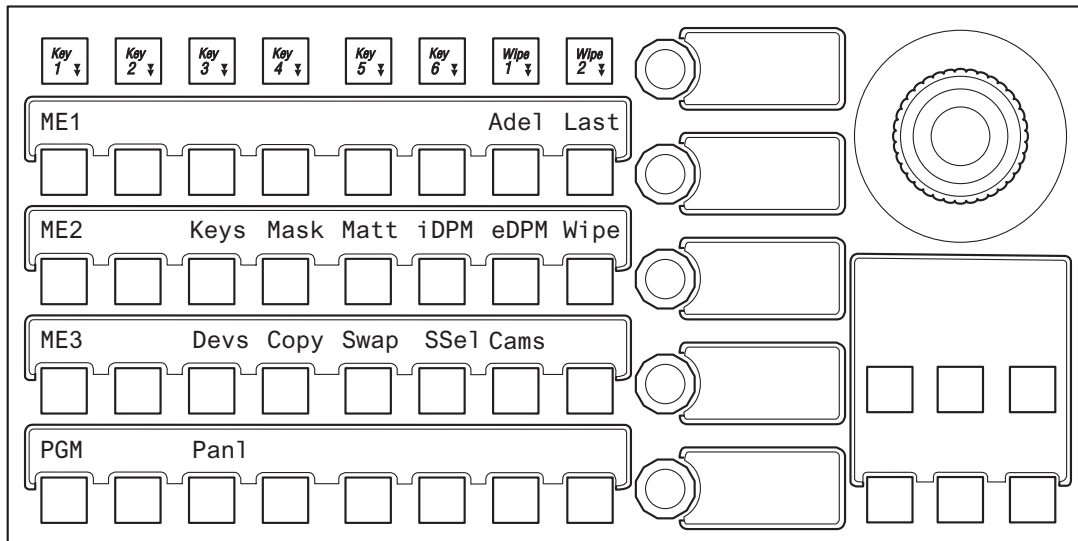

Multi-Function Module Example

The following describes the Multi-Function Module organization:

- Function button row (top left), with four or six Keyer (Key 1, 2, etc.) buttons and Wipe 1 and Wipe 2 buttons for delegating to a keyer for the selected M/E.
- Below the function row is the main delegation area with buttons and status display:
 - The first column (left) are radio buttons for delegating the M/Es, for example M/E 1, M/E 2, M/E 3, and PGM.
 - Adel button (right)—ON supports 'Auto Delegation' of this module when selecting a source on a key bus, delegating a keyer in the bus control section of any Source Select Module, selecting a keyer in any Next Transition section of any M/E, and selecting Wipe 1 or Wipe 2 in any Transition Module,
 - Last button (far right)—Toggles between current and previous delegation modes,
 - HOME button (only displayed when not at the Home position)—Moves the display to the top or 'Home' level,

Note: The HOME, Adel, and Last buttons change position in some delegated modes, for example in Copy or Swap mode, these buttons move from the main delegation area to the Multi-Function Module just below the joystick.

- The other buttons in the main delegation area, when in the Home position, delegate to: Keys, Masks, Mattes, i-DPM, e-DPM Wipe, Device, Copy, Swap, Source Select, and Panel Preference. When pressed, the LEDs and buttons are delegated to those modes and modifiers,

- Knob row with LEDs (middle-right) provides adjustment and display of parameters for delegated functions,
- Joystick (top-right) performs multiple functions depending on the delegation, for example for keyers the joystick positions a delegated keyer (X,Y, and Z axis), but with device control the joystick performs jog control operations (Up, Down, Fast Forward, Rewind—center button performs Mark-In),

Note: The joystick can be calibrated from the MFM: from Home, press Panl, Cali and follow the instructions displayed on the MFM.

- Multi-Function Module, (bottom-right) below the joystick, supports various delegated functions, for example Copy/Swap and Devices.
 - The XFER button, displayed in the Multi-Function Module when the Wipe menu is displayed, assigns control of values and status display for the five other buttons in the group to the five soft knobs. Pressing one of the soft knobs delegates control for numeric entry in the main delegation area. Pressing Enter completes the numeric entry operation.

Source Select Module

The Source Select Module is available in three configurations: 15, 25, and 35 button models.

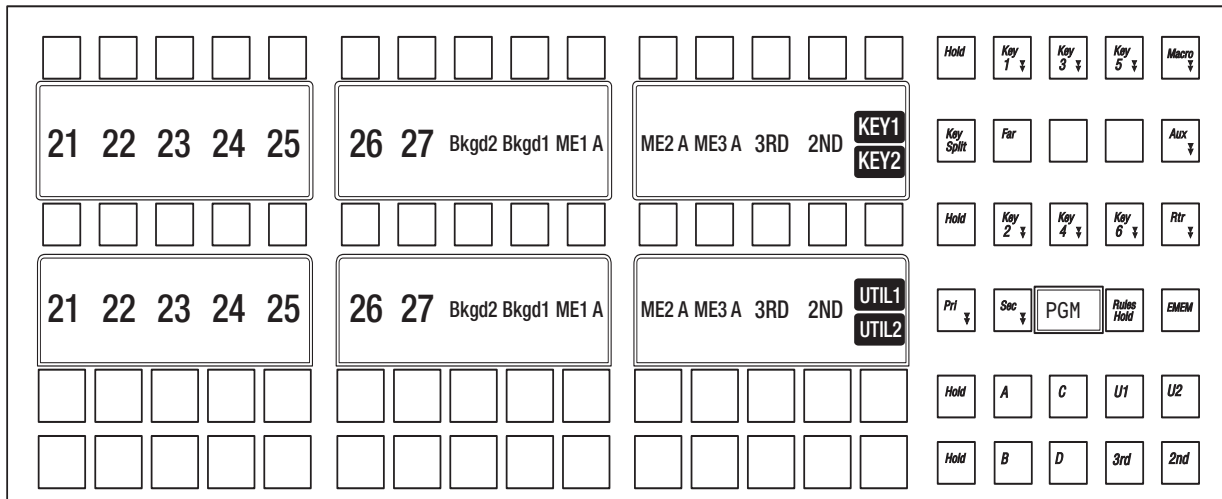

Source Select Module Example

Text Display Outlines

Outlines border the display text; this is the default. Outlines can be toggled off/on in the MFM: from Home, press the **Panl**, **Bri**, buttons then toggle the **OUTL** (under Joystick) button.

Source Name Text Wraps

Inserting a space in the Source Name wraps the text to the second line. For example typing **CAM** then a space then the number 3 would wrap '3' to the next line of the OLED button display.

8874_02

The Source Select Module can be viewed as being in two sections; left for source selection buttons, in groups of five, with SND (Source Name Display) display and right, with function and delegation buttons (and one display) for that M/E.

Source Select Device Input Name Modifiers

The device input name modifier symbols provide device status on the Source Selection display.



Source Selection Modifier Symbols

Source Select Motion Control Symbols

Motion Control Device Input Modifier Symbols

Symbol	Name	Description
>	Right bracket	Play
<	Left Bracket	Reverse Play
.	Dot (period)	Stop (also indicates a loaded Image Store still or recording)
.	Dot (period)	Record
<<	Double left bracket	Rewind
>>	Double right bracket	Fast Forward

Notification Symbols

Device Input Modifier Notification Symbols

Symbol	Name	Description
~	Tilde	Device not acquired
?	Question mark	Device is not connected
!	Exclamation mark (or 'bang')	Device error
*	Asterisk	Router Source destination is not selected or is undefined
^	Caret	No Image Store movie or image (not used for external devices)

Source Select Buttons and SND

The following describes the Source Select Module organization for source select buttons:

- Source Selection buttons (left)—Can be mapped and delegated to buses, macros, routers, etc. and there are no limits to mapping so the same function or source can be

mapped numerous times, and saved in Panel Memory (Local E-MEM Module/File Ops, Panel Mem menu). Source selection buttons can be mapped as:

- Switcher sources—Can be delegated to source selection for any M/E bus, Aux bus/Aux selection, Router control, Macros, or E-MEM recall,
- Shift function—There are four shift levels 1st (unshifted), 2nd, 3rd, and 4th,
- Row Delegation function—Mapped to the right-most source select button (default). The SND (Source Name Display) associated with the row delegation button indicates the name of the bus or function, e.g. K2, MACRO, Router, U2, etc.,
- SND LEDs—SNDs have two modes, 'Full' and 'Split'. If both adjacent rows have identical text for a source, it is displayed in full, i.e. large text. If the two rows have different text, the SND is split into two rows of smaller text. SNDs show source names, macro names, router source and router destination names, Aux bus numbers, etc.
- Shift buttons—Shifts can be mapped anywhere on the Source Select Module (or nowhere) using the User Prefs, Button Mapping menu (default is 2nd and 3rd on the second and third source select buttons from the right).

Function and Delegation Buttons

The following describes the function and delegation buttons:

- **Hold** button—Sets a bus hold on the delegated row.
- M/E bus select buttons—**K1-K6, A, B, U1, and U2** in columns 2-4, pressing one of these buttons delegates that bus.
- **Macro** select button—Delegates rows 1 and 2 of a Source Select Module to macros.

Note: To delegate one row, hold down the Macro button and press a bus delegation button or hold down the bus delegation row button and press the Macro button.

- **Key Split** button—Creates a split key when a source is selected for the fill signal, the Key Split button is held down, and a source is selected on a row delegated to the key bus.
- **Far** button—The Far modifier is used for DPM rotation transitions. During DPM operations, the side that is seen by the user is defined as the 'near side'. To set the far side for the current delegation of a bus, press and hold the Far button (and shift button if necessary) and make a source selection for that side.
- **Aux** select button—Delegates Rows 1 and 2 of a Source Select Module to Aux bus control.
- **Router** select button—Delegates Rows 1 and 2 of a Source Select Module to Router selection.
- **Rules Hold** button—When pressed (toggle), Source Rules will not be applied to the M/E delegated to that Source Select Module.
- **E-MEM** select button—Delegates rows 1 and 2 of a Source Select Module to E-MEMs.

Note: To delegate one row, hold down the E-MEM button and press a bus delegation button or hold down the bus delegation row button and press the E-MEM button.

- **Pri** partition select button—Delegates all four rows of a Source Select Module to the primary partition (Rows 1 and 2 are delegated to the last delegation when Pri was used, Row 3 is delegated to the A bus and Row 4 is delegated to the B bus).
- **Sec** partition select button—Delegates all four rows of a Source Select Module to the secondary partition (Rows 1 and 2 are delegated to the last delegation when Sec was used, Row 3 is delegated to the U1 bus and Row 4 is delegated to the U2 bus).
 - Pressing the Pri and Sec buttons together causes both buttons to high tally. Both partitions are controlled but only tallies for the Primary partition will be seen on the Source and Local E-MEM modules.

Note: Pressing the **Pri** or **Sec** buttons delegates the Transition and Local E-MEM Modules in addition to the Source Select Module and modifies what wipe generators can be selected on the Matte and Wipe delegations of the Multi-Function Module.

- M/E delegation indicator—Located between the Sec and Rules Hold buttons, displays the current delegation of the panel row to the logical M/E (M/E-1, M/E-2, PGM, etc.).

Split OLED Source Select Display States

Control Panel Source Select OLED displays split under the following conditions:

- Source Memory is turned on for the selected source.

Note: Sources with Source Memory applied have a line through the source name on the OLED.

- The selected source is Asynchronous.

Note: OLED backgrounds flash a solid color for Asynchronous sources.

- A bus row is shifted independently,
- Delegations—Macro, Router, E-MEM, etc., and
- Uncalibrated—The source video is processed, for example RGB Color Corrected, pixelated, etc. (the source name is underlined in the OLED).



Split OLED Source Select Display

Local Aux Module

The Local Aux Module is located at the top of the Control Panel, above the Stripes.

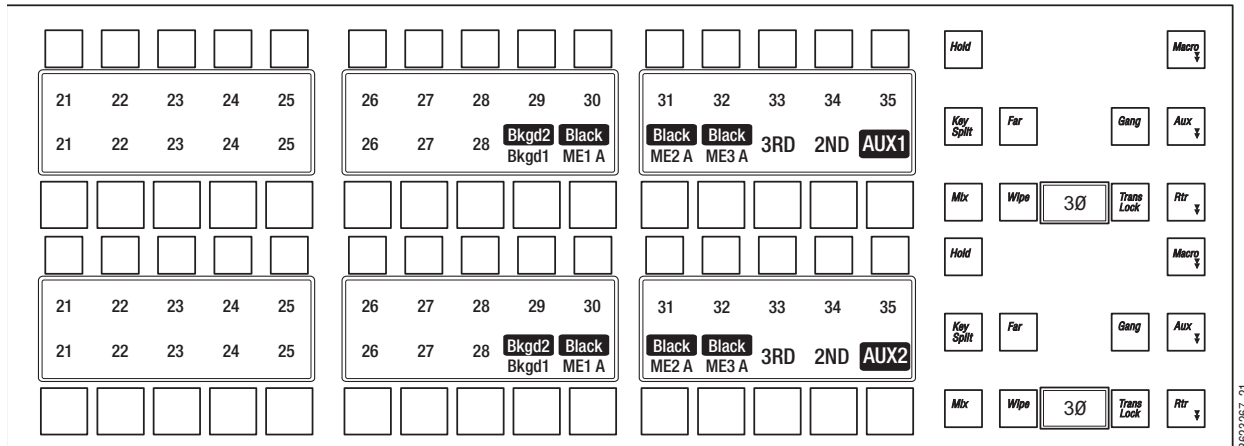

Local Aux Module Example

Included features:

- The following will tally button colors in the Local Aux Panel to more easily identify special sources:
 - eDPM=Blue,
 - IS (Image Store Channel)=Orange, and
 - Preview Primary=Yellow.
- Outlines border the display text; the default. Outlines can be toggled off/on in the MFM: from Home, press the **Panl**, **Bri**, buttons then toggle the **OUTL** (under Joystick) button.
- To allow a larger font, the Local Aux Panel OLED displays the ID or Name (if configured), only.
- Inserting a space in the Source Name wraps the text to the second line. For example typing **CAM** then a space then the number 3 would wrap '3' to the next line of the OLED button display.

Note: If a name is configured, the Eng ID can still be seen in the Menu Panel.

The Local Aux Module is similar to the Source Select Module, the main differences are:

- Status displays (OLEDs) are located between the button rows, both at the top and bottom of the module,
- There are two rows of small buttons and two rows of larger buttons, and
- Different function buttons on the right side of the module, as shown:

8623267_21

Local Aux Panel Function Buttons

Function Button	Local Aux module	Source Select module
Hold	X (2)	X (4)
Macro	X	X
Key Split	X	X
Far	X	X
Aux	X	X
Rtr	X	X
Gang	X	
Mix	X	
Wipe	X	
Trans Lock	X	
Key1-Key 6		X
Pri		X
Sec		X
Rules Hold		X
EMEM		X
A (Bus)		X
B (Bus)		X
C (Bus)		X
D (Bus)		X
U1 (Bus)		X
U2 (Bus)		X

The Local Aux Module provides the following functionality:

- Aux Bus control (the default), including Aux Bus dissolves and wipes,
- Router control,
- Panel Ganging, and
- Macros.

There are two identical sets of Aux Bus controls; upper and lower, both sets of controls operate identically. For each set of controls, pressing a button on the top row selects an Aux Bus destination and pressing a button on the bottom row selects a source for the selected top row Aux Bus.

System Bar

The System Bar provides:

- Switched Preview selection,
- Macro editing functions,

- Machine control, and
- Displays reboot indications.

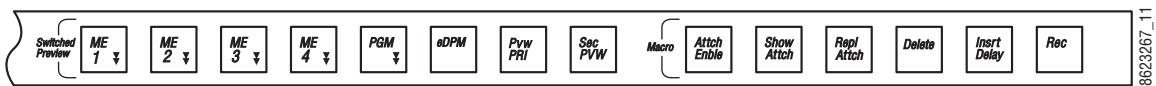
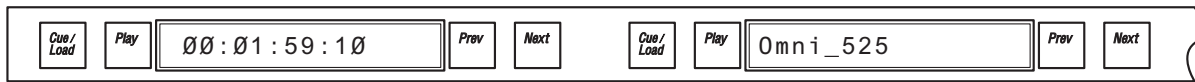

System Bar Example

Switched Preview Button Group

The Switched Preview button group is the second button group from the right on the System Bar.

Switched Preview is a special output of the switcher that permits previewing any source. Typically this output is connected to a dedicated Switched Preview monitor. The Switched Preview button group is used to control what signal is routed to that output.

ME 1, ME 2, ME 3, ME 4, PGM, eDPM, and Pvw PRI, are radio buttons, and **Sec PVW** is a toggle button (on/off).

ME 1 - PGM buttons—Routes the primary preview of that M/E to the Switched Preview output. When Sec PVW is toggled on, routes the secondary preview of that M/E (if it has been split) to that output.

eDPM button—Routes the A output of the eDPM to the Switched Preview output. When Sec PVW is toggled on, routes the C output of the eDPM to that output.

Pvw PRI button— Preview Prime is a specially named bus that is available on the Switched Preview button group, and can be mapped as a delegation on the Local Aux Module. When the Switched Preview **Pvw PRI** button is on, the currently selected source on that Preview Prime bus is routed to the Switched Preview output. When the Local Aux Module has also been delegated to PVW Pri, any source mapped on the Local Aux Module buttons can then be selected for display on the Switched Preview output.

Sec PVW button—As described above, when the **Sec PVW** button is on, it selects the secondary preview of an M/E, or the C output of the eDPM for display on the Switched Preview output. This button is inactive when **Pvw PRI** is selected, since that bus has only one output.

Macro Editing Button Group

The Macro Editing buttons (Figure 130) work in conjunction with the source select rows delegated to macros:

Attch Enable button—Turns on/off macro attachments.

Show Attch button—Flashes all source select buttons that have a macro attached.

Repl Attch button—Substitutes a macro for the button’s normal action.

Delete button—Enables the macro delete operation. Pressing a button on a bus row delegated to macros deletes the macro and ends the delete operation.

Insert Delay button—Changes the delegated macro row(s) to display Time Delay on the SNDs in increments of seconds and tenths of a second (1st shift level—unshifted) or fields (2nd shift level).

Record button—Enables the record operation. Pressing a button on a bus delegated to Macros starts the recording, the recording is ended by pressing the **Record** button again or pressing the **Macro** button (on the Source Select Module) again.

Device Control Groups

There are six Device Control groups for 25 and 35 button Source Select Modules and two Device Control groups for 15 button Source Select Modules.

Each Device Control group provides a:

Cue/Load button—Pressing this button after the Prev or Next buttons have been pressed, sends a load command if the clip is different from the clip currently loaded or a cue command if the clips are the same.

Play button—Sends a Play command to the selected device (pressing **Play** a second time pauses the device).

Display—Displays the current clip.

Prev button—One button press steps backward through the current directory of clips.

Next button—One button press steps backward through the current directory of clips.

Reboot indication—The left-most Device Control display is used as a frame reboot indication and the next (to the right) Machine Control display is used to indicate a Control Panel reboot.

Device Control Module

The Device Control Module brings together essential machine controls that are currently being performed by auxiliary devices, into a single point of control.

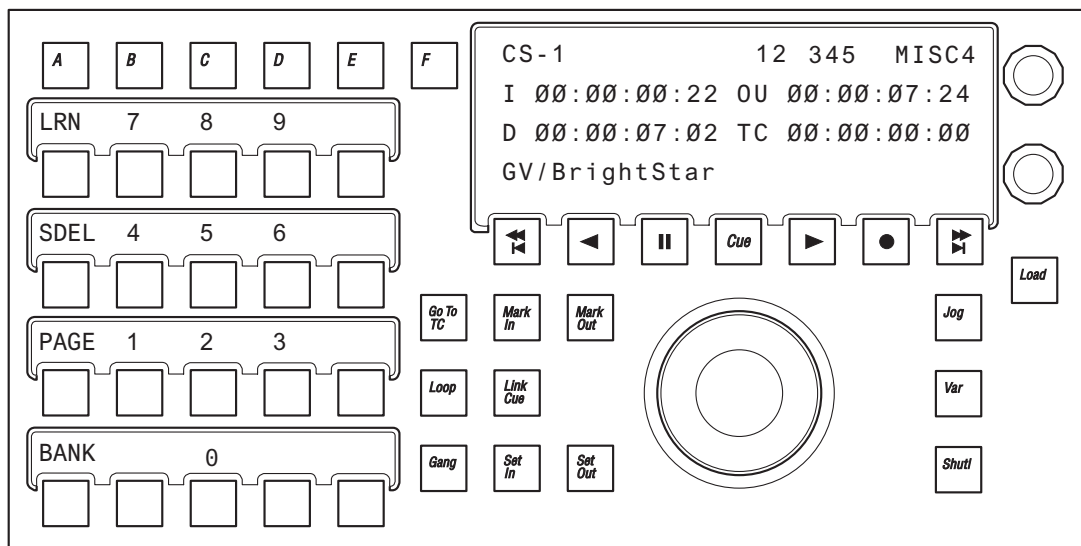

Device Control Module Example

The Device Control Module controls all configured devices including:

- Serial control of VTRs and DDRs,
- Ethernet control of VTRs and DDRs,
- Image Store, and
- ClipStore.

Device Control Functionality

The Device Control Module supports the following functionality:

- Run control:
 - Play,
 - Cue,
 - Stop/Pause,
 - Jog +/-,
 - Fast Forward, Rewind,
 - Variable speed play,
 - Mark in/out,
 - Loops,
- Library of cues (Q-MEM),
- Record, and
- Ganging.

Device Control Module Organization

The Device Control Module is organized as follows:

- Device Select button group (buttons A-F), located at the top-left of the Device Control Module, has six buttons labeled A-F. These buttons select devices for control by the Device Control Module and when selected, show status for that device in the Status Display (top-left).
- Status Display, located middle-right at the top, (right of the Device Select button group),
- Run Control button group (with Cue button), located middle-right (just below the status display),
- The two soft knobs (Knob 1 and Knob 2), at the far right of the Device Control Module (right of status display), are:
 - Knob 1, Device select knob (top)—turn to scroll through and delegate devices, and
 - Knob 2, Clip select knob (bottom)—turn to scroll through and select clips (parameters for both knobs are shown on the right in the status display.),
- Clip Editing button group, located in the middle of the Device Control Module, has eight clip control buttons:
 - Go To TC—Device jumps to keypad entered numeric time code data.
 - Mark In—Captures the current Time Code of the selected device and stores it as the 'Mark In' position.

- Mark Out—Captures the current Time Code of the selected device and stores it as the 'Mark Out' position.
- Loop—If Mark In/Mark Out points are set, causes the selected device to loop from the Mark Out point to the Mark In point, if points are not set, causes the device to loop from the end of a clip to the beginning.
- Link Cue—Allows you to learn more than one device into a cue.
- Gang—Works with Device select button group to 'Gang' devices.
- Set In—Allows you to set a Mark In into a clip using numeric keypad entry.
- Set Out—Allows you to set a Mark Out into a clip using numeric keypad entry.
- Jog knob—The Jog knob (middle-right) is associated with the Jog, Var, and Shuttle mode buttons (middle, right of Jog knob). The jog knob operates in the three modes (with button on) as follows:
 - Jog—Complete 90 degree rotation of the Jog knob represents one frame (forward or in reverse),
 - Shuttle—Rotating the Jog knob causes forward (or backward) play at a rate starting from unity speed to the maximum shuttle speed of the device. A complete 360 degree rotation of the Jog knob causes the device to be at its maximum shuttle speed, and
 - Var—Starting from a pause condition, the first 360 degree forward rotation of the Jog knob scales play speed from zero to 1.0, then the next 360 degree rotation scales between 1.0 and 3.0, the maximum.
- Load—Loads selected clip to delegated device.

Kayenne Delegation

Delegation permits a single group of buttons and knobs to control a large number of identical system functional areas, or objects. Delegation connects a group of controls, to a particular object. Delegation makes it possible to control many more system functional areas than would be possible using dedicated, single function Control Panel buttons.

M/E Delegation

Any stripe can control any M/E, delegation can be saved in Panel Memory.

DELG Button

The light blue **DELG** button on any Local E-MEM Module puts that module into Panel Delegation mode and displays M/Es delegated to the suite in rows that correspond to the top to bottom Stripes on that Control Panel. Current M/E selections are high tallied with the defined M/E color. Pressing the button for an M/E or PGM PST M/E delegates the corresponding Stripe to the selected M/E. The same selection can be made on more than one row.

Note: Only those M/Es for which physical M/Es have been assigned to the suite are displayed in Delegation mode on the Local E-MEM Module.

If the Control Panel has fewer than four Stripes, then only rows for those Stripes present will be shown. If the Control Panel has more than four stripes, then pressing the **Page** button on the Local E-MEM Module will show the M/E delegations for those additional Stripes.

Exchange ME

The **Exchange ME** button (see [Transition Module](#), on page 159) allows you to delegate M/Es that are not assigned to a Stripe. For example on a 4.5-M/E Kayenne system with four Stripes, the fifth M/E can be 'exchanged' with a currently delegated M/E on that Stripe by pressing the Exchange ME button. The function is global for all Stripes, i.e. if M/E-4 is unassigned, pressing the Exchange ME button on the current PGM PST Stripe assigns M/E-4 to that Stripe and PGM PST is available for exchange (delegation) on each Stripe's Exchange ME button.

For Kayenne systems with more than one additional M/E than available Stripes, an M/E can be preassigned to the Exchange ME button by holding down the button and selecting the M/E for exchange on the Local E-MEM Module. Only one M/E for exchange can be assigned at a time.

The Exchange ME button displays the color of the unassigned M/E. For the example above with PGM PST and M/E-4, when PGM PST is red and M/E-4 is purple, after M/E-4 is exchanged with PGM PST the Exchange ME button changes from purple to red (for each Exchange ME button on all Stripes in that suite).

Automatic Delegation

With the ADeI button toggled on in the Multi-Function Module, when an operator activates any object on a Stripe, the Multi-Function Module will automatically delegate to control the specific object involved. For example, selecting a key for the next transition, automatically delegates the other modules in that Stripe, and the Multi-Function Module to control that keyer. Automatic delegation only occurs when the operator presses a button on a Stripe, and does not occur if the panel's state is changed by an external interface, like an edit controller.

Automatic delegations can be quickly disabled at any time on the Multi-Function Module by toggling the ADeI button to off.

Multiple Keyer Delegations

The M/E Keyer Delegation buttons on the Multi-Function Module can delegate the Keyers, Mattes, and Masks to more than one keyer. If the Multi-Function Module's controls have been delegated to multiple keyers, the Multi-Function Module delegation buttons will go off, to indicate a single keyer is not being controlled. The remaining Multi-Function Module buttons can only display status for one of the keyers (the first one pressed). Any changes made will be applied to all the keyers involved. Any context sensitive delegation inside the Multi-Function Module will be based on the first keyer selected. For example, if Key 1 is a Chroma Key and Key 2 is a Preset Pattern, adjusting Clip should change the clip for both Key 1 and Key 2. However, since Key 2 does not use Clip (being a Preset Pattern) it is unaffected. The size of the Preset Pattern will not change.

Similarly, in the Source Select Module, you can select and hold down multiple keyer delegation buttons, then select a source, and that source will be selected for all keyers in the selection. The multiple selection is applied to the Multi-Function Module.

DPOP and SPOP Menu Delegation

DPOP stands for Double Press Open. This is a form of automatic delegation where a specific menu is displayed on the Menu Panel when a panel button is pressed twice in rapid succession. A menu can contain controls that do not exist on the Control Panel. DPOP makes these additional menu controls readily available. If further delegation exists within the menu, for example to a specific keyer, that delegation occurs as well. If the menu is already open, a single press performs the menu delegation (a second button press is not required).

SPOP stands for Single Press Open. SPOP buttons operate similar to DPOP, but only a single button press is required.

DPOP Buttons with Menus

DPOP Button	Module	Menu
Key 1,2,3,4,5,6	Source Select/Multi-Function	Keyer, Mode (selected keyer delegated)
Macro	Source Select/Local Aux	Macro, Catalog
Aux		Aux Delegation
Rtr		Router Assign
Pri	Source Select	ME, Mode
Sec		ME, Mode
Row 1,2,3,4		Defined in: User Setups, Panel Prefs, Bus DPOP Prefs
Wipe 1,2	Transition/Multi-Function	Wipes, Patterns
User 1-6 and Key Prior	Transition	Keyer, Priority
Key 1-6		Keyer, Mode
Menu	Local E-MEM	E-MEM & Timeline, Timeline View

SPOP Buttons with Menus

DPOP Button	Module	Menu
Menu	Local E-MEM	E-MEM & Timeline, Timeline Edit

SPOP Buttons with Menus

DPOP Button	Module	Menu	
Szl c	Multi-Function (for iDPM/eDPM MFM menu delegations)	iDPM/eDPM, Transform	
3dLc			
ROT			
SPIN			
Axis			
ASPT			
SCEW			
PGLB			
SGLB			
Sngl			Events List
MULT			Device Control
ME-1,2,3,4, and PGM	System Bar	User Setups, Suite Prefs, Safe Title, Prefs	

Many, but not all of the 'hard' buttons (with legends) supporting DPOP on the Modules are indicated with two triangles on the lower right of the button legend.

Menu Panel and Touch Screen Overview

The Menu Panel includes a touch screen display, five knobs for adjusting parameter values, and four USB ports (two on the right side edge of the panel and two on the back for keyboard and mouse (wired or wireless are supported)).

The GV Korona has a built-in multi-touch screen with additional joystick control functionality.

Touch Screen

CAUTION: : Do not apply any sharp or rigid object (no pens or pencils) to the touch screen display surface.

The Menu Panel touch screen allows direct interaction with menu controls displayed on the screen. The screen is designed to work with a finger or other soft object. The touch screen is sensitive to a single pressure location only, so only one touch surface control can be adjusted at a time.

Menu Selection

Various GV Switcher system operating menus are selected using the menu buttons at the bottom of the Menu Panel touch screen. When a menu is accessed, it is initially displayed in the state it was in when last used.

Soft Knobs

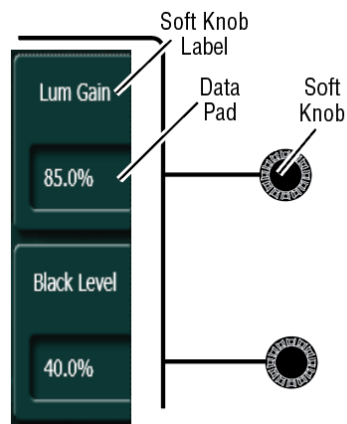

Knobs along the right side of the Menu Panel can be used to dial in parameter values for functions displayed on the touch screen. When a knob is active, the touch screen displays the parameter name and its current value on a data pad. The parameter can be adjusted by turning the knob, or the data pad can be touched to bring up a numeric keypad.

Data Pads and Touch Buttons

The GV Switcher system menus make extensive use of data pads. Data pads are active areas on the screen that display a summary of the status of an object, and when touched bring up additional controls and information for that object. For example if the data pad for ME-1, Keyer 1 in the Keyer Mode menu is selected, the selection causes the rest of the screen to display settings and controls for that keyer. A special pattern data pad also exists, which displays the shape of the current pattern (the square shape). Touching this data pad brings up a wipes palette, from which wipe pattern generator shapes are selected.

Touch buttons are labeled by their function and do not display data. Examples of touch button functions include selecting an operating mode, or turning on an attribute. Touching these buttons will immediately activate their function. Touch buttons can control on/off functions, and have an indicator on the left side, or they can select from a group of parameters, and turn light blue to indicate the state of that parameter.

GV Korona Menu and Joystick Control

GV Korona Transform Engine Menus indicate joystick control of menu parameter values, with colored text and dots on the soft knob data pads.

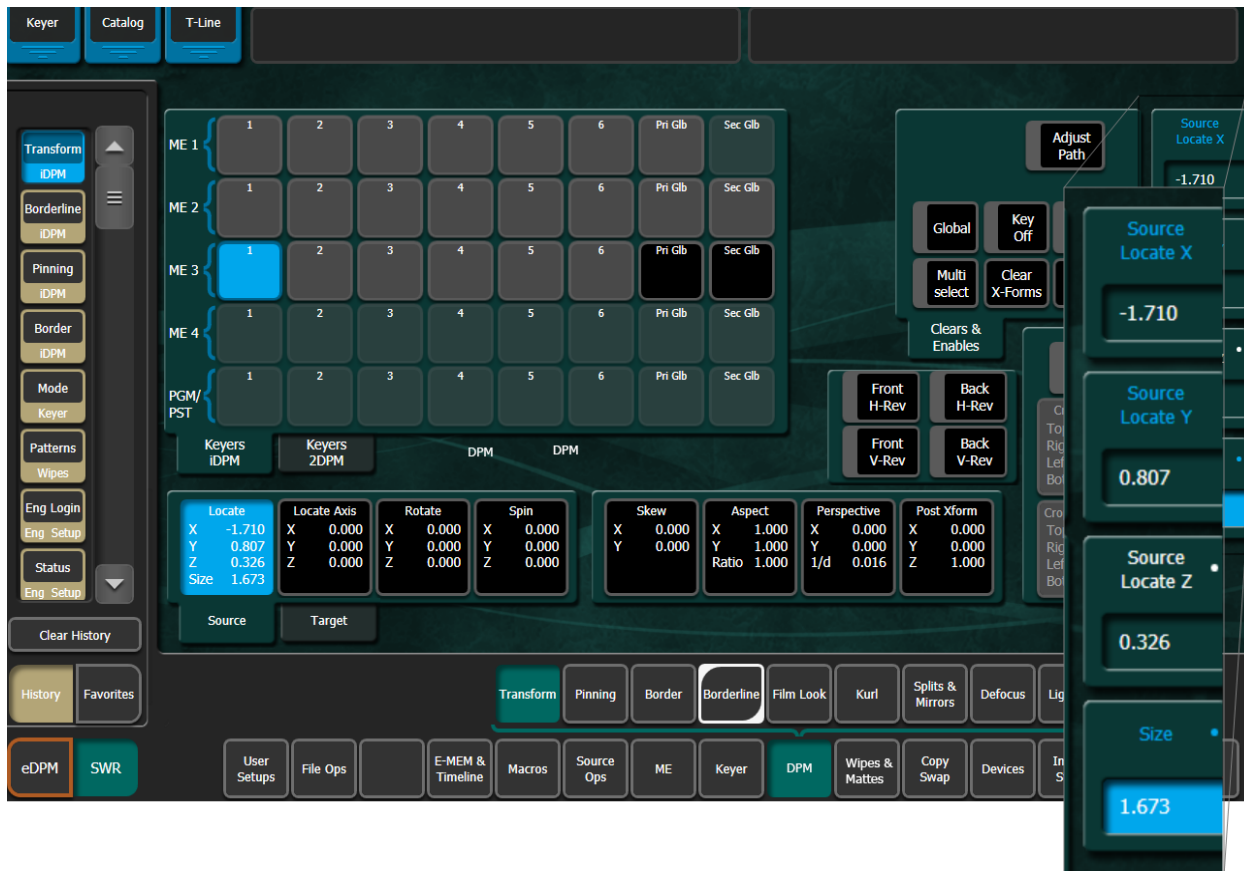

- Blue text indicates the parameter is under joystick control and moving the joystick will change the values for that parameter.
 - White text with a white dot indicates the location values can be selected for control by the joystick (when selected, the white dot/text turns blue).
 - A blue dot (with blue text) indicates that the parameter is selected and moving the joystick will change the values.
- 1 To select a parameter for joystick control (white), select any data pad with a dot and press the soft knob for that data pad; text and dot turn blue.
 - 2 Move and turn the joystick to change the parameter values for all parameters with blue text.

Menu Screen Organization and Components

GV Switcher system menus are context sensitive. They display different information and provide various types of controls depending on what area of the system is involved.

Backgrounds vary for each menu type:

- Green for User

- Red for Engineering
- Light Brown for e-DPM (optional)

For clarity, the menu screen examples are divided into two areas:

- Navigation and
- Content and Messaging

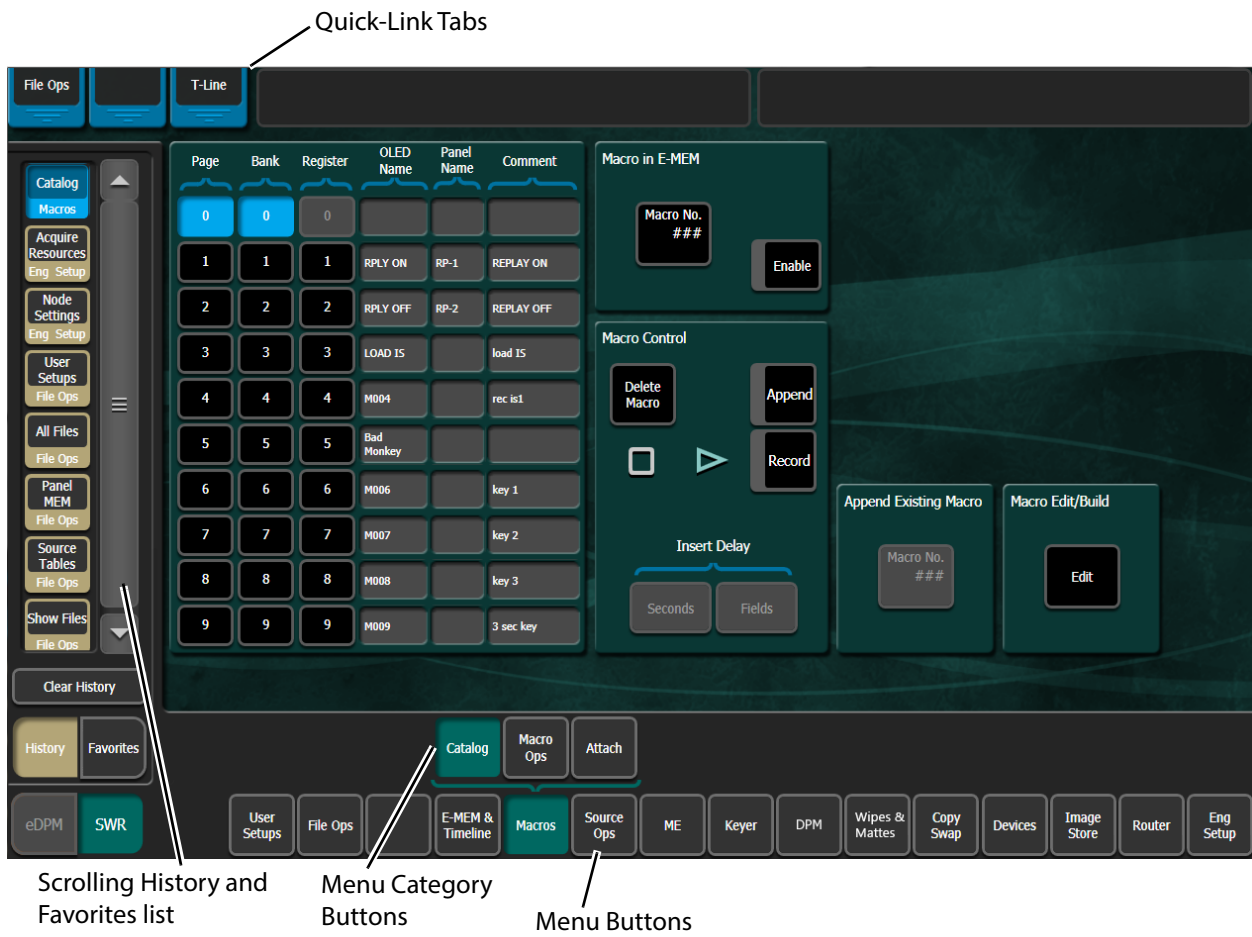

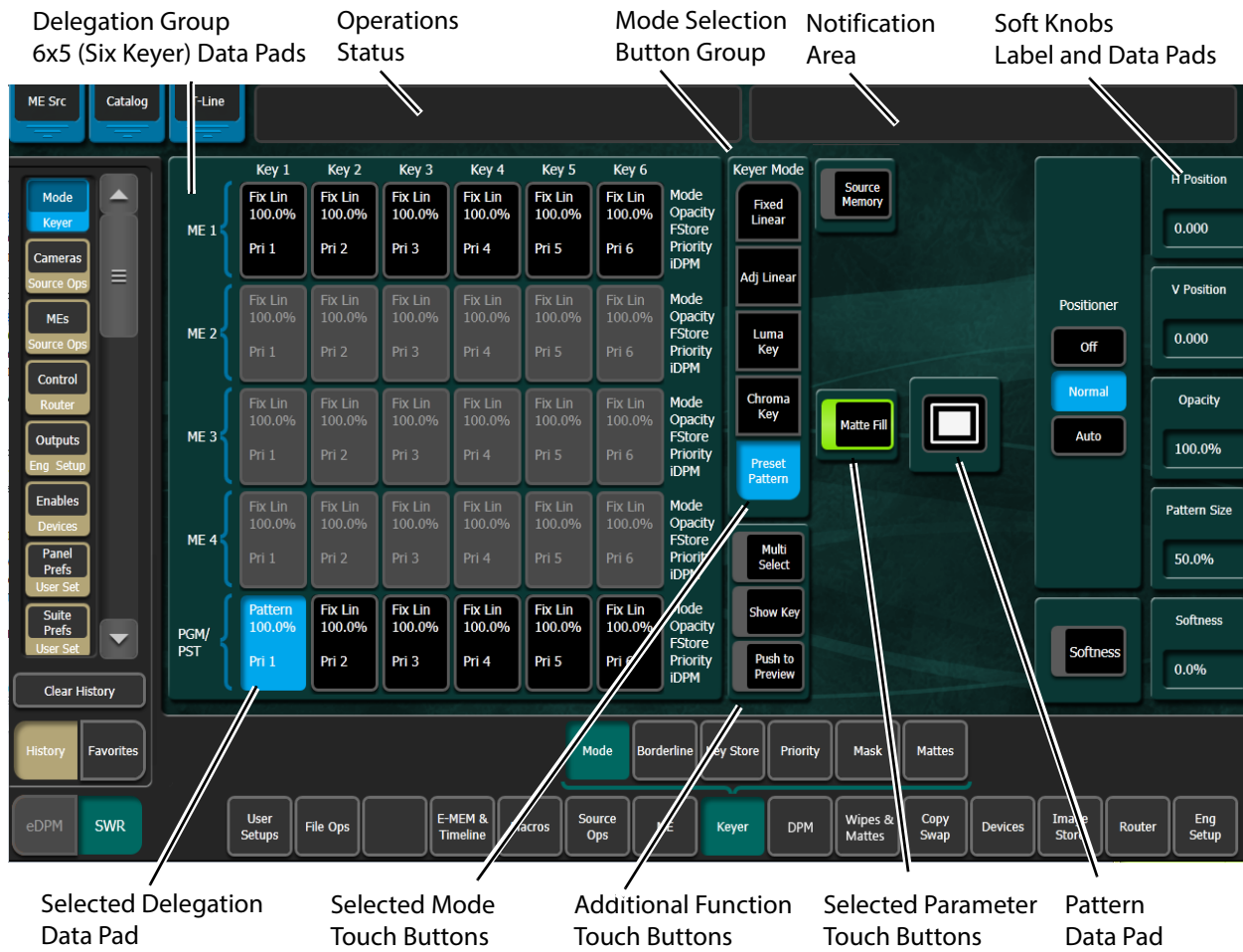

History Mode

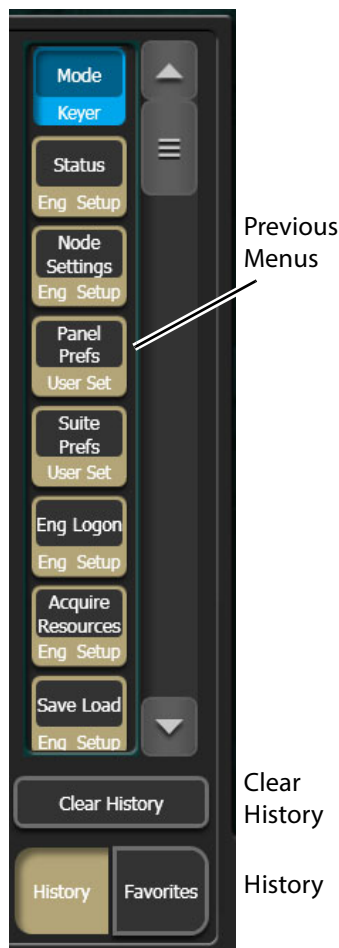

When the **History** mode touch button is selected, up to 45 previously visited menus can be quickly accessed by clicking on the representative menu icon. The scrolling menu icon window can be cleared by selecting the **Clear History** touch button (left side of menu).

History menu icon buttons appear light brown and black until selected, then change to blue.

Use the scroll bar to see more History menu icon choices.

Favorites Mode



When the **Favorites** mode touch button is selected, up to 10 pages of 12 menu icons each can be stored to quickly access often visited menus, or sets of menus for repetitive tasks (left).

Favorites menu icon buttons appear light green and black until selected, then change to blue.

Use the **Left** and **Right** arrows (bottom-left) to navigate through Favorites pages.

To create a Favorites list, perform the following steps:

1 Choose a Favorites page (1-10), using the Left and Right menu arrow buttons.

2 Navigate to the menu to be added to the list.

3 Select a grayed out or existing menu icon from the two side-by-side rows of six you wish to create (a previously learned icon can be overwritten).

4 Touch the **Learn** button.

To clear a Favorites page, select the **Clear Page** button (bottom-left).

Creating a Last Menu Assignment in Favorites Mode

In Favorites mode, you can create a **Last Menu** icon button so you can return to the last menu of your choosing.

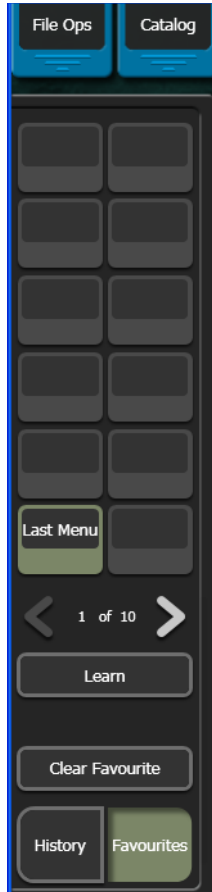

1 Touch the **Favorites** button.

2 Touch the **Learn** button.

3 Touch a favorite button on any page 1-10.

Result: The button changes to the Last Menu icon.

Quick Tabs

Quick tabs provide fast access to related menus in addition to the History and Favorites mode. Each tab with a label provides a semi-transparent, predetermined menu that appears over the current menu when touched to allow fast access when performing operations like setting parameters, selecting delegations, choosing functions, etc.

Click on the tab, upper left of the menu, to open the Quick Tab, the tab moves to the bottom. Click in another menu, where the tab was, or on the tab a second time to close it.

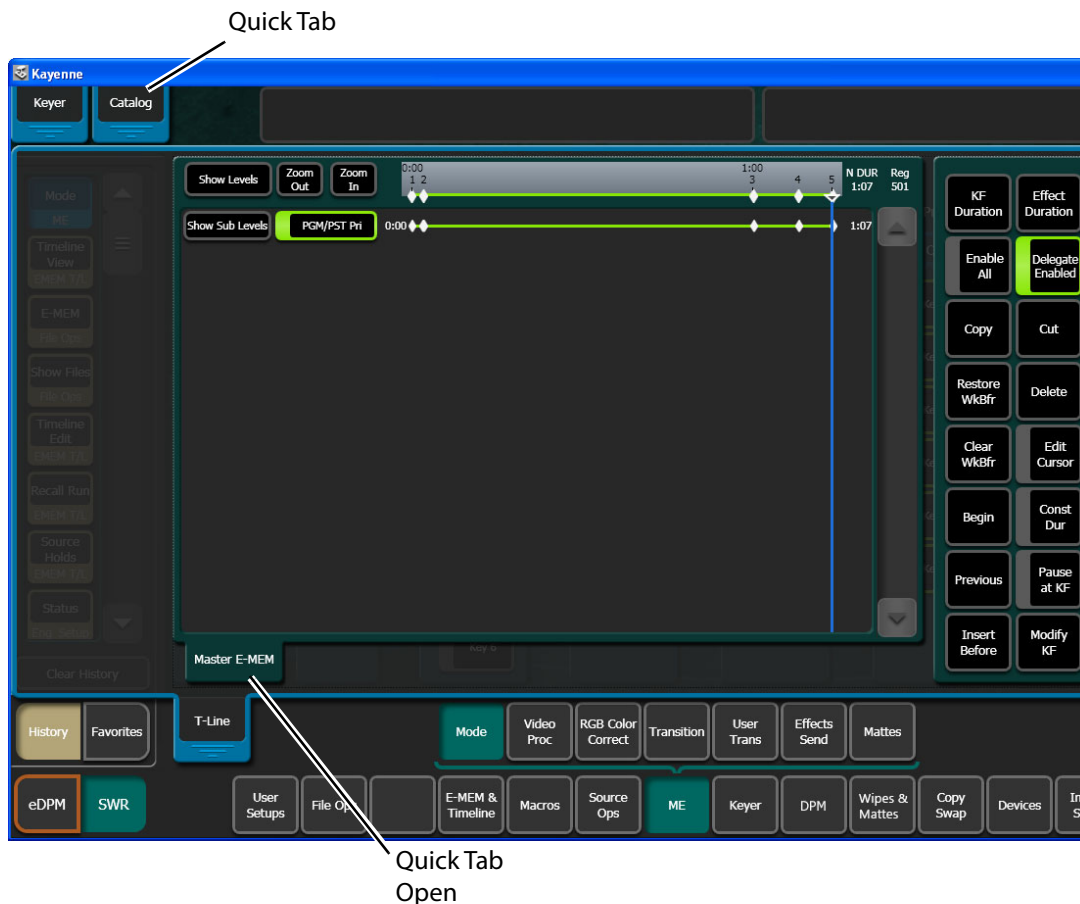

The top line is identical in all the GV Switcher system menus:

- The left portion of the top line has three Quick Tabs,
- The center portion of the top line displays operations status messages, and
- The right portion of the top line is an operator notification area, where messages generated by the GV Switcher system are displayed.

Delegation Group

Additional levels of delegation are needed in some menus, like the Keyer menu for example because it must control all keyers. This highest level of delegation is located on the left side of the menu as a grid of data pads. Data pads display limited status for a particular object. Touching a data pad delegates that object, and the rest of the menu will then display information and controls for only that object. The data pad of the selected object is colored light blue.

Parameter Control Area

A Parameter Control area contains function selection buttons and soft knob pads for the selected operating mode. Function selection buttons either toggle on and off or are part of an interlocked group. The soft knob pads on the right allow individual parameter adjustments, as described earlier.

Numeric Keypad

Touching a soft knob pad or other single numeric parameter pad brings up a numeric keypad that can be used to enter exact values. You can also use a standard computer keyboard to enter information while this display is active.

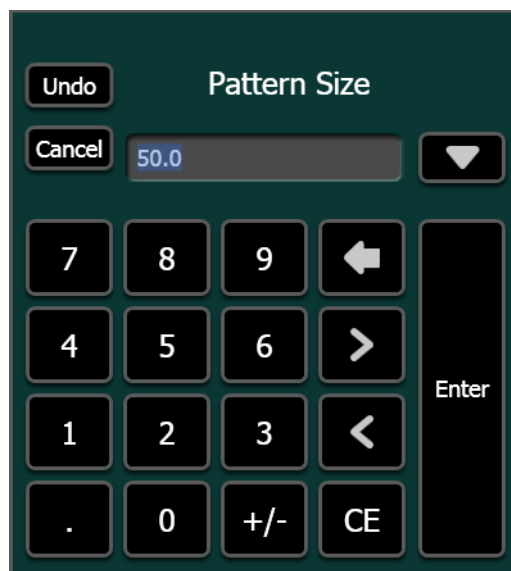

Alphanumeric Keypad

Touching the pad for a text parameter brings up an alphanumeric keypad. You can also use a standard computer keyboard to enter information while this display is active.

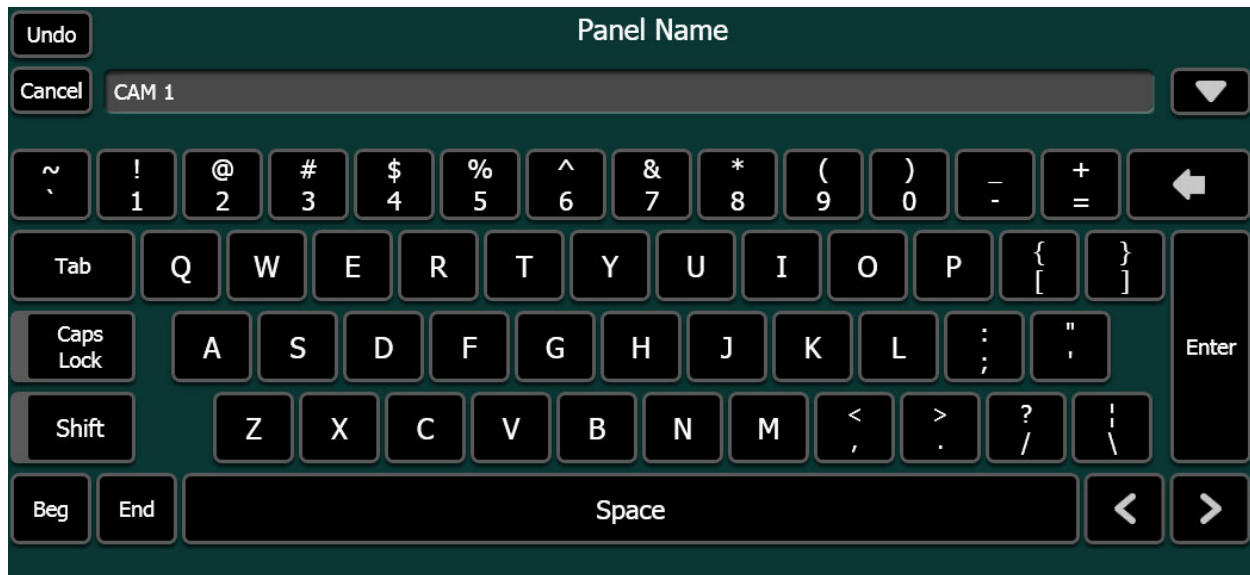

Scrolling Lists



When multiple items are available for selection, scrolling lists are used. On most menus, touching the up and down triangle buttons scrolls the list up or down one item. When the top or bottom of the list is reached, that button goes gray. Touching the green area above or below the white handle scrolls the list up or down one group of items. You can also drag the white handle to quickly scroll through the entire list on some menus.

Some menus have two scrolling lists, used to associate an item in one list to an item in the other list. Typically you choose an item on the left list, and the system automatically selects the item currently associated with it on the right list. You can then choose a different item from right list to change the association.

Some of these menus have a Lock button for the right list. This prevents that list from scrolling to the currently associated item when an item on the left pane is selected. This does not prevent the selection of the associated item, but just keeps the list from

scrolling. This allows you to quickly make multiple associations for items arranged near each other on the lists.

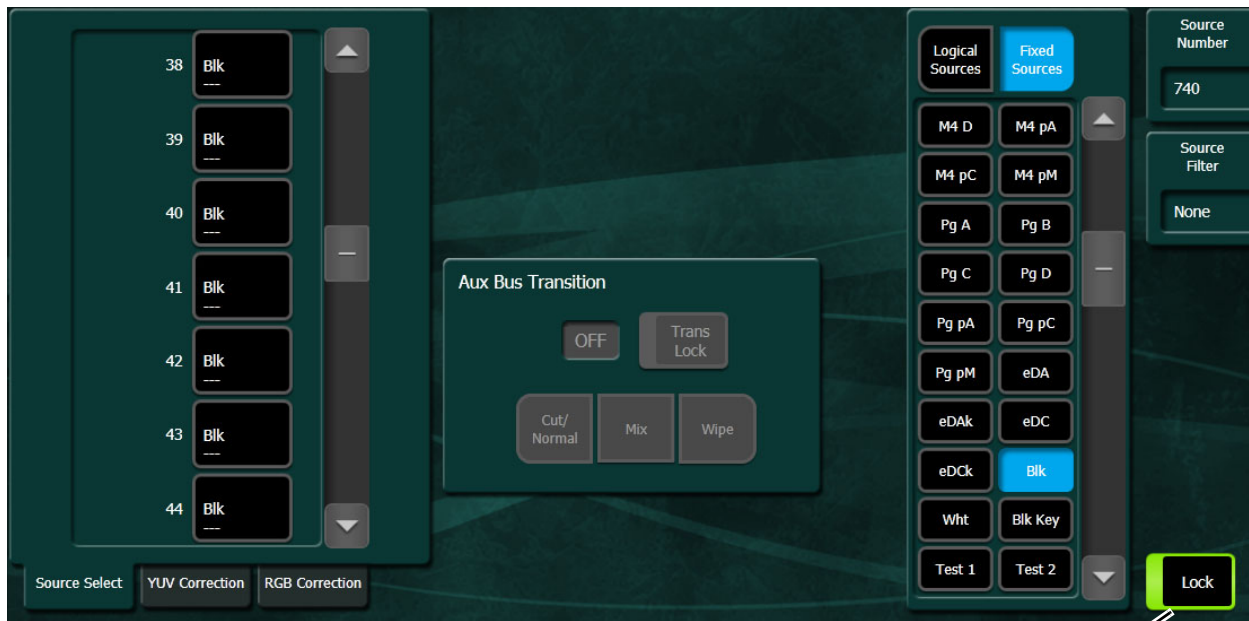

Lock On

Menu and Panel Interactions

The Control Panel and Menu Panel operate as a single control surface, and so these components interact with one another. Many controls on the Control Panel are duplicated on the Menu Panel screens. For example, a keyer can be set to use a Chroma key with a Control Panel button or a menu button. Other controls are only available on the Menu Panel.

Double Press Open (DPOP) and Single Press Open (SPOP) are convenient ways to access related menus when working on the Control Panel. Double pressing or single pressing certain buttons bring up particular menus.

Once that menu is displayed, delegation changes affecting that menu that are made on the Control Panel will be tracked on the Menu Panel. For example, if ME 3 Key 1 is selected on a menu, and then ME 3 Key 2 is selected on the Control Panel, the menu display will change its delegation to ME 3 Key 2. However, the reverse is not true. Changing delegations on the Menu Panel does not change Control Panel delegations.

When both the Control Panel and the Menu Panel are delegated to the same object (say, ME 1, Key 1), changes can be made to that object from either panel. Once the change occurs, both panels will be updated to reflect the status of the object. Both panels do not need to be delegated to the same object to enact a change, however. Suppose the Control Panel is delegated to control ME 1, Key 1 while the Menu Panel is delegated to ME 2, Key 2. Changes made on the Menu Panel will affect only ME 2, Key 2, and changes made on the Control Panel will affect only ME 1 Key 1. When the delegation of either panel is changed to a new object, that object's current status (which may have been changed since last shown) will be reflected on that panel.

Transitions

A transition is a change from one image to another. The GV Switcher system supports three types of transitions:

- Cut
- Mix
- Wipe

A transition can be applied to the entire picture, or to only the background or keyed elements of the picture, and can include multiple elements.

M/E and Aux Panel transitions can be performed on the GV Switcher Control Panel. Transitions are also possible from the M/E, Transition menu.\

Wipes

A wipe is a transition from one picture to another in which the edge of a shape moves across the screen, revealing the new picture. Wipe transitions can be applied to backgrounds, to keys, or to both simultaneously. A wipe transition shape can be selected from a variety of patterns, and these patterns can be adjusted in several ways (position, aspect ratios, edge attributes, etc.).

Each M/E has two separate wipe systems, each of which can be assigned a different wipe pattern and be adjusted independently. These systems can each use one of the two available complex wipe pattern generators with advanced capabilities. It is also possible to combine these wipes to create extremely complicated wipe transition shapes, and generally this is used only by advanced operators. Utility bus video signals can also be used to generate a custom pattern for a wipe transition or other purposes.

Other Wipe Pattern Generator Uses

Wipe pattern generator circuitry can be used for purposes that do not involve transitions. Each M/E has the two complex wipe pattern generators described above, and each of its four Keyers also has a simple pattern generator and a box pattern generator, making a total of six. These pattern generators can also be used for Preset Pattern, Masking, and Matte Washes.

4K SDQS Wipe Limitations and Supported Wipe Patterns

It is recommended that in 4K SDQS (Square Division Quad Split) Frame Operating Mode, wipe transitions should be previewed before taking them on-air. Wipes and supported wipe patterns can be used in 4K but there are some limitations. For example, when moving some wipe patterns:

- Horizontally more than +/- 16,
- Vertically more than +/- 23), or,
- X or Y more than +/- 14

may result in on-screen artifacts or anomalies.

Modulation, Multiply, and Horizontal Split functions are not supported. Rotation can be used successfully with most of the wipe patterns but may cause issues with others so it is best to preview the pattern with Rotation before taking it on-air.

For any wipe pattern, position, rotation, and size for a preset pattern or transition percentage for a transition can interact and sometimes have an unexpected appearance. Therefore, it is important to preview the settings for a wipe before taking it on-air. If the preview of the wipe settings shows the desired behavior, the wipe will consistently perform as expected with those settings.

Note: Horizontal and Vertical Modulation will work if the keyer is contained to one quadrant of video.

Most wipe patterns available in the HD modes are available in 4K mode.

Note: Unsupported wipe pattern buttons are not grayed out in the GV switcher menu in 4K Mode.

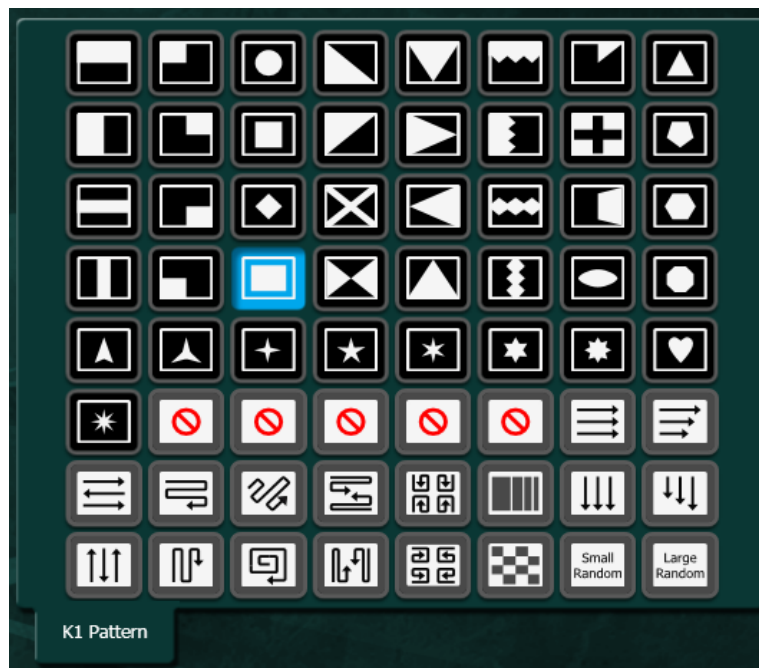

Kayenne Transition Module

Kayenne Manual Transitions

Manual transitions are preset with the next transition element buttons. Any elements that are active when a transition is performed will change state. Active keyers will transition from on-air to off-air or vice versa. Background transitions will occur between the A and B buses with a flip flop at the end of transition, ensuring the A bus is always on-air and the B bus is off-air when a transition is not in progress. Any element not selected in the next

transition element group retains its current state. Combinations of elements can be included in the same transition by selecting more than one transition element button.

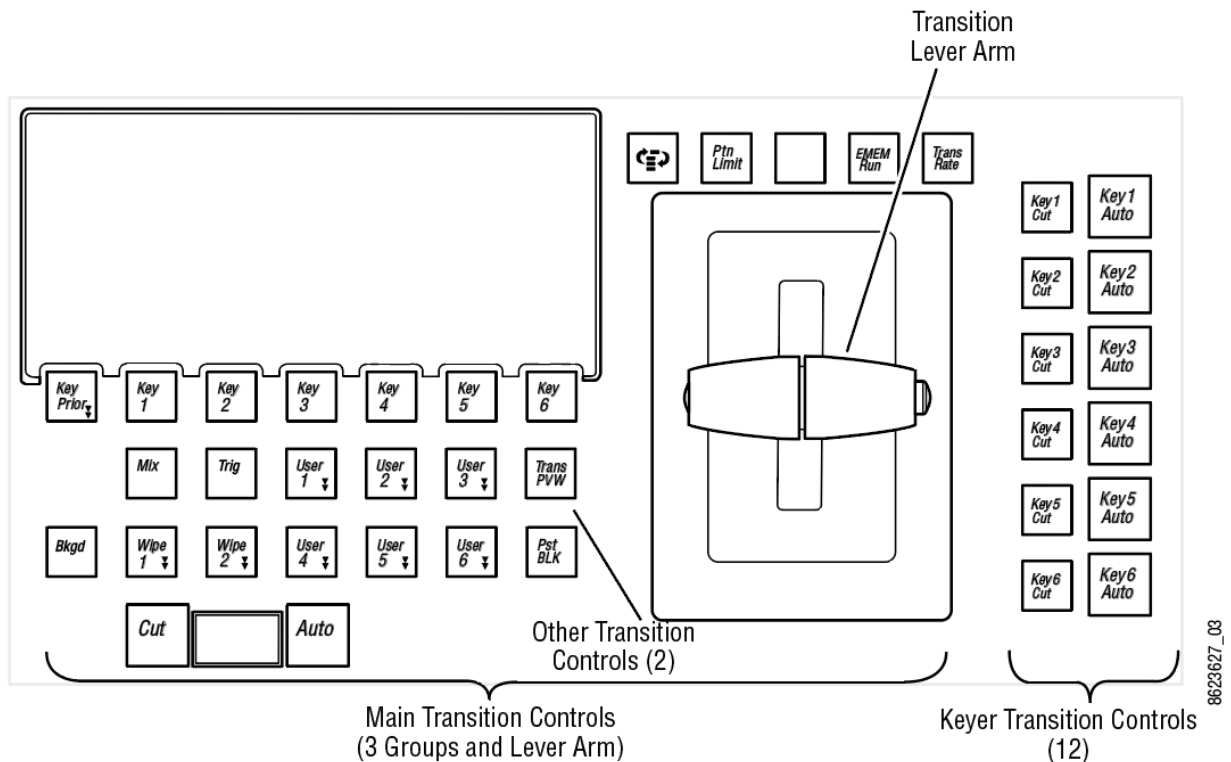

Transition Module

Perform a Lever Arm Transition

- 1 Select the next transition button(s) for the element(s) involved (**Bkgd**, **Key 1,2**, etc., **Key Prior**). Selecting one element button disables any others selected. Holding down one button while pressing another selects both elements, allowing all the transition elements to be activated if desired.
- 2 Select the type of transition (**Mix**, **Wipe 1/Wipe 2**, or **User Transitions**).
- 3 Select any new sources involved in the transition:
 - If performing a background transition, select the new source to transition to on the B bus.
 - If you are transitioning in a new key, select that new source on the key bus.
 - If you are changing key priority, specify a new key priority in the Keyer Priority menu.
- 4 If desired, select a transition modifier (Trans PVW or Preset Black).
- 5 Move the transition lever arm. The picture will transition only the elements selected. Other elements will remain unchanged.

Perform an Auto Transition

- 1 Setup for an Auto Transition is the same as a lever arm transition ([Perform a Lever Arm Transition](#), on page 193) with the following added step:

- Specify the duration of the transition by turning on the **Trans Rate** button, selecting the flashing button of the desired element, and entering a value in <seconds> • <frames> • <field> format ([Time Value Entry](#), on page 109). Different durations can be specified by repeating this process for each element.
- Press the **Auto Trans** button. The picture will transition only the elements selected at the specified rate(s). Other elements will remain unchanged.

Perform a Mix Through Video Transition

One common application of a Mix Through Video transition is to add a white flash to simulate a photographer's flashbulb. To set up a simple white flash effect do the following:

- In the ME, Mattes menu, select the ME for the transition (left pane).
- Select the Base Color data pad (right pane).
- Set the Brightness to 100% and the Saturation to 0% with either the soft knobs or the popup keypad to create a white matte. The matte will appear in the Base Color box.
- Go to the ME, User Trans menu and select the User Trans Mix Through Matte (1-6) button.
- In the ME, User Trans menu, select the Full Screen button under 'Intermediate Video Appears' to create a full raster effect.
- Change the **Initial Mix Ends at** to a lower number to sharpen the slope of the mix from the initial to the intermediate video.

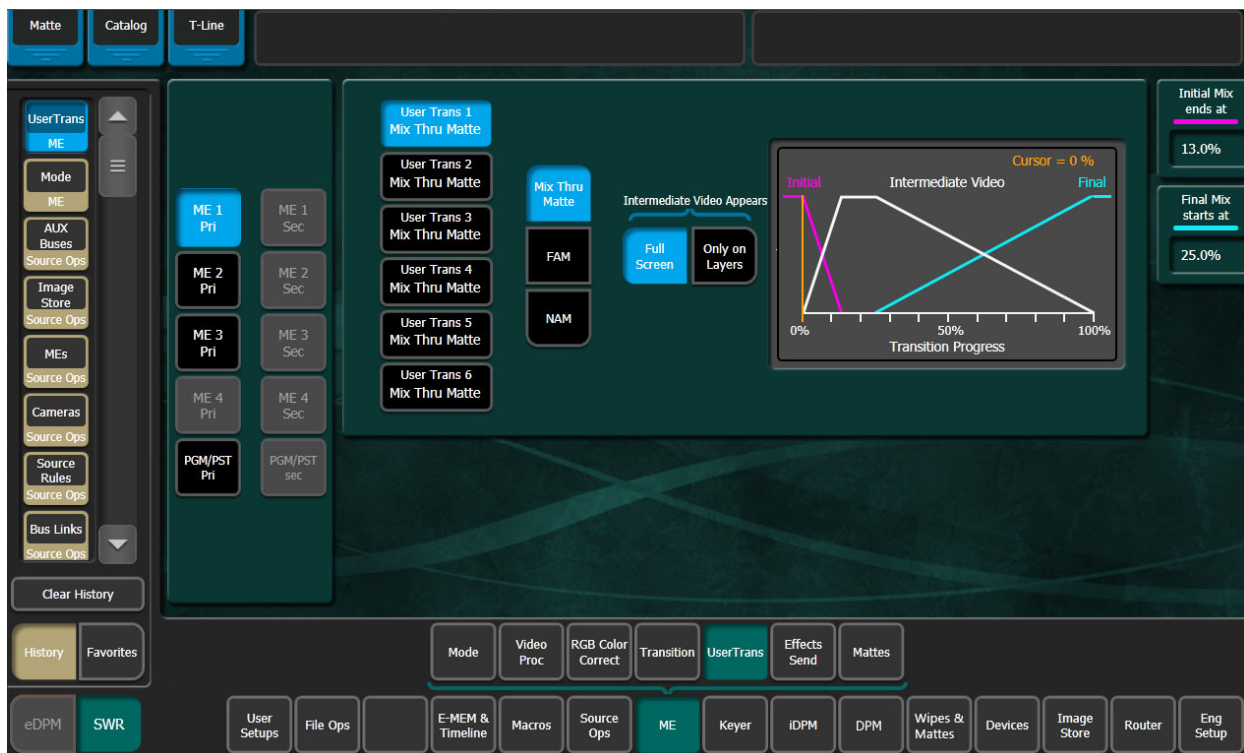

Camera Flash Mix Values

- 7 On the Control Panel, select a video source on the corresponding ME A bus and a different video source on the B bus to transition to.
- 8 Select the User Transition button you assigned earlier in the Transition Module. For a simple white flash between sources, select a **Bkgd** transition only (no key).
- 9 Use the Transition Lever Arm to run the white flash transition. Alternatively you can set the Transition Rate in the Transition Module to a fast rate to enhance the flashing effect, then press the **Auto** button to perform the transition at the specified rate.

You can experiment with various different programmed values to vary the appearance and timing of the effect.

NAM and FAM Mixed Transitions

Non Additive Mix (NAM) and Full Additive Mix (FAM) are special mix transitions in the GV Switcher system.

NAM transitions pass only the brightest regions of each picture to the output. During the first half of a NAM transition the original picture retains its original intensity while the next picture mixes to full intensity. Brighter areas in the new picture replace any corresponding darker areas of the previous picture. During the second half of a NAM transition the previous picture mixes out of the darker areas of the new picture. FAM transitions also first fade a new picture to full intensity and then fade the old picture out, but both full intensity pictures are mixed together to the output during the transition. The resulting signal is clipped at white level to prevent generating illegal video.

Ramping characteristics can be adjusted which allows the full mix point to be achieved at a preselected point in the transition. This can be useful when dissolving to and from animated transitions which have high luminance values.

Select **ME, User Transitions**. Select the **FAM** or **NAM** menu button.

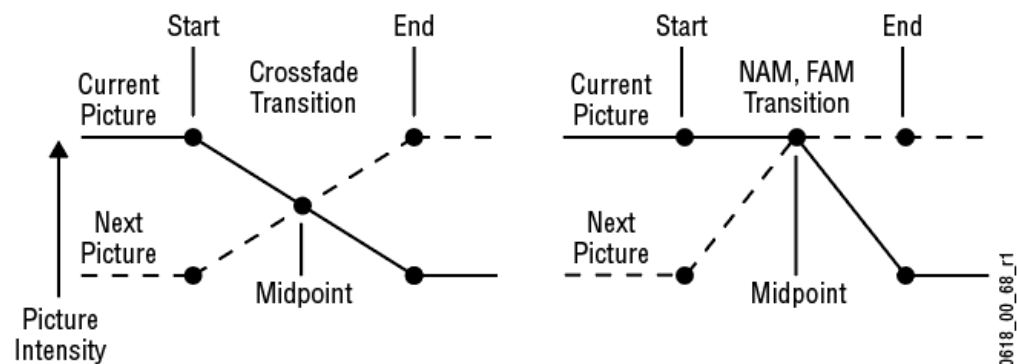

Normal, NAM and FAM Mixes

Aux Bus Transitions

You can perform Aux bus transitions and mix or wipe between sources on an Aux bus. GV Switcher allows you to use one or more M/E partitions to perform mixes or wipes on multiple aux buses (including "Controller M/Es").

To perform a mix, a wipe, or a mixture of both transition types for a show, you will need to allocate M/E resources in the User Setups, Suite Prefs, Resource Allocation menu.

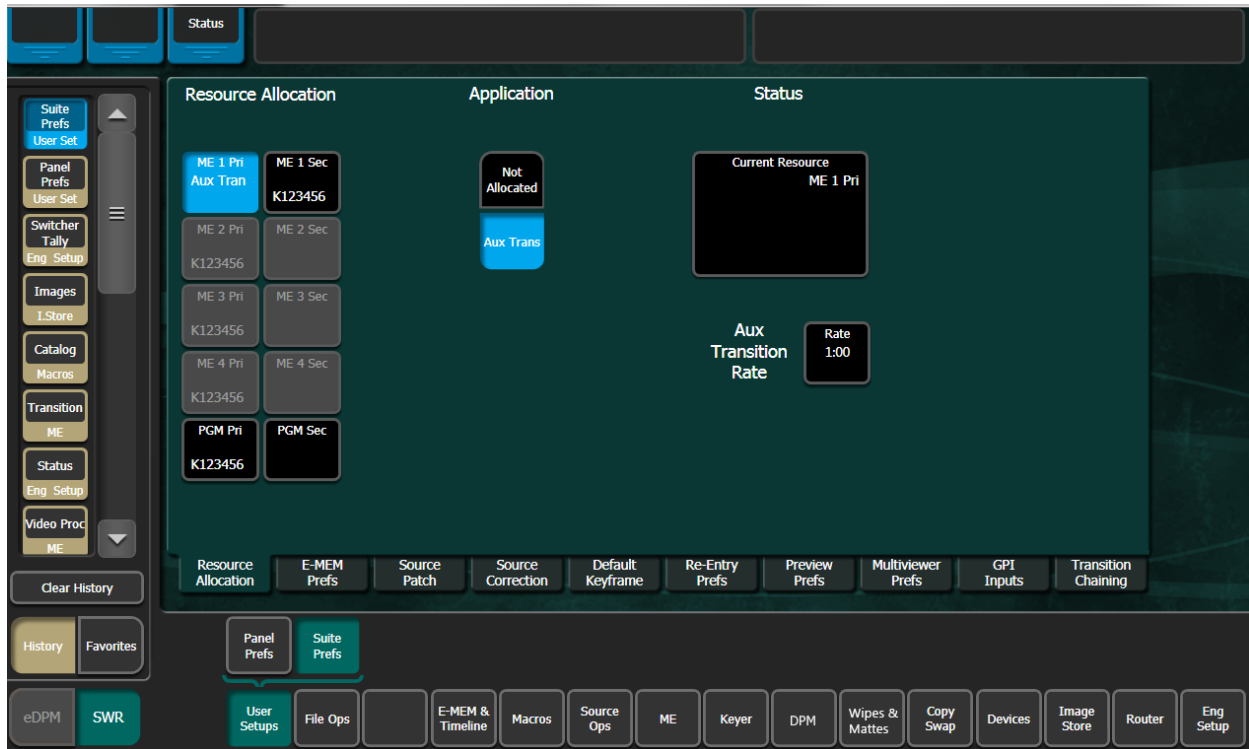

Trans Lock Button

The **Trans Lock** button in the Source Ops, Aux Buses menu allows you to lock the selected mix or wipe as the transition type for the selected aux bus (repeats when a source is taken on that aux bus). By turning on the Trans Lock button, the transition will continue to mix or

wipe until it is deselected. With the Trans Lock button off, a mix or wipe will only transition once and then reset to a cut (cut is the default setting for an aux bus).

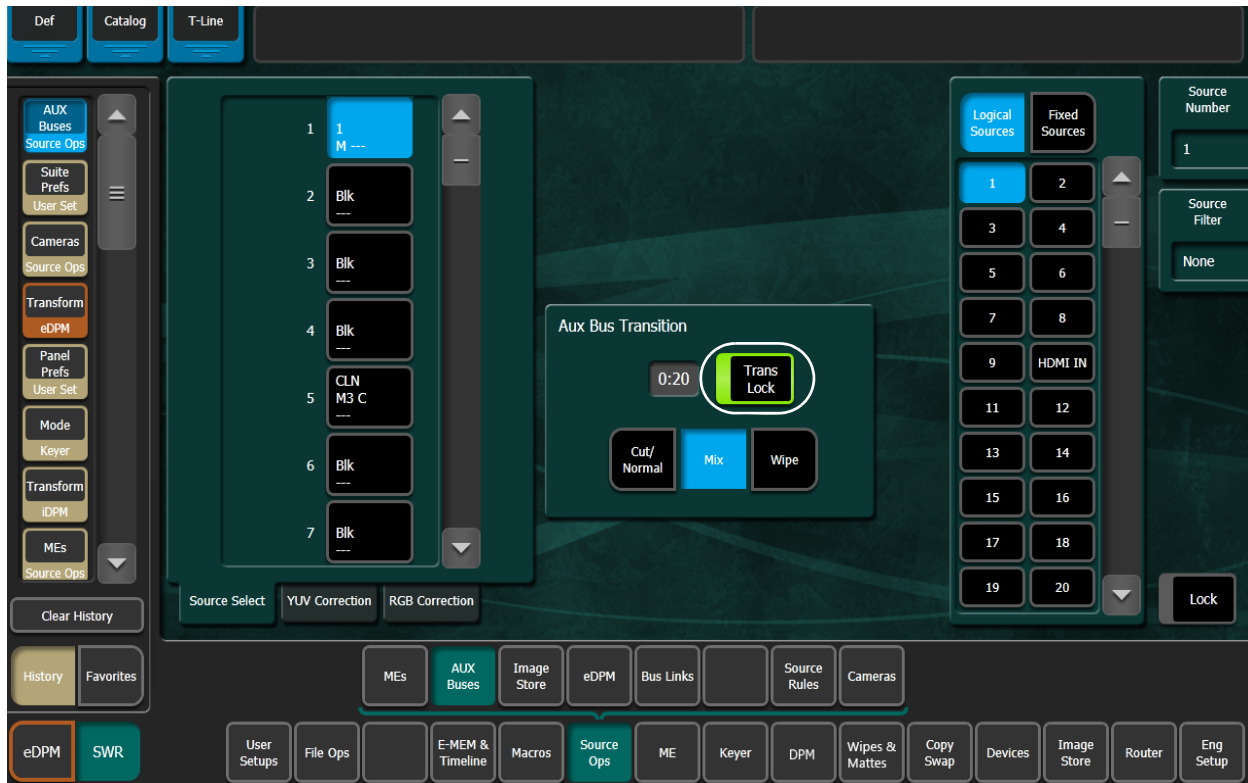

Setting Wipe Transition Parameters

- 1 Go to the Wipes menu in the GV Switcher menu or press the Wipe button in the Multi-Function Module and set the wipe parameters for the M/E(s) you will use for the aux bus.
- 2 Select the wipe pattern to be used.

CAUTION: : When two partitions or more are released for aux bus wipe transitions, it is very important to make all wipe parameters the same because the dynamic assignment of M/E partitions will not guarantee that an allocated partition will supply the transition resource for a specific aux bus.

Allocating Resources and Setting up the Transition

Note: The DoubleTake option is required for Aux bus transitions.

Aux bus transitions use the allocated resources only during the transition. Any Aux bus can then use the resource as it frees the resource after the transition.

When resources are allocated, the ME Mode menu still allows for the keyers to be used on the resource. If keyers are cut on they will only be visible on the Aux bus during the transition.

To allow both mix and wipe transitions, release the partition of a full M/E in the User Setups, Suite Prefs, Resource Allocation menu. For mix-only, you can release and allocate a Controller M/E resource.

Aux bus transitions can be recalled in a macro but are not E-MEMable, however the macro can be embedded in an E-MEM.

Perform Aux Bus Transitions

- 1 Go to the User Setups, Suite Prefs, Resource Allocation menu.
- 2 Select the button(s) of the M/E partition you wish to allocate as the transition resource for the aux bus.
- 3 Press the **Aux Trans** button in the Application column.
- 4 To change the transition rate, press the **Aux Transition Rate** parameter button, enter a transition rate in the pop-up keypad, and press **Enter**.
The **Mix** and **Wipe** buttons on the Local Aux Module are now low tally.
- 5 Select an Aux bus on the Local Aux Module.
- 6 Press the **Mix** or **Wipe** button.
- 7 Press the **Trans Lock** button if you wish the mix/wipe transition to remain selected.

The aux bus is ready for transition to the next source.

Note: If you attempt an Aux bus transition while all allocated M/E transition resources are in use, the Aux bus will perform a cut (not a transition). For example if during a long transition where allocated resources are all in use, and you switched sources during the transition, the Aux bus would 'cut' to the selected source (it would not mix or wipe).

8

Device Control

About Device Control

The GV Switcher system can control devices like ClipStores, DDRs, character generators, etc., and can also control the Image Store clips and stills and GPIs to any external device. GV Switcher device control only supports devices that have been associated with GV Switcher sources.

About Menu Application Device Control

External Devices can be controlled by the menu or the Control Panel (see [Kayenne Device Control from the Control Panel](#), on page 220, [Karrera Device Control](#), on page 234, and [Device Control with GV Korona](#), on page 235).

The Enables, Control, and Events List Device menu features include:

- ChyronHego® Click Effects PRIME and LyricX graphics support,
- Controls that change based on external device type, for example ClipStore/DDR devices use the Timecode, Even List, Program Clip, and Stop, Play, etc., while graphic devices use Activate, Scene List, Program Scene, and In and Out, etc.,
- A device manufacturer's icon (when provided) is displayed in the Device Summary point of use button for faster device identification,
- Mute for AMP Devices, and
- Device selections are saved as part of the Show file.

Enables Menu

Generally, properly configured external devices are connected by default (green status bar).



Enabling and Disabling Devices (Troubleshooting)

If devices lose communication (red status bar), you can try enabling the device(s) (Enable Selected/Enable ALL buttons) to reestablish communication or if devices are purposely off-line, they can be disabled to prevent the menu from displaying error messages. Devices must be disabled, either by selecting the Disable Selected or Disable ALL buttons or from a loss of communication before they can be enabled.

Note: ClipStore devices are enabled/disabled in the Eng Setup, Node Settings menu only.

Timeline Events Menu

The Timeline Events menu allows you to learn selected external device control commands along an E-MEM timeline (see [Control an External Device Using Timeline Events and E-MEM](#), on page 212). The controls change based on the type of device selected.

ClipStore/DDR External Device Types

When a ClipStore or DDR type device is selected, those controls are displayed in the Devices, Timeline Events menu.



Devices Timeline Events Menu Buttons—ClipStore/DDR

Button	Description
Device Summary point of use	<ul style="list-style-type: none"> Select to enable Engineering name (or “Current Device” label if loaded on the Control Panel System Bar) Device name Device Type (DDR AMP, DDR AMP Serial, VDCP Ethernet, VDCP Serial, DDR Odetics, DDR BVW, VTR BVW) Status: <ul style="list-style-type: none"> Device icon (when provided from manufacturer) Device type Clip loaded Cue Time Command <ul style="list-style-type: none"> Play Stop Gang Enabled/Disabled Loop Enabled/Disabled Connection status bar
Load	Load enable, select data pad for folder and clip file operation menu
Cue	Cue enable, select data pad to enter Cue Time
Play	Play enable, select data pad to enter Play Speed

Devices Timeline Events Menu Buttons—ClipStore/DDR

Button	Description
Stop	Stop clip
Gang Enable	Gang enable, select data pad to choose device from Gang Device Picker
Gang Disable	Disable Ganging
Loop Enable	Enable Loops
Loop Disable	Disable Loops
Clear Delegated Device Events	Clears enabled buttons, data pad entries, and loaded clips for the selected point of use (Device Summary)
Clear All Events	Clears enabled buttons, data pad entries, and loaded clips for all Device Summary point of use buttons
Device	Device search, select data pad to enter device ID

ChyronHego® Click Effects PRIME® and LyricX®

When a ChyronHego® Click Effects Prime/LyricX device type is selected, those controls are displayed in the Devices, Timeline Events menu.

Note: Gang and Loop buttons are not used and grayed out for Click Effects PRIME and LyricX, however they will be available for other AMP devices.



Devices Timeline Events Menu Buttons—Click Effects PRIME/Lyric

Button	Description
Device Summary point of use	<ul style="list-style-type: none"> Select to enable Engineering name (or “Current Device” label if loaded on the Control Panel System Bar) Device name Device Type (Amp Ethernet) <p>Status:</p> <ul style="list-style-type: none"> Device icon (when provided from manufacturer) Device type Scene Cue Time Command <ul style="list-style-type: none"> Play Stop Connection status bar
Load	Load enable, select data pad for folder and scene file operations menu

Devices Timeline Events Menu Buttons—Click Effects PRIME/Lyric

Button	Description
Activate	Displays folder and scene file operations menu, activate scene for control and to identify the active scene when layered on one channel
In	Take scene
Out	Take scene off-air Note: To cue the same scene again after the Out button is selected, use the Cue To Begin button (not the In button)
Clear Delegated Device Events	Clears enabled buttons and activated scenes for the selected point of use (Device Summary)
Clear All Events	Clears enabled buttons and activated scenes for all Device Summary point of use buttons
Device	Device search, select data pad to enter device ID

About ChyronHego® Click Effects and Lyric Workflow and Layering

It is recommended that one scene be activated per channel. However, multiple scenes can be layered on one channel but it is important to note which scenes are layered, the order, and which scene is active; using the Activate button can assist in identifying each scene in the channel.

Control Menu

Control up to five devices in the Main menu tab and up to eight each in the Dev 1 and Dev 2 menu tabs. The main control channel (left), provides ganging and multiple transport controls while a subset of those controls are provided for the four channels on the right. The Dev 1 and Dev 2 menu tabs also provide a subset of the main channel controls for each control pane.



Devices Control Menu, Main Control Buttons—ClipStore/DDR

Button	Description
Device point of use	<ul style="list-style-type: none"> Selection displays Device Picker Engineering name Device name Status: <ul style="list-style-type: none"> Device icon (when provided from manufacturer) Connection status bar
Time Code	Enter Time Code in pop-up keypad; 00:00:00:00 Hours, Minutes, Seconds, Frames
Event List (Active/---)	Displays 'Active' with event list loaded, opens file operations menu
Preset Clip	Displays next clip (next event list clip), opens Event list file operations menu
<>(Swap)	Swaps the Preset Clip with the Program clip, taking it on air
Program Clip	Displays on-air clip, opens Current Device file operations menu
Gang Status	Displays ganged devices when Gang Enable is highlighted

Devices Control Menu, Main Control Buttons—ClipStore/DDR

Button	Description
Gang Enable	Enable ganging
Off Air Advance	Automatically loads next event list clip to Preset Clip
Auto Start	Sets clip to play when loaded to Program Clip
Loop	Clip runs continuously, cuing the first frame once the last frame is played
Progress bar	Percentage of clip played
Record Enable	Begin recording source
Record Time	Enable record time, select data pad to enter Record Time duration
Mute	Mute clip audio for the channel
Cue To Begin	Cues to beginning clip or mark in point if set
Mark In Data Pad	Displays Mark In time code
Mark	Mark clip at current time code
Jog Back	Move back one frame
Var Play Speed	Play clip faster or slower than 100%, select to enter percentage in pop-up keypad
Jog Forward	Move forward one frame
Rewind	Rewind clip
Stop	Stop clip
Play	Play clip
Fast Forward	Advance clip at a fast speed
Swap (Control panes, right)	Exchange a clip from a Control channel (right) with the Main Control channel (left)

Event List Menu

Key controls change in the Event List menu based on the device type selected, i.e. ClipStore/DDR versus graphics devices.

ClipStore/DDR:

- Clip Browser,
- List Edit,
- Event List,
- Loaded

Graphics devices (e.g. ChyronHego® PRIME):

- Scene Browser (Current Folder/thumbnails for View List supported in an upcoming release),
- List Edit,

- Event List (thumbnails supported in an upcoming release),
- Loaded

About the Devices Event List Menu

The Devices, Event List menu provides list editing and transport controls for devices.



Clip/Scene Browser Menu Pane Buttons

Button	Description
Current Folder	Select to open Current Folder operations menu (graphic devices supported in an upcoming release)
View - List -	Select to choose thumbnail size or list view (graphic devices supported in an upcoming release)
Clip/Scene scrolling list	Selection works with Replace, Insert Before, and Insert, List Edit enable buttons

List Edit/Event List Menu Pane Buttons

Button	Description
Device Summary point of use	<ul style="list-style-type: none"> • Select to choose a device • Engineering name • Device name • Connection status bar
Replace	Select to enable, replaces selected event with Browser selection; multiple selections can be replaced
Insert Before	Select to enable, inserts Browser selection before selected event; multiple selections can be inserted
Insert After ('Insert' if Event List is empty)	Select to enable, inserts Browser selection after selected event; multiple scenes can be inserted
Undo	Undo last List Edit action
Delete	Delete Event List selection
Unload List	Clear Event List
Cut	Cut a Event List selection
Copy	Copy Event List selection
Paste	Paste copied/cut event to Event List
Move Up	Move Event List selection up
Move Down	Move Event List selection down
Save List	Save Event List

Event List Pane

Event List	Current events, works with List Edit operations
Loaded	Green box indicates currently loaded event

Transport Control Pane Buttons

Button	Description
Auto Load	Select to enable, auto-load next event to Program
Auto Start	Select to enable, auto-start event when loaded to Program
Off Air Advance	Select to enable, auto-load next event to Preset Clip
Previous Event	Select the previous event in the list
Next Event	Select the next event in the list
Mark	Marks event time code, works with the Play/Stop/Cue To Begin buttons
Load Event/Cut To Begin	Load selected event/Cue To Begin; select to play

ClipStore/DDR

Stop	Stop clip
------	-----------

Transport Control Pane Buttons

Button	Description
Play	Play clip
Graphics Device	
Out	Take scene off-air
In	Take scene on-air

Clip Loading

External devices are controlled using various protocols (BVW, Odetics, AMP). These protocols have different capabilities, and specific models of external devices may support only specific protocols. The exact clip/scene loading procedures, if available, will vary depending on the device model and protocol being employed.

In general, clips/scenes are loaded from the Devices Control menu by selecting the **Program Clip/Scene** data pad then selecting the clip/scene from the list displayed.

Note: GV Switcher systems do not support Unicode characters in the AMP Protocol.

Clip Directory (AMP Protocol)

If you change a clip locally on the Summit/Solo server, that clip name will be updated on the GV Switcher Devices menus. If the folder list or clip list are incomplete, re-enabling the device will fetch the entire folder and clip list. A maximum of 20 folders is recommended along with a maximum of 20 clips per folder.

CAUTION: Do not create file or folder names that have the pound character (#) along with either the dash (-) or underscore (_), and avoid blank spaces (for example, use "DeadEnd" not "Dead End". This can inhibit clip access).

Device Control

Timeline Event Information and Work Buffer Values

Do not create file or folder names that have the pound character (#) along with either the dash (-) or underscore (_) character, and avoid blank spaces (for example, use “DeadEnd” not “Dead End”. This can inhibit clip access).



Timeline Event Information and Work Buffer Values

The **Device Summaries** and **Current Device** data pads update to show the current state of the work buffer by displaying what events exist on each keyframe as it is encountered during effect run or time cursor navigation and showing what events will be added to the timeline if a new keyframe is inserted or one is modified. This is consistent with other work buffer parameters, but requires some discipline when working with events. For other parameters, inserting keyframes without changing values will result in no change between keyframes. But for events, this same practice will result in reissuing the event at each keyframe. It is a good practice to use the **Clear All Events** or **Clear Delegated Device Events** button after inserting or modifying a keyframe containing external device events. This prevents those same events from being duplicated when the next keyframe is inserted.

Prepare the External Device for Control

- 1 Turn on the **EXT DEV** button in the E-MEM & Timeline, Recall Run menu (or whichever button your machine control device has been associated with) and press the **EMEM Edit** button in the Master E-MEM Module.

Note: Devices can be assigned to any level, including 1-8 which are provided as hard buttons in the Master E-MEM Module, in the User Setups, Suite Prefs, E-MEM Prefs, Name Misc. Levels menu.

- 2 Go to the Devices, Enables menu, and select the device you wish to enable in the Device Enables pane (left), and select the **Enable Selected** button (or enable all using the **Enable All** button) in the Enables pane.



Control an External Device (Example)

- 1 Go to the Timeline Events menu, select the **Clear All Events** button. This ensures only that device's events will be specified in the keyframe.

Device Control

Control an External Device Using Timeline Events and E-MEM

- 2 Go to the Timeline Events menu and select the button of the desired device to delegate the menu to that device.

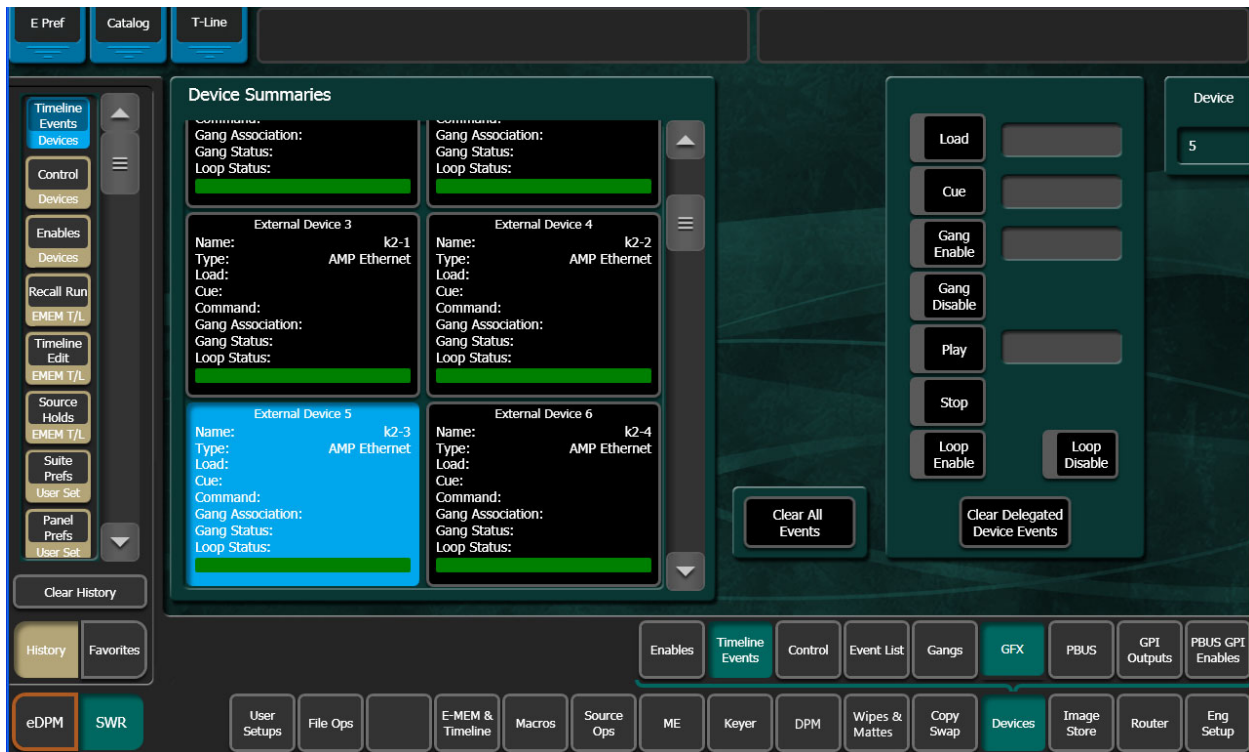

- 3 Select the Load button on the right.
- 4 Select the Cue button to enter the timecode:
 - If you want to play the clip from its starting point, it will automatically cue to this location when loaded.
 - If you do not want to play the clip from its starting point, either cue the device to the desired location or enter the timecode value manually.

Control an External Device Using Timeline Events and E-MEM

- 1 Set up the Control Panel to the desired state, making sure the DDR source is not selected on the PGM PST A bus.
- 2 Learn this state to an E-MEM register as the first keyframe of the effect.
- 3 Go to a point later in your effect giving sufficient time for the clip to load and cue. For example, go to three seconds by pressing **GoTm, 3, •, ENT**.
- 4 Select the **Clear Events** button in the Events pane to deselect the old commands. This helps prevent accidental multiple load and cue commands in the same effect.
- 5 Select the **Play** button on the Timeline Events menu.
- 6 Set up your control panel to the desired state, including selecting the DDR on the PGM-PST A bus.
- 7 Press **<Insert** or **>Insert** to add the keyframe information to the E-MEM register.

- 8 Go to a point later in your effect giving sufficient time for the desired material in the clip to play. For example, for a 20 second clip that started at three seconds, press **GoTm, 23, •, ENT**.
- 9 Select the **Clear Events** button in the Events pane to deselect the old commands.
- 10 Select the **Stop** button.
- 11 Set up your control panel to the desired state, including selecting an alternate source on the PGM-PST A bus.
- 12 Press **<Insert** or **>Insert** to add the keyframe information to the E-MEM register.
- 13 Select the **Clear Event** button in the Events pane to deselect the commands.
- 14 Recall and run the register. The clip will load and cue, be taken on-air, play automatically, be taken off-air and then stop.

Play a Video and Key Pair of Sources in Sync from an External Device

- 1 Besides **EXT DEV** (or whichever button your machine control device has been associated with), make sure **PGM PST** level is also enabled in the Master E-MEM Module.
- 2 In the Timeline Events menu, delegate the device to be used for the video signal, and select **Load** and **Cue** events for it. Do not add these events to a keyframe yet.
- 3 Delegate the device to be used for the key signal, and select **Load** and **Cue** events for it.
- 4 Set up the Control Panel so PGM PST **Key 1** is not on-air and the DDR source is not selected on the PGM PST A bus.
- 5 Add this to the first keyframe of the effect by pressing **<Insert** or **>Insert**.
- 6 Go to a later point in your effect giving sufficient time for the clips to load and cue. For example, press **GoTm, 3, •, ENT**.
- 7 Select PGM PST **Key 1** in the Next Transition area so it will mix on, and setup a split key with the two DDR channels.
- 8 Select the **Clear Events** button in the Events pane to deselect the old commands.
- 9 Delegate the device playing the video and select a **Play** event for it.
- 10 Delegate the device playing the key and select a **Play** event for it.
- 11 Add these events to the same keyframe of the effect by pressing **<Insert** or **>Insert**.
- 12 Select the **Clear Events** button on the Timeline Events menu to deselect the commands.
- 13 Put the PGM PST A bus in Hold to prevent the effect from changing its source.
- 14 Recall and run the effect. Both DDR channels will roll in sync and the system will mix the key on air at the instant they play.

Load a Clip to Play On Air Later with Auto Start

- 1 In the Timeline Events menu, select the button of the desired device to delegate the menu to that device.
- 2 Select the **Load** button on the right. If the correct clip is not displayed, select the data pad and select the clip from the list.
- 3 Set up the Control Panel to the desired state, making sure the DDR source is not selected on the PGM PST A bus. DDRs cannot cue and buffer instantaneously, so should not be placed on-air immediately when the effect is recalled.

- 4 Learn this state to an E-MEM register.
- 5 Select the **Clear Events** button on the right to deselect the Load command. This helps prevent accidentally creating unwanted load and cue commands when editing effects later.
- 6 Make sure **Auto Start** is on in the Devices, Control menu. Each device has its own auto start flag. Note that this is not a keyframeable E-MEM control, and so it must be selected manually for use.
- 7 Recall the register. The clip will load.
- 8 After allowing sufficient time for the clip to load and buffer (which varies with different DDR models), take the DDR on-air. The clip will play automatically.

Note: Because a Stop command was not entered, the clip will continue to play until it reaches its end or it is stopped.

Build an Event List

The event list editor is designed for speed and does not follow traditional editing operations. For example, a normal insert operation would have the operator select the insert point in the event list, select the clip to be inserted in the browser, and then press **Insert Before** or **Insert After**. Instead, the Event List editor makes insert and replace operations a mode and modifies what happens when a clip in the browser is selected. This allows an event list to be built by turning on **Insert After**, then selecting clips in the order they should appear in the event list. An insert operation is reduced from two button selections to only one.

- 1 Select **Devices, Event List** in the menu.
- 2 Select the **Insert** button so its indicator is illuminated.
- 3 Scroll the Clip Browser and select the first clip for the list. It will be added to the Event List in the right pane, and the Insert button legend will change to **Insert After**.
- 4 Continue to select clips in the desired order with the **Insert After** button on to build the rest of the Event List.
- 5 If you need to re-arrange the order of the clips in the Event List, use the list editing buttons (**Move Up, Move Down**, etc.). Remember to first select the clip in the Event List where you wish the re-arrangement to occur before you use these buttons.
- 6 When the Event List is complete, it can be used for your production without saving it. The list will only reside in RAM, however, and so will be lost if the GV Switcher system is reset.
- 7 To save the Event List for reuse in the future, select **Save List**, navigate to the destination folder (creating a new one if desired), enter a name for the list, and then select Save.

Notes:

- Image Store channels do not support the Gang function.
 - External Devices are configured for control in the Ports & Devices, External Devices menu. See the *Kayenne/Karrera/GV Korona Installation & Service Manual* for more information.
-

About E-MEM Control of External Devices

E-MEM effects can be used to:

- Load, cue, play, and stop DDR clips, and
- Cue, play, and stop tapes in VTRs.

E-MEM Device Control is good for recalling the same clips repeatedly, and for integrating clips into specific switcher effects. Manual control is appropriate when different clips are used each time, and when clips are not used in a switcher effect (like rolling a news story and taking it directly to air.)

For Kayenne systems, E-MEM Device Control operates independently from the manual controls on the Multi-Function or Device Control Module, but both mechanisms can be used together. For example, an E-MEM recall can make a VTR cue up, then the module can be used to roll that tape.

E-MEM External Device Control utilizes events. External device events are different from other parameters in the E-MEM system. Rather than defining a value at a keyframe and smoothing the transition between keyframes with interpolation, a device event consists of instructions sent to the external device at the time the cursor passes the keyframe during an effect run. This is similar to GPI and PBus triggers.

Controlling an external device typically requires spacing the instructions over two or more keyframes. The space between keyframes allows the device to respond to the first set of instructions. For example, a DDR or VTR takes time to load and cue before it can play. The effect must be built so that a play event does not occur until the device is ready, or the command will be executed late or not at all.

The GV K-Frame XP system does not play a DDR or VTR in sync along with the timeline like digital effects devices controlled by CPL. Instead, the system issues a play command then lets the device manage its own playback. This means that if the effect is lengthened or shortened, the device's playback may not line up with the effect as intended. Device playback does not speed up or slow down if the duration of the effect changes.

Configuration

Device Control option software must be installed and configured to permit either manual or E-MEM control of DDRs and VTRs. Sources will also need to be configured as external devices in Eng Setup.

E-MEM control for external devices is by default assigned to the **Misc 16 EXT** Master E-MEM Module enable group button. This can be changed in the User Setups, Suite Prefs, E-MEM Prefs menu.

Operation

E-MEM Device Control is accomplished by:

- Associating an external device with an E-MEM enable group button (factory default is Misc 16 EXT),
- Enabling the E-MEM button for that enable group and, if editing the effect, delegating that enable group for editing,
- To run E-MEM Device Control effects, ensure the device(s) are Enabled for E-MEM control, using the Devices, Enables menu. Devices do not need to be enabled in this

menu when building an effect, however, and in fact it may be desirable to disable them at that time.

- Specifying what Device Control events will be added to a keyframe in the effect, using the Devices, Timeline Events menu,
- Adding the Device Control keyframe to the effect (Insert Before/After, Modify KF in the Timeline Edit menu, or Learn in the Recall Run menu),
- Clear events after adding the keyframe, to prevent accidentally adding additional machine control commands to other keyframes,
- Specifying and adding additional Device Control keyframes if multiple keyframes are desired, clearing all devices each time, and
- Recalling and running the effect.

When the effect register is recalled, the first keyframe can, for example, command the device to load and cue. When the effect runs, the device can be commanded to play when a later keyframe with a play event is encountered on the timeline.

The device may not play if it has not fully cued when the effect is run. It is up to the operator to build the effect to accommodate cue and load time. Also, running effects with external device events backwards will not cause the clip or tape to play backwards. The order of the commands will be reversed and if the clip or tape plays at all it will not be at the anticipated time or direction.

Timecode Entry

Timecode is entered in hours, minutes, seconds, frames format, with optional • (dot) separators. Typing in partial values will enter the smaller value. For example, typing in 5 enters five frames (00:00:00:05). Typing in 5• enters five seconds (00:00:05:00). Typing in 5•4 enters five seconds and four frames (00:00:05:04). Typing in 5•4•3•2 enters five hours, four minutes, three seconds, and two frames (05:04:03:02).

You can enter timecode values without • (dot) separators. Simply enter the exact value. Leading zeros are ignored. For example, 00:02:00:11 can be entered by typing **20011, 020011, or 00020011.**

About Multiple Events on the Same Keyframe

More than one external device event can be specified to occur in the same keyframe. If more than one event is specified, they are sent to the device in Load, Cue, Play order. For example, you can specify only Load which will make the device load to the start of the clip, or you can specify Load and Cue which will load and cue the device to the entered timecode. Both Play and Stop cannot be specified on the same keyframe, however. Turning one on automatically turns the other off.

RossTalk XPression Device Control

GV K-Frame XP systems provide control of up to four external XPression graphic devices and the ability to fire up to four GPI triggers, using RossTalk. XPression controls can be recorded into macros that can be triggered from any Control Panel or menu application.

Configure an External Device for XPression Control

You can configure up to four XPression devices; GFX 1-GFX 4, allowing you to send commands from the Control Panel or menu to your external device. You can take IDs, fire up to four GPI sets, clear buffers, and override or fine tune the controls.

- 1 Select **Eng Setup, Ports & Devices, External Devices** in the menu.



- 2 In the External Devices pane, scroll down until GFX 1-GFX 4 is displayed and select one.
- 3 Enable the **XPression** Type button
- 4 Select the **Device Name** data pad, enter a name using the pop-up keypad, and select **Enter**.

IMPORTANT: The Device Name must end with *-n*, where *n* = a channel numbered 1 through 16. For example, GV Device-10.

- 5 Select the **IP Address** data pad and enter the IP Address of an XPression device in the pop-up keypad and select **Enter**.

Take XPression IDs from an External Device

The Standard GFX workflow allows you to take IDs from an external XPression device then take the next IDs in the list. Functions are also provided to clear the active buffer and all buffers.

1 **Select Devices, GFX** in the menu.

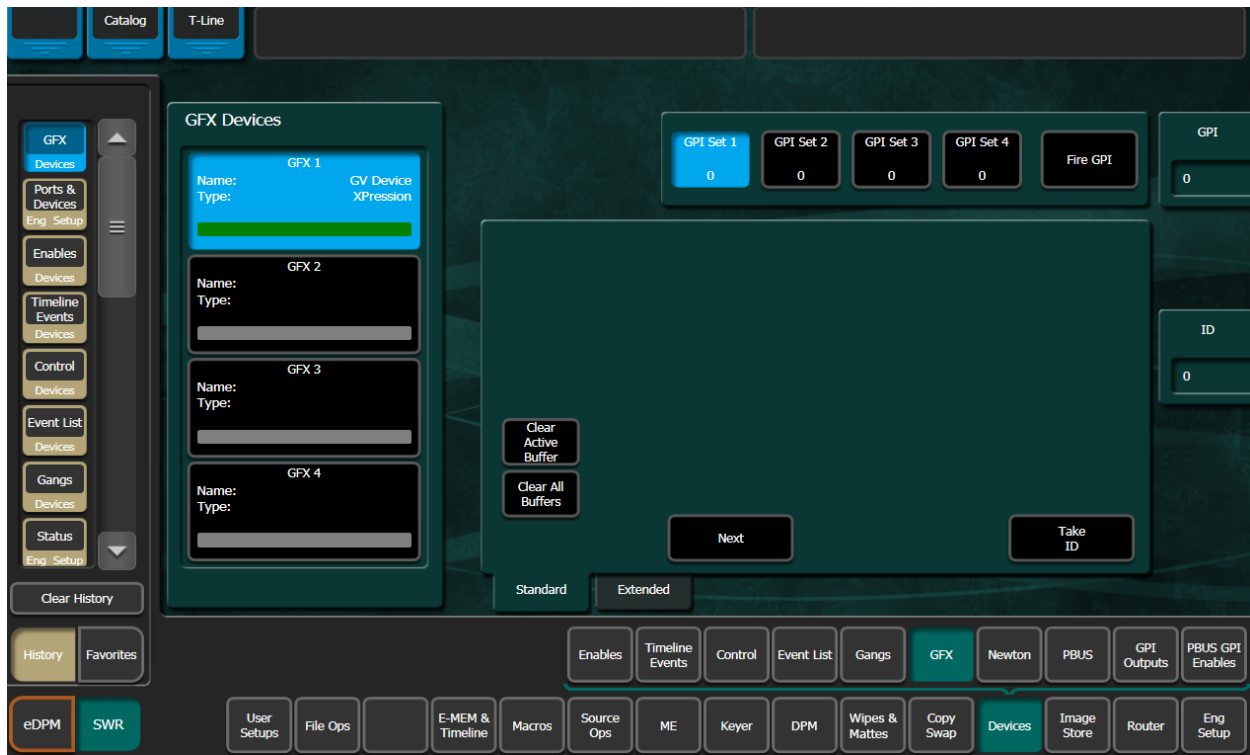

- 2 Select an ID by either scrolling with the soft knob or selecting the ID data pad and entering an ID and selecting **Enter**.
- 3 Select **Take ID**.
- 4 Optionally, select **Next** to take the next ID in the list; repeat to take the next ID and so on.
- 5 To clear the buffers, either select the **Clear Active Buffer** or **Clear All Buffers**.

Using Extended GFX XPression Controls

Setup XPression controls for an ID, a buffer, and a layer, and send those commands to your external device. Typically, the commands are embedded in the ID but the menu function buttons allow you to override or fine tune those controls and clear buffers.

- 1 Select **Devices, GFX, Extended** in the menu to access the GFX XPression controls.



- 2 Select an **ID, Buffer, or Layer** by either scrolling with the soft knob or selecting the ID data pad and entering an ID and selecting **Enter**.
- 3 Use the function buttons in the Extended pane to set controls for IDs, Buffers and Layers

Fire XPression GPI Sets

There are four XPression GPI Sets that can be fired from the GV switcher, GPI Set 1-GPI Set 4. There is macro support for firing the GPIs. Creating a macro to fire a GPI means the GPI ID you preset to one of the four GPI buttons will be fired when the macro is triggered; not GPI 1 through GPI 4 presets but the GPI ID assigned to each.

- 1 Select **Devices, GFX** in the menu.

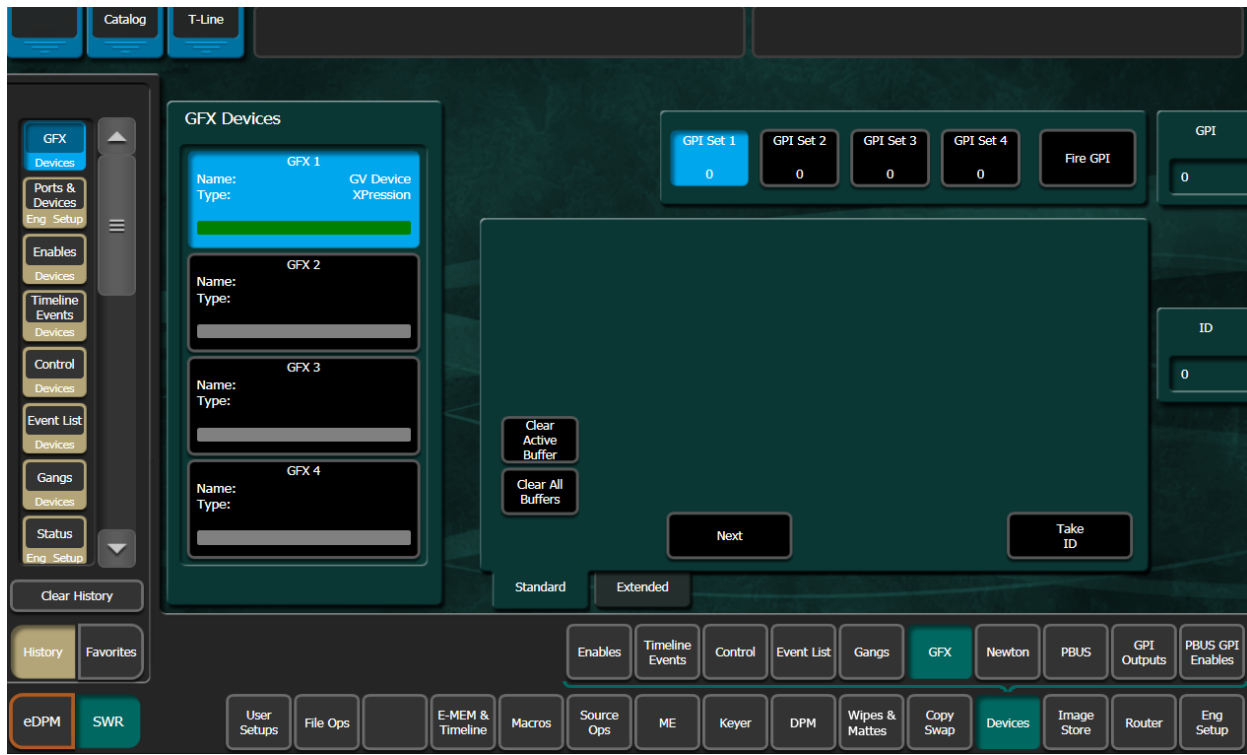

- 2 Select a GPI number you have configured in the external device by either scrolling with the soft knob or selecting the GPI data pad and entering the GPI and selecting **Enter**. Repeat for each GPI Set preset.
- 3 Select one of the GPI presets, then select **Fire GPI**.

Note: Only one GPI preset can be fired at a time.

You can also create a macro to select and fire the GPI preset ID, from the Control Panel or Macros menu.

Kayenne Device Control from the Control Panel

The following provides device control operations from the Kayenne system:

- System Bar,
- Local Aux Module,
- Multi-Function Module,
- Module Option, and
- The Menu Panel or menu on a PC.

System Bar

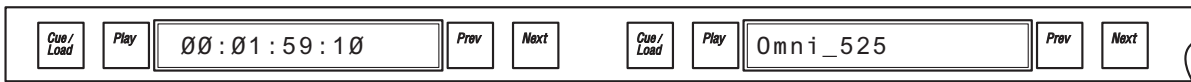

System Bar Example

Device control from the System Bar is performed in the Device Control Groups (Two for a 1-M/E Kayenne system and six for a 2-M/E (2-M/E Stripes) and larger), which consists of a 16 character Status Display (displays the current clip) and Play, Cue/Load, Next Clip, and Previous Clip buttons.

Note: Off Air Advance and Auto Start buttons are accessed from the menu and the Multi-Function Module (**Devs, ADV/APLY**), not on the System Bar. Also, Rewind, Fast Forward, Stop, Jog +/-Jog -, Mark In, and Gang Rolls are not supported on the System Bar (but are supported in the Device Control Module).

To associate a device with a Device Control Group, hold down a source select button that has a device attached, then press the PREV and NEXT buttons together (or you can press and hold down the PREV and NEXT buttons and then press a source button).

Group buttons:

- **Play**—Causes the associated device to play (pressing again causes device to pause).
- **Cue/Load**—Pressing after a PREV or NEXT button press causes a load and cue command to be sent to the device, subsequent presses causes a command to be sent to the device to 'cue' to its in-point.
- **Next Clip/Previous Clip**—Causes the previous or next clip name in the frame-maintained clip stack list (per device), to be brought into the Status Display window.

Local Aux Module

Ganging

The Gang Control function in the Local Aux Module allows a single point of control for multiple devices. The points of control are:

- The right-most Device Control Group on the System Bar, and
- The Device Control Module option.

Note: An Aux bus link overrides a set delegate association in the System Bar.

Kayenne systems equipped and configured properly support device control of Profile DDRs and VTRs. The Gang function permits control of multiple external devices with the same set of panel controls. Devices can be ganged so they play together at the same time (original and backup tapes, for example).

Note: The Kayenne Gang function does not synchronize multiple devices and there is a possibility devices may not respond to a Play or Stop command at precisely the same time. This may cause a slight offset in playback of multiple clips.

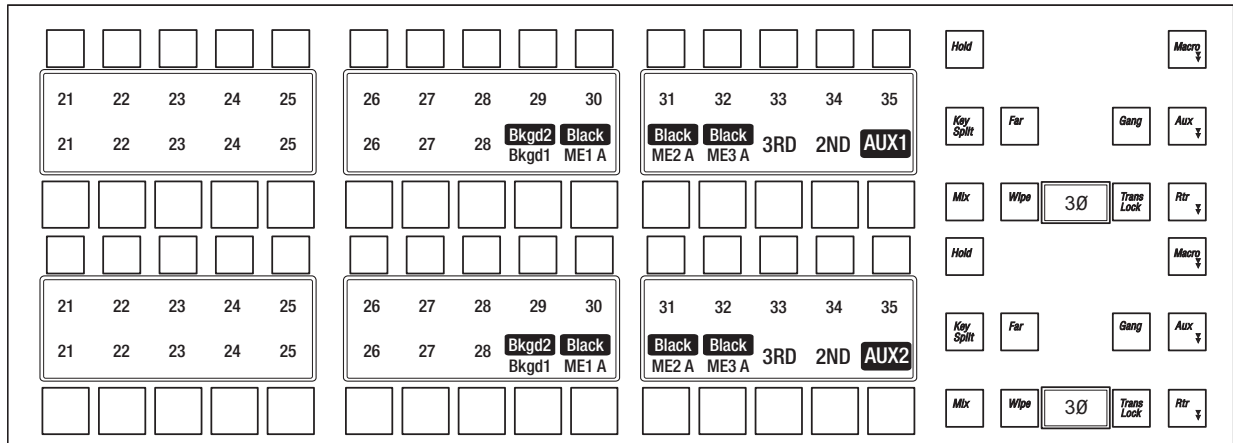

Local Aux Module

Set up a Gang for Control

- 1 Press one of the **Gang** buttons on the Local Aux Module (right). GANG is displayed in the top row however the button displays are blank. The bottom row display shows sources mapped to buttons on the Local Aux Module, in the Panel Prefs, Button Mapping menu. Buttons are colored white and are low tally.
- 2 Press the source select buttons of the devices to be ganged. The source select button for each device will change to green, high tally as they are pressed.

The gang is dynamic so toggling sources on and off adds/removes them from/to the gang.

- 3 Press the Gang button again to exit the Gang mode. The gang remains.

About System Bar Gang Control

Gangs can be controlled using the right-most Device Control Group on the System Bar. Play, Cue/Load, and Previous and Next commands are all supported (see [System Bar](#), on page 221).

The Device Control Module

Panel Gangs (Local Aux Bus gangs) can also be controlled with the optional Device Control Module. Stop, Play, Rew, Fast Fwd, Forward Jog, Reverse Jog, Mark, etc. are operational in Gang mode (see [Device Control Module](#), on page 228). Panel Gangs and the gang on the 'F' button (of A-F) are the same when the **SDEL** button is selected. Gang device selections made in the Device Control Module affect gang selections in the Local Aux Bus Module and vice versa.

About Multi-Function Module Device Control

The Kayenne Multi-Function Module supports Single and Multiple Device Control. In Single Device Control mode, you have full VTR control of an Event List right on the Control Panel. In Multiple Device Control mode, you can select and control up to eight devices at a time from the Control Panel, with Stop, Cue, and Play for each (including gangs).

Single Mode Device Control

To place the Multi-Function Module in Single Device Control mode, press the **Devs** button from the HOME position, then press the **Sngl** button located below and right of the joystick on the Multi-Function Module.

Follow Mode Device Control

When in Follow mode, the default, the Multi-Function Module tracks the right-most Device Control group on the System Bar (see [System Bar](#), on page 221). The current device is shown in the function button status display just below the Joystick, on the right side of the Multi-Function Module. 'Device Follow' is displayed in the LED to the right of the top soft knob.

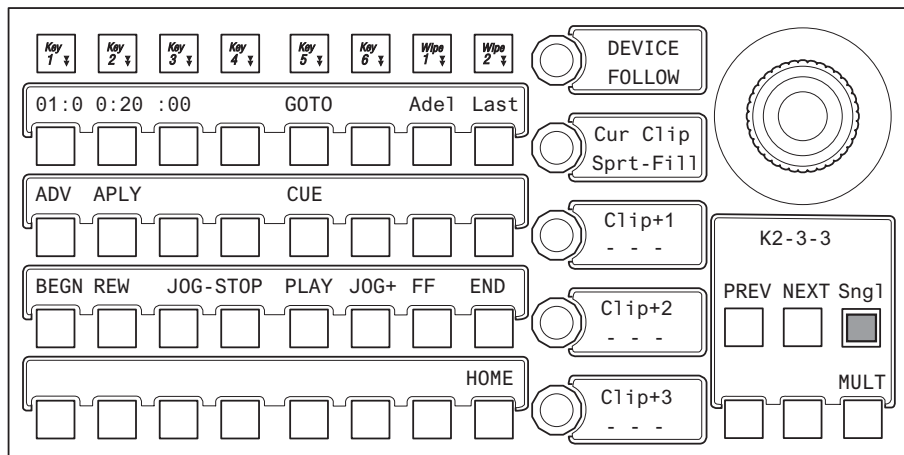

Single Device Control, Follow Mode

Device Selection

Device Selection is performed by turning the top soft knob. Turning this knob in Device Control mode scrolls through the associated devices (seen in the status display). Turning the soft knob immediately delegates the Multi-Function Module to the newly selected device.

Pushing down the top soft knob returns the Multi-Function Module to the Follow mode.

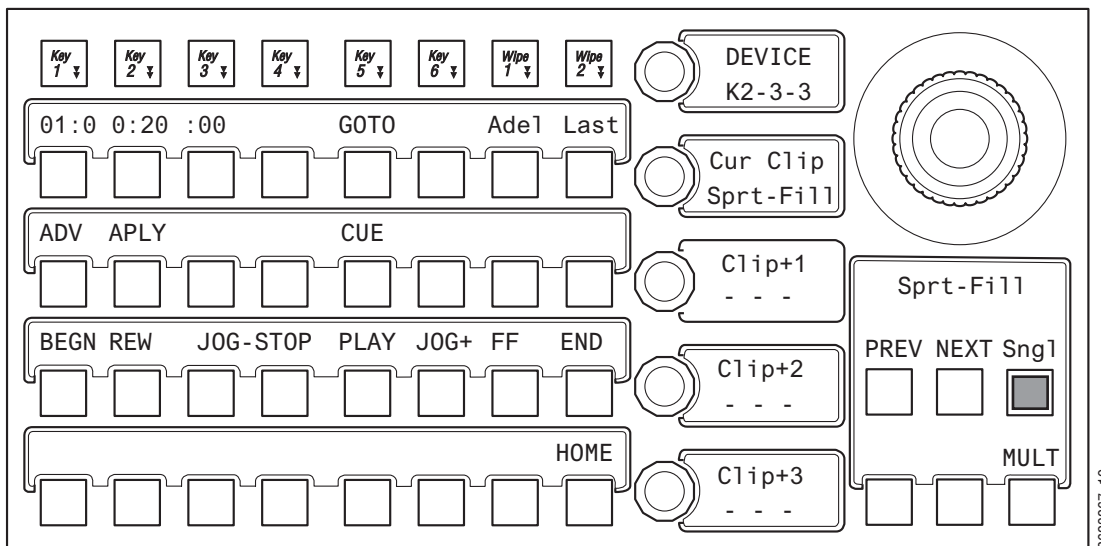

Single Device Control, Selection Mode

Current Clip

Current clip selection is made by turning the soft knob, second from the top. The current clip in the Event List is shown in the status display LED just right of the soft knob. Pushing down the soft knob loads the selected clip.

Event List Editing

Turning any of the lower three soft knobs in Single Device Control mode on the Multi-Function Module changes the clip name in the adjacent OLED and three buttons are added in the main function area; **INS**, **MOD**, and **DEL**.

Note: After the **INS**, **MOD**, or **DEL** button is pushed, the editing buttons turn off.

INS button—Causes the new clip name from the clip list, in the Current Folder in the Clip Browser (see [About E-MEM Control of External Devices](#), on page 215), to be inserted into the Event List. Clips can be inserted into the Event List in the 1st, 2nd, or 3rd position in the list using the bottom three soft knobs. All other clip names will be pushed down one.

Note: Only one of the three bottom soft knobs are active at a time in Device Control mode.

Insert a clip

- 1 Turn the soft knob (Clip +1, Clip +2, or Clip +3) and scroll through the current folder on the selected device and select a clip (editing buttons appear in the main function area).
- 2 Press the **INS** button on the Multi-Function Module. The new clip name will be added to the Event List for selection in the 'Current Clip' OLED, in the position selected in Step 1. Clips below the inserted clip are pushed down in the list.

- 3 The **MOD** button can be used to replace the current clip name with the new clip name in the Event List. To modify a clip name with the MOD button, perform the following:
 - a Turn the soft knob (Clip +1, Clip +2, or Clip +3) and scroll through the current folder on the selected device and select a clip (editing buttons appear in the main function area).
 - b Press the **MOD** button on the Multi-Function Module. The new clip name will appear in the position of the old clip name in the Event List.
- 4 The **DEL** button can be used to delete the current clip from the Event List and all remaining clips to move up one. To delete a clip from the Event List, perform the following:
 - a Turn the soft knob (Clip +1, Clip +2, or Clip +3) and scroll through the current folder on the selected device and select a clip (editing buttons appear in the main function area).
 - b Press the **DEL** button on the Multi-Function Module. The clip name will be deleted from the Event List and will no longer be available for selection in the 'Current Clip' OLED.
- 5 Pressing one of the three bottom soft knobs after changing the Event List returns it to the current clip name in that position of the list.

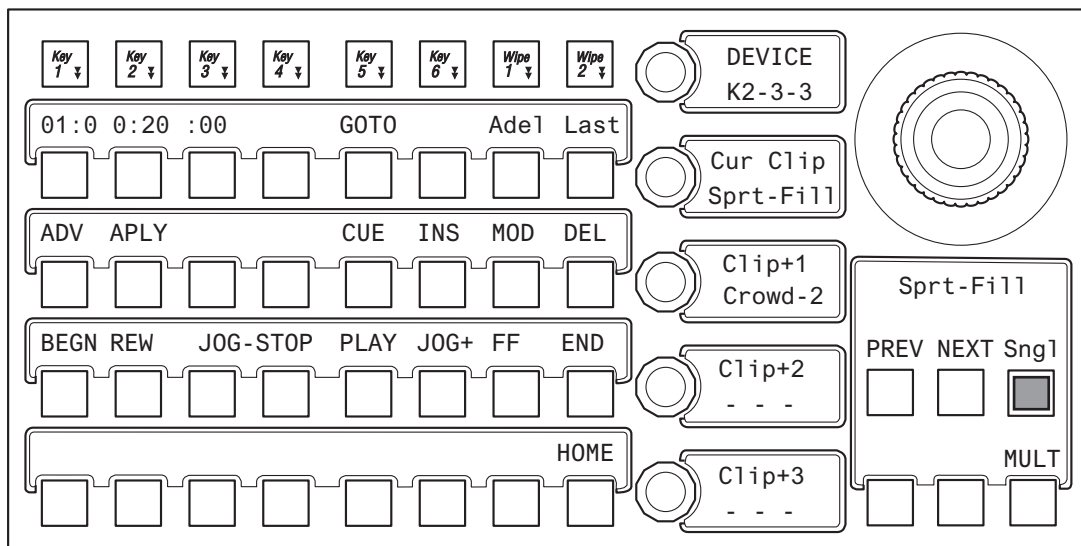

Single Device Control, Clip Stack Editing

Clip Run Control Functions in Single Device Mode

The joystick provides the following clip control:

- Joystick left—Left jog,
- Joystick right—Right jog,
- Joystick up—Fast Forward,
- Joystick down—Rewind, and
- Button on top of the joystick—Mark In.

The motion control buttons in the main function area provide the following:

BEGN—Places the clip at the beginning,

END—Places the clip at the end,

REW—Rewinds the clip,

JOG+/JOG—Jog forward, jog backward through the clip,

PLAY—Play the clip from current position,

STOP—Stop the clip,

FF—Fast Forward through the clip,

ADV—Off Air Advance, and

APLY—Auto Play

The PREV and NEXT buttons performing the following:

PREV—Moves up through the Event List in the Current Clip and loads the selected clip,

NEXT—Moves down through the Event List and loads the selected clip.

About Multiple Device Control

To place the Multi-Function Module in Multiple Device Control mode, press the **Devs** button from the HOME position, then press the **MULT** button located below and right of the joystick on the Multi-Function Module (directly below the **Sngl** button).

Devices are configured using the Panel Prefs, Panel User Interactions menu. Eight external devices of the 32 possible can be controlled from the Multi-Function Module in the Multiple Device mode. Each device name is displayed above the assigned button (D1, D2, D3, etc.).

The **PLAY**, **CUE**, and **STOP** command buttons tally as follows:

- PLAY button high tallies green while playing and high tallies red when on air.
- STOP button high tallies when stopped, and the
- Cue button high tallies when the current timecode for the device matches Mark In.

About Creating a Gang

To create a gang in Multiple Device Control mode, toggle any of the configured device buttons (device name). Device buttons toggle between high tally and low tally. All devices in high tally are part of the gang. Toggling to low tally removes the device from the gang. A gang can be immediately canceled by pressing the soft knob (Gang Cancel), second from the top in the Multi-Function Module.

Once a gang is created (more than one device is high tally), buttons **GCUE** (Gang Cue, causes a gang to cue) and **GPLAY** (Gang Play, causes a gang to play) appear below the joystick.

The first soft knob from the top controls the Auto Cancel function which has two states,

Pressing an individual PLAY, CUE, or STOP button causes only the selected device to respond to the command. This is beneficial for example if a director calls for a device to be individually controlled.

GOTO Mode

Pressing the **GOTO TC** button on the Multi-Function Module provides delegation to the Timecode Entry mode, and delegates control over the Timecode display in the upper left of the Main function area.

Entering the first digit causes the display to be set to zero and the first number entered. Additional entries accumulate from right to left.

Plus (+) and minus (-) buttons are provided on the Multi-Function Module in GOTO mode to perform trim operations.

Enter the timecode:

- 1 Press the **GOTO** button.
- 2 Enter the timecode using the examples below.
- 3 Press the **ENTER** button. The Multi-Function Module returns to Device Control mode.

Examples of Timecode entries

22 — 00:00:00:22

2 — 00:00:00:02

102 — 00:00:01:02

The **CLR** button on the Multi-Function Module empties the buffer and resets timecode display to the current timecode.

Pressing the **HOME** button returns the Multi-Function Module to the Device Control mode.

Device Control Module

The Kayenne Device Control Module provides essential Device Control which can replace auxiliary devices such as DNF and Lance controllers, PDR Panels for Profile and EVS, and Hard controllers for EVS/Omega/FFW.

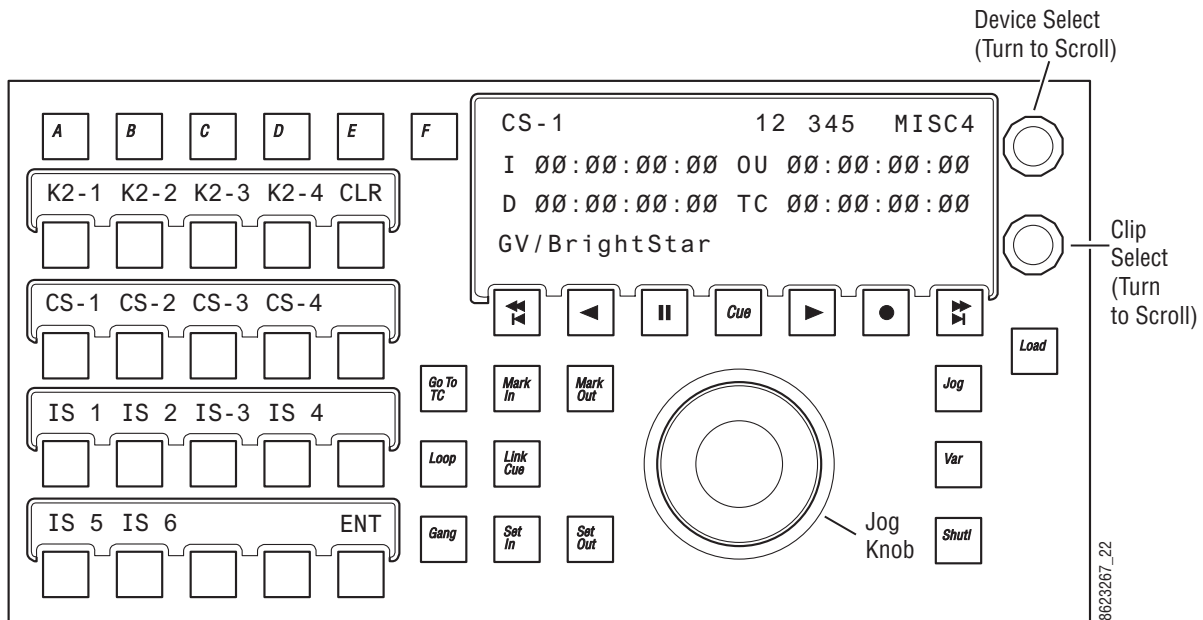

Device Selection, Device Control Module

Supported machine control functionality:

- Run Control:
- Play,
- Cue,
- Stop/Pause,
- Jog +/-,
- FF, REW,
- Next clip/Previous clip,
- Set mark in/out:
 - Cue marks,
 - Loop marks,
- Cue library (Q-MEM with 1000 Q-MEM Registers)
 - Ability to recall large numbers of clips/marks
 - Create virtual clips as mark in/out point within another clip
 - Create assemblies of clips which span channels (for example Video and Key and driving video walls with 4 or 8 channels),
 - Ability to record a clip to a device, cue to mark-in, and add a play command.
 - Cue can be for more than one device

- Variable speed play,
- Multiple Device Control:
 - Swap between controlled devices,
- Channel ganging,
- Create recordings, and
- Loops:
 - Stop, and
 - Play.

Control all configured devices with the following properties:

- Current Mark in/out,
- Current duration,
- Current clip name,
- Current loop flag,
- List of currently ganged devices.

Device Selection

Device selection buttons A-F can be configured to control devices in the Device Control Module.

- 1 Select a device by rotating the Device Select knob to scroll through the devices.
- 2 Press the **LRN** button.
- 3 Press one of the device buttons (**A-F**) to assign the current device.

The **F** button can be made to track the selection on the right-most of the source control selections on the System Bar, by pressing the **SDEL** (Set Delegate Tracking) button on the Device Control Module. When the SDEL button is on, it high tallies blue and the F button low tallies blue.

About Gangs

When devices are ganged, motion control commands are applied to all the devices in the gang. Play, Stop, Cue to Mark-In, etc. are performed simultaneously for all devices in the gang. Loading clips, which is not motion control, is not included in a gang. To load more than one device at the same time, use a Q-MEM linked cue (see [Learning Additional Devices](#), on page 232).

Ganging Devices Associated with Lettered Buttons

To gang devices associated with the **A - F** lettered buttons on the DCM, press and hold down the letter buttons and press the **Gang** button (the ganged buttons tally green). For example, hold down **A** and **B** buttons (or any combinations of **A - F** with devices associated) and press the Gang button on the DCM. The devices associated with **A** and **B** are ganged. Pressing the **CLR** button during device gang selection clears all devices from the gang.

Ganging Additional Devices

Hold down a single lettered button (**A - F**) and press the **Gang** button (Gang Device Selection appears on the status display). A menu of devices is displayed that you can add (or remove) in association with the lettered button. You can page through and press the device buttons to make your selections. Once you've made your selections as part of the gang, press the **ENT** (or Gang) button to gang the devices.

The DCM supports multiple gangs, so there may be a gang associated with the device on the **A** button, and another gang on the device associated with the **B** button, and so on.

When the Gang button is high-tallied green, then there is an active gang associated with the selected letter button. To temporarily disable the gang, press the **Gang** button; it will low tally green, then make an adjustment. Pressing **Gang** again, will re-enable the gang. For example, this can be used where one device is video and the other key. By pressing the **Gang** button you can turn off the gang temporarily, jog the key channel to more precisely align it with the fill, and then re-enable the gang.

Panel Gangs

The "Panel Gang" (Local Aux Bus gang) and the gang on the 'F' button are the same when the **SDEL** button is selected. Gang selections made from the DCM in this way also affect gang selections made in the Local Aux Bus Module and vice versa.

About Q-MEMs

Q-MEM can be used to assign a device to a letter button on the DCM, load a named clip on that device and cue to its mark-in point, and optionally play or loop the clip. Multiple devices can also be loaded and cued using the "Link Cue" feature.

Each suite has 1000 cue memory registers (Q-MEMs).

Each cue has:

- Up to 38 devices with associated device state data (device state),
- Up to 6 device associations with Device Control buttons A - F,
- Selection of radio buttons A - F (or none) (device selection), and
- One play flag.

For each device, the following device state data is learned into the cue:

- Clip name,
- Mark-In point for clip,
- Mark-out point (may be empty),
- Loop flag,
- Gang flag, and
- A list of ganged devices.

Recalling a cue register can be used to:

- Associate devices with the lettered buttons only, so you can set up your DCM for manual use,
- Recall and cue devices without affecting the current letter button selections, and

- Both associate the devices with letter buttons and load, cue, and play them.

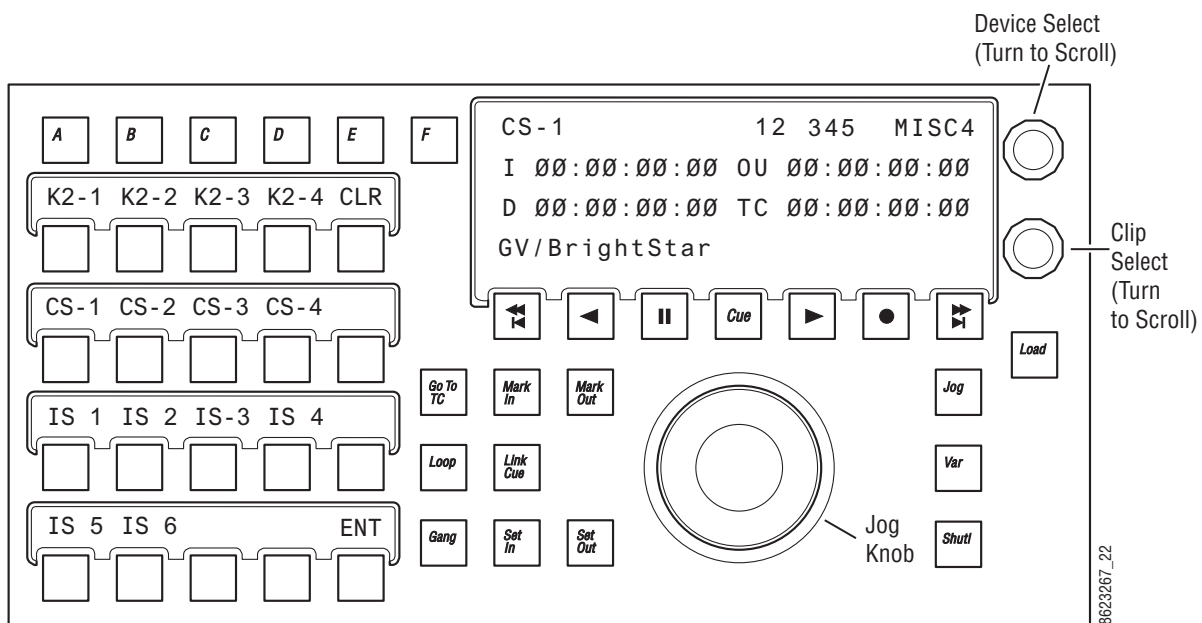

Device Control Module, Q-MEMs

Learn a Q-MEM Register with a Single Device

To learn a simple cue with one device:

- 1 Select a device by pressing a control button, A - F.
- 2 Select a clip on that device using the bottom soft knob and press the **Load** button to load the clip. You can then set the mark-in/mark-out points (**Mark In/Mark Out** buttons) and optionally turn on the **Loop** button (tallies blue).
- 3 Press the **LRN** button.
 - a Optionally, press the **Play** button (flashes green) to add a play command (so when the cue register is recalled, the clip will load *and* play).
- 4 Press the desired Cue register number button (use the Page and Bank buttons for the higher numbered registers). The selected Cue register button high tallies red.

Learning a Q-MEM Register with Multiple Devices

Lettered button (A - F) links can be learned as part of a Cue register for later recall.

- 1 Press and hold down the letter buttons for the devices to be linked (for example A, B, and D).
- 2 Press the **Link Cue** button (high tallies blue).
- 3 Learn the Q-MEM register.
- 4 Press the **LRN** button.
 - a Optionally, press the **Play** button (flashes green) to add a play command (so when the cue register is recalled, the clip will load and play).
 - b Press the Cue Register button to recall the cue.

Note: To see the link cue status, press the lettered button then the Link Cue button.

Learning Additional Devices

You can link multiple devices in addition to the devices associated with the lettered buttons using the Cue Device Selection menu. Each clip will need to be setup with mark-in/out points etc. prior to creating the link.

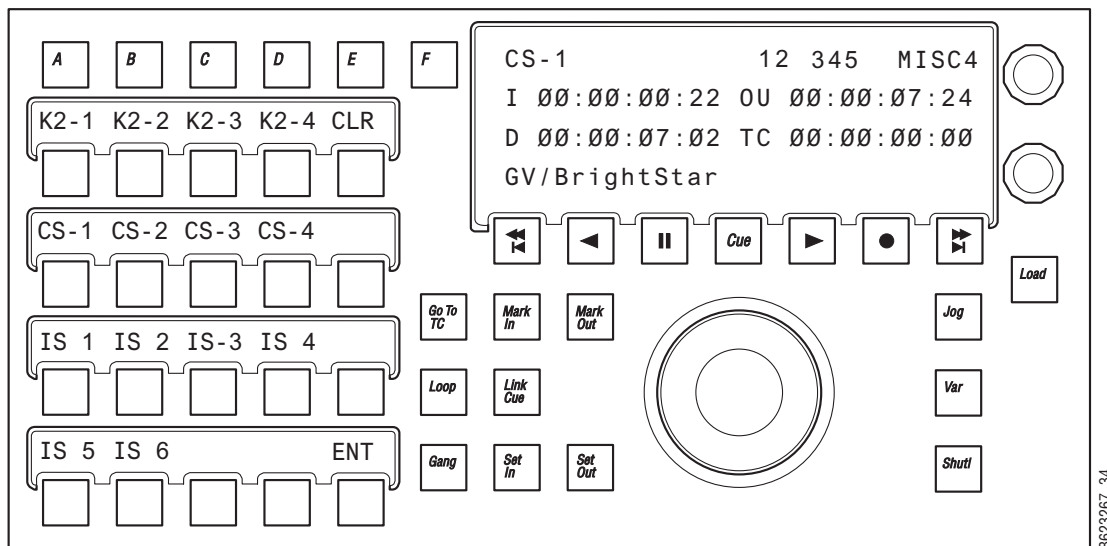

Device Control Module, Cue Links

Hold down a lettered button (**A - F**) and press the **Link Cue** button (high tallies blue), the Cue Device Selection menu is displayed. Press the device buttons to add (or remove) devices as part of the cue then press the **ENT** (or **Link Cue**) button. All device buttons added to the cue will tally blue.

Pressing the **CLR** button clears all devices from the cue.

Note: Both loop cue status and link status are always learned into the cue; if the **Loop** button is high tally, then a loop is learned and if **Link Cue** button is high tally blue, then the multiple devices are linked into the cue.

When recalled, a clip will load and cue for each device linked into the Q-MEM register. (There is one Play command per register so if learned as part of a Cue register, all devices will play when the register is recalled.)

Learn Device Associations (only) into a Register

Cues can be used to associate devices to lettered buttons only, without learning clip and mark information. So on recall, the devices are assigned to the lettered buttons but nothing is done to the current status of the devices. The Cue Device Selection menu is used to configure these associations.

- 1 Hold down a lettered button, and press the **Link Cue** button. Both the letter button and the button for the device high tally.
- 2 Turn on any other letter buttons, but turn off the device buttons. If the letter button is on and the device button is off, then only the device association will be learned into the register.
- 3 Press **ENT** to end the device selection and then learn a cue.

Only the association of the device to the lettered button is learned.

Learning Clips for Devices without Affecting Letter Button Associations

To learn a cue that recalls only device states for the clip, cue to mark, loop, and play but does not affect the association of the devices with the DCM:

- 1 Hold down a lettered button, and press the Link Cue button. The letter button and the button for the device are both high tally.
- 2 Add devices to be linked into the register, but turn off any lettered buttons associated with the device.

Note: Without the letter buttons being learned, a recall of the register will control the specified devices but not affect what is currently happening on the DCM.

- 3 Press **ENT** to end the device selection and learn a cue.

About Cues and Ganging

If a device which is learned into a cue is ganged to another device, then that gang association will be learned into the register too. So that when the register is recalled, the devices will be ganged.

Status Display

For a selected device, the display will show:

- Device name,
- Preset or current Page/Bank,
- Last recalled page, bank, and register,
- E-MEM level name,
- Timecode,
- Mark-in/out timecode,
- Calculated duration between mark in and mark out, and

- Clip folder and clip name (folder only displayed if supported by the device, e.g. ClipStore supports folder display but K2 does not).

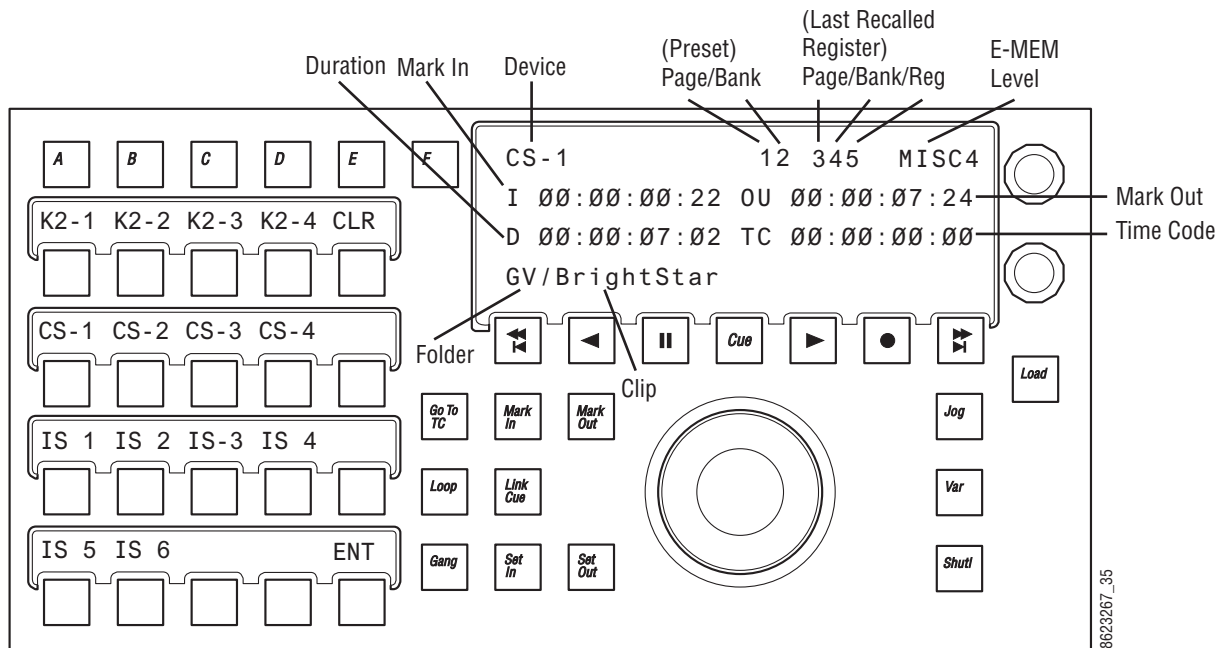

Device Control Module, Status Display

Karrera Device Control

With Karrera, external devices can be controlled from Device Control Groups (one for a 2-M/E Karrera system and two for a 3-M/E). The Device Control Group consists of a 16 character Status Display (displays the current clip) and Play, Cue/Load, Next Clip, and Previous Clip buttons.

For the one group on the 2-M/E Karrera, the Device Control Group can be assigned to a button row, on a 3-M/E the right-most group can be assigned to a device associated with a source select button.

Note: Off Air Advance and Auto Start buttons are accessed from the GV Switcher menu.

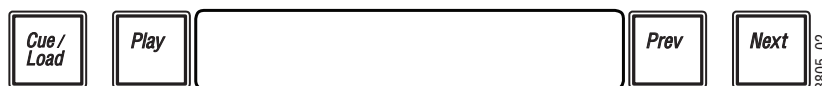

System Bar, Device Control Group

For the left-most Device Control Group (on a 3-M/E system), you can associate (or marry) a source button row to the group by holding down the PREV and NEXT buttons together and then select any button in the row.

For the other Device Control Group on a 3-M/E, you can associate a device to the group by holding down a source select button that has a device attached, then press the PREV and

NEXT buttons together (or you can press and hold down the PREV and NEXT buttons and then press a source button).

Device Control Group buttons:

- **Play**—Causes the associated device to play (pressing again causes device to pause).
- **Cue/Load**—Pressing after a PREV or NEXT button press causes a load and cue command to be sent to the device, subsequent presses causes a command to be sent to the device to 'cue' to its in-point.
- **Next Clip/Previous Clip**—Causes the previous or next clip name in the frame-maintained clip stack list (per device), to be brought into the Status Display window.

Device Control with GV Korona

Delegate the GV Korona Status Display to cue, load, and play videos from external devices.

Status Display Device Control Transport Buttons

Button	Description
DEV	Device Control <ul style="list-style-type: none"> Places the Status Display in Device Control mode On=Black text over white background Off=White text over black background
Cue/Load	Touch to load (then play), touch again to cue to beginning
Play	Play the video
Delegation (top center, double-wide button)	Delegation <ul style="list-style-type: none"> Displays the stripe and row of the selected source when touched and held In Delegation mode (D:), displays the source and name when touched and held
Next	Move to the next video on the device
Previous	Move to the previous video on the device (displays once Next is touched)

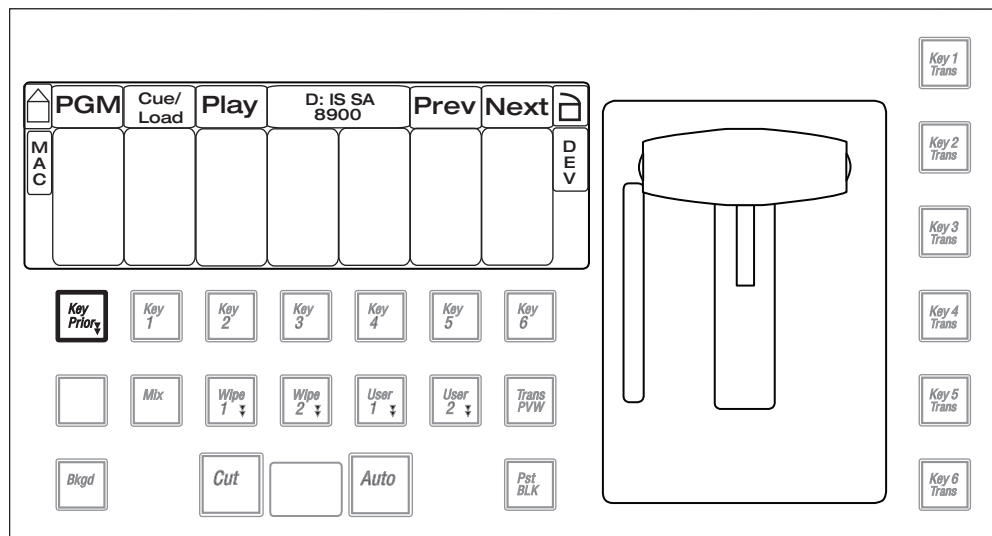

GV Korona, Device Control Mode

Select the Device to Control

- 1 Enable the **DEV** button on the Source Display.
- 2 Press the Source Select button for the device you want to control.
- 3 Use the transport control buttons to play video.

Delegate a Source for Device Control

Once delegated, the device under control cannot be changed by source selection. A 'D:' is displayed in the Delegation button of the Status Display.

- 1 Turn on the **DEV** button.

- 2 Touch and hold the **Delegation** button on the Status Display (pressing and holding the button also displays the row and source selected).
- 3 Press the Source Select row button for the device you want to delegate and control.

Router Interface Operation

Introduction

The GV Switcher system can interface with an external routing system. A routing system connects a *router source* (router input) to a *router destination* (router output). Changing the router source sends a different signal to the destination (called a *take*). A router destination can in turn be connected to a GV Switcher input and be configured as a *routed GV Switcher source* (called *switcher source* in this discussion and in the GV Switcher menus). The router acts as a pre-selector for the switcher source, and so increases the number of inputs available to a button on a GV Switcher system bus.

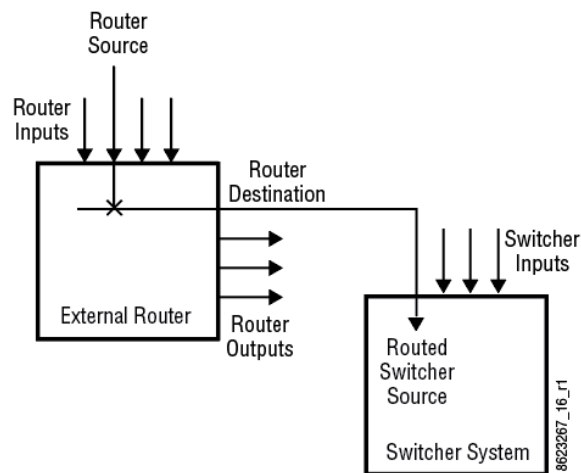

Router Source, Destination, and Routed GV Switcher Source

Router signal switching is non-deterministic, as compared to source selections performed on a production switcher. For this reason, it is better to choose the desired router source in advance, then switch it on-air using switcher controls, rather than select a different router source while it is on-air.

An external router can be configured into *levels*, to allow the switching of multiple signals simultaneously. For example, video signals can be organized on one level, and key signals on another. By specifying both levels when giving a router take command, both the video and key signals of a source will be routed to their destinations.

Note: GV Switcher system router take commands are only applied to all router levels. The external routing system's destinations must be configured with all router levels selected.

Router control panels can also *protect* router destinations from being changed by other control panels. A protected router destination cannot be changed by a different control

panel, but may be changed by the panel that set the protection. Protections help prevent inappropriate router source changes. The GV Switcher system can be considered a type of router control panel, and so the GV Switcher system can protect router destinations. GV Switcher system router protect commands are applied to all router levels.

The names of router sources appear on the GV Switcher system source name displays. These names originate from the router system, and their text cannot be changed from the GV Switcher system. If a routed source has no connection to the router, an **X** appears in place of the router source name. If the router connection exists, but no source has yet been selected for that destination (which can occur during bootup), **No Src** appears.

Features

- Interfaces to the Grass Valley SMS 7000 routing system.
- GV Switcher system configuration of routed sources.
- Names of router sources are shown on GV Switcher Control Panel source name displays.
- Router source selection control via the Control Panel, and Menu Panel.
- Protection types (None, Protect, Protect All, and On Air).
- R-MEM control.

Menu Panel Router Interface Operation

The Router Control menu provides a way to directly change router sources from the Menu Panel. The Router Select menu is reached by pressing the **R-MEM** Menu Panel button, then selecting the **Router Control** category selection button.

Note: Router interface operation becomes available after the GV Switcher system and the external router have been properly configured. See the Installation & Service Manual for your switcher model for additional information.

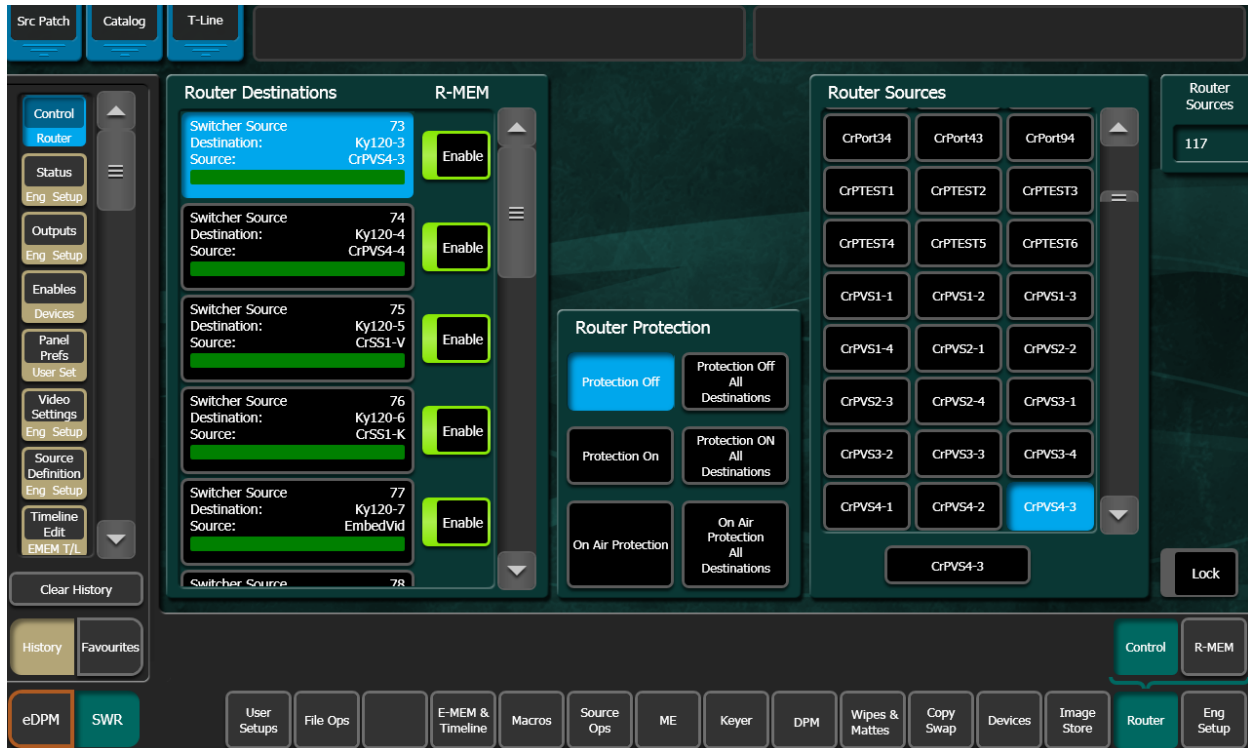

The Router Destination pane on the left is a scrolling list of switcher sources (only sources configured as routed GV Switcher sources appear). Each button displays the Switcher Source ID number, Destination, and Source. The currently selected switcher source on the list is colored light blue.

Refer to the *Kayenne/Karrera/GV Korona Installation & Service Manual* about configuring the Router Ethernet connection.

The Router Sources pane on the right is a scrolling list of all the available router sources. Communication with an external routing system is required before router sources will appear on this list. The router source button of the currently selected switcher source is automatically selected.

Change the Router Source of a Switcher Source

- 1 Select the desired switcher source button in the left pane. Its current router source will appear selected in the right pane.
- 2 Select a different router source button in the right pane, scrolling the menu if necessary. The source change will be immediately enacted.

Router Source Keypad Selection

The Router Source data pad at the top of the right pane provides access to router sources by name. Selecting this data pad opens an alphanumeric keypad, into which you can enter the name of the desired router source. The Router Source list will then scroll to and select that router source, changing that source's output signal. If an exact match is not found for the name entered, no change will occur.

Protection

The Router Protection pane (middle) provides protection controls. These controls are used to send commands to the external router to protect or un-protect the router destination associated with the selected switcher source. The button for the current setting of the selected switcher source will be highlighted. The following protections are available:

- **Protection Off**– Source can be changed at any time by any control panel,
- **Protection Off All Destinations**– Same as Protection Off but for all destinations.
- **Protection On**– Source cannot be changed by another Control Panel, but may be changed from the GV Switcher system,
- **Protection On All Destinations**– Same as Protection On but for all destinations.
- **On Air Protection**– The source cannot be changed by another control panel when it is on-air, but may be changed manually from the GV Switcher system. The source will also not be changed by an R-MEM recall, and
- **On Air Protection All Destinations**– Same as On Air Protection but for all destinations.

External router system panels can place protections on router destinations. The first panel placing a protection controls that destination. The GV Switcher system will not be able to change router sources feeding router destinations protected from another panel, and vice versa.

Router Indexing

The GV Switcher system uses indexing to manage router connections (instead of router names), therefore you can change router source and destination names without affecting router source control.

Add Router Indexing to Shows Created with Earlier Versions

To add indexing to shows created on switcher systems with software earlier than 9.0, you will need to load the show then create a new show with router indexing enabled.

- 1 In the File Ops, Show Files menu, load a show file created using an earlier version of software.
 - a Navigate to and select the show using the System Storage or Remote Storage tabs and navigation buttons in the Directory Search pane (left).
 - b Select **Load Show** in the Show Create & Load menu pane.
- 2 In the Eng Setup, Router menu, select **Index** in the Type menu pane.
- 3 In the File Ops, Show Files menu, select **Create Show** in the Show Create & Load menu pane.

- 4 Name your show by selecting the Show Name data pad, entering the name in the pop-up keyboard, and selecting **Enter**.
- 5 Select your preferences in the Create Show pane (right), and select **Create**.

Router Control of Aux Buses

The GV Switcher can be configured to allow Encore and Prelude control systems, including standalone Prelude Control Panels, to control Aux bus source selections.

All switcher Aux buses can be configured to appear on the Router Control System. Aux buses that are not enabled for router control are seen as being 'protected' by the switcher to the Router Control System. In other words, an Aux bus' current status (source selection) is displayed but it cannot be controlled by the Router Control System.

If an Aux bus is enabled for router control, then the source can be changed by a configured Router Control Panel.

Note: Prelude Control Systems are limited to selecting the first 128 switcher sources.

Control Aux Bus Source Selections from a Router

Aux buses are enabled for control in the Eng Setup, Outputs menu.

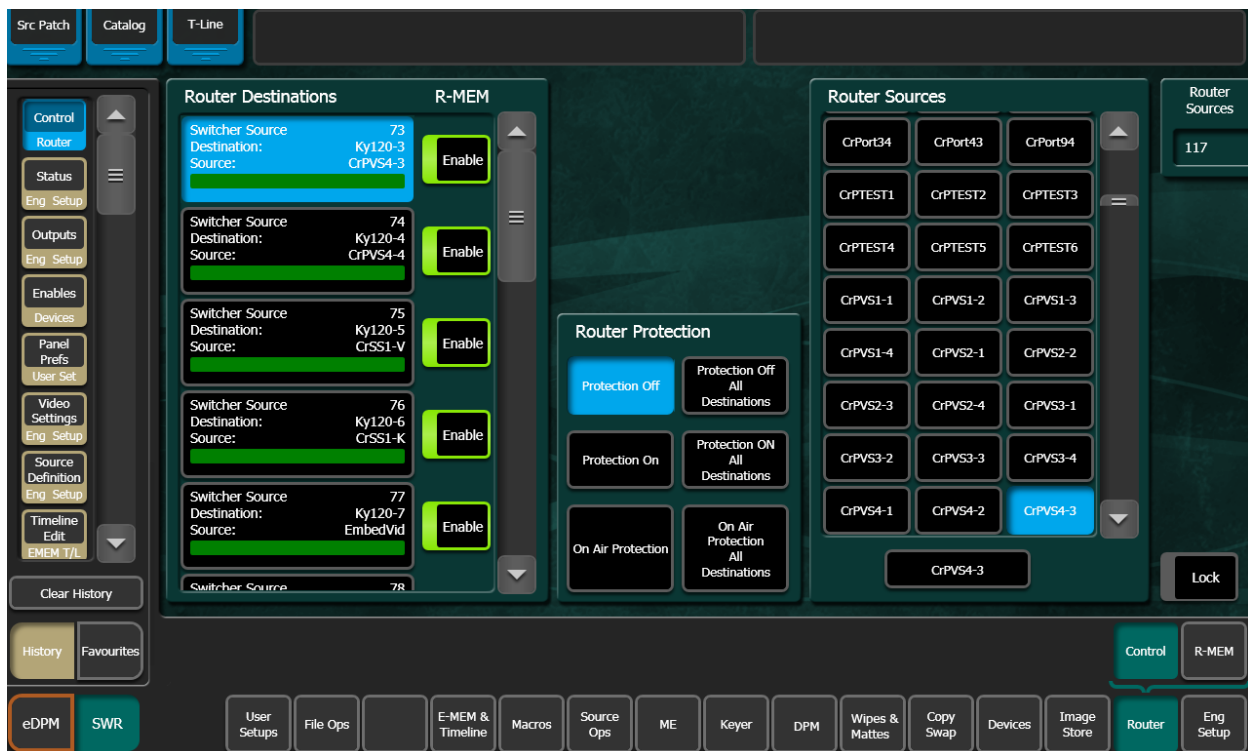

Enable the Aux Buses for router control:

- 1 Select the Aux button in the Output Type.
- 2 Select a Aux 1-46 data pad in the Logical Aux Bus pane to designate it for router control.
- 3 Select the Router Control selector button (highlights green when selected).

Repeat Steps 1-3 for each Aux Bus you wish to control by router.

The router must have the switcher sources defined and the 46 Aux Buses defined as destinations, with four levels each (see the documentation that came with your router):

- Level 1: Suite 1 Video,
- Level 2: Suite 1 Key,
- Level 3: Suite 2 Video, and
- Level 4: Suite 2 Key.

Once configured, you can switch sources on Aux Buses from the external router.

Note: A Prelude router can communicate directly with the GV Switcher switcher.

About R-MEM (Router Memory Registers)

With R-MEMs, you can use the GV Switcher system to store groups of external router source selections for use later. One or all switcher sources can be selected for control, and the router source selections for all the selected switcher sources can be recalled and enacted quickly.

R-MEM operation is similar to E-MEM, in that information is learned into a register for later recall. Each R-MEM register holds a router source name for one or more switcher sources. R-MEM allows selectively enabling router destinations for control, and has Auto Recall, both similar to E-MEMs selection of enable groups.

R-MEM can be assigned to an E-MEM enable group, if desired, to provide E-MEM control of R-MEM functions (see [About E-MEM Control of R-MEM](#), on page 244).

Features

- 100 R-MEM registers.
- Select 1 or more switcher sources for R-MEM control.
- Instantaneous Learn and Recall.
- Save To and Load From Disk.
- Auto Recall.
- Preview of R-MEM register source and destination names.
- E-MEM control of R-MEM, if desired.

R-MEM Menu Operation

R-MEM registers are learned, recalled, and previewed from the R-MEM menu. The R-MEM menu is accessed by pressing the **Router** Menu Panel button, then selecting the **R-MEM** category selection button.

R-MEM Menu

The R-MEM menu has a Router Destinations pane on the left showing the switcher sources, router sources and destinations, and protection status. Switcher sources configured as routed sources also appear in the left pane. There is a Mode pane in the center and an R-MEM pane on the right listing the R-MEM registers available (the full register number is displayed on each register button).

R-MEM Auto Recall

The R-MEM *Auto Recall* mode acts similar to the E-MEM Auto Recall. An R-MEM Auto Recall automatically changes only the switcher sources that were enabled when the register was learned.

Preview

When *Preview* mode is turned on, recalling a register will only display the R-MEM settings stored in that register. No switcher sources will change. This allows you to see what switcher sources will be affected by a register recall, and what the router sources and destinations will be after the recall.

When Preview is turned off, the left pane returns to displaying the current status, including any previously set enables.

Learn an R-MEM Register

- 1 Enable the switcher sources to be affected by R-MEM in the left pane. Selected switcher source buttons are green on the left. Only the selected sources will be saved to the R-MEM. You can use the **Enable All** button to select all or none of the switcher sources (toggle).
- 2 If you want the register to use Auto Recall, select the **Auto Recall** button so its indicator illuminates.
- 3 Select the **Learn** button in the Mode pane.
- 4 Select the numbered Bank and Register buttons in the right pane to save the information to the selected register. Select the bank button first if you are saving to a different bank. If the desired bank is already selected, you can select just the Register button.

Recall an R-MEM Register

- 1 Make sure the Preview mode button is not selected.
- 2 Turn the **Auto Recall** button on or off to control how the register is recalled.
- 3 Select the Bank and Register buttons for the desired register. Select the bank button first if you are recalling from a different bank, or just select the Register button if in the same bank.
 - a If the **Auto Recall** button is on, the sources selected when the register was saved (with Auto Recall on) will be changed to the R-MEM values of that register. If Auto Recall was not on when the register was saved, the currently selected switcher sources will be changed.

- b If the **Auto Recall** button is off, the sources currently selected in the Switcher source pane will be updated with the R-MEM values of that register.

Note: A switcher source that is currently on-air with an *On Air* protection status cannot be changed by an R-MEM recall. Either place the source off-air or select a different protection status to change the switcher source selection.

About E-MEM Control of R-MEM

R-MEM can be assigned to an E-MEM Enable group, to permit E-MEM control of R-MEM settings. R-MEM information is learned to the R-MEM level of an E-MEM register, allowing the selection of specified router sources when that E-MEM register is recalled. One R-MEM setting is supported per effect (R-MEM is not keyframeable).

Because R-MEM is a level of E-MEM, there is a one-to-one correspondence between E-MEM and R-MEM registers. For example, settings in R-MEM register 10 only apply to E-MEM register 10. This is similar to the relationship between an individual M/E E-MEM and the Master E-MEM system. R-MEM information is added to an E-MEM register using the Learn operation or the Learn Mod operation.

R-MEM Disk Storage

While R-MEM is organized operationally as a level of an E-MEM register, R-MEM data is saved to disk separately, as R-MEM registers. This allows added flexibility. For example, the same E-MEM effect can use different router source selections or enables, depending on which R-MEM register has been loaded from disk.

R-MEM Enable Control and Auto Recall

R-MEM also provides an additional level of control. R-MEM has its own set of enables that control which sources (router destinations) are affected by a recall operation. This aspect of R-MEM is like the enable groups used for Master E-MEM. The Auto Recall button on the R-MEM menu controls R-MEM recalls similar to the control the Auto Recall button in the Control Panel Master E-MEM Module exerts over E-MEM recalls. These are separate functions affecting different control elements, however.

An example of using this is to control which router sources will be changed without having to learn a new E-MEM register for each variation. Suppose you learn an R-MEM specifying router sources for several switcher sources, create an E-MEM effect using those sources, and learn that E-MEM with the R-MEM Enable button selected. Recalling that E-MEM with the Master E-MEM Auto Recall button on, will also recall that R-MEM. If the R-MEM Auto Recall button is also on, the enabled switcher sources will select the specified router sources. If the R-MEM Auto Recall button is off, only the switcher sources enabled on the R-MEM menu will be affected by the recall. Disabling all the switcher sources on the menu makes the E-MEM recall use the currently selected router sources, with no changes.

E-MEM Prefs Assignment

By default R-MEM is not assigned to any E-MEM Enable group button. You use the E-MEM Prefs menu (accessed in the User Setups, Suite Prefs, E-MEM Prefs menu), to make an assignment. Select the R-MEM data pad, then select the desired Enable button.

Once this assignment has been made, recalling an E-MEM register in the Master E-MEM Module will recall that same number R-MEM register. Learning an E-MEM register in the Master E-MEM Module will also learn the same R-MEM register.

CAUTION: : Make sure the R-MEM enable group you choose is only enabled when you actually need to use it during effect recalls. Confusing source selection button changes can occur otherwise. Using E-MEM Auto Recall can help control when groups are enabled.

Learn R-MEMs from the Control Panel

When R-MEM has been assigned to an E-MEM Enable button, learns can be performed from the Control Panel as well as the R-MEM menu.

Note: The Learn operation you will use erases any existing information in all the enabled levels of the current E-MEM register.

- 1 On the Master E-MEM Module, select the Enable button to which R-MEM has been assigned. This enables R-MEM for the current effect register.
- 2 Setup the desired R-MEM state.
 - a Go to the R-MEM Router Select menu (accessed via Router, Control) and select the router source to be used with each switcher source.

- b Go to the R-MEM menu (select the R-MEM category selection button) and enable the desired switcher sources. Select **Auto Recall** if you want the ability to recall R-MEM settings for only the selected switcher sources.

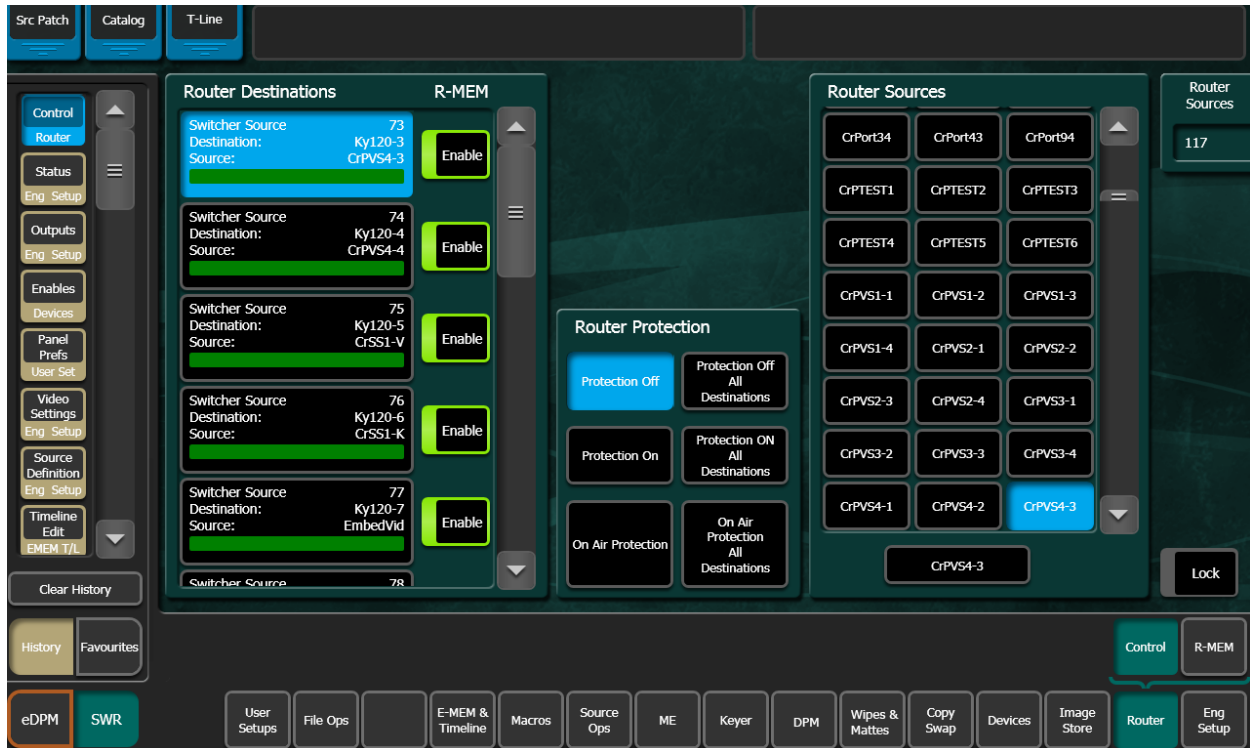

- 3 Press the **LRN** button in the Control Panel Master E-MEM Module, then press the Page, Bank, and Register keypad number of the desired register. This will save the current R-MEM setting in the menu to the header area of that E-MEM effect register and the first keyframe of the new effect will be created. The corresponding R-MEM register in the menu will also be updated.

Change R-MEM on an Existing E-MEM Register

- 1 On the Master E-MEM Module, recall the E-MEM register you wish to change.
- 2 On the Master E-MEM Module, select the Enable button to which R-MEM has been assigned.
- 3 Setup the desired R-MEM state.
 - a Go to the R-MEM Router, Control menu (accessed via Router, Control) and select the router source to be used with each switcher source.
 - b Go to the R-MEM menu (select the **R-MEM** category selection button) and enable the desired switcher sources. Select **Auto Recall** if you want the ability to recall R-MEM settings for only the selected switcher sources.
- 4 On the Master E-MEM Module, press Learn. The R-MEM setting in the menu will be updated to the header area of that E-MEM effect register. Keyframes existing in the

effect will remain unchanged. The corresponding R-MEM register in the menu will also be updated.

Loading R-MEM Registers

Like E-MEM registers, loading an R-MEM register from disk does not affect the current work buffer. If an effect is loaded in the work buffer and that register number containing different settings is loaded from disk, the register will need to be recalled before any changes in state occur.

About Empty R-MEM Keyframes

If the R-MEM enable button is on when keyframes on other levels are inserted into the effect, R-MEM keyframes containing effectively no data will also be added to the effect and appear on the Timeline menu. These keyframes are only system artifacts and do not influence the running of the effect.

Camera Control with Ethernet Camera Tally

GV Switcher Camera Integration provides the ability to place cameras into a usable but not fully shaded setup/rehearsal mode. The GV Switcher can connect to up to 99 cameras via the Grass Valley LDK Connect Gateway. Cameras can be acquired by multiple suites.

Note: For configuration information, refer to the *Kayenne/Karrera/GV Korona Installation & Service Manual*.

Switcher camera control is provided in the menu.

Camera control from the GV Switcher system makes camera source setup fast and easy by allowing you to:

- Turn color bars on/off to quickly identify which source is associated with a camera,
- Control a subset of camera settings:
 - Auto Iris enable/disable,
 - Auto Black level (trigger),
 - ND (Neutral Density) Filter settings, and
- Load a Scene File with a single button push or recall a Scene File with an E-MEM.

Note: The Camera sub-level is assigned to an E-MEM level in the Menu Panel.

Ethernet Camera Tally allows you to:

- Tally camera associated sources using Tally Calcs and,
- Tally the Red, Yellow, or Green indicator on the camera from the switcher Menu Panel/Control Panel.

Camera Operations

Camera control from the GV Switcher switcher provides remote control of a subset of camera functions. Camera user operations from the menu are performed in the Source Ops, Cameras, Live Ops menu tab.

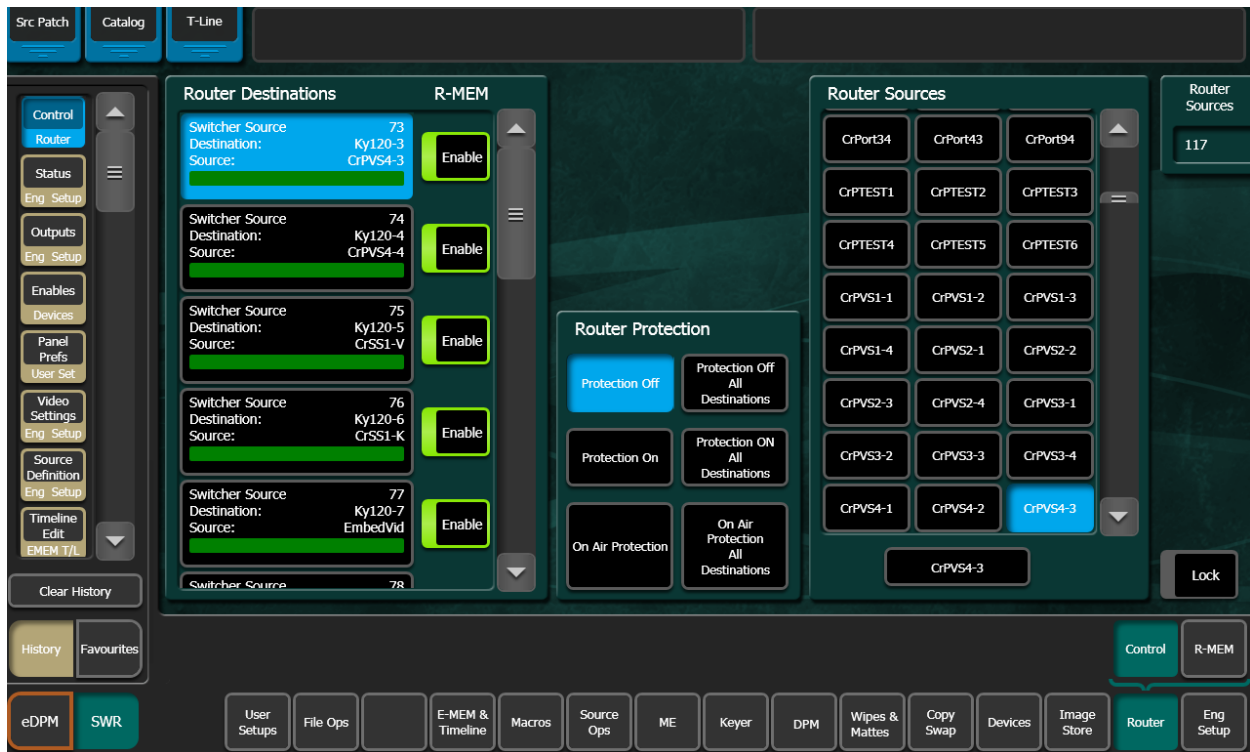

GV Switcher camera control provides the ability to place cameras into a usable but not fully shaded setup/rehearsal mode using the menu buttons in the Live Ops menu tab:

- Camera Sources—Select from 1-99 defined camera sources for control.
- Color Bars—Enable/disable color bars to verify the camera as the associated source.
- Auto Iris—Enable/disable camera's Auto Iris.
- Auto Black—Triggers a reset of camera's black level.
- ND (Neutral Density) Filter— Changes the neutral density filter wheel setting.

Use back and forward arrow buttons to scroll through and enable 1/4, 1/16, 1/64 filter wheel settings, or CLR to clear the filter wheel setting.

Ethernet Camera Tally Operations

When installed and configured, the GV Switcher sends tally over Ethernet to cameras. This is described in the Installation & Service Manual for your switcher model. In addition, the **Red**, **Yellow**, and **Green** buttons in the Source Ops, Cameras menu allow you to test the camera tally colors and/or send a call to the camera operator.

About Scene Files

Up to four Scene Files can be saved and quickly loaded to selected cameras with the **Fast Recall (1-4)** buttons or recalled as part of an E-MEM, using the **Scene File in E-MEM (1-4)** buttons, in the Source Ops, Cameras, Scene Files menu tab.

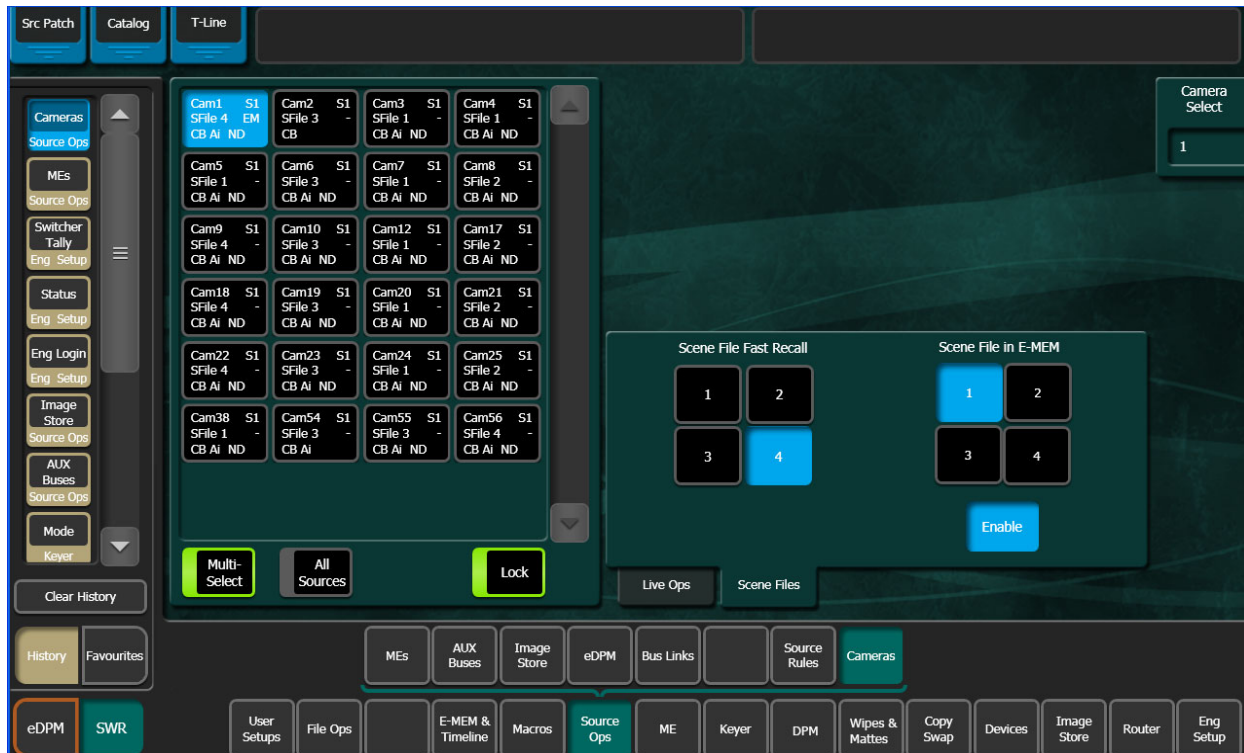

Scene File Fast Recall allows you to recall scene files 1, 2, 3, or 4 to all selected cameras in the Camera Source list. Simply select a camera source or sources and select a Scene File Fast Recall (1-4) button.

For Scene Files in E-MEM, the Camera level button is in the User Setups, E-MEM Prefs menu and can be used to assign camera sub-levels to levels (and are definable) and recalled as part of an E-MEM. E-MEMs can be used for example so the TD could recall and turn off a Star Filter on all cameras instead of it being an engineering task.

- 1 Select a camera source or sources in the Camera Sources list.
- 2 In the Scene Files menu, select the numbered **Scene File in E-MEM (1-4)** button for the scene file you wish to save as part of an E-MEM.
- 3 Select the **Enable** button (highlights blue when on). **EM** (for E-MEM) is displayed in the selected camera's button data.
- 4 Select **User Setups, Suite Prefs, E-MEM Prefs, Cameras**.
- 5 Select the level to which you wish to assign the Camera's sub-level and select **Done**.
- 6 Build an E-MEM recalling the level with the camera sub-level assigned.

The enabled Scene File will be recalled for the selected cameras.

About Newton Modular Control

The Newton modular control system provides comprehensive and consolidated real-time control of Grass Valley modular products. Some Newton functionality has been incorporated into the GV Switcher menu application. This makes it possible to control Grass Valley Gecko and Kameleon frame modular products from a GV Switcher menu. The modular frames must reside on the same subnet as the GV Switcher system.

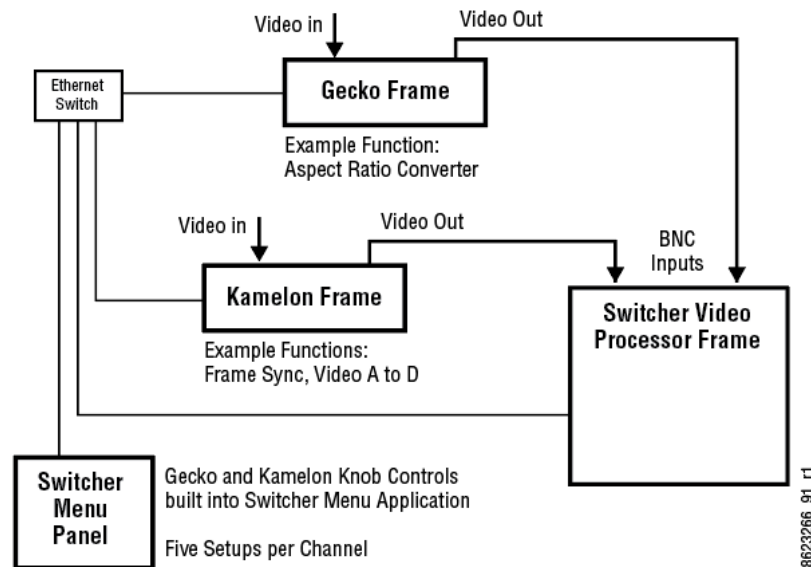

Newton Modular Control

Installation on GV Switcher

The GV Switcher's Newton interface is installed during the standard GV Switcher menu application installation procedure. The Newton menu is available on all GV Switcher systems. However, a Newton system must be available on the GV Switcher network, and configuration steps will be required before this menu becomes functional.

Selecting the NetConfig installation option from the GV Switcher Installer program will install a compatible version of NetConfig with the NetConfig Newton Configurator plug-in.

Newton Controls Configuration

Newton functionality within GV Switcher can be configured using any PC on the GV Switcher network, provided the configuration tools are installed onto that PC. Select the **NetConfig** option in the GV Switcher Installer program to install these configuration tools. During this process, the NetConfig network configuration application and a Newton

Configurator plug-in are installed. The tool is accessed by launching NetConfig and selecting the Newton tab on the top menu bar.

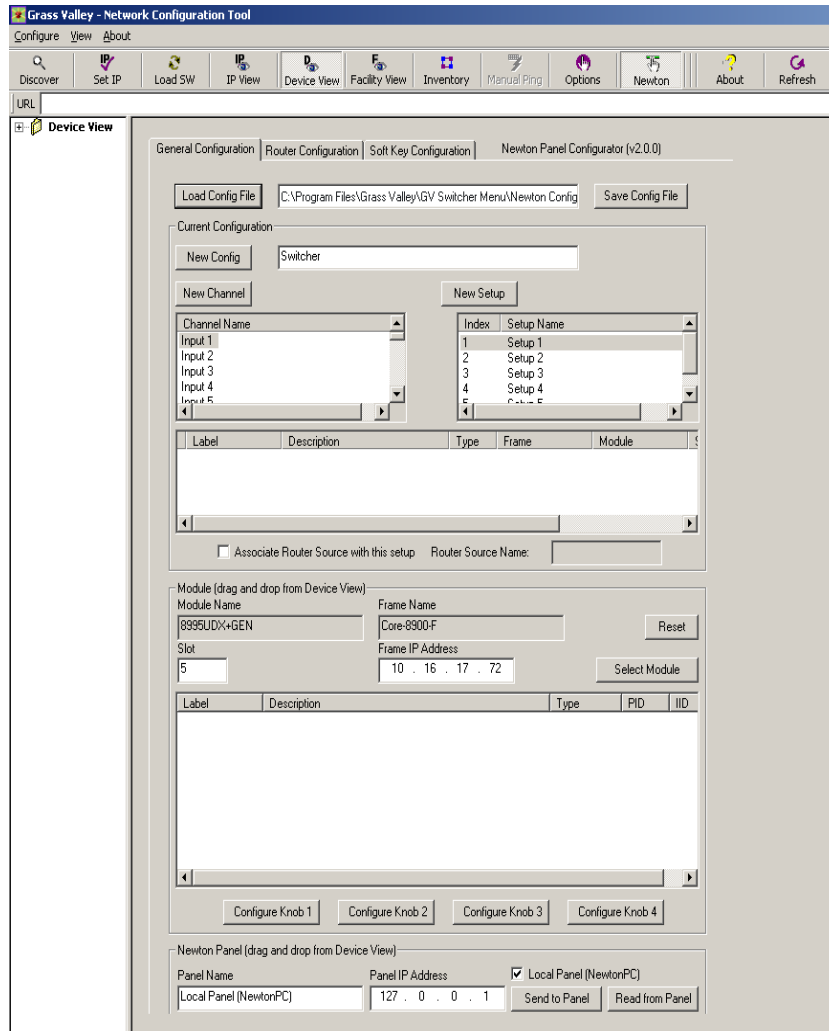

NetConfig Newton Configurator Plug-in

The Configurator tool is used to define the functionality of Newton controls by creating a Newton configuration file. The Newton configuration establishes a one-to-one relationship of Newton channels to GV Switcher physical inputs (BNC connectors on the Video Processor Frame). Each GV Switcher input/Newton channel can have up to five different setups defined. A default Newton configuration file with 96 channels (inputs) is provided with five empty setups for each channel. Using the configurator, controllable parameters in modules which are in the video path for each switcher input can be assigned to GV Switcher Menu Panel knobs. The user is then able to control those modules directly from the GV Switcher system.

Refer to the separate Newton Instruction Manual and NetConfig Instruction Manual for specific information about how to configure the Newton controls. These manuals are available for download from the Grass Valley website.

External Device Newton Menu Description

Once configured, module parameters can be adjusted in the Devices, Newton menu.

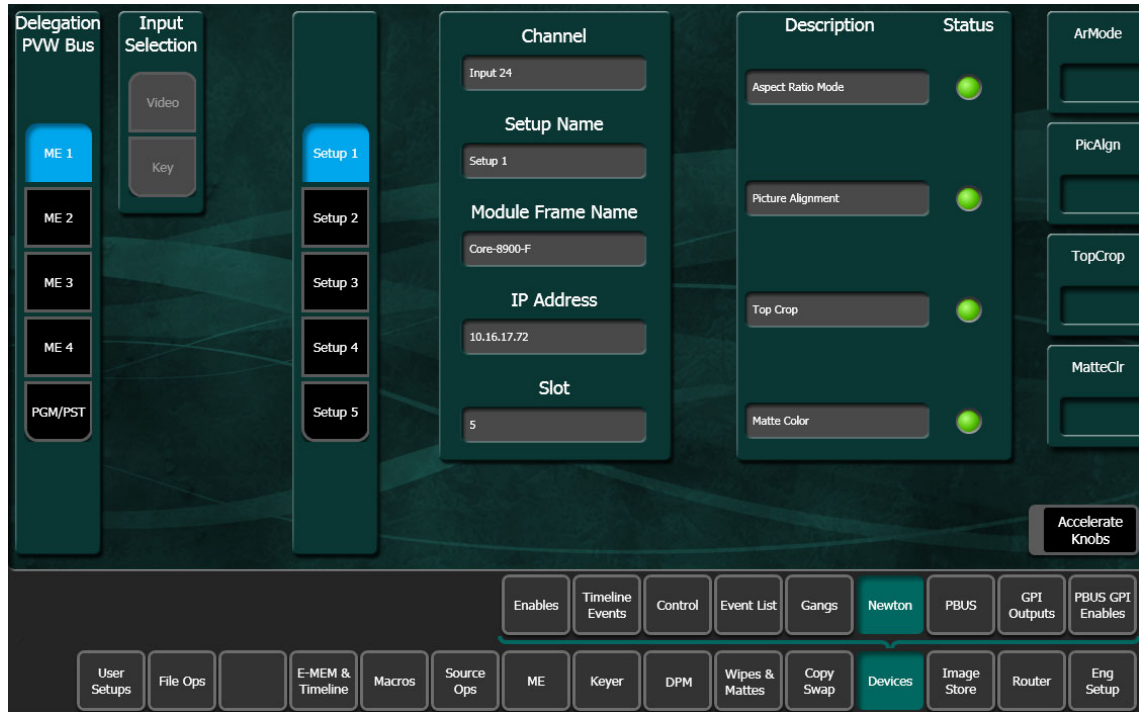

Selection of a module parameter to control is mediated through the GV Switcher source selection mechanism. By selecting a source on the currently delegated Preview bus of the GV Switcher's Control Panel, the source's physical input, and that input's associated Newton channel controls are activated on the GV Switcher's Device menu.

About the Delegation Pvw Bus

The Delegation Pvw Bus pane is used to select which Preview bus will be used to select the Newton channel to be controlled.

About Input Selection

When a video/key source is selected, you choose to control either the video input or the key input with the Video and Key buttons.

About the Setup Selector

The Setup buttons are used to select the desired set of controls from the setups defined for that channel. The menu displays asterisks for setups that have no parameters assigned.

Newton Channel Information

Channel – The number of the GV Switcher input BNC used to select the current Newton channel is displayed.

Setup Name – The currently selected setup (1-5) is displayed in this pane.

Additional information for the currently selected channel is displayed below.

If multiple modules are daisy chained together in a Newton channel, the information displayed will be for the module with a parameter assigned to the top knob.

About Newton Controls

On the right side of the menu the active control functions are identified. Direct knob control and data pad numeric entry are available. The menu displays asterisks for unconfigured controls. The status of the function for each control is also reported, with green indicating a connection exists and the data is valid, and red indicating no connection.

Accelerate Knobs – Selecting this button accelerates knob adjustments by a factor of 10, providing coarse and fine knob control.

Refer to the separate Newton Instruction Manual for specific information about Newton controls.

Advanced Operations



About Effect Editing with E-MEM & Timeline

Effect editing involves changing work buffer values using panel and/or menu controls, then applying these values to the effect. This discussion concerns effect editing using the Master Timeline for the examples.

Inserting a Keyframe

CAUTION: Timeline effects with a pause inserted cannot be run in reverse.

The Insert Before and Insert After operations are used to insert new keyframes onto the timeline of an effect. The result of the Insert operation varies depending on whether the edit cursor is on a keyframe or between keyframes (on the path).

An inserted keyframe has both work buffer values and a duration. The keyframe duration is calculated by the GV Switcher system (time to the next keyframe) and is not actually contained in the keyframe data. This permits added flexibility during effect editing.

Inserting a Keyframe With Insert After

When the edit cursor is on a keyframe, pressing **Insert After** inserts a new keyframe after the current one. The insert occurs after the duration of the keyframe the cursor is on, at the next numbered Master Timeline keyframe location. This inserted keyframe's duration is, by default, the duration of the keyframe the cursor was positioned on before the insert, though this value can be changed by the operator ([About Keyframe Durations](#), on

page 259). The edit cursor also moves to the start of the new keyframe. This operation will increase the duration of the effect by the duration of the inserted keyframe.

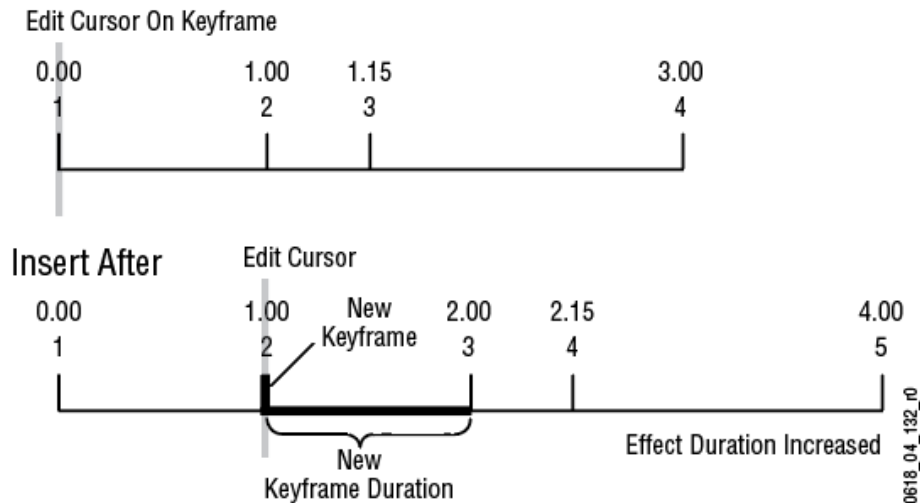

New Keyframe Inserted After

Insert on a Keyframe With Insert Before

When the edit cursor is on a keyframe, pressing Insert Before inserts a new keyframe at that time line location. The old keyframe, and all the keyframes that follow, are moved to the right the length of the new keyframe's duration. This operation will increase the duration of the effect by the duration of the inserted keyframe, which by default is the duration of the keyframe the cursor was originally positioned on before the insert, though this can be changed ([About Keyframe Durations](#), on page 259). Note that keyframes are renumbered after the insert. In the example, what was keyframe #1 becomes keyframe #2.

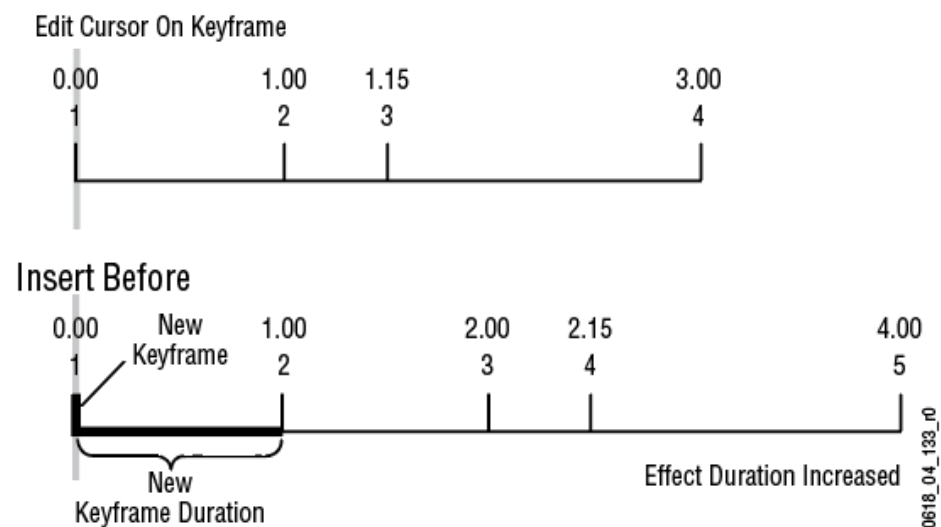

New Keyframe Inserted Before

Insert After or Insert Before on a Keyframe

In an existing effect, an Insert After at the keyframe 2 location would seem to be the same as an Insert Before at the keyframe 3 location, but this is usually not true. The work buffer material inserted into an effect is typically based on an existing keyframe, with some modifications. For Insert After keyframe 2, the starting point for the inserted work buffer data will be keyframe 2 values. For Insert Before keyframe 3, however, the inserted material will be based on keyframe 3 values. If the starting parameters in keyframe 2 and 3 are different from one another, the look of the resulting effect will vary depending on which Insert operation is performed.

Insert a Keyframe on the Path

When the edit cursor is not positioned on a keyframe, the insert operation inserts a new keyframe at the current location. This is called inserting on the *path*. The default duration of new keyframe inserted on the path will be the time between the cursor location and the next keyframe on the Master Timeline. The **Insert After** and **Insert Before** buttons perform the same operation when you insert on the path.

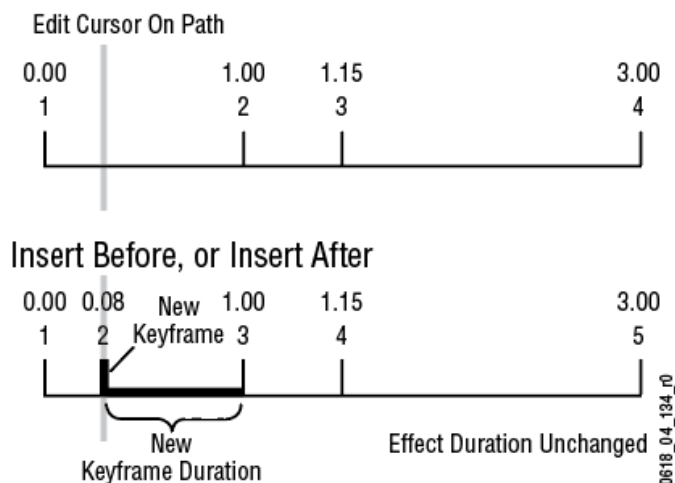

New Keyframe Inserted on the Path

Note that after inserting on the path, the preceding keyframe's duration is shortened and the new keyframe's duration extends to the next keyframe. When keyframes are inserted on the path the overall effect duration does not change.

When an empty register is recalled, no keyframes exist yet for the cursor to be on or between. In this situation, because the cursor is not on a keyframe the Insert operation inserts on the path. This is why either Insert button can be pressed to create the first keyframe in a new effect.

Build an Effect By Inserting a Keyframe on the Path

You can build an entire effect by inserting every keyframe on the path in the Master E-MEM Module. Keyframe durations will be automatically calculated by the system. This can be useful if you need to build an effect to match some pre-recorded material.

- 1 Review the recorded material and determine the times that keyframes are needed. In this example, keyframes are needed at 1.5 seconds, 2.5 seconds, and 3 seconds.
- 2 Bring up an empty register (**LRN**, *****), set up the look for the first keyframe and then press either **<Ins** (Insert Before), **>Ins** (Insert After) or **Mod** to add that keyframe to start the effect.
- 3 Press **GoTM, 1, *, 15, ENT** to move the cursor one and a half seconds into the effect, set up the second keyframe and add it to the effect.
- 4 Press **GoTM, 2, *, 15, ENT**, set up the third keyframe and add it.
- 5 Press **GoTM, 3, *, ENT**, set up the last keyframe and add it.

The effect will now exactly match the recorded material. Using E-MEM, you can run the effect and the recording simultaneously (see [About E-MEM Control of External Devices](#), on page 215).

Deleting a Keyframe

In the menu, when the edit cursor is on a keyframe, pressing **Delete** removes that keyframe from the effect. The Delete button is inactive when the edit cursor is on the path.

Delete behavior is affected by Constant Duration mode. When Constant Duration is OFF, the duration of the deleted keyframe is also removed from the effect (time to the next keyframe). When Constant Duration is ON, the duration of the previous keyframe is increased by the deleted keyframe's duration, so the total duration of the effect is unchanged. After a delete operation, any keyframes following the deleted keyframe are renumbered accordingly.

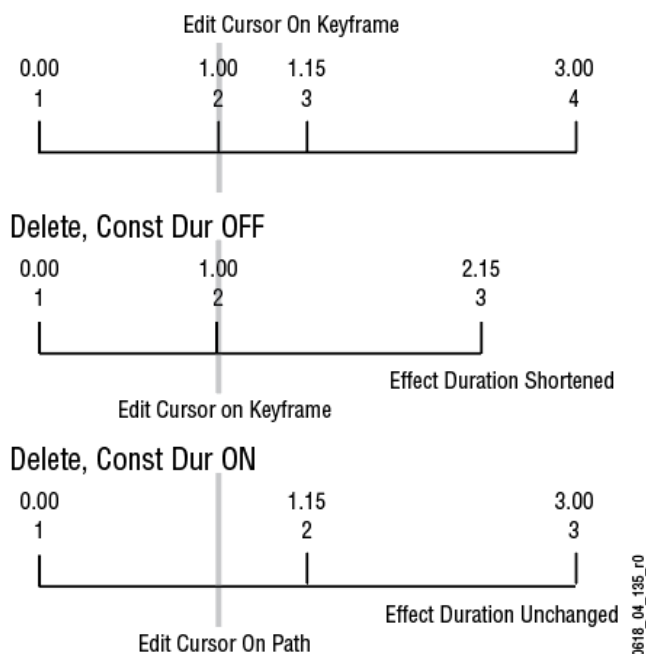

Delete Keyframe

Note that after a Delete with Constant Duration ON the cursor is located on the path, not on a keyframe. You will need to move the cursor to a keyframe before you can use Delete again.

About Keyframe Durations

Pressing the **KF Duration** button in the E-MEM & Timeline menu assigns the keyframe duration value to the keypad. Once assigned, keyframe durations will be displayed on the Master E-MEM status display. When the cursor is moved from keyframe to keyframe, the value will change to reflect the duration of the keyframe where the cursor is located. When the cursor is moved between keyframes, the duration shown is the distance from the current time to the next numbered Master Timeline keyframe. The time value displayed is used by default when a new keyframe is inserted into an effect.

Change Duration for a New Keyframe

The value for a new keyframe's duration may be set from the keypad.

- 1 Move the edit cursor to the desired location in the effect, in this case on the path midway through a one second keyframe.
- 2 Press **KF Duration** button.
- 3 Type a **1.0** duration value on the keypad and press **Enter** to change the value displayed on the readout.

Note: Pressing Emem Edit, <enter value>, TRIM in the Master E-MEM Module will increase or decrease the duration value by the amount specified.

- 4 Press **Insert Before** or **Insert After** to insert the new keyframe with the specified duration.

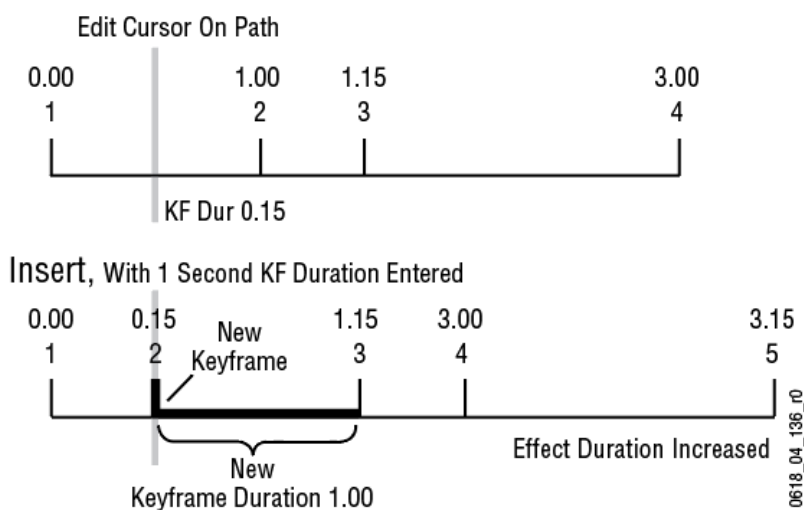

Duration Specified for Inserted Keyframe

Modify an Existing Keyframe Duration

The duration of an existing keyframe can also be modified.

- 1 Move the cursor to the keyframe whose duration you wish to modify. You cannot modify a keyframe duration when the cursor is on the path. In this case, the keyframe duration is 15 frames.
- 2 Press the **KF Duration** button to display the keypad.
- 3 Type a **1.0** duration value on the keypad and press **Enter** to change the value displayed on the readout.
- 4 Press **Modify** to apply the new duration value to the keyframe.

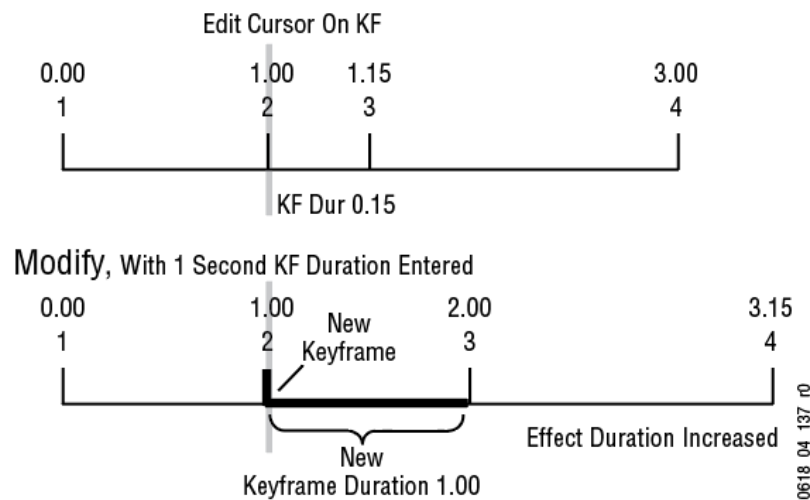

Existing Keyframe Duration Modified

Restore KF Duration Default to the Keypad

The keypad retains the last duration value entered until it is changed on the keypad, or until the edit cursor is moved to a new location with a different duration. You can reset the keypad to the factory default of one second duration, at any time

- 1 Press the **KF Duration** button to display the keypad.
- 2 Press **.** (dot).

About Effect Duration Editing

When an effect is first created it has a “natural duration”, which is the time indicated by the last keyframe. With the Effect Duration feature you can make the overall length of the effect longer or shorter with a single command. Each keyframe duration in the effect will be increased or decreased proportionately to match the new “forced duration”.

Edit Effect Durations from the Control Panel

- 1 Select the effect whose duration you wish to change.
- 2 Select the **Ef Dur** button on the Master E-MEM Module.

- 3 Type a new duration in Seconds • Frames • Field format and select **Enter**. Entering a single value defaults to frames, and the third Field value is optional. Entering a **1** for the Field value specifies odd field. For example, **1.0.1** indicates 1 second, 0 frames, 1 field.

Note: Entering only a • (dot) restores the natural duration of the effect.

Edit Effect Durations from the Menu

- 1 Select the effect whose duration you wish to change.
- 2 Select **E-MEM & Timeline, Timeline Edit** in the Menu.

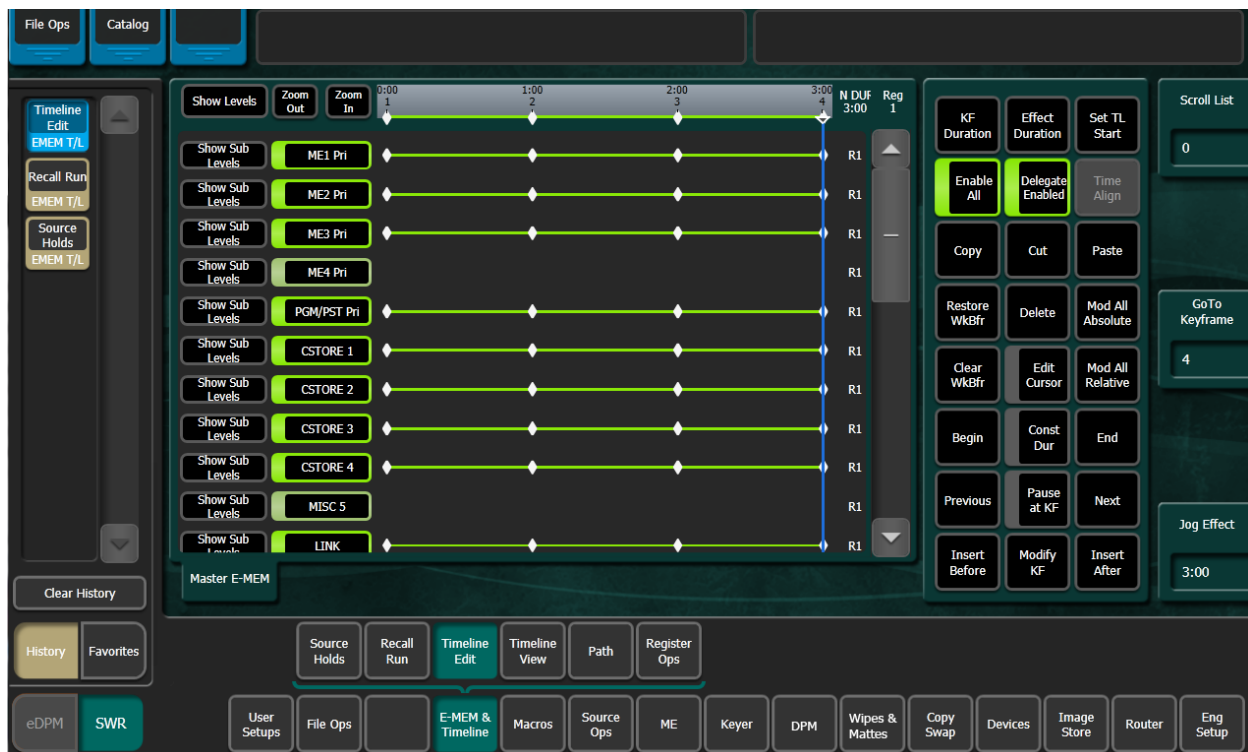

- 3 Select the **Effect Duration** button to open a keypad (located in pane, just right of the Timeline view). Type a new duration in Seconds • Frames • Fields format and select **Enter**.

Note: Entering only a • (dot) restores the natural duration of the effect.

- 4 The new Forced Duration (F (Forced) DUR 8:00) of the event is showing at the right end of the white Duration box at the top of the Timeline View pane.

About Editing Effect Durations of Individual Levels

You can apply Forced Duration to individual levels by selecting only those levels for modification. In the example below the first three levels have been set to a Forced Duration of 5 seconds and the other levels remain at the Natural Duration of 4 seconds. The Natural

and Forced Duration values are reported in the menu on the right-hand side of the screen. The Natural Duration values are indicated with the letter "N" to the right of the time display.

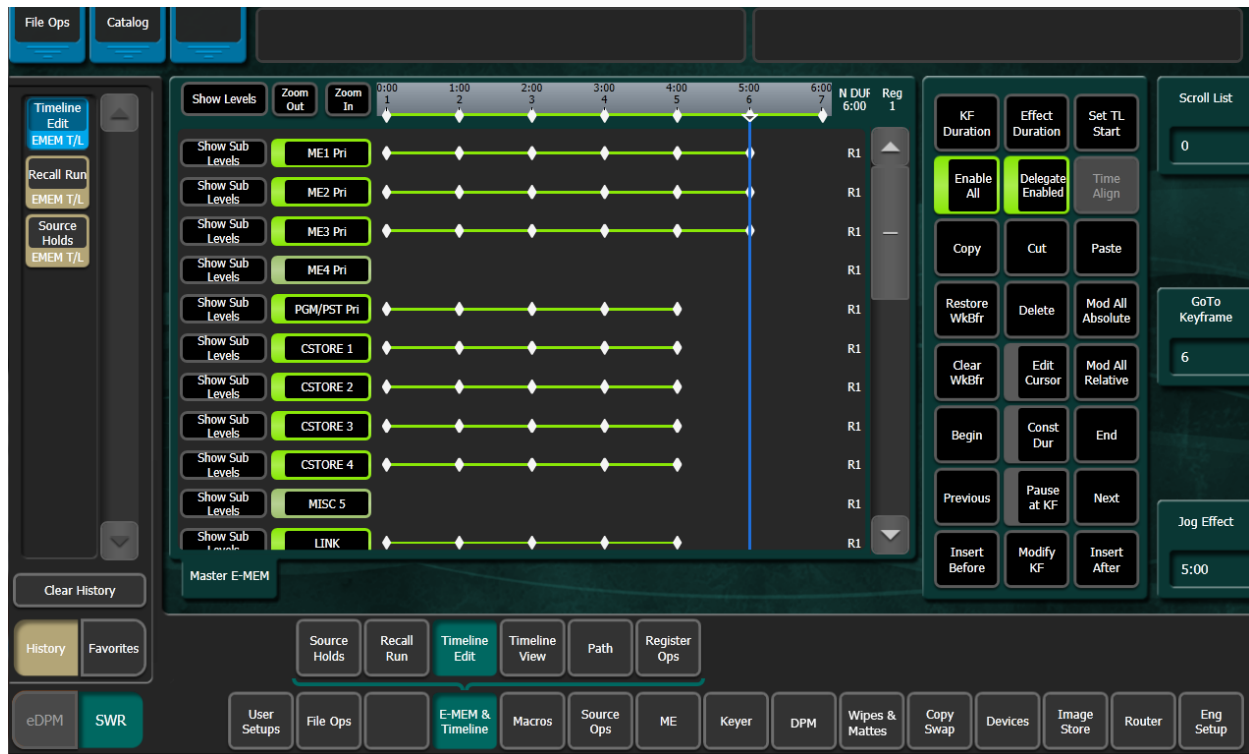

About E-MEM Modify All Operations

The Modify All function can be used to modify selected values of all the keyframes in an effect that are on levels delegated for editing. Keyframes on levels not delegated for editing are unaffected.

Modify All operations only affect parameters that have been modified in the work buffer from the values of the current position of the time cursor. Typically this position is the current keyframe, but it could be the interpolated state on the path between keyframes. If the cursor is on the path, the Modify All function will also add a keyframe to the effect at that location. Modifications to the work buffer are made by pressing a button, turning a knob, or entering a value with the key pad.

Two different types of Modify All functions are available:

Modify All Relative operations calculate a difference between the current value at the time cursor position and the current work buffer value for each changed parameter. This difference is applied to all the affected key frames in the effect. For example, a hue change of 30 degrees will shift different hues by that amount, and will not change them to the same hue. This function is performed by selecting the Modify All Relative button on the Timeline Edit menu.

Modify All Absolute operations replace the current value of parameters of all affected keyframes in the effect with the current value of each changed parameter in the work buffer. For example, if a hue was changed 30 degrees to make it red, different hues on other keyframes will be changed to red, not shifted 30 degrees. Exact values, not differences,

result. This function is performed by selecting the Mod All Absolute button on the Timeline Edit menu.

Mode changes are always absolute. Turning a function on turns it on for all affected keyframes, and does not toggle on functions off.

Perform a Modify All Operation

- 1 Delegate for editing the levels in the effect you wish to be affected by the modifications.
- 2 Move the time cursor to the location in the effect you wish to use as a baseline for the operation.
- 3 Change the desired parameters by pressing a button, turning a knob, or entering a value with the key pad.
- 4 Perform the desired relative or absolute modify operation:
 - To make relative changes, access the Timeline Edit menu by selecting **E-MEM & Timeline, Timeline Edit**, then select the **Mod All Relative** button. The relative changes of the modified parameters will be applied to all the affected keyframes in the effect.
 - To make absolute changes, access the Timeline Edit menu by selecting **E-MEM & Timeline, Timeline Edit**, then select the **Mod All Absolute** button. The absolute values of the modified parameters in the work buffer will be applied to all the affected keyframes in the effect.

Note: When using the Modify All Absolute feature, it is recommended that only one parameter at a time is modified to prevent, for example, all keyframes being moved to the same position.

About E-MEM Learn Auto Recall

Each E-MEM register contains header information, along with keyframe data. Header information applies to the entire effect and is not keyframable. Register header information includes:

- E-MEM enable group button selections (for Auto Recall)
- Effect Dissolve state (on or off)
- Effect Dissolve rate (seconds, frames, field)

When an effect is edited in the standard manner (Insert Before/After, Modify Keyframe, Modify All), only keyframe data is affected. The header information does not change. In a standard Learn operation, all existing keyframe data is overwritten with a single keyframe, and new header information is saved.

Update E-MEM Register Header Information

Learn Auto Recall can be used to update E-MEM register header information without changing keyframe data.

- 1 In the Master E-MEM Module of the Control Panel, select the state of the desired header information.
- 2 Press **LRN, Auto Recall**.

Set the Enable Groups Associated with Auto Recall

Levels of the switcher can either be included or excluded from Auto Recall using the level buttons in the Master E-MEM Module of the Control Panel.

- 1 Press **Auto Recall** in the Master E-MEM Module so it is on.
- 2 Press to enable the level buttons in the Master E-MEM you wish to include with Auto Recall.
- 3 Press **LRN, Auto Recall**.

Set the Effect Dissolve Rate for Auto Recall in an E-MEM Register

Set the dissolve rate to seconds, frames, or fields; for example entering 1.0 results in a one second dissolve rate where entering 10 results in a 10 frame dissolve rate, and entering .01 results in a one frame dissolve rate.

- 1 In the Master E-MEM Module of the Control Panel, press **LRN, DIS, RTE**.
- 2 Press the buttons under the keypad numbers to select seconds, frames, or fields for the dissolve rate and press **ENT**.
- 3 Press the button for the register you wish to apply the effect dissolve rate.

Change Path Control Values in an Effect

Path control determines how interpolation is performed through keyframes. S-Linear, Linear, and Curve path types are supported, in addition to Path Hold. These path types provide fine control of the dynamics of the effect. See for background information.

- 1 Move to the location in the effect that you wish to change.

- 2 Go to the Path menu (**E-MEM & Timeline, Path**) and delegate the desired Level(s), Sub-level(s), and Group(s). In the following example, the keyer wipe of Keyer 1 of M/E 1 has been selected for path control editing.

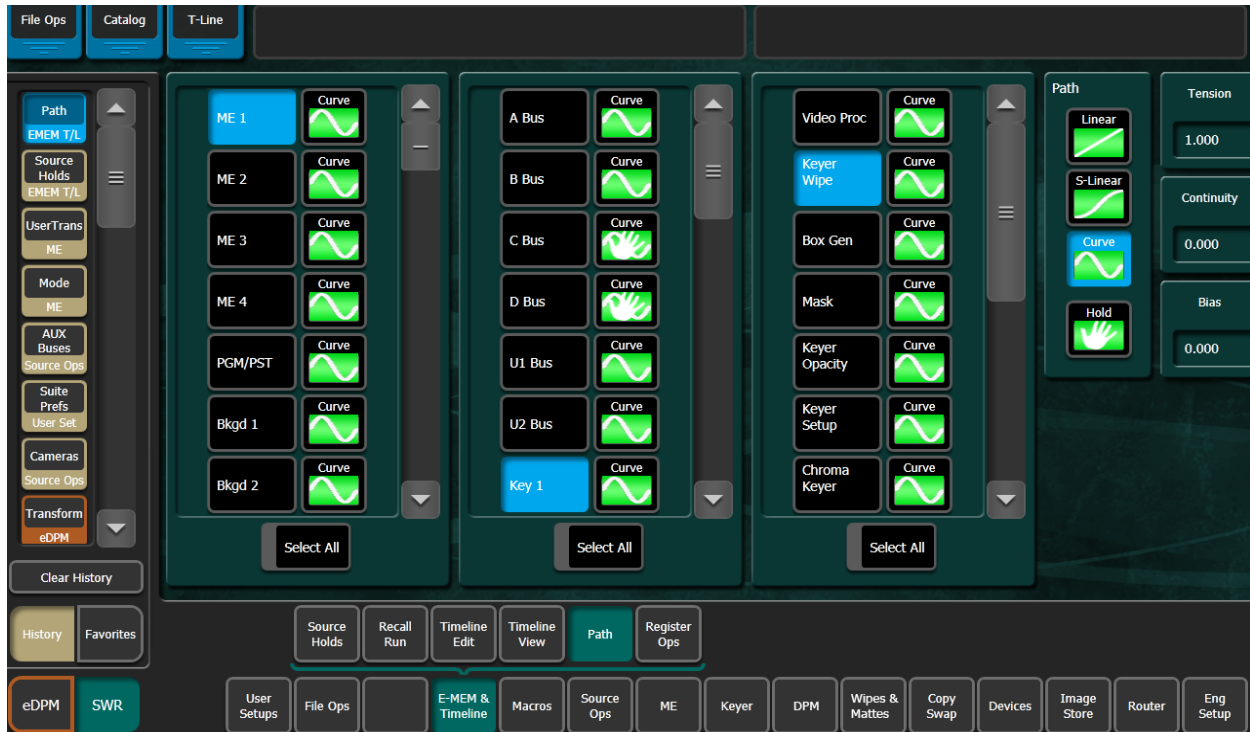

- 3 Choose the desired Path type (**S-Linear, Linear, or Curve**). If **Curve** is selected, you can use the soft knobs or data pads to change the values for **Tension, Continuity, and Bias**.
- 4 Add the new values to a keyframe in the effect with **Insert** or **Modify**, or **Learn**. You must change the keyframe, because current work buffer values are overwritten during the running of an effect.
- 5 Run the effect to see your changes.

General Curve Tips

Although adjusting the Curve path type Tension, Continuity, and Bias controls can feel like a guessing game, here are some general tips to help you build desired effects in a timely manner:

- Tension in the minus direction (up to -1.0) creates bigger, looser curves.
- Continuity at +1.0 is the same as S-Linear motion.
- Continuity in the plus direction gives a bigger bounce, with +2.0 a good value.
- Bias in the plus direction makes the curve happen after the keyframe.
- Bias in the minus direction makes the curve happen before the keyframe.

Cutting and Pasting Path Values

Being aware of how Curve values may change during editing can help you successfully fine tune the paths of edited effects.

- When keyframes are cut and pasted to and from the clipboard, the path type (Curve, Linear, S-Linear) is retained for each keyframe.
- When a block of Curve path keyframes are cut and pasted, the first and last keyframes in the block are given Tension = 1.0, Continuity = 0.0, and Bias = 0.0 values. This helps merge the path with neighboring path settings, since the Curve path requires three keyframes for proper calculation. Intermediate Curve path keyframes in the marked block retain their original values, since the neighboring keyframes required for the calculation exist.
- Cutting or copying a single keyframe with a Curve path type is handled the same as a first or last keyframe, and so this keyframe is given Tension = 1.0, Continuity = 0.0, and Bias = 0.0 values.
- If you paste a keyframe with a Curve path into the middle of an effect, reset Tension values to 0.0.

Controlling Smooth Path Windup

Effects with a curved transform path may move back slightly in the opposite direction when the move begins or ends. This “windup” is a characteristic of Curve path control, which is the factory default path type applied to new effect keyframes. Curve requires three keyframes for proper interpolation, so values for the previous (or next) keyframe affects the path through the next (or previous) keyframe.

There are several ways to change an effect so moves begin and end without any windup.

- Change the Path Type on the function keyframe to S-Linear.
- Set the Curve path Tension value on the function keyframe to 100.
- Set a Path Control menu Hold for the function on the previous keyframe.

E-MEM Transitions

Transitions can be built into E-MEM resistors. Recalling and running these E-MEMs will make the transitions occur as programmed. The lengths of transitions in effects is determined by keyframe duration, not the transition duration used for manual transitions. When you build effects with transitions, keep the E-MEM transition rules in mind, which are different from the rules used for manual transitions. The beginning and ending states of the buses and transition elements must be set properly.

Though background and keyer transitions are described here as separate procedures, effects can easily be built that include both background and key transitions in the same keyframe by selecting the appropriate next transition element buttons.

E-MEM Transition Rules

Key Priority Transitions interpolate wipes and mixes as part of an E-MEM.

Note: When creating a priority transition that will interpolate as part of an E-MEM, it will only transition correctly if the 'Next' Priority Stack on the initial keyframe is set to match the 'Current' Priority Stack of the subsequent keyframe.

- A background transition will occur only when the **Bkgd** next transition element is selected on the initial keyframe AND the source selected on the B bus of the initial keyframe matches the source selected on the A bus of the following keyframe.

Note: The decision to perform a background transition is based on keyframe values, regardless of the state of Bus or Source Holds. If a Hold is active you will not be able to tell by looking at the currently selected sources whether a background transition will occur.

- A keyer transition will occur only when the keyer (for example **Keyer 1**) background transition element(s) for the keyers involved are selected on the initial keyframe AND a keyer changes its on/off state at the following keyframe.
- If Effects Dissolve is on, when an effect is recalled transitions will occur between the previous switcher state and the first keyframe of the effect, following the rules above. If Effects Dissolve is off effect recalls will cut to the first keyframe of the effect.

Build Background E-MEM Transitions

When building background transitions make sure the A and B background bus selections are consistent throughout the effect. Otherwise the background video may cut to different sources when keyframes are encountered. Plan ahead to the next transition when you create keyframes in an effect that has multiple background transitions.

- 1 Go to the keyframe in the effect where you wish the background transition to begin.

Note: Adding new transition keyframes to the end of an effect is the easiest way to build effects containing background transitions, though using this method is not required.

- 2 Select the **Bkgd** next transition button.
- 3 Select the type of transition (**Mix**, **Wipe 1**, or **Wipe 2**).
- 4 Select the new source to transition to on the B bus.
- 5 Press **Modify** to change the keyframe to the values set above.
- 6 Perform the transition by moving the lever arm or pressing the **Auto Trans** button. This lets you preview how the transition will look (though the transition duration used may not match the keyframe duration specified).

Note: Performing the transition is not required (pressing **Cut** accomplishes the same goal, which is to put the switcher into the next desired state). The transition type button selection and the keyframe duration determines how the transition will be performed when the effect runs.

- 7 If there will be another transition immediately following this one, select on the B bus the source that will transition to in the next keyframe. This prevents undesirable background cuts from occurring.
- 8 Press **Insert After** to add this keyframe to the effect.
- 9 Repeat the steps above for any additional background transitions.
- 10 Rewind and run the effect to check its operation. The transitions will occur as programmed.
- 11 After the effect runs properly, you can go back and modify keyframes with Source Holds where needed.

TIP: If unwanted background cuts occur, go to the keyframe where the cut occurs, identify the source selected on the A bus, go to the previous keyframe, select that same source on the B bus, and then press **Modify KF** to properly setup that source in that keyframe for that next transition.

Building Keyer E-MEM Transitions

Individual keyers transition on or off (there is no keyer preset bus). To cross fade between keys, use two keyers and have one key transition in while the other transitions out. You can include any combination of keys in a single transition, using the transition rules to determine the exact behavior of the transitioning keys.

- 1 Go to the keyframe in the effect where you wish the key transition(s) to begin.
- 2 Select the **Key 1,2**, etc. next transition button(s) for the keyer element(s) involved. Selected keys that are on will transition off, and keys that are off will transition on.
- 3 Select the type of transition (**Mix**, **Wipe 1**, or **Wipe 2**).
- 4 Press **Modify** to change the keyframe to the values set above.
- 5 Change the on/off state of the keys you wish to transition.
- 6 If you are transitioning in a new key, select the source on that key bus. If you are transitioning out a key, do NOT change the source selected on the key bus for that keyer (this prevents an unwanted cut).
- 7 Press **Insert After** to add this keyframe to the effect.
- 8 Repeat the steps above for any additional keyer transitions.
- 9 Rewind and run the effect to check its operation. The transition(s) will occur as programmed.

Changing the Length of an E-MEM Transition

In the menu, change the keyframe duration of the first keyframe involved in that transition.

- 1 Go to the first keyframe for that transition.
- 2 Press **KF Duration** and then enter a value in <seconds> • <frames> • <fields> format on the keypad.
- 3 Press **Modify KF**.

Preventing Elements from Transitioning in E-MEMs

To ensure a transition for an element does not occur, simply make sure the next transition button for that element is off in the keyframe by selecting another element's button.

To ensure no transition occurs at all at a keyframe (any changes will be cuts), you can select only the next transition button for a keyer and make sure its state does not change in the next keyframe. A change of state in a keyer is required for a transition to occur when the effect runs.

The transition rules have one subtle limitation. The next transition element buttons are an interlocked group. All these buttons cannot be turned off simultaneously (at least one element is always selected). This means you cannot use these buttons to prevent any transition from occurring when all the elements are in use. To work around this special case, add another keyframe to the effect to transition the keys with a one field transition (which is the same as a cut).

Return to Normal Technique

A useful technique to use when building effects for use on-air is to first establish a normal switcher state for the particular show. This normal state could, for example, have only the *Bkgd* next transition element selected, a *Mix* transition type, all keyers off, and one second transition durations. This normal state permits immediate cuts or dissolves to and from any element, probably the most common requirements during a live show.

Running the effect departs from the normal state to do whatever is required. When the effect comes to the end of its run, the next to last keyframe controls the transition that occurs at the end of the effect. The last keyframe has no following keyframe and so does not transition, and that keyframe effectively has no duration. You can set the next transition elements in this last keyframe to the normal state without fear of causing unanticipated transitions. This return to normal technique permits completely controllable seamless shifts between your effect recalls and runs and your live switching.

When building effects for the show, take care that the beginning and ending of every effect works well with the normal state. You also may wish to apply a Source Hold to the first keyframe to ensure the last source selected remains unchanged going into the effect.

About Source Holds in Effects

During E-MEM recalls and effect runs sources can be programmed to change. Sometimes this is not desired, as an effect may be designed to run on the currently selected sources, not the particular sources used when the effect was built. Holds can be programmed into an effect with the Source Holds menu to prevent sources from changing when that effect is recalled. This form of hold is keyframeable, and so can be applied to specific portions of an effect.

Set a Source Hold in a New Effect

- 1 Select **E-MEM & Timeline, Source Holds**.

- 2 Turn on the buses you wish to hold by selecting their labeled buttons.



- 3 Press **Lrn** on the GV Switcher Control Panel (Master or Local E-MEM Module), then press a bank and register number to create a new effect with a Source Hold in its one keyframe.

Source Hold, being a work buffer parameter, will be imposed on other keyframes as they are inserted, unless turned off in the Source Hold menu. You may want to start an effect with a Source Hold, so the existing sources will not change when the effect is recalled, then turn it off to enable source changes during the running of the remainder of the effect.

Set a Source Hold in an Existing Effect

- 1 In the E-MEM & Timeline, Timeline Edit menu, locate the cursor on a keyframe in the effect where you wish to add a Source Hold.
- 2 Turn on the buses you wish to hold by selecting their labeled buttons (highlighted green border).
- 3 In the E-MEM & Timeline, Timeline Edit menu select **Modify KF** or **Insert Before/After** to add the Source Hold to the effect.

The Source Hold only applies to that keyframe, meaning the previously selected sources on the chosen buses will be held at that keyframe until the next keyframe lacking a Source Hold is encountered.

About Reusing Effects

E-MEM effects can be built and saved for use later. It is important to realize that the GV Switcher system operating environment affects how an effect will load and run. Just recalling a particular effect without considering the environment within which it runs does not guarantee that effect will look the same as when built. When the GV Switcher system environment for an effect is compatible, however, the look of the effect should be exactly the same every time.

One of the most important aspects of the GV Switcher environment to consider when reusing effects is Suite Preferences. In particular, the Source Patching and E-MEM Prefs must be compatible. Other Suite Prefs control the behavior of the switcher, but do not affect E-MEM compatibility.

Source patching is the mechanism to sort out facility specific differences in sources. Loading a Suite Prefs file with preexisting Source Patch settings will not necessarily allow an effect to run as designed. The sources must be patched to compensate for different physical source definitions in each facility. For example, the replay VTR may be engineering source 12 in one truck and engineering source 27 in another. If the effect was built to expect the replay VTR on Logical source 12, then logical source 12 must be patched to source 27 in the other truck. Once all the re-patching is completed, effects saved from the first truck will call up the correct sources.

E-MEM Prefs control which E-MEM levels will control specific components of the switcher. For example, if Image Store Channel 2 is assigned to the IS A group in one facility and to Misc 7 in another, the effect may not include Channel 2 if Misc 7 is not included in the original effect. Mapping M/E partition boundary and secondary partitions is also critical to effect recall and run since it determines which M/E E-MEM panel (or Master E-MEM enable group) controls M/E partitioning.

The simplest way to guarantee Suite Pref settings are compatible is to save them when the effects are built, and reload them when you want to run those effects at a later time, making only the necessary modifications (like those for Source Patching described above). One common method is to save all the effects along with the Suite Pref and User Pref files for a particular show together on a USB Memory Stick, and then reload them all the next time you work on that show. Note that User Prefs settings will not change how an effect runs, but will reproduce the control surface as it was when the effect was built so, for example, all the source buttons are arranged exactly where you want them.

Other GV Switcher environment variables to consider for successful reuse of effects are listed below.

- All the external devices required are available for use (Profile VDRs, GVEous, PBus devices, GPI outputs, etc.).
- Correct clips loaded on the Profile or other DDRs.
- Correct stills cached on the GV Switcher Image Store.
- If operating in Multi Suite mode, the suites should be setup for effect sharing by properly acquiring logical devices in each suite. Also sufficient resources need to be available in the suite. If resources are not acquired, those portions of the effect will be silently ignored. If resources are acquired after loading effects, the effects will need to be reloaded.

- If using a router interface, router sources and destinations need to be defined correctly and available, and any required R-MEMs loaded.

About E-MEM and Macro Interaction

Macros and E-MEMs can interact in two fundamentally different ways. An E-MEM can be programmed to execute one or more macros, or a macro can be created that recalls one or more E-MEMs. With care, operating both control mechanisms together can be extremely powerful. However, improper use can create infinite loops or other undesirable behavior. It is especially important that your GV Switcher system be loaded with the correct E-MEMs and Macros and is operating in the correct mode, or unpredictable system behavior will result from the mismatched E-MEMs and macros.

A macro can be added to an E-MEM keyframe and be executed when that E-MEM register is recalled and run. Only the macro register number (and its Enabled state) is saved to the E-MEM register, not the actual macro commands. If a macro is subsequently changed, any E-MEM specifying that macro register will run the modified macro. See [E-MEM Recalls in a Macro](#), on page 139 for related information.

About E-MEM Prefs Macro Sub-level Assignment

A Macro sub-level can be assigned to any E-MEM level (default is **Misc 8 MCRO**) in the E-MEM Prefs menu.

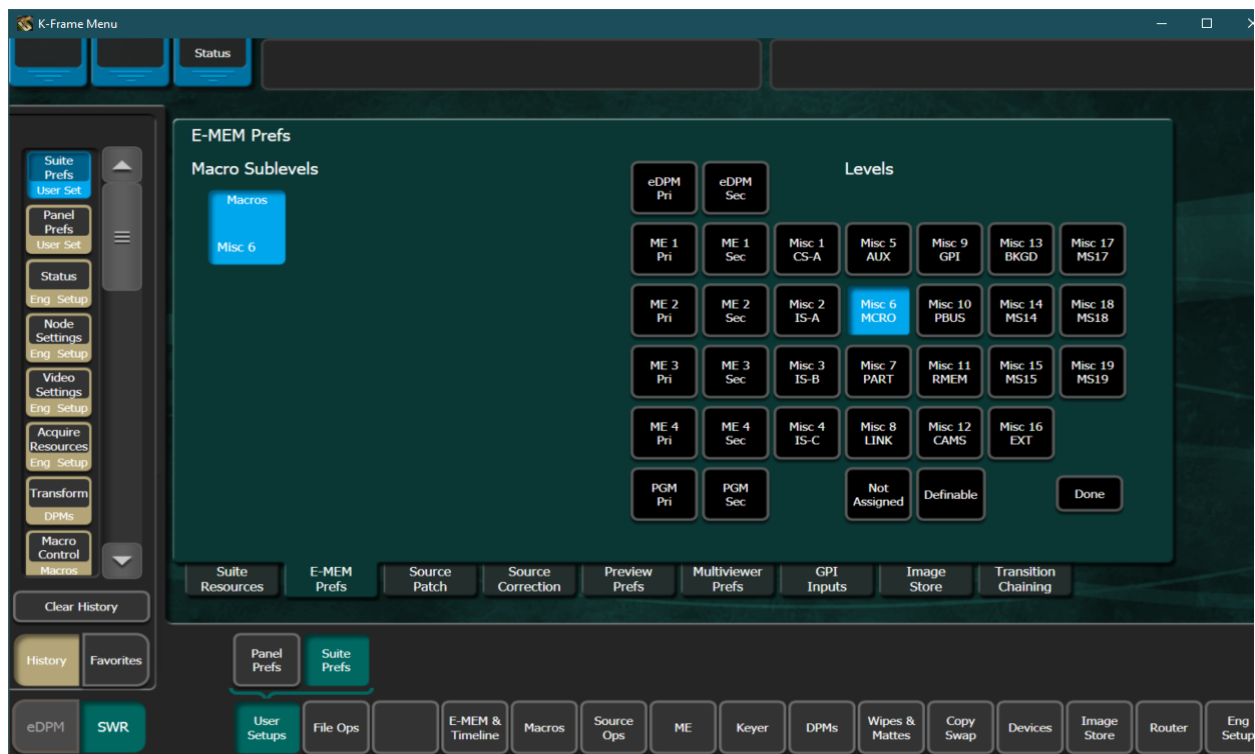

Preventing Assigned Macros from Running

If you want to be able to prevent any assigned macro from running in an effect, make sure the Macro sub-level is assigned to a separate level, and then enable or disable that level to turn all the E-MEM macros on or off.

Add a Macro to an E-MEM

The Macro in E-MEM pane is used to add a macro register number and its Enabled state to an E-MEM effect. You can control a macro from this menu including: append, record, delete, or insert a delay (in seconds or frames) using the Macro Catalog buttons.

- 1 Select **Macros, Catalog** in the menu.

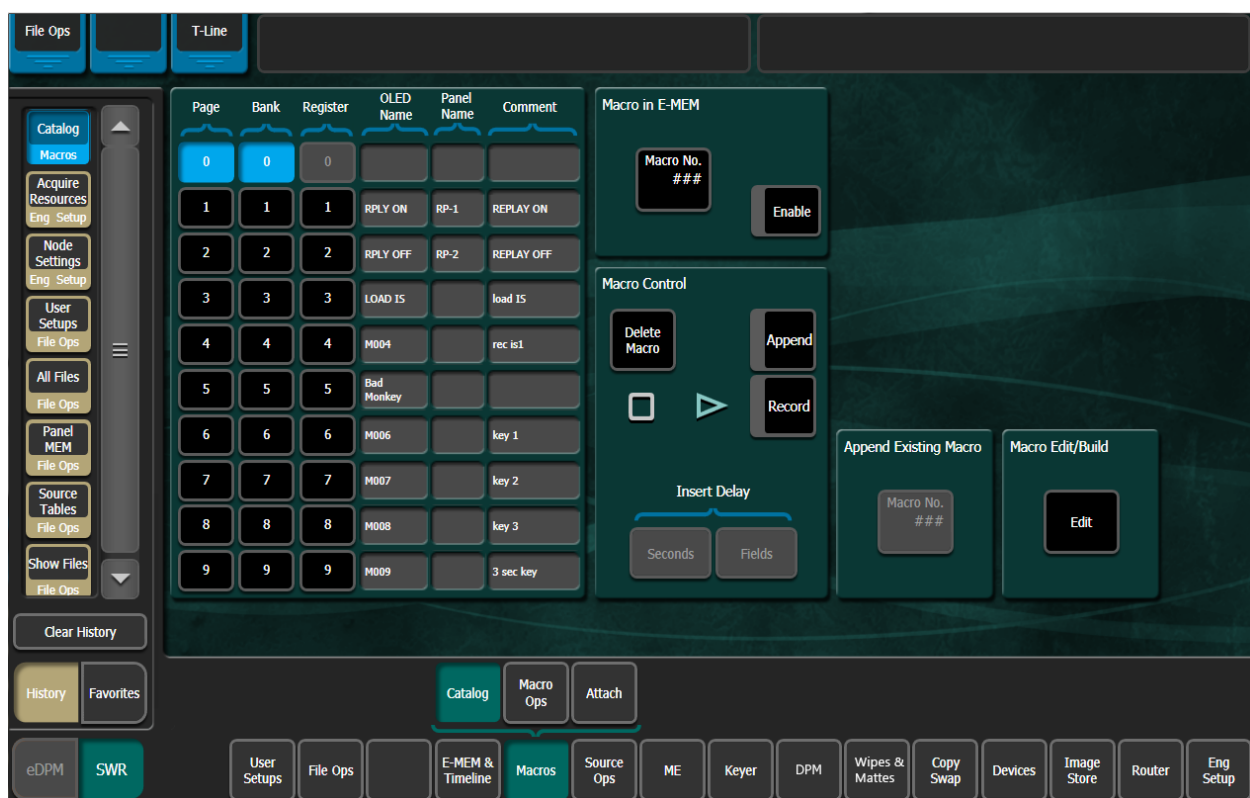

- 2 Select the **Macro No.** data pad in the Macro in E-MEM pane to open the Macro selection menu.



- 3 Select the desired macro in the menu, then the **Select** button to confirm your choice. The name of the selected macro appears in the data pad.
- 4 Select the **Enable** button (select again to disable) that specific macro.
- 5 Navigate to the desired location in the current effect.
- 6 Insert or Modify a keyframe to associate that macro and its enabled state to that location in the effect.

Partial Keyframing

Partial Keyframing is the ability to create and control independent sub-level timelines on a keyframe by keyframe basis in an effect. A partial keyframe is created when any sub-level is 'excluded', i.e. temporarily disabled for a level in a timeline, whether the keyframe is inserted or edited.

Available only in the menu, Partial Keyframing can include definable sub-levels as available resources using the Define E-MEM feature which is discussed later in this section.

Excluding Sub-Levels in a Level

- 1 Select **E-MEM & Timeline, Recall Run** in the menu and select the buttons of the switcher levels you want to enable for defining sub-levels (or select the Select All toggle button. Alternatively, you can select the levels on the Master E-MEM Module.

- 2 Select **E-MEM & Timeline, Timeline Edit** and select the **Show Sub Levels** button to the left of the level you wish to edit. The Enables menu is displayed for that level.

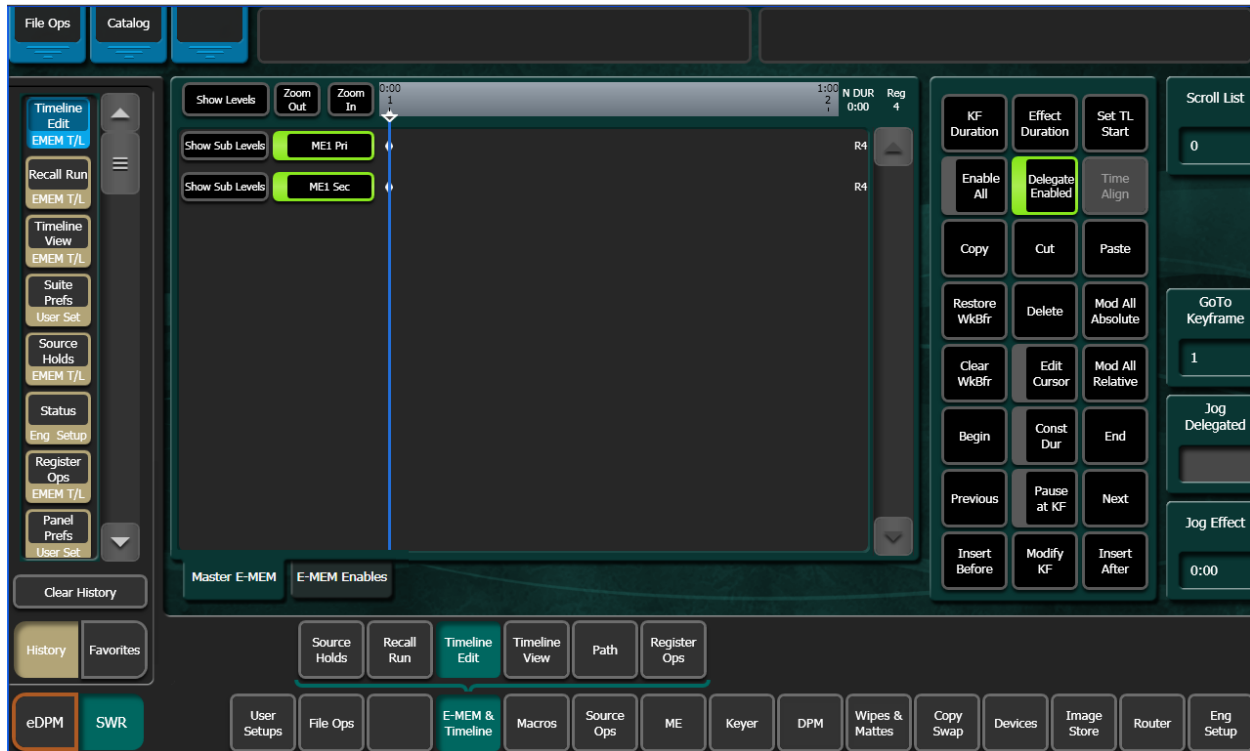

- 3 Select the Enable button of any sub-level to disable that sub-level from being included in the current E-MEM register.

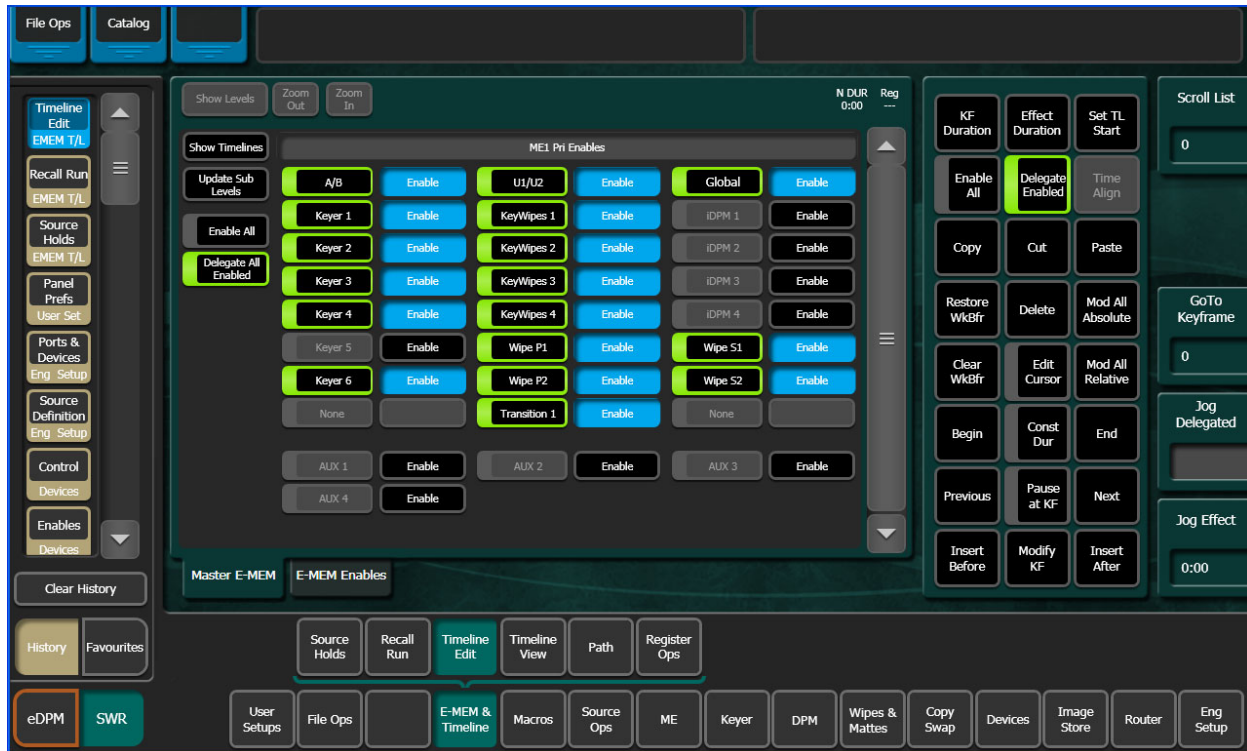

- 4 For additional levels, Repeat Steps 1-3.
- 5 Learn the Partial Keyframe enabled effect to a register by pressing and holding down the **Lrn** button on the Local/Master E-MEM Module and selecting a register.

The delegate buttons (left of enable buttons) can be turned on/off to delegate/release sub-levels when inserting or modifying keyframes.

Rules and Options for Excluding Sub-levels

Once any sub-levels have been disabled, the **Lrn** button in the Local and Master E-MEM Module will be colored Cyan (light blue) to reflect a partial keyframe is present in the timeline of the effect; the default is white.

Pressing and holding the cyan **Lrn** button while pressing a register button forces any Partial Keyframes to be part of that E-MEM. If the cyan **Lrn** button is not held when a register button is pressed, any Partial Keyframes will not be part of that E-MEM register and they will no longer exist. The register will learn a default state with all sub-levels enabled and any 'defined' sub-levels disabled.

About Define E-MEM

Sub-levels can be made definable on an effect-by-effect basis to be included in a level when an effect is recalled. Define E-MEM is *not* keyframeable.

For a sub-level, there are three states possible:

- Not assigned—Not controlled by an E-MEM, for example if you want manual control of an Aux Bus and do not want it to be recalled by an E-MEM.
- Assigned to a E-MEM MISC Level—Under typical E-MEM control.
- Definable—Define which level will own a sub-level on an effect by effect basis.

With GV Switcher, sub-levels which are set to be defined can be ‘enabled’ in any level.

The the sub-levels for the E-MEM Preference levels can be made as ‘definable’ in the User Setups, Suite Prefs, E-MEM Prefs, menu.

Make E-MEM Sub-levels Definable to Other Levels

- 1 In the User Setups, Suites Prefs, E-MEM Prefs menu, select an E-MEM Level.

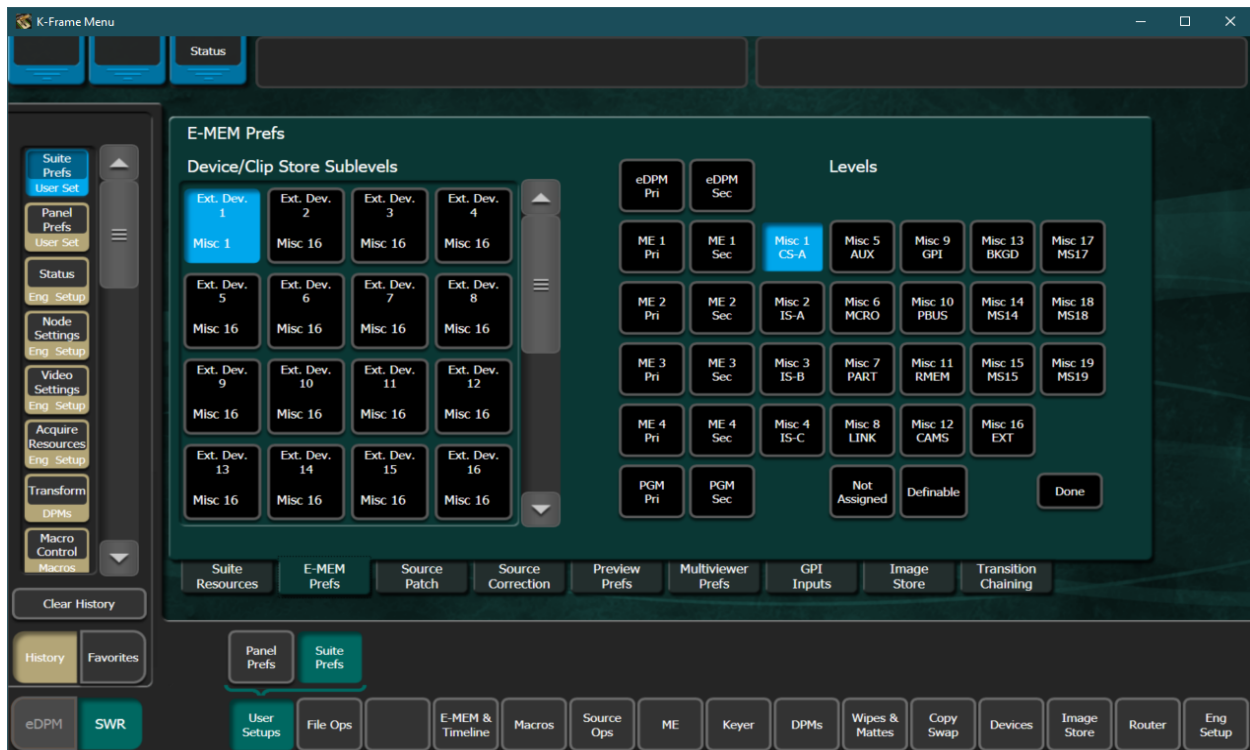

- 2 Select the sub-level you wish to make definable.
- 3 Select the **Definable** button, lower right in the menu.
- 4 Repeat Steps 1 and 2 for each sub-level you wish to make definable.

The sub-level is now definable and can be defined to a level. The definable sub-levels are not yet attached to a level.

Note: Sub-levels can only be defined to one level at time, for example if Aux 1 and Aux 2 sub-levels are assigned to M/E-2 Primary, they are not available to M/E-1 Primary.

Enable Definable Sub-levels

- 1 Select **E-M/EM & Timeline, Timeline Edit** in the menu.
- 2 Select the **Show Timelines** button.
- 3 Select the **Show Sub Levels** button corresponding to the level you wish to define.
- 4 Select the **Enable** button corresponding with the sub-level you wish to enable.
- 5 Learn the effect:
 - a For a new register, press and hold the cyan (light blue) Lrn button in the Local or Master E-M/EM Module, and press a register button.
 - b To edit an existing register, select the **Update Sub Levels** button.

Once the sub-level is defined to a level, an effect can be learned with this relationship. When that effect is recalled, the level/sub-level relationship will be reestablished.

Note: The Delegate All Enabled button's default is 'On'. If you choose to toggle this button to off, you must select the Delegate Enabled button, top right of menu to delegate enabled choices. Otherwise, the enabled sub-levels will not be part of the inserted keyframes and therefore not part of the effect.

Defined sub-levels are appended below the assigned levels (if present). Aux 1, Aux 2, Aux 3, and Aux 4 have been appended.

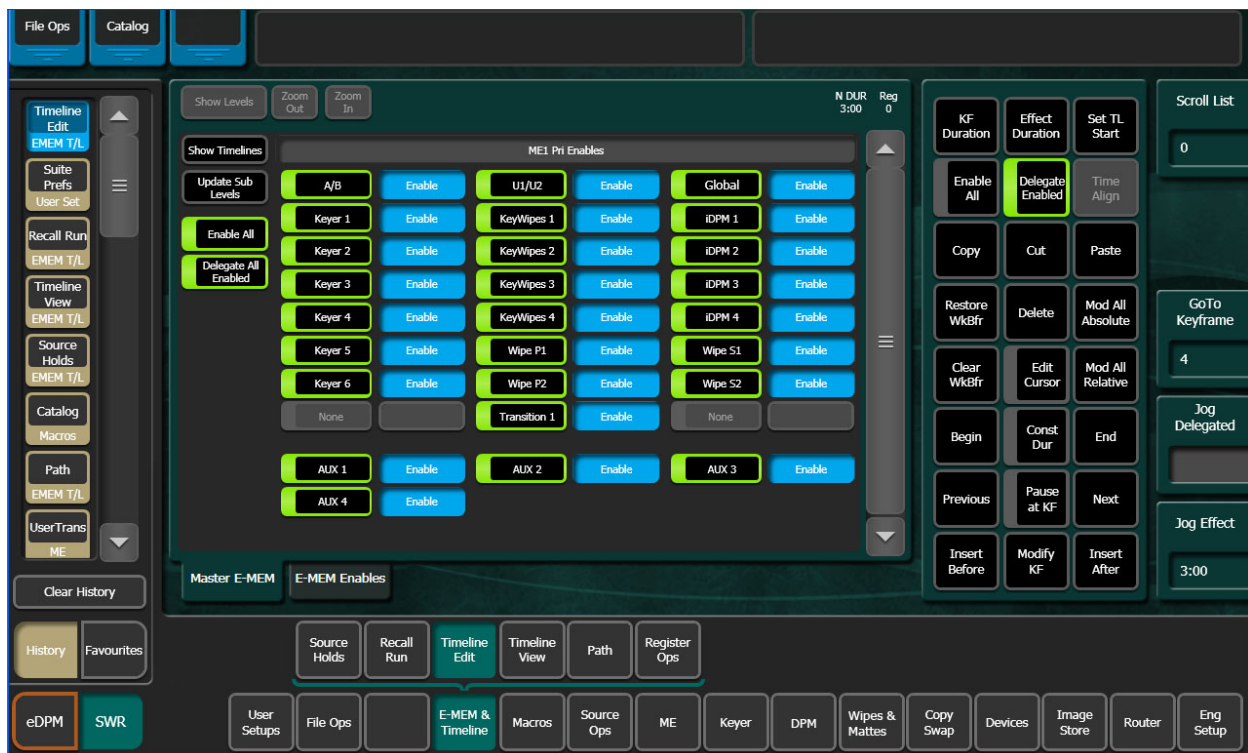

About Moving Currently Defined Sub-levels

CAUTION: : Moving a defined sub-level to another level while On-Air will result in a loss of that resource.

Defined sub-levels can be taken by other levels. To prevent the accidental taking of sub-levels, the GV Switcher menu will display a defined and delegated sub-level with 'yellow' if the sub-level is assigned to another level. If you select the enable button for that sub-level, it will be redefined to the current level and undefined from the previous level. If you then select the **Update Sub Levels** button, the current E-M/EM register will be modified.



About E-M/EM Enables Tab

The E-M/EM & Timeline, Timeline Edit, E-M/EM Enables menu tab allows the operator to review and edit each M/E level in an E-MEM register, for all M/Es at once. Additionally, the

operator can view the states of all M/E sub-levels for an effect from one location. This is sometimes preferable to performing these tasks one M/E at a time in the Master E-MEM tab.

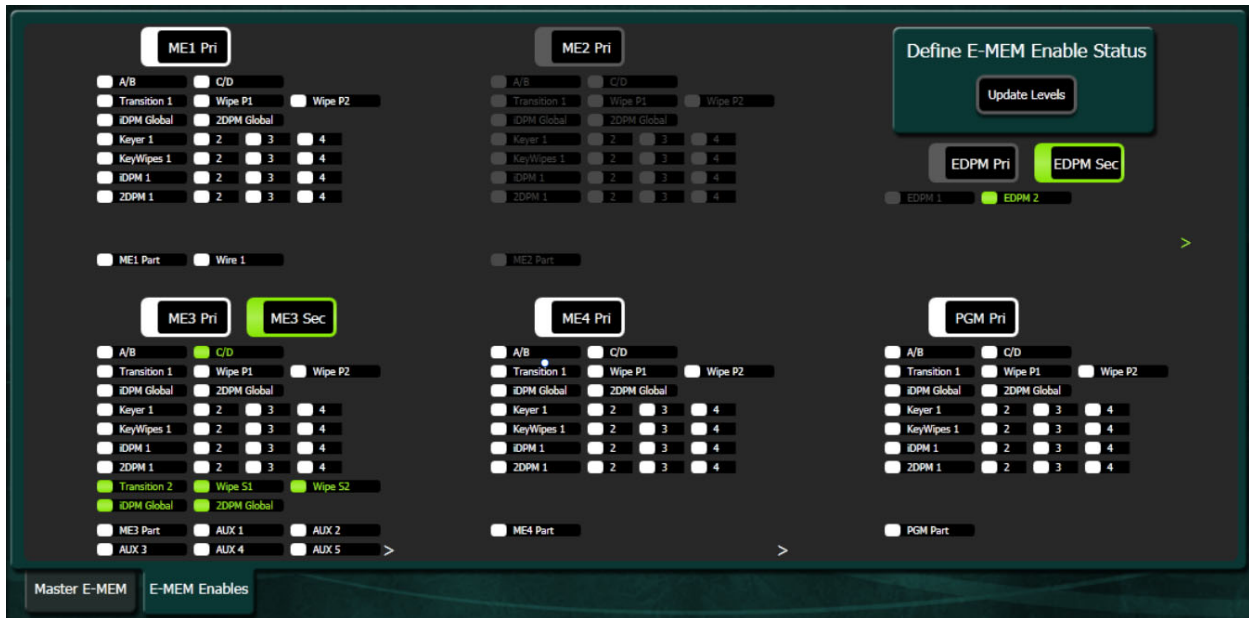

Note: The menu interface is designed for maximum data so mouse control is recommended, however levels and sub-levels can be controlled using select.

Secondary levels and their sub-levels are green when selected for easy identification.

About Assignable Sub-levels

Up to six assignable sub-levels including primary and secondary can be displayed for each M/E. If more than six sub-levels are assigned, the > symbol will be displayed; white for primary and green for secondary, both to the immediate right of the sixth assigned sub-level. Use the Master E-MEM tab to view and change the states of non-visible sub-levels.



About Definable Sub-levels

Definable sub-levels are not displayed in the E-MEM Enables tab. If there are defined sub-levels enabled, the > symbol will be displayed; white for primary and green for secondary, both to the lower right of the M/E to which it is assigned. Use the Master E-MEM tab to define sub-levels.

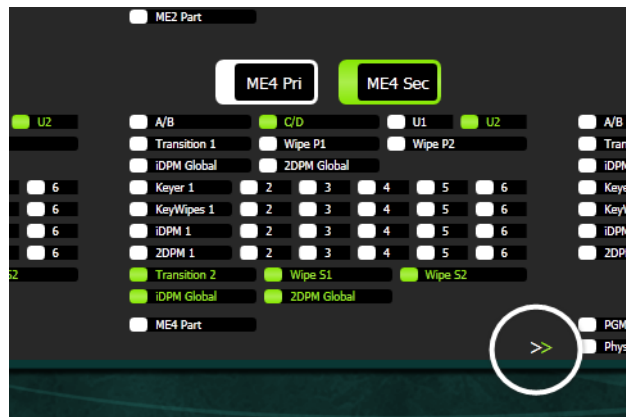

About Effects Editing in the E-MEM Enables Tab

Effects can be edited in the E-MEM Enables tab for all M/Es by enabling or disabling levels and sub-levels from the switcher state. An M/E level (i.e. M/E 4 Pri) can be disabled (turned off), then one sub-level at a time can be enabled; the M/E level is enabled (turned on) once one sub-level is enabled.

Note: Disabling then re-enabling an M/E in the E-MEM Enables tab resets all sub-levels to enabled for that M/E.

Effects edited in the E-MEM Enables tab will run with the level and sub-level states as selected, however until the **Update Levels** button is selected, the effect's E-MEM register is not modified. A recall of the register will return the register to its saved state.

Enable E-MEM Levels from the E-MEM Enables Tab

M/E levels for an E-MEM can be enabled/disabled from the E-MEM & Timeline, Timeline Edit, E-MEM Enables menu tab. Proxy eDPM control is also provided, however eDPM sub-levels are in the eDPM menus. Levels updated in either the Master E-MEM or E-MEM Enables tab are reflected in both.

Prerequisite: Read the Define E-MEM section in the User Manual for your switcher model.

- 1 Select an E-MEM register.
- 2 Select **E-MEM & Timeline, Timeline Edit, E-MEM Enables** in the menu.
- 3 Enable or disable E-MEM levels and sub-levels for the selected register.
- 4 Select **Update Levels** (top right of menu) to save the effect to the register; the effect can be run without updating the levels. However, when recalled, the effect will return to the saved state.

About Additive Keyers

In the keyer circuitry of the switcher, unshaped video is processed using a multiplicative key and shaped video that is processed using an additive key. In the normal course of operation, this is done automatically. Shaped video can be turned on or off (unshaped video) for a source's linear key in the Key Mode pane of the Eng Setup, Source Definition menu.



However, there are instances when manual control is useful:

- A source's key is not properly defined and you wish to correct the shape by overriding the key type, or
- You wish to key an artistic effect by changing the video to the "incorrect" video shaping.

Enable an Additive Keyer in the Menu

Additive Key and Super Add buttons are provided in the menu for Fixed and Adjusted Linear and Luma keys so you can override the video shape selected in the Source Definition menu (changes from Auto to On or Off) for that source.

1 Select **Keyer, Mode** in the menu.

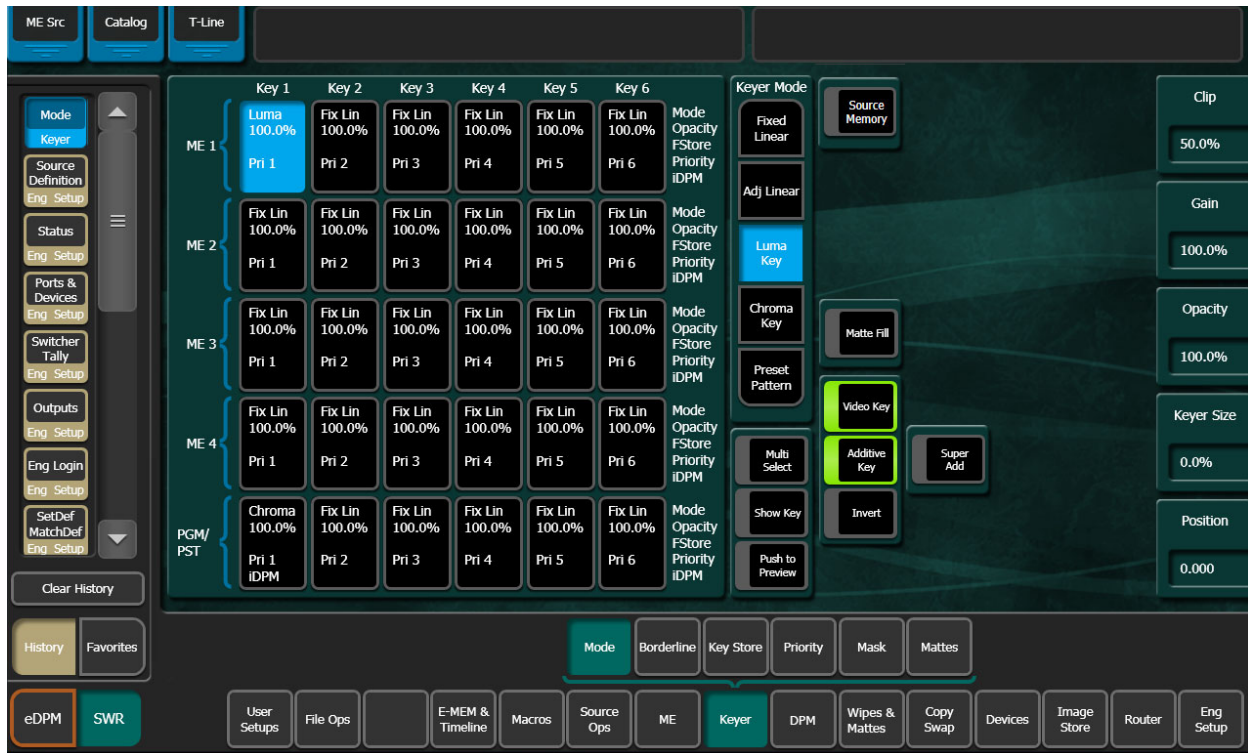

Note: Selecting or re-selecting any Keyer Mode button (Fixed Linear, Adj Linear, or Luma Key) will reset the shape type to “Auto”, as defined in the Source Definition menu.

- 2 Select the desired Key.
- 3 In the Keyer Mode pane, select the **Fixed Linear**, **Adj Linear**, or **Luma Key** buttons if not already selected.
- 4 Select the **Additive Key** button to turn it to On (illuminates green).
- 5 Turn off the **Additive Key** button.

The key will remain in the selected On/Off state.

About Super Additive

“Super Additive” mode replaces the key signal of the selected source with a full field of black, while in the additive key mode. The opacity of the fine and semi-transparent video is greatly increased based on its luminance. This is very much a “fashion-statement” kind of keying which has been very popular with entertainment shows. Additionally, Super Additive mode is very useful for keying over credits and other text because it brightens and increases transparency.

When Additive Key mode is On, the Super Add button is displayed and defaults to Off. Select the Super Add button to turn it On/Off.

The Super Add button is also returned to “Auto” state by selecting or re-selecting a Keyer Mode button.

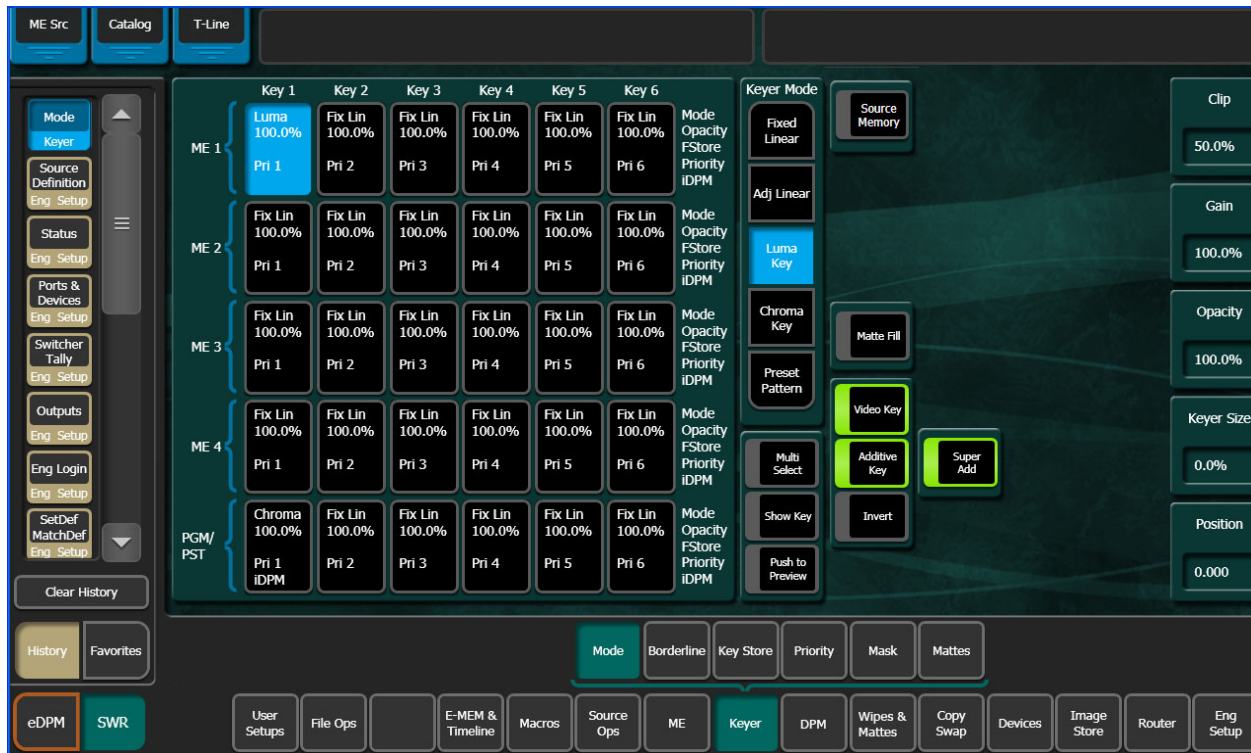

About Additive Keyer and the Control Panel

In the Multi-Function Module of the Control Panel, the Add button is provided in the Keyer (Keys) menu (press Keys, Add). For Super Add, DPOP the Add button (Add button changes from high tally white to high tally orange).

About Macro Builder

The Macro Builder was added to the Macro Editor to simplify the common tasks associated with building and editing new common macros. The existing Macro Editor functions remain and are used for editing existing complex macros or building new complex macro lines but these Macro Builder features are quite easy to use and have a simple, intuitive interface.

The Macro Editor Edit/Build menu includes the Macro Builder pane containing the Insert New Line and Edit Line functionality for common and complex macros and other editing features:

- The Macro OLED Name can be edited,
- The Macro Panel Name can be edited, and
- Comments can be edited.

Simply select the field and edit with the pop-up keyboard.

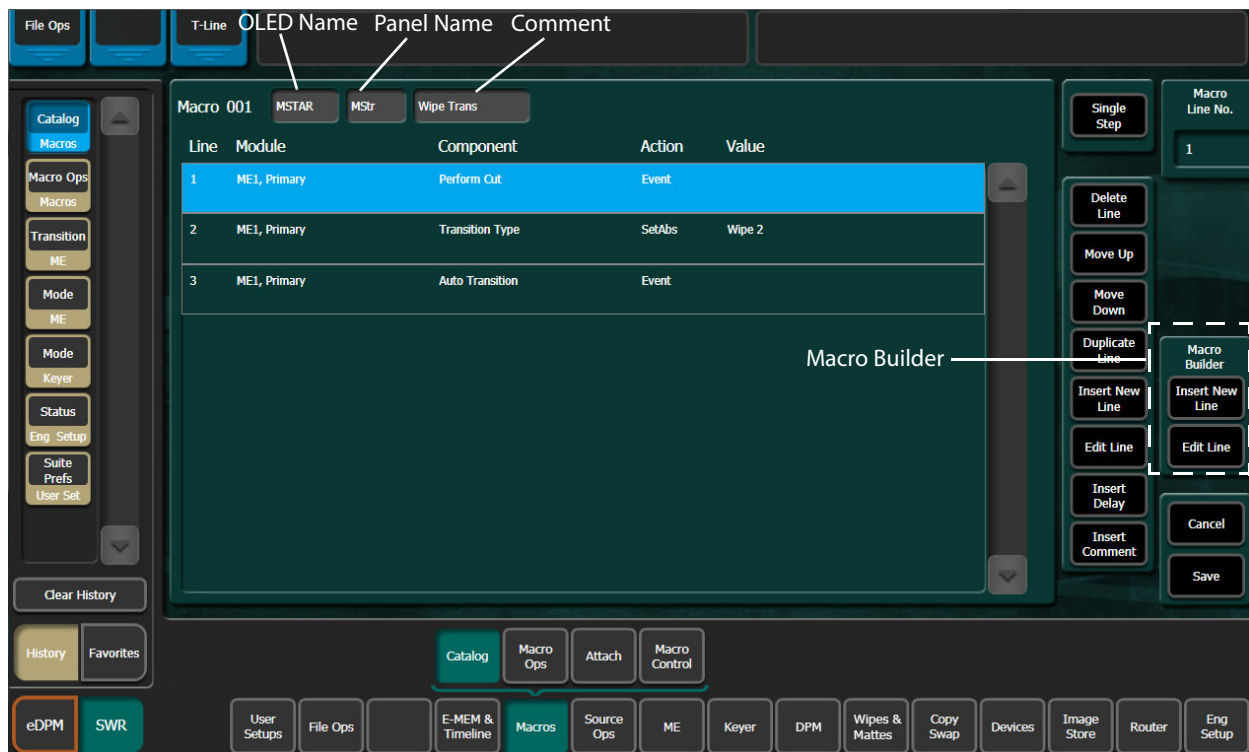

A macro line is made up of the following columns:

- *Line*—Order of execution in the macro
- *Module*—Switcher area affected
- *Component*—Switcher component involved
- *Action*—Type of action: SetAbs (set value) or Event (trigger)
- *Value*—Component value set by the macro

About Macro Line Editing

The Macro Editor line editing buttons in the Macro Build/Edit menu can be used to edit and organize macro lines for Macro Builder supported macros and complex macros (including macros built in earlier versions of software).

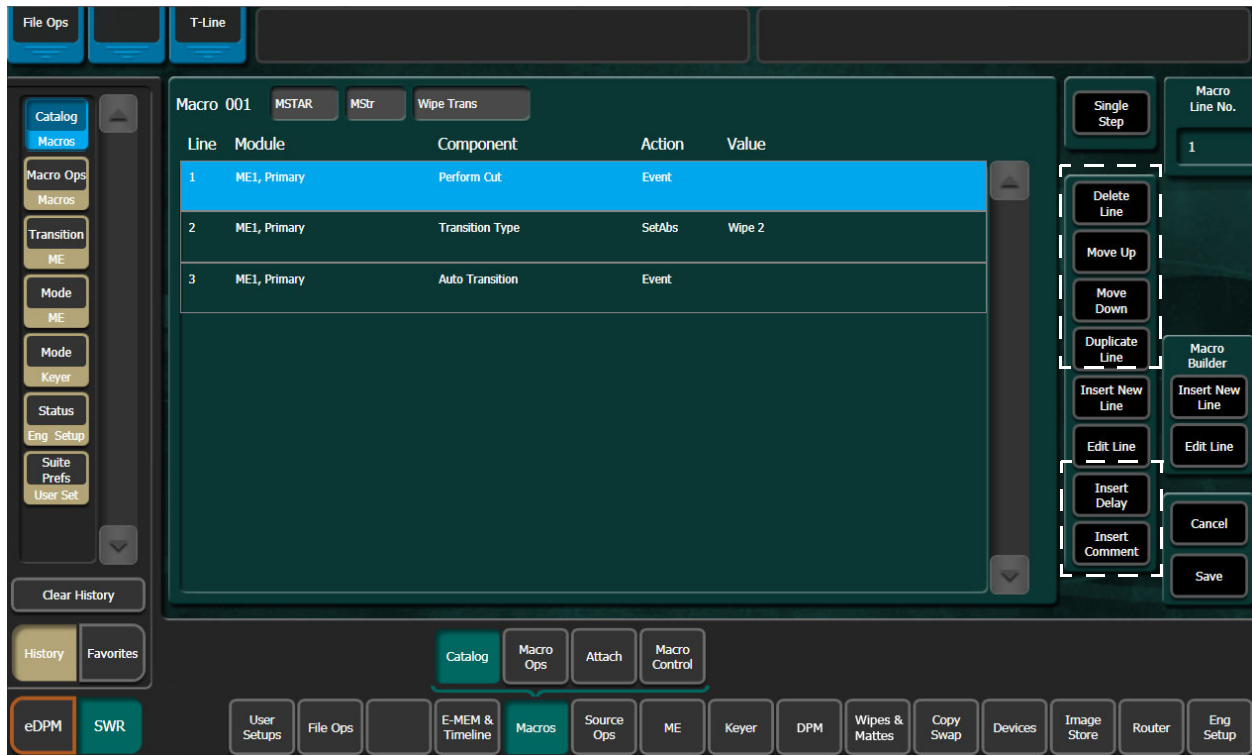

Using the Macro Edit buttons, you can edit or reorganize the macro lines:

- *Delete Line*—Deletes the selected line
- *Move Up/Down*—Moves the selected line up/down
- *Duplicate Line*—Duplicates the selected line
- *Insert Delay*—Inserts a Delay (line) after the selected line.
- *Insert Comment*—Inserts an editable comment after the selected line; comments do not effect macro performance

Build a New Macro with Macro Builder

The Macro Builder Insert New Line menus guide you step-by-step through building a macro. The following is an example of building a new macro line for a wipe transition. Breadcrumb style menu navigation is displayed above and to the left of the menu.

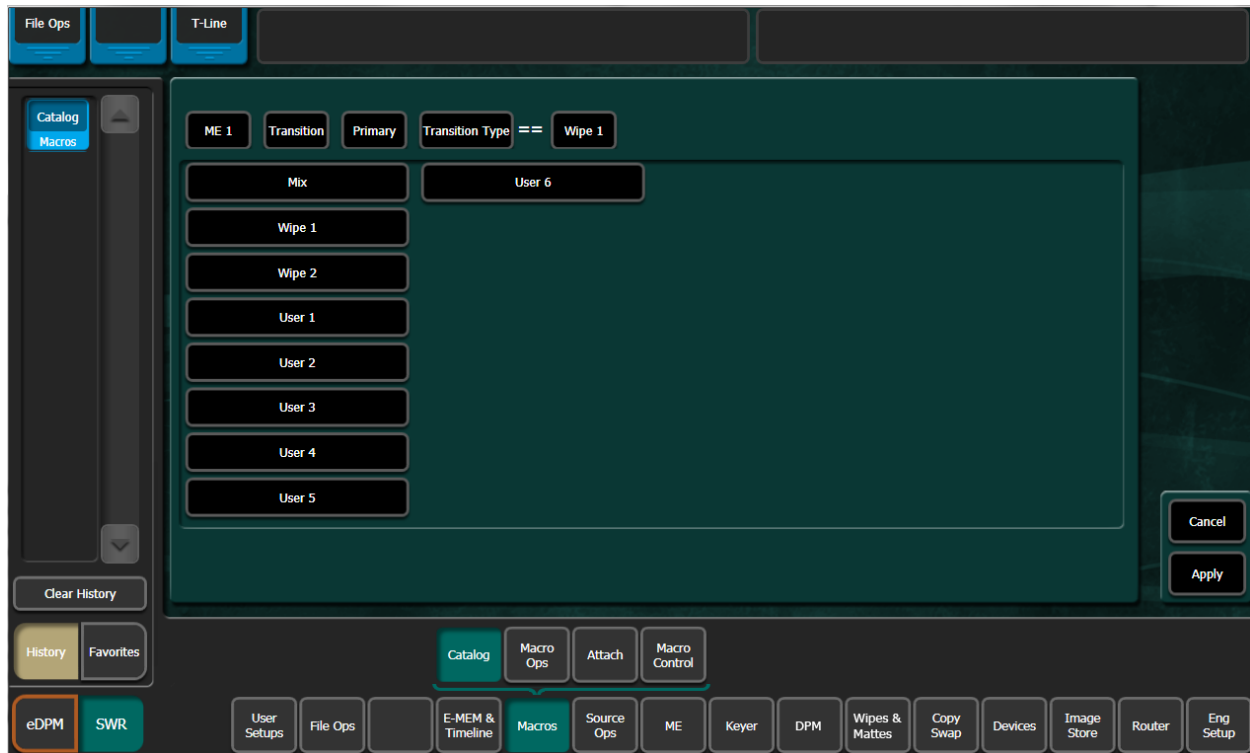

- 1 Select **Macros, Catalog** then select the **Edit** button in the Macro Edit/Build pane (lower right).

2 Select the Macro Builder **Insert New Line** button on the far right of the menu.

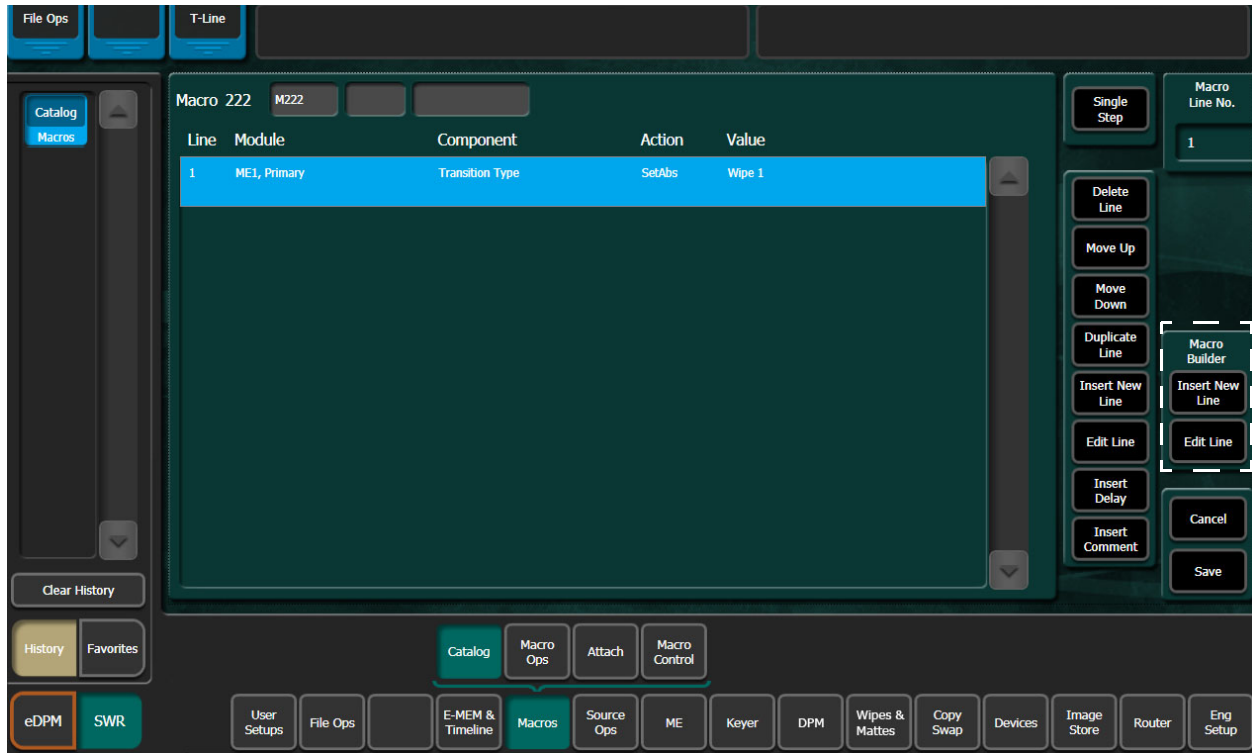

- 3 Select an area of the switcher system—**ME 1**.
- 4 Make the next selection—**Transition**.
- 5 Make the next selection—**Primary**.
- 6 Make the next selection—**Transition Type**.
- 7 Make the next (and in this case the last) selection—**Wipe 1**.
- 8 Select the **Apply** button that is displayed when the final step of the macro has been completed.

Result: The macro to transition Wipe 1 is added to the macro register.

Edit Macro Builder Created Macros

Lines in a macro supported by the Macro Builder can be edited by selecting the *Edit Line* Macro Builder button and selecting a new parameter. In this example, the Wipe 1 transition in this macro will be changed to Wipe 2. The *Single Step* button located at the top right of the menu is provided to step through each line.

Note: If the Macro Builder *Edit Line* button is selected but the macro command in the line is not supported by the Macro Builder, the Macro Editor will open the more complex editing menus automatically.

- 1 Select Macros, Catalog then select the macro to be edited.
- 2 Select the **Edit** button in the Macro Edit/Build pane (lower right).
- 3 Select a line to be edited; in this example a Wipe 1 transition.

- 4 Select the **Edit Line** button of the Macro Builder button pane.

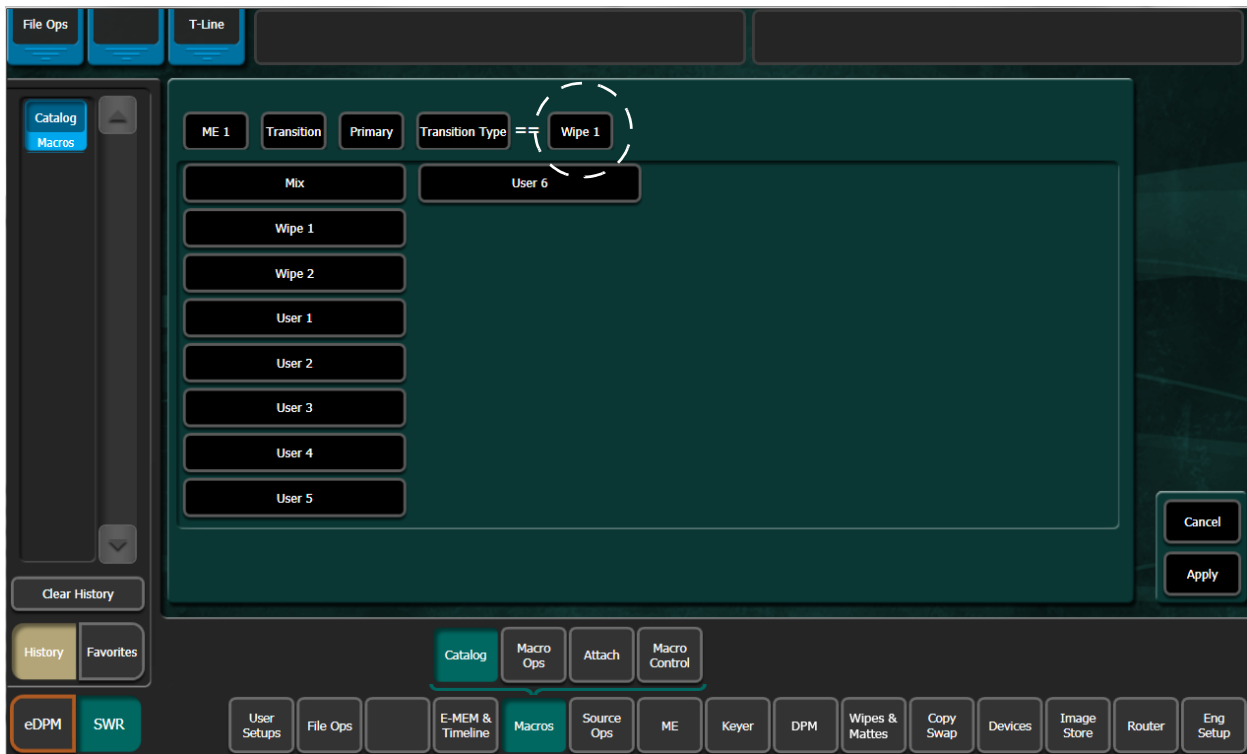

- 5 Select **Wipe 2** and select **Apply**.

Insert a Macro Delay

- 1 Select the **Insert Delay** button.
- 2 Select the **Enter Delay** data pad and enter the value in the pop-up numeric keypad, for Fields or Frames or Seconds.
- 3 Select **Enter**.

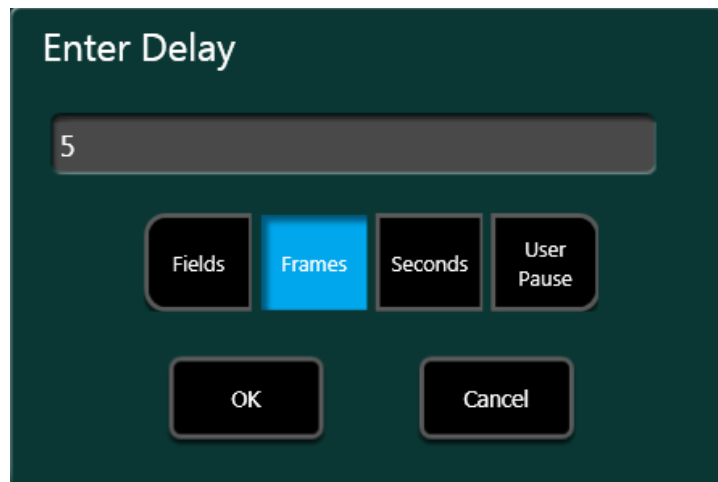

Insert External Device Control Commands in Macros

You can insert actions into macros using Macro Builder to trigger an event such as play or stop. You can also trigger parameter setting changes like a time code or a mark-in point; a dialog will display for actions with editable parameters when selected.

- 1 Select **Macros, Catalog** in the menu, and select a recorded macro.
- 2 In the Macro Edit/Build pane (lower right side of menu) select the **Edit** button.
- 3 In the Macro Builder pane (right edge of menu) select the **Insert New Line** button.
- 4 Select **Devices**, then **Control**.
- 5 Select an external device.
- 6 Select an action; for editable parameters, enter those parameters in the pop-up dialog.
- 7 Select **Apply** (bottom right).

Result: The macro line is inserted into the Macro Editor.

- 8 Select **Save**.

Create a New Complex Macro

Creating a new macro can be done in the Macro Editor (not the Macro Builder), however it may not be practical. It is recommended that you learn about Tiers, Groups, and component locations using existing macros first.

- 1 Select an empty macro register in the Macros, Catalog menu.
- 2 Select the **Insert New Line** button in the Macro Line Edit menu, the Component Edit menu is displayed.
- 3 Choose the Tier 1, Tier 2, Tier 3 (if necessary) levels by selecting those buttons.
- 4 Choose the Group, Location, and Component by selecting those buttons.
- 5 Select the Edit Value button to set the value for the component.
- 6 Select Apply.
- 7 Select Save.

Repeat the above steps for each line of the macro.

About Copying and Editing Complex Macros

With Macro Editor, you do not have to re-create complex macros that you want to use for other parts of the switcher. You can copy a macro from one register to another and then edit the macro lines to fit your needs.

There are two levels of macro editing: editing or organizing macro lines and editing a macro line itself. When reorganizing macro lines, you use the macro editing buttons which allow you delete, move, insert lines, etc. whereas with line editing, you can edit the individual lines; location, values, etc. for each.

You can edit a macro line by selecting the line you wish to edit in the Macro Line Editing menu and then selecting the *Line Edit* button.

The Macro Editor displays a component level, hierarchical view of the selected macro line. In this view you can select a different Tier, Group, Location, and/or Component, and then set a new value for the Component (and apply and save the changes).

The parts of the switcher are organized hierarchically into tiers. Each selected tier has a number of groups. Each group contains a set of components which share the same set of locations. So when editing it is essential to select a group which contains the locations and components you wish the macro to act on.

Note: Selecting the *Edit Line* button does not open the Component Edit menu for all lines, for example with an Insert Delay line, the Enter Delay dialog is displayed when the Edit Line button is selected.

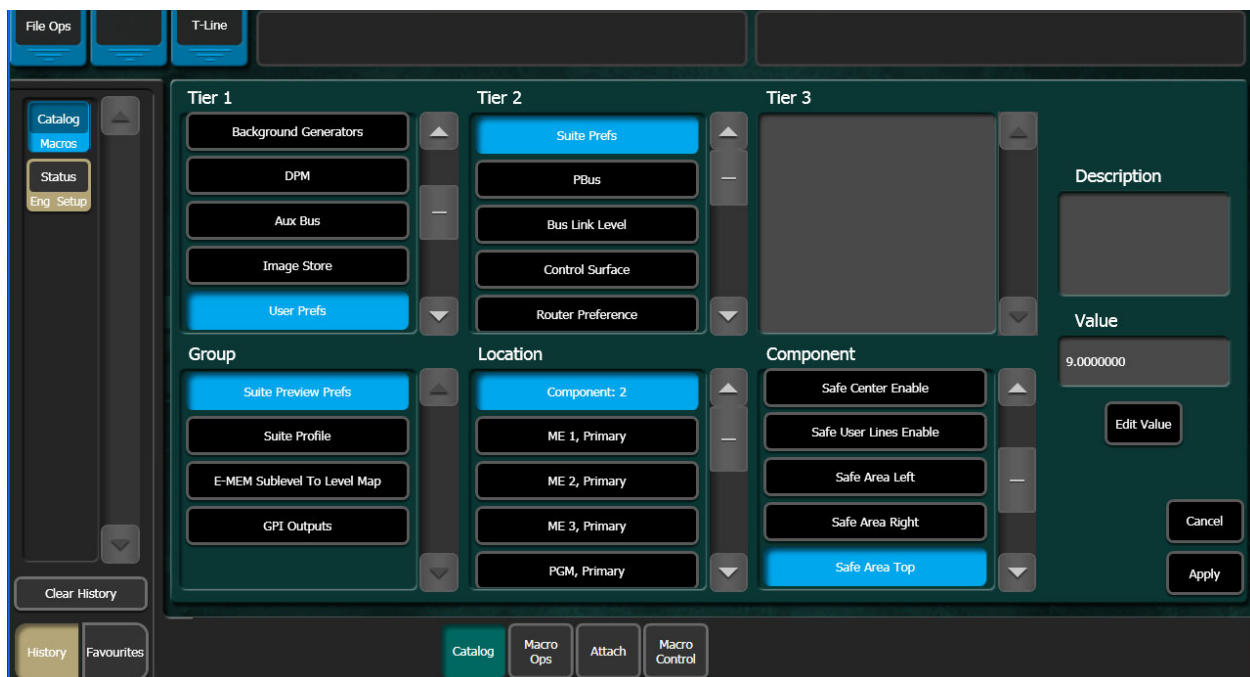

If you wanted to use a macro built for ME 1 on ME 2, you could copy the macro register and go through each line and simply change ME 1, Primary to ME 2, Primary. The macro will now perform identically but for ME 2.

Edit Values

Changing component values is a very useful feature of line editing. For example you could change the value for the “Safe Area Top” component of Line 23.

- 1 Select the Edit Value button, the Enter Value dialog is displayed.

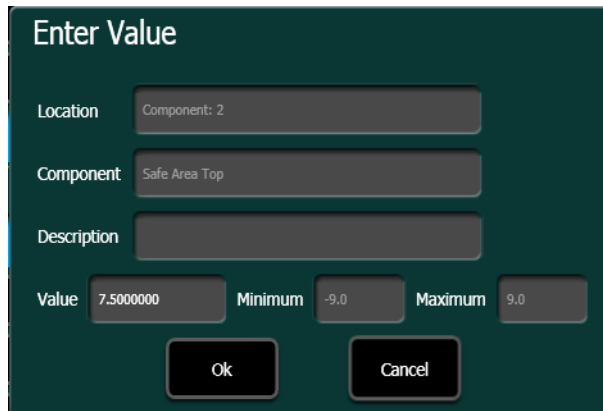

- 2 Select the Value data pad, enter the new value in the pop-up numeric keypad, and select Enter.

TIP: Some components allow you to choose from a list of values.

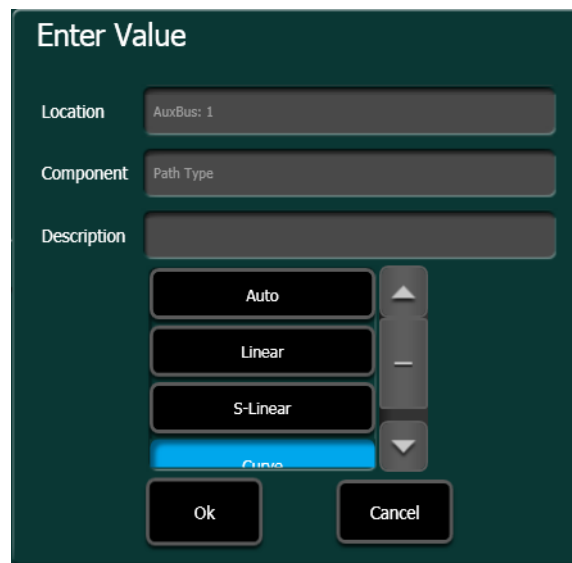

Result: The dialog closes and the new value is displayed in the Component Value Menu's Edit Value data pad.

Note: It is very important to use a real show file data set, for instance if you were choosing from a list of sources.

- 3 Select the Apply button.
- 4 Select the Save button to save your changes.

Result: The Macro Line Edit menu is updated to reflect the value change for Line 23.

About the Frame Simulator and Macro Editing/Building

Using a correctly configured Frame Simulator and Show file, you will be assured that macros will properly reference sources and source names, as well as the expected durations for the required line and frame rate.

You can use the Frame Simulator included with the GV Switcher software to edit and create macros offline and save them to a USB Memory Stick or other storage device making them portable for use in future shows.

To configure, operate, and understand more about the Frame Simulator, open and follow the instructions in the Readme.txt file in the Frame Simulator directory (default).

The GV Switcher Frame Simulator will be installed automatically in the Grass Valley directory, during the software installation (see the Release Notes for your switcher model) for a standalone PC. In order to run the Frame Simulator properly, the line rate will have to be configured once (as it affects all transition, timeline, and macro pause durations) and the main.exe file will need to be running simultaneously with the Menu on PC.

Set the Line Rate for the Frame Simulator

Set the line rate in the Eng Setup, Video Settings menu prior to editing or building macros using the Frame Simulator. This will prevent video settings errors when macros are transferred from disk to a GV K-Frame XP system.

- 1 Select **Eng Setup, Video Settings**.
- 2 Select the line rate from the Frame Operating Mode pane.

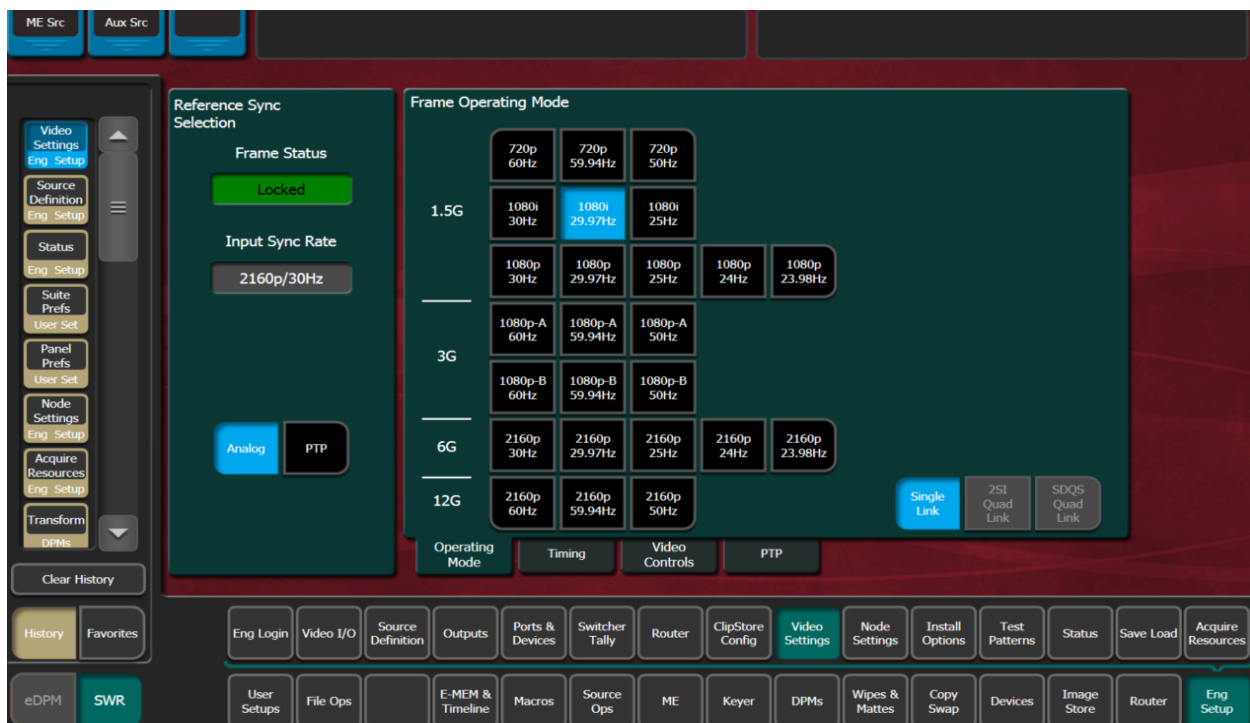

About Offline Macro Editing with the Frame Simulator

You can use the Frame Simulator included with the GV Switcher software to edit and create macros offline and save them to a USB Memory Stick or other storage device making them portable for use in future shows.

Also in this release, as part of the Frame Simulator interface, you can configure the line rate. The line rate will affect all transition, timeline, and macro pause durations.

Configure the Frame Simulator

Configure the Frame Simulator line rate using a Windows shortcut:

- 1 Navigate to C:\Program Files (x86)\Grass Valley\GV Switcher\GVSwitcherSystem_Vx.x.x\Frame Simulator.
- 2 Right-click select Create Shortcut.
- 3 Right-click on the shortcut and select Properties.
- 4 Append -config to the Target address after main.exe.

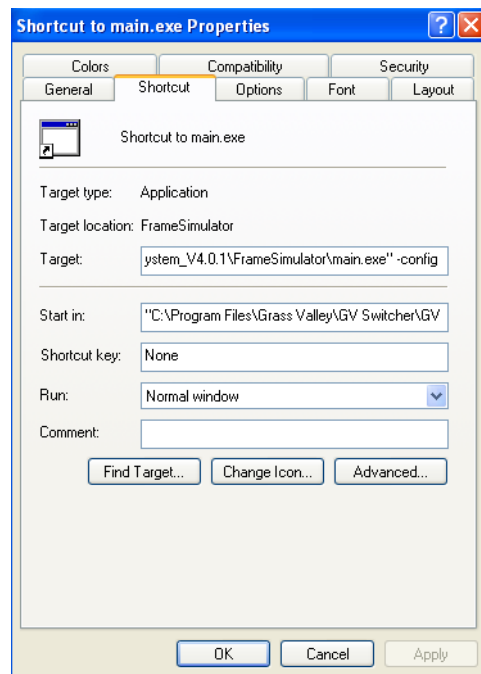

- 5 Open the shortcut to adjust the line rate.

Configure the GV Switcher Menu

Enter the Frame simulator IP Address:

- 1 In the GV Switcher menu, select **Eng Setup, Node Settings, Frame Suite Nodes & ID.**
- 2 Select the **Frame IP Address** data pad.
- 3 Enter **127.0.0.1** as the Frame IP address in the Frame IP numeric keypad and press **Enter.**

Note: The Node Name “LocalHost” with the IP 127.0.0.1 for Suite1 Surface A has been auto-entered into the Eng Setup, Node Settings, Control Surfaces menu.

- 4 At this time, you may want to load a real Show file if the macros you will be editing/creating affect sources or other variables.
- 5 Macros can now be edited, created, and saved offline from a PC.

About Transition Chaining

Transition Chaining allows you to chain transitions across different M/Es:

- *Key Chaining*—Allows you to chain keys to coordinate their keyer states (on and off) on a single M/E or from one M/E to another. There are 15 Key Chains available in a GV Switcher System. All keys in a chain transition on and off together (see [About Key Chaining](#), on page 296).
- *Background Chaining*—Links background next-transition elements across different M/Es; Primary to Primary partitions and Secondary to Secondary partitions. Two chains are available per suite (see [Background Transition Chaining](#), on page 300).
- *Partition Sync*—Links Primary and Secondary partitions within the same M/E (see [Partition Sync Mode](#), on page 307).

These features can be used separately or together, and in combination with bus links to provide for example multiple feeds or 3D productions.

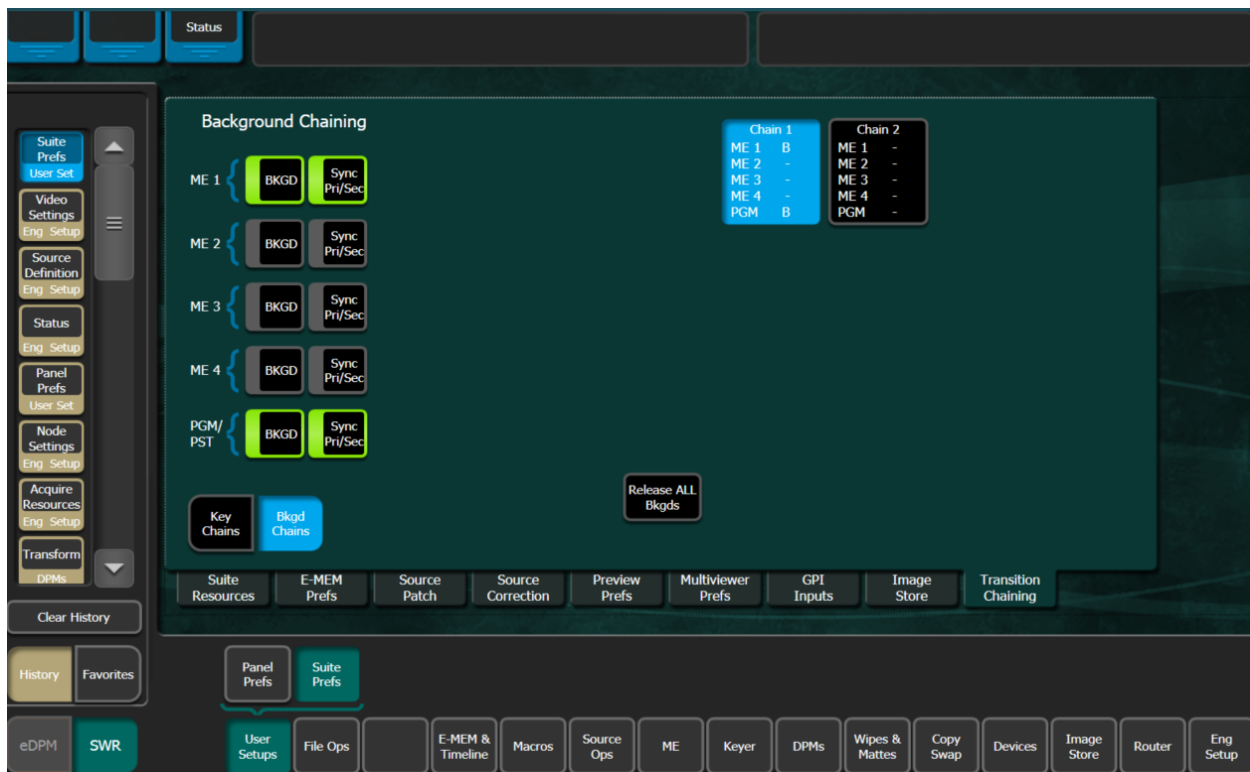

About Key Chaining

Key Chaining allows you to chain keys to coordinate their keyer states (on and off) on a single M/E or from one M/E to another. There are 15 Key Chains available in a GV Switcher System. All keys in a chain transition on and off together. Key Chaining is performed in the User Setup, Suite Prefs, Key Chaining menu.

Some uses for Key Chaining are:

- Keyers within an M/E for language or Ident separations of clean feeds,
- Aspect ratio-specific graphics across more than one M/E, or
- Advertising graphics on bus-linked M/Es which already substitute background pictures.

In the Key Chaining menu, you can configure which keyers are chained together in each chain. The following rules apply:

- Each keyer may not be in more than one Key Chain.
- All keyers in a Key Chain will be equal in command priority.

Key Chaining is part of the GV Switcher configuration and saved as part of File Ops, Suite Prefs. A layer of load granularity (*Key Chaining* button) has been added to this menu.

Keyers are controlled from the Transition Module on the GV Switcher Control Panel. They can be cut on/off or transitioned on/off using the dedicated Key Cut and Auto buttons. Key chaining allows for a single button push to transition all the keys in the chain. A single keyer selection in the Next-Transition area will similarly cause the other keys in the chain to be selected. Then a single push of the *Auto* button or movement of the Lever Arm will cause all of the keys in the chain to transition on one or more M/Es simultaneously.

Creating a Key Chain

To create a Key Chain or chains in a single M/E, simply select a Chain parameter data pad (Chain 1, Chain 2, etc.) to select it (turns blue), and select the keys you wish to add to the chain. Select another Chain parameter data pad and repeat the process (for the same M/E in this case).

The Chain parameter data pads display each M/E and either dashes (if empty) or Keys 1-4/6 if keys are enabled for that M/E in the chain.

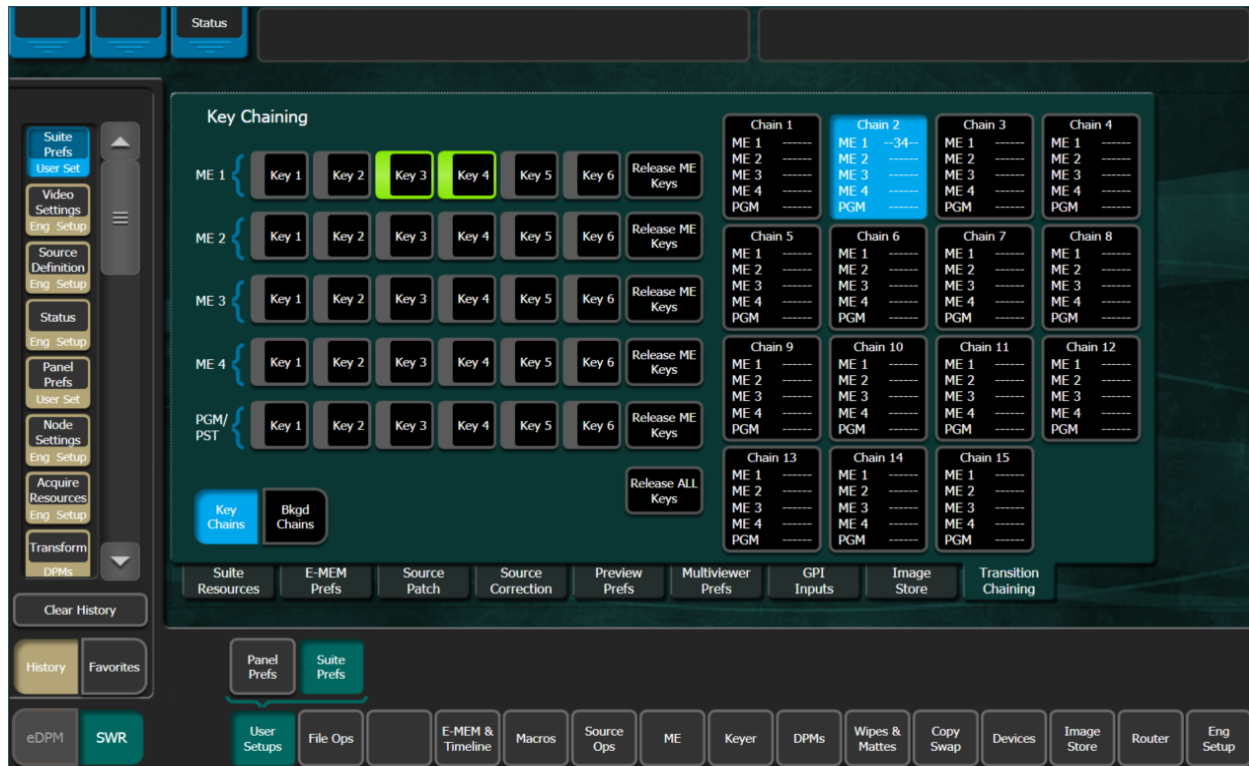

Result: Once a keyer is enabled as part of a chain, the button is grayed out as each key can only be part of one chain.

The Release ME Keys and Release All Keys buttons are provided to help manage Key Chain configuration.

Using Key Cut/Auto Control Panel Buttons

Pressing any of the key cut or key auto cut (for example *K1 Cut* or *K1 Auto*) transition buttons, with those keys as part of a chain, will result in the following:

Chained keyers on the same or different M/Es all transition simultaneously,

The transition rate of the button that is pressed (controlling keyer) is applied to all the other (controlled) keyers in the chain.

Key Chaining on a Single M/E

In the Chain parameter data pads, the following three key chains have been created for M/E 1:

- Chain 1—Keys 1 and 2,
- Chain 2—Keys 3 and 4, and

- Chain 3—Keys 5 and 6.



Selecting keys in the Next-Transition section of the Control Panel will make those keys initiators for the transition. Key Chaining causes the chained (controlled) keys to be selected as well. These chained keys will flash to indicate they are in the chain. The keys which do not flash are the initiators. When the Lever Arm is moved, or the *Auto* button is pressed, the keys transition together.

If a selection is made for a keyer in the primary partition, and the chained controlled key is in the secondary partition, the controlled keys will transition simultaneously with the keys in the primary partition, irrespective of the delegation of the *Sec* button (Source Select Module). The same is true for selections made in the secondary partition with controlled keys in the primary; they always delegate whether or not the *Pri* button (Source Select Module) is delegated. This behavior corresponds to the tally of the next-transition buttons. The blinking tally indicates that the keys will transition.

Key Chaining Across M/Es

In the Chain 1 parameter data pad below, the following multiple M/E key chain has been created:

- PGM/PST, Key 1,

- ME-1, Key1



Selecting a keyer in the Next-Transition section of the Control Panel will make that keyer the initiator. On the M/Es with keyers in the chain, their next-transition selections will be erased and the keyers in the chain selected. These keyers will flash to indicate that they are in the chain. The key which is not flashing is the initiator.

You can also use the Cut/Auto keys as described in [Using Key Cut/Auto Control Panel Buttons](#), on page 297. If a Cut button is pressed on the initiating M/E, then all the M/Es with chained keyers, cut. If an Auto button is pressed, then similarly, all M/Es with chained keyers shall perform the same transition at the same rate.

Other non-chained keys or other transition elements can be added to the next-transition at this time. Key chains can be established with keys both in the same and different M/Es.

Background Transition Chaining

There are two chains available for Background Chaining in the menu. You could for example chain backgrounds for ME-1, ME-2, and ME-3 in Chain 1 and for ME-4 and ME-5 in Chain 2.

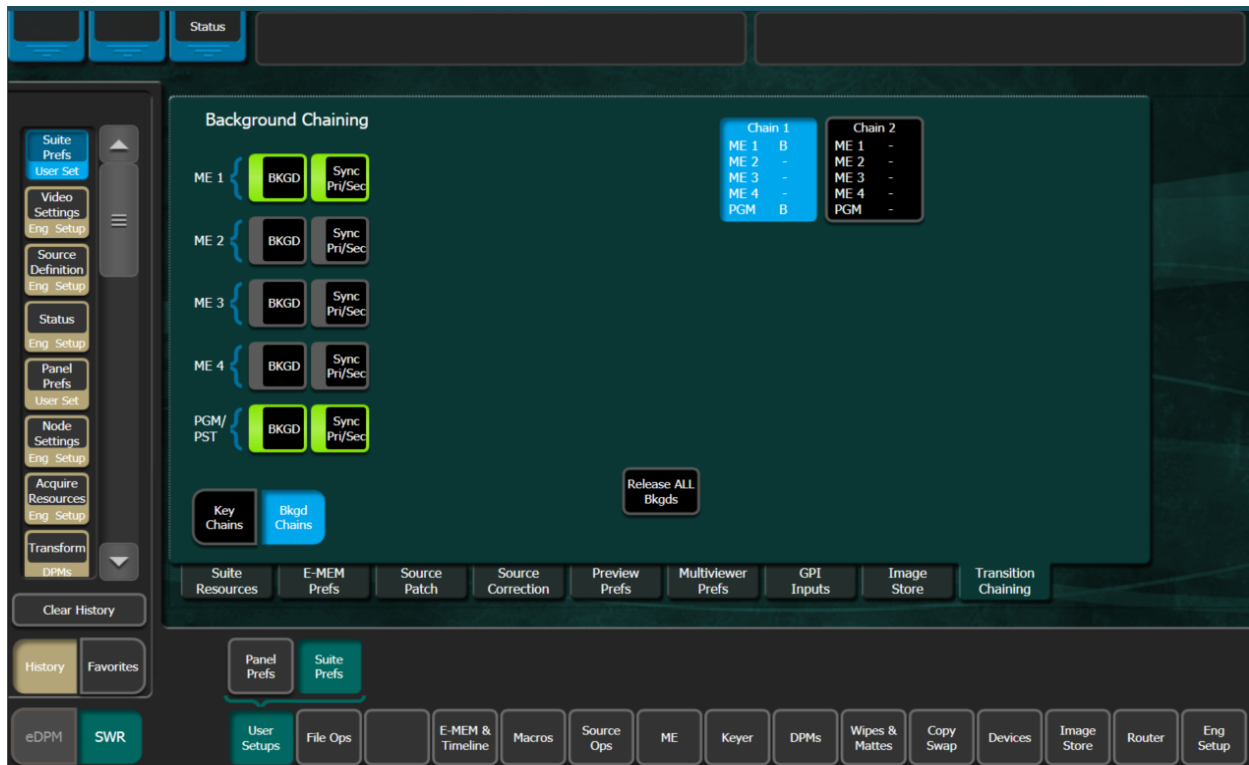

Similar to Key Chaining, where the first M/E Keyer button pressed on the Control Panel is the controlling M/E for the chain, the first M/E Bkgd button pressed on the Control Panel becomes the primary or “controlling” M/E. This is important for example when you are coupling M/Es (backgrounds, keyers, buses, etc.) for a multiple feed or 3D broadcast, it will be much more effective to switch the show from the primary M/E with the secondary M/E(s) following.

Note: The Primary M/E’s Bkgd Transition button (once pressed) will be high tally while chained Bkgd Transition buttons will flash.

The primary M/E’s transition type and rate are not copied into the other M/Es with Background Chaining.

In the Background Chaining menu, in the Chain 1/Chain 2 data pads, a “B” is displayed next to the M/E when that M/E’s background is part of the Background chain.

Note: An M/E can only belong to one Background Chain at a time, so once chained it will be grayed out and unavailable to the other chain.

About M/E Split Mode

Split Mode allows the operator to divide a GV Switcher system M/E into two partitions (Primary and Secondary) by enabling Split Mode on that M/E. Each Split Mode M/E partition can be assigned resources (keyers and wipe generators) of that M/E. Each partition can be setup and controlled from the Control Panel using the *Pri* and *Sec* delegation buttons, and each partition has its own E-MEM sub-level, permitting precise independent control of M/E partition effects. A powerful aspect of Split Mode is control of the partitioning resides in the E-MEM system itself. It is possible to create M/E partitions when needed with an effect recall, and then quickly return the M/Es to full functionality with another effect recall. The Split Mode feature also provides Preview outputs for each partition

Putting M/Es in Split Mode essentially gives the operator more M/Es (up to eight on a 4-M/E GV Switcher system), each with part of the M/Es functionality. This can be useful for some styles of production. In fast paced programs an operator may dedicate an M/E to a simple task for the duration of the show and never change it. Split Mode provides a way to use some resources of an M/E for these set-and-forget requirements, and allow the operator to use the remaining resources of the M/E for other purposes.

Note: E-MEM control of the Primary and Secondary M/E outputs and Layered parameters (on the ME Mode menu) have been placed in the ME/eDPM Part sub-level. This is a logical organization of M/E output/layered control for E-MEM recall and will prevent M/E Secondary output recall issues that may have occurred with earlier releases.

An example of using Split Mode in this manner is a shot clock at a sporting event. The shot clock composite requires only one or two keys plus a background and uses a fixed camera that doesn't move. During pre-production M/E 1 can be split and the Secondary partition can be set up with the shot clock composite. When the shot clock is needed during the show, that partition of the M/E is taken on-air. The Control Panel M/E-1 controls can be delegated to the Primary partition and be used for other effects, which can be set up, recalled, and run independently from the Secondary partition used for the shot clock.

Split Mode can also be used for other purposes. For example, complex composites could be built on the Secondary partition of an M/E by assigning all keyers to that partition. The Primary partition of that M/E is then used only for background transitions between the A and B buses.

Splitting an M/E with Split Mode is useful when independent control of each partition is desired, so E-M/EM recalls and transitions only affect part of the M/E. If you want an alternate output from the same M/E but wish to have the effects and transitions track on both outputs, Programmable Clean Feed mode is probably the better choice.

M/E Split Mode in the Menu

In Split operating mode, the M/E is divided into Primary and Secondary partitions. The Primary partition has the Pgm A and Pgm B outputs that use the Background A and B buses, and the Secondary output has the Pgm C and D outputs that use the Utility buses. The Pgm Out columns on the menu are re-arranged when Split mode is selected to show the A and B Primary outputs on the left and the C and D Secondary outputs on the right.

The Secondary Assign pane is used to assign Keyers to the Secondary partition. Assignments made here affect what elements are learned and recalled by the E-MEM levels (see Split M/Es and E-MEM Control on page 363). Selecting an item so its indicator illuminates green, assigns it to the Secondary partition. The buttons for these items are then activated on the Secondary partition outputs. Unselected items remain assigned to the Primary partition. Note that keyers can be activated or deactivated (green button indicators on or off) on the individual outputs if desired, the same as in Programmable Clean Feed mode.

Keyer Partition Visibility

Keyers assigned to the Secondary Partition output can be made visible on the Primary Partition output and vice versa by selecting the Key buttons in the Primary Keyers Visible on Primary/Secondary Partition panes in the ME, Mode menu.

Assigned key buttons can also be turned on and off in the ME Output pane (far right).

For example, Key 2 and Key 3 on the Secondary Partition can be made visible on the Primary Partition by selecting Key 2 and Key 3 in the Secondary Keyers Visible on Primary Partition pane in the ME, Mode menu.

Partition (Split) an M/E

The ME Mode menu is used to activate Split Mode on an M/E and assign resources to the partitions.

- 1 Select **ME, Mode** in the menu.
- 2 Select the desired M/E and select **Split** to partition that M/E.

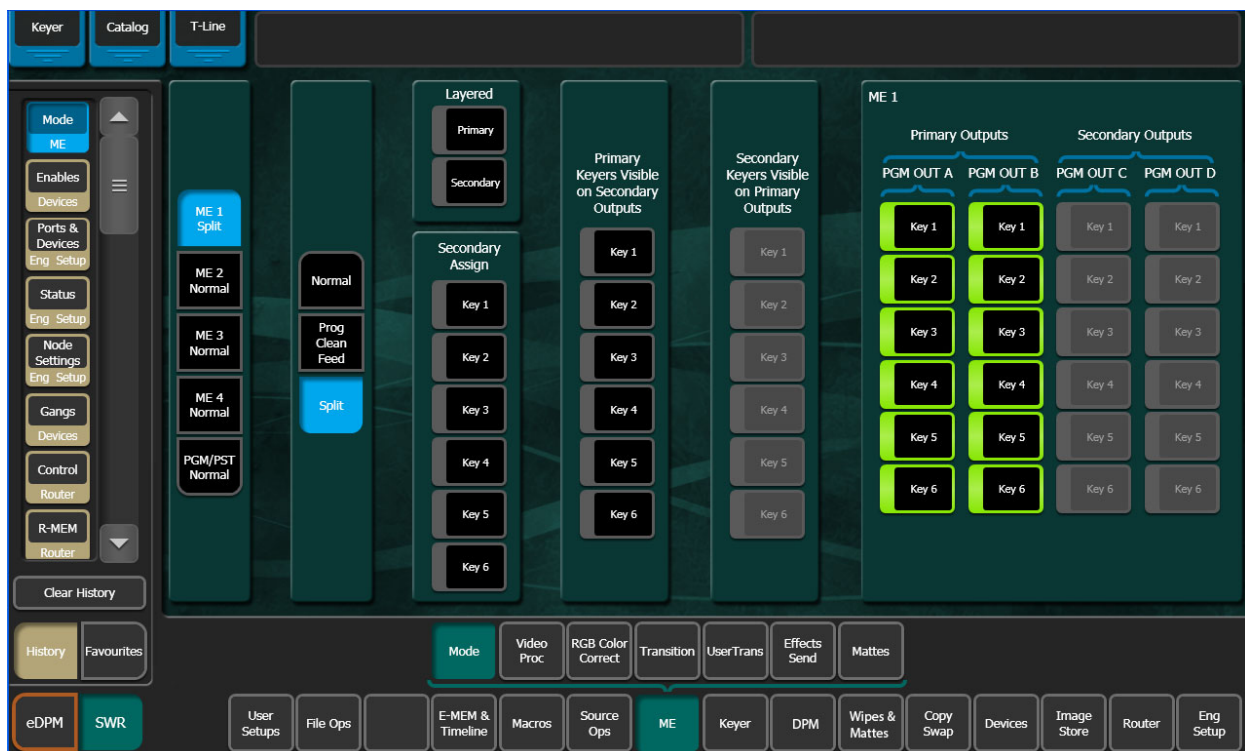

The keyers will be visible in the Primary Partition but are controlled only by the Secondary.

M/E Split Mode from the Control Panel

When an M/E has been split, the *Pri* and *Sec* delegation buttons on that M/E are activated. All M/E stripe resources (E-MEM, Transition, etc.) are delegated to the selected partition. When both the *Pri* and *Sec* buttons are selected, the Primary partition's state will be delegated.

Secondary Partition Only

With the Secondary partition delegated (the *Sec* button selected), a separate set of background sources from the Primary can be delegated. This can be useful for example if you want to delegate keyer buses Keyer 1 and Keyer 2 to the Primary partition and Keyer 3 and Keyer 4 buses to the Secondary. Any background buses can be assigned to a partition, even the same buses; for example the same background in each partition but with different key sources composited.

M/E Partition Preview

Preview outputs are available for both partitions of a Split M/E. The ___ MxpA output of each bank is used for the Primary partition preview, and the ___ Mxp2 output is used for the Secondary partition preview. These preview signals can be mapped to output connectors with the Output Assignments menu, accessed by selecting Eng Setup, Outputs.

You can preview M/E primary and secondary M/E partitions on switched preview using the System Bar. Press the Sw PVW button and select an M/E for primary, select the ALT button (next to Sw PVW) to see the secondary.

Transitions in Split Mode

When the Control Panel controls of a split M/E are delegated to only one partition, the M/E's main transition system controls only that partition. Moving the Transition Lever Arm or pressing the *Auto Tran* or *Cut* buttons will affect only the delegated partition. Only elements assigned to that partition may be selected for the next transition. Keyers associated with the other partition may not be selected and therefore can not be included in the transition.

When a split M/E has been delegated to both partitions, all the controls become functional and simultaneous transitions in both partitions will occur for what ever elements are selected.

As an exception to the independence of the two partitions, the *Key Cut* and *Key Mix* buttons can always be used regardless of partitioning and panel delegation. If a keyer is associated with the secondary partition, the *SEC* indicator above the keyer's cut and mix buttons illuminates to inform the operator that the keyers are not assigned to the primary partition.

Correcting Split M/E Mode Out of Sync Transition Lever Arm

If a split M/E is delegated to a different partition when a transition is in progress, an out of sync condition of the transition lever arm will probably result. This situation is similar to recalling an E-MEM register that splits the screen with a transition wipe. The Transition

Lever Arm will need to be re-synced (by moving the lever arm to a limit) before it can be used to finish the transition or start a new one.

Local E-MEM in Split Mode (Kayenne/Karrera)

When the M/E bank of a split M/E is delegated to one partition, that M/E's Local E-MEM will control only that partition's E-MEM registers. Learning, recalling, and running effects will only occur on the currently selected partition.

When the M/E bank is delegated to both partitions, effect recalls and runs are initiated in both partitions and are controlled simultaneously.

When effect registers are saved to disk, all the levels of that effect are saved, including information for both partitions of a split M/E.

Master E-MEM in Split Mode

The Master E-MEM allows for enabling the M/E levels. If the M/E is not split then all M/E control except for ME Mode is with the ME Primary level and the ME Secondary level is disabled. When the M/E is split then the control for the Secondary is with the ME Sec level.

The ME Mode is controlled by the ME Partition sub-level. ME Mode includes ME Split Mode, the assignments of the Keyers, Layered Mode and configuration of the ME PGM outputs.

The Partition Level by default has the M/E partition sub-level for each of the M/Es. The M/E partition sub-level can be assigned to other levels. It's recommended that if having an M/E level control its own partitioning is desired, then the Primary ME level should be used. If the M/E partition sub-level is assigned to an ME Secondary level, there is a potential for that level to be disabled and the partition sub-level with it.

Split M/Es and E-MEM Control

When an M/E is split, the Primary and Secondary partitions each have their own essentially separate E-MEM system. How each of these partitions are controlled by E-MEM operations depends on the E-MEM Prefs settings for that M/E.

M/E Copy in Split Mode

The Copy/Swap function can be used to copy M/E settings from one location to another. ME Copy and Swap operates on the entire M/E regardless of mode or secondary assignments. For example, if a source M/E is split and the destination M/E is not, after a copy both M/Es will be split. Swaps behave in a similar manner, with the split setting and resource assignments being swapped between the M/Es.

Partition Boundaries

The ME mode (Normal, Prog CF, and Layered Mode when in Split mode), output, and any secondary assignment information is stored as partition boundary information in the E-MEM system itself. This makes it possible to change an M/E's mode with an E-MEM recall. This partition boundary information is maintained as a separate component to permit

isolation between Primary and Secondary partitions. See [Partition Boundary Control](#), on page 305.

On a GV Switcher system, the default settings assigns the partition boundary to the partition level (PART) accessed in the User Setups, Suite Prefs, E-MEM Prefs, ME Partitions menu.

E-MEM Level Assignments in Split Mode

When an M/E is split, essentially two separate E-MEM systems are created. The primary partition is always associated with its own E-MEM level. The secondary partition is part of the PART Level and becomes enabled when the M/E is placed into Split Mode. These settings affect how each split M/E's Local E-MEM Module and how the Master E-MEM Module is used to enact E-MEM control of the M/Es.

Partition Boundary Control

The partition control information can be assigned to an E-MEM level, or not be assigned (Not Assigned). Which level the partition control is associated with controls the amount of isolation between Primary and Secondary partition E-MEM behavior.

- For the switcher default, the partition boundary is assigned to a different E-MEM level entirely and complete independence of the split M/E partitions results. This setting can be used to map all M/E partition boundaries to the same separate level. This level can be used to preset the partitioning of the entire switcher, and then Primary and Secondary E-MEM operations would not change the switcher settings.
- If the partition boundary is assigned to the Secondary partition, recalls by the Secondary partition splits that M/E. This setting would work with the shot clock example cited in the introduction, especially if the shot clock is used frequently and the remaining resources of that M/E are sufficient. Note that there is a chicken and egg aspect to this mapping. The M/E cannot be split from the Control Panel by recalling a Secondary partition unless the M/E is already split. You will need to go to the ME Mode menu and manually turn on Split mode to activate Secondary partition recalls from the Control Panel. You will also need to manually turn Split mode off from the menu to restore all the resources to the Primary partition.
- If the partition boundary is assigned to the Primary partition E-MEM level, every E-MEM recall of the Primary partition of a split M/E imposes the ME mode and the secondary resource assignments. E-MEM recalls of the Secondary partition will not change the current mode or alter any resource assignments. This mapping is useful in cases where split ME mode is used occasionally during a show, but the M/E is normally used unsplit. Primary partition E-MEM recalls will split the M/E when desired and restores it when all resources are needed by the Primary partition. Note that all the effects built on the Primary partition will need to include consistent partition boundary information. If any change is made later in ME partitioning, all the Primary partition effects will need to be edited.
- If the partition boundary is unassigned (none), E-MEM recalls will not affect the current M/E settings. Changes can only be done manually in the ME Mode menu.

A Primary partition is always associated with an M/E's main E-MEM level and has a dedicated button in the Master E-MEM Module (ME 1, ME 2, ME 3, Pgm Pst). A Secondary partition has its own level, enabled in Split Mode. There are also dedicated buttons in the

Master E-MEM Module (ME 1 Sec, ME 2 Sec, etc.) which are enabled when the M/E is in Split Mode.

- If a Secondary partition is unassigned (none), E-MEM control is only available on that M/E's individual Local E-MEM when it has been delegated to a Secondary partition. The Master E-MEM will have no control of that M/E's Secondary partition.
- If a Secondary partition is enabled, then E-MEM control of that Secondary partition will be available from the Master E-MEM. Control continues to be available from that M/E's individual Local E-MEM when it is delegated to its Secondary partition.
- If a Secondary partition is attached to its Primary partition level, E-MEM control of the two partitions will be linked together. Specifically, Master E-MEM operations for that level will always affect both partitions. When the individual M/E is delegated, E-MEM operations will affect both partitions. However, when the individual ME Secondary is delegated, E-MEM operation will only affect that Secondary partition.

Split Layered Mode

Video Compositing, or Layered Mode is a feature that allows the operator to composite two keyers together to create a single video/key pair. These two signals are to be routed in parallel to provide a much cleaner key than would normally be possible. This key pair can be re-entered into the switcher on another keyer to create more key layers on a different M/E. This compositing of keys can be done on either or both of the primary and secondary outputs.

Split Layered mode can be particularly useful for taking more keyers than are available on one M/E board. For instance you can split ME 1 and assign keyer 1 to the primary side and keyers 2, 3, 4, 5, and 6 (on a six keyer system) to the secondary side. On Pgm-Pst, assign keyer 6 to ME 1 secondary as the source for the keyer. You now have the six keyers on Pgm-Pst plus the ME 1 Keyers 2, 3, 4, 5, and 6 on Keyer 4.

Layering is enabled on an M/E-by-M/E basis in the ME Mode menu. When enabled for the primary output, the A output has black selected as the background source and the B output acts as the key cut signal for the keyers selected for the primary output. Similarly, for the secondary output the C output has black selected as the background source and the D output acts as the key cut signal for the keyers selected. Priority of the layers is set using normal keyer priority controls.

Split Layered Mode Menu Controls

The Layered panes are enabled only when the Split button is selected in the Mode pane. Selecting Split, then selecting the Primary button sets the Primary partition to Layered

mode. Likewise, selecting the Secondary button sets the Secondary partition to Layered mode.

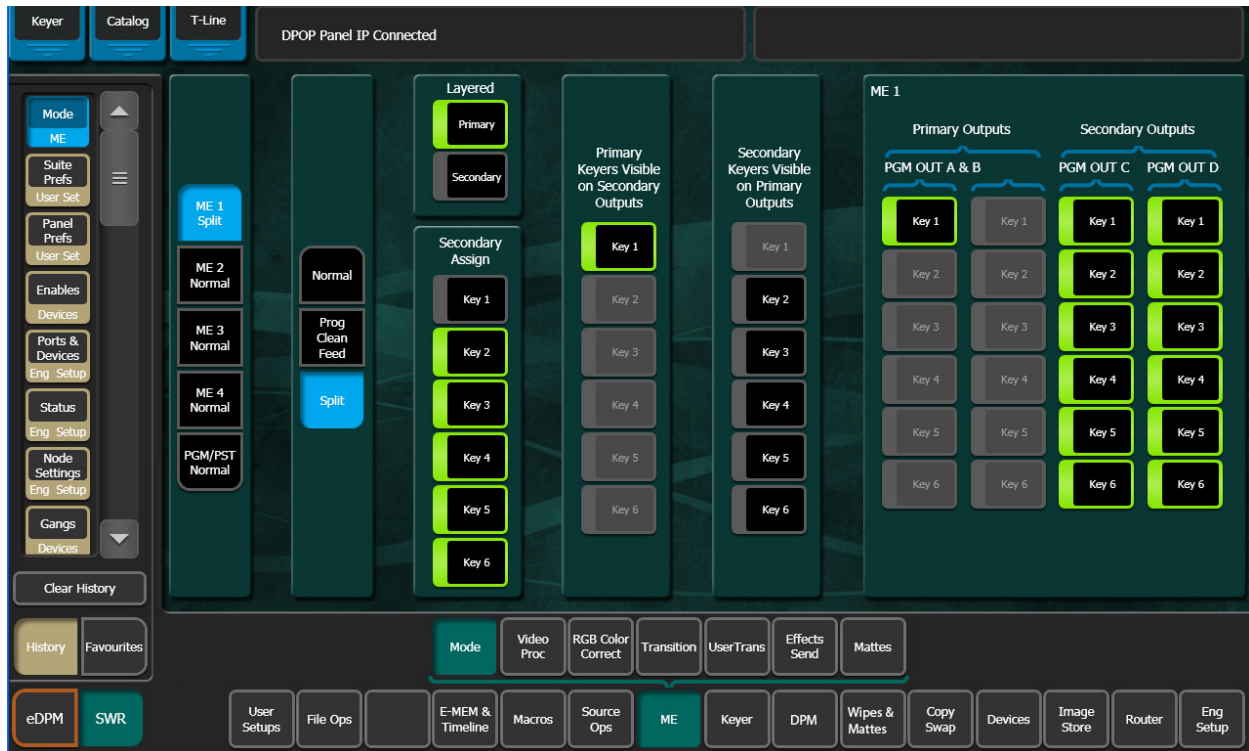

Partition Sync Mode

Partition Sync mode (*Sync Pri/Sec* buttons) synchronizes or “locks” the chained background transitions together and puts the Lever Arm in a primary transition-only state, with the secondary transition attached. If you perform a Primary and Secondary transition without Partition Sync on for a split M/E, the two outputs may be slightly offset. Turning on a SyncPri/Sec button precisely synchronizes the backgrounds for transition.

There is no general need to chain the primary and secondary partitions of an M/E, this can be done by selecting both the Pri and Sec buttons in Split Mode.

Partition Sync

Partition Sync selects the M/E’s Primary and Secondary partition. The *Pri* button high tallies red and the *Sec* button high tallies green to indicate this mode. Without using Partition Sync, there is no way to lock the Pri/Sec mode on, so if you have a Program Clean Feed set up on Primary and Secondary partitions for re-entry, and you forget to turn the Pri/Sec mode on for that M/E, upon transition the secondary partition would not re-enter as a clean feed so the Program Clean Feed would be lost.

Operations

Background and Key Chaining and Partition Sync are configured in the Menu Panel.

With the introduction of GV Switcher DoubleTake, you could Split an M/E and its keys between two feeds, for example one feed in English using the Primary Partition and one in French using the Secondary or you could use one partition with keys for Left-Eye and one for Right-Eye for use with 3D. However, you were limited to up to six keys divided between feeds (four full or “complex” keys for K-Series systems (no keys 5 and 6)), two of them being “simple” keys (Key 5 and Key 6). With Background Chaining, you can have a split feed using two full M/Es rather than two partitions, with the power and flexibility of all licensed keys per feed and two backgrounds (with the same or different sources by using source substitution).

In addition, you are not limited to two M/Es, you could chain the backgrounds of all the M/Es in your Control Panel. You could switch a multiple feed show from the English M/E and also feed the show in French and Spanish using three M/Es.

Create Primary and Secondary M/Es (Dual Feed)

In the following example procedure, a dual feed with English on the Primary and French on the Secondary ME will be configured. The A and B background buses will be chained and bus linked and three full keys will be chained on ME 1 and three on ME 2. The result is the operator can switch the show completely from ME 1 and use two full M/Es with all licensed keys for each of the dual feed outputs.

ME 1 will be the primary, controlling M/E, i.e. ME 2 sources, background buses, and keys will “follow” ME 1.

Prerequisite: ME 1 and ME 2 are licensed and acquired resources (or other licensed M/Es, for example ME 3, ME 4).

- 1 In the User Setups, Suite Prefs, Transition Chaining, select the Bkgd Chains menu button (lower left).
- 2 Select ME 1 to assign it to the chain.
- 3 Select ME 2 to assign it as the secondary or “controlled” M/E.
- 4 To synchronize the background transitions, select the Sync Pri/Sec button for the controlling M/E (in this example, ME 1).
- 5 Select the Key Chains selector button to access the Key Chaining menu.
- 6 Select one of the 15 Key Chain data pads and Chain ME 1, Key 1 to ME 2, Key 2 by selecting those buttons in the Key Chaining pane.
- 7 Repeat Step 5 for ME 1/ME 2 Key 2 and ME 1/ME 2 Key 3.
- 8 Go to the Bus Linking menu by selecting Source Ops, Bus Links.
- 9 In the Links Setup menu tab, select the Controlling Bus data pad in the Table Setup pane.
- 10 In the ME Buses pane, select ME1 A.
- 11 Select the Linked Bus data pad, and select ME2 A in the ME Buses pane.
- 12 Repeat Step 9 and Step 10 for ME1 B and ME2 B.
The A and B buses for ME 2 will now follow the A and B buses for ME 1.
- 13 To make ME 1 the controlling M/E for the chain, press the ME 1 Bkgd transition button on the Transition Module.

Multiple Feeds

Starting with the example in [Create Primary and Secondary M/Es \(Dual Feed\)](#), on page 308, you could chain additional M/Es for multiple feeds. This should be planned carefully but once configured, the entire show can be switched from the Primary ME thus simplifying a very complex set of operations.

Including Source Substitutions

Source substitutions can also be a powerful part of chained M/Es. They can be used to cut on two or more different sources for the chained M/Es and switched from the Primary ME. For example during a "Home" versus "Away" baseball game, the Primary ME could take a camera source in the Home team's dugout on Source 1 but take a different camera on Source 11 on the Secondary ME in the Away team's dugout using the source substitution (see [Bus Linking Source Substitution Tables](#), on page 150).

Source substitutions could also be used across multiple feeds for different languages or for paid cable verses network feeds and so on.

Transition Chaining is part of the Load Granularity pane in the File Ops, User Setups, Suite Prefs menu.

About Corner Pinning

Corner Pinning allows you to move the corners of a source image relative to the background. Corner Pinning is keyframeable, with all standard path control functions. The new corner locations do not need to form a rectangle.

Corner Pinning is accomplished by distorting the source to fit into its newly defined corners. The modified image remains in its original source plane, and is not "bent" along the Z axis. Corner Pinning does not change the location of the axis of rotation or spin of the source image.

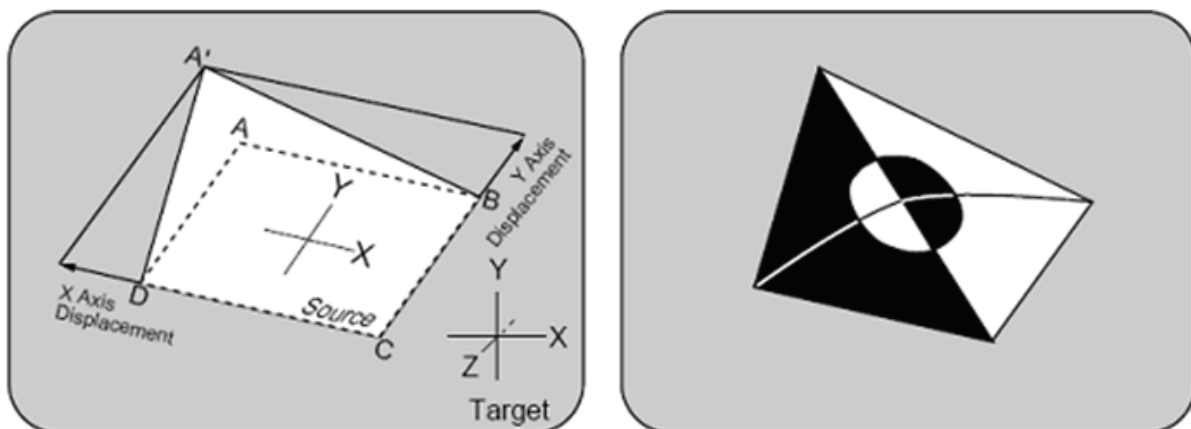

Corner Pinned Object

8623267_31

Corner Adjust Limits

Corner Pinning works for convex quadrilaterals but not for concave quadrilaterals. A convex quadrilateral is defined as a four-sided shape with all angles less than 180 degrees, all vertices point outwards and all diagonals lie entirely inside the quadrilateral.

Results from adjusting a corner beyond the limits are undefined.

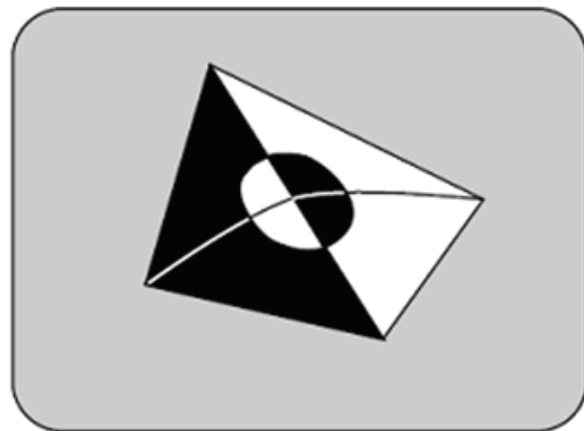
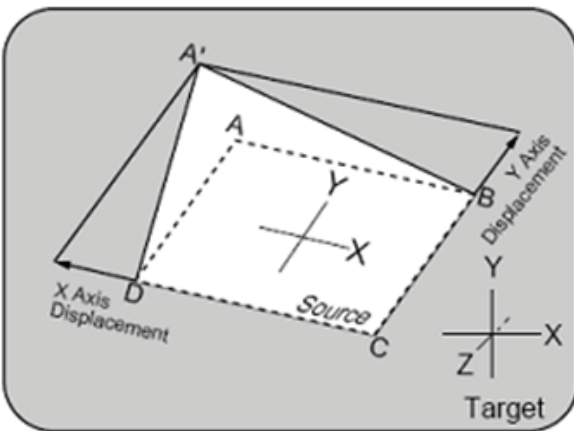

Convex Quadrilateral—Corner Adjust Limits

8623267_31

To allow fine adjustment of an image when using Corner Pinning, the View Through (View Thru Enable) feature allows you to temporarily (for editing purposes only) reduce the opacity of an iDPM channel to let you “look through” the image to align the corners precisely with the background.

Corner Pinning and Cropping

Corner Pinning is designed to work in conjunction with cropping. Each time Corner Pinning is turned on, the pinned corners will be adjusted to match the current iDPM crop settings. After pinning the corners of an image you can crop it to select the exact portion of the source video to display in the corner pinned area.

For example, your source video could contain two people, but you may want to fly the image of only one person. In this case, you could build an effect, turn on Corner Pinning, use crop mode, and leave the corners at the defaults. If you now move the crops maintaining the original aspect ratio (4x3 or 16x9) you can position these crops so that only the desired person is shown. If the person or the camera moves, you can adjust the user

crops to keep the person centered between the edges of the crops. This will result in the person being centered in the video and the effect can be flown around the screen.

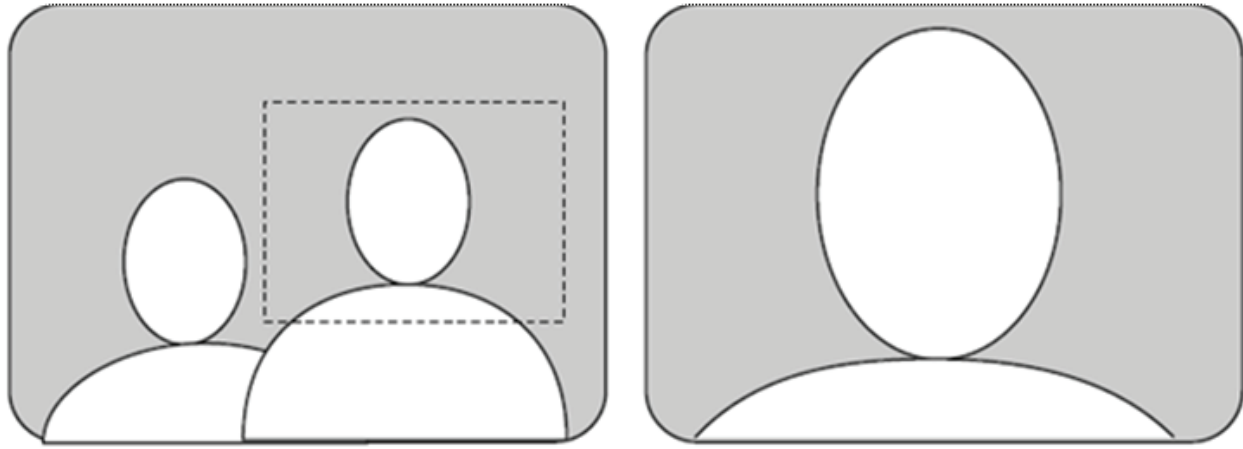

Corner Pinned Cropped Object

Note: Toggling Corner Pinning on and off will reset the corners to the current crop values and change the pinned corners.

Corner Pinning Menus

The **Corner** Pinning menu is available in both the SWR (Switcher) (iDPM, Corner Pinning) and the eDPM (option) mode (eDPM, Corner Pinning). The menu function identically.

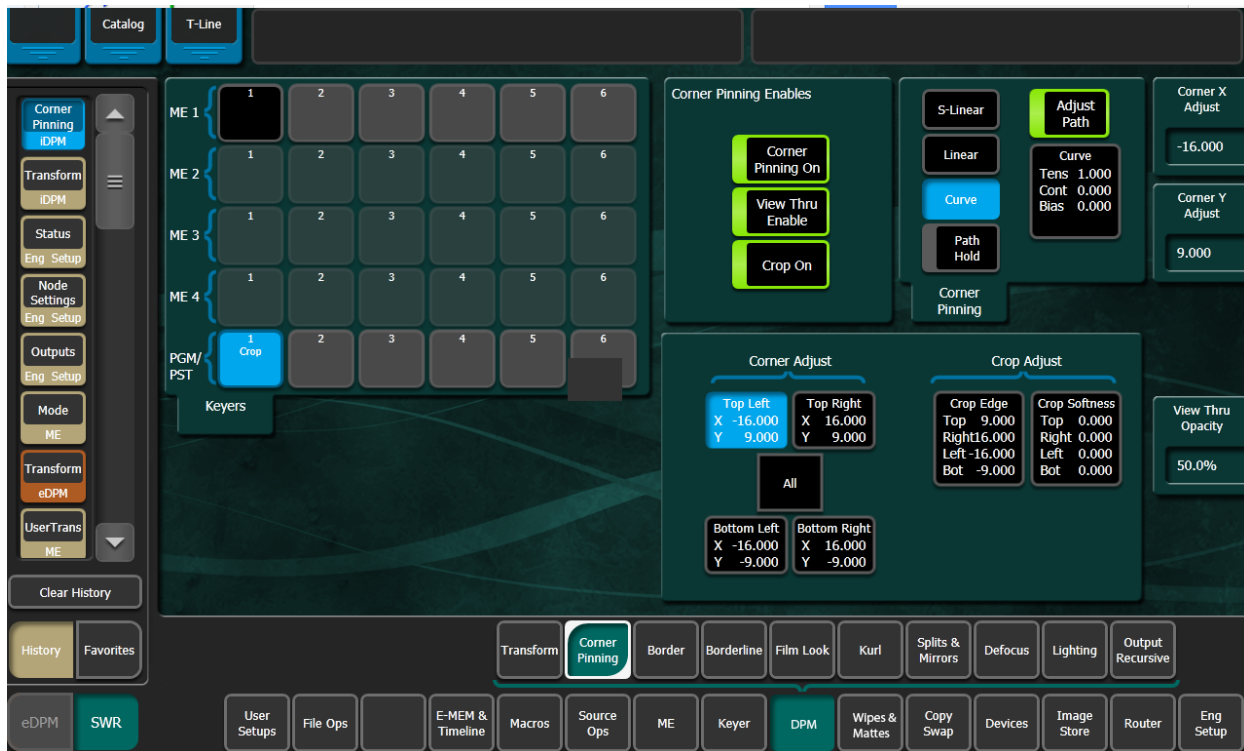

Select the **eDPM** mode button (lower left), **eDPM, Corner Pinning**.

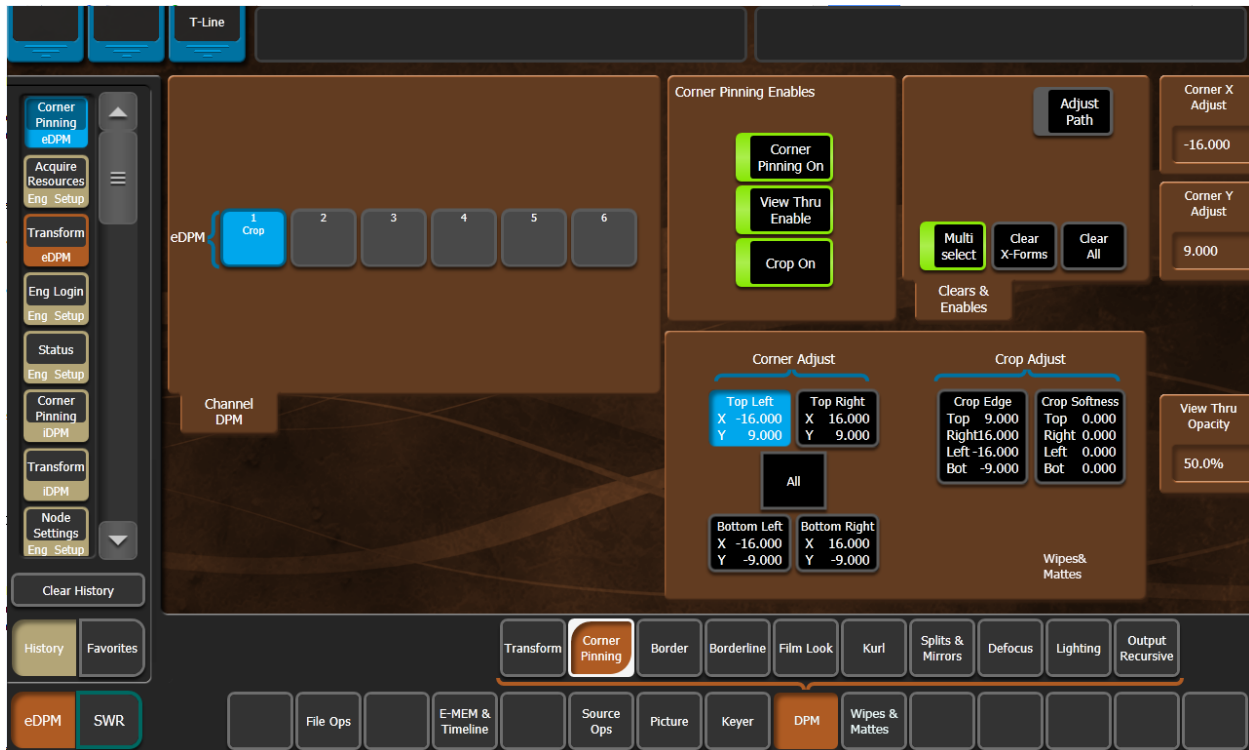

Corner Pinning example: during a sporting event, a camera points at a shot clock. The DPM uses Corner Pinning to build a box to contain the clock and crop adjustments place the clock exactly in the box but the camera is accidentally moved and the content of the box no longer shows the entire shot clock. Using Pan and Scan, you can move the camera content to be shown correctly without moving the edges of the box.

Crop enables/disables and crop edge parameter changes are global. For example, if crops are enabled in the iDPM, Transform menu, and the top crop edge parameter was changed, the effect would be mirrored in the Corner Pinning menu and vice versa in the iDPM, Corner Pinning menu.

Create a Corner Pinning Effect (Example)

By completing this task you will have an understanding of how to create an effect using Corner Pinning. This understanding of Corner Pinning functionality will allow you to create Corner Pinning effects for your own show.

- 1 Select a background source.
- 2 Select a source for a keyer, and cut on the key over the background.
- 3 Select **DPM, Transform** and turn on the **Crop On** button (highlights green).
- 4 Select the **Crop Edge** data pad (turns light blue), the Crop Edge soft knobs will be displayed.
- 5 Adjust the crop edges to include the portion of the video you want in the key.

6 Select DPM, Corner Pinning.

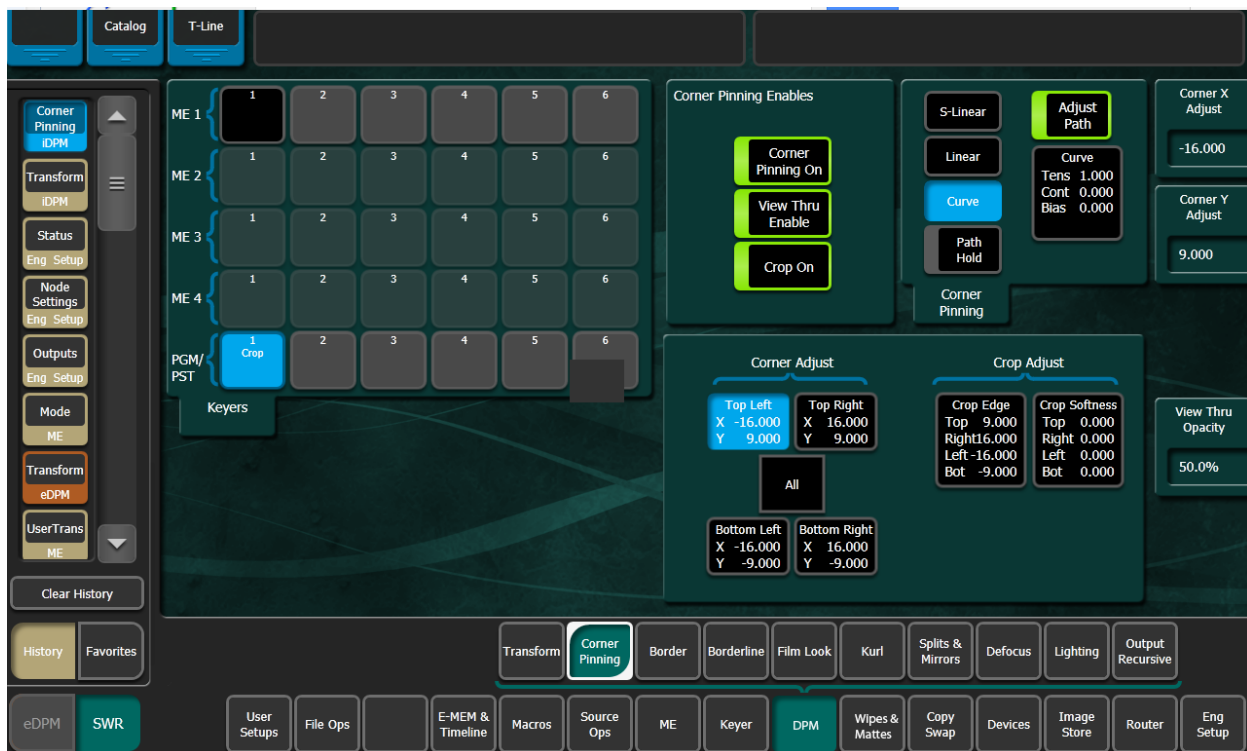

7 Select the **Corner Pinning On** button to turn it on (highlights green).

Result: The image will fill the screen—each corner of the key is now pinned to the corners of the monitor.

8 Select the **All** button in the Corner Adjust area of the Corner Adjust/Crop Adjust pane.

Adjusting the iDPM with the Corner Pinning All button enabled, acts similar to a zoom. Use the **Corner All** soft knob to adjust the size of the key; in this case to the approximate size of the shot clock.

9 Turn off **All Corner Adjust**.

10 Select the **View Thru Enable** button to turn it on. This will set the opacity of the video in the key to 50% so you can see the shot clock through the video which will help you align the corners of the image to the background video (the shot clock). The opacity can be changed using the **View Thru Opacity** data pad or soft knob.

11 Select a Corner Adjust button—**Top Left**, **Top Right**, **Bottom Left**, or **Bottom Right**, and use the **Corner Adjust X** and **Corner Adjust Y** soft knobs to pin the corner to the corner of the shot clock in the background video. This will allow you very precise adjustment. Repeat for each corner.

12 Turn off the View Thru Enable feature.

If the background video changes, you can re-center the image (shot clock in the example) using the *Pan* and *Scan* crop buttons. You 'Pan' the crop; move the crop sideways which

simultaneously trims the value of the Left Crop and Right Crop, or 'Scan' the crop; move the crop up and down, which simultaneously trims the Top Crop and Bottom Crop values.

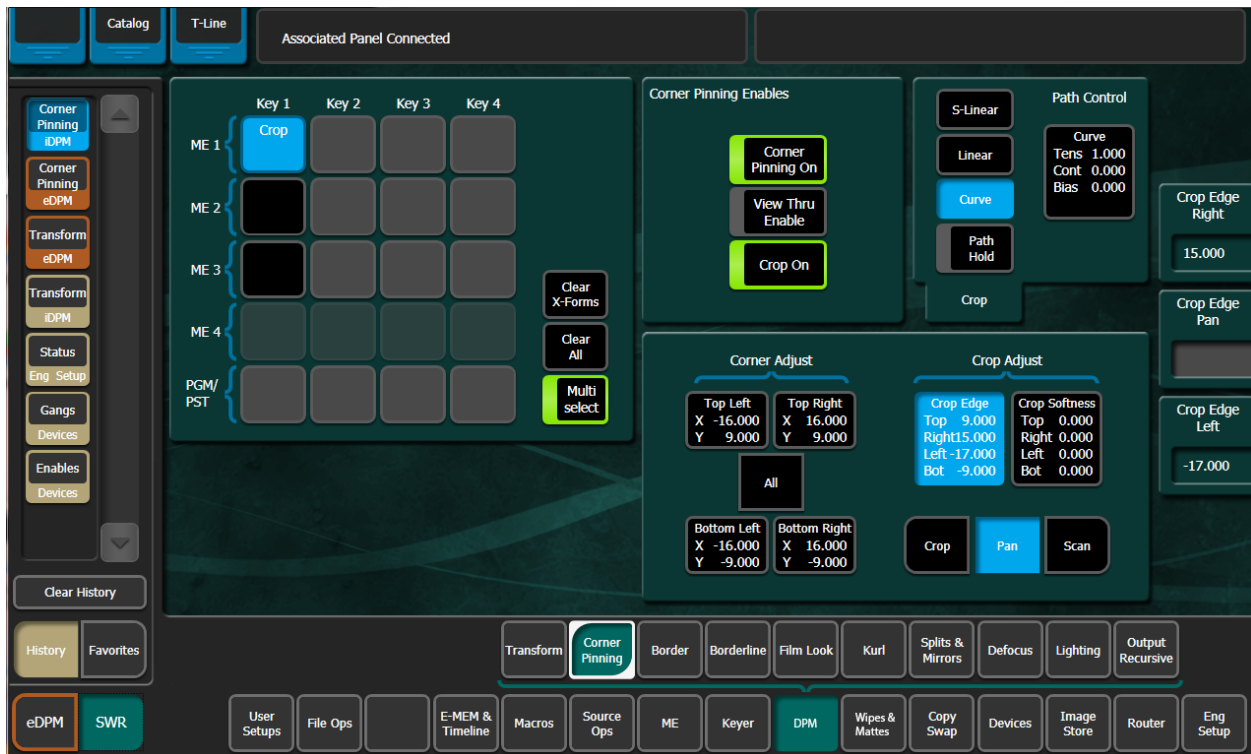

Re-center the image:

- 1 Select the **Crop Edge** data pad.
- 2 Select the **Pan** or **Scan** button.
- 3 Use the **Crop Edge Pan** or **Crop Edge Scan** soft knob to pan or scan until the image is re-centered.

Note: Panning scanning beyond (+ 16:9 for example) can have unexpected results, i.e. the picture may begin to stretch.

Corner Pinning from the Kayenne Control Panel

Corner Pinning can be performed from the MFM (Multi-Function Module), in the iDPM (and identically the eDPM), CPin menu.

The CPin (Corner Pinning) button is in the iDPM menu of the MFM.

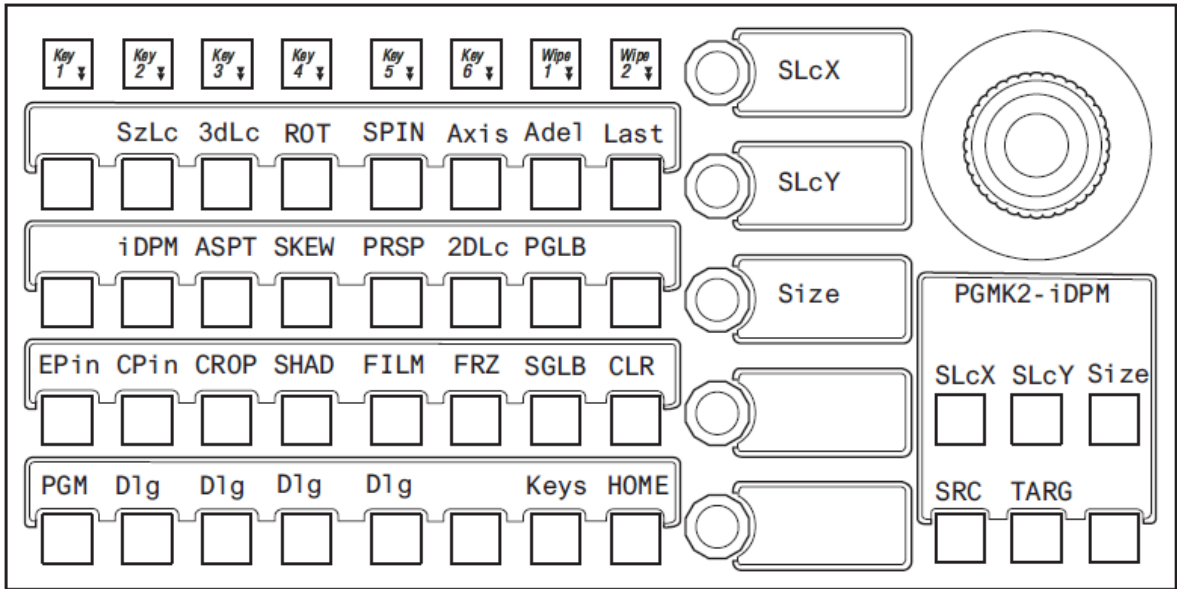

iDPM Menu—Multi-Function Module

Corner Pinning and Crop controls are located in the CPin MFM Module menu. Press the CPin button to enable/disable Corner Pinning, press the D1g button directly below to turn on Corner pinning and adjust the Corner Pinning parameters using the soft knobs.

Note: Corner Pinning and Crops have their own path controls, however each corner and each crop edge share the same path. See [Change Path Control Values in an Effect](#), on page 264 for more information about paths.

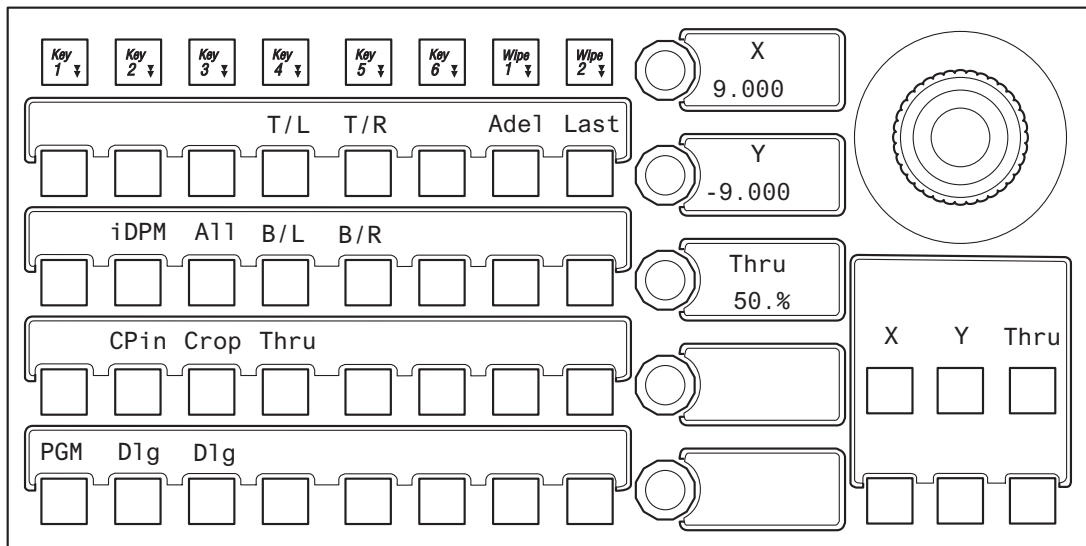

iDPM, CPin (Corner Pinning) Menu—Multi-Function Module

8623267_23_r3

8623267_29

The All and Corner buttons:

- T/L—Top Left,
- T/R—Top Right,
- B/L—Bottom Left, and
- B/R—Bottom Right,

The All and Corner buttons are the same as in the Corner Pinning menu (see [Corner Pinning Menus](#), on page 311). The MFM soft knobs are used for adjusting the corners when selected.

The Thru button performs the same function as the View Thru Enable button in the menu but is momentary (opacity setting is only visible when the button is held down). The opacity is adjusted with the Thru soft knob.

Crop is available in the CPin menu. When Corner Pinning is enabled, and the Crop button is pressed, the All button will be added to the Crop menu. The All button is a toggle that includes All, Pan, and Scan. Each work as in the menu. Z operation of the joystick operates the All crop adjustment (works similar to zoom), X and Y operates as Pan and Scan.

Crop All and Crop Edges can be adjusted using the soft knobs.

Note: Crop Softness controls are not available for crops when Corner Pinning is enabled in the MFM, however Crop Softness controls are available in the Menu Panel.

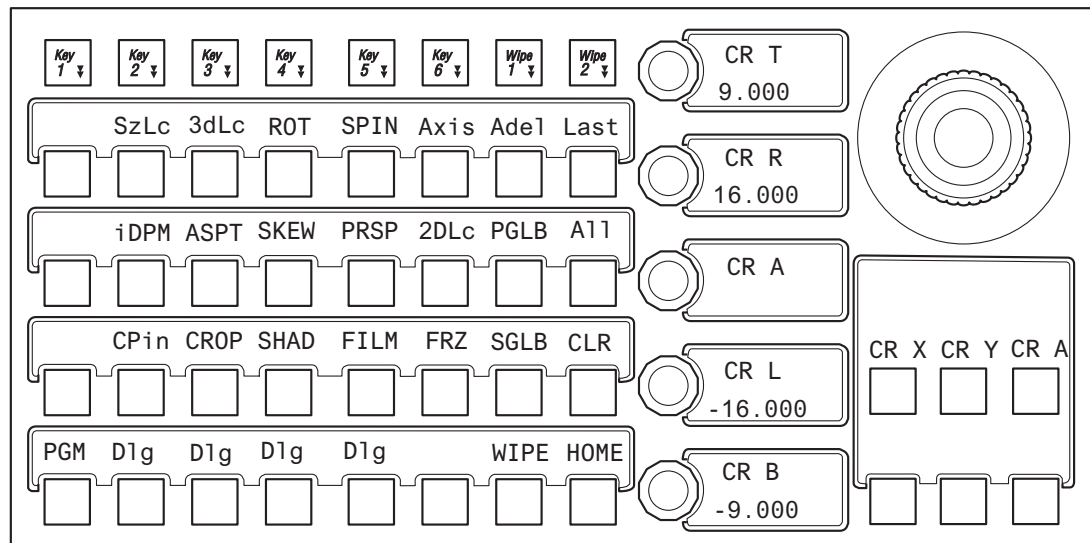

Corner Pinning, Crop Menu—Multi-Function Module

2D DPM Edge Pinning

Edge Pinning is the 2D version of Corner Pinning and is designed to work in conjunction with cropping. Each time Edge Pinning is turned on, the pinned edges will be adjusted to match the current 2D DPM crop settings. After pinning the edges of an image you can crop

it to select the exact portion of the source video to display or, conversely, you can crop the image and then pin the edges by stretching the image to the target location.

For example, your source video could contain two people, but you may want to fly the image of only one person. In this case, you could build an effect, turn on Edge Pinning, use crop mode, and leave the edges at the defaults. If you now move the crops maintaining the original aspect ratio (4x3 or 16x9) you can position these crops so that only the desired person is shown. If the person or the camera moves, you can adjust the user crops to keep the person centered between the edges of the crops. This will result in the person being centered in the video and the effect can be flown around the screen.

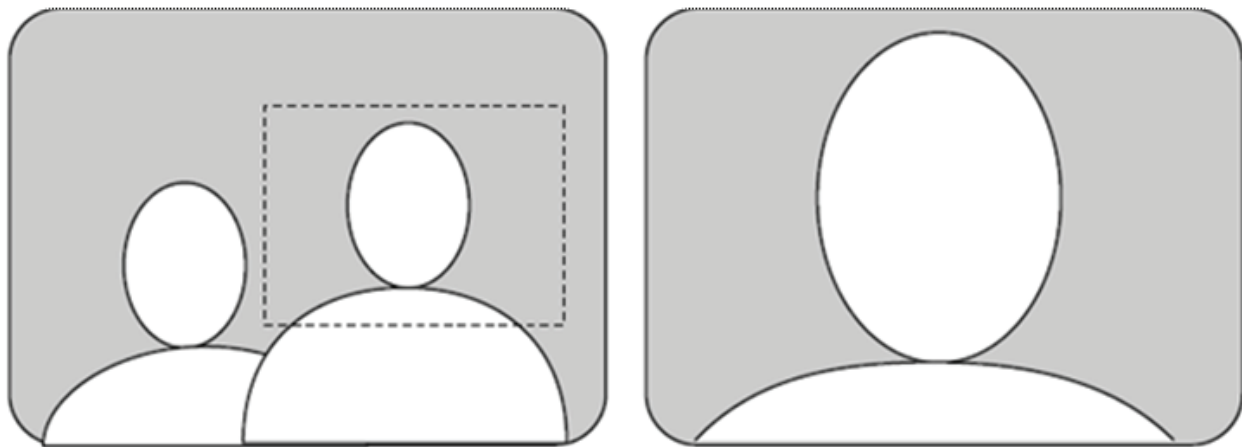

Edge Pinned Cropped Object

Note: Toggling Edge Pinning on and off will reset the edges to the current crop values and change the pinned edges.

Edge Pinning allows you to move the edges of a 2D DPM source image relative to the background. Edge Pinning is keyframeable, with all standard path control functions. Edge Pinning is accomplished by distorting the source to fit into its newly defined edges. Edge Pinning does not change the location of the axis of rotation or spin of the source image.

Edge Pinning example: during a basketball game, a camera points at a shot clock. The 2D DPM uses Edge Pinning to build a box to contain the clock and crop adjustments place the clock exactly in the box but the camera is accidentally moved and the content of the box no longer shows the entire shot clock. Using Pan and Scan, you can move the camera content to be shown correctly without moving the edges of the box.

Crop enables/disables and crop edge parameter changes are reflected across 2DPM menu tabs. For example, if crops are enabled in the Transform, Keyers 2DPM menu tab and the top crop edge parameter was changed, the effect would be mirrored in the Pinning, 2DPM menu tab and vice versa.

Create an Edge Pinning Effect (Example)

In this example of a shot clock box effect, used in a sporting event, a 2D DPM cropped box effect will be created and the edges of the box's video source pinned to the cropped edges. Then, using pan and scan, the video source will be repositioned inside the 2D DPM box

Advanced Operations

Create an Edge Pinning Effect (Example)

effect without moving the box. This effect is very useful if the camera is bumped or moved so the switcher operator can reposition the video from the switcher.

- 1 Select a background source.
- 2 Select **DPM, Transform, 2DPM** in the menu and select a keyer with the source for the box; in this case a camera pointed at a shot clock, and cut on the key over the background.



- 3 Enable the **Crop On** button (highlights green).
- 4 Enable the Crop Edge data pad (turns light blue), the Crop Edge soft knobs will be displayed.
- 5 Adjust the crop edges using the soft knobs to define the portion of the video you want in the box (key); the shot clock in this example.
- 6 Enable the **Post xform** data pad and use the soft knobs to size and position the key close to the desired area of the background using the soft knobs.
- 7 Select **DPM, Pinning, 2DPM** and enable the **Edge Pinning On** button (highlights green).
Enabling Edge Pinning will pin the video edges to the cropped edges of the box.
 - a Optionally, enable the **View Thru Enable** button to see the location of the box effect over the background video; this sets the opacity of the video in the key to

50%. The opacity can be adjusted by enabling the **View Thru Opac** data pad and turning the **View Thru Opacity** soft knob.



- 8 Enable the **Edge** data pad in the Edge Adjust/Crop Adjust pane (lower right; highlights blue).
- 9 Use the **Edge All, Top, Right, Left,** and **Bottom** soft knobs to pin the edges to the box; this allows very precise edge adjustment. Repeat for each edge.
Adjusting the 2D DPM Edge Pinning **Edge All** acts similar to a zoom.
- 10 Turn off the View Thru Enable if enabled.
- 11 Use the Pan and Scan features to reposition the shot clock if the camera is moved.

Adjust a 2D DPM Image with Edge Pinning Pan and Scan

To 'Pan' a cropped image means to move the crop sideways which simultaneously trims the value of the Left Crop and Right Crop. To 'Scan' a cropped image means to move the crop up and down, which simultaneously trims the Top Crop and Bottom Crop values.

- 1 Select the **Crop Edge** data pad.
- 2 Select the **Pan** or **Scan** button.
- 3 Use the **Crop Edge Pan** or **Crop Edge Scan** soft knob to pan or scan until the image is correctly displayed.

Note: Panning or scanning beyond (+ 16:9 for example) can have unexpected results, i.e. the picture may begin to stretch.

Set Edge Pinning with the Kayenne Multi-Function Module

Edge Pinning can be performed from the MFM (Multi-Function Module) of the Kayenne Control Panel, in the 2DPM (and identically the eDPM), EPin menu.

In this example of a shot clock box effect, used in a sporting event, a 2D DPM cropped box effect will be created and the edges of the box's video source pinned to the cropped edges. Then, using pan and scan, the video source will be repositioned inside the 2D DPM box effect without moving the box. This effect is very useful if the camera is bumped or moved so the switcher operator can reposition the video from the switcher.

- 1 Select a background source.
- 2 Select a keyer with the source for the box; in this case a camera pointed at a shot clock, and cut on the key over the background.
- 3 On the MFM, press **2DPM**, **Crop** and the **Dlg** button just below Crop.

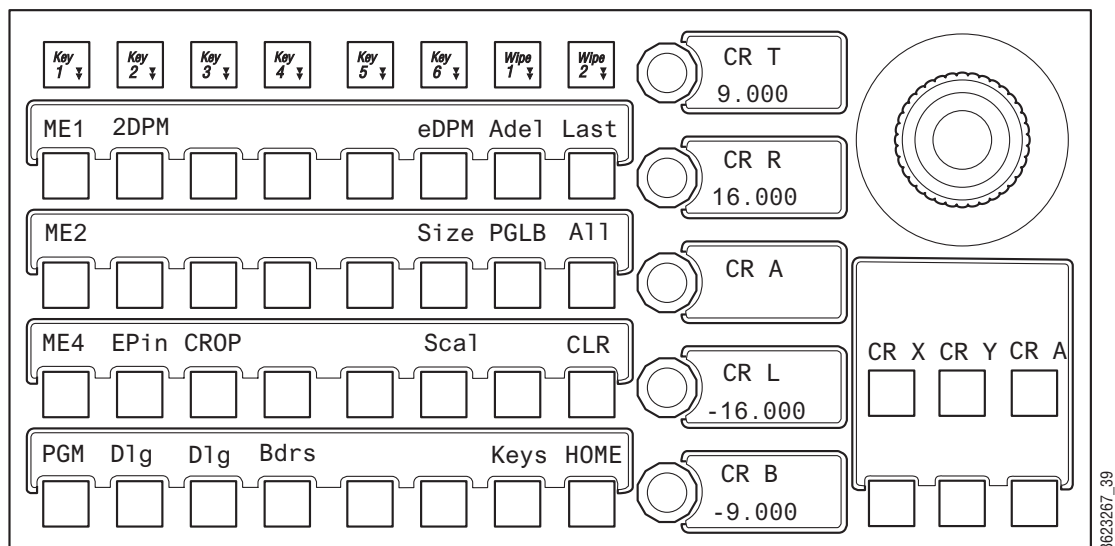

2D DPM (Edge Pinning) Crop—Multi-Function Module

- 4 Adjust the crop edges using the soft knobs to include the portion of the video you want in the box (key); the shot clock in this example.
- 5 Press the **Size** button and use the Size and X and Y positioning soft knobs to size and locate the cropped key over the background.
 - a On the MFM, press **Thru** to turn it on to see the location of the box effect over the background video. This will set the opacity of the video in the key to 50%. The opacity can be adjusted by turning the **Thru** soft knob.
- 6 Turn off the **Dlg** button.

- 7 On the MFM, press **EPin** and then the **Dlg** button directly below to turn on Edge Pinning.

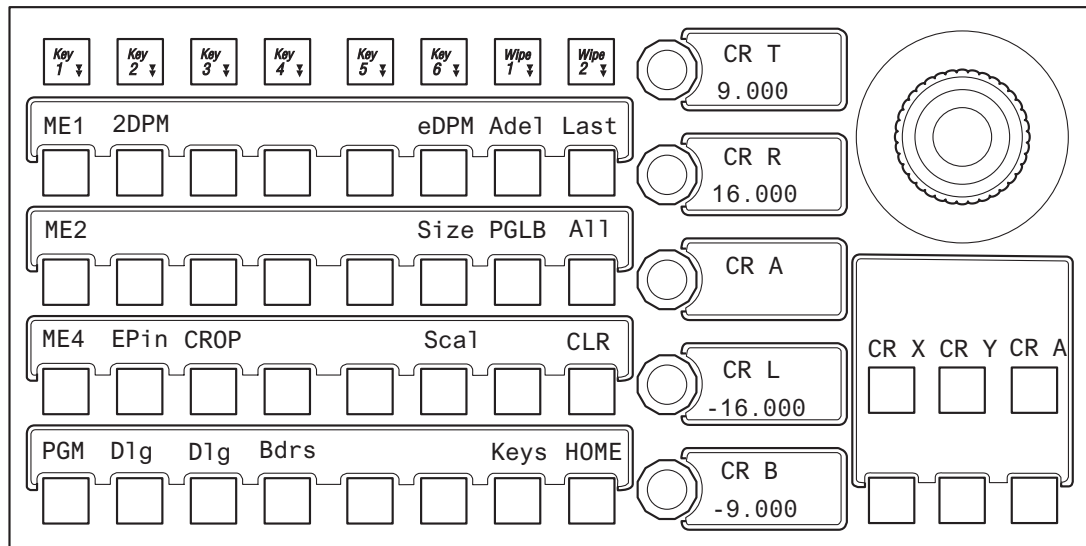

2D DPM (Edge Pinning) EPin Menu—Multi-Function Module

- 8 Press the **All**, **Top**, **Right**, **Left**, or **Bottom** button and use the soft knobs to pin the edges to the cropped box; this allows very precise edge adjustment.
Adjusting the 2D DPM with the Edge Pinning **All** soft knob acts similar to a zoom.
- 9 Turn off the View Thru Enable feature if enabled.
- 10 Use the Pan and Scan features to reposition the shot clock if the camera is moved.

Pan and Scan a 2D DPM Image with the Kayenne Multi-Function Module

To 'Pan' a cropped image means to move the crop sideways which simultaneously trims the value of the Left Crop and Right Crop. To 'Scan' a cropped image means to move the crop up and down, which simultaneously trims the Top Crop and Bottom Crop values.

- 1 Press the **Crop** button to turn it on.
- 2 Press the **All** button which toggles from All to Pan and Scan and choose **Pan** or **Scan**.
- 3 Use the **Pan** or **Scan** soft knob to pan or scan until the image is correctly placed in the cropped box.

Note: Panning or scanning beyond (+ 16:9 for example) can have unexpected results, i.e. the picture may begin to stretch.

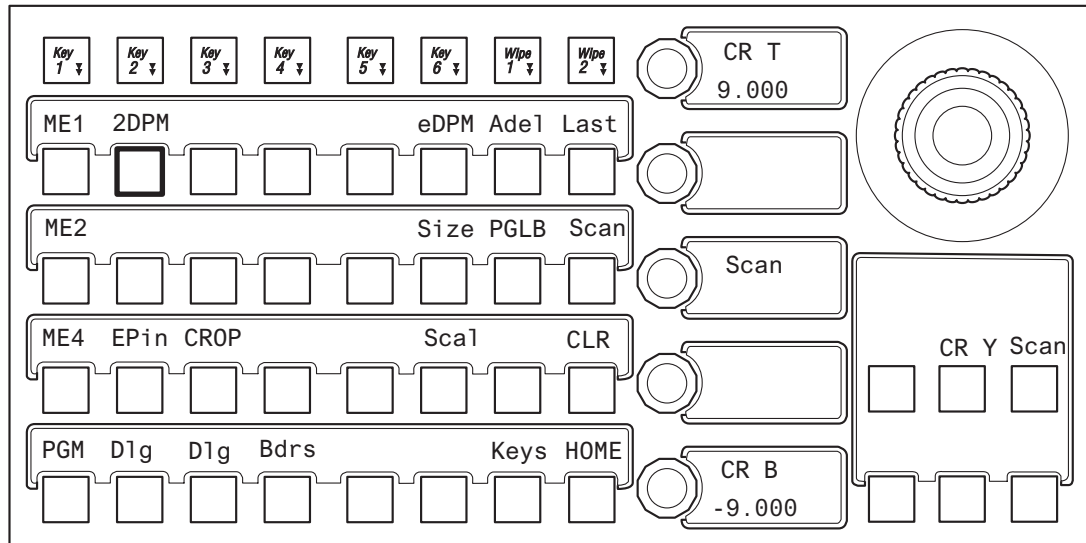

2D DPM (Edge Pinning) Pan/Scan Menus—Multi-Function Module

About Copy/Swap

Copy and Swap functions are available for M/Es, Keyers, and eDPM Channels. With Copy you can use the settings of one location at a different location in the system. This can be useful if, for example, an effect has been set up on ME 1 but it needs to be placed on-air using ME 2. You can quickly copy the ME 1 settings to ME 2 and place it on-air, freeing ME 1 for another purpose. Swap can be useful for multiple users, for example one TD prefers to use ME 2 for an effect where another TD prefers ME 3. M/Es can be swapped, and swapped back for each preference. When an M/E copy or swap is performed, all the M/E settings are transferred. This includes the current source selections and all keyer settings.

Copy Swap Menus

The Copy Swap menus are used for copying setups from one part of the system to another. For example, if a chroma key was set up on ME 1, but the operator needs the key while ME 1 is in use, he can copy the keyer's setup to ME 2 and place the chroma key on air there.

The set of menus for Copy and Swap use a common layout. The Copy Swap Mattes menu typifies the layout shared by the others. Choose a source in the From pane, choose a

destination in the To pane, and an action in the Operations pane. After performing a Copy or Swap, one level of Undo is available until another button on the menu is selected.

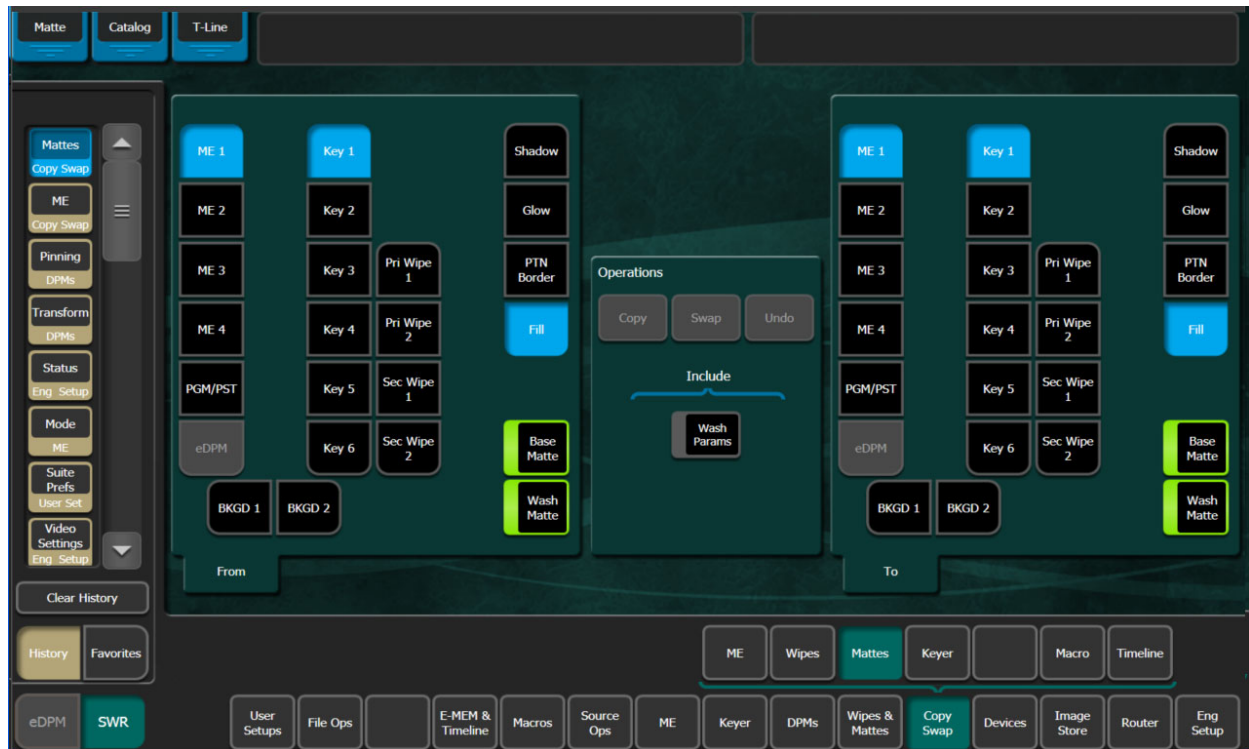

Copy Swap M/E Menu

The Copy Swap, ME menu is used to copy an entire setup from one M/E to another.



Copy Swap Wipes Menu

Wipe parameters can be copied from one wipe to another. This can be done on the same M/E (or eDPM) or from one M/E (or eDPM) to another.

Transition or complex wipes can be copied to Transition Wipes and Keyer Wipes can be copied to keyer wipes directly. Transition Wipes can be copied to Keyer wipes and vice versa.

Mattes can be included or excluded when copying wipes.

The Copy Swap, Wipes menu is used to copy wipe settings from one location to another.

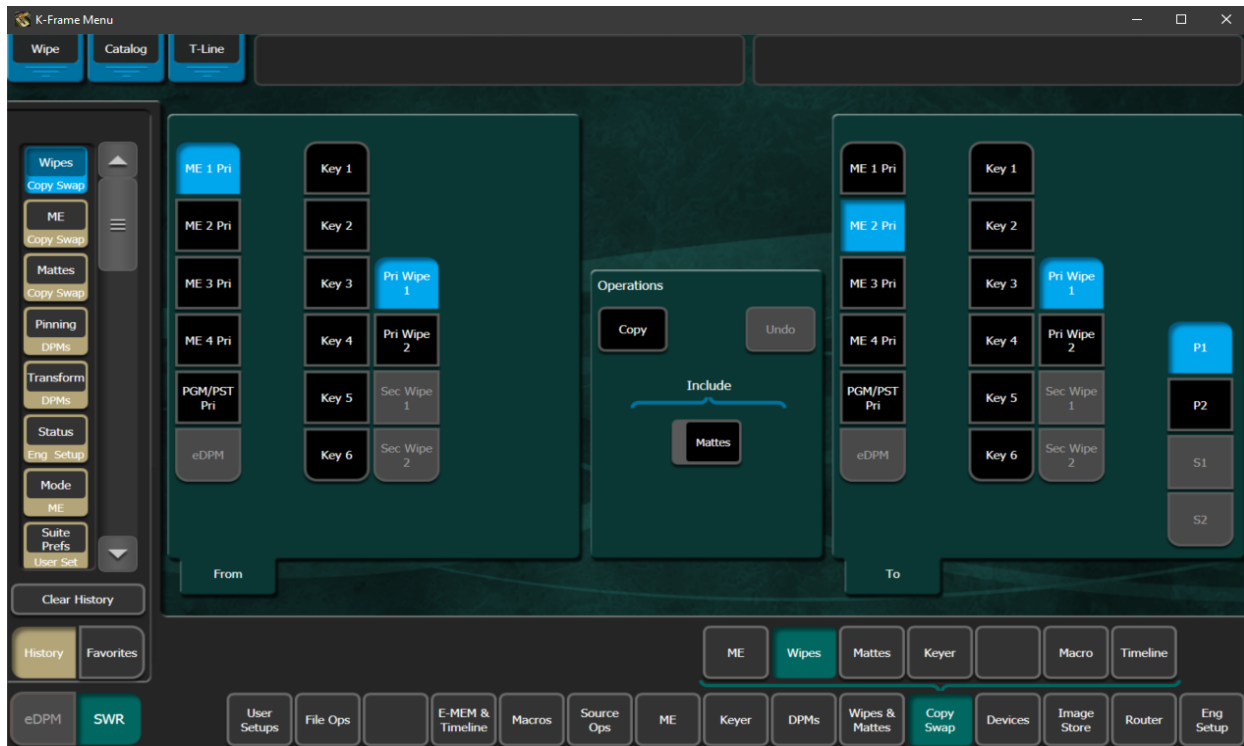

Wipe Generator Buttons in the To Pane

When one of the **P1**, **P2**, **S1** or **S2** Wipe Generator buttons is selected in the To pane, and **Copy** is selected, the Primary Wipe or Keyer Wipe selected in the To pane will have that complex generator copied to it. For example, if ME 2, Pri Wipe 1 is selected in the To pane, and **P2** is selected, when **Copy** is selected P2 replaces the ME 2, Primary Wipe 1-P1 wipe generator.

Copy One Transition Wipe to Another

- 1 Select the ME and Primary (**Pri Wipe 1** or **Pri Wipe 2**) or Secondary (**Sec Wipe 1** or **Sec Wipe 2**) wipe button in the From panel.
- 2 Turn on or off the **Mattes** button: On highlights green.
- 3 Select an ME and Primary Wipe button in the To pane.
- 4 Select the **Copy** button.

Copy a Key wipe to a Key wipe

- 1 Select the ME and Key Wipe (**Key 1 - Key 4**) button in the From panel.
- 2 Turn on or off the **Mattes** button: On highlights green.
- 3 Select an ME and Key Wipe button in the To pane, and if desired, choose a **Preset Patt**, **Inhibit Mask**, or **Force Mask** button to copy parameters from/to.

- 4 Select the **Copy** button.

Copying Between Transition and Key Wipes

If the keyer (to) is using a complex generator, you can choose which complex wipe will be the destination. The complex wipe generator will be copied and the keyer will be assigned to that generator. The generator is also assigned to the transition wipe (in most cases) and the generator for that transition wipe is also changed. If the Keyer is assigned to a keyer wipe, only a subset of the complex wipe parameters will be assigned.

Copy a Transition Wipe to a Keyer Wipe (and Vice Versa)

- 1 Select the ME and Primary (**Pri Wipe 1** or **Pri Wipe 2**) or Secondary (**Sec Wipe 1** or **Sec Wipe 2**) wipe button in the From panel.
- 2 Turn on or off the **Mattes** button: On highlights green.
- 3 Select an ME and Key Wipe (**Key 1 - Key 4**) button in the To pane, and if desired, choose a **Preset Pattern**, **Inhibit Mask**, or **Force Mask** button to copy parameters from/to.
- 4 Select the **Copy** button.

Copying from a Key Wipe to a Transition Wipe works the same, however Keyer wipe values will be copied to the Transition Wipe, not the Wipe Generator.

Copy an eDPM Wipe

eDPM Channels can be copied from one to another and between Transition and Key Wipes. eDPM Wipes are simple wipes, similar to the Key Wipes.

- 1 Select the **eDPM** button in the From or To pane.
- 2 Select a channel button (**CH 1 - CH 4**) with the parameters you wish to copy from or to, and if desired, choose a **Preset Patt**, **Inhibit Mask**, or **Force Mask** button to copy parameters from/to.
- 3 Select the **Copy** button.

Copy Swap Mattes Menu

Select **Copy Swap, Mattes** to access the Copy Swap Matte menu.

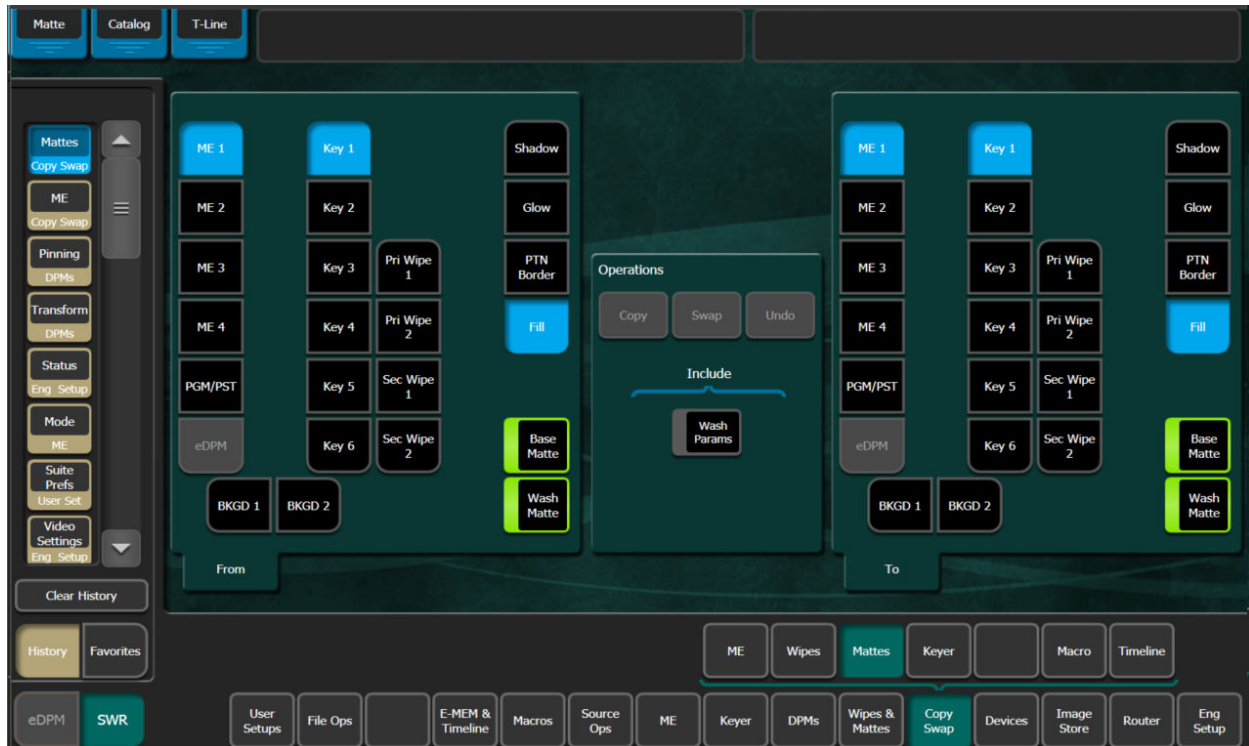

Some combinations of ME level, Key level, and matte generator level do not exist. For example, the destination matte is ME 1's Trans Wipe. Pst Ptn Border, and Fill are grayed out because they only apply to keyer mattes. Similarly, if Bkgd 1 had been chosen, no further delegation would be needed, so all of the keyer related selections would be grayed out.

Copy Swap Keyer Menu

Select **Copy Swap, Keyer** to access the Copy Swap Keyer menu.



The menu enables the copying and swapping of entire keyers, including the mapping of key cutter and key fill sources. It is a direct copy of what is currently in the chosen From keyer, including key type, key split condition, and all parameters describing the key's behavior.

Wipes, Mattes, iDPM, and 2DPM resources can be included/excluded using the buttons in the Include section of the Operations pane.

Copy Swap Macro Menu

The Copy Swap Macro menu is accessed by selecting Copy Swap, Macro.

Note: The functionality of this menu is duplicated in the Macros, Macro Ops menu for convenience.

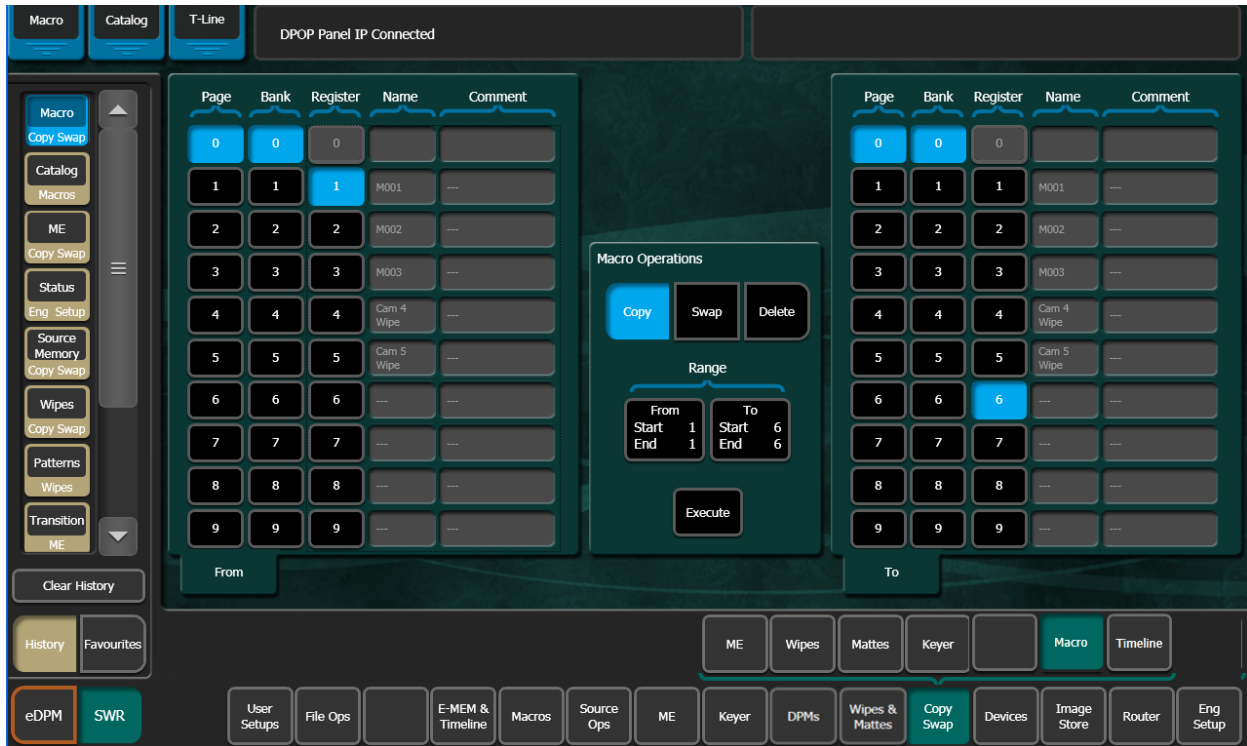

Macro register information can be moved from one register to another with this menu by selecting the registers in the From and To scrolling panes, then selecting the **Copy** or **Swap** buttons in the Macro Operations pane. The soft knobs and data pads on the upper right can be used to quickly select specific register numbers in each pane.

Copy Swap Timeline Menu

The Copy Swap Timeline menu is accessed by selecting **Copy Swap, Timeline**.

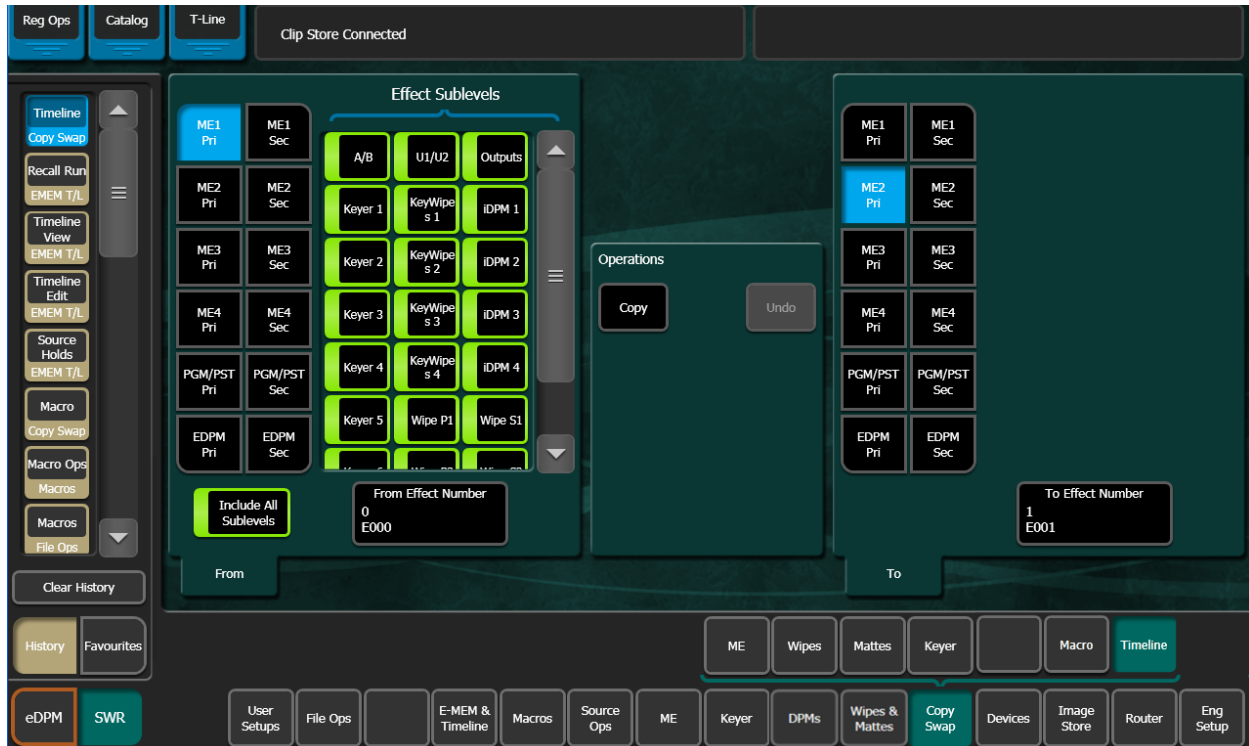

Complete E-MEM timelines containing multiple keyframes can be copied from one M/E to another M/E or the eDPM and vice versa. All sub-level information can be included using

the **Include All Sublevels** button or with this button off, sub-levels can be excluded from being copied by selecting the sub-level's enable button.

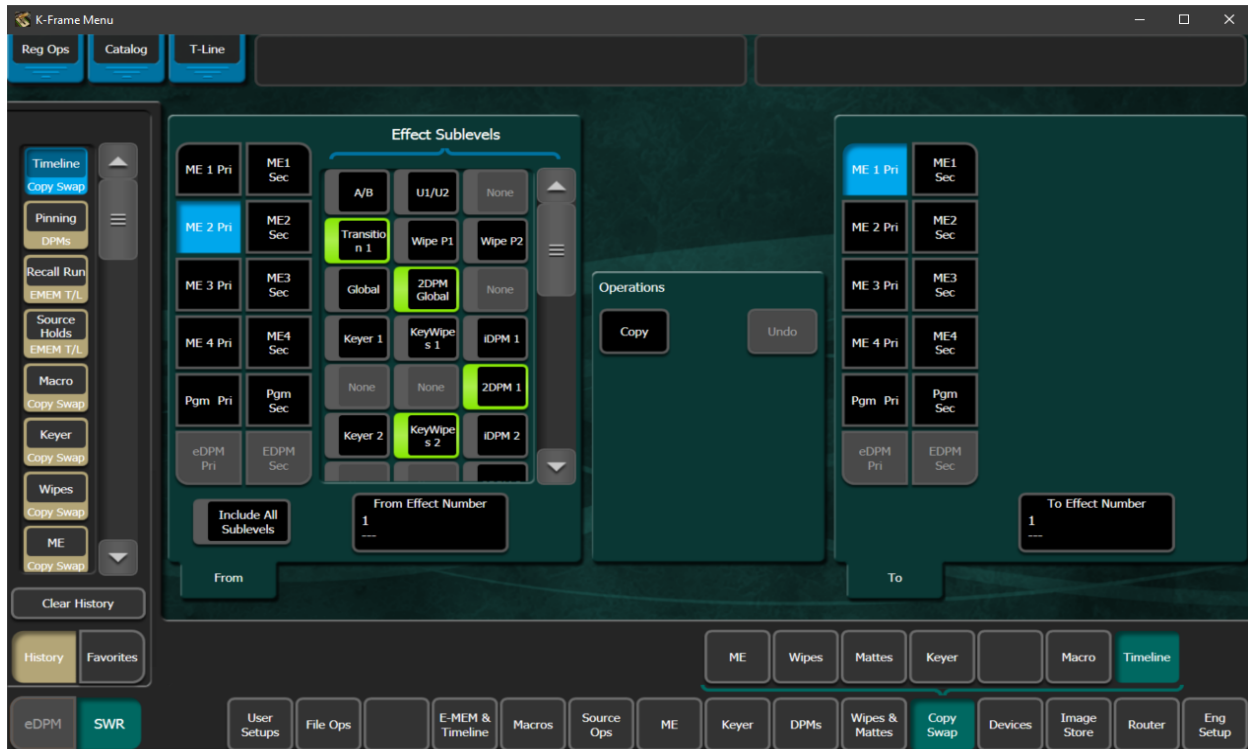

For example, ME2 Pri, Effect Register 1, has two keyers with iDPM parameter settings you want as part of an effect but you want to use those sub-levels with the parameter settings in Effect Register 0, on ME1 Pri. One way to accomplish this is to copy the Keyer/iDPM sub-level information of Effect ME2 Pri, Effect Register 1, to Register 0, on ME1 Pri.

Copy a Timeline with Copy/Swap

- 1 Select the **From Effect Number** data pad and enter the effect register number you want to copy 'from' in the Enter Source Register pop-up keypad.
- 2 Select the **To Effect Number** data pad and enter the effect register number you want to copy 'to' in the Enter Destination Register pop-up keypad.
- 3 With the **Include All Sublevels** button off, select the **Keyer 3**, **Keyer 4**, **iDPM 3** and **iDPM 4** sub-level buttons to turn them on (alternatively, you can turn on Include All sub-levels and individually select each sub-level to disable them).
- 4 Select the **Copy** button.
- 5 Recall the destination register to see the result (selecting the Copy button does not trigger a recall).

Result: Only Keyer 3, Keyer 4, iDPM 3, and iDPM 4 are copied to Register 0, on ME1 Pri. All other effect parameter settings are the same. Definable sub-levels can also be part of the copied register.

Copy/Swap with the Multi-Function Module

Use the Copy and Swap mode buttons in the Multi-Function Module to enter those modes and copy or swap ME, Keyer, and e-DPM settings between M/Es.

The Wipe, Matt, and DPM buttons can be turned on and off (default is on) in the MFM. With an ME and Keyer selected in either Copy or Swap menu delegations, the buttons will be available therefore you can include/exclude those parameters from the copy/swap operations.

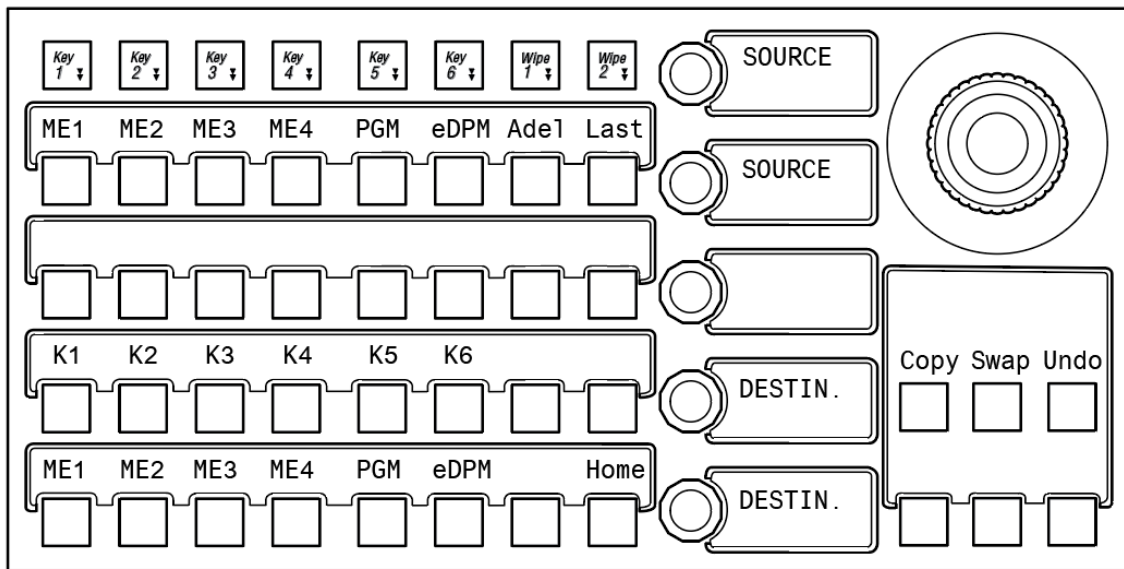

Copy Swap—Multi-Function Module

Copy an M/E

In Copy or Swap mode, the M/E/Keyer/e-DPM sources are selected from the source buttons in the top two button rows in the Multi-Function Module and destinations are selected in the bottom two rows.

Note: M/E Keyers can be copied/swapped with e-DPM channels and vice versa.

- 1 From the Home mode in the Multi-Function Module, press the **Copy** button.
- 2 Select the Source ME/Keyer.
- 3 Select the Destination ME/Keyer.
- 4 Press the **Copy** button (below the joystick).

Swap M/Es

- 1 From the Home mode in the Multi-Function Module, press the Swap button.
- 2 Select the Source ME.
- 3 Select the Destination ME.

- 4 Press the Swap button (below the joystick).

Copy a Keyer

- 1 From the Home mode in the Multi-Function Module, press the **Copy** button.
- 2 Select the Source ME.
- 3 Select a Source Keyer (**K1-K6**) (Keyers can also be copied to e-DPM Channels and vice versa).
- 4 Select the Destination ME.
- 5 Select a Destination Keyer (e-DPM Channel).
- 6 Press the **Copy** button (below the joystick).

To Swap Keys:

- 1 From the Home mode in the Multi-Function Module, press the **Swap** button.
- 2 Select the Source ME.
- 3 Select the Destination ME.
- 4 Select a Destination Keyer (Keyers can also be swapped with e-DPM Channels and vice versa, see [Swap e-DPM Channels](#), on page 333).
- 5 Press the **Swap** button (below the joystick).

Copy e-DPMs

e-DPM Channels can also be copied to Keyers and vice versa.

- 1 From the Home mode in the Multi-Function Module, press the Copy button.
- 2 Press the Source eDPM button, K1-K4 buttons of the top row are now assigned as e-DPM channels Ch1-Ch4 (the button legends remain K1-K4).
- 3 Select a Source e-DPM channel.
- 4 Select the Destination eDPM button (K1-K4 destination button LED labels change to Ch1-Ch4).
- 5 Select a Destination e-DPM channel.
- 6 Press the Copy button (below the joystick).

Swap e-DPM Channels

e-DPM Channels can swapped with Keyers and vice versa.

- 1 From the Home mode in the Multi-Function Module, press the Swap button.
- 2 Press the Source eDPM button, K1-K4 buttons of the top row are now assigned as e-DPM channels Ch1-Ch4, however the button legends remain K1-K4.
- 3 Select a Source e-DPM channel.
- 4 Press the Destination eDPM button, K1-K4 destination button LED labels change to Ch1-Ch4.
- 5 Select a Destination e-DPM channel.
- 6 Press the Swap button (below the joystick).

About the Undo Button

The Undo button (below the joystick) reverses a copy or swap operation that has been performed. Only one level of undo is supported. For example, pressing Undo a second times does not return the M/Es to their previous states before the first Undo was performed.

About Image Store Options

There are two Image Store Options, the basic option for Stills and an enhancement that also supports movies. The Image Store hardware board is required, and cache memory must be licensed. Image Store supports 4K.

Supported Image Formats

Stills

- .GIF
- .JPEG
- .TIFF
- .BMP
- .
- .PNG (including 3840x2160)
- Kalypso (gvi, gva)
- Kayanne/Karrera/GV Korona (.kif)

Movies (Including 4K)

- .AVI (Video/Key)
- .MOV (Video/Key)
- .MP4 (Video)
- .PNG (sequences—load a series of still images with a single Image Store ID)

Image Store Memory

Image Store cache is licensed with either of memory. The memory is available for suite allocation in units of 1GB. Memory must be released from one Suite to be acquired by another suite's cache.

Each unit of Image Store memory provides cache memory in frames; for example a 1GB unit is enough memory for approximately 90 frames of 1080i. See [Image Store Movie Storage Capacity](#), on page 346 for memory requirements for Movies.

Image Store Images Menus

The four Image Store Images menus are selected using the Stills, Movies, Movie Record, and Movie Edit tabs. The three Movies menu tabs are grayed out if the option is not licensed.

- The scrolling window on the left displays the items in the cache.

- The buttons on the right represent the Image Store channels. Channels acquired by the current suite are active. The selected channel has a blue box when selected, which turns red when that channel is on-air.
- The Scroll Image List data pad and soft knob on the right can be used to select and/or load images and movies.
- The Cache Remaining data field indicates the unused portion of the currently allocated cache memory, in frames.
- The Number of Images data field displays the number of stills or movies currently loaded into the allocated cache memory.

Image Store Quick Tabs

There are three Quick Tabs (top-left) in the Image Store menus: Src Ops (Source Operations), Catalog (Macro Catalog), and T-Line (Timeline Edit for the Master E-MEM).



Image Store Stills

With Image Store, still images are captured as Video/key or video-only and can be used as part of an effect or selected and loaded to output from the Menu or Control Panel.

Note: Locally, still images are stored as .eif file format.

Imported Still File Formats

See [Supported Image Formats](#), on page 334.

Operating the Menu Panel

From the Image Store menu, you can perform the following with still images:

- Still capture and playback,
- File operations (Library), and
- Backup and restore.

Modifying/Adding Image Descriptions

Image descriptions can be modified or added by selecting the Change Description button (top of scrolling image list) and entering the name in the pop-up keyboard. The name will appear in the image's icon when Enter is pressed

Configure Image Store Resources

Image Store resources can be allocated between the two suites. By default all resources are assigned to Suite 1. To assign Image Store resources to Suite 2, do the following:

- 1 Select **Eng Setups, Eng Login** and log into Suite 1.
- 2 Release one or more Image Store channels.
- 3 Login to Suite 2 and acquire one or more Image Store channels.
- 4 With an Image Store channel selected, allocate some Image Store memory to that suite (see below). This will reduce the memory available in the other suite.

Release/Acquire Image Store Memory Between Suites

Image Store memory must be allocated to any suite that will perform Image Store operations.

In the Eng Setup, Acquire Resources menu, release and/or acquire available Image Store memory:

- 1 Select an allocated Image Store Logical Resource in the Logical Resources pane on the top left of the Acquire Resources menu.

- 2 Release Units of Memory from the current suite by moving them from **Units** to **Available** using the **Right Arrow** button in the *Image Store Memory* acquisition group.

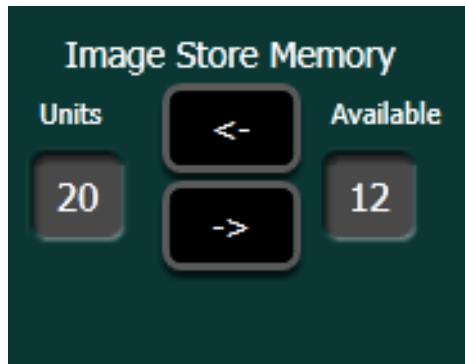

- 3 Login to the other suite in the Eng Setup, Eng Login menu (see the *Kayenne/Karrera/Korona Installation & Service Manual*).
- 4 Returning to the Acquire Resources menu, acquire available memory using the **Left Arrow** button.

Map Image Store Input Delegates

Delegate Image Store inputs to the aux bus delegates on the Local Aux Module:

Note: Alternatively, you can select Image Store input sources from the Image Store menu.

1 Select **User Setups, Panel Prefs, Aux Delegate Mapping**.

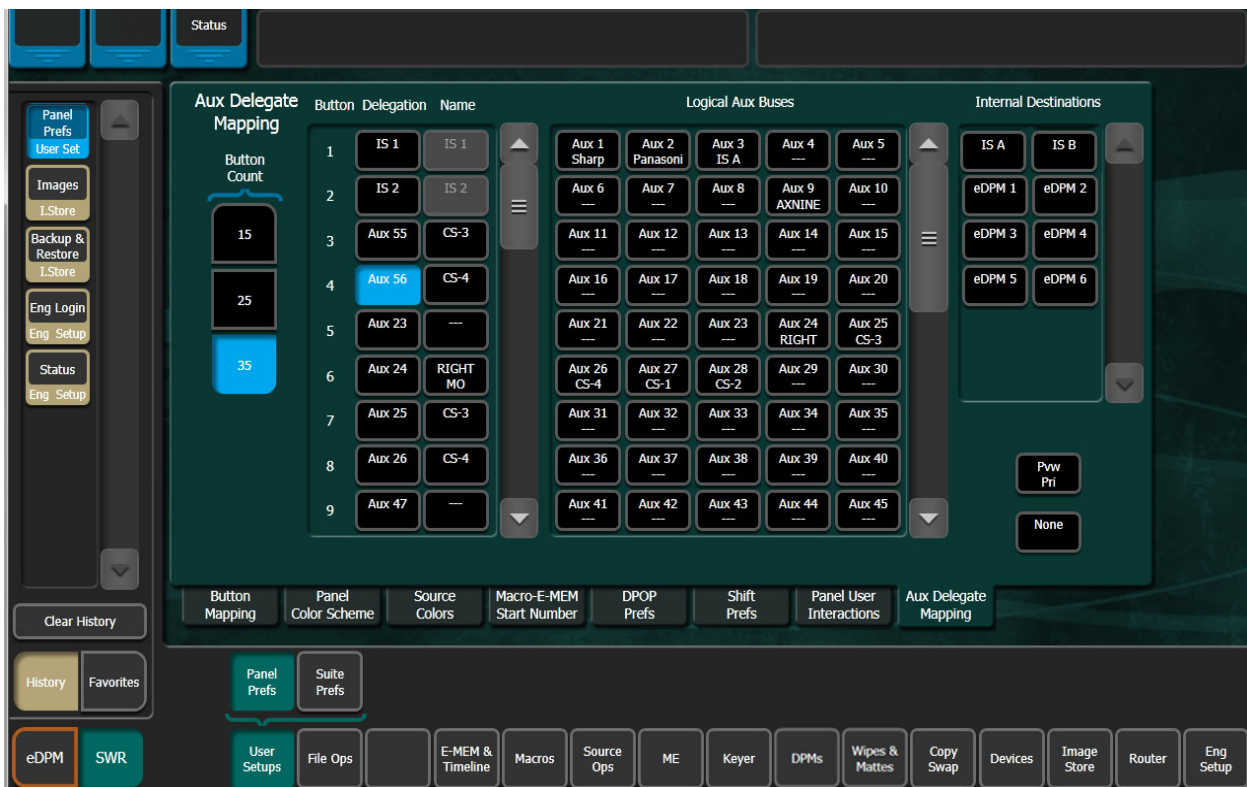

- 2 Select a Local Aux Module button in the Button/Delegation scrolling list.
- 3 Select an Image Store input (**IS A-IS B**) in the Internal Destination scrolling list.

Capture a Still from Input Video

Image Store channels use the “Grab” function to capture a still (in RAM) and the “Keep” function to load that still into cache. A “grabbed” still can be replaced with another Grab.

Stills can be captured as a video/key pair or video only (when replayed, video only stills will have a full raster white key applied).

- 1 Do one of the following:
 - Setup the input sources on the Local Aux Module (see [Map Image Store Input Delegates](#), on page 337), or
 - In the Image Store, Images, Stills menu:
 - a Select the **Capture Still** button to turn it on.
 - b Select the **Input Source** data pad.
 - c Select the input from the Inputs scrolling list.
- 2 Select **Image Store, Images** menu tab.
- 3 Select an Image Store channel **1-**.

- 4 Optionally, select the **Key** button in the Record Elements group to capture a video-only still.
- 5 Select the Input **Source data** pad and select the input source for the selected channel (or select the desired source from the Aux panel).
- 6 Select the **Show E-E** button. The Show E-E button becomes the **Grab** button.
- 7 Select the **Grab** button; the captured still is displayed in the selected output (the Grab button returns to Show E-E).

Note: The Show E-E/Grab buttons can be pressed repeatedly until the desired still is captured before selecting the Keep button.

- 8 With Show E-E enabled, select the **Keep** button to place the captured still into cache.
- 9 A keypad is displayed with a **Name** button.

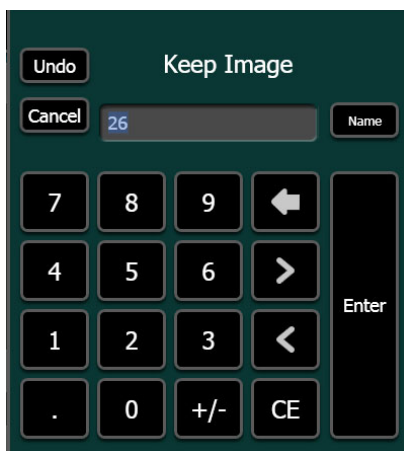

- 10 Choose one of the following three options:
 - a Select **Enter** to accept the auto-generated Image ID,
 - b Type your own Image ID (1-8999) and select **Enter**, or

CAUTION: Entering an existing Image ID and selecting the Enter button will overwrite the existing image associated with that ID.

- c Select the **Name** button and type an Image Description in the pop-up keyboard, select **Enter**, and select **Enter** again in the keypad.

The captured still will be placed in cache and displayed in the scrolling image list in the Still menu.

Create a Split Key for a Still Store Still

A “split key” is when the key source is different than that of the video source. When an Image Store video/key still is captured, in the Image Store, Images, Stills menu, the video and key signals are from the same source. Split Key allows you to change the key signal source.

Advanced Operations

Create an Image Store Still with another Video (Not Key)

- 1 Navigate to the Source Ops, Image Store menu by selecting the Src Ops Quick Tab or the Source Ops, Image Store menu buttons.



- 2 Select the Split Key button to turn it on.
- 3 Select the **IS Input B** button (top-right, center of menu) to select it, then select a source from either the Logical or Fixed sources scrolling list to change the key signal source.

Create an Image Store Still with another Video (Not Key)

Image Store channels capture a video/key still as the default. A still can also be captured using another video for a video/video still by changing the key to video in the Source Ops, Image Store menu.

- 1 Navigate to the Source Ops, Image Store menu by selecting the Src Ops Quick Tab from the Image Store, Images, Stills menu or the Source Ops, Image Store menu buttons.



- 2 Turn off the **Input B is Key** button.
The **IS Input B** is now a second video.
- 3 Select the **IS Input B** button to select it, then select a source from either the Logical or Fixed sources scrolling list to change the video signal source.

Still Playback from the Menu

Still playback is performed in the Image Store, Images, Stills menu tab. Stills are loaded directly to Program or they can be modified without being loaded.

Load stills to an Image Store channel output in one of the following ways:

- With the **Auto Load** button turned on, select a channel to select it then select a still in the scrolling list to load the still or turn the **Scroll Image List** soft knob to load stills sequentially.
- For direct keypad entry, type <Image ID #> + **dot** (.) + <Channel #> in the Image ID keypad and select **Enter** to load the image ID.

Example: typing 123.3 then selecting Enter loads Image ID 123 on output channel 3.

Modify a Still

To find and modify stills without loading them to a channel:

- 1 Toggle the **Auto Load** button to off.
- 2 Select the **Scroll Image List** soft knob button data pad to display the Enter an Image ID to go to keypad.
- 3 Enter an image number, then select **Enter**.

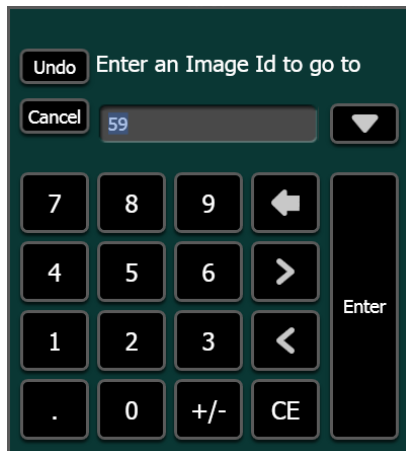

Set Freeze Mode

In interlaced formats, Freeze Mode can be set to Frame, Field 1, or Field 2. This is very useful if you need to eliminate motion flicker or artifacts from an interlaced still.

- 1 Select a still from the scrolling list.
- 2 Toggle the **Capture Still** button off.
- 3 Select the **Freeze Mode** button.
- 4 Viewing the still on a monitor, select the **Frame/Field 1/Field 2** buttons to change the mode for the best result.
- 5 Select the **Confirm** button.

Kayenne Image Store Device Control

Stills can be controlled from both the DCM (Device Control Module) and the System Bar on the Control Panel.

The DCM (Device Control Module), allows you to scroll through and select an Image Store channel (1-10), select a still for the channel, and load that still.

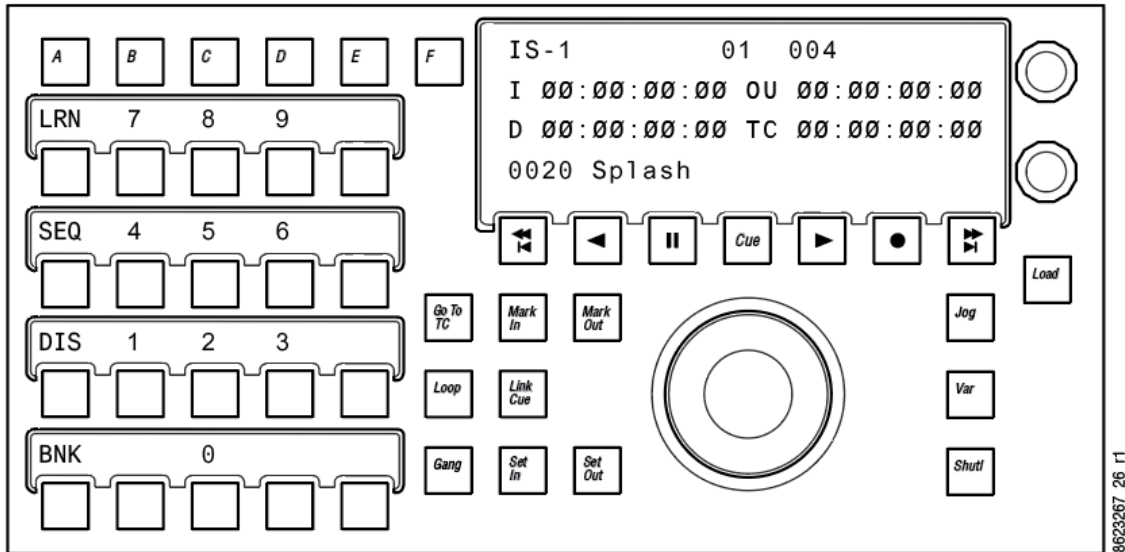

Image Store Device Control—Device Control Module

- 1 Use the soft knob in the upper right of the DCM to scroll through the devices until the desired Image Store channel is seen in the display.
- 2 Use the bottom-most soft knob to scroll through the stills until the desired Image ID is displayed.
- 3 Press the **Load** button (right).

The still is loaded to the Image Store output channel.

Kayenne System Bar Control

Image Store channel stills can be selected and loaded from the System Bar Module.

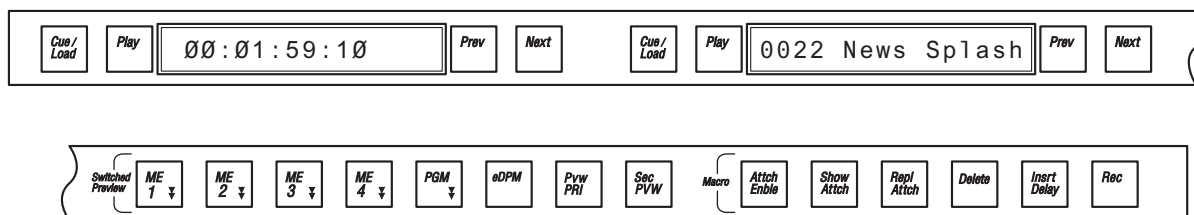

Image Store Device Control—System Bar

- 1 Press and hold down a source select button that has an Image Store channel attached.
- 2 Press the **PREV** and **NEXT** buttons together in the desired Device Control Group (alternatively, you can press and hold down the **PREV** and **NEXT** buttons and then press a source button).
- 3 Press the **Prev/Next** buttons for that Device Control Group until the desired still is displayed.

- 4 Press the **Cue/Load** button to load the still.

Image Store Movies Option

Image Store movies are recorded to and played from cache memory. The Image Store option is completely different from ClipStore clips, which are recorded to, and played from, an external server.

When enabled, the Image Store Movies option provides:

- Movie recording
- Movie playback, including loop and bounce
- Mark thumbnail image
- Mark-in and mark-out cue points
- Trim start and end points
- Cut and Join operations
- Build and Edit operations
- Import and conversion of video files
- Import and conversion of still sequences into a movie file
- Export of movies in one standard file format
- Timeline Events for movies

The Image Store Backup & Restore Menu, used for cache management, also supports Image Store movies.

The Image Store Library Menu used with Image Store stills and ClipStore material is also used for movie file management.

Supported Image Formats

See [Supported Image Formats](#), on page 334.

GV K-Frame XP Image Store Movie Lengths

EIF Files

Movies recorded with the GV K-Frame XP Image Store that are within the Maximum EIF Frames will be generated in the .EIF file format. .EIF files are compatible with other K-Frame systems (GV K-Frame X, K-Frame Standard, Compact, etc.).

EIF Maximum ImageStore Movie Lengths

Line Rate	Frequency (Hz)	Max. Frames	Time (m:s:f)
720p	59.94/60	1136	00:18:56
720p	50	1136	00:22:35
1080i	29.97/30	505	00:16:25
1080i	25	505	00:20:04
1080p	29.97/30	505	00:16:25

EIF Maximum ImageStore Movie Lengths

Line Rate	Frequency (Hz)	Max. Frames	Time (m:s:f)
1080p	25	505	00:20:04
1080p	23.98/24	505	00:21:01
1080p-A	59.94/60	505	00:08:25
1080p-A	50	505	00:10:04
1080p-B	59.94/60	505	00:08:25
1080p-B	50	505	00:10:04

ISF Files

Movies recorded with Image Store that are larger than the maximums, including all recorded in 2160p, will be generated in the .ISF file format. The .ISF format is supported by GV K-Frame XP systems only.

ISF Maximum Image Store Movie Lengths

Line Rate	Frequency (Hz)	Max. Frames	Time (m:s:f)
720p	59.94/60	32380	08:59:39
720p	50	32380	10:47:30
1080i	29.97/30	16124	08:57:14
1080i	25	16124	10:44:24
1080p	29.97/30	16124	08:57:14
1080p	25	16124	10:44:24
1080p	23.98/24	16124	11:11:20
1080p-A	59.94/60	16124	04:28:44
1080p-A	50	16124	05:22:24
1080p-B	59.94/60	16124	04:28:44
1080p-B	50	16124	05:22:24
2160p	29.97/30	3932	02:11:01
2160p	25	3932	02:37:07
2160p	23.98/24	3932	02:43:20
2160p	59.94/60	3932	01:05:31
2160p	50	3932	01:18:32

Note: Image Store movies longer than the maximum save-to-disk file lengths can be recorded and played but not saved. Movies can be as long as the available cash.

Image Store Movie Storage Capacity

Image Store maximum storage capacity of movies for 32GB, 64GB, or 128GB licensed memory.

32GB Maximum Image Store Capacity

Line Rate	Frequency (Hz)	Max. Frames	Time (m:s:f)
720p	59.94/60	8155	02:15:54
720p	50	8155	02:43:04
1080i	29.97/30	4059	02:15:09
1080i	25	4059	02:42:09
1080p	29.97/30	4059	02:15:09
1080p	25	4059	02:42:09
1080p	23.98/24	4059	02:49:03
1080p-A	59.94/60	4059	01:07:39
1080p-A	50	4059	01:21:09
1080p-B	59.94/60	4059	01:07:39
1080p-B	50	4059	01:21:09
2160p	29.97/30	987	00:32:27
2160p	25	987	00:39:11
2160p	23.98/24	987	00:41:03
2160p	59.94/60	987	00:16:27
2160p	50	987	00:19:36

64GB Maximum Image Store Capacity

Line Rate	Frequency (Hz)	Max. Frames	Time (m:s:f)
720p	59.94/60	16315	04:31:55
720p	50	16315	05:26:15
1080i	29.97/30	8123	04:30:22
1080i	25	8123	05:24:33
1080p	29.97/30	8123	04:30:22
1080p	25	8123	05:24:23
1080p	23.98/24	8123	05:38:10
1080p-A	59.94/60	8123	02:15:22
1080p-A	50	8123	02:42:23
1080p-B	59.94/60	8123	02:15:22
1080p-B	50	8123	02:42:23
2160p	29.97/30	1979	01:05:29

64GB Maximum Image Store Capacity

Line Rate	Frequency (Hz)	Max. Frames	Time (m:s:f)
2160p	25	1979	01:19:03
2160p	23.98/24	1979	01:22:10
2160p	59.94/60	1979	00:32:59
2160p	50	1979	00:39:28

128GB Maximum Image Store Capacity

Line Rate	Frequency (Hz)	Max. Frames	Time (m:s:f)
720p	59.94/60	32380	08:59:39
720p	50	32380	10:47:30
1080i	29.97/30	16124	08:57:14
1080i	25	16124	10:44:24
1080p	29.97/30	16124	08:57:14
1080p	25	16124	10:44:24
1080p	23.98/24	16124	11:11:20
1080p-A	59.94/60	16124	04:28:44
1080p-A	50	16124	05:22:24
1080p-B	59.94/60	16124	04:28:44
1080p-B	50	16124	05:22:24
2160p	29.97/30	3932	02:11:01
2160p	25	3932	02:37:07
2160p	23.98/24	3932	02:43:20
2160p	59.94/60	3932	01:05:31
2160p	50	3932	01:18:32

Image Store Movies Feature Configuration

Standard, Compact, S-series, and GV K-Frame X have ten channels of Image Store, V-series has eight.

Prerequisites

The Image Store Movies feature requires:

- the optional Image Store hardware board installed,
- an Image Store Movies license code, and
- activation of Image Store Cache Size (16GB, 32GB, or 64GB).

License the Image Store Option

To enable the Image Store Movies option:

- 1 Go to the Eng Setup/Install Options menu.
- 2 Click on the New Auth Code for Perm data field.
- 3 Enter the authorization license code.
- 4 Select Replace or Install. The authorization code will be added.

Note: A minimum of 16GB of Image Store Cache must be enabled.

- 5 If necessary, using the procedure above, enable your Image Store Cache size. A minimum of 32GB is recommended to maximize your movie storage time.

Movie Playback from the Menu Application

Movies that have been loaded to Image Stores can be cued and played from any of the Image Store Images tabs (Stills, Movies, Movie Record, Movie Edit). When an Image Store channel with a loaded movie is selected, the Cue to Start, Play Reverse, Stop, Play Forward, and Cue to End buttons are activated, and the progress bar above them indicates the current location of the movie.

Movie Cue and Playback Controls

Once a movie is loaded and selected for control, the Cue to Start, Play Reverse, Stop, Play Forward, and Cue to End buttons are available. Additional menu playback controls include:

- **Loop**—Sets the movie to run continuously, jumping from its last frame to the first.
- **Bounce**—Sets the movie to run to its end, reverse playback to its beginning, then play forward, and repeat (only available when Loop is active).
- **Auto Start**—Sets the movie to play when taken On-Air.
- **KF Trigs**— Enables EMEM KF triggering (see [E-MEM Keyframe Triggers for Image Store Movies](#), on page 349).
- **Timecode**—Opens a keypad allowing entry of a time code value to cue the movie to. This control is also available on the Movie Record and Movie Edit menus.
- **Mark In**—Sets the current cued location of the movie as its playback start point.
- **Mark Out**— Sets the current location of the movie as its playback end point.
- **Cue to Begin**— Cues to the Mark In point, if set.
- **Var Play Speed**— When On, plays the clip at the percentage speed displayed on the right. Clicking on the percentage allows entry of the desired speed. Supported range is from 0.1% to 5000%.
- **Jog Movie**—The knob on the Menu Panel can be used to jog the movie forwards and backwards. This control is also available on the Movie Record and Movie Edit menus.

Movie Playback with the System Bar

Selecting an Image Store channel on the PVW bus activates the System Bar controls, which will display the currently loaded item. The System Bar Cue/Load, Play, Previous, and Next buttons allow the loading, cuing and playback of movies on that Image Store channel.

If a Image Store channel is selected on the PGM bus, holding down that source select button activates the System Bar for control of that Image Store channel.

E-MEM Keyframe Triggers for Image Store Movies

Movie replay can be controlled with E-MEMs. Keyframe triggers that are E-MEMable are:

- Load (Movie),
- Loop (Enable/Disable),
- Bounce (when Loop is On)
- Cue (to in), and

All Motion Controls:

- Movie Start,
- Reverse Play,
- Stop,
- Play,
- Movie End, and
- Variable Speed Play (Var Play Speed button).

The selected Image Store channel has a blue outline. If that Image Store channel is On-Air, it has a red outline. The Stills, Movies, and Movie Record menus also allow direct loading of movies and stills to acquired Image Store channels.

Previously recorded movies and captured clips appear in the pane on the left. Selecting the **Include Stills** or the **Include Movies** button will also show thumbnails of those items in that pane.

Load a Movie

Movies are loaded to Image Store channels the same way as stills.

- 1 Select to enable an Image Store channel to control.
- 2 Select **Auto Load** so it is illuminated.
- 3 Select a movie in the pane on the left. It will load to the selected Image Store channel.

Create an E-MEM Keyframe Trigger

- 1 In the Devices menu, select the **Clear All Events** button, ensuring unwanted keyframe triggers are not included in your E-MEM.
- 2 In the Image Store, Images, Movies tab in the menu, select an Image Store channel (or pair), select a movie, then select the **Load** button.
- 3 Select the **KF Trigs** button. The motion control buttons become jeweled toggle buttons, and **Loop Enable**, **Loop Disable** and **Cue** buttons are displayed.
- 4 Select the controls that you want as part of the keyframe trigger ([Movie Cue and Playback Controls](#), on page 348).
- 5 Learn the keyframe trigger to an E-MEM on the Control Panel ([Learning E-MEM Registers from the Control Panel](#), on page 110) or from the EMEM & Timeline, Recall Run menu.

Create an E-MEM Trigger Cue

A cue point, different from a Mark In point, can be defined with a KF Trigger. An example of this application would be to have an E-MEM recall a movie and cue it at midpoint, play the movie, and have it loop from Mark In and Mark Out points after the cue point.

- 1 With KF Trigger enabled, select the Cue button. A data pad will appear next to the button.
- 2 Select the data pad. A numeric keypad will open, allowing you to enter a movie frame location. The default value will be the current Mark In location.
- 3 Select Enter on the keypad. The cue value is stored and inserted as part of the keyframe.

Note: Turning Cue off and back on will re-enter the current Mark In location for that Cue.

Record a Movie

Movies are recorded by selecting an Image Store channel, selecting a video source, specifying any recording options, making the recording, inspecting the recording (optional), and then committing that recording to the cache with the Keep button.

- 1 Select an Image Store channel for recording.
- 2 Select an Input then choose the video source to be recorded.
- 3 Select the **Show E-E** button. The current movie or clip on that Image Store channel, if loaded, will be unloaded in preparation for recording. The incoming video will be displayed on the output of that Image Store channel. The Show E-E button legend changes to **Record**.
- 4 Define the options you wish to apply to the recording:
 - **Video & Key** or **Video only**.
 - Record Time (optional duration of the recording).
- 5 Select the Record mode button to initiate the recording, and then either press Record again to stop the recording, or let the movie record until the Record Time duration is reached.
- 6 You will now be able to cue and play the candidate recording to see if it meets your requirements.

Note: The movie recording is not saved to cache. If upon inspection the recording isn't correct, you can select the **Show E-E** button again to discard that recording and prepare to make another.

- 7 When you are satisfied with the recording, select **Keep** to save it to cache. A key pad opens with a default new image number. You can use that number, or specify another, and select **Enter**.

Note: Specifying the number of an existing Image Store item will overwrite that existing item with the new recording.

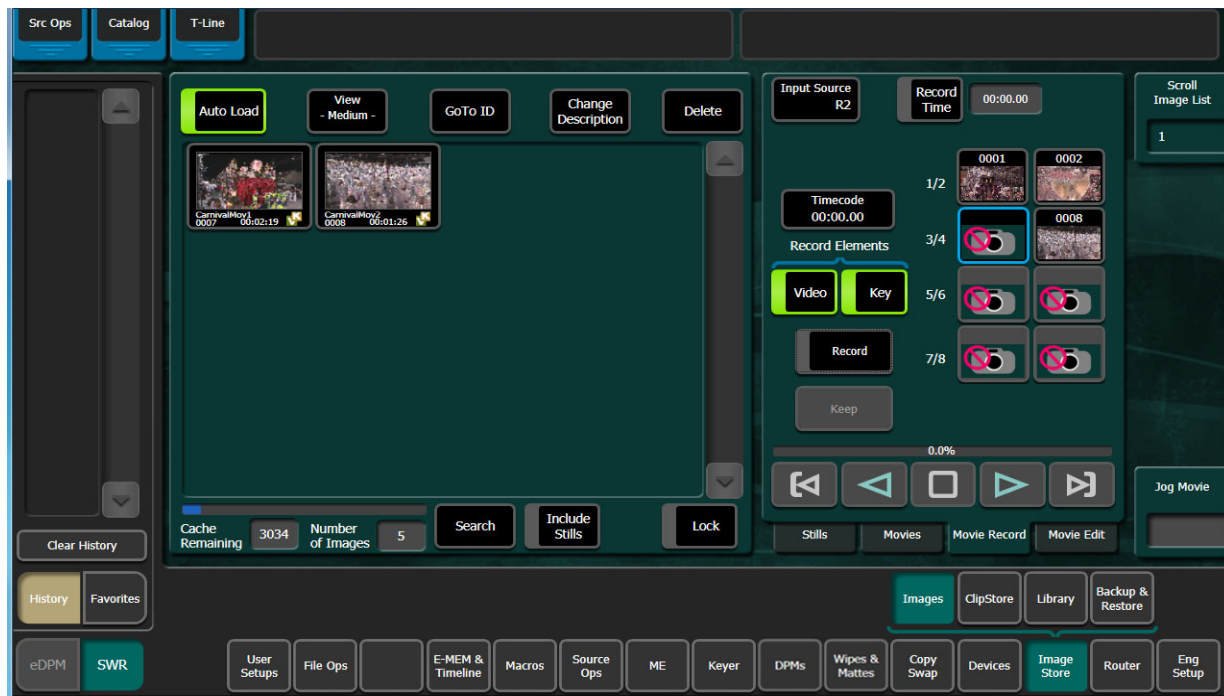

- 8 That movie will now be loaded in that Image Store channel, and will also appear in the pane on the left. The movie can immediately be cued and played if desired.

Name a Movie

A movie can be named after it has been recorded.

- 1 Go to the Movie Record menu.
- 2 Select the Change Description button.
- 3 Enter a name for the movie.

Select a Thumbnail

When a movie is recorded a default thumbnail is created for that movie. If you wish to change the thumbnail, do the following.

- 1 Go to the Movie Edit menu.
- 2 Cue the movie to the desired thumbnail frame.

- 3 Select **Mark Thumbnail**. The thumbnail will change and the timecode of that location will be displayed.

Trim a Movie

The Cut Edit, Trim mode allows you to trim unwanted video from the start and/or end of a movie. Doing so deletes that video, conserves space in the cache, and ensures that unwanted material will not be aired.

- 1 In the Image Store, Images, Movie Edit menu, select the Image Store, Images, Movie Edit menu.
- 2 Select an Image Store channel with the movie to be trimmed.
- 3 Cue the movie to the first desired frame.
- 4 Select **Mark In** to set that in point. The timecode of that location will be displayed.
- 5 Cue the movie to the last desired frame.
- 6 Select **Mark Out** to set that out point.
- 7 You can use the **GoTo In** and **GoTo Out** buttons to cue the movie, and play it to ensure those points are correct.
- 8 When satisfied, select **Trim Movie**. A prompt will appear indicating the operation is not reversible. Select **Yes**. The extra video will be discarded.

Split an Image Store Movie

The Cut Edit, Split Movie mode allows the operator to cut a movie in Image Store Cache into two new movies; the original movie is not retained in cache so the cache memory used before and after the cut are the same.

- 1 In the Image Store, Images, Movie Edit menu, select the **Cut** Edit Type button.
- 2 Insert the movie split point by:
 - a Either jogging, shuttling, or playing to the point in the movie where you want to split the movie and selecting the **Mark Split** button, or
 - b Selecting the **Mark Split** data pad (below Mark Split button) and entering the value for the split point in the Mark Split Point pop-up keypad, and select **Enter**.

Note: Mark In and Mark Out are not used for Trim.

- 3 Select the **Split Movie** button. The New Image 1 pop-up keyboard is displayed.
- 4 Enter a name (select **Name**) or accept the default (the existing ID) for the first movie and select **Enter**.
- 5 Enter a name (select **Name**) or accept the default for New Image 2 (the existing ID plus and select **Enter**. The two new movies are created and original removed.

Join Image Store Movies and Stills

The Join Edit mode allows the operator to merge two clips into one. The original clips are no longer in cache so no additional cache is used. Movie and still images are joined to create a new movie.

- 1 In the Image Store, Images, Movie Edit menu, select the Join Edit Type button.

- 2 Select the Change Image button for the first movie (top thumbnail) and select the desired movie.



- 3 Select the **Change Image** button for the second movie (bottom thumbnail) to be appended to the tail end of the first, and select the desired movie.
- 4 Select the **Join Images** button. The new movie is created and appears in the movie lists in the Movies menus.
- 5 Mark a thumbnail if desired (optional).
 - a Determine where you want to mark thumbnail and select the Mark Thumbnail data pad, or
 - b Enter the mark-thumbnail point in the pop-up keypad and select Enter.

Image Store Build Edit

Image Store Build Edit allows you to mix and match Video (or Fill) and Key (or Cut) signals that are elements of up to three different movies. Each movie is loaded into a separate Image Store channel. When built, the elements from each channel are composited into a new Image Store movie. Each element can be edited, including independent offsets for the Key/Cut.

Playback controls are provided so you can preview the composited image prior to building a new movie.

Key/Cut Image Store movie elements can be offset in relation to the Video/Fill element. A negative offset means the key signal begins before the video and a positive offset means

the key signal starts after the video. The key can be offset independently in the Image Store Build Edit menu.

Built Movie Length

When built, the movie length is the total of the composited elements, including offsets. The Video/Fill and Key/Cut elements add frames with a duplicate still to extend the recorded length to match the longest element.

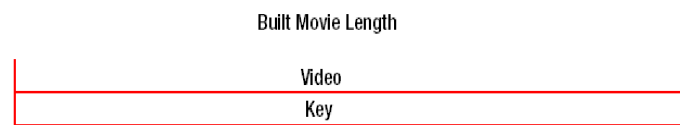
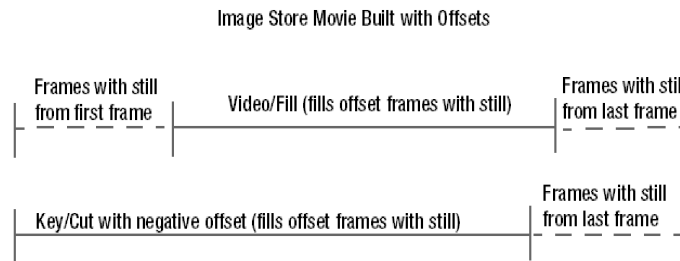

Image Store Movie Length

Build Edit Default Settings

The Image Store Build Edit menu default has the Video/Fill element with the associated key/cut signal selected. Meaning, if you selected the **Build Movie** button in the menu, a duplicate of the Video/Fill movie would be created. In this default state, the **Key from Video** button in the Key/Cut element area, are enabled (highlighted).

Enable Edit (Button)

The Enable Edit button must be enabled to edit Video/Fill, and/or Key/Cut signals. Selected Image Store channels with movies loaded for editing have a light gray background behind the Image Store ID, indicating that the channel is in editing mode and *cannot* be output from the switcher until the Enable Edit button is disabled. Best practice is to disable the Enable Edit button immediately after editing or before a broadcast.

Build Edit Menu Button Descriptions

The left-hand Build Edit Type menu pane is divided into three elemental areas: Video/Fill and Key/Cut. In addition to common channel and timecode editing buttons, the Key/Cut element areas provide independent function for movie building and playback control.

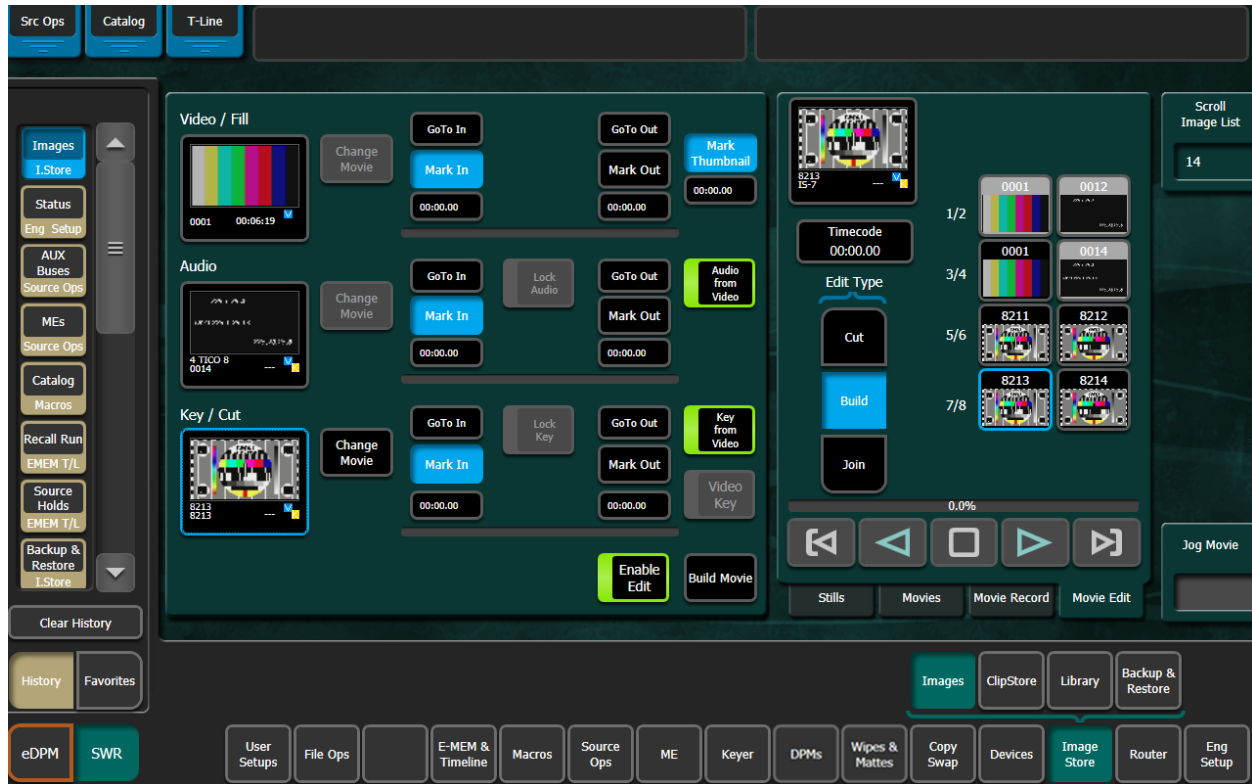

Build Edit Menu Buttons

Element Area	Button	State	Description
All (Video/Fill, Audio, Key/Cut)	Thumbnail Viewer	Image Store Channel selected/Movie loaded	Thumbnail of the currently loaded clip
	Change Movie		Change Image Store channel movie
	GoTo In		Go to mark-in point in the movie
	GoTo Out		Go to mark-out point in the movie
	Mark In		Set mark-in point in the movie
	Mark Out		Set mark-out point in the movie
	Mark In/Mark Out Timecode Data Pads		Enter mark-in/mark-out timecode for the element
	Mark Thumbnail		Select thumbnail image from the Video/Fill element's current position
	Build Movie		Builds a movie from the composite elements
Video Fill	Mark Thumbnail Timecode Data Pad		Enables Build Edit for selected Video/Fill Image Store movies (Enable Edit must be disabled for selected channels to be output from the switcher)
			Enter mark point for thumbnail image in timecode
Key/Cut	Key from Video	On	Key comes from movie in Video/Fill
		Off	<ul style="list-style-type: none"> Key comes from movie in Key/Cut If no key is loaded in channel, key is removed and full raster white is used when Build Movie is performed
	Video Key	On	Key comes from movie in Video/Fill channel (default when Key from Video button is off)
		Off	<ul style="list-style-type: none"> Cut comes from movie in Key/Cut channel If no cut is loaded in channel, cut is removed and full raster white is used when Build Movie is performed
	Lock Key	On	<ul style="list-style-type: none"> Key/Cut signal locked with Video/Fill channel timeline Playback motion control enabled
		Off	Playback motion control of Key/Cut channel only

Copy a Movie with Build Edit

With the Build Edit menu, you can create a duplicate of an existing Image Store movie including the key. This allows you to retain the original movie and edit the copy.

- 1 In the Image Store, Images, Movie Edit menu, select **Build** as the Edit Type.
- 2 Select an Image Store channel for the Video/Fill element (right).
- 3 If desired, select the **Change Movie** button to select a different movie.

Build a Movie Using a Key and Video from Different Movies

The key of the Key/Cut channel can be paired with the video in the Video/Fill channel to create a new movie using the Build Edit feature.

- 1 In the Image Store, Images, Movie Edit menu, select Build as the Edit Type.
- 2 Select an Image Store channel for the Video/Fill element (right).
- 3 If desired, select the Change Movie button to select a different movie.
- 4 Repeat for the Key/Cut movie.
- 5 Turn off the Key from Video button in the Key/Cut element area.
- 6 Turn off the Video Key button (when highlighted) in the Key/Cut element area.
Result: The key from the Key/Cut channel is paired with the video from the Video/Fill channel.
- 7 Position the movie for each element at the first synchronized frame.
- 8 Optionally, with the Lock button enabled, the composite elements can be previewed using the Image Store movie controls before building the new movie.
- 9 Select the Build Movie button and create a name for the Image Store movie using the pop-up keyboard.

Build a Movie With Video from One Channel as the Key for Another

The video of the Key/Cut channel can be paired with the video in the Video/Fill channel as its key to create a new movie using the Build Edit feature.

- 1 In the Image Store, Images, Movie Edit menu, select **Build** as the Edit Type.
- 2 Select an Image Store channel for the Video/Fill element (right).
- 3 If desired, select the **Change Movie** button to select a different movie.
- 4 Repeat for the Key/Cut movie.
- 5 Turn off the **Key from Video** button in the Key/Cut element area.
- 6 Result: The **Video Key** button is highlighted (and must remain on) meaning the video from the Key/Cut channel is the key for the video in the Video/Fill channel.
- 7 Position the movie for each element at the first synchronized frame.
- 8 Optionally, with the **Lock** button enabled, the composite elements can be previewed using the Image Store movie controls before building the new movie.
- 9 Select the **Build Movie** button and create a name for the Image Store movie using the pop-up keyboard.

Offset an Image Store Key/Cut Signal with Build Edit

A *negative* offset sets the Key/Cut signal to start before the Video/Fill; if the key is shorter than the video, the last frame will record as a still to the end of the movie. A *Positive* offset

sets the key signal to start after the Video/Fill and records a still of the first frame of the key until the key starts.

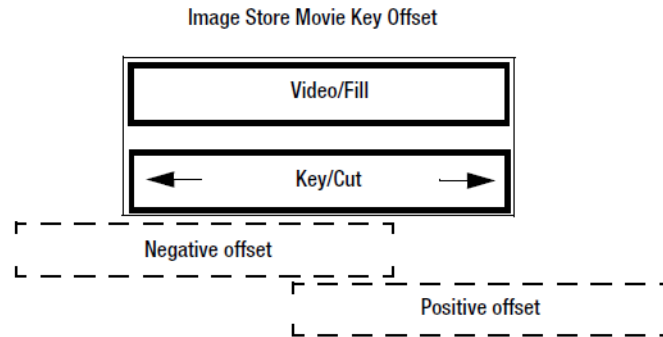

Image Store Key/Cut Offset

Prerequisite: Image Store audio output groups are configured and enabled.

- 1 Select **Image Store, Images, Movie Edit** tab in the menu.
- 2 Select the Key/Cut element movie and assign an Image Store channel by selecting it (right).
- 3 Enter the offset value in the **Key Offset** data pad (a negative (-) value means the audio is set to begin before the video):
 - a Turn the Menu Panel soft knob to select a value or,
 - b Select the **Key Offset** data pad, enter a value in the pop-up keypad, and select Enter.

Creating a Sequenced Movie

A series of suitable related still images can be sequenced into a movie, using the Library menu Sequence Image Operation.

Prerequisites:

- Images must be PNG or TGA (Targa) format.
- All images must be in an accessible Disk/Folder.
- Each still image file needs to be named as a four digit number (i.e. 0001.png, 1092.tga).
- The sequence of files must be in ascending numerical order, matching their relative position in the movie. The lowest numbered file will be the first movie frame, and the highest numbered file the last. Numbers can be skipped (i.e. 0001, 0002, 0101, 0102, 0103 is valid), but the presentation order is always ascending.

Create a Still Sequenced Movie

- 1 Go to the Image Store/Library menu.
- 2 Select From Disk/Folders on the left and navigate to the folder holding the stills.
- 3 Select **To Cache** on the right. The Sequence Image Operations button will appear. Select **Sequence** so it highlights.
- 4 Click **Images** in the center and enter the sequence of stills in the pop up menu.

- 5 Click **Start ID** and enter the file name number for the resulting movie. If that file name already exists it will be overwritten.



Movie Sequence Confirmation Prompt

- 6 Select Execute. A confirmation prompt appears.
- 7 Select Yes. The stills will be converted into a movie, and when done that movie will be available in the Cache for immediate loading and playing from the Image Store.

Image Store Record Modes

Normal Record Mode

Record a movie continuously until it is stopped or the Image Store cache is full.

Timed Record Mode

Record a movie of a set duration.

Loop Record Mode

Record a video segment of a set duration (MM:SS.FF) from the last seconds of a continuously streaming video. In Loop record mode, the last frame of the buffer is displayed in output.

When recording in Loop mode, Image Store buffers video from the currently recording frame, back to the first frame of the defined duration; previously recorded frames are discarded as new ones are recorded.

When recording is stopped, the buffered video is available as an Image Store movie.

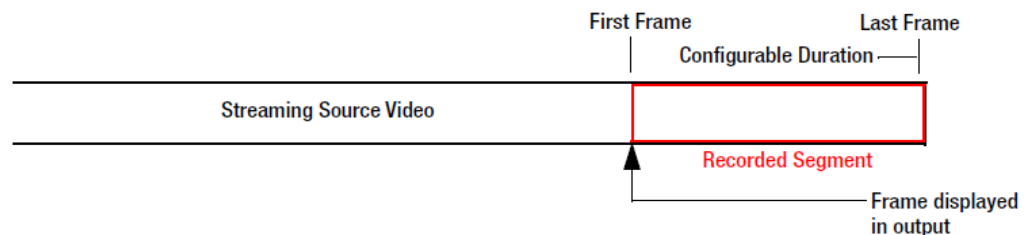

Image Store Loop Record Mode Definition

Delay Line Record Mode

Record a video segment of a set duration (MM:SS.FF) from the last seconds of a continuously streaming video with a delay. In Delay Line record mode, the first frame of the

continuously recording video in buffer is displayed in output, therefore the recorded frames up to the end of the recording are delayed.

Note: When recording is first started in Delay Line record mode, after one second the first frame will freeze until the remaining frames of the defined duration have been recorded into the buffer.

When recording in Delay Line mode, Image Store buffers video of a set duration. The buffered video is captured from the currently recording frame back to the first frame of the defined duration; previously recorded frames are discarded as new ones are recorded.

When recording is stopped, the buffered video is available as an Image Store movie.

Create a Movie from Continuously Streaming Video with Loop Mode

Create a movie of a set duration from the last seconds of a continuously streaming video. In Image Store Loop record mode, the last frame of the buffer is displayed in the output.

- 1 In the Image Store, Images, Movie Record menu, select an Image Store channel (1/2 through 9/10).
- 2 Select a source for the video stream on the Image Store channel.
- 3 Set the record mode by selecting the **Record** (mode) data pad and choosing **Loop** in the pop-up Record Mode Button pane.
- 4 Select the **Record Mode Duration** data pad, enter a duration (MM:SS:FF) in the pop-up keypad, and select **Enter**.
- 5 Optionally, select the **Record Elements** data pad and select from Video, Key as part of the recording, then select **Done**.
- 6 Select the **Timecode** data pad and enter a duration in the pop-up keypad for the movie length you wish to record, and select **Enter**.
- 7 Select **Show E-E** (changes to Record) then **Record**.
- 8 Select the **Record** button again to stop recording.
- 9 To save the recorded movie, select **Keep** then **Enter** in the pop-up keypad (optionally you can change the image number using the keypad).

Result: An Image Store movie is created and the thumbnail is displayed in the scrolling images list.

Create a Movie including a Delay with Delay Line Mode

Create a movie of a set duration from the last seconds of a continuously streaming video with a delay. In Delay Line record mode, the first frame of the video in buffer is displayed in output, therefore the frames up to the end of the recording are delayed.

- 1 In the Image Store, Images, Movie Record menu, select an Image Store channel (1/2 through 9/10).
- 2 Select a source for the video stream on the Image Store channel.
- 3 Set the record mode by selecting the **Record** (mode) data pad and choosing **Delay Line** in the pop-up Record Mode Button pane.

- 4 Select the **Record Mode Duration** data pad, enter a duration (MM:SS:FF) in the pop-up keypad, and select **Enter**.
- 5 Optionally, select the **Record Elements** data pad and select from Video, Key, as part of the recording, then select **Done**.
- 6 Select the **Timecode** data pad and enter a duration in the pop-up keypad for the movie length you wish to record, and select **Enter**.
- 7 Select **Show E-E** (changes to Record) then **Record**.
- 8 Select the **Record** button again to stop recording.
- 9 Select Keep then Enter in the pop-up keypad (optionally you can change the image number using the keypad).

Result: An Image Store movie is created and the thumbnail is displayed in the scrolling images list.

Image Store Library

The Image Store Library menu allows you to perform file operations. Save image files from Image Store Cache to the internal Image Store Disk or from external Menu disk/folders or Network and USB Memory Stick drives, to Image Store.

The output files are native K-Frame (.eif).

Copy, Swap, Move, and **Delete** buttons are available in the Image Store Library menu. Different Image Operations buttons are available based on the file transfer type.



Swap Images

Swap images between Image Store IDs, for example if you have an effect that recalls ID 0022 but you 'd like a different image to be recalled during certain shows, and you do not want to replace the image, you can swap images between the IDs.

Move Images

Move images to a new Image Store ID number, for example IDs 0001-0010 could be moved to 0050-0060.

Conversion Requirements for Transferring External Image Files

Importing files into GV K-Frame XP either from a folder on the network or USB Memory Stick, requires that the file name must be a number between 0001 and 8999 with the .kif extension (Kayenne/Karrera/GV Korona).

CAUTION: When importing files into Image Store cache, existing files with the same ID can be overwritten so check if the ID already exists in the cache.

Image Store Still File Formats

- GIF
- JPEG
- TIFF
- BMP
- PNG

Image Store Movie File Formats

SD/HD/4K

- AVI
- MOV
- Mp4
- PNG sequences (load a series of still images and create a single ID movie from them)

SD/HD

- KayakHD (xtendd)
- Kalypso (gvi, gva)

Importing Kalypso File Types

- The still files must be named using the default Kalypso numbering format (I000000.gvi/.gva, but not greater than I008999.gvi/.gva). If a Kalypso still has been renamed, change it back to this naming format using the Kalypso system, or by renaming both the .gva and .gvi files to matching file names directly in the computer directory.

- Both of the Kalypso still .gvi and .gva file components must be present for each image.
- Thumbnail.bmp images are not supported (the system generates its own thumbnails). Kalypso image .bmp files can be ignored, and can safely be deleted from the directory to keep them from appearing on the Image Store Library menu screen.

Note: Kalypso NTSC Still Store images contain 486 lines, while the Image Store supports 487 lines. A GV Switcher system will display one black line at the bottom of the image raster of converted Kalypso NTSC stills.

Transfer Files

Transfer files from one location to another with the Image Store, Library menu.



- 1 Select a tab to execute a file operation “from” (left side of menu).
- 2 Select a tab to execute a file operation “to” (right side of menu).
- 3 Select an active Image Operations button; Copy, Swap, Move (or Delete) from the center of the menu.
- 4 Select the Images range data pad in the center of the menu to display the pop-up keypad.
- 5 Enter an Image ID number or a range of images:
 - a Enter a start ID.
 - b Select the Thru- button.
 - c Enter an ending range.

Note: Alternatively, use the Next, button in the pop-up keypad to enter non-sequential Image IDs.

- 6 Select Enter.
- 7 Optionally, a starting ID can be defined for the image files in the target (To) directory when the operation is executed:
 - a Turn on the Start ID button.
 - b Select the Start ID data pad.

- c Enter an image ID in the pop-up keypad, and select Enter.
- 8 Select Execute.

Backup & Restore

The Image Store Backup & Restore menu tab provides control of manual and scheduled backups to local disk and restore from local disk. To access the Backup & Restore menu, select Image Store, Backup & Restore.



Manual Backup

To manually backup the Image Store Cache locally:

- 1 Select the Local Backup Path data pad.
- 2 Select to select a target folder by navigating to an existing folder in the navigation pane (left), or by creating a new target folder:
 - a Navigate to the desired directory in the navigation pane.
 - b Select the Create Folder button.
 - c Enter a folder name in the pop-up keyboard.

Note: Verify the path in the Local Backup Path data button; the target folder must be open to see the complete path.

- d Select the Accept button.

- 3 Select the Backup Cache Start toggle button to begin the backup operation (border highlights green).

Schedule a Backup

Use the scheduling controls in the Backup & Restore menu to schedule backups for one, several, or all days, including the time of day. To access the Backup & Restore menu scheduling controls, select Image Store, Backup & Restore.

Note: The backup schedule is based on the Current Date & Time of the system.



- 1 In the Scheduled Backup Setting pane, select the day(s) you wish to schedule the backup (also **All Days** button can be selected).
- 2 Select the Scheduled Backup Time data pad.
- 3 Either by selecting the **Hours/Minutes** data pads and entering values in the pop-up keypads or using the soft knobs on the Menu Panel, enter a time of day.
- 4 The default is AM unless you select the **PM** toggle button to turn it on (highlights green, shows am/pm in the **Scheduled Backup Time** data pad at the end of the time).
- 5 Select the **Scheduled Backup Path** data pad and select to select a target folder by navigating to an existing folder in the Navigation pane (left), or by creating a new target folder:
 - a Navigate to the desired directory in the navigation pane.

- b Select the **Create Folder** button.
 - c Enter a folder name in the pop-up keyboard.
 - d Select the **Accept** button.
- 6 Select to toggle on the **Enable Schedule** button (highlights green).

Restore Cache from the Local Drive

To restore the Image Store Cache from the local drive:

CAUTION: A restore clears and replaces all files in cache.

- 1 Select the Local Backup Path data pad.
- 2 Select to select a source folder by navigating to an existing folder in the navigation pane (left).
- 3 Select the Restore Cache Start toggle button to begin the restore operation (border highlights green).
 - a If restoring from a scheduled backup, verify that the Local Backup Path shows the correct path.

About Image ReStore

Image ReStore allows you to automatically load stored Image Store files after a system reboot or during switcher operation. Each suite has an independent Image ReStore.

Image ReStore includes the following functionality for storing and loading files:

- Automatically restore stills and movies after a system reboot,
- Edit saved files in Image ReStore using common file operations, so only the files you need will be included, reducing file load durations, and
- Save or load files during switcher operations.

Image ReStore Button Functions

The Image ReStore button pane is located in the Image Store, Backup & Restore, Library menu.

Image ReStore Button Functions

Image ReStore Button Functions

Button	State	Description
Enable	On/Off toggle	When on, saved Image Store files will be loaded after a system reboot

Image ReStore Button Functions

Button	State	Description
Store Start	On - Starts storing files Off - File storage complete	<ul style="list-style-type: none">• When enabled, starts storing the files from Image Store cache to the Image ReStore folder• Replaces the entire contents of the ReStore folder• Files will be restored after a system reboot• File storage can be stopped by turning off the Store Start button
ReStore Start	On - Starts loading files Off - Restore Complete	<ul style="list-style-type: none">• On—When enabled, starts restoring files from the Image ReStore folder to the Image Store cache• Off—Restore complete• File restore can be stopped by turning off the ReStore Start button

Enable Image ReStore

When Image ReStore is enabled, any stored files will be reloaded after a system reboot. Image ReStore automatically stores any cached still or movie.

- 1 Select Image Store, Backup & Restore in the menu.
- 2 In the Image ReStore menu pane, turn on the Enable button (green highlighted border).

Editing Files in Image ReStore

Stored files are located in the Image Store, Library, From Image Store menu tab, in the Default/ReStore folder. You could for example, copy an additional file to the directory or delete files that you do not want restored.

Stored images can be edited using the Image Store Library, Image Store File Operations. See the Image Store section in the *Kayenne/Karrera/GV Korona User Manual* for more information.

Configure a Networked PC for Image Store File Sharing Windows

For Windows 7 and Windows 10, you can transfer properly labeled image files of a supported format from a networked PC or USB Storage Device to the Image Store Cache. However, the PC network security must be configured for access.

CAUTION: If the network is part of a domain or you are unable to access shared folders across a network, contact your local Systems Administrator.

Create an Images Directory and Configure it for Sharing

- 1 Create a folder in C:\ and name it Images.
- 2 Right-click on the Images folder and choose **Share with**, and select **Specific people...** from the pull-down menu.
- 3 Click on **Everyone** and verify that the Owner pull-down is set to Read/Write.
- 4 Click **Share**.

Set Network and Sharing Settings

Click to select the following in order:

- 1 Windows **Start, Control Panel**,
- 2 **Network and Sharing Center**,
- 3 **Choose homegroup and sharing options**,
- 4 **Change advanced sharing settings...**,
- 5 **Turn off network discovery** (radio button),
- 6 **Turn off password protected sharing** (radio button), and
- 7 **Save Changes**.

ClipStore

With the seamless integration of the K2 Summit/Solo technology into the Image Store menus, you can record and play clips with audio. The Summit provides four Video/Key channels while the Solo provides two.

See the *Kayenne/Karrera/GV Korona Installation & Service Manual* for engineering configuration information.

- The ClipStore is supplied to record and playback with AVC-Intra 100 or DVCPRO HD compression format. Clips imported in DVCPRO HD, DVCPRO 25/50, DV, and MPEG-2 will play natively.
- The ClipStore supports embedded audio only. The AES inputs and outputs are not used.

The ClipStore is completely configured and controlled from the GV Switcher menu and control panel. There is no need to use the built-in AppCenter Elite software. In fact, if changes are made to the ClipStore using AppCenter, they will be overwritten by the switcher the next time it sends a configuration to the ClipStore.

Note: To change the Summit IP address, see the Installation & Service Manual for your switcher model.

This highly integrated solution provides several powerful features, including:

- Fast access to clips and folders,
- Large storage capacity,
- Non-volatile memory—no loss of images due to power failure,
- Clip control from the GV Switcher Menu Panel and clip stack control from the GV Switcher Control Panel,
- ClipStore device controls (including macros and cues) are E-MEMable, and
- Make sub-clips from clips and build composite clips with audio.

Summit/Solo Software Version

The latest version of the AppCenter Elite software is available on the GV Switcher Software Download site.

CAUTION: Do not use AppCenter Elite software for ClipStore from the Summit/Solo server web site as it may not be compatible.

For more information about installing and updating AppCenter Elite software, see the Summit/Solo manuals.

ClipStore as an External Device

Note: ClipStores 1-4 as devices can only be enabled in the Eng Setup, Devices, Node Settings menu in the Frame Suite Nodes & ID menu tab.

When assigning devices to E-MEM levels, ClipStore is devices 29 through 32.

ClipStores 1-4 will appear as the first four external devices in the Device Enables scrolling list, in the Devices, Enables menu (and other Devices menus). External Device 1 will now be in the 5th position in the Device Enables list. Enable/Disable buttons in the Devices menu do not function for ClipStore.

Note: For a two-channel K2 Solo, only ClipStores 1 and 2 are reserved and External Device 1 will be in the 3rd position.

ClipStore can be used in a gang like any other external device. For more information about ganging devices, see [Router Interface Operation](#), on page 237.



Control Panel Operation

As with other external devices, device control is possible through the Multi-Function and the System Bar. Engineering names (CS-1, CS-2, etc.) appear in the control panel displays and all motion controls provided from the server are available. ClipStore motion controls can be learned as part of an E-MEM.

ClipStore Menu Operations

Clip Replay

The selected ClipStore output channel will be outlined in blue or red if on-air.

Note: ClipStore channel represents a permanent Video/Key pair.

Clip replay is performed in the Image Store, ClipStore, Clips menu. A *Record Time Remaining* indicator in HH:MM:SS format is provided in ClipStore as a reminder to maintain enough storage space for recording or adding clips. The indicator displays the available storage remaining in the ClipStore Summit/Solo server.



Select a Folder

- 1 Select the **Current Folder** data pad located just above the scrolling clip list to change the current folder. The Folders/Clips menu is displayed.



- 2 Select the folder you wish to be the current folder and either select a clip on the right or press the **Cancel** button (bottom right of menu, to close and return to the Clips menu (if the Cancel button is selected, the folder will still be changed but it will not result in a clip load).

Menu Clip Selection

Clips can be selected in three ways in the menu:

- Selecting a clip in the scrolling clip list,
- Selecting the Scroll Image List data pad, and entering the Image ID for the clip (ascending numeric value in the current folder).
- Selecting the Current Folders data pad and then selecting a clip in the Current Clip scrolling list.

With the **Auto Load** button selected (highlighted green), the clip will be loaded into the selected ClipStore channel.

Load a ClipStore Clip

- 1 Turn on Auto Load by selecting the Auto Load button.

Note: Auto Load must be on to load a clip.

- 2 Select a ClipStore channel.
- 3 Select a clip in the scrolling clip list.

The clip loads to the selected channel.

The Current Thumbnail viewer displays the loaded clip in the selected channel.



Note: When a ClipStore channel is selected and a clip is loaded, that clip will be highlighted in blue in the scrolling clip list and the list will automatically scroll to display the selected clip.

Clip Search

You can search for clips using the **Search Clip** button. Selecting the button displays the Search Clip keyboard. Type letters and/or numbers (minimum 1 character) and select **Enter** to execute the search. The found clips will be listed in the scrolling clip list.

If Auto Load is on, the first clip in the resulting list will be loaded into the selected channel. If Auto Load is off, or the search finds no clips, then no clips will be loaded.

Playback a Clip

The Playback pane in the Image Store, Clips menu provides playback and playback parameter controls for clips.

- 1 Load the clip into a ClipStore channel and select the **Play** button.
 - a Loop a clip by selecting the **Loop** button (highlights green).
 - b Mute the audio of each channel individually with the **Audio Mute** button.
- 2 Alternatively, turn on the **Auto Start** button and take the channel on-air.

Example: If you take the CS-1 channel on-air, either as a background or keyer, the clip loaded into the CS-1 channel will play automatically when the Auto Start button is on.

Other controls include:

- Timecode data pad—Select the Timecode data pad to enter a timecode.
- Mark In/Mark Out buttons and data pads—Select the Mark In/Mark Out buttons to set the mark-in/mark-out to the current clip position, select the data pads to enter a Mark In or Mark Out point on a numeric keypad.
- Cue to Begin button data pad—Select the Cue to In data pad and enter the value.
- Var Play Speed data pad—Var Play Speed button on, enables variable speed play. Select the data pad to enter the playback speed percentage value.

Device control buttons:

- Rewind
- Fast Forward
- Start of Clip
- Reverse Play
- Stop
- Play
- End of Clip

(The KF Trigs button is described in [E-MEM Keyframe Triggers for ClipStore](#), on page 375)

Note: There is macro support for all the functions listed above.

Clip Cueing and Playback Controls

Once a movie is loaded and selected for control, the Cue to Start, Play Reverse, Stop, Play Forward, and Cue to End buttons are available. Additional menu playback controls include:

Loop—Sets the movie to run continuously, jumping from its last frame to the first.

Bounce—Sets the movie to run to its end, reverse playback to its beginning, then play forward, and repeat (only available when Loop is active).

Auto Start—Sets the movie to play when taken On-Air.

KF Trigs— Enables EMEM KF triggering (see [E-MEM Keyframe Triggers for Image Store Movies](#), on page 349).

Timecode—Opens a keypad allowing entry of a time code value to cue the movie to. This control is also available on the Movie Record and Movie Edit menus.

Mark In—Sets the current cued location of the movie as its playback start point.

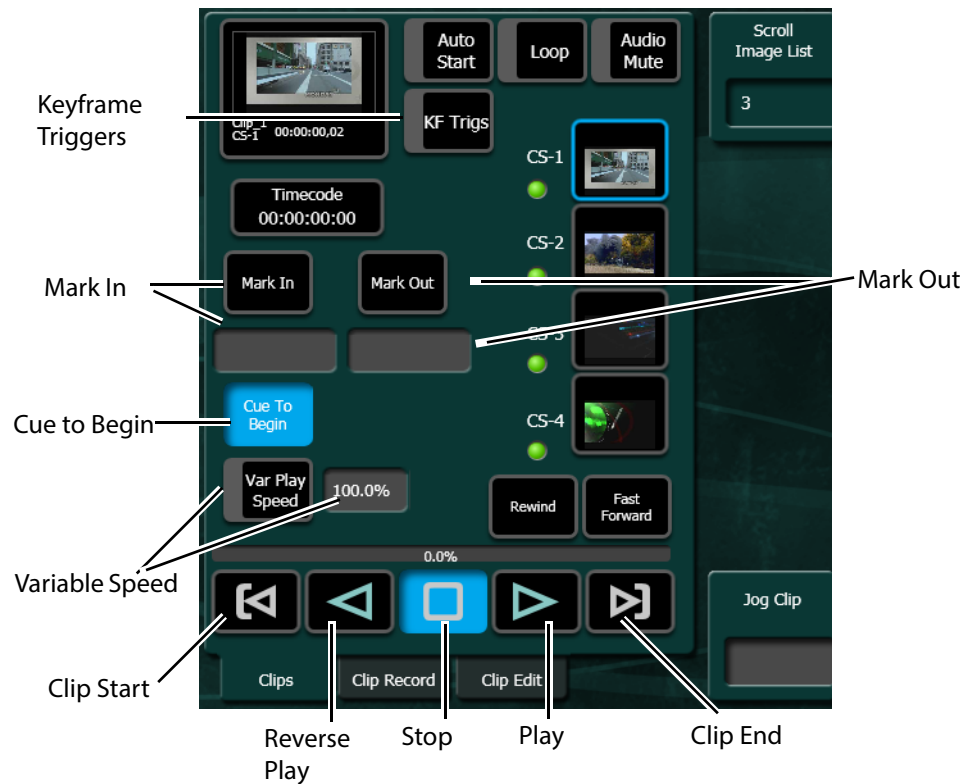

Mark Out— Sets the current location of the movie as its playback end point.

Cue to Begin— Cues to the Mark In point, if set.

Var Play Speed— When On, plays the clip at the percentage speed displayed on the right. Clicking on the percentage allows entry of the desired speed. Supported range is from 0.1% to 5000%.

Jog Movie—The knob on the Menu Panel can be used to jog the movie forwards and backwards. This control is also available on the Movie Record and Movie Edit menus.

E-MEM Keyframe Triggers for ClipStore

ClipStore replay can be controlled with E-MEMs. Keyframe triggers that are E-MEMable are:

- Load (Clip),
- Loop Enable/Disable,
- Cue (to in).

All Motion Controls:

- Clip Start,
- Reverse Play,
- Stop,
- Play,
- Clip End, and

- Variable Speed Play (Var Play Speed button).

Note: The Master E-MEM has CS-1, CS-2, CS-3, and CS-4 assigned by default to MISC 1-4.

Create a ClipStore E-MEM Keyframe Trigger

- 1 In the Devices menu, select the **Clear All Events** button, ensuring unwanted keyframe triggers are not included in your E-MEM.
- 2 In the Image Store, ClipStore, Clips tab in the menu, select a ClipStore channel then select a clip.
- 3 Select the **KF Trigs** button. The motion control buttons become jeweled toggle buttons, and **Loop Enable**, **Loop Disable** and **Cue** buttons are displayed.



- 4 Select the controls that you want as part of the keyframe trigger (see [Clip Cueing and Playback Controls](#), on page 374).
- 5 Learn the keyframe trigger to an E-MEM on the Control Panel ([Learning E-MEM Registers from the Control Panel](#), on page 110) or from the E-MEM & Timeline, Recall Run menu.

Recording Clips

Clips are recorded with embedded audio in the Image Store, ClipStore, Clip Record menu.

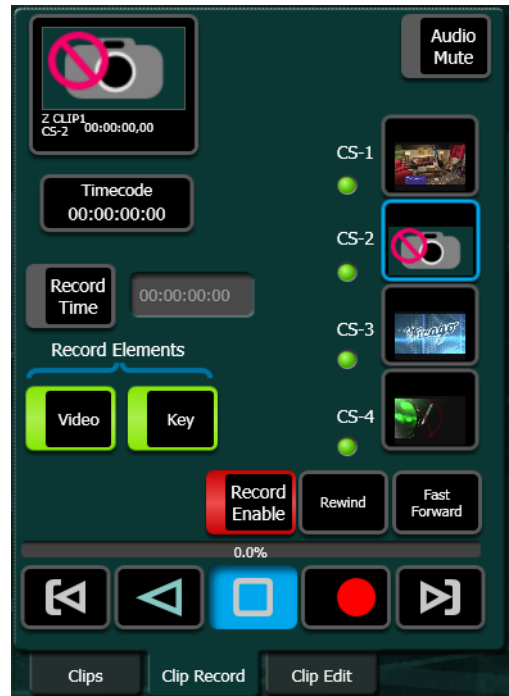

When the **Record Enable** button is selected, ClipStore ejects the clip from the selected channel, places the ClipStore channels in E/E mode, and displays a pop-up keyboard. Type in the name of the new clip. Once the name is typed, **Enter** is pressed, and the keyboard closes, the **Record Enable** button is highlighted red and the menu has changed to display recording controls and parameters in readiness for recording. The **Play** device control button is replaced by a **Record** button.

Clips can be overwritten by entering an existing clip name into the pop-up keyboard or by selecting the Cancel button in the pop-up keyboard and selecting a clip (or folder then clip) in the Folders/Clips menu. Once either operation is completed, you are returned to the Record mode menu and the Record button is present and highlighted in red.

Note: Thumbnails do not display in the Current Thumbnail Viewer in Record Enable mode except when overwriting an existing clip.

The **Video** and **Key Record Elements** buttons allow you to route the Aux Bus selections:

- Video Only—Video + Full Raster White,
- Key Only—Key + Key, and
- Video/Key—Video + Key.
- Set a Record Time using the Record Time button.

Note: If an Aux Bus is not configured for the ClipStore output, the **Video** and **Key** buttons will always be on.

Set a Record Time

Video and Key Record elements are also very useful for editing when you want to build or join clips (see [Editing Clips](#), on page 378).

To set a record time:

- 1 Select the **Record Time** button, a pop-up keypad will appear.
- 2 Enter the desired value. and select **Enter**.

Record a ClipStore Clip

- Select to select the ClipStore channel for recording.
- Select the **Record** mode button.
- Define the Record Elements you wish to apply to the clip to be recorded.
- Select the **Record Enable** button.
- Enter a new clip name or an existing clip name if you wish to overwrite that clip.
- Select **Enter**.
- Select the **Record** device control button.
- Select the **Stop** device control button when the desired length of the clip is reached.

Editing Clips

Clips can be edited in the Image Store, ClipStore, Clip Edit menu. There are three types of clip editing provided:

- Cut Edit,
- Build Edit, and
- Join Edit.

Cut Edit

- Cut Editing allows you to edit a clip in the following ways:
- Rename Clips (use the Rename button).
- Mark a thumbnail, see [Cut Edit](#), on page 378),
- Trim and remove from the head of the clip to the Mark In point ([ClipStore Trim and Remove](#), on page 379),
- Trim and remove from Mark Out point to the end of the clip,
- Make sub-clips (including splitting one clip into two) from the current clip ([Make Sub-clips from the Current Clip](#), on page 380), and
- Cut Edit while recording a clip ([Cut Editing while Recording](#), on page 381).

For Cut Edit, select **Image Store**, **ClipStore**, **Clip Edit** and select the **Cut** button in the Edit Type mode group.

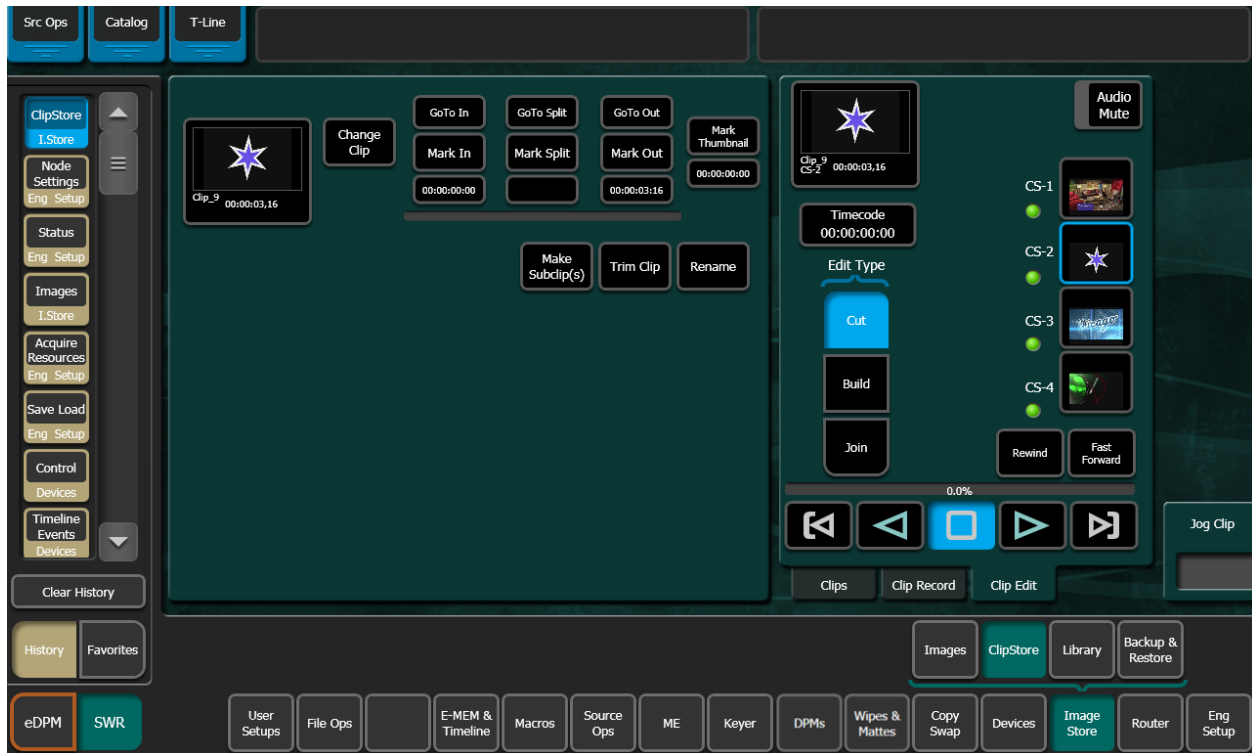

Mark a ClipStore thumbnail

The Cut Edit menu displays the currently loaded clip in the thumbnail view. If you wish to change the clip, select the **Change Clip** button before editing.

- 1 Select the **Change Clip** button to select a clip to edit (unless previously loaded).
- 2 Either jog, shuttle, or play to the desired frame and select the **Mark Thumbnail** button or,
- 3 Select the **Mark Thumbnail** data pad and enter the mark point in the pop-up Mark Thumbnail Point keypad, and select **Enter**.
- 4 Select the **Mark Thumbnail** button—the new thumbnail replaces the old in all views.

ClipStore Trim and Remove

Material can be removed from the head of a clip to a mark-in point and from a mark-out point to the end of a clip. Both operations can be performed on a single clip.

Trim Clip operations include:

- Setting only the mark-in point, and selecting the Trim Clip button—the clip will be trimmed from the beginning of the clip to the mark-in point.
- Setting only the mark-out point, and selecting the Trim Clip button—the clip will be trimmed from the mark-out point to the end of the clip.

- Setting both a mark-in and mark-out point, and selecting the Trim Clip button—the clip will be trimmed on both ends (beginning of clip to mark-in and mark-out to end of clip).

Note: Trim Clip to mark-in, trims up to the mark point in the clip so the marked frame is the first frame of the new sub-clip.

To enter the mark-in/mark out points, either jog, shuttle, or play to the desired frame and select the **Mark In/Out** button or select the **Mark In/Out** data pad and enter the mark-in/out point in the pop-up keypad, and select Enter.

CAUTION: Trim Clip from the mark-out point, trims (removes) the marked frame and trims to the end of the clip so the frame at the mark point will not be part of the new sub-clip.

Make Sub-clips from the Current Clip

A sub-clip can be created from the current clip with mark-in and mark-out values (or without and the clip length will be the same as the original) or split into two sub-clips.

- 1 To enter the mark-in/mark out points, either jog, shuttle, or play to the desired frame and select the **Mark In/Out** button or select the **Mark In/Out** data pad and enter the mark-in/out point in the pop-up keypad, and select **Enter**.
- 2 Select the **Make Subclip(s)** button.
- 3 Enter a clip name or accept the provided name (appends _a) and select **Enter**—a new sub-clip with the trimmed length is created.

When making a split clip, the first clip is created from the current clip head to the split mark point, the second from the split point to the clip end.

Split One Clip into Two Sub-Clips

- 1 Either jog, shuttle, or play to the point in the clip where you want to split the clip and select the **Mark Split** button, or
- 2 Select the **Mark Split** data pad (below Mark Split button) and enter the value for the split point in the Mark Split Point pop-up keypad, and select **Enter**.

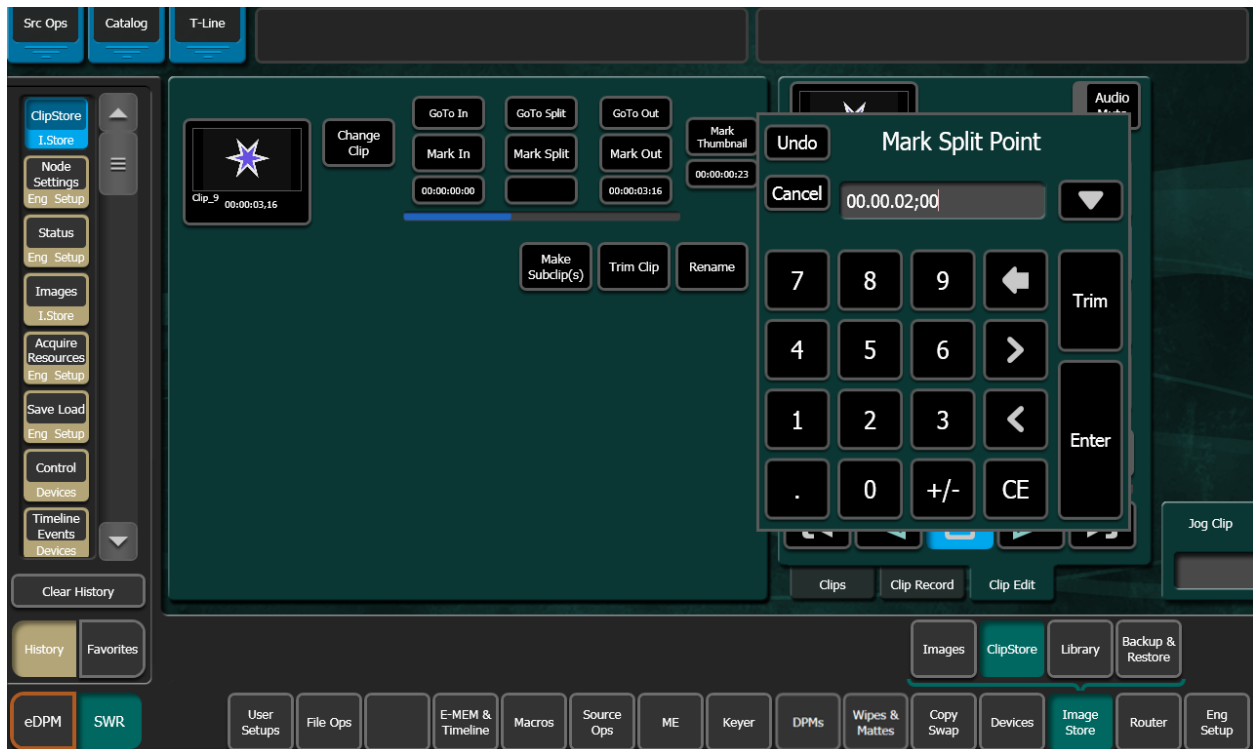

- 3 Select the **Make Subclip(s)** button—the Name First sub-clip pop-up keyboard is displayed.
- 4 Enter a name or accept the default name for the first sub-clip in the Name First sub-clip pop-up keyboard (for the default, `_a` is appended to the clip name).
- 5 Select **Enter**.
- 6 Enter a name or accept the default name for the second sub-clip in the Name Second sub-clip pop-up keyboard (for the default, `_b` is appended to the clip name).
- 7 Select **Enter**—the two new sub-clips are created.

Cut Editing while Recording

A key advantage to using a ClipStore server is you can record and replay simultaneously. This allows you to create sub-clips from the currently recording clip.

The following rules apply to performing a Cut Edit operation during recording:

- Making sub-clips is the only available operation.
- Only the Cut Edit type will be available.

- Changing the clip will not be possible from the menu during this operation.

Once recording has begun, you can select the **Edit** mode button, set mark-in/mark-out points, and create a sub-clip (see [Make Sub-clips from the Current Clip](#), on page 380).

A currently recording clip can also be loaded into another channel of ClipStore. From the other channel, sub-clips can be made from any part of the recording without interrupting the record.

Build Editing

Build Editing allows you to take elements from one long clip or from multiple clips and make a sub-clip, including:

- Video and Audio (audio from a clip or .WAV file),
- Video (with embedded audio) and Key, or
- Video, Audio (audio from a clip or .WAV file), and Key.

CAUTION: Audio files must be 48kHz/.WAV file format, other file types will not be recognized by ClipStore.

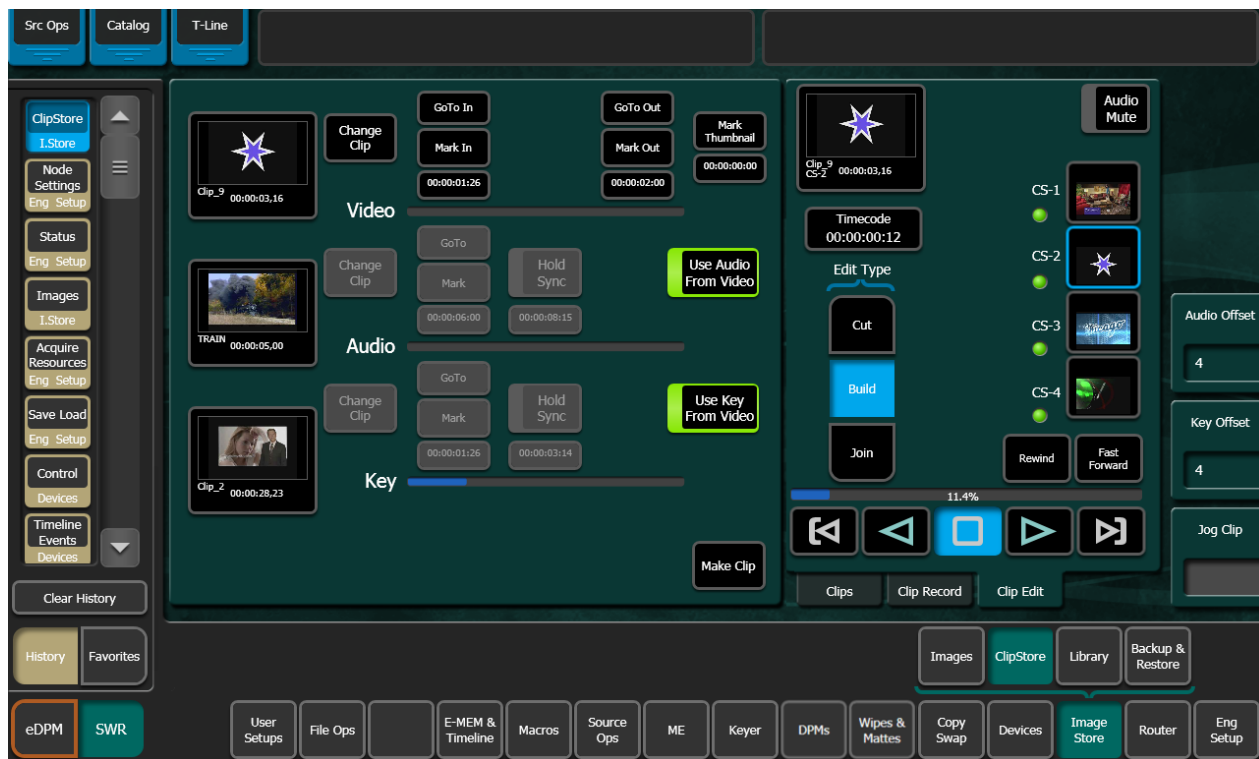

The clip created with the Make Clip operation will be a sub-clip that has its head to tail length defined by the mark-in and mark-out points of the Video track (if there are no marks, the sub-clip created will be the same length as the original). Both Audio and Key tracks of the new clip will only exist between the Video track's marks.

Video is the controlling track in the scratch clip, i.e. the Audio, Key, and motion control is slave to the Video track when selected.

Audio Offset, Key Offset, and Jog soft knobs are provided for editing (1/4 turn equals 1 frame).

Hold Sync

Hold Sync sets the position of the Audio/Key track in relation to the Video track's current timecode position. The Audio/Key track's timecode can be offset in relation to the video track timecode by changing the Hold Sync Mark Point (using the Hold Sync data pad pop-up keypad or the Audio/Key Offset soft knobs). In this way, the Audio/Key tracks can be synchronized with the Video track. Different Hold Sync Points can be set for the Audio and Key tracks in relation to the Video.

Note: If a key track from another clip is used, and starts past the mark-in point of the video track, full raster white will be used for the key until the key timecode begins when the composite clip is played. If an audio element from another clip is used, and starts past the mark-in point of the video track, there will be no audio until the start of the audio timecode when the composite clip is played.

Once the **Hold Sync** button is selected for either the Audio or Key, the Hold Sync point will be set and their positions in relation to the current video track timecode position become part of the scratch clip, and subsequently the new sub-clip when the Make Clip button is selected.

Note: You can still change any of the current timecode values, including the video timecode by changing the mark-in/mark-out points and the Audio/Key timecode using the Hold Sync data pad or Audio/Key Offset soft knobs, before the Make Clip button is selected. Each change updates the scratch clip.

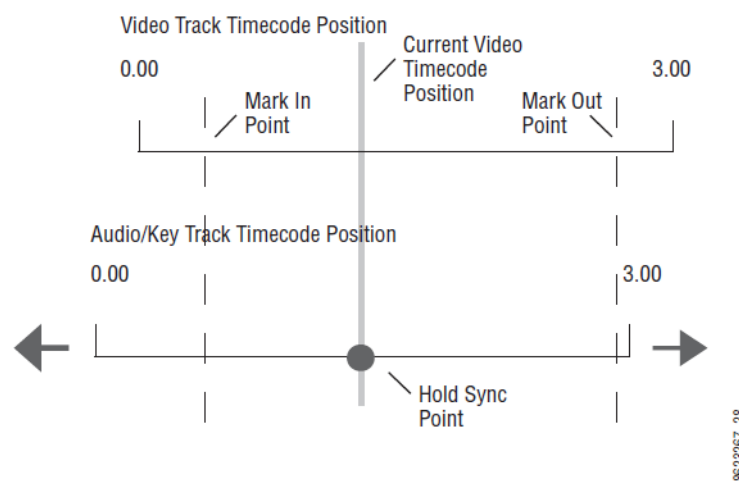

Hold Sync Point

The following provides examples and procedures of how to combine elements of Video, Audio, and Key. These composited elements become part of the new sub-clip.

These procedures can also be used to make a composite clip of elements on one long clip, for example if both Video and Key track are recorded on one clip, the clip can be loaded as the Video track and then as the Key track, synchronized, and then a sub-clip made of the composite elements.

As with other ClipStore editing operations, if you enter the name of an existing clip, that clip will be overwritten when creating a sub-clip using the Make Clip operation.

Editing a Video Clip with Build Edit

The following examples demonstrate how to mark-in, mark-out, mark a thumbnail, and make a sub-clip. The **Use Audio From Video** and **Use Key From Video** buttons are enabled (highlighted green) which means only the video track will be edited and a new clip made with those changes:

Mark In/Out

Select Image Store, ClipStore, Clip Edit and select the Build button in the Edit Type mode button group.

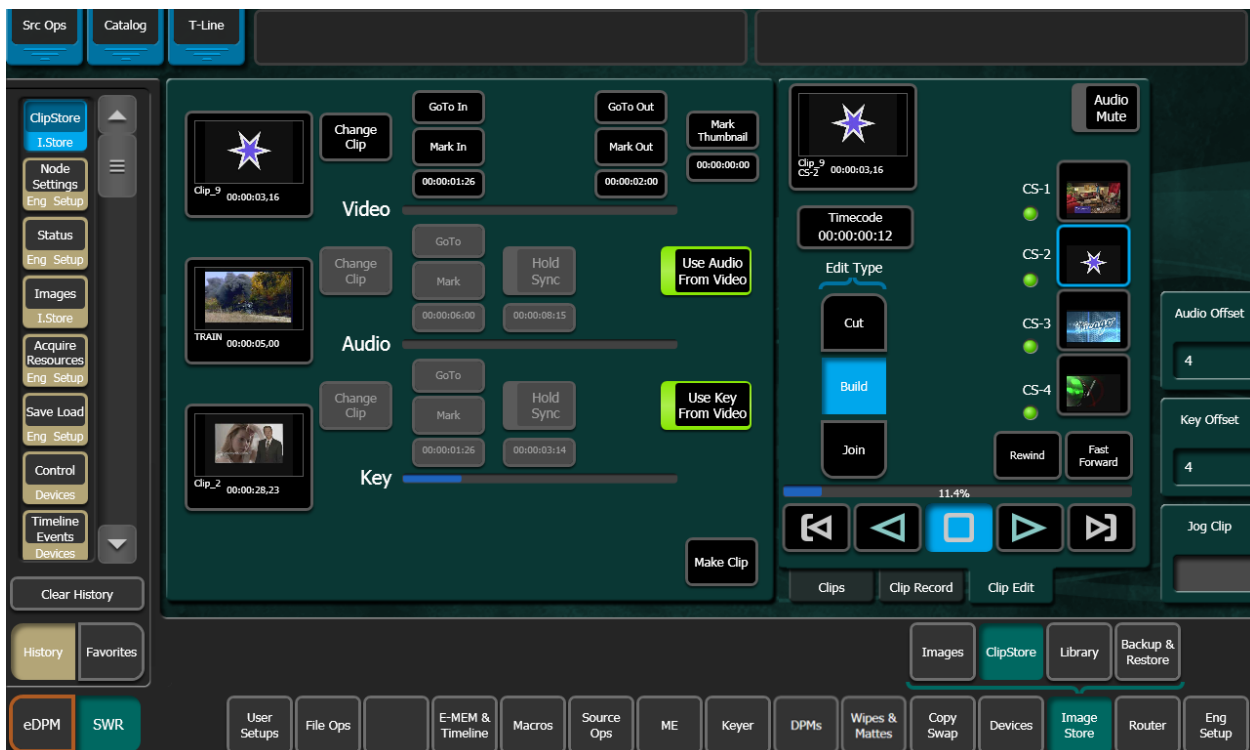

- 1 Unless the desired clip is loaded, select the Video Thumbnail Viewer.
- 2 Select the **Change Clip** button for the Video and select the desired clip.
- 3 Determine where you want a mark-in point for the Video track by either playing/jogging to the mark while viewing the clip on a monitor and selecting the

Mark In button or if you know the timecode, select the **Mark In data pad** and enter the timecode into the pop-up keypad, and select **Enter**.

- 4 Determine the mark-out point for the Video track and enter it as described for Mark In.

Mark a Thumbnail

- 1 Jog, shuttle, or play to where you want to mark thumbnail and select the **Mark Thumbnail** data pad, or
- 2 Select the **Mark Thumbnail** data pad and enter the mark-thumbnail point in the pop-up keypad, and select **Enter**.

With the Video Thumbnail Viewer selected, you can test the composite elements using the motion control buttons.

Make the Sub-Clip

Select the **Make Clip** button.

Enter the name of the new clip and select **Enter**.

The new clip is created and appears in the clip lists in the ClipStore menus.

Note: If Multiple sub-clips are desired from a built clip, use Build Edit to make the whole clip and then use the Cut Edit to make multiple sub-clips.

Adding a New Audio Element with Build Edit

If you require audio before or after video, a video track (for example of black) is needed so a mark can be made (this can be added with Join Edit, see Join Edit on page 484).

In this case, use the Video and Key of the loaded Video track but add/replace the Audio track and make a sub-clip. The Use Key From Video button is enabled (highlighted green):

Add an Audio Element

In the Video area:

- 1 Unless the desired clip is loaded, select the **Video Thumbnail Viewer**.

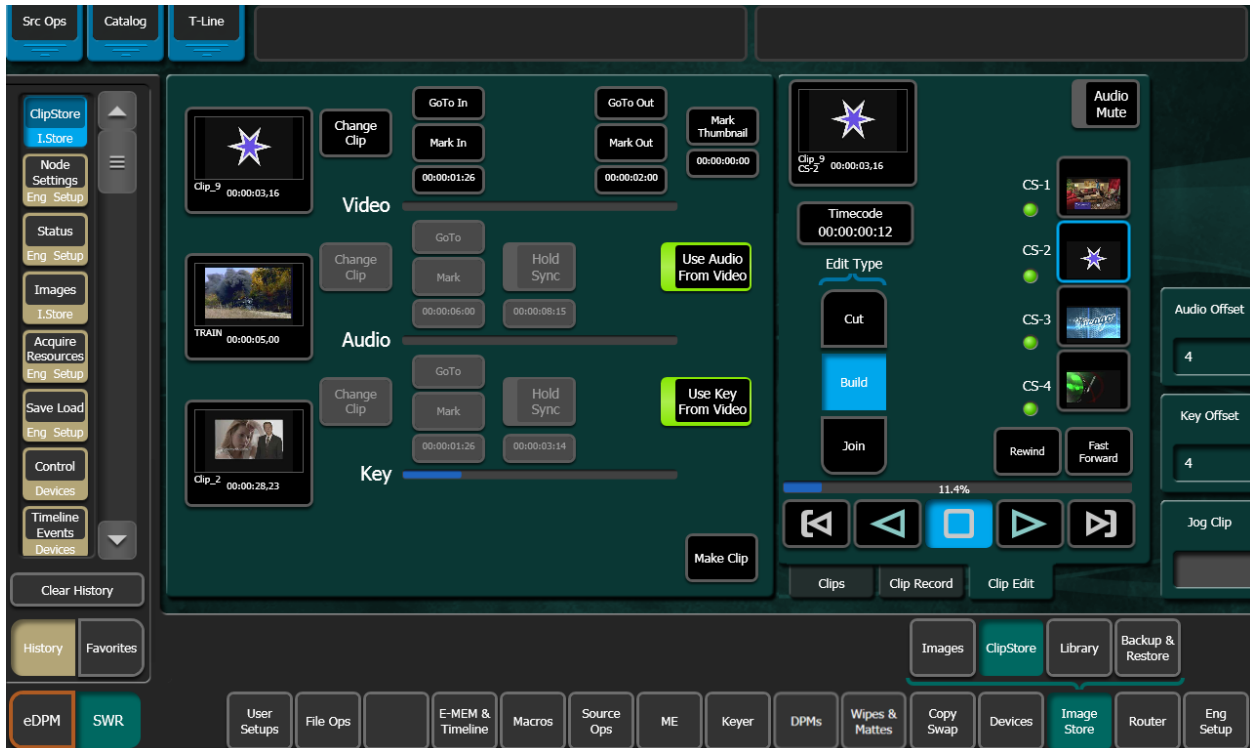

- 2 Select the **Change Clip** button for the *Video* area (top) and select the desired clip.
- 3 Determine where you want a mark-in point for the *Video* track by either playing/jogging to the mark while viewing the clip on a monitor and selecting the **Mark In** button or if you know the timecode, select the **Mark In** data pad and enter the timecode into the pop-up keypad, and select **Enter**.
- 4 Determine the mark-out point for the *Video* track and enter it as described for Mark In.

In the Audio area (center):

- 1 Turn off the **Use Audio From Video** button by selecting it.
- 2 Select the **Audio Thumbnail Viewer**.
- 3 Select the **Change Clip** button and select the desired clip/.WAV file with the desired *Audio* track.
- 4 Synchronize the Audio track in relation to the current video track timecode position, if needed, using the **Hold Sync** data pad or the **Audio Offset** soft knob (see [Hold Sync](#), on page 383).
- 5 With the Video Thumbnail Viewer selected (*Video* area, top), you can test the composite elements using the motion control buttons.

Make the Sub-Clip

- 1 Select the **Make Clip** button (bottom right of menu).
- 2 Enter the name of the new clip and select **Enter**.

Add/Replace a Key Element with Build Edit

In this case, you use the video and audio of the loaded video element but add/replace the key track and make a sub-clip. The Use Audio From Video button is enabled (highlighted green):

- 1 Unless the desired clip is loaded, select the **Key Thumbnail Viewer**.
- 2 Select the **Change Clip** button in the *Key* area (bottom) and select the desired clip.
- 3 If selected, turn off the **Use Key from Video** button.
- 4 In the *Video* area, determine where you want a mark-in point for the key track by either playing/jogging to the mark while viewing the clip on a monitor and selecting the **Mark In** button or if you know the timecode, select the **Mark In data pad** and enter the timecode into the pop-up keypad, and select **Enter**.
- 5 Determine the mark-out point for the Video track and enter it as described for Mark In.
- 6 Synchronize the *Key* track in relation to the current video track timecode position, if needed, using the **Hold Sync** data pad or the **Key Offset** soft knob (see [Hold Sync](#), on page 383).
- 7 With the **Video Thumbnail Viewer** selected, you can test the composite elements using the motion control buttons.
- 8 Select the **Make Clip** (bottom right of menu) button.
- 9 Enter the name of the new clip and select **Enter**.

Join Edit a Clip

Join Edit allows you to append one clip to another, and mark a thumbnail if desired.

- 1 To go to the Join Edit mode menu, select **Image Store**, **ClipStore**, **Clip Edit** and select the **Join** button in the Edit Type mode group.

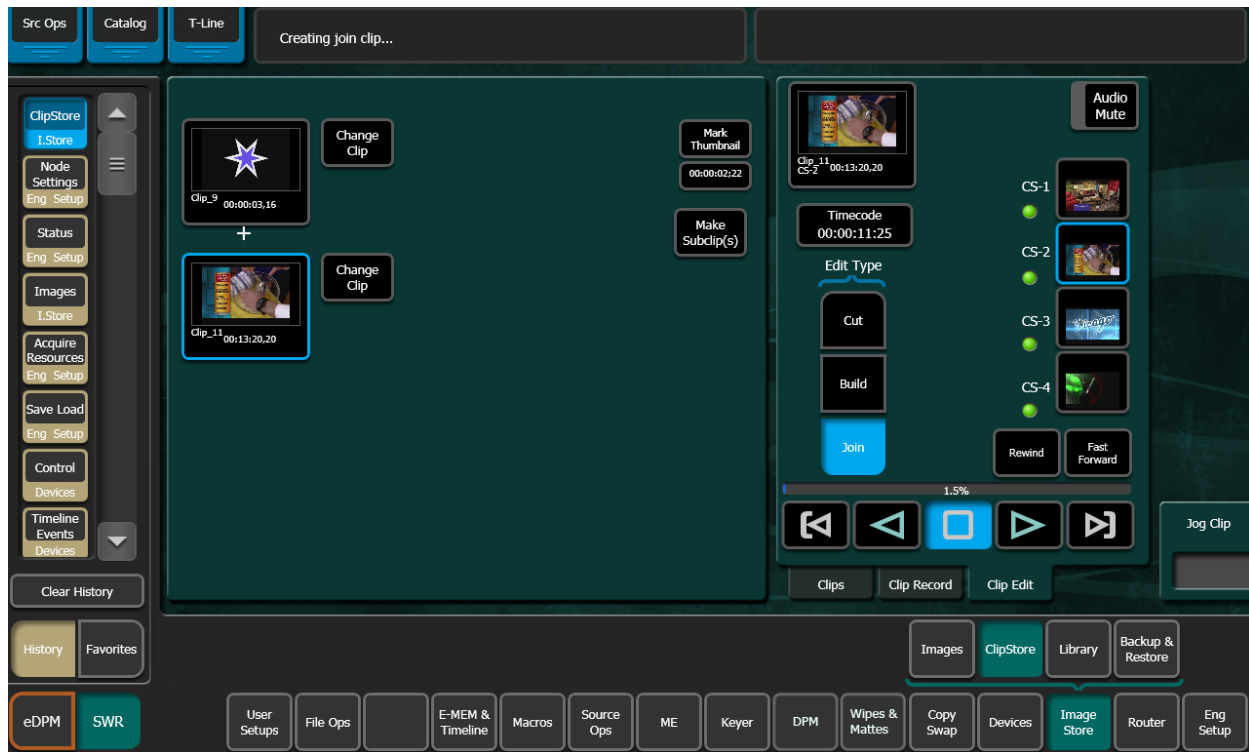

- 2 Select the **Change Clip** button for the first clip (top thumbnail) and select the desired clip.
- 3 Select the **Change Clip** button for the second clip (bottom thumbnail) to be appended to the tail end of the first, and select the desired clip.
- 4 Mark a thumbnail if desired (optional):
 - a Determine where you want to mark thumbnail and select the **Mark Thumbnail** data pad, or
 - b Enter the mark-thumbnail point in the pop-up keypad and select **Enter**.
- 5 Select the **Make Subclip(s)** button.

The new clip is created and appears in the clip lists in the ClipStore menus.

File Operations

ClipStore file transfers are performed in the ClipStore Library menu. Select Image Store, Library. Files can be imported or exported using the Copy/Paste (or Cut/Paste in the case of ClipStore to ClipStore folder transfers) buttons in the To and From ClipStore and Disk/Folder menu tabs.

Note: File renaming is not supported in the ClipStore Library menus.

File transfers can be performed from/to the following locations from the GV Switcher Menu Panel:

- ClipStore Server,
- Image folder on the GV Switcher Menu Panel,
- USB Storage Devices (seen as Removable Disks) and
- External USB Disk Drives (seen as Hard Disk Drives).

USB storage devices can be inserted into the USB ports on both the ClipStore server and on the GV Switcher Menu Panel. Memory Sticks will be seen as Removable Disks and will be displayed in the From Disk/Folders and To Disk/Folders menu tabs. External USB Disk Drives will also be seen in the From and To Disk/Folders menu tabs however first a shared folder is needed on the device (see [Creating a Shared Folder for External USB Disk Drives](#), on page 390).



Both files and folders containing files can be copied from disk to the ClipStore server. However, folders can only be copied to the top directory of the ClipStore server, “nested” folders are not permitted.

Files can be exported in multiple formats, by selecting the mode buttons in the Export Format modes pane. This operation is only supported when the files selected for export are in the From ClipStore pane. Files in Video/Key format can only be exported in GXF format.

Note: If a folder is selected for export, all files within the folder will be exported with the same format.

Creating a Shared Folder for External USB Disk Drives

To exchange files with an external USB disk drive, you will need to create a shared folder in the device, in Windows:

- 1 Insert the USB connector for the external USB drive in the Menu Panel.
- 2 Minimize the GV Switcher menu.
- 3 Open **My Computer** from the Desktop.
- 4 Open the disk drive from the Hard Disk Drives list.
- 5 Create a new folder using the File menu, name the folder (for example “GV Switcher Clips”).
- 6 Right-Click on the folder, and choose **Sharing and Security** from the pull-down menu.
- 7 In the **Sharing** tab, select the **Share this folder** radio button.
- 8 Press the **Permissions** button.
- 9 Allow full control for Everyone.
- 10 Click **Apply**.

The folder is now shared. The new folder will be available in the Image Store, Library, From/To Disk Folders menu tabs.

Device Control

Images can be controlled from the System Bar on the Control Panel, see [Device Control](#), on page 199.

Auto Transition	A transition having a predefined duration generally initiated by pressing a control panel button.
Aspect	The ratio of a picture's horizontal and vertical dimensions when correctly displayed (4:3, 16:9).
Background Bus	A row of buttons on an M/E used to select background video signals. Typically labeled A and B, with A representing the current output, and B representing the next output.
Background Transition	A transition between the background video signals selected on an ME.
Background Video	Video that forms a background scene into which a key may be inserted. Backing Color
Backing Color	The color in a chroma key scene that will be replaced with another video signal.
Bit Rate	The number of bits per second passed from one point to another.
Black	A black video signal generated within the switcher.
Box Wipe	A rectangular wipe pattern. For masking, the GV Switcher system provides a special box wipe pattern generator allowing independent control of the placement of each side of the box.
Chroma	The depth or saturation of color. Chroma, hue, and luminance make up the three characteristics of television color.
Chroma Key	A video key effect in which one video signal is inserted in place of areas of a particular color in another video signal. Blue and green are the chroma key colors most frequently used.
Clean Feed	A final output of the switcher that does not include downstream key effects or fade to black. Also see Programmable Clean Feed .
Clip	A threshold level adjustment to which the keying attribute (luminance, chrominance) is compared for generating the internal key control signal. Clip, in conjunction with gain, sets the switching point between the background and the key fill. Also see <i>Gain</i> .
Clip High, Clip Low	An alternative to Clip and gain keying, providing independent control of the points where the background video and the key fill video are each fully visible.

Complex Wipe Pattern Generator	A wipe pattern generator with additional capabilities (for example, matrix wipes).
Component Video	A video signal that keeps color and luminance information separate. RGB; Y, R-Y, B-Y; and Y, Cr, Cb are examples of component video.
Composite Video	An encoded video signal that combines color information with luminance information. NTSC, PAL, and D-2 are examples of composite video.
Compositing	Combining two or more video signals together into one output signal.
Control Signal	A signal used to perform an alteration or transition of video signals. For example, control signals are used for keying, masking, and wipe transitions.
Control Surface	The set of controls available to a single operator. These controls may reside on separate but related control panels.
Cross Fade	See Mix .
Crosspoint	An electronic switch, usually controlled by a button on the panel, that allows video or audio to pass when the switch is closed.
Cut	An instantaneous switch from one picture to another. Switching circuitry allows cuts only during the vertical interval of the video signal to prevent disruption of the picture.
VDR (Video Disk Recorder)	A video recorder and playback device using hard disk storage in place of video tape.
Delegate	To assign panel controls to a particular operating function. Some panel controls (buttons, knobs, joystick) can affect more than one function. The operator can choose an alternative function by delegating the panel controls to that function (typically by pressing or holding down a panel button).
Deserializer	A device that converts serial digital information to parallel.
Dissolve	See Mix .
DPOP (Double Press Open)	Pressing a control panel button twice rapidly to open a related menu. Buttons supporting DPOP are labeled with a graphical indicator.
Effect	A setup of panel controls specifying the sources involved and any processing applied to those sources. Effects can be learned (saved) and recalled by the E-MEM effects memory system.
Effect Transition	Recalling an E-MEM effect so that a transition is automatically performed at the start of the recall.

Effects Processor	The portion of a switcher that performs mixes, wipes and cuts between background and/or effects key video signals.
E-MEM Effects Memory	A feature that permits control panel setups to be stored for later recall.
Engineering Setups	On the GV Switcher system, a collection of configuration settings that establishes an essential baseline for system operation and integrates the system into a facility.
Ethernet	A form of high speed data transport between devices on a network.
Fade To Black	A mix transition to black.
Field	One scan of an interlaced video image. In interlace systems, two fields are required to make a complete picture (video frame) because alternate lines are scanned.
Fill Video	A video signal which fills a hole cut in background video by a key control signal.
Fixed Linear Key	A linear key that uses predetermined Clip and gain settings that are not adjustable.
Flip-Flop	A transition where the sources selected on the background buses (for example, preset and program) of an ME are exchanged at the end of a transition. The original preset bus source becomes selected on the program bus, and the original program bus source becomes selected on the preset bus.
FPGA	Field Programmable Gate Array.
Frame	One complete scan of a video image. For interlace video, alternate lines are scanned, and so a frame containing all the picture information consists of two fields.
Frame Rate	The number of frames presented per second. For interlace systems the frame rate is half the field presentation rate.
Gain	An amplification factor applied to a key control signal by a keyer that determines how much, if any, of the background and key fill video will be mixed together at the key edge areas. Low gain (1, or unity) generally results in a linear key.
General Purpose Interface (GPI)	An interface that allows limited remote control of some of a device's functions.
House Sync	Sync generated within a facility that is used as a reference for generating and/or timing other signals.
Hue	The location of a color on the color spectrum (i.e. red, yellow, green, blue). Chroma, hue, and luminance make up the three characteristics of television color.

Image Store	A device that captures, saves, and outputs still and movie video images.
Interlace	A system of video scanning where the odd and even numbered lines of a picture are presented consecutively as two separate interleaved fields. The two fields required to make a complete picture are called a frame.
Jitter	An undesirable variation in the timing of transitions in a digital signal.
Joystick	A hardware positioner with control of multiple axes.
Key	An effect where a portion of a background scene is replaced by a new video. Key cut and key fill signals are involved, though in some cases the same signal may be used for both (self key).
Key Cut	In key effects, the key cut signal is used to specify where to cut a hole in the background that will be filled with the key fill video. The key cut signal determines the shape of the key effect.
Key Fill	In key effects, the video signal which fills the hole cut in the background video.
Key Invert	Reversing the polarity of a key, such that material formerly keyed out will be keyed in, and vice versa.
Key Mask	A key mode which allows use of a wipe pattern generator to prevent some undesirable portions of the key cut signal from cutting holes in the background video.
Key Priority	The stacking order of multiple keys. The keyed signal with the highest priority appears in front of all the others. Keyed signals appear below higher priority keys and in front of lower priority keys, in a stack. A key priority transition changes the order of the keys without changing the background output.
Key Frame	A complete definition of an effect at a single point in time. Default keyframe values can be set for a suite.
Learn	To save a panel setup using E-MEM.
Linear Key	A key in which the keyer signal is faithfully reproduced in the final key effect. Linear keying preserves soft key edges, and generally has a gain of 1, or unity.
Look Ahead Preview	Video that shows the result of the currently setup next transition.
Looping, Loop-Through	An input that includes two connectors. One connector accepts the input signal, and the other connector is used as an output for connecting the input signal to another piece of equipment. On GV switchers, only the analog reference input is loop through.
Luminance	The brightness of the picture or area of the screen being considered. Chroma, hue, and luminance make up the three characteristics of television color.
Luminance Key	A key effect in which the portions of the key cut signal that are greater in luminance than the clip level cuts the hole in the background scene. Generally used when the key cut and key fill signals originate from the same source. Luminance key clip and gain is adjustable.

Mask	See Key Mask .
Matte	Internally-generated color video which can be adjusted for luminance, hue, and chroma. Matte can be used to fill areas of keys and borders.
Matte Fill	Using matte video to fill the hole of a key effect.
Matte Generator	A video generator that produces matte signals.
M/E	Abbreviation of mix/effects, pertaining to the circuitry and controls involved in compositing video signals.
Mix	A transition between two video signals in which one signal is faded down as the other is faded up.
Multiplier	A control circuit in which a control signal is multiplied with one or more input video signals. The resulting video output level varies from full on to full off according to the state of the control signal.
Object	An individual functional area of a system, typically one of several having similar capabilities.
Pattern Border	A variable width border that occurs at the edges of a wipe pattern.
Pixel	A picture element. A pixel is a digital sample of the luminance and color values of a picture at a single point.
Preference	See Suite Preference and User Preference .
Profile	Model name of a Video Disk Recorder.
Point of Use	A location in the system where a resource is used. A resource is generally used at different locations at different times. However, with some resources it is possible to use the same resource at different locations at the same time.
Preset Bus	A row of source buttons used to select the source that will be output by that ME during the next background transition. Also called the B bus.
Preset Pattern	A key effect in which a wipe pattern that has been preset to a desired size and location is used to cut the key hole. The characteristics of the pattern are set using pattern controls.
Preview	A video signal that is viewed before it is output by the switcher. See also Look Ahead Preview and Switched Preview.
Program Bus	A row of source buttons used to select the source for the current output of that ME. Also called the A bus.
Programmable Clean Feed	A type of clean feed where different keys can be selected for inclusion or exclusion from the clean feed.

Recall	To restore a previous panel setup that has been learned using E-MEM.
Reclocking	The process of clocking the data with a regenerated clock to remove jitter.
Resource	A capability of the system, typically consisting of a set of circuitry.
Register	A place to store an effect.
Saturation	The degree of purity of a color. Adding white to a color reduces its degree of saturation.
Self Key	A key effect in which a single video signal serves as both the key cut and key fill.
Sequence	On the GV Switcher system, a feature allowing a series of E-MEMs to be recalled in a specific order with a single command.
Serial Digital Video	Passing video data bits in serial form (one bit after another), along a single wire. Standard Definition serial digital video (SMPTE 259M) operates at 270 Mbits/sec (2 x 13.5 MHz x 10 bits).
Serial Interface	An interface which allows the switcher to be controlled remotely by a computer editor or other serial controller. Data is passed serially between the editor and the switcher at selectable baud (transmission) rates.
Serializer	A device that converts parallel digital information to serial.
Soft Border	A wipe pattern border which is mixed on the edges to give a soft effect.
Soft Edge	A pattern edge between two video signals in which the signals are mixed for a soft effect.
Source	1) An external device providing video. A source may provide only one video signal, or it may provide two signals (key fill and key cut). 2) The video signal(s) from a source, along with the source definition information associated with that source. See Source Definition.
Source Definition	A definition of the video signals making up a source, the device type and name of source, and the default processing and other parameters to be used for that source. The GV Switcher system is based on source selection, rather than choosing crosspoints.
Source Memory	A feature where the last keying and video processing settings for a source are retained and re-imposed when that source is re-selected. Default source memory values can be set for each source on each bus.
SPOP (Single Press Open)	Automatically opening a related menu when a control panel button is pressed. On the GV Switcher system, buttons supporting SPOP are labeled with a graphical indicator.
Stack	See Key Priority .
Suite	One or more control surfaces configured for use on the same project.
Suite Preference	A collection of settings used to configure a suite to create a consistent working environment for all involved.

Switched Preview	A special output of the system connected to a dedicated monitor. The operator can select and switch various system video signals to that output to preview them.
Sync	<p>1) General term for a synchronizing signal or signal component. Digital systems generally employ an analog external timing reference signal (such as color black or tri-level sync) to synchronize different pieces of equipment. Within the digital signal itself, however, synchronizing information is carried by special digital codes inserted at the beginning and end of each active line.</p> <p>2) In analog television systems, sync is the portion of the video signal which occurs during blanking and is used to synchronize the operation of cameras, monitors, and other equipment. Horizontal sync occurs within the blanking period in each horizontal scanning line, and vertical sync occurs within the vertical blanking period. A color black signal is often used for synchronizing different pieces of analog equipment.</p>
Tally	A light which lights up to indicate that the associated button has been selected or to indicate that the associated input to the switcher is on-air.
Terminate, Termination	To complete a circuit by connecting a resistive load to it.
Transition	A change from one picture to another. Cut, mix, and wipe are transitions.
User Preference	A collection of control surface configuration settings available to a user that allows customizing of the working environment.
Vertical Interval	The portion of the video signal that occurs between the end of one field or frame and the beginning of the next.
Video Fill	A video signal used to fill the hole made by a key cut signal.
Video Path	The path that video takes through the switcher.
Wash Matte	A type of matte that contains two elements rather than a single flat color. For example, a wash matte can have one color that mixes gradually across the screen to another color.
Wipe	A transition between two video signals that occurs in the shape of a selected pattern.
Wipe Pattern Generator	Circuitry that creates patterns that can be used to create wipe transitions, preset patterns, key masks, and matte washes.
Work Buffer	An active area of memory where the current effect parameters are stored, allowing the operator to use and modify the effect without changing the data stored in E-MEM.

index

Index

0–9

2D DPM	95
edge pinning example	335
enable on a keyer	93

A

additive keyer	
Kayenne control panel	296
unshaped video	294
alternative source names	
menu name	45
OLED name	45
panel name	45
AppCenter Elite	
ClipStore	396
audio/key track offset	
ClipStore	409
auto transition	
Kayenne transition module	176
procedure	207
aux bus mapping	33
aux panel source mapping	38

B

background cuts	
unwanted	280
background mattes	81
background transitions	
synchronize	319
bar graph	
lever arm	174
bias	
path	277
bus linking	
bus pair rules	169
management	170
overrides	169

button mapping	
changing	33
logical inputs	33
mapping sources	33

C

camera control	
fast recall	261
cascading bus links	
creating	168
example	168
character limits	
panel name	45
chroma	76
chroma key	74
auto setup	74
hue	75
secondary color suppression	79
selectivity	75
clear working buffer	49
clip hi	78
clip low	78
ClipStore	
and USB ports	415
AppCenter Elite	396
as external device	397
audio/key track offset	409
file operations	414
hold sync	409
K2 Solo	396
K2 Summit	396
color priority	36
common macro	296
common versus complex macros	296
compact flash	
drive access	54
complex macro	296
continuity	
path	277
control commands	232

-
- control panel
 - button mapping example 35
 - color priority 36
 - DPMs 92
 - E-MEM time value entry 123
 - get and put 124
 - GV Korona macro buttons 141
 - Karrera macro buttons 137
 - Kayenne macro buttons 134
 - key chaining 309
 - learn source memory 90
 - M/E split mode 315
 - motion control symbols 182
 - notification symbols 182
 - panel name 45
 - Sync Pri button 319
 - Sync Sec button 319
 - user colors 37
 - copy/paste
 - show files 55
 - copy/swap
 - E-MEM timelines 347
 - wipe generators 342
 - coring 76
 - corner pinning
 - example effect 329
 - shot clock example 331
 - view through 328
 - create folders
 - file operations 56
 - create show button
 - show files 58
 - cross fade
 - between keyers 280
 - crosshair button
 - preview prefs 51
 - cue and playback
 - Image Store movies 367
 - cut transition
 - Kayenne transition module 176
- D**
- default
 - button mapping 33
 - panel prefs and suite prefs 55
 - default keyframe
 - explained 49
 - learning 49
 - delegation button colors
 - setting 36
 - delegation button mapping
 - remote aux panel 38
 - delete files
 - file operations 56
 - device control
 - E-MEM 229
 - E-MEM operations 229
 - GV Korona control panel 248
 - Karrera control panel 247
 - Kayenne control panel 235
 - keyframe spacing 229
 - option software 229
 - protocols 223
 - work buffer values 224
 - device control module organization
 - Kayenne control panel 189
 - device control timeline events 224
 - device ganging
 - Kayenne control panel 235
 - DPMs
 - control panel 92
 - drive access
 - compact flash 54
 - menu panel hard drive 54
 - dual feed
 - primary and secondary M/Es 320
- E**
- edge pinning
 - 2D DPM example 335
 - Kayenne control panel 337
 - eDPM
 - delegation 92
 - eDPM effects 116
 - effect
 - corner pinning example 329
 - effects
 - eDPM 116
 - effects memory
 - E-MEM 123
 - E-MEM
 - device control 229
 - effects memory 123
 - execute macros 284
 - sub-level states 289

E-MEM & Timeline
 forced duration273
 insert after267
 insert before267
 E-MEM prefs
 reusing effects283
 E-MEM register offsets 69
 external device
 ClipStore397
 external device events
 multiple events230
 external DPM
 see eDPM effects116
 external routing systems
 router interface249

F

fast recall
 camera control261
 FF MPEG utility
 Image Store audio386
 file extensions
 switcher 57
 file operations
 ClipStore414
 load user setups 64
 register files 67
 save user setups 63
 saving register files 68
 switcher 54
 file ops menu
 register buttons 68
 file storage
 default panel and suite prefs 55
 organization 54
 show feature 55
 forced duration
 E-MEM & Timeline273
 fringe 77

G

get
 see get and put124
 get and put
 procedure124

GFX workflow
 XPression231
 GFX Xpression
 control commands232
 GV Korona control panel
 device control248
 GV Korona macro buttons
 control panel141

H

hold sync
 ClipStore409
 hue 75

I

Image Store
 imported formats353
 split key359
 Image Store audio
 FF MPEG utility386
 Image Store movie
 cue and playback367
 offsets387
 waveform continuity386
 imported formats
 Image Store353
 indexing
 router252
 insert after
 E-MEM & Timeline267
 insert before
 E-MEM & Timeline267
 interlocked
 next transition281

K

K2 Solo396
 ClipStore396
 K2 Summit396
 ClipStore396
 Karrera control panel
 device control247
 Karrera macro buttons
 control panel137

-
- Kayenne control panel
 - additive keyer 296
 - device control 235
 - device ganging 235
 - edge pinning 337
 - Q-MEM overview 243
 - Kayenne device control module
 - organization 189
 - Kayenne macro buttons
 - control panel 134
 - Kayenne source select module
 - button descriptions 182
 - split OLEDs 184, 186
 - Kayenne system bar
 - macro editing buttons 187
 - switched preview buttons 187
 - Kayenne transition module
 - auto transition 176
 - cut transition 176
 - function buttons 175
 - next transition 176
 - organization 173
 - status display 174
 - key chaining
 - control panel 309
 - key signal
 - super additive mode 295
 - key store 84
 - keyer
 - delete source memory 89
 - enable 2D DPMs 93
 - visible on primary partition 314
 - visible on secondary partition 314
 - keyers
 - cross fade 280
 - explained 73
 - keyframe inserted on path
 - technical note 269
 - keyframe spacing
 - device control 229

 - L**
 - layered mode 318
 - lever arm 174
 - out of sysnc correction 315
 - lever arm bar graph 174
 - lever arm transition
 - procedure 207
 - load show files 60
 - from history 60
 - loading E-MEM registers 69
 - loading source rules
 - example 66
 - loading source tables
 - example 66

 - M**
 - M/E 73
 - split mode example 313
 - M/E split mode
 - control panel 315
 - example 313
 - layered mode 318
 - partitioning 312
 - transitions 315
 - macro
 - execute with E-MEMs 284
 - recall E-MEMs 284
 - macro editing
 - offline 306
 - macro editing buttons
 - Kayenne 187
 - macros 128
 - mapping
 - aux panel sources 38
 - master E-MEM sub-levels
 - ME split mode 316
 - ME split mode
 - master E-MEM sub-levels 316
 - partition preview 315
 - secondary partition 315
 - menu name
 - character limts 45
 - menu panel hard drive
 - access 54
 - motion control symbols
 - control panel 182
 - multiple events
 - external device control 230

N

next transition	
interlocked	281
interlocked group workaround	281
Kayenne transition module	176
notification symbols	
control panel	182

O

offline	
macro editing	306
offset	
Image Store movie	387
OLED name	45

P

panel name	
character limits	45
control panel	45
Panel Prefs menu	
button functions	34
partition	
sync mode	319
partition sync mode	319
operation	319
split M/E	319
partitioning	
M/E split mode	312
path	
bias	277
continuity	277
tension	277
preview prefs	
crosshair button	51
primary and secondary M/Es	
dual feed	320
primary partition	
keyer visibility	314
primary suppression	
coring	76
fringe	77
protocols	
device control	223
put	
see get and put	124

Q

Q-MEM	
overview	243

R

recall E-MEMs	
macro	284
register buttons	
file ops menu	68
register offsets	
E-MEM	69
register-based file operations	67
registers	
E-MEM loading	69
remote aux panel	
delegation button mapping	38
rename file ops files	56
reusing effects	
E-MEM prefs	283
source patch, suite prefs compatibility ..	283
router indexing	
requirements	252
router interface	
external routing systems	249

S

safe area	50
saving register files	
file operations	68
saving source rules	
example	65
saving source tables	
example	65
secondary color suppression	79
secondary partition	
keyer visibility	314
selectivity	75
shadow clip	77
shadow density	77
shadow gain	77
shot clock	
corner pinning effect	331
show feature	
manage file groups	55

-
- show file buttons 57
 - create show 58
 - show files
 - copy/paste 55
 - load 60
 - load from history 60
 - update 61
 - software
 - device control option 229
 - source memory
 - delete from keyer 89
 - learn from control panel 90
 - learning for a keyer 88
 - source patch 43
 - menu description 44
 - source IDs 43
 - source planning 46
 - suite prefs and effects 47
 - suites 45
 - source rules
 - loading 66
 - saving 65
 - source select aux mode
 - GV Korona 156
 - Karrera 156
 - Kayenne 156
 - source substitution
 - split M/E mode 321
 - source tables
 - loading 66
 - saving 65
 - split key
 - Image Store 359
 - split M/E mode
 - source substitution 321
 - split OLEDs
 - Kayenne source select module 184, 186
 - status display
 - Kayenne transition module 174
 - sub-level states
 - E-MEM 289
 - suite prefs
 - engineering names explained 45
 - suites
 - source patch 45
 - super additive mode 295
 - key signal 295
 - switched preview buttons
 - Kayenne 187
 - switcher file extensions 57
 - sync correction
 - lever arm 315
 - sync partitions
 - operations 319
 - Sync Pri button
 - control panel 319
 - Sync Sec button
 - control panel 319
 - synchronize
 - background transitions 319
- ## T
- tension
 - path 277
 - time value entry
 - control panel 123
 - timeline events
 - device control 224
 - timelines
 - copy/swap 347
 - transition
 - auto procedure 207
 - lever arm 207
 - transition module organization
 - Kayenne control panel 173
 - transitions
 - M/E split mode 315
- ## U
- unshaped video
 - additive keyer 294
 - unwanted background cuts 280
 - update show files 61
 - USB ports
 - ClipStore 415
 - user colors
 - control panel 37
 - user setups
 - load 64
 - save 63
- ## V
- video compositing
 - see layered mode 318

view through
corner pinning328

W

waveform continuity
Image Store movie386
wipe generators
copy/swap342

wipe limitations
4K SDQS205
work buffer
device control224

X

XPression
GFX workflow231



Grass Valley Technical Support

For technical assistance, contact our international support center, at 1-800-547-8949 (US and Canada) or +1 530 478 4148.

To obtain a local phone number for the support center nearest you, please consult the Contact Us section of Grass Valley's website (www.grassvalley.com).

An online form for e-mail contact is also available from the website.

Corporate Head Office

Grass Valley
3499 Douglas-B.-Floreani
St-Laurent, Quebec H4S 2C6
Canada
Telephone: +1 514 333 1772
Fax: +1 514 333 9828
www.grassvalley.com