



8943RDA-DFR

SD/HD/3G-SDI FIBER READY RECLOCKING DA

Release Notes

Software Version 1.1.2

Contacting Grass Valley

International Support Centers	France 24 x 7	+800 8080 2020 or +33 1 48 25 20 20	United States/Canada 24 x 7	+1 800 547 8949 or +1 530 478 4148
Local Support Centers (available during normal business hours)	Asia	Hong Kong, Taiwan, Korea, Macau: +852 2531 3058 Indian Subcontinent: +91 22 24933476 Southeast Asia/Malaysia: +603 7805 3884 Southeast Asia/Singapore: +65 6379 1313 China: +861 0660 159 450 Japan: +81 3 5484 6868		
		Australia and New Zealand: +61 1300 721 495	Central/South America: +55 11 5509 3443	
		Middle East: +971 4 299 64 40 Near East and Africa: +800 8080 2020 or +33 1 48 25 20 20		
	Europe	Belarus, Russia, Tadzikistan, Ukraine, Uzbekistan: +7 095 2580924 225 Switzerland: +41 1 487 80 02 S. Europe/Italy-Roma: +39 06 87 20 35 28 -Milan: +39 02 48 41 46 58 S. Europe/Spain: +34 91 512 03 50 Benelux/Belgium: +32 (0) 2 334 90 30 Benelux/Netherlands: +31 (0) 35 62 38 42 1 N. Europe: +45 45 96 88 70 Germany, Austria, Eastern Europe: +49 6150 104 444 UK, Ireland, Israel: +44 118 923 0499		

Copyright © Grass Valley, Inc. All rights reserved.
This product may be covered by one or more U.S. and foreign patents.

Grass Valley Web Site

The www.grassvalley.com web site offers the following:

Online User Documentation — Current versions of product catalogs, brochures, data sheets, ordering guides, planning guides, manuals, and release notes in .pdf format can be downloaded.

FAQ Database — Solutions to problems and troubleshooting efforts can be found by searching our Frequently Asked Questions (FAQ) database.

Software Downloads — Download software updates, drivers, and patches.



END-OF-LIFE PRODUCT RECYCLING NOTICE

Grass Valley's innovation and excellence in product design also extends to the programs we've established to manage the recycling of our products. Grass Valley has developed a comprehensive end-of-life product take back program for recycle or disposal of end-of-life products. Our program meets the requirements of the European Union's WEEE Directive, the United States Environmental Protection Agency, and U.S. state and local agencies.

Grass Valley's end-of-life product take back program assures proper disposal by use of Best Available Technology. This program accepts any Grass Valley branded equipment. Upon request, a Certificate of Recycling or a Certificate of Destruction, depending on the ultimate disposition of the product, can be sent to the requester.

Grass Valley will be responsible for all costs associated with recycling and disposal, including freight. However, you are responsible for the removal of the equipment from your facility and packing the equipment to make it ready for pickup.



For further information on the Grass Valley product take back system please contact Grass Valley at + 800 80 80 20 20 or +33 1 48 25 20 20 from most other countries. In the U.S. and Canada please call 800-547-8949 or 530-478-4148, and ask to be connected to the EH&S Department. Additional information concerning the program can be found at: www.thomsongrassvalley.com/environment



Contents

- Introduction 5
- 8943RDA-DFR Version 1.1.2 Software Overview..... 5
- Software Updating 6
- Using NetConfig to Update Software. 6
- NetConfig Software Update with XML Method..... 7

Version **1.1.2**

MAY 2010

8943RDA-DFR Release Notes

Introduction

These release notes provide important information on the release of the latest software for the 8943RDA-DFR modules. This 1.1.2 release provides updates from the initial software version 1.1.0.

Note This release does not affect the 8943RDA and 8943RDA-D modules as they do not have fiber functionality.

These release notes contain the following sections:

- 8943RDA-DFR Software Overview
- Software Updating Procedures ([page 6](#))

8943RDA-DFR Version 1.1.2 Software Overview

Version 1.1.2 features the following new enhancements for the 8943RDA-DFR modules:

- This software version allows the use of the latest SFP fiber optic sub-modules. The submodules are part of a kit that includes the submodule, a mounting bracket, and a cable assembly:
 - SFP-13103G-M1DRX-K (Dual receiver, RX1 and RX2)
 - SFP-13103G-M1DTX-K (Dual transmitter, TX1 and TX2)
 - SFP-13103G-M1TRX-K (Transceiver TX1 and RX2)

Note The Transceiver cabling for this module is different than other GeckoFlex fiber optic modules due to necessary circuit board design.

Software Updating

This module software is updated using the Grass Valley PC application NetConfig (available from the Grass Valley ftp site free of charge).

Using NetConfig to Update Software

The NetConfig networking application is a highly versatile tool for both software updating and accessing modular products on the network to view status and set module parameters. If you do not have NetConfig or the latest version as of this printing (version 2.0.10), you can download it free of charge from the Thomson Grass Valley ftp site at this URL:

<ftp://ftp.grassvalley.com/router/NetConfig/Version%202.0.10/>

1. Right-click on the latest NetConfig link to download the zipped file to the C:\temp folder or other convenient location on your PC.
2. Extract the zipped files onto your local drive:
3. Double-click on the NetConfig.exe file to install NetConfig.

Note Installing NetConfig into the default location given in the install script (C:\Programs\Grass Valley Group) is recommended for future NetConfig and module software updates.

To update with NetConfig you must have the following:

- PC with NetConfig Networking application installed (version 2.0.10 is the latest version available),
- IP connection between the GeckoFlex frame and your PC, and
- 8900NET (Net Card) module in the GeckoFlex frame with software 4.0.2 or later. The latest version of the 8900NET (Net card) module is version 4.3.0. This update is available free of charge from the Thomson Grass Valley ftp site at this URL:

<ftp://ftp.grassvalley.com/modular/8900/8900net/V4.3.0>

NetConfig Software Update with XML Method

A newer method of downloading software is now being used which uses an .xml file instead of the previous method using a .sw2 file. The new method is very similar to the older method and allows for easier updating of all module types (different hardware versions) at once.

1. Locate the latest 8943RDA-DFR module software on the Thomson Grass Valley ftp site at this URL:

<ftp://ftp.grassvalley.com/modular/8900/8943RDA-DFR/V1.1.2>

2. On your local C:\ drive, locate the NetConfig program directory. This directory is normally in the default location in C:\Program Files\Grass Valley Group\NetConfig.

If you have installed NetConfig in another location, find the location of the NetConfig directory by right-clicking on the NetConfig shortcut. Select **Properties** and note the location in the **Start In** field.

1. Copy the .xml and .fld files listed below into the main NetConfig directory from the ftp site.
 - 8943RDA_SW_1.1.2.xml
 - 8943RDA_SW_1.1.2.fld
2. In the main NetConfig directory, locate a folder named **modular**. If this folder does not exist, create a folder called **modular** in the main NetConfig directory.
3. Move the 8943RDA_SW_1.1.2.fld file listed above in the main NetConfig directory into this **modular** directory. Leave the .xml file in the main directory.
4. Open NetConfig by double clicking on the NetConfig icon on your desktop.

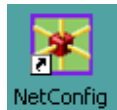

Note If you have not used NetConfig before, refer to the *NetConfig Instruction Manual* included during installation in the main NetConfig directory in PDF format (NetConfig.pdf).

5. Click on the **Load SW** button on the top of the NetConfig toolbar.
6. This will bring up the Load Software screen ([Figure 1](#)).
7. If you have done previous software downloads using .sw2 files, you will have a **Modular** and possibly a **Misc** directory, as shown in [Figure 1](#).
8. For this update using the .xml method, open the **Modular** directory by selecting the +.

Figure 1. NetConfig Software Update

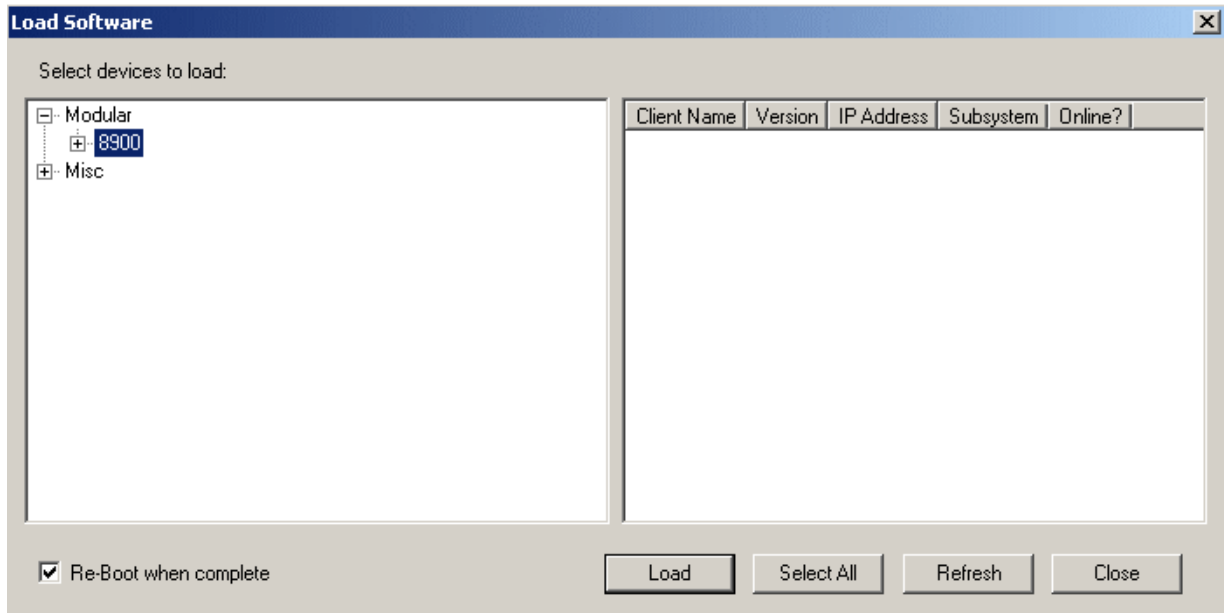

9. Now open the 8900 directory by selecting the +.
10. Open the 8943RDA directory with the +, then open the App directory to bring up the 1.1.2(1.1.2) software upload file.

11. Select the software file to highlight it as shown in [Figure 16](#).

Figure 2. Find 8943RDA Directory

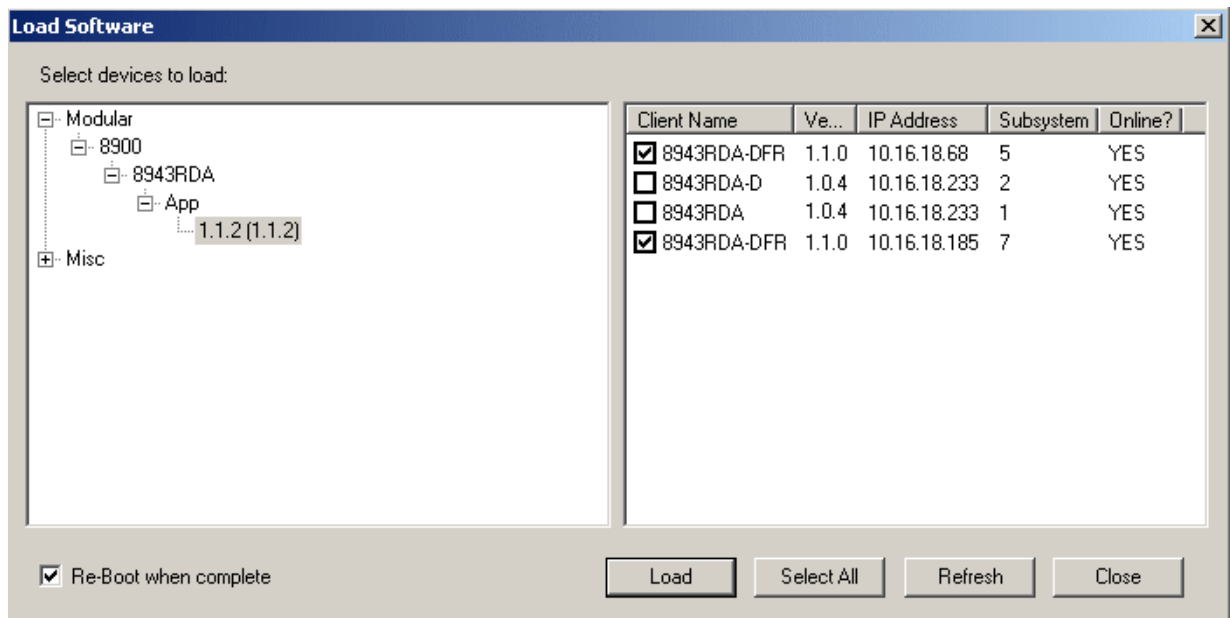

12. This will bring up all of the 8943RDA-DFR modules on your network, including the 8943RDA and 8943RDA-D, on the right side of the screen. Update only the 8943RDA-DFR modules.

Note This software does not affect the 8943RDA or the 8943RDA-D since they do not have fiber functionality.

13. Check the 8943RDA-DFR checkboxes you wish to update in the Client Name list. You may update all devices at once if desired by clicking on the **Select All** button at the bottom of the screen. Or you may only check the corresponding checkboxes only next to the specific modules you need to update.
14. Check the **Re-Boot when complete** checkbox in the lower left corner of the Load Software screen.
15. Select the **Load** button to update all selected modules. This will bring up a progress bar (not shown) showing software download status. Wait for the progress bar to finish.

16. If the upload has been successful, a pop-up screen similar to the one shown in [Figure 3](#) will appear.

Figure 3. Load Successful Popup



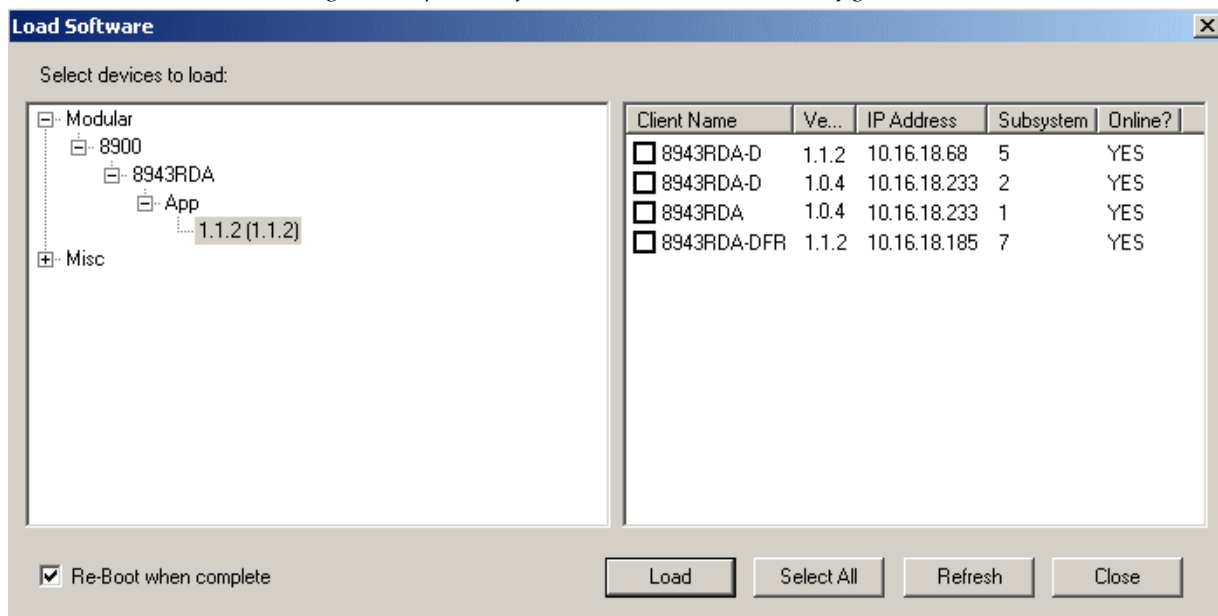

17. When the software update has finished, check that the software version for each module checked for update in the Client Name list is now at version 1.1.2 as shown in [Figure 4](#) and that the 8943RDA-DFR Status web page is updated for each module as shown in [Figure 5](#) on page 11.

Figure 4. Updated Software Version Shown in NetConfig



18. Verify proper operation of the module.
19. Now link to the User Settings web page and select the **Set Factory Defaults** and **Set Factory Names** button. This will return the module to the factory default values and update the module with the new parameters for this release.

Figure 5. Status Web Page

 **Status** 
Model: [8943RDA-DFR](#) Description: [Dual FO SD/HD/3G DA](#)
Frame Location: [Modular Bay 2](#) , Slot: [1](#)
Fiber Module Type: [Not Installed](#)

Gecko Flex Module Physical Structure

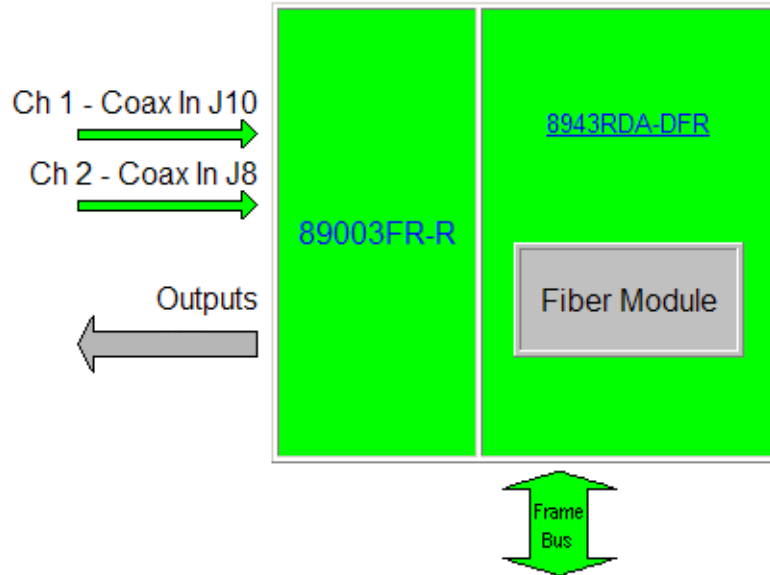

Fiber Module: [MISSING](#)

Update successful 

Part Number: 771-0376-03A
Serial Number: KB09450634
Hardware Revision: 03A
Software Version: 1.1.2
Asset Tag:

